



**PS5R Standard Series  
Switching Power Supplies**

**Key features:**

- Wide power range: 7.5W-240W
- Universal input :  
7.5W-50W: 85-264V AC/105-370V DC  
100W: 85-132V AC/170-264V AC  
240-370V DC (selectable)  
75W, 120W, 240W: 85-264V AC/110-350V DC
- Overcurrent/overvoltage protection
- Power Factor Correction (75W, 120W, 240W models)  
EN61000-3-3  
EN61000-3-2
- Voltage adjustment +10%
- Spring-up crew terminal, IP20 (finger-safe)
- DIN rail or panel surface mount
- Approvals:  
CE marked  
UL 508 Listed  
c-UL  
TÜV approved  
EMC Directives:  
EN50081-2  
EN50082-2  
EN61000-6-2  
LVD EN60950:2000



**Part Numbers**

Style	Watts	Rated Voltage	Rated Current	Part Number
	7.5	5V DC	1.5A	PS5R-A05
		12V DC	0.6A	PS5R-A12
		24V DC	0.3A	PS5R-A24
	15	5V DC	2.5A	PS5R-B05
		12V DC	1.2A	PS5R-B12
		24V DC	0.6A	PS5R-B24
	30	12V DC	2.5A	PS5R-C12
		24V DC	1.3A	PS5R-C24
	50	24V DC	2.1A	PS5R-D24

Style	Watts	Rated Voltage	Rated Current	Part Number
	75	24V DC	3.1A	PS5R-Q24
	100	24V DC	4.2A	PS5R-E24
	120	24V DC	5A	PS5R-F24
	240	24V DC	10A	PS5R-G24

Specifications

Model	PS5R-A05	PS5R-B05*	—	—	—	—	—	—
	PS5R-A12	PS5R-B12	PS5R-C12	—	—	—	—	—
	PS5R-A24	PS5R-B24	PS5R-C24	PS5R-D24	PS5R-Q24	PS5R-E24	PS5R-F24	PS5R-G24
<b>Output Capacity</b>	7.5W	15W	30W	50W	75W	100W	120W	240W
<b>Input</b>	Input Voltage (single-phase, 2-wire) 100 to 240V AC nominal (85 to 264V AC), 50/60Hz (47 to 63Hz) 110 to 340V DC nominal (105 to 370V DC)						100 to 120V AC, 50/60Hz 200 to 240V AC, 50/60Hz (jumper selectable) 240 to 370V DC	100 to 240V AC, 50/60Hz, 110 to 340V DC
Input Current (typical)	0.17A at 100V AC	0.3A at 100V AC	0.68A at 100V AC	1.15A at 100V AC	1.1A at 100V AC	2.5A at 100V AC 1.5A at 200V AC	1.8A at 100V AC	4A at 100V AC
Internal Fuse Rating	2A	2A	3.15A	3.15A	3.15A	4A	4A	6.3A
Inrush Current	50A maximum (at cold start at 200V AC)				70A maximum (at cold start at 230V AC)	50A maximum (at cold start at 200V AC)	70A maximum (at cold start at 230V AC)	
Leakage Current (at no load)	0.75mA maximum (60Hz, measured in conformance with UL, CSA, VDE)							
Typical Efficiency	69% at 5V 75% at 12V 79% at 24V		75% at 12V 75% at 24V	79% at 24V	83% at 24V	85% at 24V	83% at 24V	
Overvoltage Protection	Outputs turns off at 105% (typical)							
<b>Output</b>	5V, 1.5A 12V, 0.6A 24V, 0.3A	5V, 2.5A 12V, 1.2A 24V, 0.6A	12V, 2.5A 24V, 1.3A	24V, 2.1A	24V, 3.1A	24V, 4.2A	24V, 5A	24V, 10A
Voltage Adjustments	±10% (V.ADJ screw on top)							
Output Holding Time	20ms minimum (at full rated input and output)							
Rise Time	200ms maximum (at full rated input and output)							150ms max.
Line Regulation	0.4% maximum							
Load Regulation	1.5% maximum							
Fluctuation due to Ambient Temperature Change	0.05% maximum							
Ripple Voltage	2% peak to peak maximum (including noise)							
Overload Protection	120% typical (Zener-limiting)			120% typical, auto reset				
Operation Indicator	LED (green)							
Parallel Operation Allowed	PS5R-A	PS5R-B	PS5R-C	PS5R-D	PS5R-Q	PS5R-E	PS5R-F	PS5R-G
	No				Yes	No	Yes	
Dielectric Strength	Between input and output terminals: 3,000V AC, 1 minute Between input terminals and housing: 2,000V AC, 1 minute Between output terminal and housing: 500V AC, 1 minute							
Insulation Resistance	Between input and output terminals/input terminals and housing: 100MΩ minimum (500V DC megger)							
Operating Temperature	-10° to +60°C (14° to 140°F) (see derating curves)							
Storage Temperature	-30° to +85°C (-22° to 185°F)							
Operating Humidity	20 to 90% relative humidity (no condensation)							
Vibration Resistance	45m/s <sup>2</sup> , 10 to 55Hz, 2 hours on each of 3 axes				10 to 50Hz, 0.75mm p-p, 2 hrs on each of 3 axes			
Shock Resistance	300m/s <sup>2</sup> (30G), 3 shocks in each of 6 directions							
Approvals	Conforms to EMC Directives EN50081-2 & EN50082-2. LVD Directive EN60529 — Certified to EN60950. UL508 listed. c-UL, TUV approved. CE marked. EN61000-3-2							
Weight	150g	170g	360g	390g	800g	600g	1200g	2000g
Termination	Spring-up, fingersafe terminals with captive M3.5 screws							
IP protection	IP20 (finger safe)							
Dimensions H x W x D (mm)	75 x 45 x 70	75 x 45 x 95	75 x 90 x 95	75 x 90 x 95	120 x 85 x 140	75 x 145 x 95	120 x 115 x 140	120 x 200 x 140
Dimensions H x W x D (inches)	2.95 x 1.77 x 2.76	2.95 x 1.77 x 3.74	2.95 x 3.54 x 3.74	2.95 x 3.54 x 3.74	4.72 x 3.35 x 5.52	2.95 x 5.71 x 3.74	4.72 x 4.53 x 5.52	4.72 x 7.87 x 5.51



1. For dimensions, see page 151. 3. \*12.5W for 5VDC model.  
2. For usage instructions, see page 150.

Oil Touchscreens

PLCs

Automation Software

Power Supplies

Sensors

Communication

Barriers

Temperature Derating Curves

PS5R-A/B

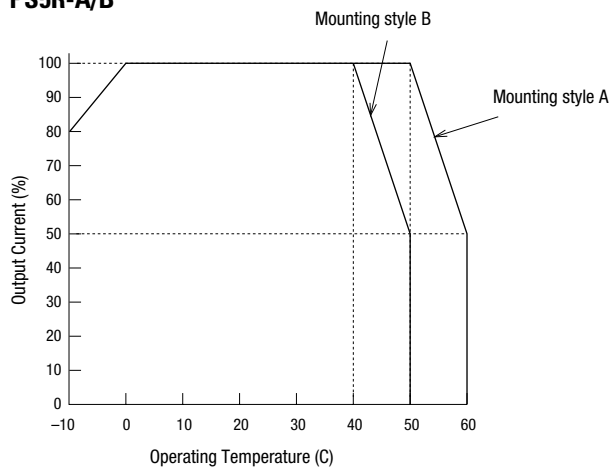

PS5R-C/D

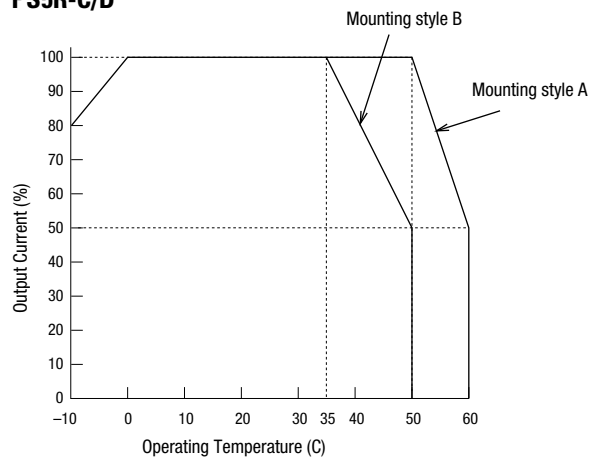

PS5R-E

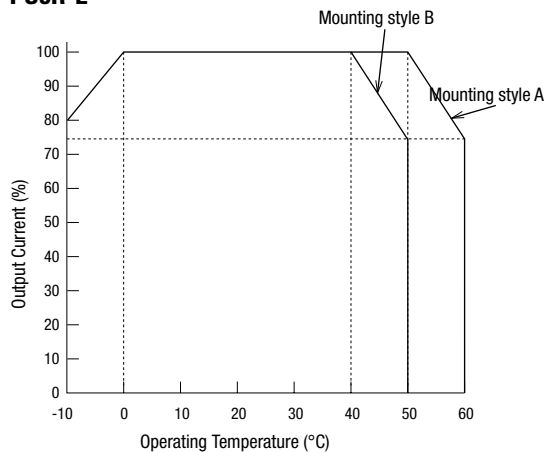

PS5R-Q

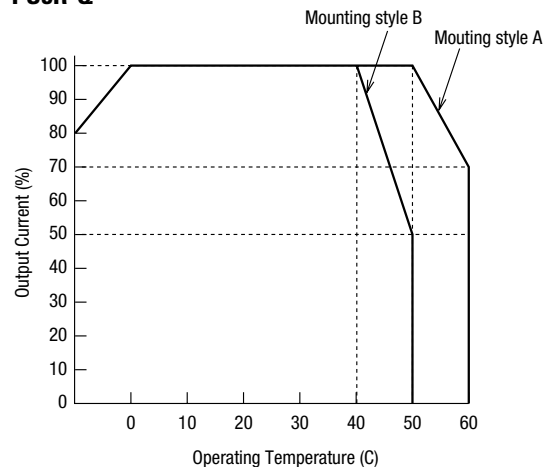

PS5R-F/G

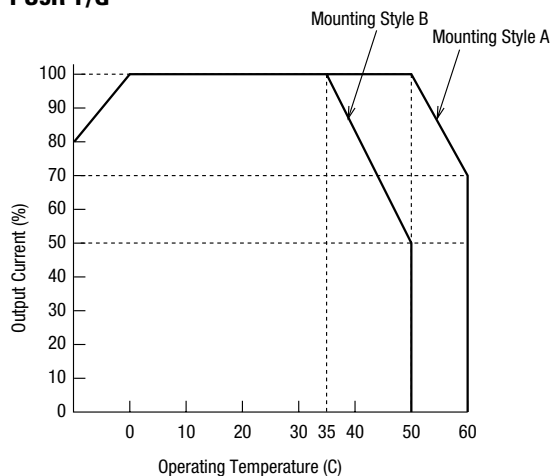

A Mounting (standard)

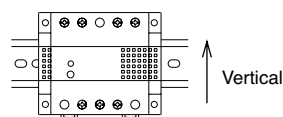

B Mounting (Facing Upward)

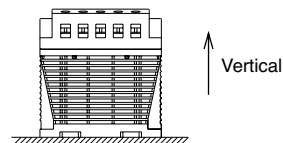

OT Touchscreens

PLCs

Automation Software

Power Supplies



Sensors

Communication

Barriers

Accessories

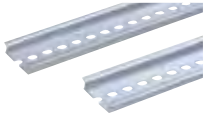
Part Numbers: PS5R Accessories

Appearance	Description	Part Number
	DIN rail (1000mm)	BNDN1000
	DIN rail end clip	BNL5

Installation Instructions

Time-Saving Spring-up Terminals

The innovative terminals on the PS5R series use a spring-loaded screw. This makes installation as easy as pushing down and turning with a screwdriver. Installation time is cut in half since the screws do not need to be backed out to install wiring. The screws are held captive once installed and are 100% finger-safe. Screw terminals accept bare wire or ring or fork connectors.

1. Insert the wire connector into the slot on the side of the power supply.



2. Using a flat head or Phillips screwdriver, push down and turn the screw.

The wire is now connected, and the screw terminal is fingersafe!

Front Panel (terminals)

Markings	Name	Description
V. ADJ	Voltage adjustment	Adjusts within $\pm 10\%$ ; turn clockwise to increase output voltage
DC ON	Operation indicator	Green LED is lit when output voltage is on
+V, -V	DC output terminals	+V: Positive output Terminal -V: Negative output terminal
	Frame ground	Ground this terminal to reduce high-frequency currents caused by switching
L, N	Input terminals	Accept a wide range of voltages and frequencies (no polarity at DC input)
NC	No connection	Do not insert wires here, as this may damage the power supply

Overcurrent Protection Characteristics

PS5R-A/B

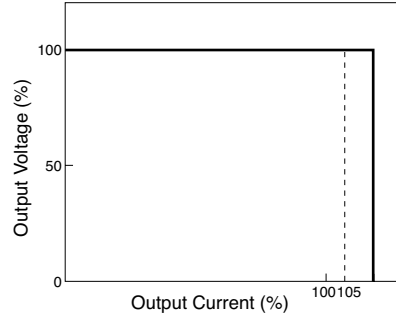

PS5R-C/D/E

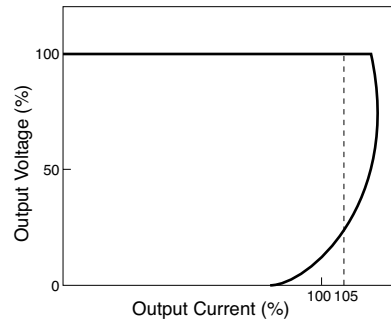

Parallel Operation

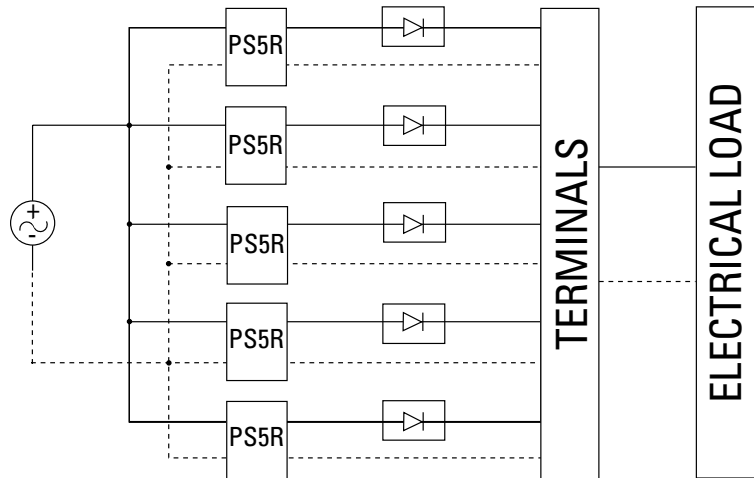

1. Parallel operation only recommended for PS5R-Q24, PS5R-F24 and PS5R-G24.
2. Factory recommended diode ST Microelectronics BYV54V-50, BYV54V-100, BYV54V-200, BYV541V-200 or with equivalent electrical specifications.
3. Using the voltage adjustment make sure out-voltage is the same for all power supplies.

OI Touchscreens

PLCs

Automation Software

Power Supplies

Sensors

Communication

Barriers

Dimensions

PS5R-A (7.5W)

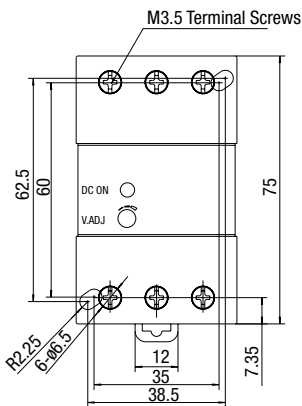

PS5R-B (15W)

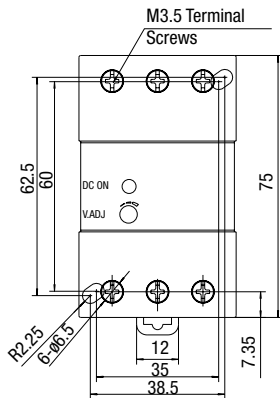

PS5R-C (30W)

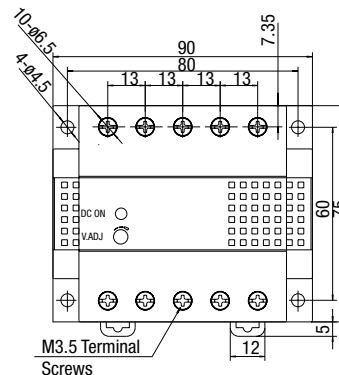

PS5R-D (50W)

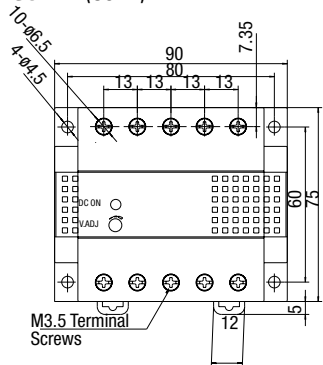

PS5R-Q (75W)

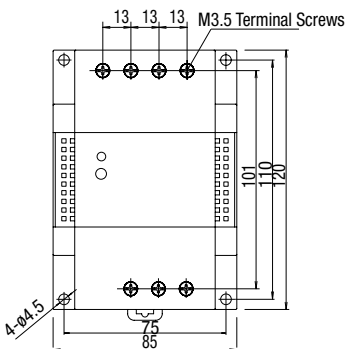

PS5R-F (120W)

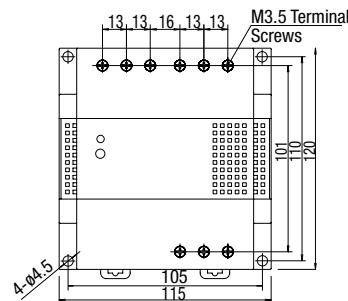

PS5R-E (100W)

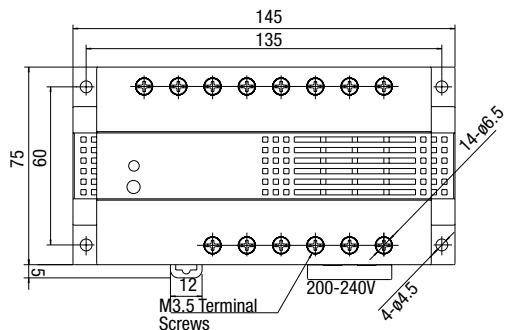

PS5R-G (240W)

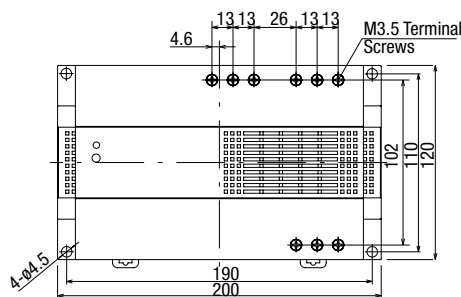

Terminal Markings

PS5R-A/B

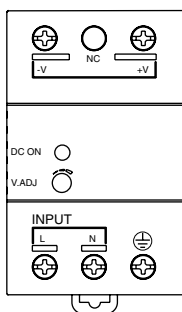

PS5R-C/D/Q/F/G

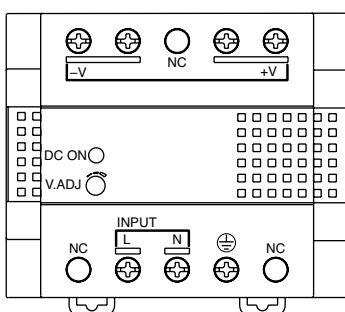

PS5R-E

