

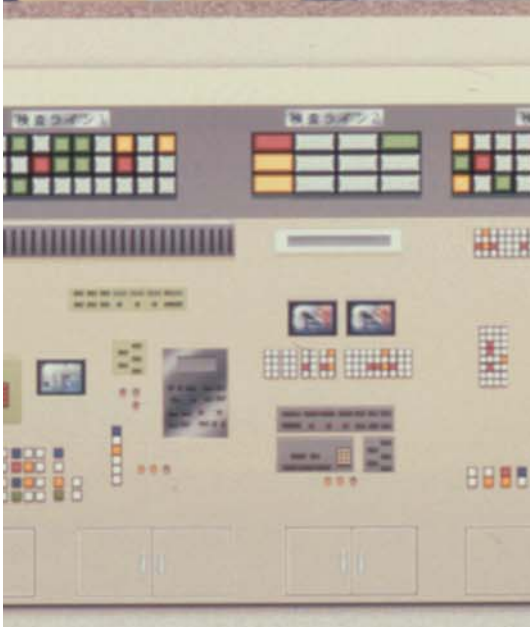



















Ø30 Series











Control Units













ø30 ø30 Series Control Units (Selection Guide)





















Function	Emergency Stop Switch	Pushbutton							
Category	Pushlock Turn Reset	Flush		Extended		Extended with Half Shroud		Extended with Full Shroud	
		Momentary/Maintained							
Shape	 	 	 	 	 				
Type	HN1E	ABN1 AON1	(Diecast) ABD1 AOD1	ABN2 AON2	(Diecast) ABD2 AOD2	ABN2G AON2G	(Diecast) ABGD2 AOGD2	ABN2F AON2F	(Diecast) ABFD2 AOFD2
Page	6	13	69	13	69	13	69	13	69













Function	Pushbutton									
Category	Mushroom		Mushroom with Full Shroud		Palm Mushroom		Jumbo Mushroom with Shallow Shroud		Jumbo Mushroom with Deep Shroud	
	Momentary/Maintained					Momentary				
Shape	 	 	 	 	 					
Type	ABN3 AON3	(Diecast) ABD3 AOD3	ABN3G (Diecast) ABGD3 AOGD3	ABN4 (Diecast) ABD4	ABN4G (Diecast) ABGD4	ABN4F (Diecast) ABFD4				
Page	14	70	14	70	14	70	14	70	14	70





















Function	Pushbutton						
Category	Square Flush		Square Extended		Mushroom Pushlock Turn Reset	Mushroom Pushlock Key Reset	Jumbo Mushroom Pushlock Key Reset
	Momentary		Momentary				
Shape	 	 	 	 	 		
Type	UBQN1		UBQN2		AVN3 (Diecast) AVD3	ABN3K	ABN4K
Page	14		14		15	15	15



















Function	Pushbutton									
Category	Mushroom Push Turn Lock		Key ON/OFF Lock		Toggle Lever		Mushroom Pull		Mushroom Push-Pull	
Shape	 	 	 	 	 					
Type	AJN3 (Diecast) AJD3	ABN5	ATN4	ATN23 (Diecast) AZD3	ATN21 ATN22 (Diecast) AYD3					
Page	15	71	15	16	71	16	71			

ø30 Series Control Units (Selection Guide) ø30





Function	Pushbutton			Twin Maintained Pushbutton	
Category	Pin Lock	Square Twin	Square Twin	Flush	Mushroom
		Momentary	Maintained		
Shape	   	   	   	   	   
Type	ABN8P (Diecast) ABD8P	UWQN1	UWQN2	ABBN11	ABBN33
Page	16 71	17	17	17	17





Function	Pilot Light (LED)			Pilot Light (Incandescent)	
Category	Dome	Square	Rectangular (Marking)	Dome (1W)	Dome (2W)
		Shape	   	   	   
Type	APN1 APNE1 (Diecast) APD1 APDE1	UPQN3B	UPQN4 UPQNE4	APN1 (Diecast) APD1	APN1 APNE1 (Diecast) APD1 APDE1
Page	18 72	19	19	19 72	18 72





Function	Pilot Light (Incandescent)			Illuminated Pushbutton (LED)	
Category	Rectangular (Marking) (1W/2W)	Square Flush (1W)	Dome	Extended	Extended with Half Shroud
			Push-to-Check	Momentary/Maintained	
Shape	   	   	   	   	   
Type	UPQN4 UPQNE4	UPQN3B	APN1*P	ALN2 ALNE2 AOLN2 AOLNE2 (Diecast) ALD2 AOLD2	ALGN2 ALGNE2 AOLGN2 AOLGNE2
Page	19	19	21	22 73	24





Function	Illuminated Pushbutton (LED)				(Incandescent)	
Category	Extended with Full Shroud	Mushroom	Mushroom Pushlock Turn Reset	Mushroom Push Turn Lock	Extended	
	Momentary/Maintained				Momentary/Maintained	
Shape	   	   	  	   	   	
Type	ALFN2 ALFNE2 AOLFN2 AOLFNE2 (Diecast) ALFD2 AOLFD2	ALN3 ALNE3 AOLN3 AOLNE3 (Diecast) ALD3 AOLD3	AVLN3 AVLNE3 (Diecast) AVLDE3	AJLN3	ALN ALNE AOLN AOLNE (Diecast) ALD2 AOLD2	
Page	26 74	28 75	31 76	31	23 73	

ø30 ø30 Series Control Units (Selection Guide)

Function	Illuminated Pushbutton (Incandescent)					
Category	Extended with Half Shroud	Extended with Full Shroud	Square Flush	Rectangular	Turn Lock	
	Momentary	Momentary/Maintained		Momentary/Maintained		
Shape						
Type	ALN*G ALNE3G3	ALN*F ALNE3F3 AOLN*F AOLNE3F3	(Diecast) ALFD2 AOLFD2	ULQN UOLQN	ULQN*B UOLQN*B	ALN*L
Page	25	27	74	29	29	30

Function	Illuminated Pushbutton (Incandescent)		Selector Switch						
Category	Mushroom Pushlock Turn Reset	Mushroom Push Turn Lock	Knob	Lever	Key				
	Shape								
Type	AVLN3 AVLNE3	(Diecast) AVLD3 AVLDE3	AJLN3	ASN ASTN	(Diecast) ASD	ASN*L ASTN*L	(Diecast) ASD*L	ASN*K ASTN*K	(Diecast) ASD*K
Page	32	76	32	33/37	77	34/38	78	35/39	79

Function	Illuminated Selector Switch (LED)		Illuminated Selector Switch (Incandescent)		Selector Pushbutton		Mono-Lever Switch		
Category	Knob		Knob		Ring	Lever	Standard		
	Shape								
Type	ASLN	(Diecast) ASLD	ASLN	(Diecast) ASLD	ABN	(Diecast) ASBD2	ABN*L	(Diecast) ASBD2L	ARN ARNS
Page	40	80	40	80	42	82	42	82	44

Function	Mono-Lever Switch		Cam Switch			
Category	Interlocking		Knob	Key	Maintained/ Spring Return	Spring Return
	Shape					
Type	ARNL		ACSNO ACSSO	ACSNK ACSSK	UCSQO	UCSQM
Page	44		47	47	47	47

ø30 HN Series Emergency Stop Switches

Emergency Stop Switches (Unibody Type) Specifications

Contact Ratings

Rated Insulation Voltage (Ui)		250V			
Rated Thermal Current (Ith)		10A			
Rated Operational Voltage (Ue)		24V	110V	220V	
Rated Operational Current	AC 50/60 Hz	Resistive Load (AC-12)	6A	3A	3A
		Inductive Load (AC-15)	6A	3A	3A
	DC	Resistive Load (DC-12)	6A	2A	1A
		Inductive Load (DC-13)	1.5A	0.3A	0.15A

Note: The operational current represents the classification by making and breaking currents (IEC 60947-5-1). Minimum applicable load (reference value): 3V AC/DC, 5 mA (Applicable range may vary with operating conditions and load types.)

LED Lamp Ratings

Unit Rated Operating Voltage	LED Lamp		
	Type No.	Rated Voltage	Rated Current
24V AC/DC	LSTD-2R	24V AC/DC ±10%	10 mA

Incandescent Lamp Ratings

Unit Rated Operating Voltage	Incandescent Lamp	
	Type No.	Wattage
24V AC/DC	LS-3	1W (30V)



Specifications

Operating Temperature	-25 to +60°C (no freezing) Illuminated units: -25 to +55°C
Storage Temperature	-40 to +80°C
Operating Humidity	45 to 85% RH (no condensation)
Contact Resistance	50 mΩ maximum (initial value)
Insulation Resistance	100 MΩ minimum (500V DC megger)
Dielectric Strength	Between live and dead metal parts
	Contacts: 2,500V AC, 1 minute Illuminated parts: 1,000V AC, 1 minute
Vibration Resistance	Damage limits: 60 m/s ²
	Operating extremes: 5 to 55 Hz, amplitude 0.5 mm
Shock Resistance	Damage limits: 1,000 m/s ²
	Operating extremes: 100 m/s ²
Operating Frequency	900 operations/h
Life	Mechanical: 250,000 operations minimum
	Electrical: 100,000 operations minimum
Degree of Protection	IP65
Terminal Style	M3.5 screw

Applicable Standards and Approvals



Safety Standards	File No. or Organization
UL508	UL Listing File No. E55996
CSA C22.2 No. 14	c-UL (File No. E55996)
EN60947-5-5	DEMKO approved

Pushlock Turn Reset Switches (Unibody Type)

Shape	Contact	Type No.	Button Color
 	1NO-1NC	HN1E-BV411R	Red only
	2NC	HN1E-BV402R	

- When pressed, the button is held depressed. The button is released by turning clockwise.
- Terminal cover HW-VL7 is supplied with the switch.

Illuminated Pushlock Turn Reset Switches (Unibody Type)

Shape	Lamp	Contact	Type No.	Lens Color
 	Without Lamp	1NO-1NC	HN1E-LV411Q0R	Red only
		2NC	HN1E-LV402Q0R	

- When pressed, the button is held depressed. The button is released by turning clockwise.
- The illuminated pushlock turn reset switch does not contain a lamp. Order LED or incandescent lamps separately. For lamps, see page 63.
- Terminal cover HW-VL7 is supplied with the switch.

ø30 HN Series Emergency Stop Switches

Dimensions

• HN1E-BV4

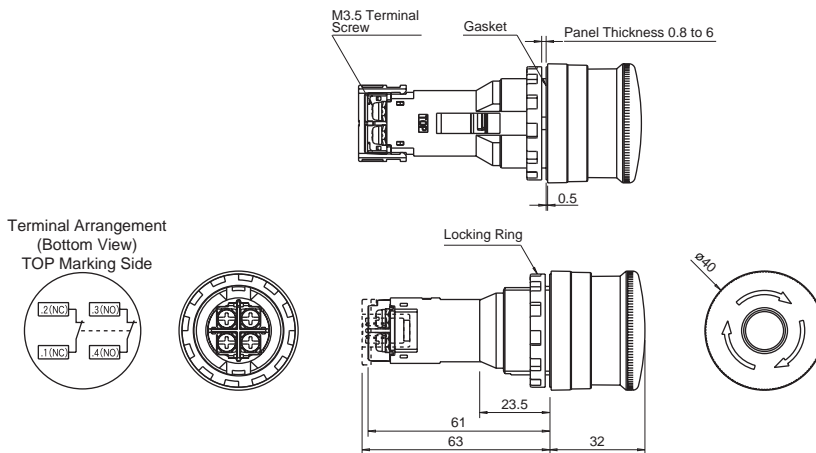

Panel Cut-Out

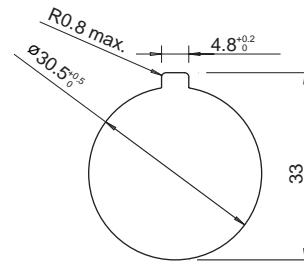

• HN1E-LV4

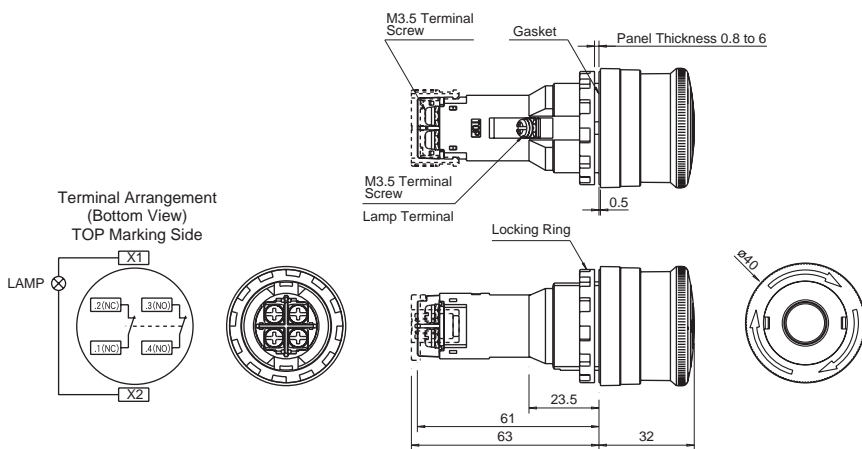

All dimensions in mm.

Replacement Parts

Name	Type No.	Ordering Type No.	Package Quantity	Remarks
Terminal Cover	HW-VL7	HW-VL7PN10	10	Used on HN1E emergency stop switches for preventing electrical shocks. The HW-VL7 terminal cover is supplied with the HN1E.

Nameplates

Shape	Type No.	Legend	Package Quantity	Remarks
	HNAV-0	(blank)	1	Background: Yellow Legend: Black Applicable panel thickness: 0.8 to 4.5 mm Material: Polyamide Legend "EMERGENCY STOP" is indicated outside a ø44mm circle.
	HNAV-27	EMERGENCY STOP		



Accessory

Shape	Material	Type No.	Package Quantity	Remarks
	Metal	TWST-T1	1	<ul style="list-style-type: none"> Used for tightening the locking nut. Tighten the locking nut to a torque of 2.0 to 2.5 N·m.

ø30 ø30 Series Control Units

Heavy duty control units offer both variety and reliability Endures harsh environments

- Degree of protection: IP65
- UL, CSA approved, and EN compliant.

Safety Standards	File No. or Organization
UL 	UL Listing File No. E68961
CSA 	File No. LR21451
EN EN60947-5-1	

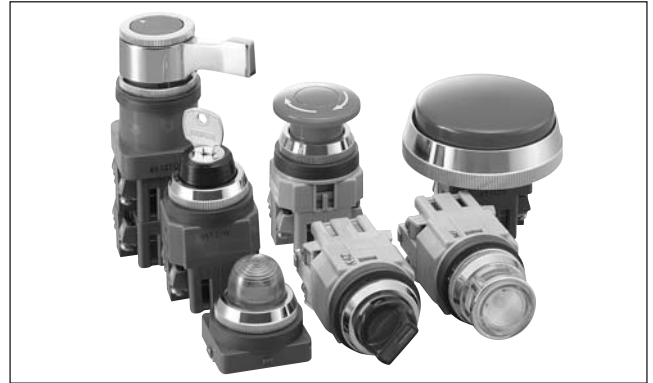

Specifications and Ratings

Contact Ratings

Pushbuttons Illuminated Pushbuttons Selector Switches Illuminated Selector Switches Selector Pushbuttons	Contact Block	Type BS/BST (ø30 series)
	Rated Insulation Voltage	600V
	Rated Continuous Current	10A
	Contact Ratings by Utilization Category IEC 60947-5-1	AC-15 (A600) DC-13 (P600)

Characteristics

• Contact Ratings by Utilization Category

Operational Voltage		24V	48V	50V	110V	220V	440V
Operational Current	AC 50/60 Hz	AC-12 Control of resistive loads and solid state loads 10A	—	10A	10A	6A	2A
		AC-15 Control of electromagnetic loads (> 72 VA) 10A	—	7A	5A	3A	1A
	DC	DC-12 Control of resistive loads and solid state loads 10A	5A	—	2.2A	1.1A	—
		DC-13 Control of electromagnets 5A	2A	—	1.1A	0.6A	—

Note: The operational current represents the classification by making and breaking currents (IEC 60947-5-1).



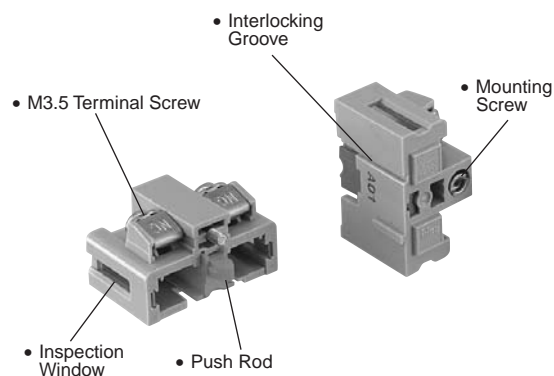

Minimum applicable load: 3V AC/DC, 5 mA (applicable range may vary with operating conditions and load types)

For mono-levers and cam switches, see pages 43 and 46.

BS (BST) Contact Block



• Contact Block Types

Contact	Single-pole Contact Block Type			
				
Type	BS	BST	BS	BST
	BS010E	BST010	BS001E	BST001
	BS010SE	BST010S	BS001SE	BST001S
Push Rod	Green	Red	Black	White

BST contact blocks are used for the following control units and are not interchangeable with BS contact blocks.
(The BS housing is dark gray and the BST housing is light gray.)

- Pushlock turn reset and push turn lock switches
- LED illuminated pushbuttons
- LED/incandescent illuminated selector switches
- All models of diecast zinc housing control units

- Durable nylon 66 housing has a high resistance against alkalis.
- Silver contacts.
- Up to four blocks in two layers can be mounted onto each operator.

ø30 ø30 Series Control Units





LED Illuminated Unit Specifications

Unit	Color Code ②	Input Type	Operating Voltage	LED Lamp		
				Lamp Base	Type No.	Voltage
Pilot Light Illuminated Pushbutton Illuminated Selector Switch	A: amber G: green PW: pure white R: red S: blue W: white Y: yellow	Full Voltage	6V AC/DC	BA9S/13	LSTD-6②	6V AC/DC ±10%
			12V AC/DC		LSTD-1②	12V AC/DC ±10%
			24V AC/DC		LSTD-2②	24V AC/DC ±10%
			6V AC/DC	E12/15	LETD-6②	6V AC/DC ±10%
			12V AC/DC		LETD-8②	12V AC/DC ±10%
			24V AC/DC		LETD-2②	24V AC/DC ±10%
		Transformer	100/110V AC/DC 115V AC/DC 120V AC/DC 200/220V AC/DC 230V AC/DC 240V AC/DC 380V AC/DC 400/440V AC/DC (50/60 Hz)	BA9S/13	LSTD-6②	6V AC/DC ±10%
				E12/15	LETD-6②	
		DC-DC Converter	110V DC	BA9S/13	LSTD-6②	6V AC/DC ±10%
				E12/15	LETD-6②	

Incandescent Illuminated Unit Specifications

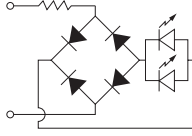
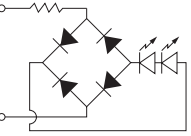
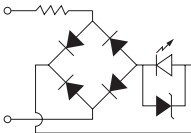
Unit	Color Code ②	Input Type	Operating Voltage	Incandescent Lamp		
				Lamp Base	Type No.	Rating
Pilot Light Illuminated Pushbutton Illuminated Selector Switch	A: amber G: green O: orange R: red S: blue W: white	Full Voltage	6V AC/DC	BA9S/13	LS-6	1W (6.3V)
			12V AC/DC		LS-8	1W (18V)
			24V AC/DC		LS-3	1W (30V)
			6V AC/DC	E12/15	LE-6	2W (6.3V)
			12V AC/DC		LE-8	2W (18V)
			24V AC/DC		LE-3	12W (30V)
		Transformer	100/110V AC/DC 115V AC/DC 120V AC/DC 200/220V AC/DC 230V AC/DC 240V AC/DC 380V AC/DC 400/440V AC/DC 480V AC/DC (50/60 Hz)	BA9S/13	LS-6	1W (6.3V)
				E12/15	LE-8	2W (18V)

LED Lamp Ratings (LSTD Type)

Type No.	LSTD-6②	LSTD-1②	LSTD-2②
Lamp Base	BA9S/13		
Rated Voltage	6V AC/DC	12V AC/DC	24V AC/DC
Voltage Range	6V AC/DC ±10%	12V AC/DC ±10%	24V AC/DC ±10%
Current Draw	AC	A, R, W, Y: 17 mA G, PW, S: 8 mA	11 mA
	DC	A, R, W, Y: 14 mA G, PW, S: 5.5 mA	10 mA
Color Code ②	A (amber), G (green), PW (pure white), R (red), S (blue), W (white), Y (yellow)		
Lamp Base Color	Same as illumination color		
Voltage Marking	Die stamped on the base		
Life (reference value)	Approx. 50,000 hours (The luminance is reduced to 50% the initial intensity when used on complete DC.)		
Internal Circuit	A, R, W, Y		A, R, W, Y
			
	G, PW, S		
			 LED Chip  Protection Diode  Zener Diode

LED Lamp Ratings (LETD Type)

Type No.	LETD-6 ^②		LETD-8 ^②	LETD-2 ^②
Lamp Base	E12/15			
Rated Voltage	6V AC/DC		12V AC/DC	24V AC/DC
Voltage Range	6V AC/DC ±10%		12V AC/DC ±10%	24V AC/DC ±10%
Current Draw	AC	A, R, W, Y: 17 mA G, S: 8 mA	7 mA	11 mA
	DC	A, R, W, Y: 14 mA G, S: 5.5 mA	6.5 mA	10 mA
Color Code ^②	A (amber), G (green), R (red), S (blue), W (white), Y (yellow)			
Lamp Base Color	Same as illumination color			
Voltage Marking	Die stamped on the base			
Life (reference value)	Approx. 50,000 hours (The luminance is reduced to 50% the initial intensity when used on complete DC.)			
Internal Circuit	A, R, W, Y		A, R, W, Y	
	G, S		G, S	
			LED Chip Protection Diode Zener Diode	

Incandescent Lamp Ratings (LS Type)

Type No.	LS-6	LS-8	LS-2	LS-3
Lamp Base	BA9S/13			
Rated Voltage	6V AC/DC	12V AC/DC	18V AC/DC	24V AC/DC
Wattage	1W (6.3V)	1W (18V)	1W (24V)	1W (30V)
Voltage Marking	Die stamped on the base			
Life (reference value)	Approx. 1,000 hours minimum (mean value when used on the rated voltage)			

Incandescent Lamp Ratings (LE Type)

Type No.	LE-6	LE-8	LE-2	LE-3
Lamp Base	E12/15			
Rated Voltage	6V AC/DC	12V AC/DC	18V AC/DC	24V AC/DC
Wattage	2W (6.3V)	2W (18V)	2W (24V)	2W (30V)
Voltage Marking	Die stamped on the base			
Life (reference value)	Approx. 1,000 hours minimum (mean value when used on the rated voltage)			

ø30 ø30 Series Control Units

Specifications

Operating Temperature	-25 to +50°C (no freezing)	
Operating Humidity	45 to 85% RH (no condensation)	
Contact Resistance	50 mΩ maximum (initial value)	
Insulation Resistance	100 MΩ minimum (500V DC megger)	
Dielectric Strength	Between live and dead metal parts: 2,500V AC, 1 minute (Full voltage type and pilot lights: 2,000V AC, 1 minute)	
Vibration Resistance	Operating extremes: 5 to 55 Hz, amplitude 0.5 mm	
Shock Resistance	Damage limits:	1,000 m/s ²
	Operating extremes:	100 m/s ²
Mechanical Life (minimum operations)	Pushbuttons	
	Momentary:	5,000,000
	Maintained:	500,000
	Illuminated pushbuttons	
	Momentary:	2,500,000
	Maintained:	500,000
	Selector switches:	500,000
	Key selector switches:	500,000
	Illuminated selector switches:	500,000
	Selector pushbuttons:	250,000
	Mono-lever switches:	500,000
	(Interlocking type):	250,000
	Pushlock turn reset	500,000
Electrical Life (minimum operations)	Mushroom push-pull switch	
	Two contact blocks:	500,000
	Four contact blocks:	200,000
	Pushbuttons:	500,000 *1
	Illuminated pushbuttons:	500,000 *1
	Selector switches:	500,000 *2
	Key selector switches:	500,000 *2
	Illuminated selector switches:	500,000 *2
	Selector pushbuttons:	250,000 *2
	Mono-lever switches:	500,000 *3
(Interlocking type):	250,000 *3	
*1 Switching frequency 1,800 operations/h, duty ratio 40% *4		
*2 Switching frequency 1,200 operations/h, duty ratio 40%		
*3 Switching frequency 900 operations/h, duty ratio 40%		
*4 Switching frequency 900 operations/h for square twin or twin maintained types		

Degree of Protection

Type No.	Unit	NEMA ICS 6-110	IEC 60529
A****	Pushbuttons, pilot lights, illuminated pushbuttons, selector switches, selector pushbuttons, mono-lever switches, and cam switches (ACSNO/ACSSO)	Type 1, 2, 3, 3R, (3S), 4, 5, 12,13	IP65
	Illuminated selector switches, key pushbuttons, key reset pushbuttons, key cam switches, and key selector switches	Type 1, 2, 3, 3R, 5, 12, 13	IP54
U****	Square pushbuttons, square pilot lights, and cam switches (UC)	Type 1, 2	IP40

Note: (3S) of NEMA ICS 6-110 applies to the pilot lights with round lens.

Mounting Hole Layout

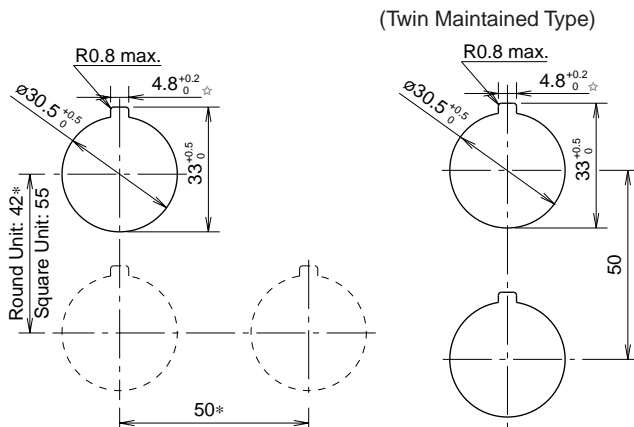

*The minimum mounting centers are applicable to switches with one layer of contact blocks (two contact blocks). When two layers of contact blocks (four contact blocks) are mounted, determine the minimum mounting centers in consideration of convenience for wiring.

- Mushroom with shroud: 50 mm minimum
- Jumbo mushroom: 67 mm minimum
- Jumbo mushroom with shroud: 76 mm minimum
- Square twin: 55 mm minimum
- Selector switch with lever: 50 mm minimum

☆ The 4.8 mm recess is for preventing rotation and is not necessary when the nameplate or anti-rotation ring is not used.

Note: For mounting hole layout of pushbuttons, mono-lever switches, and cam switches, see each section.

Ordering Information

Standard Units

- Specify an operator or lens color code in the Type No.
- Black, green, and red buttons are included with flush push-buttons.
- Full voltage type illuminated units are not supplied with a lamp. Order LED or incandescent lamps separately. Transformer and DC-DC converter type illuminated units contain an LED or incandescent lamp.
- Terminal covers, nameplates, and accessories are ordered separately.

Terminal Cover

- When a terminal cover is required, order an applicable terminal cover referring to page 55.

The Type No. development charts shown below can be used to specify control units other than those listed on the following pages. Gold-plated silver contacts are also available.

ø30 Series Pushbuttons

ABN2 11 R - MAU

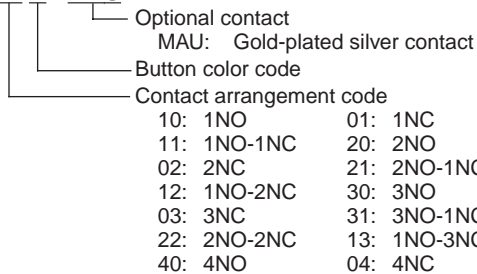

Note:

- Mushroom pull type ATN23 can have a maximum of two contact blocks.
- Mushroom push-pull return type ATN22 cannot have only NO or only NC contacts.
- No other contact configurations are available for square twin type UWQN1 than those specified in this catalog.

ø30 Series Pilot Lights

APN1 116 D R

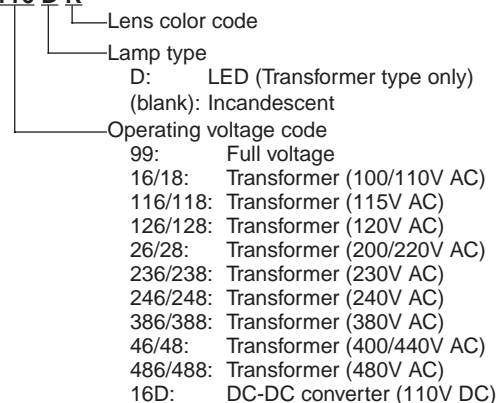

Note:

- Full voltage type is not supplied with a lamp.
- Transformer and DC-DC converter types contain an LED lamp (LSTD-6② or LETD-6②) or incandescent lamp (LS-6, 1W or LE-8, 2W).
- LED lamps cannot be used on 480V AC transformers.
- DC-DC converter is available with LED lamps only.
- Operating voltage codes 18, 118, 128, 28, 238, 248, 388, 48, and 488 are available for incandescent types only.

ø30 Series Illuminated Pushbuttons

ALFN2 116 13 D N R - MAU

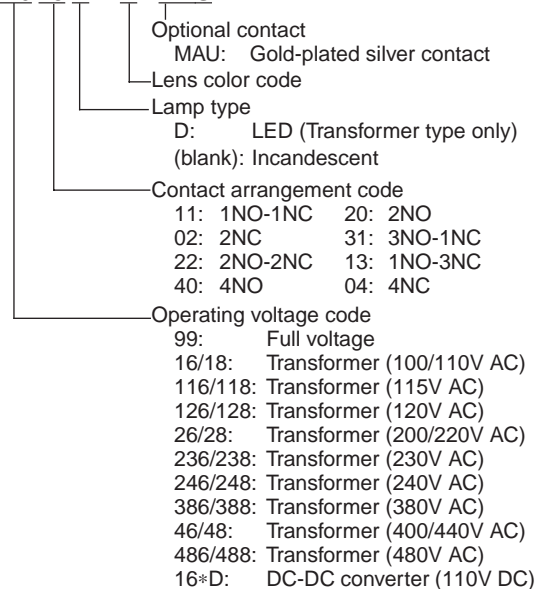

Note:

- Illuminated pushbuttons cannot have an odd number of contact blocks, such as 1NO, 1NC, 3NO, 2NO-1NC, 1NO-2NC, and 3NC.
- Transformer and DC-DC converter types contain an LED lamp (LSTD-6② or LETD-6②) or incandescent lamp (LS-6, 1W or LE-8, 2W).
- LED lamps cannot be used on 480V AC transformers.
- DC-DC converter is available with LED lamps only.
- Operating voltage codes 18, 118, 128, 28, 238, 248, 388, 48, and 488 are available for incandescent types only.

ø30 ø30 Series Control Units (Ordering Information)

ø30 Series Selector Switch

ASN 2 L 11 - MAU

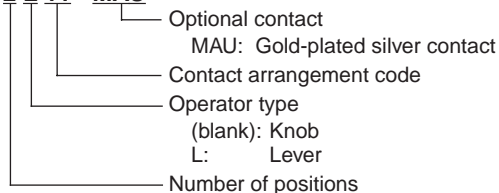

ø30 Series Key Selector Switch

ASN 2 K 20 B - MAU

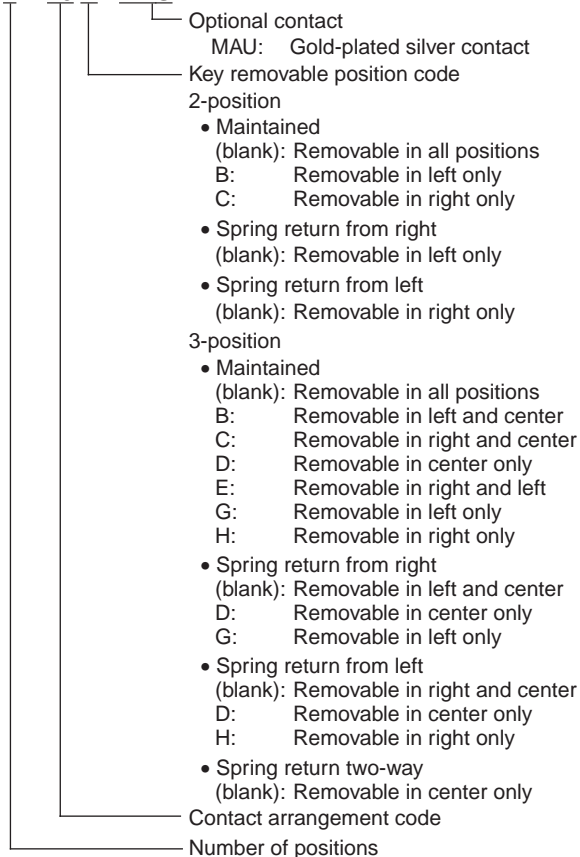

Note:

- The key cannot be removed in the return position.

ø30 Series Illuminated Selector Switch



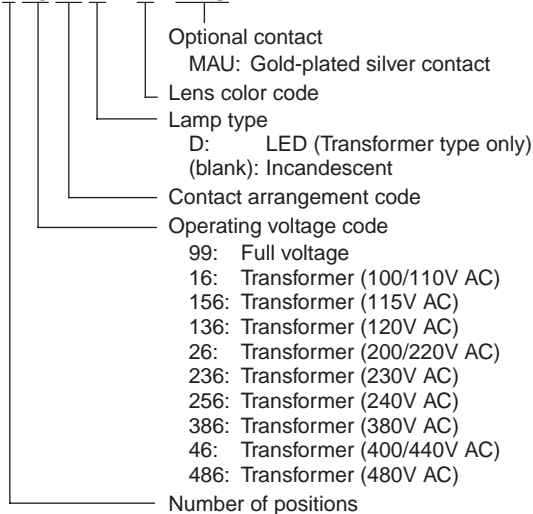









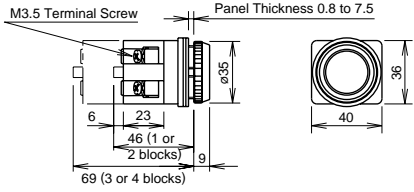

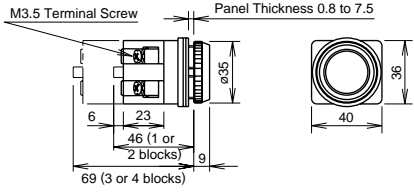
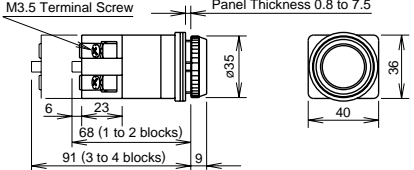

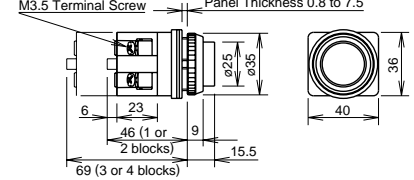
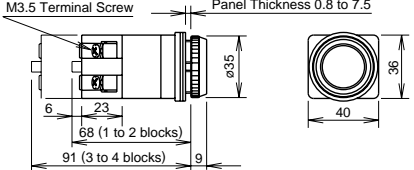
ASLN 2 16 22 D N R - MAU

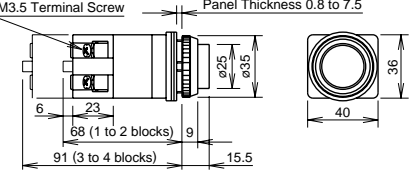

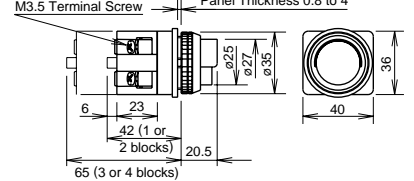
Note:

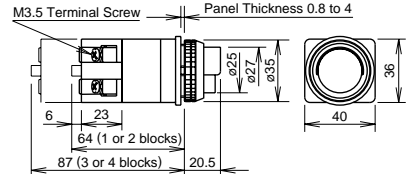
- Full voltage type is not supplied with a lamp.
- Transformer type contain an LED lamp (LSTD-6②) or incandescent lamp (LS-6, 1W).
- LED lamps cannot be used on 480VAC transformers.

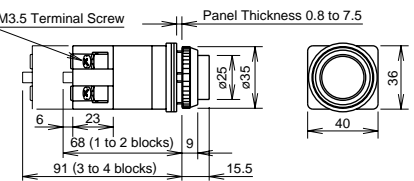
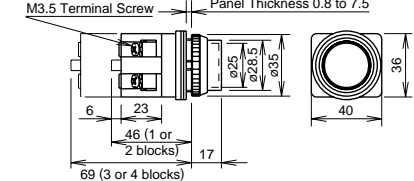

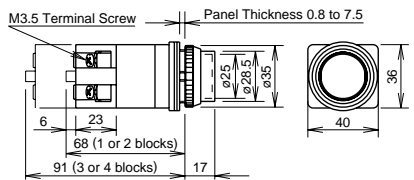











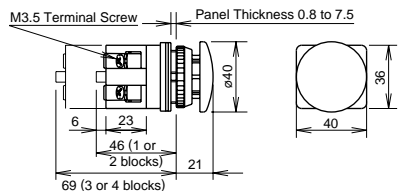



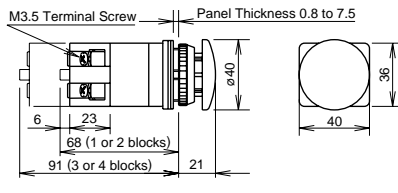



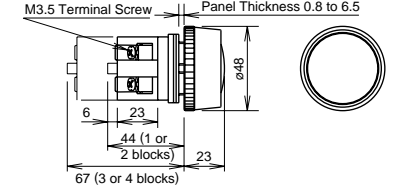



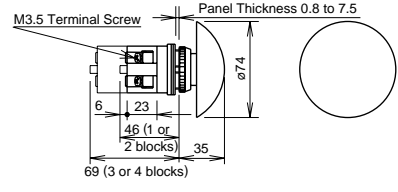



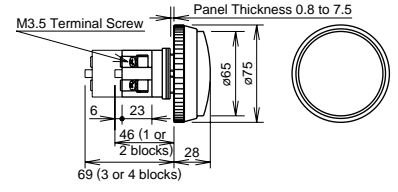

Flush / Extended / Extended w/Half Shroud / Extended w/Full Shroud Types

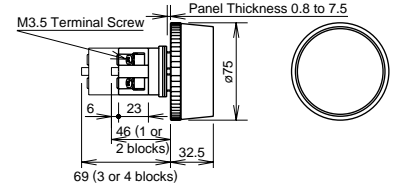
Shape	Operation Type	Contact	Type No.	① Button Color Code	Dimensions (mm)
Flush ABN1  	Momentary	1NO	ABN110①	Black (B), green (G), and red (R) buttons are supplied with each unit.	
		1NC	ABN101①		
		1NO-1NC	ABN111①		
		2NO	ABN120①		
		2NC	ABN102①		
		2NO-2NC	ABN122①		
Flush AON1  	Maintained	1NO	AON110①	Specify Y or W when a yellow or white button is required.	
		1NC	AON101①		
		1NO-1NC	AON111①		
		2NO	AON120①		
		2NC	AON102①		
		2NO-2NC	AON122①		
Extended ABN2  	Momentary	1NO	ABN210①		
		1NC	ABN201①		
		1NO-1NC	ABN211①		
		2NO	ABN220①		
		2NC	ABN202①		
		2NO-2NC	ABN222①		
Extended AON2  	Maintained	1NO	AON210①		
		1NC	AON201①		
		1NO-1NC	AON211①		
		2NO	AON220①		
		2NC	AON202①		
		2NO-2NC	AON222①		
Extended with Half Shroud ABN2G  	Momentary	1NO	ABN2G10①	Specify a button color code in place of ① in the Type No.	
		1NC	ABN2G01①		
		1NO-1NC	ABN2G11①		
		2NO	ABN2G20①		
		2NC	ABN2G02①		
		2NO-2NC	ABN2G22①		
Extended with Half Shroud AON2G  	Maintained	1NO	AON2G10①	B: black G: green R: red W: white Y: yellow	
		1NC	AON2G01①		
		1NO-1NC	AON2G11①		
		2NO	AON2G20①		
		2NC	AON2G02①		
		2NO-2NC	AON2G22①		
Extended with Full Shroud ABN2F  	Momentary	1NO	ABN2F10①		
		1NC	ABN2F01①		
		1NO-1NC	ABN2F11①		
		2NO	ABN2F20①		
		2NC	ABN2F02①		
		2NO-2NC	ABN2F22①		
Extended with Full Shroud AON2F  	Maintained	1NO	AON2F10①		
		1NC	AON2F01①		
		1NO-1NC	AON2F11①		
		2NO	AON2F20①		
		2NC	AON2F02①		
		2NO-2NC	AON2F22①		

- Round bezel and shroud (metal): Chrome-plated
- Other contact arrangements and gold-plated silver contacts are also available. See page 11.

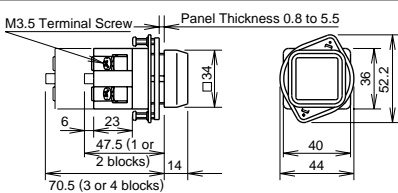



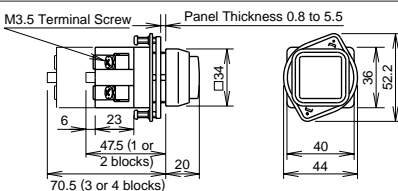





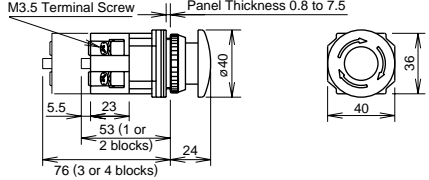

ø30 ø30 Series Pushbuttons

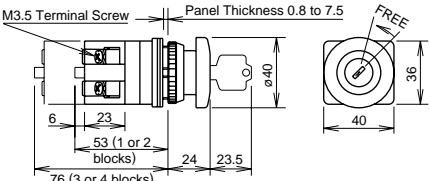
Mushroom / Jumbo Mushroom / Square Flush / Square Extended Types

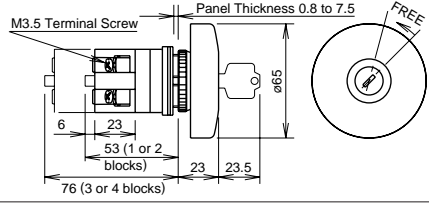
Shape	Operation Type	Contact	Type No.	① Button Color Code	Dimensions (mm)	
Mushroom ABN3    	Momentary	1NO	ABN310①	B: black G: green R: red W: white Y: yellow		
		1NC	ABN301①			
		1NO-1NC	ABN311①			
		2NO	ABN320①			
		2NC	ABN302①			
2NO-2NC	ABN322①					
Mushroom AON3    	Maintained	1NO	AON310①			
		1NC	AON301①			
		1NO-1NC	AON311①			
		2NO	AON320①			
		2NC	AON302①			
2NO-2NC	AON322①					
Mushroom with Full Shroud ABN3G    	Momentary	1NO	ABN3G10①			
		1NC	ABN3G01①			
		1NO-1NC	ABN3G11①			
		2NO	ABN3G20①			
		2NC	ABN3G02①			
2NO-2NC	ABN3G22①					
Palm Mushroom ABN4    	Momentary	1NO	ABN410①			
		1NC	ABN401①			
		1NO-1NC	ABN411①			
		2NO	ABN420①			
		2NC	ABN402①			
2NO-2NC	ABN422①					
Jumbo Mushroom with Shallow Shroud ABN4G    	Momentary	1NO	ABN4G10①	B: black G: green R: red		
		1NC	ABN4G01①			
		1NO-1NC	ABN4G11①			
		2NO	ABN4G20①			
		2NC	ABN4G02①			
2NO-2NC	ABN4G22①					
Jumbo Mushroom with Deep Shroud ABN4F    	Momentary	1NO	ABN4F10①			
		1NC	ABN4F01①			
		1NO-1NC	ABN4F11①			
		2NO	ABN4F20①			
		2NC	ABN4F02①			
2NO-2NC	ABN4F22①					
Square Flush UBQN1    	Momentary	1NO	UBQN110①	B: black G: green R: red Y: yellow		
		1NC	UBQN101①			
		1NO-1NC	UBQN111①			
		2NO	UBQN120①			
		2NC	UBQN102①			
2NO-2NC	UBQN122①					
Square Extended UBQN2    	Momentary	1NO	UBQN210①			
		1NC	UBQN201①			
		1NO-1NC	UBQN211①			
		2NO	UBQN220①			
		2NC	UBQN202①			
2NO-2NC	UBQN222①					

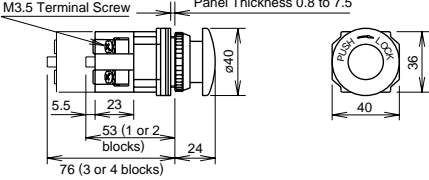

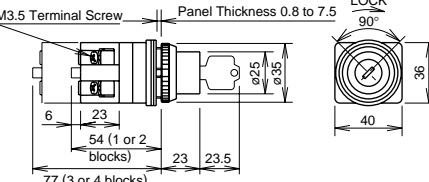

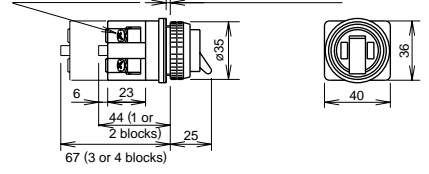

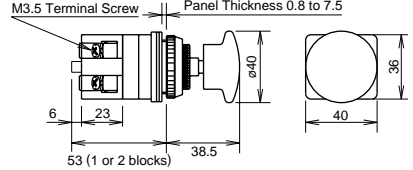

- Specify a button color code in place of ① in the Type No.
- Round bezel and shroud (metal): Chrome-plated
- Other contact arrangements and gold-plated silver contacts are also available. See page 11.

Pushlock Turn Reset / Pushlock Key Reset / Push Turn Lock / Key ON/OFF Lock / Toggle Lever Types

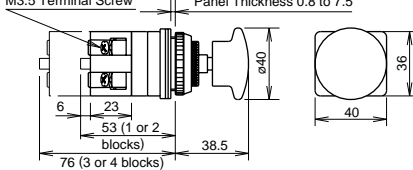
Shape	Contact	Type No.	① Button Color Code	Dimensions (mm)
Mushroom Pushlock Turn Reset AVN3  	1NO	AVN310N①	R: red Y: yellow	
	1NC	AVN301N①		
	1NO-1NC	AVN311N①		
	2NO	AVN320N①		
	2NC	AVN302N①		
Mushroom Pushlock Key Reset ABN3K  	1NO	ABN3K10①	B: black G: green R: red Y: yellow	
	1NC	ABN3K01①		
	1NO-1NC	ABN3K11①		
	2NO	ABN3K20①		
	2NC	ABN3K02①		
Jumbo Mushroom Pushlock Key Reset ABN4K  	1NO	ABN4K10①	B: black G: green R: red	
	1NC	ABN4K01①		
	1NO-1NC	ABN4K11①		
	2NO	ABN4K20①		
	2NC	ABN4K02①		
Mushroom Push Turn Lock AJN3  	1NO	AJN310N①	B: black G: green R: red Y: yellow	
	1NC	AJN301N①		
	1NO-1NC	AJN311N①		
	2NO	AJN320N①		
	2NC	AJN302N①		
Key ON/OFF Lock ABN5  	1NO	ABN510	-	
	1NC	ABN501		
	1NO-1NC	ABN511		
	2NO	ABN520		
	2NC	ABN502		
Toggle Lever ATN4  	1NO	ATN410	Lever: black	
	1NC	ATN401		
	1NO-1NC	ATN411		
	2NO	ATN420		
	2NC	ATN402		
2NO-2NC	ATN422			

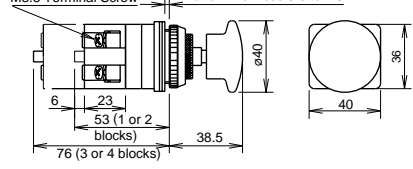
- Specify a button color code in place of ① in the Type No.
 - Round bezel (metal): Chrome-plated
 - Cylinder (metal): Chrome-plated
 - Other contact arrangements and gold-plated silver contacts are also available. See page 11.
 - **Pushlock Turn Reset:** Button is maintained when pressed and is reset when turned clockwise. Red buttons only.
- Note: AVN3 pushlock turn reset switches cannot be used as emergency stop switches. When emergency stop switches are required, use the HN1E series emergency stop switches (ISO 13850 and IEC 60947-5-5 compliant).
- **Pushlock Key Reset:** Button is maintained when pressed and is reset with a key. Key is removable from both depressed and reset positions. Two keys are supplied.
 - **Push Turn Lock:** Button is locked when turned clockwise in the depressed position and is reset when turned counterclockwise.
 - **Key ON/OFF Lock:** Button can be locked in both depressed and reset positions.
 - **Toggle Lever:** ON and OFF are indicated on the cap.

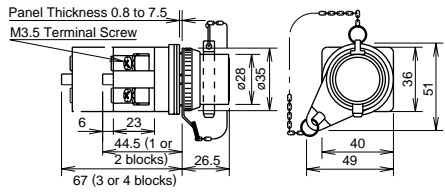
Pull / Push-Pull / Pin Lock Types

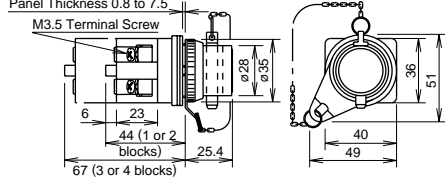
Shape	Contact	Type No.	① Button Color Code	Dimensions (mm)				
Mushroom Pull ATN23  UL LISTED SP CE	1NO	ATN2310①	B: black G: green R: red Y: yellow					
	1NO-1NC	ATN2311①						
	2NO	ATN2320①						
	2NC	ATN2320①						
Mushroom Push-Pull ATN21  UL LISTED SP	1NO-1NC	ATN2111①		B: black G: green R: red Y: yellow				
	2NO	ATN2120①						
	2NC	ATN2102①						
	2NO-2NC	ATN2122①						
Mushroom Push-Pull (Spring Return) ATN22  UL LISTED SP CE	1NO-1NC	ATN2211①			B: black G: green R: red Y: yellow			
	2NO-2NC	ATN2222①						
Pin Lock ABN8P  UL LISTED SP CE	1NO	ABN8P10					B: black G: green R: red Y: yellow	
	1NC	ABN8P01						
	1NO-1NC	ABN8P11						
	2NO	ABN8P20						
	2NC	ABN8P02						
	2NO-2NC	ABN8P22						
Pin Lock (ON Lock Type) ABN8P** -TK231-1  UL LISTED SP CE	1NO	ABN8P10-TK231-1	B: black G: green R: red Y: yellow					
	1NC	ABN8P01-TK231-1						
	1NO-1NC	ABN8P11-TK231-1						
	2NO	ABN8P20-TK231-1						
	2NC	ABN8P02-TK231-1						
	2NO-2NC	ABN8P22-TK231-1						

- Specify a button color code in place of ① in the Type No.
- Round bezel and shroud (metal): Chrome-plated
- Square bezel (metal): Chrome-plated
- Other contact arrangements and gold-plated silver contacts are also available. See page 11.
- **Pull:** Pulling the button operates the contacts. Up to 2 contact blocks (1 layer) can be mounted on pull switches.
- **Push-Pull:** Button is maintained in both depressed and reset positions.
- **Push-Pull (Spring Return):** Pushing or pulling the button operates the contacts. Button is spring-returned to the center position.
- **Pin Lock:** Button can be locked in either depressed or reset position by inserting the pin. Pad lock with a ø6mm pin can also be used to lock the button.
- **Pin Lock (ON Lock Type):** Button is locked in the depressed position by inserting the pin. Button cannot be locked in the reset position.







• Contact Operation

Contact	ATN23	
	Normal	Pull
1NO	○●	○●
1NC	●●	●●
1NO-1NC	○● ●●	○● ●●
2NO	○● ○●	○● ○●
2NC	●● ●●	●● ●●

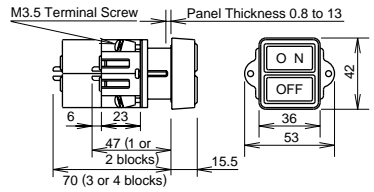
Contact	ATN21	
	Push	Pull
1NO-1NC	○● ●●	○● ●●
2NO	○● ○●	○● ○●
2NC	●● ●●	●● ●●
2NO-2NC	○● ●● ○● ●●	○● ●● ○● ●●

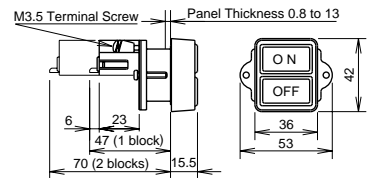
Contact	ATN22		
	Push	Normal	Pull
1NO-1NC	○● ●●	○● ●●	○● ●●
2NO-2NC	○● ●● ○● ●●	○● ●● ○● ●●	○● ●● ○● ●●

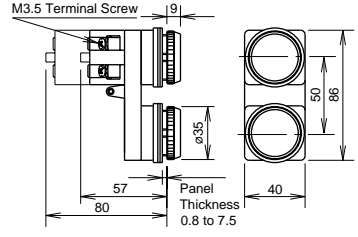
Square Twin / Twin Maintained Types

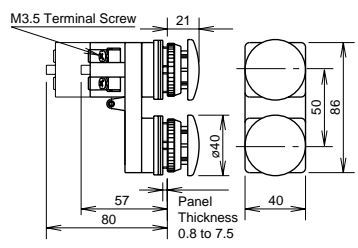
Shape	Contact		Type No.	Button Color	Dimensions (mm)
	ON	OFF			
Square Twin (Momentary) UWQN1 	1NO	1NO	UWQN11010	ON: Black OFF: Red	
	1NO	1NC	UWQN11001		
	2NO	2NC	UWQN12002		
Square Twin (Maintained) UWQN2 	1NO	–	UWQN21000	ON: Black OFF: Red	
	1NC	–	UWQN20100		
	1NO-1NC	–	UWQN21100		
	2NO	–	UWQN22000		
	2NC	–	UWQN20200		
Flush Twin Maintained ABBN11 	Top	Bottom		Black (B), green (G), and red (R) buttons are supplied with each unit. Other color buttons are separately ordered. See page 61.	
	1NO	–	ABBN1110		
	1NC	–	ABBN1101		
	1NO-1NC	–	ABBN1111		
	2NO	–	ABBN1120		
	2NC	–	ABBN1102		
Mushroom Twin Maintained (Without buttons) ABBN33 	Top	Bottom		Order buttons separately. See page 61.	
	1NO	–	ABBN3310		
	1NC	–	ABBN3301		
	1NO-1NC	–	ABBN3311		
	2NO	–	ABBN3320		
	2NC	–	ABBN3302		

- Round bezel (metal): Chrome-plated
- Other contact arrangements and gold-plated silver contacts are also available. See page 11.
- **Square Twin (Momentary):** Two independent momentary switches are contained in one unit, each operated by ON or OFF button. With the ø30 adapter removed from the sleeve, the unit can mount in a ø25.5mm mounting hole for the ø25 series.
- **Square Twin (Maintained):** The contact operates when ON button is pressed and is maintained in the depressed position. The button is reset by pressing the OFF button.
- **Twin Maintained:** The contact operates when the top button is pressed and is maintained in the depressed position. The button is reset by pressing the bottom button.
 Different combinations of flush, extended buttons, and colors are available (ABN1B-*, ABN2B-*). See page 61.
 Mushroom buttons for the ABBN33 are ordered separately. Specify the color code (ABN3B-*). See page 61.

ø30 ø30 Series Pilot Lights

Dome Types

Shape	Lamp	Input Type	Lamp Receptacle	Type No.	② Lens/LED Color Code	Applicable Lamp	
Dome APN1 APNE1 	Without Lamp	Full Voltage	BA9S	APN199②	A: amber C: clear G: green O: orange R: red S: blue W: white Y: yellow	LSTD LS (1W)	
			E12	APNE199②		LETD LE (2W)	
	LED	Transformer		BA9S	APN1③DN②	A: amber G: green PW: pure white**	LSTD-6②
				E12	APNE1③DN②	R: red S: blue W: white Y: yellow	LETD-6②
		DC-DC Converter*		BA9S	APN116DDN②	R: red S: blue W: white Y: yellow	LSTD-6②
				E12	APNE116DDN②		LETD-6②
	Incandescent	Transformer		BA9S	APN1③②	C: clear G: green O: orange R: red S: blue W: white	LS-6 (1W)
				E12	APN1③②		LE-8 (2W)

• Operating Voltage Code

Specify an operating voltage code in place of ③ in the Type No.

③ Operating Voltage Code	
LED Transformer BA9S and E12 Types Incandescent Transformer BA9S Type	Incandescent Transformer E12 Type
16: 100/110V AC	18: 100/110V AC
116: 115V AC	118: 115V AC
126: 120V AC	128: 120V AC
26: 200/220V AC	28: 200/220V AC
236: 230V AC	238: 230V AC
246: 240V AC	248: 240V AC
386: 380V AC	388: 380V AC
46: 400/440V AC	48: 400/440V AC
486: 480V AC (incandescent only)	488: 480V AC

- Specify a lens/LED color code in place of ② in the Type No. Use the white lens (W) for LED pure white illumination.
- Full voltage types do not contain a lamp. Order LED or incandescent lamps separately. For lamps, see page 63.
- LED illuminated transformer and DC-DC converter types contain an LED lamp: LSTD-6② or LETD-6② (rated voltage 6V AC/DC).
- Incandescent illuminated transformer types contain an incandescent lamp: LS-6 (1W, 6V AC/DC) or LE-8 (2W, 18V AC/DC).
- * DC-DC converter types are not approved by UL and CSA, and not CE compliant (operating voltage 90 to 140V DC).
- ** Pure white is available for BA9S lamp base types only.

Dimensions

• Full Voltage Type

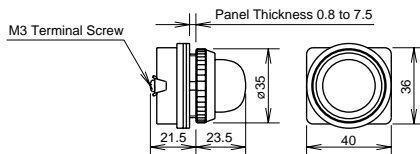



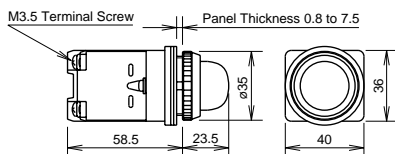



- Transformer Type
- DC-DC Converter Type



All dimensions in mm.

Square / Rectangular (Marking) Types

Shape	Lamp	Input Type	Lamp Receptacle	Type No.	② Lens/LED Color Code	Applicable Lamp
Square UPQN3B  	Without Lamp	Full Voltage	BA9S	UPQN3B99②	A: amber C: clear G: green O: orange R: red S: blue W: white Y: yellow	LSTD LS (1W)
	LED	Transformer	BA9S	UPQN3B③D②	A: amber G: green R: red S: blue W: white Y: yellow	LSTD-6②
		DC-DC Converter*	BA9S	UPQN3B16DD②	A: amber G: green R: red S: blue W: white Y: yellow	LSTD-6②
Incandescent	Transformer	BA9S	UPQN3B③②	C: clear G: green O: orange R: red S: blue W: white	LS-6 (1W)	
Rectangular (Marking Type) UPQN4  	Without Lamp	Full Voltage	BA9S	UPQN499②	A: amber G: green O: orange R: red S: blue W: white Y: yellow	LSTD LS (1W)
	LED	Transformer	BA9S	UPQN4③D②	A: amber G: green R: red S: blue W: white Y: yellow	LSTD-6②
		DC-DC Converter*	BA9S	UPQN416DD②	A: amber G: green R: red S: blue W: white Y: yellow	LSTD-6②
Incandescent	Transformer	BA9S	UPQN4③②	G: green O: orange R: red S: blue W: white	LS-6 (1W)	
Rectangular (Marking Type) UPQNE4 UPQN4  	Without Lamp	Full Voltage	E12	UPQNE499②	A: amber G: green O: orange R: red S: blue W: white Y: yellow	LETD LE (2W)
	LED	Transformer	E12	UPQNE4③D②	A: amber G: green R: red S: blue W: white Y: yellow	LETD-6②
		DC-DC Converter*	E12	UPQNE416DD②	A: amber G: green R: red S: blue W: white Y: yellow	LETD-6②
Incandescent	Transformer	E12	UPQN4③②	G: green O: orange R: red S: blue W: white	LE-8 (2W)	

ø30 ø30 Series Pilot Lights

• Operating Voltage Code

Specify an operating voltage code in place of ③ in the Type No.

③ Operating Voltage Code	
LED Transformer BA9S and E12 Types Incandescent Transformer BA9S Type	Incandescent Transformer E12 Type
16: 100/110V AC	18: 100/110V AC
116: 115V AC	118: 115V AC
126: 120V AC	128: 120V AC
26: 200/220V AC	28: 200/220V AC
236: 230V AC	238: 230V AC
246: 240V AC	248: 240V AC
386: 380V AC	388: 380V AC
46: 400/440V AC	48: 400/440V AC
486: 480V AC (incandescent only)	488: 480V AC

- Specify a lens/LED color code in place of ② in the Type No.
- On the rectangular marking type, a clear lens and a color marking plate are used for white illumination.
- Full voltage types do not contain a lamp. Order LED or incandescent lamps separately. For lamps, see page 63.
- LED illuminated transformer and DC-DC converter types contain an LED lamp: LSTD-6② or LETD-6② (rated voltage 6V AC/DC).
- Incandescent illuminated transformer types contain an incandescent lamp: LS-6 (1W, 6V AC/DC) or LE-8 (2W, 18V AC/DC).
- Marking plate for the rectangular marking type: 24 × 30 mm, 2 mm thick
- * DC-DC converter types are not approved by UL and CSA, and not CE compliant (operating voltage 90 to 140V DC).

Dimensions

• Square Full Voltage Type UPQN3B

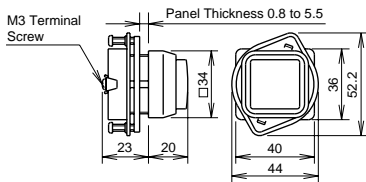

• Rectangular Full Voltage Type UPQN4

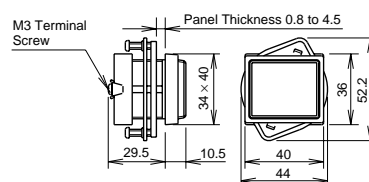

• Rectangular Full Voltage Type UPQE4

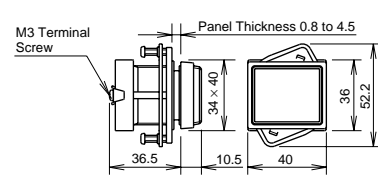

• Square Transformer Type • Square DC-DC Converter Type UPQN3B

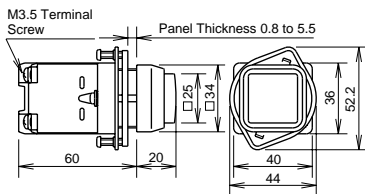

• Rectangular Transformer Type • Rectangular DC-DC Converter Type UPQN4

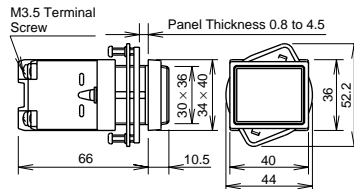

• Rectangular Transformer Type • Rectangular DC-DC Converter Type UPQE4

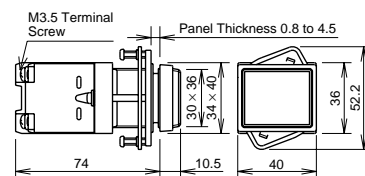

All dimensions in mm.

• Reflector

1. The lamp housing of the square type LED illuminated pilot lights has a built-in reflector.
2. Make sure that the reflector does not fall off when removing the lens or marking plate.
3. When replacing the LED lamp of UPQE4 (rectangular) type, use a lamp holder tool (OR-55).
4. To remove the reflector, insert a flat screwdriver inside the groove of the reflector and lightly push out.

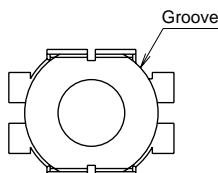

• Panel Mounting

1. Tighten the square ring to the operator and position the ring correctly.
2. Lightly tighten the screw to secure the pilot light onto the panel.

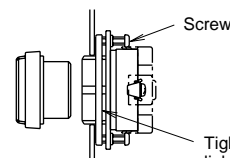

Tighten the screw lightly so that the panel does not bend.

Recommended tightening torque: 0.15 N·m

Incandescent		Push-to-Check Types (1W)				
Shape	Lamp	Input Type	Lamp Receptacle	Type No.	② Lens/LED Color Code	Applicable Lamp
Push-to-Check APN1*P 	Without Lamp	Full Voltage	BA9S	APN199P②	C: clear G: green O: orange R: red S: blue W: white	LS (1W)
	Incandescent	Transformer	BA9S	APN1③P②		LS-6 (1W)

• Operating Voltage Code

Specify an operating voltage code in place of ③ in the Type No.

③ Operating Voltage Code	
16:	100/110V AC
116:	115V AC
126:	120V AC
26:	200/220V AC
236:	230V AC
246:	240V AC
386:	380V AC
46:	400/440V AC
486:	480V AC

- Specify a lens color code in place of ② in the Type No.
- Full voltage types do not contain a lamp. Order incandescent lamps separately. For lamps, see page 63.
- Transformer types contain an incandescent lamp: LS-6 (1W, 6V AC/DC).

Circuit Example

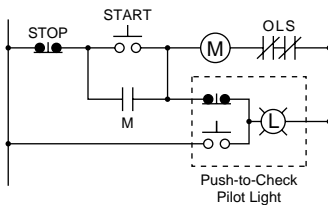

Note: The lamp of push-to-check pilot light is not connected to the contact terminal. To connect, refer to the diagram on the left.

Dimensions

- Push-to-Check
APN1*P

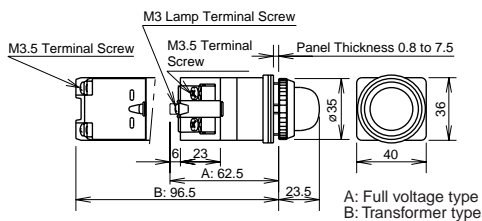

All dimensions in mm.

ø30 ø30 Series Illuminated Pushbuttons

LED Round Extended Illuminated Pushbuttons

Shape	Lamp Receptacle	Operation Type	Lamp	Input Type	Contact	Type No.	Applicable Lamp
Round Extended ALN2 AOLN2 ALNE2 AOLNE2 	BA9S	Momentary	Without Lamp	Full Voltage	1NO-1NC	ALN29911DN②	LSTD
					2NO	ALN29920DN②	
					2NC	ALN29902DN②	
		LED	Transformer	1NO-1NC	ALN2③11DN②	LSTD-6②	
				2NO	ALN2③20DN②		
				2NC	ALN2③02DN②		
	E12	Momentary	Without Lamp	Full Voltage	1NO-1NC	AOLN29911DN②	LSTD
					2NO	AOLN29920DN②	
					2NC	AOLN29902DN②	
		LED	Transformer	1NO-1NC	AOLN2③11DN②	LSTD-6②	
				2NO	AOLN2③20DN②		
				2NC	AOLN2③02DN②		
E12	Momentary	Without Lamp	Full Voltage	1NO-1NC	ALNE29911DN②	LETD	
				2NO	ALNE29920DN②		
				2NC	ALNE29902DN②		
	LED	Transformer	1NO-1NC	ALNE2③11DN②	LETD-6②		
			2NO	ALNE2③20DN②			
			2NC	ALNE2③02DN②			
E12	Maintained	Without Lamp	Full Voltage	1NO-1NC	AOLNE29911DN②	LETD	
				2NO	AOLNE29920DN②		
				2NC	AOLNE29902DN②		
	LED	Transformer	1NO-1NC	AOLNE2③11DN②	LETD-6②		
			2NO	AOLNE2③20DN②			
			2NC	AOLNE2③02DN②			



• Color Code and Operating Voltage Code

② Lens/LED Color Code	③ Operating Voltage Code
LED Illuminated Type	LED Transformer BA9S and E12 Types
Specify a lens/LED color code in place of ② in the Type No.	Specify an operating voltage code in place of ③ in the Type No.
A: amber G: green PW: pure white (BA9S type only) R: red S: blue W: white Y: yellow	16: 100/110V AC 116: 115V AC 126: 120V AC 26: 200/220V AC 236: 230V AC 246: 240V AC 386: 380V AC 46: 400/440V AC
Use the white lens (W) for LED pure white illumination.	

- Full voltage types do not contain a lamp. Order LED lamps separately. For lamps, see page 63.
- LED illuminated transformer types contain an LED lamp: LSTD-6② or LETD-6② (rated voltage 6V AC/DC).

Dimensions

• ALN2/AOLN2 BA9S/Full Voltage

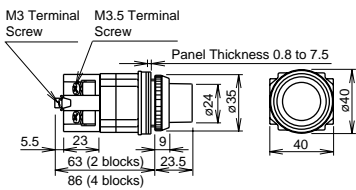

• ALN2/AOLN2 BA9S/Transformer

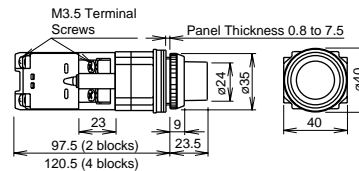

• ALNE2/AOLNE2 E12/Full Voltage

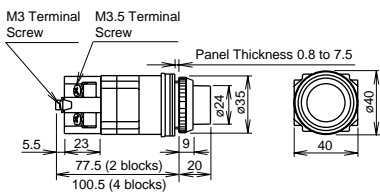



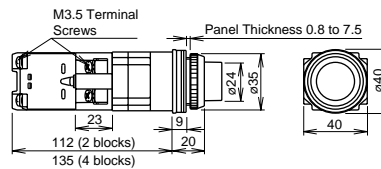





• ALNE2/AOLNE2 E12/Transformer



All dimensions in mm.

ø30 Series Illuminated Pushbuttons ø30

Incandescent Round Extended Illuminated Pushbuttons

Shape	Lamp Receptacle	Operation Type	Lamp	Input Type	Contact	Type No.	Applicable Lamp
Round Extended ALN ALNE      AOLN AOLNE   	BA9S	Momentary	Without Lamp	Full Voltage	1NO-1NC	ALN9911②	LS (1W)
					2NO	ALN9920②	
					2NC	ALN9902②	
		Maintained	Without Lamp	Full Voltage	1NO-1NC	AOLN9911②	LS (1W)
					2NO	AOLN9920②	
					2NC	AOLN9902②	
	E12	Momentary	Without Lamp	Full Voltage	1NO-1NC	ALNE9911②	LE (2W)
					2NO	ALNE9920②	
					2NC	ALNE9902②	
		Maintained	Without Lamp	Full Voltage	1NO-1NC	AOLNE9911②	LE (2W)
					2NO	AOLNE9920②	
					2NC	AOLNE9902②	
Incandescent	Transformer	Without Lamp	Transformer	1NO-1NC	ALN③11②	LS-6	
				2NO	ALN③20②		
				2NC	ALN③02②		
Incandescent	Transformer	Without Lamp	Transformer	1NO-1NC	AOLN③11②	LE-8	
				2NO	AOLN③20②		
				2NC	AOLN③02②		

• Color Code and Operating Voltage Code

② Lens Color Code	③ Operating Voltage Code	
Incandescent Illuminated Type	Incandescent Transformer BA9S Type	Incandescent Transformer E12 Type
Specify a lens color code in place of ② in the Type No.	Specify an operating voltage code in place of ③ in the Type No.	
C: clear G: green O: orange R: red S: blue W: white	16: 100/110V AC 116: 115V AC 126: 120V AC 26: 200/220V AC 236: 230V AC 246: 240V AC 386: 380V AC 46: 400/440V AC 486: 480V AC	18: 100/110V AC 118: 115V AC 128: 120V AC 28: 200/220V AC 238: 230V AC 248: 240V AC 388: 380V AC 48: 400/440V AC 488: 480V AC

- Full voltage types do not contain a lamp. Order incandescent lamps separately. For lamps, see page 63.
- Incandescent illuminated transformer types contain an incandescent lamp: LS-6 (1W, 6V AC/DC) or LE-8 (2W, 18V AC/DC).

Dimensions

• ALN Momentary BA9S/Full Voltage

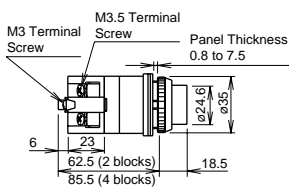

• ALN Momentary BA9S/Transformer

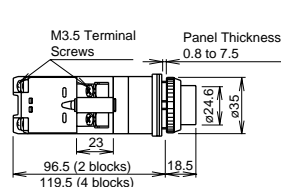

• AOLN Maintained BA9S/Full Voltage

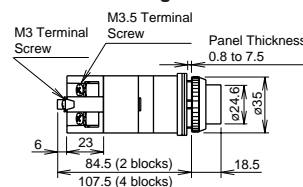

• AOLN Maintained BA9S/Transformer

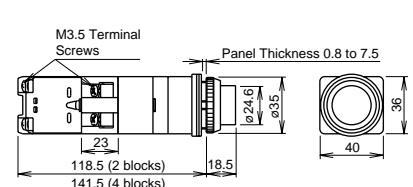

• ALNE Momentary E12/Full Voltage

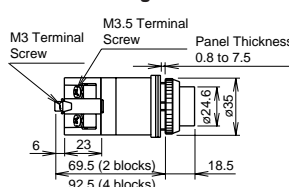

• ALNE Momentary E12/Transformer

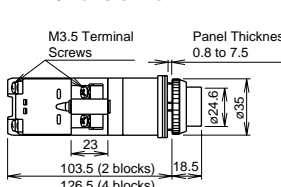

• AOLNE Maintained E12/Full Voltage

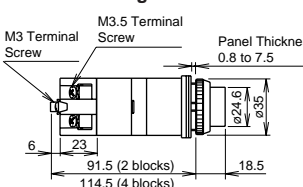

• AOLNE Maintained E12/Transformer

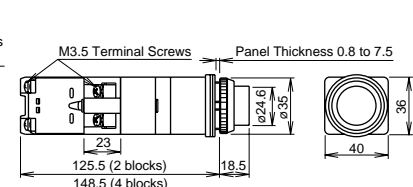

ø30 ø30 Series Illuminated Pushbuttons

LED Round Extended with Half Shroud Illuminated Pushbuttons

Shape	Lamp Receptacle	Operation Type	Lamp	Input Type	Contact	Type No.	Applicable Lamp
Round Extended ALGN2 AOLGN2 ALGNE2 AOLGNE2 	BA9S	Momentary	Without Lamp	Full Voltage	1NO-1NC	ALGN29911DN②	LSTD
					2NO	ALGN29920DN②	
					2NC	ALGN29902DN②	
		LED	Transformer	1NO-1NC	ALGN2③11DN②	LSTD-6②	
				2NO	ALGN2③20DN②		
				2NC	ALGN2③02DN②		
	Maintained	Without Lamp	Full Voltage	1NO-1NC	AOLGN29911DN②	LSTD	
				2NO	AOLGN29920DN②		
				2NC	AOLGN29902DN②		
	LED	Transformer	1NO-1NC	AOLGN2③11DN②	LSTD-6②		
			2NO	AOLGN2③20DN②			
			2NC	AOLGN2③02DN②			
E12	Momentary	Without Lamp	Full Voltage	1NO-1NC	ALGNE29911DN②	LETD	
				2NO	ALGNE29920DN②		
				2NC	ALGNE29902DN②		
	LED	Transformer	1NO-1NC	ALGNE2③11DN②	LETD-6②		
			2NO	ALGNE2③20DN②			
			2NC	ALGNE2③02DN②			
Maintained	Without Lamp	Full Voltage	1NO-1NC	AOLGNE29911DN②	LETD		
			2NO	AOLGNE29920DN②			
			2NC	AOLGNE29902DN②			
LED	Transformer	1NO-1NC	AOLGNE2③11DN②	LETD-6②			
		2NO	AOLGNE2③20DN②				
		2NC	AOLGNE2③02DN②				



• Color Code and Operating Voltage Code

② Lens/LED Color Code	③ Operating Voltage Code
LED Illuminated Type	LED Transformer BA9S and E12 Types
Specify a lens/LED color code in place of ② in the Type No.	Specify an operating voltage code in place of ③ in the Type No.
A: amber G: green PW: pure white (BA9S type only) R: red S: blue W: white Y: yellow	16: 100/110V AC 116: 115V AC 126: 120V AC 26: 200/220V AC 236: 230V AC 246: 240V AC 386: 380V AC 46: 400/440V AC
Use the white lens (W) for LED pure white illumination.	

- Full voltage types do not contain a lamp. Order LED lamps separately. For lamps, see page 63.
- LED illuminated transformer types contain an LED lamp: LSTD-6② or LETD-6② (rated voltage 6V AC/DC).

Dimensions

• ALGN2/AOLGN2 BA9S/Full Voltage

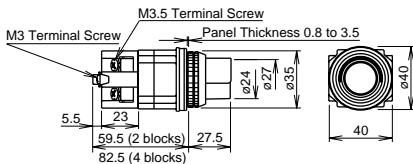

• ALGN2/AOLGN2 BA9S/Transformer

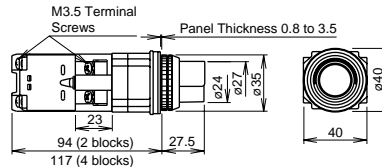

• ALGNE2/AOLGNE2 E12/Full Voltage

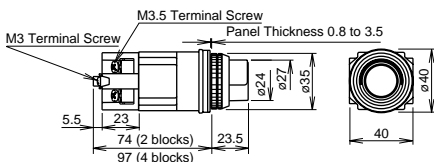

• ALGNE2/AOLGNE2 E12/Transformer

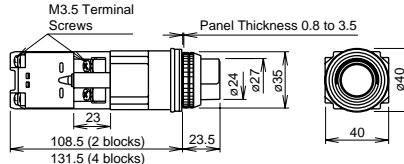

All dimensions in mm.

ø30 Series Illuminated Pushbuttons ø30

Incandescent Round Extended with Half Shroud Illuminated Pushbuttons

Shape	Lamp Receptacle	Operation Type	Lamp	Input Type	Contact	Type No.	Applicable Lamp
 Round Extended ALN*G ALNE*G	BA9S	Momentary	Without Lamp	Full Voltage	1NO-1NC	ALN9G911②	LS (1W)
					2NO	ALN9G920②	
					2NC	ALN9G902②	
			Incandescent	Transformer	1NO-1NC	ALN③11②	LS-6
					2NO	ALN③20②	
					2NC	ALN③02②	
	E12	Momentary	Without Lamp	Full Voltage	1NO-1NC	ALNE9G911②	LE (2W)
					2NO	ALNE9G920②	
					2NC	ALNE9G902②	
			Incandescent	Transformer	1NO-1NC	ALN③11②	LE-8
					2NO	ALN③20②	
					2NC	ALN③02②	

• Color Code and Operating Voltage Code

② Lens Color Code	③ Operating Voltage Code	
Incandescent Illuminated Type	Incandescent Transformer BA9S Type	Incandescent Transformer E12 Type
Specify a lens color code in place of ② in the Type No.	Specify an operating voltage code in place of ③ in the Type No.	
C: clear G: green O: orange R: red S: blue W: white	1G6: 100/110V AC 11G6: 115V AC 12G6: 120V AC 2G6: 200/220V AC 23G6: 230V AC 24G6: 240V AC 38G6: 380V AC 4G6: 400/440V AC 48G6: 480V AC	1G8: 100/110V AC 11G8: 115V AC 12G8: 120V AC 2G8: 200/220V AC 23G8: 230V AC 24G8: 240V AC 38G8: 380V AC 4G8: 400/440V AC 48G8: 480V AC

- Full voltage types do not contain a lamp. Order incandescent lamps separately. For lamps, see page 63.
- Incandescent illuminated transformer types contain an incandescent lamp: LS-6 (1W, 6V AC/DC) or LE-8 (2W, 18V AC/DC).

Dimensions

• ALN*G Momentary BA9S/Full Voltage

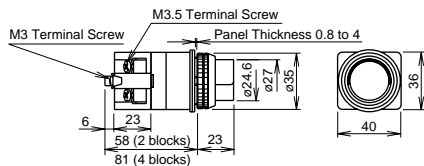

• ALN*G Momentary BA9S/Transformer

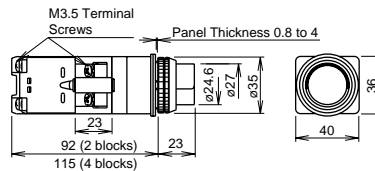

• ALNE*G Momentary E16/Full Voltage

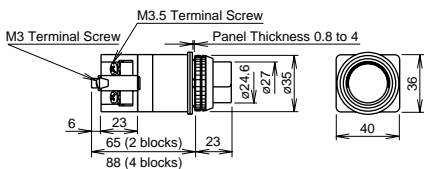

• ALNE*G Momentary E16/Transformer

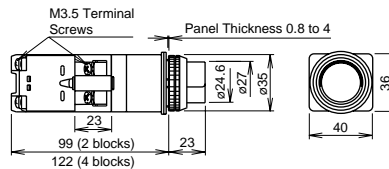

All dimensions in mm.

ø30 ø30 Series Illuminated Pushbuttons

LED Round Extended with Full Shroud Illuminated Pushbuttons

Shape	Lamp Receptacle	Operation Type	Lamp	Input Type	Contact	Type No.	Applicable Lamp
Round Extended ALFN2 AOLFNE2 ALFNE2 AOLFNE2 	BA9S	Momentary	Without Lamp	Full Voltage	1NO-1NC	ALFN29911DN②	LSTD
					2NO	ALFN29920DN②	
					2NC	ALFN29902DN②	
		LED	Transformer	1NO-1NC	ALFN2③11DN②	LSTD-6②	
				2NO	ALFN2③20DN②		
				2NC	ALFN2③02DN②		
	Maintained	Without Lamp	Full Voltage	1NO-1NC	AOLFNE29911DN②	LSTD	
				2NO	AOLFNE29920DN②		
				2NC	AOLFNE29902DN②		
	LED	Transformer	1NO-1NC	AOLFNE2③11DN②	LSTD-6②		
			2NO	AOLFNE2③20DN②			
			2NC	AOLFNE2③02DN②			
E12	Momentary	Without Lamp	Full Voltage	1NO-1NC	ALFNE29911DN②	LETD	
				2NO	ALFNE29920DN②		
				2NC	ALFNE29902DN②		
	LED	Transformer	1NO-1NC	ALFNE2③11DN②	LETD-6②		
			2NO	ALFNE2③20DN②			
			2NC	ALFNE2③02DN②			
Maintained	Without Lamp	Full Voltage	1NO-1NC	AOLFNE29911DN②	LETD		
			2NO	AOLFNE29920DN②			
			2NC	AOLFNE29902DN②			
LED	Transformer	1NO-1NC	AOLFNE2③11DN②	LETD-6②			
		2NO	AOLFNE2③20DN②				
		2NC	AOLFNE2③02DN②				



• Color Code and Operating Voltage Code

② Lens/LED Color Code	③ Operating Voltage Code
LED Illuminated Type	LED Transformer BA9S and E12 Types
Specify a lens/LED color code in place of ② in the Type No.	Specify an operating voltage code in place of ③ in the Type No.
A: amber G: green PW: pure white (BA9S type only) R: red S: blue W: white Y: yellow	16: 100/110V AC 116: 115V AC 126: 120V AC 26: 200/220V AC 236: 230V AC 246: 240V AC 386: 380V AC 46: 400/440V AC
Use the white lens (W) for LED pure white illumination.	

- Full voltage types do not contain a lamp. Order LED lamps separately. For lamps, see page 63.
- LED illuminated transformer types contain an LED lamp: LSTD-6② or LETD-6② (rated voltage 6V AC/DC).

Dimensions

• ALFN2/AOLFNE2 BA9S/Full Voltage

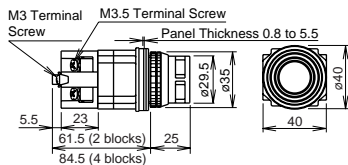

• ALFN2/AOLFNE2 BA9S/Transformer

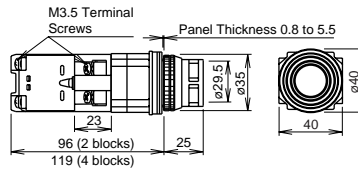

• ALFNE2/AOLFNE2 E12/Full Voltage

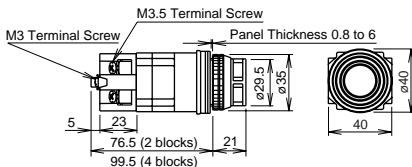

• ALFNE2/AOLFNE2 E12/Transformer

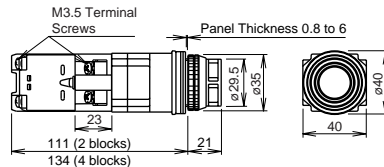

All dimensions in mm.

ø30 Series Illuminated Pushbuttons ø30

Incandescent Round Extended with Full Shroud Illuminated Pushbuttons

Shape	Lamp Receptacle	Operation Type	Lamp	Input Type	Contact	Type No.	Applicable Lamp		
Round Extended ALN*F ALNE*F AOLN*F AOLNE*F 	BA9S	Momentary	Without Lamp	Full Voltage	1NO-1NC	ALN9F911②	LS (1W)		
					2NO	ALN9F920②			
					2NC	ALN9F902②			
		Maintained	Without Lamp	Full Voltage	1NO-1NC	AOLN9F911②	LS-6		
					2NO	ALN③20②			
					2NC	ALN③02②			
		E12	Momentary	Without Lamp	Full Voltage	1NO-1NC	ALNE9F911②	LE (2W)	
						2NO	ALNE9F920②		
						2NC	ALNE9F902②		
			Maintained	Without Lamp	Full Voltage	1NO-1NC	AOLNE9F911②	LE (2W)	
						2NO	AOLNE9F920②		
						2NC	AOLNE9F902②		
Incandescent		Without Lamp	Transformer	1NO-1NC	ALN③11②	LE-8			
				2NO	ALN③20②				
				2NC	ALN③02②				
Incandescent		Without Lamp	Transformer	1NO-1NC	AOLN③11②	LE-8			
				2NO	AOLN③20②				
				2NC	AOLN③02②				

• Color Code and Operating Voltage Code

② Lens Color Code	③ Operating Voltage Code	
Incandescent Illuminated Type	Incandescent Transformer BA9S Type	Incandescent Transformer E12 Type
Specify a lens color code in place of ② in the Type No.	Specify an operating voltage code in place of ③ in the Type No.	
C: clear G: green O: orange R: red S: blue W: white	1F6: 100/110V AC 11F6: 115V AC 12F6: 120V AC 2F6: 200/220V AC 23F6: 230V AC 24F6: 240V AC 38F6: 380V AC 4F6: 400/440V AC 48F6: 480V AC	1F8: 100/110V AC 11F8: 115V AC 12F8: 120V AC 2F8: 200/220V AC 23F8: 230V AC 24F8: 240V AC 38F8: 380V AC 4F8: 400/440V AC 48F8: 480V AC

- Full voltage types do not contain a lamp. Order incandescent lamps separately. For lamps, see page 63.
- Incandescent illuminated transformer types contain an incandescent lamp: LS-6 (1W, 6V AC/DC) or LE-8 (2W, 18V AC/DC).

Dimensions

• ALN*F Momentary BA9S/Full Voltage

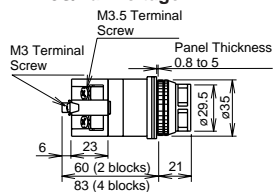

• ALN*F Momentary BA9S/Transformer

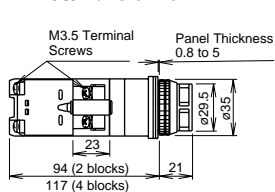

• AOLN*F Maintained BA9S/Full Voltage

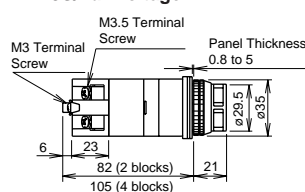

• ALON*F Maintained BA9S/Transformer

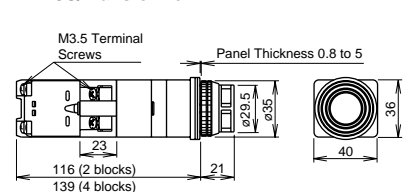

• ALNE*F Momentary E12/Full Voltage

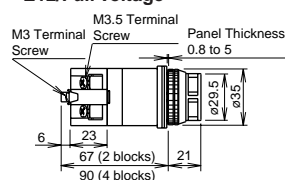

• ALN*F Momentary E12/Transformer

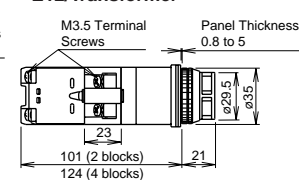

• AOLNE*F Maintained E12/Transformer

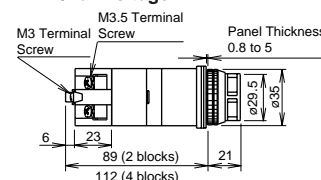

• AOLN*F Maintained E12/Full Voltage

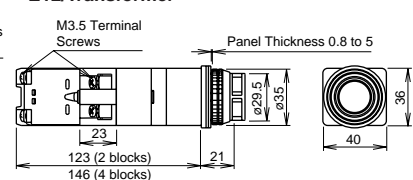

ø30 ø30 Series Illuminated Pushbuttons

LED Mushroom (ø40) Illuminated Pushbuttons

Shape	Lamp Receptacle	Operation Type	Lamp	Input Type	Contact	Type No.	Applicable Lamp
ø40 Mushroom ALN3 AOLN3 ALNE3 AOLNE3 	BA9S	Momentary	Without Lamp	Full Voltage	1NO-1NC	ALN39911DN②	LSTD
					2NO	ALN39920DN②	
					2NC	ALN39902DN②	
		LED	Transformer	1NO-1NC	ALN3③11DN②	LSTD-6②	
				2NO	ALN3③20DN②		
				2NC	ALN3③02DN②		
	E12	Momentary	Without Lamp	Full Voltage	1NO-1NC	AOLN39911DN②	LSTD
					2NO	AOLN39920DN②	
					2NC	AOLN39902DN②	
		LED	Transformer	1NO-1NC	AOLN3③11DN②	LSTD-6②	
				2NO	AOLN3③20DN②		
				2NC	AOLN3③02DN②		
E12	Momentary	Without Lamp	Full Voltage	1NO-1NC	ALNE39911DN②	LETD	
				2NO	ALNE39920DN②		
				2NC	ALNE39902DN②		
	LED	Transformer	1NO-1NC	ALNE3③11DN②	LETD-6②		
			2NO	ALNE3③20DN②			
			2NC	ALNE3③02DN②			
E12	Maintained	Without Lamp	Full Voltage	1NO-1NC	AOLNE39911DN②	LETD	
				2NO	AOLNE39920DN②		
				2NC	AOLNE39902DN②		
	LED	Transformer	1NO-1NC	AOLNE3③11DN②	LETD-6②		
			2NO	AOLNE3③20DN②			
			2NC	AOLNE3③02DN②			



• Color Code and Operating Voltage Code

② Lens/LED Color Code	③ Operating Voltage Code
LED Illuminated Type	LED Transformer BA9S and E12 Types
Specify a lens/LED color code in place of ② in the Type No.	Specify an operating voltage code in place of ③ in the Type No.
A: amber G: green R: red S: blue W: white Y: yellow	16: 100/110V AC 116: 115V AC 126: 120V AC 26: 200/220V AC 236: 230V AC 246: 240V AC 386: 380V AC 46: 400/440V AC

- Full voltage types do not contain a lamp. Order LED lamps separately. For lamps, see page 63.
- LED illuminated transformer types contain an LED lamp: LSTD-6② or LETD-6② (rated voltage 6V AC/DC).

Dimensions

• ALN3/AOLN3 BA9S/Full Voltage

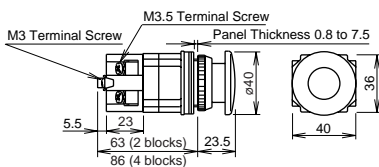

• ALN3/AOLN3 BA9S/Transformer

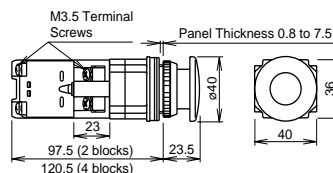

• ALNE3/AOLNE3 E12/Full Voltage

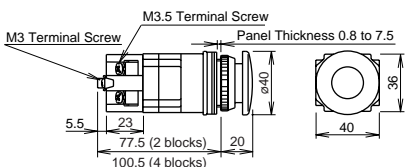



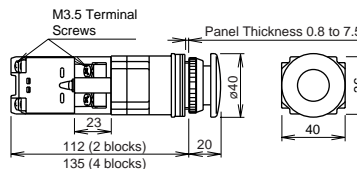

• ALNE3/AOLNE3 E12/Transformer



All dimensions in mm.

ø30 Series Illuminated Pushbuttons ø30

Incandescent Square and Rectangular Extended Illuminated Pushbuttons

Shape	Lamp Receptacle	Operation Type	Lamp	Input Type	Contact	Type No.	Applicable Lamp	
Square Extended ULQN   UL LISTED SF CE UOLQN	BA9S	Momentary	Without Lamp	Full Voltage	1NO-1NC	ULQN9911②	LS (1W)	
					2NO	ULQN9920②		
			2NC	ULQN9902②	LS-6			
			1NO-1NC	ULQN③11②				
		Maintained	Without Lamp	Full Voltage	2NO	ULQN③20②	LS (1W)	
					2NC	ULQN9902②		
			Incandescent	Transformer	1NO-1NC	UOLQN9911②		LS-6
					2NO	UOLQN③20②		
Rectangular (Marking Type) ULQN*B   UL LISTED SF CE UOLQN*B	BA9S	Momentary	Without Lamp	Full Voltage	1NO-1NC	ULQN9B911②	LS (1W)	
					2NO	ULQN9B920②		
			2NC	ULQN9B902②	LS-6			
			1NO-1NC	ULQN③11②				
		Maintained	Without Lamp	Full Voltage	2NO	ULQN③20②	LS (1W)	
					2NC	ULQN③02②		
			Incandescent	Transformer	1NO-1NC	UOLQN9B911②		LS-6
					2NO	UOLQN9B920②		
2NC	UOLQN9B902②	LS (1W)						
			1NO-1NC	UOLQN③11②	LS-6			
2NO	UOLQN③20②							
2NC	UOLQN③02②							

• Color Code and Operating Voltage Code

② Lens Color Code	③ Operating Voltage Code	
Incandescent Illuminated Type	Incandescent Transformer Square Extended Type	Incandescent Transformer Rectangular Marking Type
Specify a lens color code in place of ② in the Type No. C: clear (square type only) G: green O: orange R: red S: blue W: white Clear lens is not available for the rectangular type.	Specify an operating voltage code in place of ③ in the Type No. 16: 100/110V AC 116: 115V AC 126: 120V AC 26: 200/220V AC 236: 230V AC 246: 240V AC 386: 380V AC 46: 400/440V AC 486: 480V AC	1B6: 100/110V AC 11B6: 115V AC 12B6: 120V AC 2B6: 200/220V AC 23B6: 230V AC 24B6: 240V AC 38B6: 380V AC 4B6: 400/440V AC 48B6: 480V AC

- Full voltage types do not contain a lamp. Order incandescent lamps separately. For lamps, see page 63.
- Incandescent illuminated transformer types contain an incandescent lamp: LS-6 (1W, 6V AC/DC).

Dimensions

• ULQN Momentary BA9S/Full Voltage

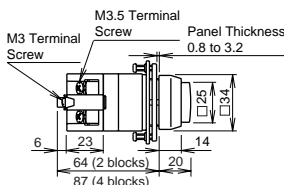

• ULQN Momentary BA9S/Transformer

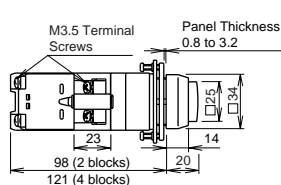

• UOLQN Maintained BA9S/Full Voltage

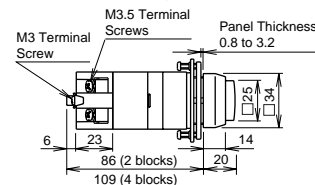

• UOLQN Maintained BA9S/Transformer

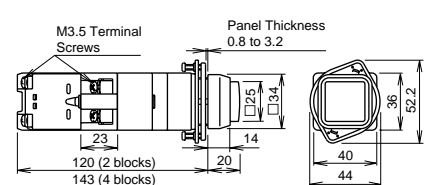

• ULQN*B Momentary BA9S/Full Voltage

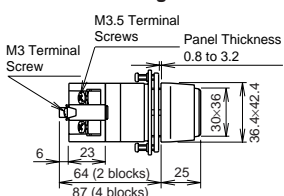

• ULQN*B Momentary BA9S/Transformer

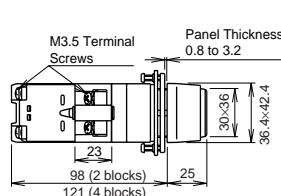

• UOLQN*B Maintained BA9S/Full Voltage

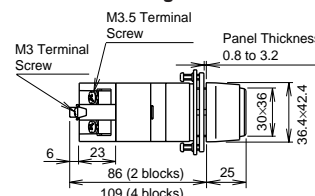

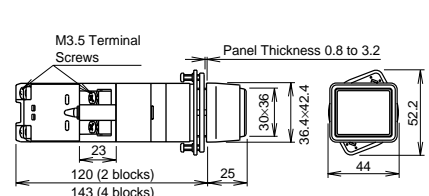

• UOLQN*B Maintained BA9S/Transformer



ø30 ø30 Series Illuminated Pushbuttons

Incandescent Push Turn Lock Switches

Shape	Lamp Receptacle	Operation Type	Lamp	Input Type	Contact	Type No.	Applicable Lamp
ALN*L  	BA9S	Push Turn Lock	Without Lamp	Full Voltage	1NO-1NC	ALN9L911②	LS (1W)
					2NO	ALN9L920②	
					2NC	ALN9L902②	
			Incandescent	Transformer	1NO-1NC	ALN③11②	LS-6
					2NO	ALN③20②	
					2NC	ALN③02②	

• Color Code and Operating Voltage Code

② Lens Color Code	③ Operating Voltage Code
Specify a lens color code in place of ② in the Type No.	Specify an operating voltage code in place of ③ in the Type No.
G: green O: orange R: red S: blue W: white	1L6: 100/110V AC 11L6: 115V AC 12L6: 120V AC 2L6: 200/220V AC 23L6: 230V AC 24L6: 240V AC 38L6: 380V AC 4L6: 400/440V AC 48L6: 480V AC

- Full voltage types do not contain a lamp. Order incandescent lamps separately. For lamps, see page 63.
- Incandescent illuminated transformer types contain an incandescent lamp: LS-6 (1W, 6V AC/DC).
- **Push Turn Lock:** Knob is maintained when turned clockwise in the depressed position and is reset when turned counterclockwise.

Dimensions

• ALN*L BA9S/Full Voltage

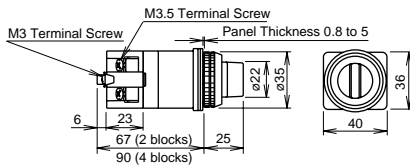



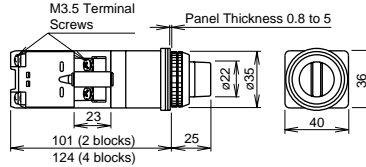

• ALN*L BA9S/Transformer



All dimensions in mm.

ø30 Series Illuminated Pushbuttons ø30

LED Pushlock Turn Reset / Push Turn Lock Types

Shape	Lamp Receptacle	Operation Type	Lamp	Input Type	Contact	Type No.	Applicable Lamp	
ø40 Mushroom Pushlock Turn Reset AVLN3 AVLNE3  	BA9S	Pushlock Turn Reset	Without Lamp	Full Voltage	1NO-1NC	AVLN39911DNR	LSTD	
					2NO	AVLN39920DNR		
					2NC	AVLN39902DNR		
	E12	Pushlock Turn Reset	Without Lamp	Full Voltage	1NO-1NC	AVLNE39911DNR	LETD	
					2NO	AVLNE39920DNR		
					2NC	AVLNE39902DNR		
ø40 Mushroom Push Turn Lock AJLN3  	BA9S	Push Turn Lock	Without Lamp	Full Voltage	1NO-1NC	AJLN39911DN ^②	LSTD	
					2NO	AJLN39920DN ^②		
					2NC	AJLN39902DN ^②		
				LED	Transformer	1NO-1NC	AJLN3 ^③ 11DN ^②	LSTD-6 ^②
						2NO	AJLN3 ^③ 20DN ^②	
						2NC	AJLN3 ^③ 02DN ^②	

• Color Code and Operating Voltage Code

② Lens/LED Color Code	③ Operating Voltage Code
LED Illuminated Type	LED Transformer BA9S Types
Specify a lens/LED color code in place of ② in the Type No.	Specify an operating voltage code in place of ③ in the Type No.
A: amber G: green R: red W: white Y: yellow	16: 100/110V AC 116: 115V AC 126: 120V AC 26: 200/220V AC 236: 230V AC 246: 240V AC 386: 380V AC 46: 400/440V AC

- Full voltage types do not contain a lamp. Order LED lamps separately. For lamps, see page 63.
 - LED illuminated transformer types contain an LED lamp: LSTD-6^② or LETD-6^② (rated voltage 6V AC/DC).
 - **Pushlock Turn Reset:** Lens is maintained when pressed and is reset when turned clockwise. Red lens only.
- Note: AVLN3 and AVLNE3 pushlock turn reset switches cannot be used as emergency stop switches. When emergency stop switches are required, use the HN1E series emergency stop switches (ISO 13850 and IEC 60947-5-5 compliant).
- **Push Turn Lock:** Lens is maintained when turned clockwise in the depressed position and is reset when turned counterclockwise.

Dimensions

• AVLN3 BA9S/Full Voltage

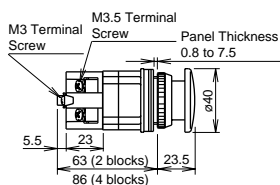

• AVLN3 BA9S/Transformer

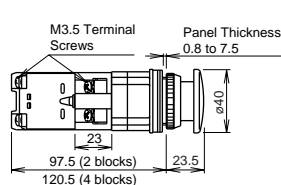

• AVLNE3 E12/Full Voltage

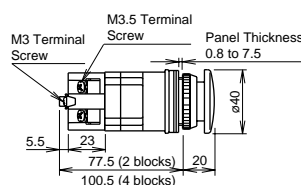

• AVLNE3 E12/Transformer

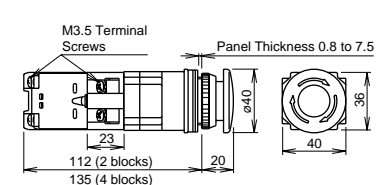

• AJLN3 BA9S/Full Voltage

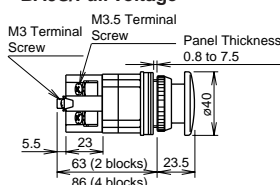



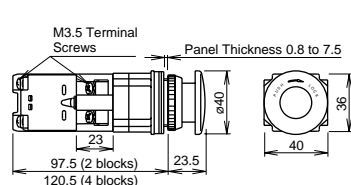

• AJLN3 BA9S/Transformer



All dimensions in mm.

ø30 ø30 Series Illuminated Pushbuttons

Incandescent Pushlock Turn Reset / Push Turn Lock Types

Shape	Lamp Receptacle	Operation Type	Lamp	Input Type	Contact	Type No.	Applicable Lamp
ø40 Mushroom Pushlock Turn Reset AVLN3 AVLNE3  	BA9S	Pushlock Turn Reset	Without Lamp	Full Voltage	1NO-1NC	AVLN39911NR	LS (1W)
					2NO	AVLN39920NR	
					2NC	AVLN39902NR	
			Incandescent	Transformer	1NO-1NC	AVLN3③11NR	LS-6
					2NO	AVLN3③20NR	
					2NC	AVLN3③02NR	
	E12	Pushlock Turn Reset	Without Lamp	Full Voltage	1NO-1NC	AVLNE39911NR	LE (2W)
					2NO	AVLNE39920NR	
					2NC	AVLNE39902NR	
			Incandescent	Transformer	1NO-1NC	AVLNE3③11NR	LE-8
					2NO	AVLNE3③20NR	
					2NC	AVLNE3③02NR	
ø40 Mushroom Push Turn Lock AJLN3  	BA9S	Push Turn Lock	Without Lamp	Full Voltage	1NO-1NC	AJLN39911N②	LS (1W)
					2NO	AJLN39920N②	
					2NC	AJLN39902N②	
			Incandescent	Transformer	1NO-1NC	AJLN3③11N②	LS-6
					2NO	AJLN3③20N②	
					2NC	AJLN3③02N②	

• Color Code and Operating Voltage Code

② Lens Color Code	③ Operating Voltage Code	
Incandescent Illuminated Type	Incandescent Transformer BA9S Type	Incandescent Transformer E12 Type
Specify a lens color code in place of ② in the Type No.	Specify an operating voltage code in place of ③ in the Type No.	
G: green O: orange R: red	16: 100/110V AC 116: 115V AC 126: 120V AC 26: 200/220V AC 236: 230V AC 246: 240V AC 386: 380V AC 46: 400/440V AC 486: 480V AC	18: 100/110V AC 118: 115V AC 128: 120V AC 28: 200/220V AC 238: 230V AC 248: 240V AC 388: 380V AC 48: 400/440V AC 488: 480V AC

- Full voltage types do not contain a lamp. Order incandescent lamps separately. For lamps, see page 63.
- Incandescent illuminated transformer types contain an incandescent lamp: LS-6 (1W, 6V AC/DC) or LE-8 (2W, 18V AC/DC).
- **Pushlock Turn Reset:** Lens is maintained when pressed and is reset when turned clockwise. Red lens only.
Note: AVLN3 and AVLNE3 pushlock turn reset switches cannot be used as emergency stop switches. When emergency stop switches are required, use the HN1E series emergency stop switches (ISO 13850 and IEC 60947-5-5 compliant).
- **Push Turn Lock:** Lens is maintained when turned clockwise in the depressed position and is reset when turned counterclockwise.

Dimensions

• AVLN3 BA9S/Full Voltage

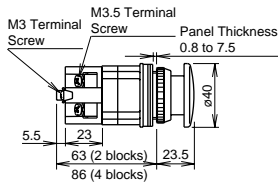

• AVLN3 BA9S/Transformer

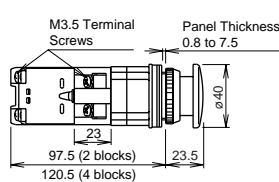

• AVLNE3 E12/Full Voltage

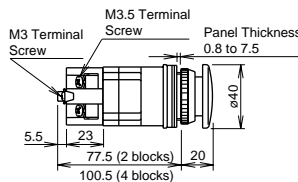

• AVLNE3 E12/Transformer

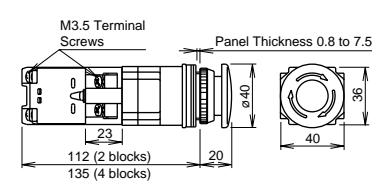

• AJLN3 BA9S/Full Voltage

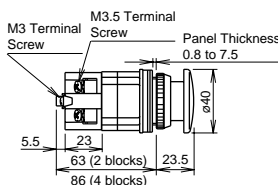



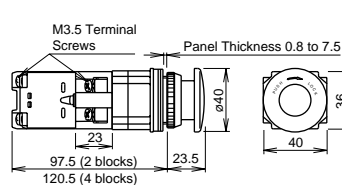





• AJLN3 BA9S/Transformer





All dimensions in mm.

ASN Selector Switches (Knob Operator Type)



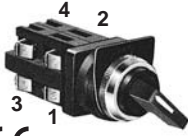

No. of Positions	Shape		Contact Arrangement Chart		ASN	 <ul style="list-style-type: none"> • Knob: Black • Round bezel (metal): Chrome-plated • Units marked with ★ differ in shape. See page 36 for dimensions. • Nameplates are ordered separately. 			
	Contact Code (ASN)	Contact Block	Operator Position		Maintained	Spring Return from Right	Maintained	Spring Return from Left	
90° 2-position	Mounting Position	Type	L	R					
			10 (1NO)	1 NO					•
	2 Dummy								
11 (1NO-1NC)	1 NO	•	•	ASN311	ASN411				
	2 NC	•							
20 (2NO)	1 NO	•	•	ASN320	ASN420				
	2 NO	•							
22 (2NO-2NC)	1 NO	•	•	ASN322	ASN422				
	2 NC	•							
	3 NO	•	•						
	4 NC	•							
7S (1NO-1NC)	1 NO	•	•	ASN37S	ASN47S				
	2 NC	•							
10 (1NO)	1 NO	•		—	—	ASN3010	ASN4010		
	2 Dummy								
11 (1NO-1NC)	1 NO	•				ASN3011	ASN4011		
	2 NC	•	•						
20 (2NO)	1 NO	•				ASN3020	ASN4020		
	2 NO	•							
22 (2NO-2NC)	1 NO	•	•			ASN3022	ASN4022		
	2 NC	•							
	3 NO	•	•						
	4 NC	•							
7S (1NO-1NC)	1 NO	•	•			ASN307S	ASN407S		
	2 NC	•							
45° 3-position	Mounting Position	Type	L	C	R				
			11 (1NO-1NC)	1 NO	•				
	2 NC			•					
22 (2NO-2NC)	1 NO	•		•	ASN122	ASN222			
	2 NC	•							
	3 NO	•		•					
	4 NC			•					
5S (2NO-2NC)	1 NO	•		•	ASN15S ★	ASN25S ★			
	2 NO	•							
	3 NC	•		•					
	4 NC	•		•					
7S (2NC)	1 NC	•		•	ASN17S ★	ASN27S ★			
	2 NC	•		•					
8S (4NC)	1 NC	•		•	ASN18S ★	ASN28S ★			
	2 NC	•		•					
	3 NC	•		•					
	4 NC	•		•					
11 (1NO-1NC)	1 NO	•		•	—	—	ASN1011	ASN2011	
	2 NC	•							
22 (2NO-2NC)	1 NO	•		•			ASN1022	ASN2022	
	2 NC	•							
	3 NO	•		•					
	4 NC	•							
5S (2NO-2NC)	1 NO	•		•			ASN105S ★	ASN205S ★	
	2 NC	•							
	3 NO	•		•					
	4 NC	•		•					
7S (2NC)	1 NC	•		•			ASN107S ★	ASN207S ★	
	2 NC	•		•					
8S (4NC)	1 NC	•		•	ASN108S ★	ASN208S ★			
	2 NC	•		•					
	3 NC	•		•					
	4 NC	•		•					

ø30 ø30 Series Selector Switches

ASN Selector Switches (Lever Operator Type)

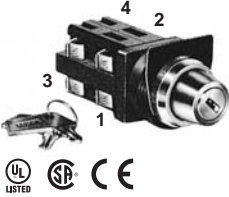
No. of Positions	Shape			ASN*L		<ul style="list-style-type: none"> • Lever: Black • Round bezel (metal): Chrome-plated • Units marked with ★ differ in shape. See page 36 for dimensions. • Nameplates are ordered separately. 						
	Contact Arrangement Chart											
90° 2-position	Contact Code (ASN)	Contact Block		Operator Position			Maintained	Spring Return from Right	Maintained	Spring Return from Left		
		Mounting Position	Type	L	R							
	10 (1NO)	1	NO		•		ASN3L10	ASN4L10	—	—		
		2	Dummy									
	11 (1NO-1NC)	1	NO		•		ASN3L11	ASN4L11				
		2	NC	•								
	20 (2NO)	1	NO		•		ASN3L20	ASN4L20				
		2	NO		•							
	22 (2NO-2NC)	1	NO		•		ASN3L22	ASN4L22				
		2	NC	•								
		3	NO		•							
		4	NC	•								
	7S (1NO-1NC)	1	NO		•		ASN3L7S	ASN4L7S				
		2	NC	•								
	10 (1NO)	1	NO	•			—	—			ASN30L10	ASN40L10
		2	Dummy									
	11 (1NO-1NC)	1	NO	•							ASN30L11	ASN40L11
		2	NC		•						ASN30L20	ASN40L20
20 (2NO)	1	NO	•			ASN30L22					ASN40L22	
	2	NO	•			ASN30L7S					ASN40L7S	
22 (2NO-2NC)	1	NO	•									
	2	NC		•								
7S (1NO-1NC)	1	NO	•									
	2	NC		•								
45° 3-position	Contact Code (ASN)	Contact Block		Operator Position					Maintained	Spring Return from Left	Maintained	Spring Return from Right
		Mounting Position	Type	L	C	R						
	11 (1NO-1NC)	1	NO	•					ASN1L11	ASN2L11	—	—
		2	NC			•						
	22 (2NO-2NC)	1	NO	•					ASN1L22	ASN2L22		
		2	NC			•						
		3	NO	•								
	5S (2NO-2NC)	1	NO	•					ASN1L5S ★	ASN2L5S ★		
		2	NO			•						
		3	NC			•						
		4	NC			•						
	7S (2NC)	1	NC			•	ASN1L7S ★	ASN2L7S ★				
		2	NC			•						
	8S (4NC)	1	NC			•	ASN1L8S ★	ASN2L8S ★				
		2	NC			•						
		3	NC			•						
		4	NC			•						
	11 (1NO-1NC)	1	NO	•			—	—	ASN10L11	ASN20L11		
2		NC			•	ASN10L22			ASN20L22			
22 (2NO-2NC)	1	NO	•			ASN10L5S ★			ASN20L5S ★			
	2	NC			•	ASN10L7S ★			ASN20L7S ★			
	3	NO	•			ASN10L8S ★			ASN20L8S ★			
5S (2NO-2NC)	1	NO	•									
	2	NC			•							
	3	NO	•									
	4	NC			•							
7S (2NC)	1	NC			•							
	2	NC			•							
8S (4NC)	1	NC			•							
	2	NC			•							
	3	NC			•							
	4	NC			•							

ASN Key Selector Switches

No. of Positions	Shape			ASN*K		<ul style="list-style-type: none"> • Cylinder: Chrome-plated • Round bezel (metal): Chrome-plated • On the spring-returned types, the keys can be released only from the maintained position. On the maintained types, the key can be released from every position. Key retained positions are also available. See page 12. • Key selector switch is supplied with two standard keys. Two different keys are available upon request. • Nameplates are ordered separately. 					
	Contact Arrangement Chart					Maintained	Spring Return from Right	Maintained	Spring Return from Left		
Contact Code (ASN)	Contact Block		Operator Position			Maintained	Spring Return from Right	Maintained	Spring Return from Left		
	Mounting Position	Type	L	R							
90° 2-position	10 (1NO)	1	NO		•	ASN3K10	ASN4K10	—	—		
		2	Dummy								
	11 (1NO-1NC)	1	NO		•	ASN3K11	ASN4K11				
		2	NC	•							
	20 (2NO)	1	NO		•	ASN3K20	ASN4K20				
		2	NO		•						
	22 (2NO-2NC)	1	NO		•	ASN3K22	ASN4K22				
		2	NC	•							
		3	NO		•						
	7S (1NO-1NC)	1	NO	■		ASN3K7S	ASN4K7S				
		2	NC	■							
		4	NC	■							
	10 (1NO)	1	NO	•		—	—			ASN30K10	ASN40K10
		2	Dummy								
	11 (1NO-1NC)	1	NO	•						ASN30K11	ASN40K11
		2	NC		•						
20 (2NO)	1	NO	•		ASN30K20			ASN40K20			
	2	NO		•							
22 (2NO-2NC)	1	NO	•		ASN30K22			ASN40K22			
	2	NC		•							
	3	NO	•								
7S (1NO-1NC)	1	NO	■		ASN30K7S			ASN40K7S			
	2	NC	■								
	4	NC	■								
45° 3-position	11 (1NO-1NC)	1	NO	•				ASN1K11	ASN2K11	—	—
		2	NC		•						
	22 (2NO-2NC)	1	NO	•				ASN1K22	ASN2K22		
		2	NC		•						
		3	NO	•							
	5S (1NO-1NC) (1NO-1NC)	1	NO	•		ASN1K5S	ASN2K5S				
		2	NC		•						
		3	NO	■							
		4	NC	■							
	7S (1NO-1NC)	1	NO	■		ASN1K7S	ASN2K7S				
		2	NC	■							
	8S (2NO-2NC)	1	NO	■		ASN1K8S	ASN2K8S				
		2	NC	■							
		3	NO	■							
		4	NC	■							
	11 (1NO-1NC)	1	NO	•		—	—	ASN10K11	ASN20K11		
2		NC		•							
22 (2NO-2NC)	1	NO	•		ASN10K22			ASN20K22			
	2	NC		•							
	3	NO	•								
5S (1NO-1NC) (1NO-1NC)	1	NO	•		ASN10K5S			ASN20K5S			
	2	NC		•							
	3	NO	■								
	4	NC	■								
7S (1NO-1NC)	1	NO	■		ASN10K7S			ASN20K7S			
	2	NC	■								
8S (2NO-2NC)	1	NO	■		ASN10K8S			ASN20K8S			
	2	NC	■								
	3	NO	■								
	4	NC	■								

ø30 ø30 Series Selector Switches

Dimensions

• Knob Operator Type

Dimensions of knob operator type marked with ★

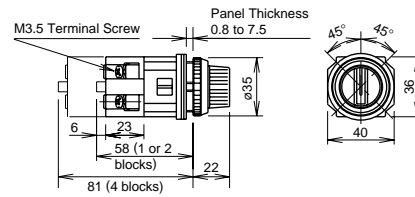
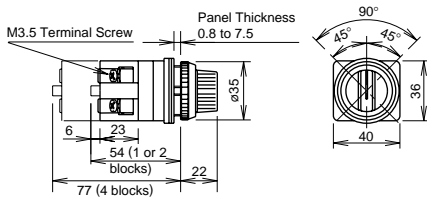

• Lever Operator Type

Dimensions of lever operator type marked with ★

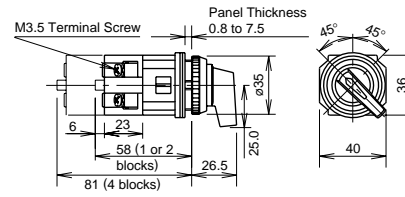
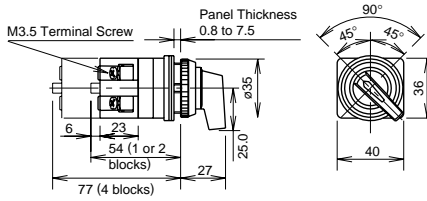

• Key Selector Type

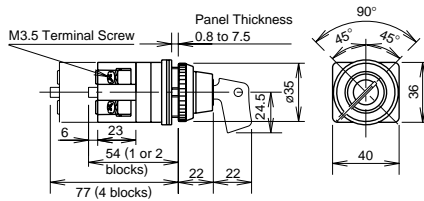





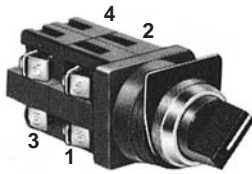



All dimensions in mm.

• Contact Block Mounting Position and Contact Arrangement Chart



		Left	Center	Right	
		L	C	R	← Operator Position
1	NO	●			
2	NO			●	
3	NC		■		
4	NC	■			

ASTN Selector Switches (Knob Operator Type)

No. of Positions	Shape		ASTN		<ul style="list-style-type: none"> • Knob operator: Black • Round bezel (metal): Chrome-plated 					
	Contact Arrangement Chart									
90° 2-position	Contact Code (ASTN)	Contact Block		Operator Position		Maintained	Spring Return from Right	—	—	
		Mounting Position	Type	L	R			—	—	
	11 (1NO-1NC)	1	NO		•	ASTN3211	ASTN4211	—	—	
		2	NC	•						
	22 (2NO-2NC)	1	NO		•	ASTN3222	ASTN4222	—	—	
		2	NO		•					
	3	NC	•							
	4	NC	•							
45° 3-position	Contact Code (ASTN)	Contact Block		Operator Position		Maintained	Spring Return from Left	Spring Return from Right	Spring Return Two-way	
		Mounting Position	Type	L	C	R				
	22 (2NO-2NC)	1	NO	•			ASTN1122	ASTN2122	ASTN20122	ASTN5122
		2	NO			•				
		3	NC			•				
		4	NC			•				
	22 (2NO-2NC)	1	NO	•			ASTN1222	ASTN2222	ASTN20222	ASTN5222
		2	NO			•				
		3	NC			•				
		4	NC			•				
	40 (4NC)	1	NO	•			ASTN1340	—	—	—
		2	NO			•				
		3	NO	•						
		4	NO			•				
	22 (2NO-2NC)	1	NO	•			ASTN1422	—	ASTN20422	—
		2	NC			•				
		3	NC			•				
		4	NO			•				
	20 (2NO)	1	NO			•	ASTN1520	—	ASTN20520	—
		2	NO	•						
	40 (4NO)	1	NO			•	ASTN1540	—	ASTN20540	—
		2	NO	•						
		3	NO			•				
		4	NO	•						
	11 (1NO-1NC)	1	NC			•	ASTN1611	—	—	—
		2	NO			•				
	22 (2NO-2NC)	1	NC			•	ASTN1622	—	—	—
		2	NO			•				
3		NC			•					
4		NO			•					
11 (1NO-1NC)	1	NO	•			—	—	—	ASTN5111	
	2	NC			•					

Notes:

1. The operator of the 2-way spring return unit may slightly deviate from the center position.
2. Turn the operator to each position accurately.

• Contact Block Mounting Position and Contact Arrangement Chart







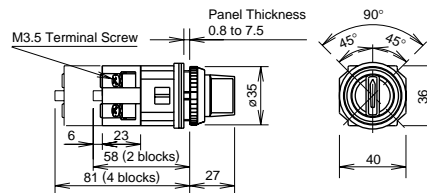





		Left	Center	Right	Operator Position
		L	C	R	
1	NO	•			
2	NO			•	
3	NC			•	
4	NC	•			

• Dimensions



ø30 ø30 Series Selector Switches

ASTN Selector Switches (Lever Operator Type)

No. of Positions	Shape		ASTN*L		<ul style="list-style-type: none"> Lever operator: Black Round bezel (metal): Chrome-plated 					
	Contact Arrangement Chart				  					
90° 2-position	Contact Code (ASTN)	Contact Block		Operator Position		Maintained	Spring Return from Right	—	—	
		Mounting Position	Type	L	R			—	—	
	11 (1NO-1NC)	1	NO		●	ASTN32L11	ASTN42L11	—	—	
		2	NC	●						
	22 (2NO-2NC)	1	NO		●	ASTN32L22	ASTN42L22	—	—	
		2	NO		●					
3		NC	●							
4		NC	●							
45° 3-position	Contact Code (ASTN)	Contact Block		Operator Position			Maintained	Spring Return from Left	Spring Return from Right	Spring Return Two-way
		Mounting Position	Type	L	C	R				
	22 (2NO-2NC)	1	NO	●			ASTN11L22	ASTN21L22	ASTN201L22	ASTN51L22
		2	NO			●				
		3	NC			●				
		4	NC			●				
	22 (2NO-2NC)	1	NO	●			ASTN12L22	ASTN22L22	ASTN202L22	ASTN52L22
		2	NO			●				
		3	NC			●				
		4	NC			●				
	40 (4NC)	1	NO	●			ASTN13L40	—	—	—
		2	NO			●				
		3	NO	●						
		4	NO			●				
	22 (2NO-2NC)	1	NO	●			ASTN14L22	—	ASTN204L22	—
		2	NC			●				
		3	NC			●				
		4	NO			●				
	20 (2NO)	1	NO			●	ASTN15L20	—	ASTN205L20	—
		2	NO	●						
	40 (4NO)	1	NO	●			ASTN15L40	—	ASTN205L40	—
		2	NO			●				
		3	NO	●						
		4	NO			●				
	11 (1NO-1NC)	1	NC		●		ASTN16L11	—	—	—
		2	NO			●				
	22 (2NO-2NC)	1	NC		●		ASTN16L22	—	—	—
		2	NO			●				
3		NC		●						
4		NO			●					
11 (1NO-1NC)	1	NO	●			—	—	—	ASTN51L11	
	2	NC			●					

Notes:

1. The operator of the 2-way spring return unit may slightly deviate from the center position.
2. Turn the operator to each position accurately.

• Contact Block Mounting Position and Contact Arrangement Chart







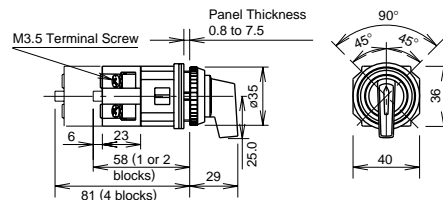













































		Left	Center	Right	
		L	C	R	Operator Position
1	NO	●			
2	NO			●	
3	NC			●	
4	NC			●	

• Dimensions



ASTN Key Selector Switches

No. of Positions	Shape			ASTN*K		<ul style="list-style-type: none"> • Cylinder: Chrome-plated • Round bezel (metal): Chrome-plated • On the spring-returned types, the keys can be released only from the maintained position. • On the maintained types, the key can be released from every position. Key retained positions are also available. See page 12. 					
	Contact Arrangement Chart					   					
90° 2-position	Contact Code (ASTN)	Contact Block		Operator Position		Maintained	Spring Return from Right	—	—		
		Mounting Position	Type	L	R			—	—		
	11 (1NO-1NC)	1	NO		●	ASTN32K11			—	—	
		2	NC	●							
	22 (2NO-2NC)	1	NO		●	ASTN32K22			—	—	
		2	NO		●						
3		NC	●								
45° 3-position	Contact Code (ASTN)	Contact Block			Operator Position			Maintained	Spring Return from Left	Spring Return from Right	Spring Return Two-way
		Mounting Position	Type	L	C	R					
	22 (2NO-2NC)	1	NO	●			ASTN11K22				
		2	NO			●					
3		NC		■							
4		NC	■								
22 (2NO-2NC)	1	NO	●			ASTN12K22					
	2	NO			●						
	3	NC		●							
	4	NC	■								
40 (4NC)	1	NO	●			ASTN13K40					
	2	NO			●						
	3	NO	●								
	4	NO			●						
22 (2NO-2NC)	1	NO	●			ASTN14K22					
	2	NC	■								
	3	NC		■							
	4	NO			●						
20 (2NO)	1	NO			●	ASTN15K20					
	2	NO	●								
40 (4NO)	1	NO	●			ASTN15K40					
	2	NO			●						
	3	NO	●								
	4	NO	●								
11 (1NO-1NC)	1	NC		●		ASTN16K11					
	2	NO			●						
22 (2NO-2NC)	1	NC		●		ASTN16K22					
	2	NO			●						
	3	NC		●							
	4	NO			●						
11 (1NO-1NC)	1	NO	●			—					
	2	NC	■								

Notes:

1. The operator of the 2-way spring return unit may slightly deviate from the center position.
2. Turn the operator to each position accurately.

• Contact Block Mounting Position and Contact Arrangement Chart



	Left	Center	Right	Operator Position
1	NO	●		←
2	NO		●	
3	NC		■	
4	NC	■		



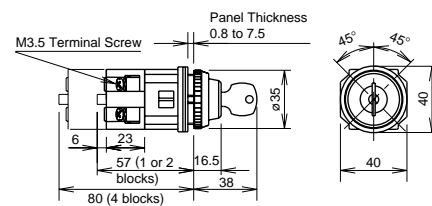

• Dimensions



ø30 ø30 Series Illuminated Selector Switches

Illuminated Selector Switches

90° 2-position

Shape		ASLN (Base BA9S)							
Contact Arrangement Chart		   							
Contact Code	Contact Block		Operator Position		Lamp	Input Type	Maintained L R	Spring Return from Right L R	Spring Return from Left L R
	Mounting Position	Type	L	R					
11 (1NO-1NC)	1	NO		●	Without Lamp	Full Voltage	ASLN29911N②	ASLN219911N②	ASLN229911N② *
	2	NC	●		LED	Transformer	ASLN2③11DN②	ASLN21③11DN②	ASLN22③11DN② *
					Incandescent	Transformer	ASLN2③11N②	ASLN21③11N②	ASLN22③11N② *
20 (2NO)	1	NO		●	Without Lamp	Full Voltage	ASLN29920N②	ASLN219920N②	ASLN229920N② *
	2	NO		●	LED	Transformer	ASLN2③20DN②	ASLN21③20DN②	ASLN22③20DN② *
					Incandescent	Transformer	ASLN2③20N②	ASLN21③20N②	ASLN22③20N② *
22 (2NO-2NC)	1	NO		●	Without Lamp	Full Voltage	ASLN29922N②	ASLN219922N②	ASLN229922N② *
	2	NC	●						
	3	NO		●	LED	Transformer	ASLN2③22DN②	ASLN21③22DN②	ASLN22③22DN② *
	4	NC	●						
				Incandescent	Transformer	ASLN2③22N②	ASLN21③22N②	ASLN22③22N② *	

• Color Code and Operating Voltage Code

LED Illuminated Type	Incandescent Illuminated Type	③ Operating Voltage Code
② Lens/LED Color Code	② Lens Color Code	
Specify a lens/LED color code in place of ② in the Type No. A: amber G: green R: red S: blue W: white Y: yellow	Specify a lens color code in place of ② in the Type No. A: amber G: green R: red S: blue W: white	Specify an operating voltage code in place of ③ in the Type No. 16: 100/110V AC 156: 115V AC 136: 120V AC 26: 200/220V AC 236: 230V AC 256: 240V AC 386: 380V AC 46: 400/440V AC 486: 480V AC (incandescent only)

- Full voltage types do not contain a lamp. Order LED or incandescent lamps separately. For lamps, see page 63.
- LED illuminated transformer type contains an LED lamp (LSTD-6②, rated voltage 6V AC/DC).
- Incandescent illuminated transformer types contain an incandescent lamp (LS-6, rated voltage 6V AC/DC).
- On the 2-position selector switches marked with * above, the contact operation is reversed as follows.

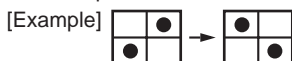

• Contact Block Mounting Position and Contact Arrangement Chart

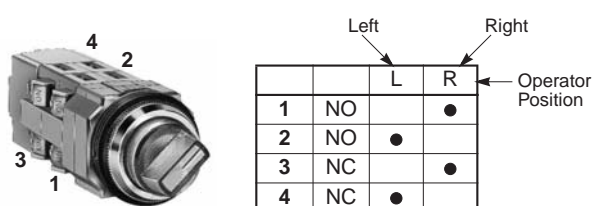

• Dimensions

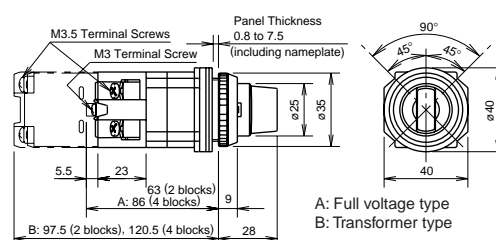

Illuminated Selector Switches

45° 3-position

Contact Code	Contact Block		Operator Position			Lamp Input Type	Maintained	Spring Return from Right	Spring Return from left	Spring Return Two-way
	Mounting Position	Type	L	C	R					
20 (2NO)	1	NO	●			Without Lamp Full Voltage	ASLN339920N②	ASLN319920N②	ASLN329920N②	ASLN339920N②
	2	NO			●	LED Transformer	ASLN3③20DN②	ASLN31③20DN②	ASLN32③20DN②	ASLN33③20DN②
						Incandescent Transformer	ASLN3③20N②	ASLN31③20N②	ASLN32③20N②	ASLN33③20N②
02 (2NC)	1	NC		■		Without Lamp Full Voltage	ASLN339902N②	ASLN319902N②	ASLN329902N②	ASLN339902N②
	2	NC	■			LED Transformer	ASLN3③02DN②	ASLN31③02DN②	ASLN32③02DN②	ASLN33③02DN②
						Incandescent Transformer	ASLN3③02N②	ASLN31③02N②	ASLN32③02N②	ASLN33③02N②
22 (2NO-2NC)	1	NO	●			Without Lamp Full Voltage	ASLN339922N②	ASLN319922N②	ASLN329922N②	ASLN339922N②
	2	NO			●	Without Lamp Full Voltage	ASLN339922N②	ASLN319922N②	ASLN329922N②	ASLN339922N②
	3	NC		■		LED Transformer	ASLN3③22DN②	ASLN31③22DN②	ASLN32③22DN②	ASLN33③22DN②
	4	NC	■			LED Transformer	ASLN3③22DN②	ASLN31③22DN②	ASLN32③22DN②	ASLN33③22DN②
					Incandescent Transformer	ASLN3③22N②	ASLN31③22N②	ASLN32③22N②	ASLN33③22N②	
40 (4NO)	1	NO	●			Without Lamp Full Voltage	ASLN339940N②	ASLN319940N②	ASLN329940N②	ASLN339940N②
	2	NO			●	Without Lamp Full Voltage	ASLN339940N②	ASLN319940N②	ASLN329940N②	ASLN339940N②
	3	NO	●			LED Transformer	ASLN3③40DN②	ASLN31③40DN②	ASLN32③40DN②	ASLN33③40DN②
	4	NO			●	LED Transformer	ASLN3③40DN②	ASLN31③40DN②	ASLN32③40DN②	ASLN33③40DN②
					Incandescent Transformer	ASLN3③40N②	ASLN31③40N②	ASLN32③40N②	ASLN33③40N②	
04 (4NC)	1	NC		■		Without Lamp Full Voltage	ASLN339904N②	ASLN319904N②	ASLN329904N②	ASLN339904N②
	2	NC	■			Without Lamp Full Voltage	ASLN339904N②	ASLN319904N②	ASLN329904N②	ASLN339904N②
	3	NC		■		LED Transformer	ASLN3③04DN②	ASLN31③04DN②	ASLN32③04DN②	ASLN33③04DN②
	4	NC	■			LED Transformer	ASLN3③04DN②	ASLN31③04DN②	ASLN32③04DN②	ASLN33③04DN②
					Incandescent Transformer	ASLN3③04N②	ASLN31③04N②	ASLN32③04N②	ASLN33③04N②	

• Color Code and Operating Voltage Code

LED Illuminated Type	Incandescent Illuminated Type	③ Operating Voltage Code
② Lens/LED Color Code	② Lens Color Code	
Specify a lens/LED color code in place of ② in the Type No. A: amber G: green R: red S: blue W: white Y: yellow	Specify a lens color code in place of ② in the Type No. A: amber G: green R: red S: blue W: white	Specify an operating voltage code in place of ③ in the Type No. 16: 100/110V AC 156: 115V AC 136: 120V AC 26: 200/220V AC 236: 230V AC 256: 240V AC 386: 380V AC 46: 400/440V AC 486: 480V AC (incandescent only)

- Full voltage types do not contain a lamp. Order LED or incandescent lamps separately. For lamps, see page 63.
- LED illuminated transformer types contain an LED lamp (LSTD-6②, rated voltage 6V AC/DC).
- Incandescent illuminated transformer types contain an incandescent lamp (LS-6, rated voltage 6V AC/DC).

• Contact Block Mounting Position and Contact Arrangement Chart

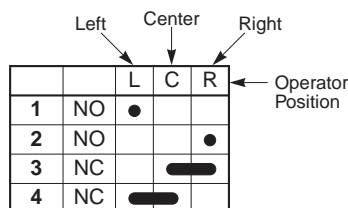

• Dimensions

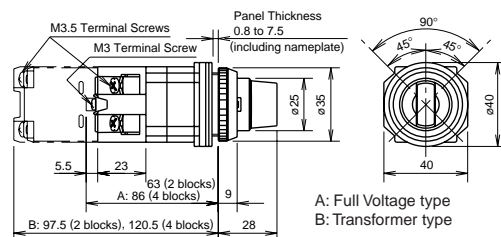

ø30 ø30 Series Selector Pushbuttons

Ring Operator Type / Lever Operator Type Selector Pushbuttons

Shape	Contact Code	Circuit Code	Contact Block		Ring/Lever				Ring Operator Type No.	Lever Operator Type No.	① Button Color Code	
					Pushbutton							
					Mounting Position	Type	Normal	Push				Normal
<p>ABN Ring Operator (90° 2-position)</p> <p>ABN*L Lever Operator (90° 2-position)</p>	11 (1NO-1NC)	A	1	NO		●		●	ABN6111①	ABN6L111①	B: black G: green R: red Y: yellow	
			2	NC	●					ABN6411①		ABN6L411①
		I	1	NC	●			■		ABN9111①		ABN9L111①
			2	NO		●	■					
		G	1	NO		Blocked			●			
			2	NC	●		●					
	20 (2NO)	D	1	NO		●			ABN7120①			
			2	NO				●				
	22 (2NO-2NC)	B	1	NC	●				ABN6122①	ABN6L122①		
				NC	●							
			3	NO		●		●				
				NO		●		●				
		C	1	NC	●				ABN6222①	ABN6L222①		
				NC	■							
			3	NO		●		●				
				NO				●				
I		1	NC	●				ABN6422①	ABN6L422①			
			NC	●								
		3	NO		●	■						
			NO		●	■						
D	1	NC	●			■	ABN7122①	ABN7L122①				
		NC	■		●							
	3	NO		●								
		NO				●						
E	1	NC				■	ABN7222①	ABN7L222①				
		NC	■									
	3	NO		●								
		NO				●						
F	1	NC				●	ABN7322①	ABN7L322①				
		NC	●									
	3	NO		●								
		NO				●						
H	1	NC	●			●	ABN9122①	ABN9L122①				
		NC	●	Blocked		●						
	3	NO							●			
		NO							●			

• Specify a button color code in place of ① in the Type No.

• Ring/Lever (metal): Chrome-plated

Notes

1. Circuit Codes A, B, C, and I: When the ring or lever operator is turned, the button is pushed in.
2. Circuit Codes E and F: The right and left NC contact blocks on circuit code E or F may overlap each other while turning the ring or lever operator. The NO and NC contact blocks on circuit code F may overlap each other while pressing the button.
3. Circuit Codes G and H: The pushbutton does not operate when the ring or lever operator is turned to the left position.
4. When using the selector pushbutton, do not turn the ring or lever operator with the pushbutton depressed. Otherwise, damage or failure may be caused.

• Contact Block Mounting Position and Contact Arrangement Chart

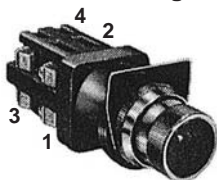

	Normal	Push
1	●	
2	●	
3		●
4		●

• Mounting Hole Layout

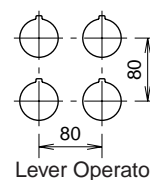
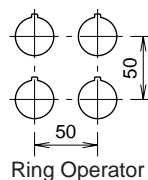

ø30 ARN/ARNS series Mono-lever Switches

Single lever offers up to four directions of control

Mono-lever switches operate in four directions using a single lever. Switch contacts are actuated in the direction in which the lever is pushed, enabling quick and accurate control in any desired direction. Ideal for machine tools and industrial machines. The lever action can be maintained or spring-returned in any combination.

Also available with interlock mechanism to prevent inadvertent actuation.



Specifications and Ratings

Contact Ratings

Contact Block	Type BR
Rated Insulation Voltage	600V
Rated Continuous Current	10A
Contact Ratings by Utilization Category IEC 60947-5-1	AC-15 (A600) DC-13 (P600)

Characteristics

• Contact Ratings by Utilization Category

Operational Voltage			24V	48V	50V	110V	220V	440V
Operational Current	AC 50/60 Hz	AC-12 Control of resistive loads and solid state loads	10A	—	10A	10A	6A	2A
		AC-15 Control of electromagnetic loads (> 72 VA)	10A	—	7A	5A	3A	1A
	DC	DC-12 Control of resistive loads and solid state loads	10A	5A	—	2.2A	1.1A	—
		DC-13 Control of electromagnets	4A	2A	—	1.1A	0.6A	—

Note: The operational current represents the classification by making and breaking currents (IEC 60947-5-1).

Specifications

Contact Arrangement	Double-break slow action Each contact block contains two independent contacts (2NO, 1NO-1NC, or 2NC) Up to four contact blocks can be mounted
Insulation Resistance	100 MΩ minimum (500V DC megger)
Dielectric Strength	Between live and dead parts: 2,500V AC, 1 minute
Mechanical Life	500,000 operations minimum
Electrical Life	(Interlocking type: 250,000 operations minimum)
Operating Temperature	-25 to +50°C (no freezing)
Operating Humidity	45 to 85% RH (no condensation)
Lever Knob	Black

BR Contact Block

The contact block is made of nylon resin. Each contact block contains two pairs of double-break silver contacts. There are three types as shown in the diagram below and up to four contact blocks can be mounted in any direction. A wide variety of circuits allows diverse combinations of control.

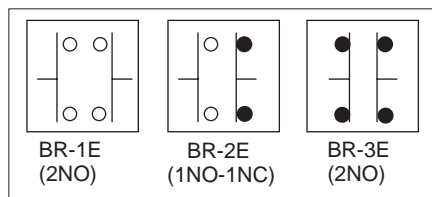





Control Mechanism

When the operator lever is pushed to about 30° in each direction from the neutral position, the contact in that direction activates. The lever can operate in two, three, or four directions, and combinations of maintained or spring-return from any position are possible.

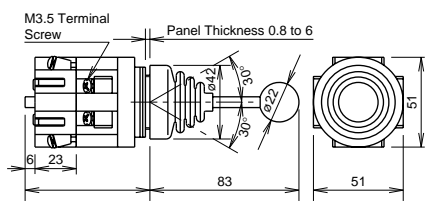
ø30 ARN/ARNS Series Mono-lever Switches

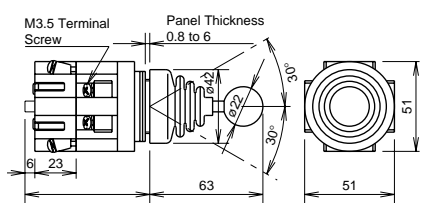
Types

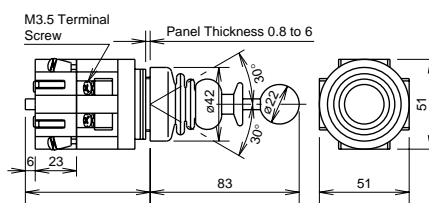
Operator Type	Position	Lever Action	Type No.	Dimensions (mm)
 ARN (Long Lever Type)	2-position (Up-Down)	Maintained	ARN2-1010-④B	 M3.5 Terminal Screw, Panel Thickness 0.8 to 6 1 block: 47, 2 blocks: 70 3 blocks: 93, 4 blocks: 116 Minimum horizontal/vertical mounting centers: 110
		Spring return	ARN2-2020-④B	
	2-position (Left-Right)	Maintained	ARN2-0101-④B	
		Spring return	ARN2-0202-④B	
	4-position (Up-Down-Left-Right)	Maintained	ARN4-1111-④B	
		Spring return	ARN4-2222-④B	
 ARNS (Short Lever Type)	2-position (Up-Down)	Maintained	ARNS2-1010-④B	 M3.5 Terminal Screw, Panel Thickness 0.8 to 6 1 block: 47, 2 blocks: 70 3 blocks: 93, 4 blocks: 116 Minimum horizontal/vertical mounting centers: 70
		Spring return	ARNS2-2020-④B	
	2-position (Left-Right)	Maintained	ARNS2-0101-④B	
		Spring return	ARNS2-0202-④B	
	4-position (Up-Down-Left-Right)	Maintained	ARNS4-1111-④B	
		Spring return	ARNS4-2222-④B	
 ARNL (Interlocking Type) The operator lever is locked only in the center position.	2-position (Up-Down)	Maintained	ARNL2-1010-④B	 M3.5 Terminal Screw, Panel Thickness 0.8 to 6 1 block: 47, 2 blocks: 70 3 blocks: 93, 4 blocks: 116 Minimum horizontal/vertical mounting centers: 110
		Spring return	ARNL2-2020-④B	
	2-position (Left-Right)	Maintained	ARNL2-0101-④B	
		Spring return	ARNL2-0202-④B	
	4-position (Up-Down-Left-Right)	Maintained	ARNL4-1111-④B	
		Spring return	ARNL4-2222-④B	

- Specify Contact Arrangement from the table below in place of ④.
- Terminal covers are ordered separately.

• Lever Operator Position

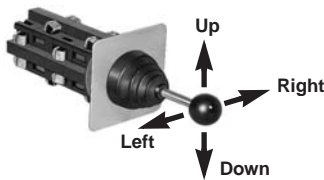

• Panel Cut-Out

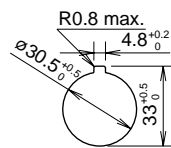

• Mono-Lever with Terminal Cover

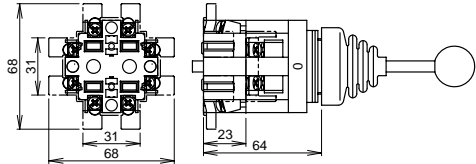

Ordering Information

When ordering, specify items ① to ⑤ according to the following example.

[Example] **ARN** **4** - **1012** - **20 00 02 11** - **B**
Up Right Down Left

① Type	② No. of Contact Blocks	③ Lever Action	④ Contact Arrangement	⑤ Lever Knob Color
ARN ARNS ARNL	1: 1 block 2: 2 blocks 3: 3 blocks 4: 4 blocks	Order of Entry: Up→Right→ Down→Left 1: Maintained 2: Spring return 0: Blocked	Order of Entry: Up→Right→ Down→Left 10: 1NO 01: 1NC 11: 1NO-1NC 20: 2NO 02: 2NC 00: Blocked	B: black

Contact Block Position	Terminal No.	Direction of Lever Operation				Terminal No.	Contact Block Type
		Lever Operation Mode					
		1	0	1	2		
1	1	NO	-	-	-	2	BR-2E
	3	-	-	NC	-	4	
2	5	-	NO *	-	-	6	BR-1E
	7	-	-	-	NO	8	
3	9	NO	-	-	-	10	BR-2E
	11	-	-	NC	-	12	
4	13	-	NC *	-	-	14	BR-3E
	15	-	-	-	NC	16	

*: Contacts marked with * do not operate.







- To calculate the number of contact blocks required, add the number of NO and NC contacts on each pair of adjoining positions (up + right, right + down, down + left, and left + up). The largest of the four sums is the number of contact blocks required. Up to four contact blocks can be mounted.

- When UL and CSA markings are required on the mono-lever switch, specify as shown below.

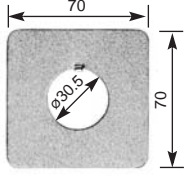
[Example] ARN4-1012-20000211-B-**U**

ARN/ARNS Series Mono-lever Switches ø30

Accessories and Maintenance Parts

Shape	Specification	Type No.	Ordering Type No.	Package Quantity	Description
Nameplate		MLO	MLO	1	Chrome-plated brass (matte surface)
			MLOPN10	10	
Terminal Cover		ARN-VL2	ARN-VL2	1	<ul style="list-style-type: none"> Terminal covers are ordered separately. When ordering, specify the Type No. and the required quantity. Order 2 pieces for each contact block.
Contact Block (BR Type)		BR-1E	BR-1E	1	• 2NO contact
		BR-2E	BR-2E	1	• 1NO-1NC contact
		BR-3E	BR-3E	1	• 2NC contact
Bellows		ARN-BL	ARN-BL	1	• For ARN/ARNS (Locking ring not included)
Bellows (Interlocking Type)		ARNL-BL	ARNL-BL	1	• For ARNL (Locking ring not included)
Knob		ARNB-①	ARNB-①	1	Specify a color code in place of ①. B (black), G (green), R (red) • For ARN/ARNS

ø30/ø25 CS Series Cam Switches

76 standard circuits to choose from

- Wide variety of heavy-duty oiltight cam switches
- Operators available up to 12 positions
- Switches made with a double-pole contact block
- Contact blocks rated at 600V, 10A
- Ideal for ammeter/voltmeter applications
- UL listed and CSA approved



Specifications and Ratings

Contact Ratings

Rated Insulation Voltage	600V
Rated Continuous Current	10A
Contact Ratings by Utilization Category IEC 60947-5-1	AC-15 (A600) DC-13 (P600)

Characteristics

• Contact Ratings by Utilization Category

Operational Voltage		24V	110V	220V	440V	
Operational Current	AC 50/60 Hz	AC-12 Control of resistive loads and solid state loads	—	10A	6A	2A
		AC-15 Control of electromagnetic loads (> 72 VA)	—	5A	3A	1A
	DC	DC-12 Control of resistive loads and solid state loads	8A	3A	1A	0.4A
		DC-13 Control of electromagnets	5A	1.2A	0.45A	0.2A

Note: The operational current represents the classification by making and breaking currents (IEC 60947-5-1).

Specifications

Contact Arrangement	Double-break slow action contacts Two contacts in one deck Up to 6 decks available (Spring-return type: Up to 3 decks)	
Operation	Maintained	Spring return
Angle	30°, 45°, 60°, 90°	45°
Operator Positions	2 to 12	2, 3, 4
Insulation Resistance	100 MΩ (500V DC megger)	
Dielectric Strength	2500V AC, 1 minute (between live and dead parts)	
Mechanical Life	1 to 3 decks: 500,000 operations 4 to 6 decks: 200,000 operations	
Electrical Life	500,000 operations minimum	
Operating Temperature	-20 to +50°C (no freezing)	





CBS Contact Block

The CBS contact block contains two poles of double-break contacts. The contacts are operated by a cam designed to perform a required contact operation. Up to six contact blocks can be mounted on a maintained-action operator base, and up to three contact blocks on a spring return operator base.

M3.5 Screw Terminal

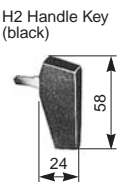

Types

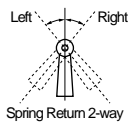
① Type		② Contact Block Decks	③ Positions	④ Angle	⑤ Spring Return	⑥ Handle	⑦ Contact Arrangement	Name-plate
ø30 Series	ø25 Series							
ACSNO	ACSSO	Maintained: 1 to 6 decks Spring return: 1 to 3 decks	Maintained: 2 to 12 positions Spring return: 2 to 4 positions	Maintained: 30°, 45°, 60°, 90° Spring return: 45° only	Spring return from right Spring return from left Spring return two-way	Y2, S2, P2, F2, 25S2 (25S2 is for ACSSO only) (one specified handle supplied)		See page 56. (ordered separately)
 (Photo: ACSNO with Y2 handle)								
ACS NK	ACSSK	Maintained: 1 to 6 decks Spring return: 1 to 3 decks	Maintained: 2 to 8 positions Spring return: 2 to 4 positions	Maintained: 45°, 90° Spring return: 45° only	Spring return from right Spring return from left Spring return two-way	Two standard keys are supplied. When the H2 key handle is required, specify H2.	See page 51.	
 Standard Key (2 keys supplied)								
 H2 Handle Key (black)								
UCSQO	(Enclosed Type)	Maintained: 1 to 6 decks Spring return: 1 to 3 decks	Maintained: 2 to 12 positions Spring return: 2 to 4 positions	Maintained: 30°, 45°, 60°, 90° Spring return: 45° only	Spring return from right Spring return from left Spring return two-way	Y2, S2, F2, P2 (one specified handle supplied)		Type CQ See page 56.
 (Photo: With Y2 handle)								
UCSQM	(Enclosed Type)	Spring return: 1 to 3 decks	Spring return: 3 positions	Spring return: 45° only	Spring return two-way		C1007 C1008 C1009 C1010 C1018 C2006 C2007 C2021 See page 51.	Type CQM See page 56.
 Indicator Left: Green Right: Red								
 Left Right Spring Return 2-way								

• For handles and accessories, see page 49.

Dimensions

ACSNO/ACSSO

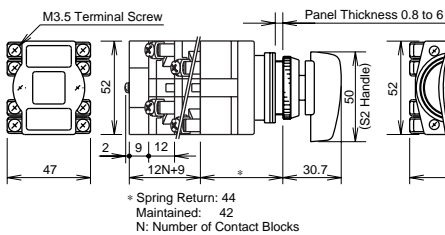

ACS NK/ACSSK

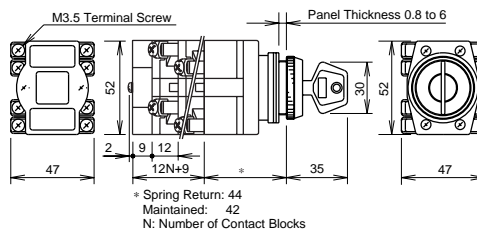

• Panel Cut-out

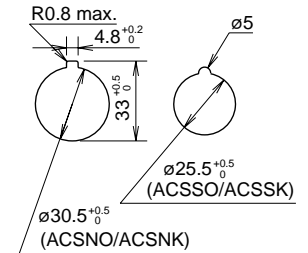

• Minimum horizontal/vertical mounting centers
 With P2 handle: 125
 With other handles: 70

UCSQO

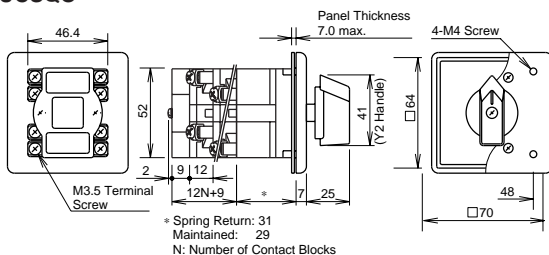

UCSQM

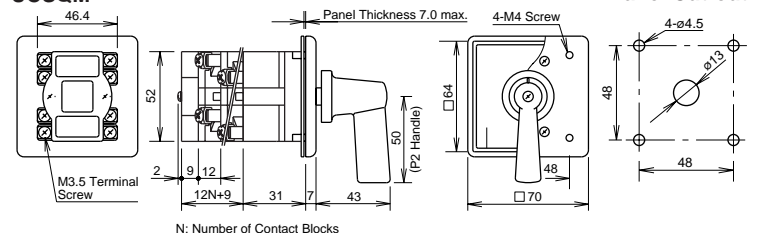

• Panel Cut-out

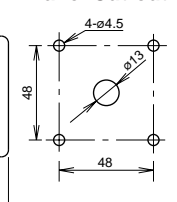

• Minimum horizontal/vertical mounting centers
 With P2 handle: 125
 With other handles: 70

All dimensions in mm.

ø30/ø25 CS Series Cam Switches

Ordering Information

When ordering, specify items ① through ⑦ as the designation example below.

①	②		③		④		⑤		⑥	⑦
Type	Contact Block Decks	Positions	Code	Angle	Code	Return	Code	Handle	Circuit No.	
ACSNO	1 deck	1	2 positions	2	30°	3	Spring return from left	RO	(Code) Y2, S2, P2, F2, H2, 25S2 (Color) B: Black See table below.	For standard contact arrangements, use designation code on pages 51 to 53. For custom contact arrangements, use the Custom Contact Arrangement Specification Sheet on page 54.
ACSNO	2 decks	2	3 positions	3	45°	4	Spring return from right	OR		
ACSSO	3 decks	3	4 positions	4	60°	6	Spring return two-way	RR		
ACSSK	4 decks	4	5 positions	5	90°	9				
UCSQO	5 decks	5	6 positions	6						
UCSQM	6 decks	6	7 positions	7						
			8 positions	8						
			9 positions	9						
			10 positions	10						
			11 positions	11						
			12 positions	12						
	Spring return: 1 to 3 decks only		Spring return: 2 to 4 positions only		ACSNO/ACSSK: 45° and 90° only Spring return: 45° only		Spring return code is required only for spring return types.		25S2 is for ACSSO only.	

• Designation Example

UCSQO - 2 3 4 RR - S2B - C2006

- When a special contact arrangement is required, specify the contact arrangement using the Custom Contact Arrangement Specification Sheet on page 54.
- A specified handle is attached.
- Accessories such as nameplates and jumpers are separately ordered.
- The key of the key operated cam switch is removable from every position. Specify other key removable configurations if required.

• Handle Designation Code

Shape	Code	Color	Applicable Cam Switch
	Y2	B: black	ACSNO UCSQO UCSQM
	S2		
	25S2		
	P2		ACSNO UCSQO UCSQM
	F2		
	H2		ACSNO UCSQO UCSQM



• Spring Return Operation



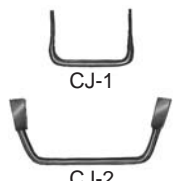

Available combinations of operator positions, angles, and return directions are listed in the table below.

Positions	2-position		3-position			4-position		3-position
	From Left	From Right	From Left	From Right	Two-way	From Left	From Right	Two-way
Return Direction								
③ ④ ⑤ Codes	24RO	24OR	34RO	34OR	34RR	44RO	44OR	34RR
Applicable Cam Switches	ACSNO, ACSSO, ACSNK, ACSSK, UCSQO							UCSQM
Contact Block Decks	1 to 3 decks							

Note: Maintained types do not require spring return code ⑤.

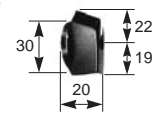
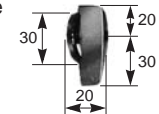
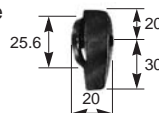
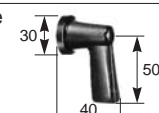
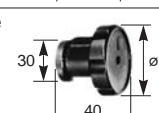
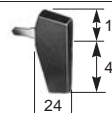
Accessories and Replacement Parts

Shape	Material	Type No.	Ordering Type No.	Package Quantity	Remarks
 <p>CJ-1 CJ-2</p>	Metal	CJ-1	CJ-1PN10	10	For connecting terminals of adjoining contact blocks
		CJ-2	CJ-2PN10	10	For connecting terminals of the same contact block
	Rubber	CR-1	CR-1	1	For preventing ingress of dust into the contact blocks Not applicable for the UCSQO and UCSQM
 <p>CS-VL2-13S CS-VL2-46S</p>	Plastic	CS-VL2-13S	CS-VL2-13S	1	For 1 to 3 decks of contact blocks
		CS-VL2-46S	CS-VL2-46S	1	For 4 to 6 decks of contact blocks

Shape	Material (Color)	Type No.	Ordering Type No.	Package Quantity
 <p>ø30 Y Handle</p>	Plastic (Black)	CSH-YB	CSH-YB	1
 <p>ø30 S Handle</p>	Plastic (Black)	CSH-SB	CSH-SB	1
 <p>ø25 S Handle</p>	Plastic (Black)	CSH-25SB	CSH-25SB	1
 <p>ø30 P Handle</p>	Plastic (Black)	CSH-PB	CSH-PB	1
 <p>ø30 F Handle</p>	Plastic (Black)	CSH-FB	CSH-FB	1
 <p>Key Handle</p>	Plastic (Black)	CSH-H2B	CSH-H2B	1
 <p>Handle Shaft</p>	Plastic	CS-HF2C	CS-HF2CPN05	5
 <p>Handle Screw</p>	For Y, ø30 S, and ø25 S handles M3 × 12	CS-SCW-M3-12	CS-SCW-M3-12PN10	10
 <p>Handle Screw</p>	For P and F handles M3 × 25	CS-SCW-M3-25	CS-SCW-M3-25PN10	10

ø30/ø25 CS Series Cam Switches

Installing the Terminal Cover for the CS series Cam Switches

- Complete wiring before installing the terminal cover on the bottom plate of the contact block.
- The terminal cover has six holes. Of the four round holes at four corners, use two diagonal pair of holes to install the terminal cover. Either pair can be used.
- Insert the attached self-tapping screws into the pair of holes and tighten the screws to a torque of 0.8 to 1.0 N·m.
- For 1 through 3 decks of contact blocks, use terminal cover CS-VL2-13S.
- For 4 through 6 decks of contact blocks, use terminal cover CS-VL2-46S.
- The CS-VL2-46S consists of the CS-VL2-13S and a terminal cover for the fourth through sixth decks. Combine the two parts together as shown. Note that once combined, the two parts cannot be separated.

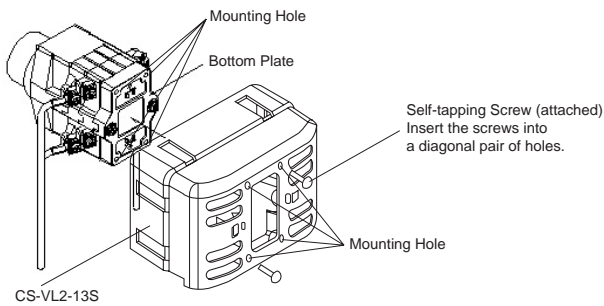

For 1 through 3 decks of contact blocks (CS-VL2-13S)

Minimum Mounting Centers for Installing the Terminal Cover

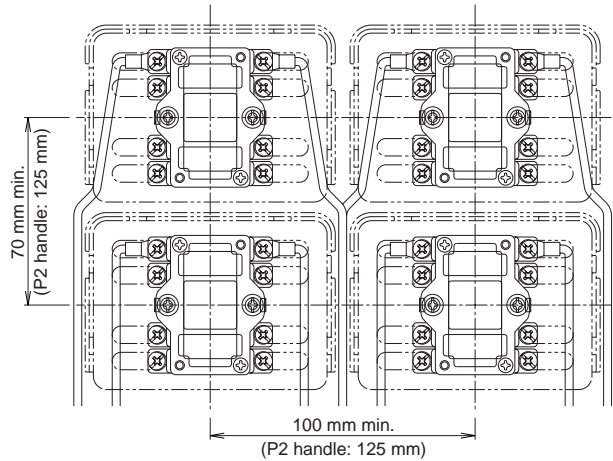

- Although the minimum mounting centers are 100 mm horizontally and 70 mm vertically, determine the mounting centers in consideration of convenience of wiring. For the P2 handle, the minimum mounting centers are 125 mm horizontally and vertically.

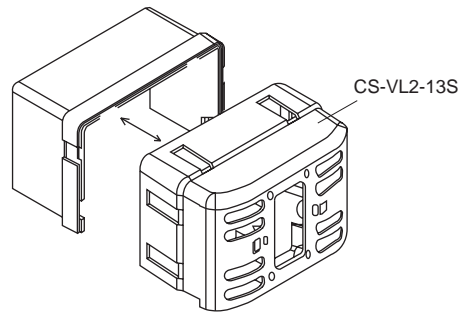

For 4 through 6 decks of contact blocks (CS-VL2-46S)

Terminal Cover Dimensions

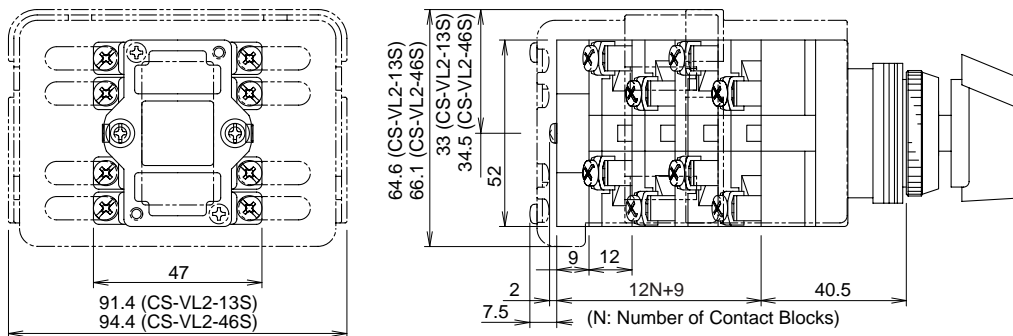

All dimensions in mm.

Standard Contact Arrangements

- The following table lists 76 standard contact arrangements for easy designation of required cam switch operation.
- When other contact arrangements are required, specify the number of contact block decks, operator positions, angles, and contact operation using the Custom Contact Arrangement Specification Sheet on page 54.

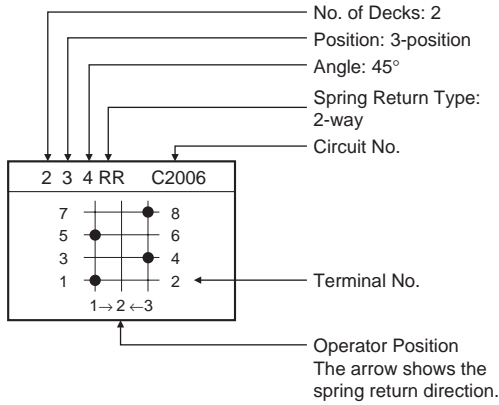

Symbol	Contact Operation
●	Contacts closed.
▬	Contacts remain closed between two operator positions.
⊃	Overlapping Contacts Contacts of different decks are both closed at one point while the handle is turned to the next position.
○	Residual Contacts When the handle is returned to the center, the contacts remain closed. The contacts are opened when the handle is turned to the opposite direction.

Listing Order of the Table

The 76 standard contact arrangements are listed in the order of the circuit number.

Same Circuits

Shown in the following examples, circuits of Fig. 1 and Fig. 2 have the same functions. When ordering, examine the standard contact arrangements. Your requirements may be satisfied simply by changing external wiring of the standard contact arrangements.

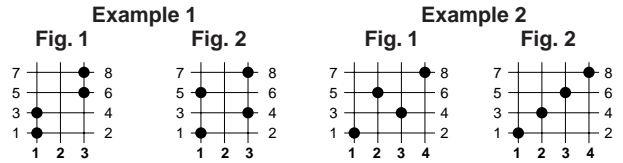

Terminal Numbers

The terminal numbers on the contact blocks correspond with the numbers shown in the chart as shown below.

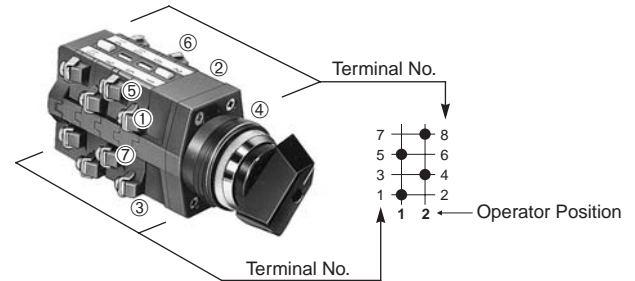

Standard Contact Arrangement Chart				
1 2 9 C1001	1 2 9 C1002	1 2 4 OR C1003	1 2 4 OR C1004	1 3 4 C1005
1 3 4 C1006	1 3 4 RR C1007	1 3 4 RR C1008	1 3 4 RR C1009	1 3 4 RR C1010
1 4 4 C1011	1 2 9 C1013	1 2 9 C1014	1 2 4 OR C1015	1 3 4 C1016
1 2 4 C1017	1 3 4 RR C1018	1 2 6 C1019		
2 2 9 C2001	2 2 9 C2002	2 3 4 C2003	2 3 4 C2004	2 3 4 C2005

ø30/ø25 CS Series Cam Switches

<p>2 3 4 RR C2006</p>	<p>2 3 4 RR C2007</p>	<p>2 4 4 C2008</p>	<p>2 4 4 C2009</p>	<p>2 4 9 C2011</p>
<p>2 2 9 C2014</p>	<p>2 2 9 C2015</p>	<p>2 3 4 C2016</p>	<p>2 3 4 C2017</p>	<p>2 3 4 C2018</p>
<p>2 3 4 C2019</p>	<p>2 3 4 C2020</p>	<p>2 3 4 RR C2021</p>	<p>2 4 4 C2022</p>	<p>2 3 3 C2023</p>
<p>2 3 3 C2024</p>	<p>2 4 3 C2025</p>	<p>2 5 3 C2027</p>	<p>2 3 6 C2028</p>	<p>2 3 6 C2029</p>
<p>3 2 9 C3001</p>	<p>3 3 4 C3002</p>	<p>3 5 4 C3003</p>	<p>3 6 4 C3004</p>	<p>3 3 4 C3005</p>
<p>3 4 9 C3008</p>	<p>3 4 9 C3009</p>	<p>3 2 9 C3010</p>	<p>3 3 4 C3011</p>	<p>3 4 4 C3012</p>
<p>3 6 3 C3013</p>	<p>3 3 6 C3014</p>	<p>3 6 6 C3015</p>	<p>3 5 3 C3016</p>	<p>3 4 4 C3017</p>
<p>3 3 6 C3018</p>	<p>3 3 6 C3019</p>	<p>4 4 4 C4001</p>	<p>4 8 4 C4002</p>	<p>4 4 9 C4003</p>
<p>4 2 4 C4004</p>	<p>4 2 9 C4005</p>	<p>4 2 9 C4006</p>	<p>4 4 9 C4007</p>	<p>4 3 4 C4008</p>

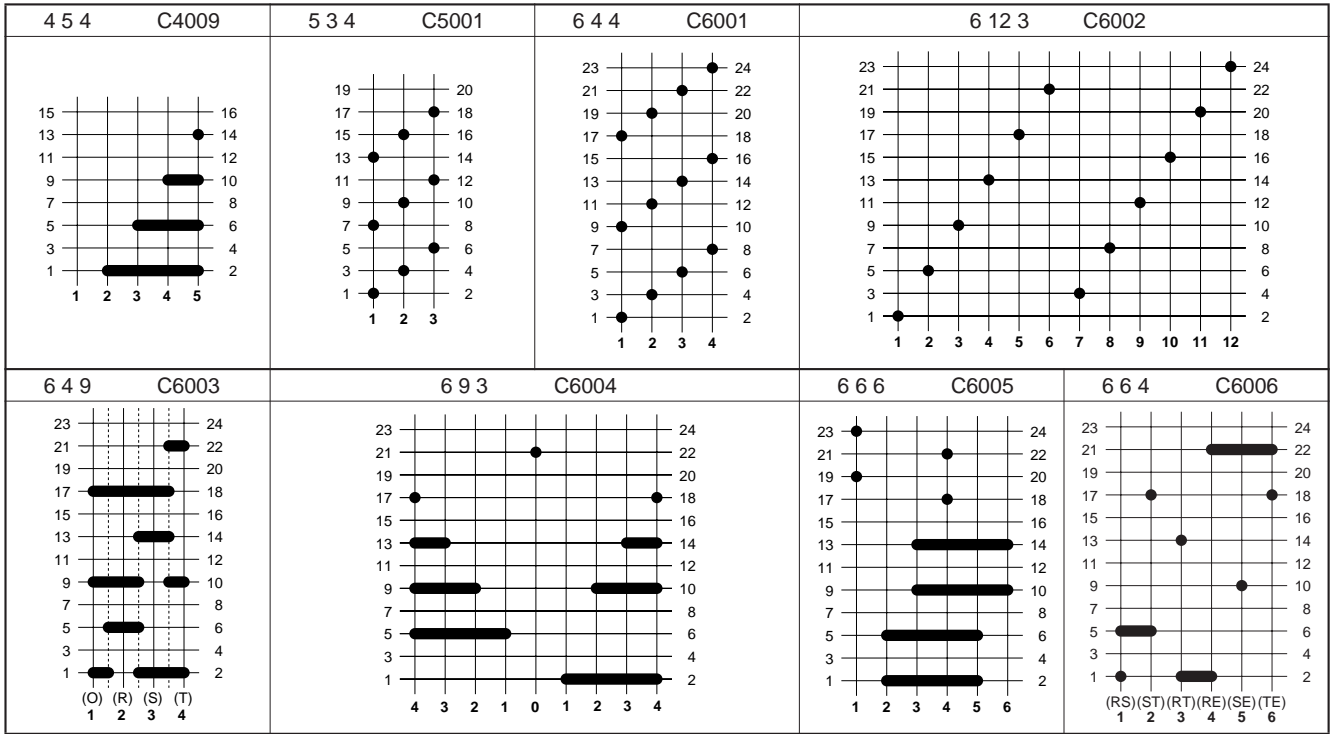

Application Examples (Voltmeter and Ammeter Circuits)

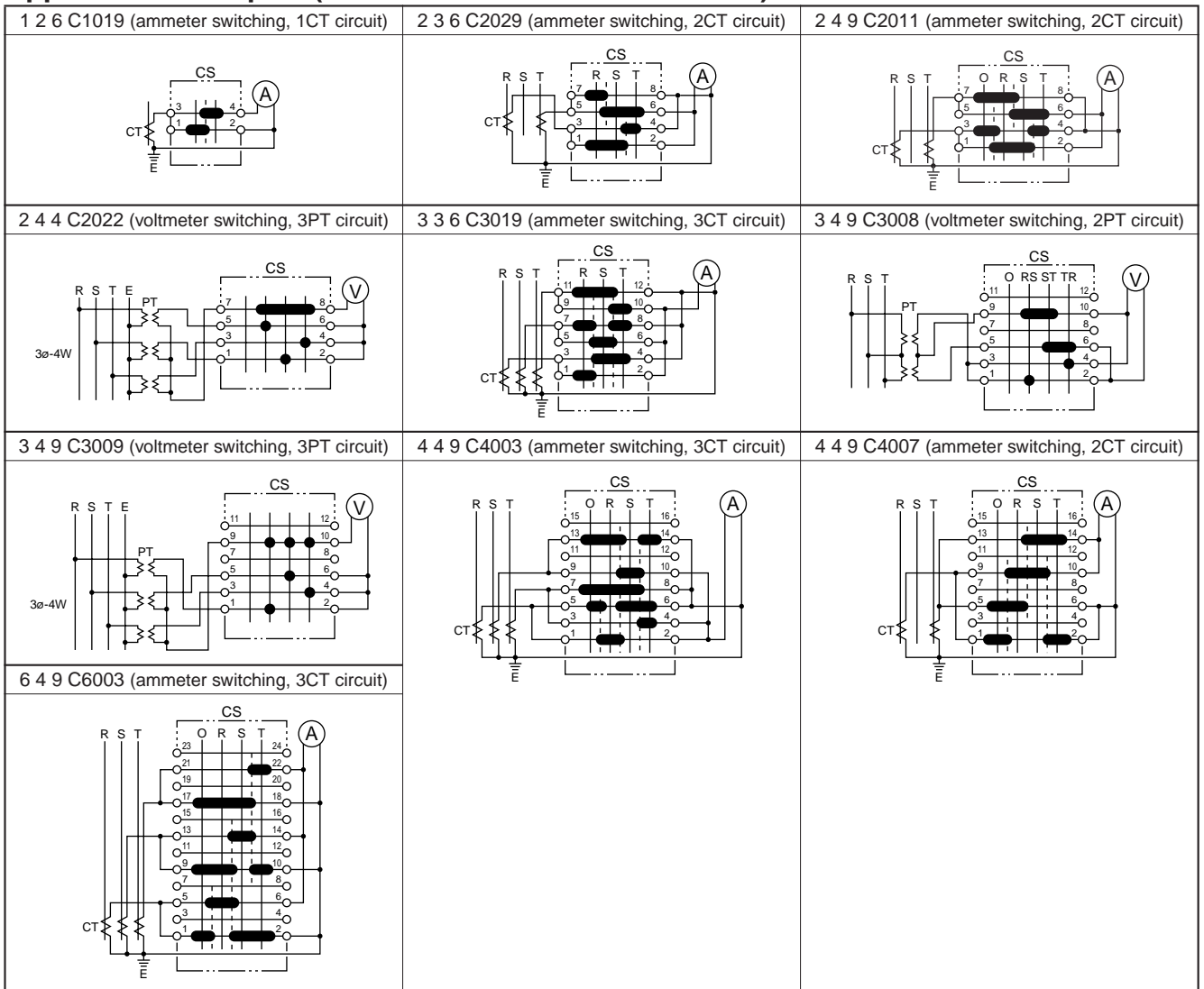

Custom Contact Arrangement Specification Sheet

- The preceding pages provide 76 standard contact arrangements. When other contact arrangements are required, specify the number of contact block decks, operator positions, angles, and contact operation using the Custom Contact Arrangement Specification Sheet shown below.
- For available number of contact blocks and operator positions, see the Ordering Information on page 48.

1. Specify operator positions

Indicate the operator positions starting at the first position. When spring return operation is required, mark an arrow between two operator positions to indicate the spring return direction.

Deck 2	7	○	○	○	●	○
	5	○	■	○	○	○
Deck 1	3	○	●	○	○	○
	1	●	○	○	○	○
Angle		↘		↗		
Positions		1	2	3	4	5
Spring Return		→				

2. Specify contact operation at each operator position







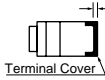

Indicate the required operation of all contacts at each operator position using the following symbols.

Symbol	Contact Operation
●	Contacts closed.
■	Contacts remain closed between two operator positions.
	Overlapping Contacts Contacts of different decks are both closed at one point while the handle is turned to the next position. Overlapping contacts are not available for handle angles of 30° and 45°.
○	Residual Contacts When the handle is returned to the center, the contacts remain closed. The contacts are opened when the handle is turned to the opposite direction.

- One deck of contact block contains two poles of contacts and four terminals. When the handle is made to turn 180° or more, special attention is needed. Since one cam operates the two poles of contacts on opposite positions, the same contact operation repeats on the other pole of contacts when the handle is turned 180°. When different contact operation is needed for handle angles of 180° or more, use another deck of contact block.

CS Series Cam Switch Custom Contact Arrangement Specification Sheet														
Type No.: [-----]											Quantity: _____			
① Type ② Decks ③ Positions ④ Angle ⑤ Spring Return ⑥ Handle														
Deck	Terminal No.	Contact Arrangement Chart												Terminal No.
Deck 6	23	○	○	○	○	○	○	○	○	○	○	○	○	24
	21	○	○	○	○	○	○	○	○	○	○	○	○	22
Deck 5	19	○	○	○	○	○	○	○	○	○	○	○	○	20
	17	○	○	○	○	○	○	○	○	○	○	○	○	18
Deck 4	15	○	○	○	○	○	○	○	○	○	○	○	○	16
	13	○	○	○	○	○	○	○	○	○	○	○	○	14
Deck 3	11	○	○	○	○	○	○	○	○	○	○	○	○	12
	9	○	○	○	○	○	○	○	○	○	○	○	○	10
Deck 2	7	○	○	○	○	○	○	○	○	○	○	○	○	8
	5	○	○	○	○	○	○	○	○	○	○	○	○	6
Deck 1	3	○	○	○	○	○	○	○	○	○	○	○	○	4
	1	○	○	○	○	○	○	○	○	○	○	○	○	2
Angle														
Positions		1	2	3	4	5	6	7	8	9	10	11	12	
Spring Return														

Accessories

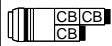
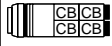
Terminal Cover		N-VL2	N-VL3	N-VL4	APN-PVL	APD-PVL	Use of terminal covers increases the depth by the dimensions below. 
ø30 Series Control Unit		 38.4H × 22W	 38H × 30.4W	 38.4H × 24W	 38H × 46W	 37H × 44W	
Pilot Light APN, APNE, UPQN, UPQNE	Full Voltage				X		+5.0 mm
Pilot Light APD, APDE							X
Pilot Light APN, APNE, APD, APDE, UPQN, UPQNE	Transformer DC-DC Converter		X				+2.7 mm
Pushbutton ABN, ABD, AON, AOD, AVN, ABGD, AJN, ABFD, ATN, AOFD, UBQN, AVD, UOQN, AJD, UWQN, AZD, ABBN, AYD, ABBS (ø25) Selector Switch ASN, ASD, ASTN Selector Pushbutton ABN, ASBD	1 contact block 	X					+0 mm
	2 contact blocks 	X 2 pieces					
	3 contact blocks 	X 2 pieces					
	4 contact blocks 	X 2 pieces					
Illuminated Pushbutton ALN, ALD, ALNE, ALDE, AOLN, AOLD, AOLNE, AOLDE, ALGN, ALGD, ALGNE, ALGDE, AOLGN, AOLGDE, ALFN, ALFD, ALFNE, ALFDE, AOLFNE, AOLFD, AOLFNE, AOLFDE, AVLN, AVLD, AVLNE, AVLDE, AJLN, AJLD, AJLNE, AJLDE, ULQN, UOLQN	Full Voltage			X 2 pieces			+4.5 mm
	Illuminated Selector Switch ASLN, ASLD Push-to-Check Pilot Light APN1**P	Transformer DC-DC Converter		X			

• **Ordering Terminal Covers**

When ordering terminal covers, specify the Type No. and the quantity.

ø30 ø30 Series Accessories and Replacement Parts

Nameplates

Type	Legend	Material	Type No.	Ordering Type No.	Package Quantity	Dimensions (mm)	Applicable Unit
NA	Blank	Aluminium 1.2 mm thick White letters on black background	NA-0	NA-0	1		ø30 Control Unit
				NA-0PN10	10		
	With Legend		NA-*	NA-*	1		
				NA-*PN10	10		
NALO	Blank	Aluminium 1.2 mm thick Black	NALO	NALO	1		
				NALOPN10	10		
MLO	Blank	Brass (chrome-plated) 1.0 mm thick Matte	MLO	MLO	1		ARN/ARNS Mono-Lever
				MLOPN10	10		
CQ	Blank	Aluminium 0.5 mm thick White letters on black background	CQ-0	CQ-0	1	<ul style="list-style-type: none"> • With adhesive tapes on the back 	UCSQO Cam Switch
				CQ-0PN10	10		
	With Legend (Legend Codes 31 and 53 only)		CQ-*	CQ-*	1		
				CQ-*PN10	10		
CQM	Blank	Aluminium 0.5 mm thick White letters on black background	CQM-0	CQM-0	1	<ul style="list-style-type: none"> • With adhesive tapes on the back 	UCSQM Cam Switch
				CQM-0PN10	10		
	With Legend (Legend Code 31 only)		CQM-*	CQM-*	1		
				CQM-*PN10	10		

• Specify a legend code in place of * in the Ordering Type No.

Nameplates

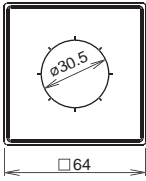
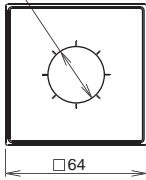
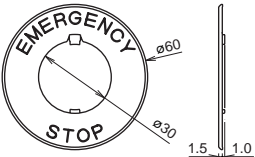
Type	Legend	Material	Type No.	Ordering Type No.	Package Quantity	Dimensions (mm)	Applicable Unit
CQN	Blank	Aluminium 0.5 mm thick White letters on black background	CQN-0	CQN-0	1		ACSNO, ACSNK Cam Switches ø30 mm Selector Switches
				CQN-0PN10	10		
	With Legend (Legend Codes 31, 35, and 53 only)		CQN-*	1			
			CQN-*PN10	10			
CQS	Blank	Aluminium 0.5 mm thick White letters on black background	CQS-0	CQS-0	1		ACSSO, ACSSK Cam Switches ø25 mm Selector Switches
				CQS-0PN10	10		
	With Legend (Legend Code 53 only)		CQS-*	1			
			CQS-*PN10	10			
HNAV	Blank	Polyamide Black letters on yellow back- ground	HNAV-0	HNAV-0	1		HN1E ø30 mm series Emergency Stop Switches
	EMERGENCY		HNAV-27	HNAV-27	1		

• Specify a legend code in place of * in the Ordering Type No.

Legends

Code	Legend
0	(blank)
1	ON
2	OFF
3	START
4	STOP
31	OFF-ON
35	HAND-AUTO
53	HAND-OFF-AUTO

Shape and Engraving Area

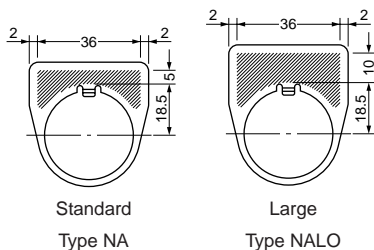











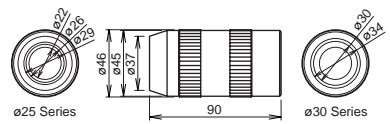

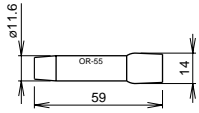

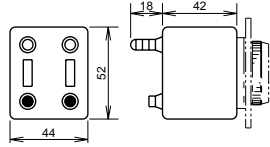
Example

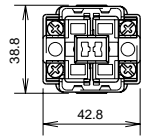
Shape	Engraving Area		Max. No. of Lines	No. of Letters on 1 Line
	Height	Width		
Standard	5	36	1	14
Large	10	36	2	14

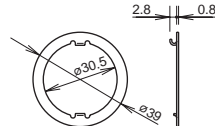

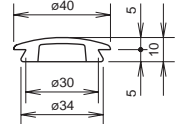

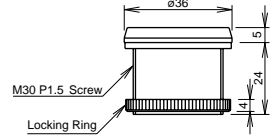

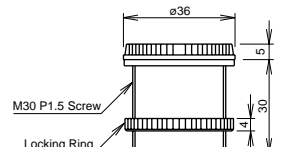

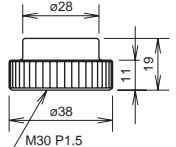

• The above example is when the letter is 4 mm tall.

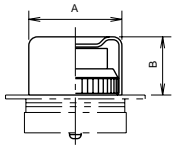
ø30 ø30 Series Accessories and Replacement Parts

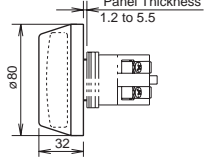
Accessories

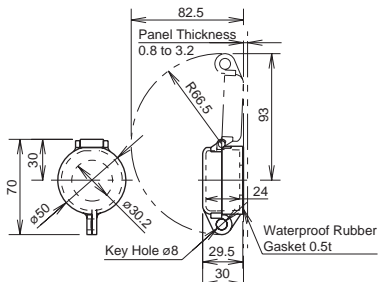

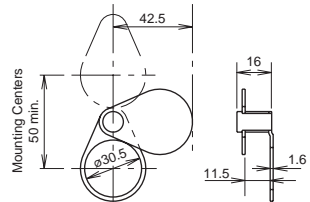

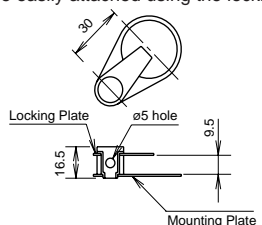

Shape	Material	Type No.	Ordering Type No.	Package Quantity	Dimensions (mm)
	Rubber	OR-12	OR-12	1	<ul style="list-style-type: none"> Used to tighten the locking ring when installing the ø30 or ø25 switch onto a panel. 
	Rubber	OR-55	OR-55	1	<ul style="list-style-type: none"> Used to install and remove the LED/incandescent lamps. See page 64. 
 <p>For momentary 1 layer of contact blocks (2 contact blocks)</p>	Rubber (nitril) (black)	OC-99	OC-99	1	<ul style="list-style-type: none"> Rubber boot used to prevent oil and dirt from entering into the contact block. Temperature range: -5 to +60°C Cannot be used for zinc diecast control units. 
 <p>For 1 layer of contact blocks (2 contact blocks)</p>	Rubber (translucent)	OC-90	OC-90	1	<ul style="list-style-type: none"> Applicable to AVN3 and AJN3. Applicable to ø30 diecast zinc pushbuttons and selector switches. 
		OC-290	OC-290	1	
	Metal	OGL-11	OGL-11PN10	10	<ul style="list-style-type: none"> Used to prevent the operator from turning. Generally used when using no nameplates on selector switches and selector pushbuttons. See page 64. 
	Rubber (black)	OB-13B	OB-13BPN05	5	<ul style="list-style-type: none"> Used to plug unused ø30mm mounting holes. Gray also available. Ordering Type No.: OB-13PN05 
	Plastic (gray)	OBP-11	OBP-11	1	<ul style="list-style-type: none"> Tightening torque: 1.2 N·m. Degree of protection: IP65 
	Metal (diecast) (zinc-plated)	OB-11	OB-11	1	<ul style="list-style-type: none"> Tightening torque: 1.2 N·m. Degree of protection: IP65 

Accessories

Shape		Material	Type No.		Ordering Type No.	Package Quantity	Dimensions (mm)								
Button Cover for Extended Pushbuttons 		Rubber (nitril)	Color	Type	–	–	<ul style="list-style-type: none"> • Metallic bezels covered with a rubber boot to enhance waterproof characteristics. • Button is not included. Applicable to extended pushbuttons only. 								
			Black	OC-11B	OC-11B	1									
			Green	OC-11R	OC-11R										
			Red	OC-11G	OC-11G										
			Yellow	OC-11Y	OC-11Y										
Pushbutton Clear Boot 	For flush pushbuttons	Rubber (EPDM)	OC-121	OC-121	1	<ul style="list-style-type: none"> • Used to cover and protect pushbuttons where units are subject to water splash. Not suitable for outdoor use or where the units are subject to oil splash.  <table border="1" data-bbox="1062 712 1310 792"> <thead> <tr> <th></th> <th>A</th> <th>B</th> </tr> </thead> <tbody> <tr> <td>OC-121</td> <td>37</td> <td>16</td> </tr> <tr> <td>OC-122</td> <td>37</td> <td>16</td> </tr> </tbody> </table>		A	B	OC-121	37	16	OC-122	37	16
			A	B											
OC-121	37	16													
OC-122	37	16													
	For extended pushbuttons	OC-122	OC-122	1											
Dust-proof Rubber Cover for Jumbo Mushrooms 		Rubber (nitril) black	OC-4GN	OC-4GN	1	<ul style="list-style-type: none"> • Used for ABN4G pushbuttons. 									
Padlock Cover 		Polyarylate (gasket: nitril rubber)	OL-KL1	OL-KL1	1	<ul style="list-style-type: none"> • Used to protect pushbuttons, illuminated pushbuttons, and selector switches (knob operator). 									
Metal Protector 		Metal (zinc-plated)	OL-C	OL-C	1	<ul style="list-style-type: none"> • Used to protect flush pushbuttons from inadvertent operation. • Can be easily attached using the locking ring. 									
Locking Attachment 		Metal (zinc-plated)	OL-H	OL-H	1	<ul style="list-style-type: none"> • Used to lock an extended pushbutton in the depressed position. • Can be easily attached using the locking ring. 									

ø30 ø30 Series Accessories and Replacement Parts

Maintenance Parts

Shape	Specification	Type No.	Ordering Type No.	Package Quantity	Remarks
Metallic Bezel 	Metal (chrome-plated)	OG-11	OG-11PN02	2	
Plastic Bezel 	Plastic	OGP-11*	OGP-11*PN02	2	Specify a color code in place of *. B (black), G (green), R (red), W (white), Y (yellow)
Clear Plastic Bezel for Flush Pushbuttons 	Clear Plastic	OGP-13	OGP-13PN02	2	<ul style="list-style-type: none"> • Clear plastic bezel and full shroud. • OGP-1411 cannot be used with LED illumination units and diecast units.
Clear Plastic Bezel for Extended Pushbuttons 		OGP-14	OGP-14PN02	2	
Clear Plastic Bezel for Illuminated Pushbuttons 		OGP-1411	OGP-1411	1	
Clear Button Cover 	Clear Plastic	ABN1B-C	ABN1B-CPN05	5	<ul style="list-style-type: none"> • Used on flush and extended pushbuttons to indicate a mark or a symbol engraved on the marking plate. The clear button cover holds the marking plate. The ø30 series marking chip can only be used on the ABN1 and AON1. • Specify a color code in place of *. B (black), G (green), R (red), W (white), Y (yellow)
Marking Plate 	Plastic	TN-0*	TN-0*PN10	10	







Maintenance Parts

Shape	Description	Material	Type No.	Ordering Type No.	Package Quantity	Color	
	1NO contact		BS010E	BS010E	1	• Push rod color: Green	
	1NC contact		BS001E	BS001E	1	• Push rod color: Red	
	EM contact (early make)		BS010SE	BS010SE	1	• Push rod color: Black	
	LB contact (late break)		BS001SE	BS001SE	1	• Push rod color: White	
	1NO contact		BST010	BST010	1	• Push rod color: Green	Applicable Units: • Pushlock Turn Reset • Push Turn Lock • LED Illuminated Pushbutton • LED Illuminated Selector Switch • Incandescent Illuminated Selector Switch • All ø30 Diecast Zinc Control Units
	1NC contact		BST001	BST001	1	• Push rod color: Red	
	EM contact (early make)		BST010S	BST010S	1	• Push rod color: Black	
	LB contact (late break)		BST001S	BST001S	1	• Push rod color: White	
	Used for APN(E)1	Plastic	APN106LN-②	APN106LN-②PN05	5	A (amber), C (clear), G (green), R (red), S (blue), W (white), Y (yellow) • Use the white (W) lens for pure white illumination	
	Used for UPQNE4 U(O)LQN*B		UPQN406L-②	UPQN406L-②PN05	5	C (clear), G (green), R (red), S (blue) • Use the clear (C) lens for white illumination.	
			UPQN406LD-②	UPQN406LD-②PN05		A (amber), Y (yellow) • Use the amber (A) lens for orange illumination.	
	Used for UPQN3B U(O)LQN		ULQN06L-②	ULQN06L-②PN05	5	C (clear), G (green), R (red), S (blue)	
			UPQN06LD-②	UPQN06LD-②PN05		A (amber), W (white), Y (yellow) • Use the amber (A) lens for orange illumination.	
			Used for ALN, AOLN (LED)	ALN2L-②	ALN2L-②PN05	5	G (green), R (red), S (blue)
ALN2LD-②		ALN2LD-②PN05		5	A (amber), W (white), Y (yellow) • Use the white (W) lens for pure white illumination		
Used for ALN, AOLN (incandescent) (1W)		ALN06L-②	ALN06L-②PN05	5	C (clear), G (green), R (red), S (blue)		
		ALN06LD-②	ALN06LD-②PN05	5	A (amber), W (white) • Use the amber (A) lens for orange illumination.		
Used for ALN, AOLN (incandescent) (2W)		ALN08L-②	ALN08L-②PN05	5	C (clear), G (green), R (red), S (blue)		
		ALN08LD-②	ALN08LD-②PN05	5	A (amber), W (white) • Use the amber (A) lens for orange illumination.		
	Flush	Plastic	ABN1B-①	ABN1B-①PN05	5	G (green), R (red), Y (yellow) Above colors are used for ø30 control units (dark colored operator units). For black, use black buttons from light colored operator units.	
	Extended		ABN2B-①	ABN2B-①PN05	5		
	Mushroom		ABN3B-①	ABN3B-①PN02	2		
	Flush		ABN1BN-①	ABN1BN-①PN05	5	B (black), G (green), R (red), S (blue), Y (yellow), W (white) Above colors are used for ø30 diecast zinc control units (light colored operator units).	
	Extended		ABN2BN-①	ABN2BN-①PN05	5		
	Mushroom		ABN3BN-①	ABN3BN-①PN02	2		
	① Mushroom (ABN4)	Plastic	ABN4B-①	ABN4B-①	1	B (black), G (green), R (red), Y (yellow)	
	② Mushroom (ABN4G/ABN4F)		ABN4GB-①	ABN4GB-①	1		
	③ Square Flush (UBQN1)		UBQN1B-①	UBQN1B-①PN02	2		
	④ Square Extended (UBQN2)		UBQN2B-①	UBQN2B-①PN02	2		

Note: Specify a button color code or lens color code in place of ① or ② in the Ordering Type No.

ø30 ø30 Series Accessories and Replacement Parts

Maintenance Parts

Shape	Description	Material	Type No.	Ordering Type No.	Package Quantity	Remarks
	For ø40 pushlock turn reset pushbuttons		AVLN3L-R	AVLN3L-RPN02	2	
	For UPQN4	Plastic	UPQN406N-W	UPQN406N-WPN05	5	
	ASN*K	Metal	ASN-SK-24401	ASN-SK-24401PN02	2	<ul style="list-style-type: none"> • Applicable to ABN3K, ABN4K, ABN5
		Rubber	OW-12	OW-12PN10	10	
		Rubber	OW-11	OW-11PN10	10	
	① Half shroud (for pushbuttons)	Metal	ABN2G	ABN2G	1	
	② Full shroud (for pushbuttons)		ABN2F	ABN2F	1	
	③ Full shroud (for mushroom pushbuttons)		ABN3G	ABN3G	1	
	④ Shallow shroud (for jumbo mushrooms)		ABN4G	ABN4G	1	
	⑤ Deep shroud (for jumbo mushrooms)		ABN4F	ABN4F	1	
	⑥ Half shroud (for illuminated pushbuttons)		ALN1GL	ALN1GL	1	<ul style="list-style-type: none"> • For incandescent/LED illuminated pushbuttons (E12 base)
			ALN2GL	ALN2GL	1	<ul style="list-style-type: none"> • For LED illuminated pushbuttons (BA9S base)
	⑦ Full shroud (for illuminated pushbuttons)		ALN1F	ALN1F	1	<ul style="list-style-type: none"> • For incandescent/LED illuminated pushbuttons (E12 base)
	ALN2FL	ALN2FL	1	<ul style="list-style-type: none"> • For LED illuminated pushbuttons (BA9S base) 		
	100/110V AC (for LED/1W incandescent lamps)		TWR-016N	TWR-016N	1	Mounting screws are not included.
	200/220V AC (for LED/1W incandescent lamps)		TWR-026N	TWR-026N	1	

Maintenance Parts

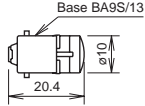
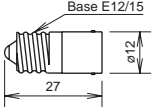

LED Lamps

Dimensions	Operating Voltage	Current Draw		Type No.	Ordering Type No.	Illumination Color Code	Package Quantity	Base
		AC	DC					
 <p>Base BA9S/13</p>	6V AC/DC ±10%	17 mA (A, R, W, Y)	14 mA (A, R, W, Y)	LSTD-6②	LSTD-6②	Specify a color code in place of ② in the Ordering Type No. A: amber G: green PW: pure white R: red S: blue W: white Y: yellow	1	BA9S/13
		8 mA (G, PW, S)	5.5 mA (G, PW, S)		LSTD-6②PN10		10	
	12V AC/DC ±10%	11 mA	10 mA	LSTD-1②	LSTD-1②		1	
					LSTD-1②PN10		10	
	24V AC/DC ±10%	11 mA	10 mA	LSTD-2②	LSTD-2②		1	
					LSTD-2②PN10		10	
 <p>Base E12/15</p>	6V AC/DC ±10%	17 mA (A, R, W, Y)	14 mA (A, R, W, Y)	LETD-6②	LETD-6②	Specify a color code in place of ② in the Ordering Type No. A: amber G: green R: red S: blue W: white Y: yellow	1	E12/15
		8 mA (G, PW, S)	5.5 mA (G, PW, S)		LETD-6②PN10		10	
	12V AC/DC ±10%	7 mA	6.5 mA	LETD-8②	LETD-8②		1	
					LETD-8②PN10		10	
	24V AC/DC ±10%	11 mA	10 mA	LETD-2②	LETD-2②		1	
					LETD-2②PN10		10	

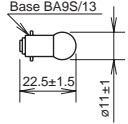
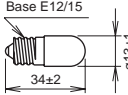
Incandescent Lamps

Dimensions	Rated Operating Voltage	Lamp Ratings	Type No.	Package Quantity	Life
 <p>Base BA9S/13</p>	6V AC/DC	1W (6.3V)	LS-6	1	Approx. 1000 hours minimum (reference value)
	12V AC/DC	1W (18V)	LS-8		
	18V AC/DC	1W (24V)	LS-2		
	24V AC/DC	1W (30V)	LS-3		
 <p>Base E12/15</p>	6V AC/DC	2W (6.3V)	LE-6	1	
	12V AC/DC	2W (18V)	LE-8		
	18V AC/DC	2W (24V)	LE-2		
	24V AC/DC	2W (30V)	LE-3		

Transformer

Separate Mounting Type	Primary Voltage	Secondary Voltage	Type No.	Applicable Load
 <p>For 1W</p>	100/110V AC	5.5V	TWR516	One full voltage type pilot light or illuminated switch containing LSTD-6②, LETD-6② LED lamp (6V AC/DC) or LS-6 incandescent lamp (6.3 V AC/DC, 1W)
	200/220V AC		TWR526	
	400/440V AC		TWR546	
 <p>For 2W</p>	100/110V AC	15V	TWR518	One full voltage type pilot light or illuminated switch containing LE-8 incandescent lamp (18V AC/DC, 2W)
	200/220V AC		TWR528	
	400/440V AC		TWR548	

Safety Precautions

- Turn off the power to the ø30 series control units before starting installation, removal, wiring, maintenance, and inspection of the products. Failure to turn power off may cause electrical shocks or fire hazard.
- To avoid a burn on your hand, use the lamp holder tool when replacing lamps.
- For wiring, use wires of a proper size to meet the voltage and current requirements. Tighten the M3.5 terminal screws to a tightening torque of 1.0 to 1.3 N·m. Failure to tighten terminal screws may cause overheating and fire.

Instructions

Panel Mounting for Square Pushbuttons and Pilot Lights

1. Tighten the square ring to the operator and position the ring correctly.
2. Lightly tighten the screw to secure the pilot light onto the panel.

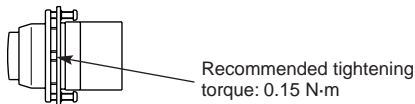

Tightening Torque for Terminal Screws

Tighten the terminal screws to a torque of 1.0 to 1.3 N·m.

Replacement of Lamps

Lamps can be replaced by using the lamp holder tool (OR-55) from the front of the panel.

- **How to Remove**
To remove, slip the lamp holder tool onto the lamp head lightly. Then push slightly, and turn the lamp holder tool counterclockwise.
- **How to Install**
To install, insert the lamp head into the lamp holder tool. Place the pins on the lamp base to the grooves in the lamp socket. Inset the lamp and turn it clockwise.



OR-55



Installing the Anti-rotation Ring

Anti-rotation rings are used on selector switches or pushbuttons which rotate and used when using no nameplates.

Insert a 1.5mm thick rubber washer between the panel and the anti-rotation ring as shown on the right.

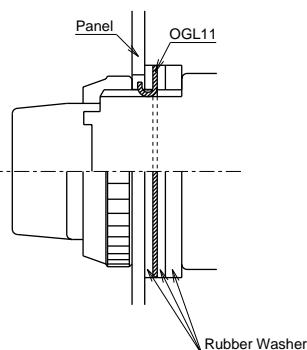

Panel Thickness and Rubber Washer

Adjust the thickness of the rubber washers according to the panel thickness. Also, make sure to include the nameplate thickness when using a nameplate.

Applicable Models

- Extended Illuminated Pushbuttons with Half Shroud (LED)
- Extended Pushbuttons with Half Shroud (Diecast)
- Extended Illuminated Pushbuttons with Half Shroud (Diecast)

Panel Thickness (mm)	Rubber Washer	
	1.5mm	3.0mm
Supplied	1 piece	1 piece
0.8 to 1.8	–	1 piece
1.8 to 3.5	1 piece	–

Applicable Models

- Extended Illuminated Pushbuttons with Full Shroud (Incandescent)
- Extended Illuminated Pushbuttons with Full Shroud (LED)
- Extended Illuminated Pushbuttons with Full Shroud (Diecast)
- Mushroom Pushbuttons with Full Shroud

Panel Thickness (mm)	Rubber Washer	
	1.5mm	3.0mm
Supplied	2 pieces	1 piece
0.8 to 2.0	1 piece	1 piece
2.0 to 3.5	1 piece	1 piece
3.5 to 5.0	–	1 piece
5.0 to 6.0 (6.5)	1 piece	–

The number in brackets is for mushroom pushbuttons with full shroud. Extended illuminated pushbuttons with full shroud (incandescent) are 5.0 mm maximum.

Applicable Models

- Toggle Lever Types
- Knob Push Turn Lock Illuminated Pushbuttons

Panel Thickness (mm)	Rubber Washer	
	1.5mm	3.0mm
Supplied	1 piece	1 piece
0.8 to 2.0	1 piece	1 piece
2.0 to 3.5	–	1 piece
3.5 to 5.5 (5.0)	1 piece	–

The number in brackets is for knob push turn lock illuminated pushbuttons.

Applicable Models

- Extended Pushbuttons with Half Shroud
- Extended Illuminated Pushbuttons with Half Shroud (Incandescent)

Panel Thickness (mm)	Rubber Washer	
	1.5mm	3.0mm
Supplied	1 piece	1 piece
0.8	1 piece	1 piece
0.8 to 2.3	–	1 piece
2.3 to 4.0	1 piece	–

Applicable Models

- Extended Pushbuttons with Full Shroud

Panel Thickness (mm)	Rubber Washer	
	1.5mm	3.0mm
Supplied	3 pieces	1 piece
0.8 to 1.5	3 pieces	1 piece
1.5 to 3.0	2 pieces	1 piece
3.0 to 4.5	1 piece	1 piece
4.5 to 6.0	–	1 piece
6.0 to 7.5	1 piece	–

Applicable Models

- Extended Pushbuttons with Full Shroud (Diecast)

Panel Thickness (mm)	Rubber Washer	
	1.5mm	3.0mm
Supplied	2 pieces	1 piece
0.8 to 2.5	2 pieces	1 piece
2.5 to 4.0	1 piece	1 piece
4.0 to 5.5	–	1 piece
5.5 to 6.0	1 piece	–

Applicable Models

- Other Models (Excluding Square Types)

Panel Thickness (mm)	Rubber Washer	
	1.5mm	3.0mm
Supplied	2 pieces	1 piece
0.8 to 3.5	2 pieces	1 piece
3.5 to 5.0	1 piece	1 piece
5.0 to 6.5	–	1 piece
6.5 to 7.5	1 piece	–

Installation of LED Illuminated Units

- Note the polarity for wiring when connecting to DC-DC converter unit.

Terminal No.	Polarity
X1	Positive
X2	Negative

- Transformer type units are recommended for use in areas subjected to noise.

Notes on LED Illuminated Units

LED lamps consist of semiconductors. If the applied voltage exceeds the rated voltage, LED elements may deteriorate due to overheat, resulting in significant decrease in luminance, hue change, or failure of lighting. Also, if an extraneous noise, transient voltage, or transient current is applied to the circuit, similar effects may occur. When using LED lamps, observe the following instructions.

• Rated Voltage

The LED lamps are rated at 6V, 12V, or 24V AC/DC, and can be used within $\pm 10\%$ the rated voltage of either AC or DC.

• DC Power

- Switching power supply
Regulated voltage from switching power supply is best suited. Make sure to use within the rated voltage of the LED lamp.
- Rechargeable battery
Note that the battery voltage may exceed the rated voltage of the LED lamp while the battery is being charged and immediately after the charging is complete. Be sure to use the LED lamp on a voltage of $\pm 10\%$ the rated voltage.
- Full-wave rectification
Since the LED lamp is AC/DC compatible, a diode bridge for rectification is not necessary. If the LED lamp is used on a full-wave rectification current through a diode bridge, the rectifier diodes will reduce the voltage, resulting in lower luminance.
- Single-phase half-wave rectification
This is not suitable for the power source of LED lamps. Use constant-voltage DC power.

• Noise

LED elements deteriorate due to extraneous noise, resulting in significant decrease in luminance, hue change, or failure of lighting. When such effects are anticipated, take a protection measure shown below, such as RC elements or a surge absorber.

- Notes for Pure White LED Lamps

- Do not use the pure white LED outdoors, otherwise it will lead to the degradation of brightness and color. Do not remove or apply shock to the cap on the pure white LED lamp, otherwise it may break or damage the cap.
- For the pure white LED, use a white lens. The illumination color will be dull if a different color is used.

[Protection Example 1] For AC circuit

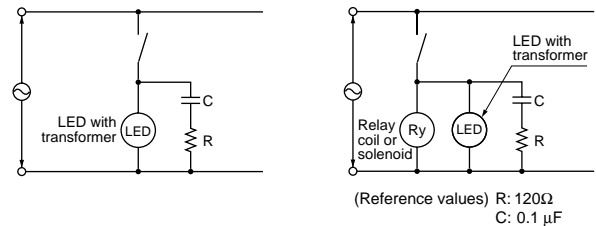

[Protection Example 2] For DC circuit

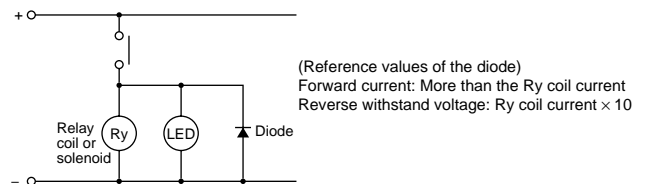

• Countermeasures against Dim Lighting

- Leakage currents through the transistors or a contact protection circuit may cause the LED lamp to illuminate dimly even when the output is off.
- When the LED lamp is illuminated by a transistor output, take the following measure.

[Circuit Example]

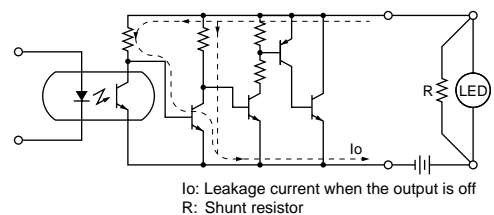

Connect shunt resistor R in parallel with the LED lamp.



ø30 ø30 series Diecast Zinc Control Units

Heavy duty switches for tough industrial usage

- Degree of protection: IP65 (IEC 60529)
- UL, CSA approved, and EN compliant

Safety Standards	File No. or Organization
UL 	UL Listing File No. E68961
CSA 	File No. LR21451
EN EN60947-5-1	



Specifications and Ratings

Contact Ratings

Pushbuttons Illuminated Pushbuttons Selector Switches Illuminated Selector Switches Selector Pushbuttons	Contact Block	Type BST (ø30 series)
	Rated Insulation Voltage	600V
	Rated Continuous Current	10A
	Contact Ratings by Utilization Category IEC 60947-5-1	AC-15 (A600) DC-13 (P600)

Characteristics

• Contact Ratings by Utilization Category



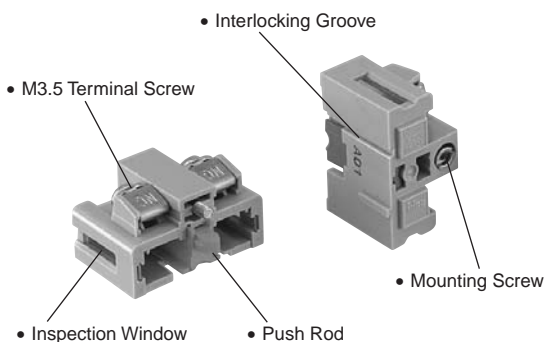

Operational Voltage			24V	48V	50V	110V	220V	440V
Operational Current	AC 50/60 Hz	AC-12 Control of resistive loads and solid state loads	10A	—	10A	10A	6A	2A
		AC-15 Control of electromagnetic loads (> 72 VA)	10A	—	7A	5A	3A	1A
	DC	DC-12 Control of resistive loads and solid state loads	10A	5A	—	2.2A	1.1A	—
		DC-13 Control of electromagnets	5A	2A	—	1.1A	0.6A	—

Note: The operational current represents the classification by making and breaking currents (IEC 60947-5-1).
Minimum applicable load: 3V AC/DC, 5 mA (applicable range may vary with operating conditions and load types)

BST Contact Block (Light Gray)



• Contact Block Types

		Single-pole Contact Block Type			
Contact					
		1NO	1NC	1 \overline{NO} (early make)	1 \overline{NC} (late break)
Type	BST	BST010	BST001	BST010S	BST001S
Push Rod		Green	Red	Black	White

Note: BST contact blocks are not interchangeable with dark gray BS contact blocks used for ø30 control units.

Specifications, ratings, and mounting hole layouts are the same as ø30 control units.
See "ø30 Series Control Units" on page 7.

Ordering Information

Standard Units

- Specify an operator or lens color code in the Type No.
- Black, green, and red colored buttons are included with flush pushbuttons.
- Full voltage type illuminated units are not supplied with a lamp. Order LED or incandescent lamps separately. Transformer type illuminated units contain an LED or incandescent lamp.
- Terminal covers, nameplates, and accessories are ordered separately.

Terminal Cover

- When a terminal cover is required, order an applicable terminal cover referring to page 55.

The Type No. development charts shown below can be used to specify control units other than those listed on the following pages.

ø30 Series Diecast Zinc Pushbuttons

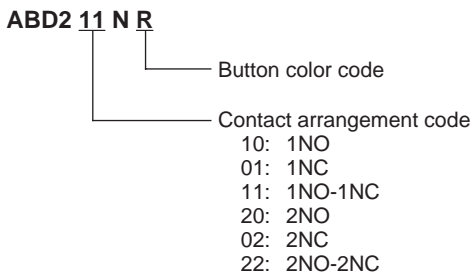

Note:

- Mushroom pull type AZD3 can have a maximum of two contact blocks.
- Mushroom push-pull type AYD31 can have a maximum of two contact blocks.

ø30 Series Diecast Zinc Pilot Lights

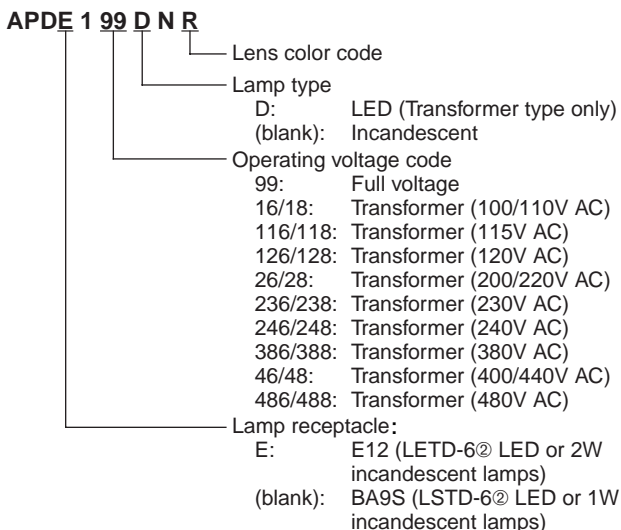

Note:

- Full voltage type is not supplied with a lamp.
- Transformer types contain an LED lamp (LSTD-6Ⓜ or LETD-6Ⓜ) or incandescent lamp (LS-6, 1W or LE-8, 2W).
- LED lamps cannot be used on 480V AC transformers.
- Operating voltage codes 18, 118, 128, 28, 238, 248, 388, 48, and 488 are available for incandescent types only.

ø30 Series Diecast Zinc Illuminated Pushbuttons

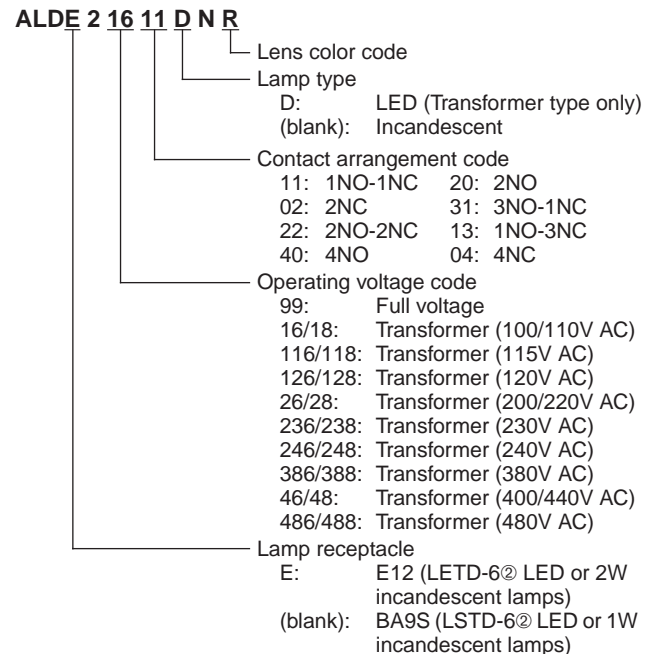

Note:

- Illuminated pushbuttons cannot have an odd number of contact blocks, such as 1NO, 1NC, 3NO, 2NO-1NC, 1NO-2NC, and 3NC.
- Full voltage type is not supplied with a lamp.
- Transformer types contain an LED lamp (LSTD-6Ⓜ or LETD-6Ⓜ) or incandescent lamp (LS-6, 1W or LE-8, 2W).
- LED lamps cannot be used on 480V AC transformers.
- Operating voltage codes 18, 118, 128, 28, 238, 248, 388, 48, and 488 are available for incandescent types only.

ø30 ø30 Series Diecast Zinc Control Units

ø30 Series Diecast Zinc Selector Switch

ASD 2 L 11 N

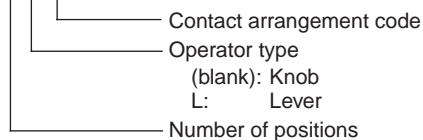

ø30 Series Diecast Zinc Key Selector Switch

ASD 2 K 20 N B

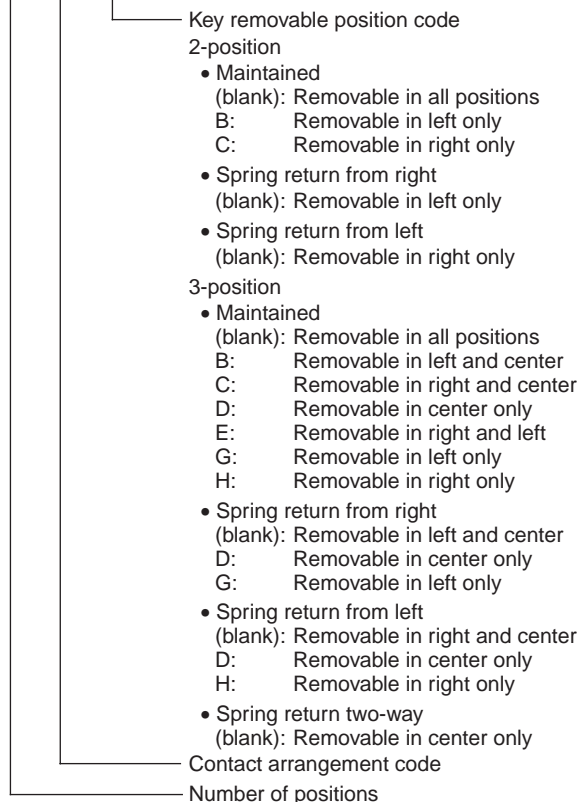

Note:

- The key cannot be removed in the return position.

ø30 Series Diecast Zinc Illuminated Selector Switch

ASLD 2 16 22 D N R

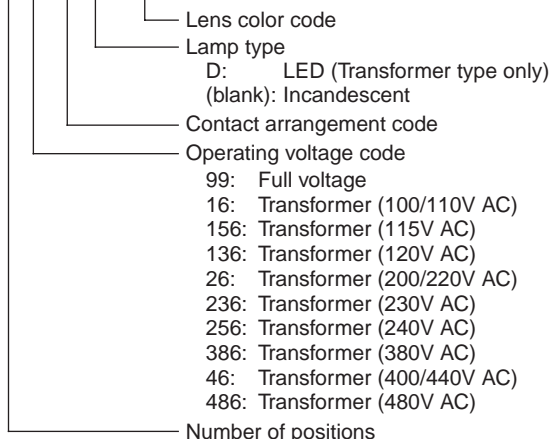









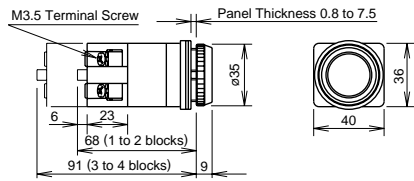

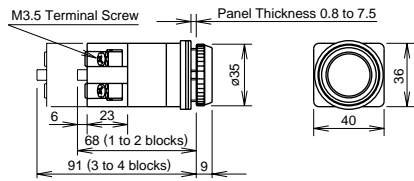

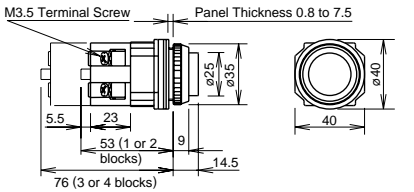

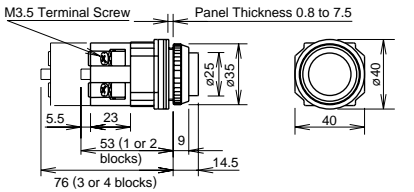
Note:

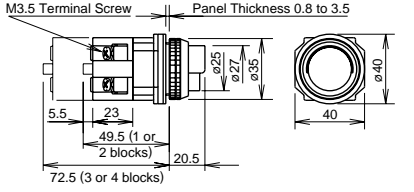
- Full voltage type is not supplied with a lamp.
- Transformer type contains an LED lamp (LSTD-6②) or incandescent lamp (LS-6).
- LED lamps cannot be used on 480V AC transformers.

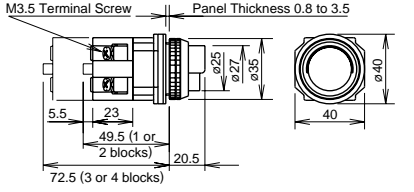
ø30 Diecast Zinc series Pushbuttons ø30

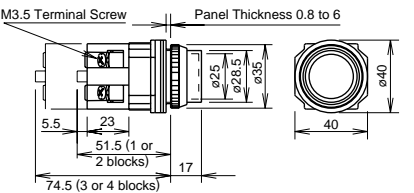

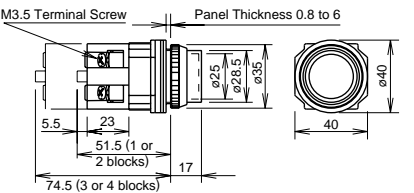



Flush / Extended / Extended with Half Shroud / Extended with Full Shroud

Shape	Operation Type	Contact	Type No.	① Button Color Code	Dimensions (mm)
Flush ABD1 	Momentary	1NO	ABD110N①	Black (B), green (G), and red (R) buttons are supplied with each unit.	
		1NC	ABD101N①		
		1NO-1NC	ABD111N①		
		2NO	ABD120N①		
		2NC	ABD102N①		
		2NO-2NC	ABD122N①		
Flush AOD1 	Maintained	1NO	AOD110N①	Specify S, Y, or W when a blue, yellow, or white button is required.	
		1NC	AOD101N①		
		1NO-1NC	AOD111N①		
		2NO	AOD120N①		
		2NC	AOD102N①		
		2NO-2NC	AOD122N①		
Extended ABD2 	Momentary	1NO	ABD210N①	Specify a button color code in place of ① in the Type No.	
		1NC	ABD201N①		
		1NO-1NC	ABD211N①		
		2NO	ABD220N①		
		2NC	ABD202N①		
		2NO-2NC	ABD222N①		
Extended AOD2 	Maintained	1NO	AOD210N①	B: black G: green R: red S: blue W: white Y: yellow	
		1NC	AOD201N①		
		1NO-1NC	AOD211N①		
		2NO	AOD220N①		
		2NC	AOD202N①		
		2NO-2NC	AOD222N①		
Extended with Half Shroud ABGD2 	Momentary	1NO	ABGD210N①	Specify a button color code in place of ① in the Type No.	
		1NC	ABGD201N①		
		1NO-1NC	ABGD211N①		
		2NO	ABGD220N①		
		2NC	ABGD202N①		
		2NO-2NC	ABGD222N①		
Extended with Half Shroud AOGD2 	Maintained	1NO	AOGD210N①	B: black G: green R: red S: blue W: white Y: yellow	
		1NC	AOGD201N①		
		1NO-1NC	AOGD211N①		
		2NO	AOGD220N①		
		2NC	AOGD202N①		
		2NO-2NC	AOGD222N①		
Extended with Full Shroud ABFD2 	Momentary	1NO	ABFD210N①	Specify a button color code in place of ① in the Type No.	
		1NC	ABFD201N①		
		1NO-1NC	ABFD211N①		
		2NO	ABFD220N①		
		2NC	ABFD202N①		
		2NO-2NC	ABFD222N①		
Extended with Full Shroud AOFD2 	Maintained	1NO	AOFD210N①	B: black G: green R: red S: blue W: white Y: yellow	
		1NC	AOFD201N①		
		1NO-1NC	AOFD211N①		
		2NO	AOFD220N①		
		2NC	AOFD202N①		
		2NO-2NC	AOFD222N①		

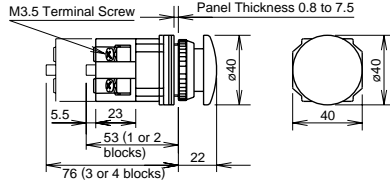
- Round bezel and shroud (metal): Chrome-plated
- Pushbuttons with one or three contact blocks contain a dummy block
- Other contact arrangements are also available. See page 67.

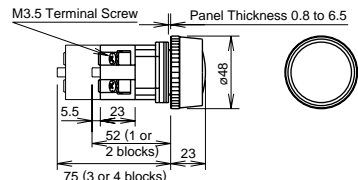

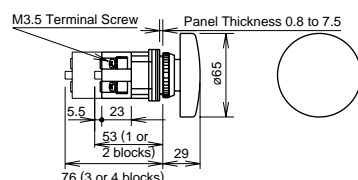





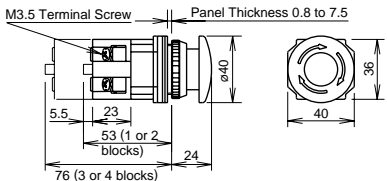

ø30 ø30 Diecast Zinc series Pushbuttons

Mushroom / Jumbo Mushroom Types

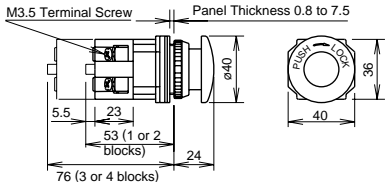
Shape	Operation Type	Contact	Type No.	① Button Color Code	Dimensions (mm)
Mushroom ABD3  UL LISTED SP CE	Momentary	1NO	ABD310N①	B: black G: green R: red W: white Y: yellow	
		1NC	ABD301N①		
		1NO-1NC	ABD311N①		
		2NO	ABD320N①		
		2NC	ABD302N①		
2NO-2NC	ABD322N①				
Mushroom AOD3  UL LISTED SP CE	Maintained	1NO	AOD310N①		
		1NC	AOD301N①		
		1NO-1NC	AOD311N①		
		2NO	AOD320N①		
		2NC	AOD302N①		
2NO-2NC	AOD322N①				
Mushroom with Full Shroud ABGD3  UL LISTED SP CE	Momentary	1NO	ABGD310N①	B: black DG: dark green DR: dark red G: green R: red Y: yellow	
		1NC	ABGD301N①		
		1NO-1NC	ABGD311N①		
		2NO	ABGD320N①		
		2NC	ABGD302N①		
2NO-2NC	ABGD322N①				
Mushroom with Full Shroud AOGD3  UL LISTED SP CE	Maintained	1NO	AOGD310N①		
		1NC	AOGD301N①		
		1NO-1NC	AOGD311N①		
		2NO	AOGD320N①		
		2NC	AOGD302N①		
2NO-2NC	AOGD322N①				
Jumbo Mushroom ABD4  UL LISTED SP CE	Momentary	1NO	ABD410N①	B: black DG: dark green DR: dark red G: green R: red Y: yellow	
		1NC	ABD401N①		
		1NO-1NC	ABD411N①		
		2NO	ABD420N①		
		2NC	ABD402N①		
2NO-2NC	ABD422N①				
Jumbo Mushroom with Shallow Shroud ABGD4  UL LISTED SP CE	Momentary	1NO	ABGD410N①		
		1NC	ABGD401N①		
		1NO-1NC	ABGD411N①		
		2NO	ABGD420N①		
		2NC	ABGD402N①		
2NO-2NC	ABGD422N①				
Jumbo Mushroom with Deep Shroud ABFD4  UL LISTED SP CE	Momentary	1NO	ABFD410N①		
		1NC	ABFD401N①		
		1NO-1NC	ABFD411N①		
		2NO	ABFD420N①		
		2NC	ABFD402N①		
2NO-2NC	ABFD422N①				

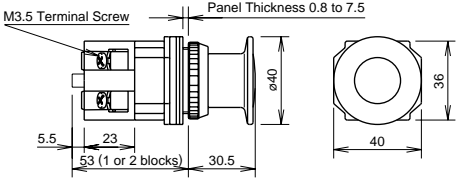
- Specify a button color code in place of ① in the Type No.
- Round bezel and shroud (metal): Chrome-plated
- Pushbuttons with one or three contact blocks contain a dummy block
- Other contact arrangements are also available. See page 67.

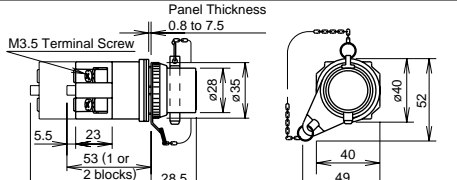
Pushlock Turn Reset / Push Turn Lock / Pull / Push-Pull / Pin Lock Types

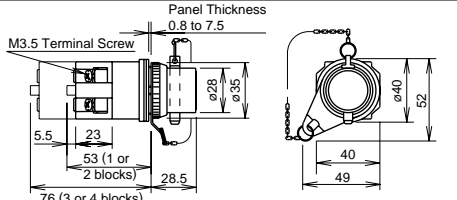
Shape	Contact	Type No.	① Button Color Code	Dimensions (mm)
Mushroom Pushlock Turn Reset AVD3  	1NO	AVD310N①	R: red Y: yellow	
	1NC	AVD301N①		
	1NO-1NC	AVD311N①		
	2NO	AVD320N①		
	2NC	AVD302N①		
Mushroom Push Turn Lock AJD3  	1NO	AJD310N①	B: black G: green R: red Y: yellow	
	1NC	AJD301N①		
	1NO-1NC	AJD311N①		
	2NO	AJD320N①		
	2NC	AJD302N①		
Mushroom Pull AZD3  	1NO	AZN310N①	B: black G: green R: red S: blue Y: yellow	
	1NO-1NC	AZN311N①		
	2NO	AZN320N①		
	2NC	AZN302N①		
Mushroom Push-Pull AYD31  	1NO-1NC	AYD3111N①	B: black G: green R: red S: blue Y: yellow	
	2NO	AYD3120N①		
	2NC	AYD3102N①		
Pin Lock ABD8P  	1NO	ABD8P10N①		
	1NC	ABD8P01N①		
	1NO-1NC	ABD8P11N①		
	2NO	ABD8P20N①		
	2NC	ABD8P02N①		
	2NO-2NC	ABD8P22N①		

- Specify a button color code in place of ① in the Type No.
 - Round bezel (metal): Chrome-plated
 - Pushbuttons with one or three contact blocks contain a dummy block.
 - Other contact arrangements are also available. See page 67.
 - **Pushlock Turn Reset:** Button is maintained when pressed and is reset when turned clockwise. Red buttons only.
- Note: AVD3 pushlock turn reset switches cannot be used as emergency stop switches. When emergency stop switches are required, use the HN1E series emergency stop switches (ISO 13850 and IEC 60947-5-5 compliant).
- **Push Turn Lock:** Button is locked when turned clockwise in the depressed position and is reset when turned counterclockwise.
 - **Pull:** Pulling the button operates the contacts. Up to 2 contact blocks (1 layer) can be mounted on pull switches.
 - **Push-Pull:** Button is maintained in both depressed and reset positions. Up to 2 contact blocks (1 layer) can be mounted on AYD31 push-pull switches.
 - **Pin Lock:** Button can be locked in either depressed or reset position by inserting the pin. Pad lock with a ø5mm pin can also be used to lock the button.

• Contact Operation

Pull Switch (Spring Return)

Contact	AZD3	
	Normal	Pull
1NO	⊖	⊖
1NC	⊙	⊙
1NO-1NC	⊖ ⊙	⊖ ⊙
2NO	⊖ ⊖	⊖ ⊖
2NC	⊙ ⊙	⊙ ⊙





Push-Pull Switch (Maintained)

Contact	AYD31	
	Push	Pull
1NO-1NC	⊖ ⊙	⊖ ⊙
2NO	⊖ ⊖	⊖ ⊖
2NC	⊙ ⊙	⊙ ⊙

Note: Pull and push-pull switches can have a maximum of two contact blocks.

ø30 ø30 Diecast Zinc series Pilot Lights

Dome Types

Shape	Lamp	Input Type	Lamp Receptacle	Type No.	② Lens/LED Color Code	Applicable Lamp
Dome APD1 APDE1    	Without Lamp	Full Voltage	BA9S	APD199N②	A: amber C: clear G: green R: red S: blue W: white Y: yellow	LSTD LS (1W)
			E12	APDE199N②		LETD LE (2W)
	LED	Transformer	BA9S	APD1③DN②	A: amber G: green PW: pure white (BA9S only) R: red S: blue W: white Y: yellow	LSTD-6②
			E12	APDE1③DN②		LETD-6②
	Incandescent	Transformer	BA9S	APD1③N②	A: amber C: clear G: green R: red S: blue W: white	LS-6 (1W)
			E12	APD1③N②		LE-8 (2W)

• Operating Voltage Code

Specify an operating voltage code in place of ③ in the Type No.

③ Operating Voltage Code	
LED Transformer BA9S and E12 Types Incandescent Transformer BA9S Type	Incandescent Transformer E12 Type
16: 100/110V AC	18: 100/110V AC
116: 115V AC	118: 115V AC
126: 120V AC	128: 120V AC
26: 200/220V AC	28: 200/220V AC
236: 230V AC	238: 230V AC
246: 240V AC	248: 240V AC
386: 380V AC	388: 380V AC
46: 400/440V AC	48: 400/440V AC
486: 480V AC (incandescent only)	488: 480V AC

- Specify a lens/LED color code in place of ② in the Type No. Use the white lens (W) for LED pure white illumination.
- Full voltage types do not contain a lamp. Order LED or incandescent lamps separately. For lamps, see page 63.
- LED illuminated transformer and DC-DC converter types contain an LED lamp: LSTD-6② or LETD-6② (rated voltage 6V AC/DC).
- Incandescent illuminated transformer types contain an incandescent lamp: LS-6 (1W, 6V AC/DC) or LE-8 (2W, 18V AC/DC).

Dimensions

• Full Voltage Type

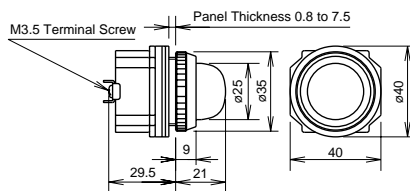

• Transformer Type

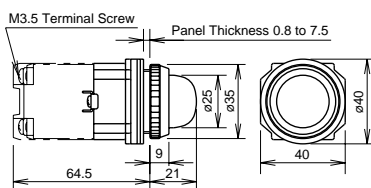

All dimensions in mm.

ø30 Diecast Zinc Series Illuminated Pushbuttons ø30

Round Extended Illuminated Pushbuttons

Shape	Lamp Receptacle	Operation Type	Lamp	Input Type	Contact	Type No.	Applicable Lamp	
Round Extended ALD2 AOLD2 	BA9S	Momentary	Without Lamp	Full Voltage	1NO-1NC	ALD29911N②	LSTD LS (1W)	
					2NO	ALD29920N②		
					2NC	ALD29902N②		
			LED	Transformer	1NO-1NC	ALD2③11DN②	LSTD-6②	
					2NO	ALD2③20DN②		
					2NC	ALD2③02DN②		
		Incandescent	Transformer	1NO-1NC	ALD2③11N②	LS-6		
				2NO	ALD2③20N②			
				2NC	ALD2③02N②			
		Maintained	Without Lamp	Full Voltage		1NO-1NC	AOLD29911N②	LSTD LS (1W)
						2NO	AOLD29920N②	
						2NC	AOLD29902N②	
LED	Transformer		1NO-1NC	AOLD2③11DN②	LSTD-6②			
			2NO	AOLD2③20DN②				
			2NC	AOLD2③02DN②				
Incandescent	Transformer	1NO-1NC	AOLD2③11N②	LS-6				
		2NO	AOLD2③20N②					
		2NC	AOLD2③02N②					

• Color Code and Operating Voltage Code

② Lens/LED Color Code	② Lens Color Code	③ Operating Voltage Code
LED Illuminated Type	Incandescent Illuminated Type	
Specify a lens/LED color code in place of ② in the Type No. A: amber G: green PW: pure white R: red S: blue W: white Y: yellow Use the white lens (W) for LED pure white illumination.	Specify a lens color code in place of ② in the Type No. A: amber C: clear G: green R: red S: blue W: white	Specify an operating voltage code in place of ③ in the Type No. 16: 100/110V AC 116: 115V AC 126: 120V AC 26: 200/220V AC 236: 230V AC 246: 240V AC 386: 380V AC 46: 400/440V AC 486: 480V AC (incandescent only)

- Full voltage types do not contain a lamp. Order LED or incandescent lamps separately. For lamps, see page 63.
- LED illuminated transformer types contain an LED lamp (LSTD-6②, rated voltage 6V AC/DC).
- Incandescent illuminated transformer types contain an incandescent lamp (LS-6, rated voltage 6V AC/DC, 1W).

Dimensions

• ALD2/AOLD2 Full Voltage

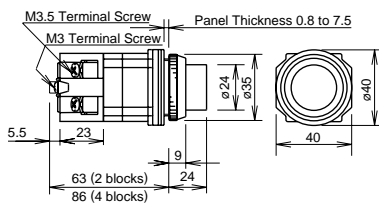

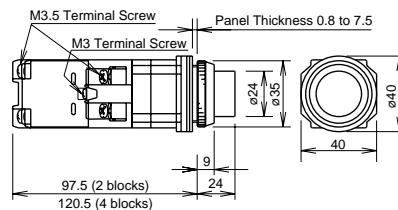

• ALD2/AOLD2 BA9S/Transformer



All dimensions in mm.

ø30 ø30 Diecast Zinc series Illuminated Pushbuttons

Round Extended with Full Shroud Illuminated Pushbuttons

Shape	Lamp Receptacle	Operation Type	Lamp	Input Type	Contact	Type No.	Applicable Lamp
Round Extended with Full Shroud ALFD2 AOLFD2  	BA9S	Momentary	Without Lamp	Full Voltage	1NO-1NC	ALFD29911N②	LSTD LS (1W)
					2NO	ALFD29920N②	
					2NC	ALFD29902N②	
			LED	Transformer	1NO-1NC	ALFD2③11DN②	LSTD-6②
					2NO	ALFD2③20DN②	
					2NC	ALFD2③02DN②	
		Incandescent	Transformer	1NO-1NC	ALFD2③11N②	LS-6	
				2NO	ALFD2③20N②		
				2NC	ALFD2③02N②		
		Maintained	Without Lamp	Full Voltage	1NO-1NC	AOLFD29911N②	LSTD LS (1W)
					2NO	AOLFD29920N②	
					2NC	AOLFD29902N②	
LED	Transformer		1NO-1NC	AOLFD2③11DN②	LSTD-6②		
			2NO	AOLFD2③20DN②			
			2NC	AOLFD2③02DN②			
Incandescent	Transformer	1NO-1NC	AOLFD2③11N②	LS-6			
		2NO	AOLFD2③20N②				
		2NC	AOLFD2③02N②				

• Color Code and Operating Voltage Code

② Lens/LED Color Code	② Lens Color Code	③ Operating Voltage Code
LED Illuminated Type	Incandescent Illuminated Type	
Specify a lens/LED color code in place of ② in the Type No. A: amber G: green PW: pure white R: red S: blue W: white Y: yellow Use the white lens (W) for LED pure white illumination.	Specify a lens color code in place of ② in the Type No. A: amber C: clear G: green R: red S: blue W: white	Specify an operating voltage code in place of ③ in the Type No. 16: 100/110V AC 116: 115V AC 126: 120V AC 26: 200/220V AC 236: 230V AC 246: 240V AC 386: 380V AC 46: 400/440V AC 486: 480V AC (incandescent only)

- Full voltage types do not contain a lamp. Order LED or incandescent lamps separately. For lamps, see page 63.
- LED illuminated transformer types contain an LED lamp (LSTD-6②, rated voltage 6V AC/DC).
- Incandescent illuminated transformer types contain an incandescent lamp (LS-6, rated voltage 6V AC/DC, 1W)

Dimensions

- ALFD2/AOLFD2 Full Voltage

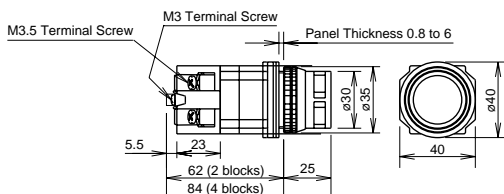



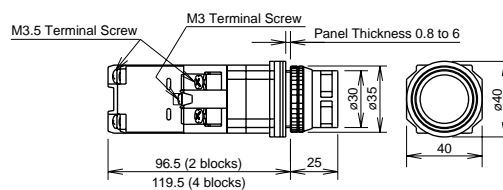

- ALFD2/AOLFD2 Transformer



All dimensions in mm.

ø30 Diecast Zinc Series Illuminated Pushbuttons ø30

Mushroom (ø40) Illuminated Pushbuttons

Shape	Lamp Receptacle	Operation Type	Lamp	Input Type	Contact	Type No.	Applicable Lamp
ø40 Mushroom ALD3 AOLD3    	BA9S	Momentary	Without Lamp	Full Voltage	1NO-1NC	ALD39911DN②	LSTD
					2NO	ALD39920DN②	
					2NC	ALD39902DN②	
			LED	Transformer	1NO-1NC	ALD3③11DN②	LSTD-6②
					2NO	ALD3③20DN②	
					2NC	ALD3③02DN②	
		Maintained	Without Lamp	Full Voltage	1NO-1NC	AOLD39911DN②	LSTD
					2NO	AOLD39920DN②	
					2NC	AOLD39902DN②	
			LED	Transformer	1NO-1NC	AOLD3③11DN②	LSTD-6②
					2NO	AOLD3③20DN②	
					2NC	AOLD3③02DN②	

• Color Code and Operating Voltage Code

② Lens/LED Color Code	③ Operating Voltage Code
LED Illuminated Type	LED Transformer BA9S Type
Specify a lens/LED color code in place of ② in the Type No. A: amber G: green R: red W: white Y: yellow	Specify an operating voltage code in place of ③ in the Type No. 16: 100/110V AC 116: 115V AC 126: 120V AC 26: 200/220V AC 236: 230V AC 246: 240V AC 386: 380V AC 46: 400/440V AC

- Full voltage types do not contain a lamp. Order LED lamps separately. For lamps, see page 63.
- LED illuminated transformer types contain an LED lamp (LSTD-6②, rated voltage 6V AC/DC).

Dimensions

- ALD3/AOLD3
Full Voltage

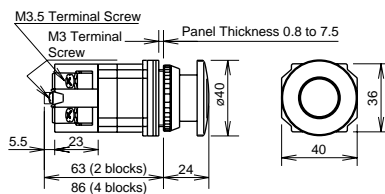

- ALD3/AOLD3
Transformer

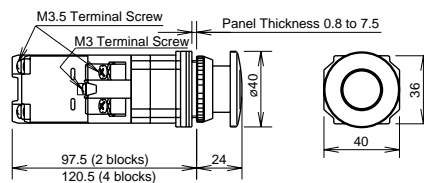

All dimensions in mm.

ø30 ø30 Diecast Zinc series Illuminated Pushbuttons

Mushroom Pushlock Turn Reset Types

Shape	Lamp Receptacle	Lamp	Input Type	Contact	Type No.	Applicable Lamp
Mushroom Pushlock Turn Reset AVLD3 AVLDE3 	BA9S	Without Lamp	Full Voltage	1NO-1NC	AVLD39911NR	LSTD LS (1W)
				2NO	AVLD39920NR	
				2NC	AVLD39902NR	
		LED	Transformer	1NO-1NC	AVLD3③11DNR	LSTD-6②
				2NO	AVLD3③20DNR	
				2NC	AVLD3③02DNR	
	Incandescent	Transformer	1NO-1NC	AVLD3③11NR	LS-6	
			2NO	AVLD3③20NR		
			2NC	AVLD3③02NR		
	E12	Without Lamp	Full Voltage	1NO-1NC	AVLDE39911NR	LETD LE (2W)
				2NO	AVLDE39920NR	
				2NC	AVLDE39902NR	
LED		Transformer	1NO-1NC	AVLDE3③11DNR	LETD-6②	
			2NO	AVLDE3③20DNR		
			2NC	AVLDE3③02DNR		
Incandescent	Transformer	1NO-1NC	AVLD3③11NR	LE-8		
		2NO	AVLD3③20NR			
		2NC	AVLD3③02NR			

• Operating Voltage Code

③ Operating Voltage Code	
LED Transformer BA9S and E12 Types Incandescent Transformer BA9S Type	Incandescent Transformer E12 Type
16: 100/110V AC	18: 100/110V AC
116: 115V AC	118: 115V AC
126: 120V AC	128: 120V AC
26: 200/220V AC	28: 200/220V AC
236: 230V AC	238: 230V AC
246: 240V AC	248: 240V AC
386: 380V AC	388: 380V AC
46: 400/440V AC	48: 400/440V AC
486: 480V AC (incandescent only)	488: 480V AC

- Color code: R (red)
- Full voltage types do not contain a lamp. Order LED or incandescent lamps separately. For lamps, see page 63.
- LED illuminated transformer types contain an LED lamp (LSTD-6②, rated voltage 6V AC/DC).
- Incandescent illuminated transformer types contain an incandescent lamp (LS-6, rated voltage 6V AC/DC, 1W)
- **Pushlock Turn Reset:** Lens is maintained when pressed and is reset when turned clockwise. Red lens only.
- Note: AVLD3 and AVLDE3 pushlock turn reset switches cannot be used as emergency stop switches. When emergency stop switches are required, use the HN1E series emergency stop switches (ISO 13850 and IEC 60947-5-5 compliant).

Dimensions

• AVLD3 BA9S/Full Voltage

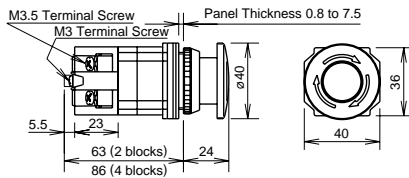

• AVLD3 BA9S/Transformer

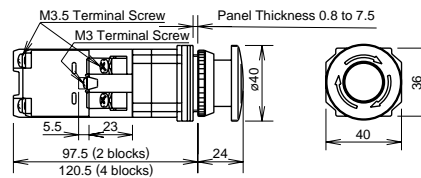

• AVLDE3 E12/Full Voltage

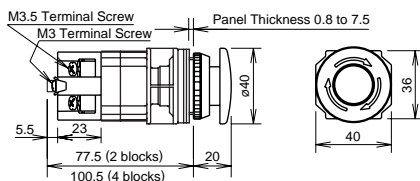



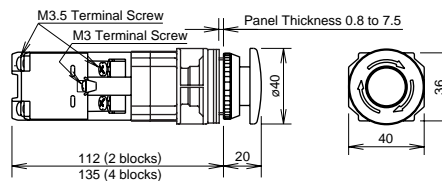







• AVLD3/AVLDE3 E12/Transformer



All dimensions in mm.

ASD Selector Switches (Knob Operator Type)

No. of Positions	Shape		ASD							
	Contact Arrangement Chart				  					
90° 2-position	Contact Code (ASD)	Contact Block		Operator Position		Maintained	Spring Return from Right	Spring Return from Left		
		Mounting Position	Type	L	R					
	10 (1NO)	1	NO		●	ASD210N	ASD2110N	ASD2210N *	—	
		2	Dummy							
	11 (1NO-1NC)	1	NO		●	ASD211N	ASD2111N	ASD2211N *		
		2	NC	●						
	20 (2NO)	1	NO		●	ASD220N	ASD2120N	ASD2220N *		
		2	NO		●					
	22 (2NO-2NC)	1	NO		●	ASD222N	ASD2122N	ASD2222N *		
		2	NC	●						
3		NO		●						
4		NC	●							
45° 3-position	Contact Code (ASD)	Contact Block		Operator Position			Maintained	Spring Return from Right	Spring Return from Left	Spring Return Two-way
		Mounting Position	Type	L	C	R				
	20 (2NO)	1	NO	●			ASD320N	ASD3120N	ASD3220N	ASD3320N
		2	NO			●				
	40 (4NO)	1	NO	●			ASD340N	ASD3140N	ASD3240N	ASD3340N
		2	NO			●				
		3	NO	●						
		4	NO			●				
	22 (2NO-2NC)	1	NO	●			ASD322N	ASD3122N	ASD3222N	ASD3322N
		2	NO			●				
		3	NC			●				
		4	NC	●						
	02 (2NC)	1	NC			●	ASD302N	ASD3102N	ASD3202N	ASD3302N
		2	NC	●						
	04 (4NC)	1	NC			●	ASD304N	ASD3104N	ASD3204N	ASD3304N
		2	NC	●						
3		NC			●					
4		NC	●							

- Knob: Black
- Round bezel (metal): Chrome-plated
- Selector switches with one contact block contain a dummy block.
- On the 2-position selector switches marked with * above, the contact operation is reversed as follows.

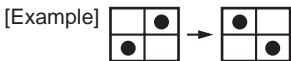

• Contact Block Mounting Position and Contact Arrangement Chart

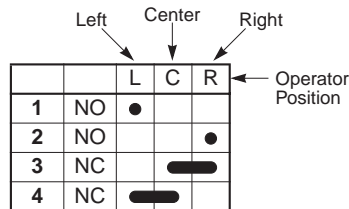



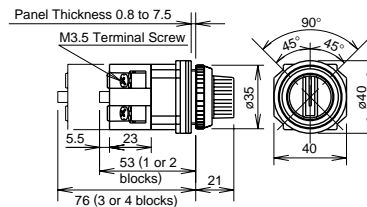







• Dimensions



All dimensions in mm.

ø30 ø30 Diecast Zinc series Selector Switches

ASD Selector Switches (Lever Operator Type)

No. of Positions	Shape		ASD*L							
	Contact Arrangement Chart				  					
90° 2-position	Contact Code (ASD)	Contact Block		Operator Position			Maintained	Spring Return from Right	Spring Return from Left	
		Mounting Position	Type	L	R					
	10 (1NO)	1	NO		●		ASD2L10N	ASD21L10N	ASD22L10N *	
		2	Dummy							
	11 (1NO-1NC)	1	NO		●		ASD2L11N	ASD21L11N	ASD22L11N *	
		2	NC	●						
	20 (2NO)	1	NO		●		ASD2L20N	ASD21L20N	ASD22L20N *	
		2	NO		●					
	22 (2NO-2NC)	1	NO		●		ASD2L22N	ASD21L22N	ASD22L22N *	
		2	NC	●						
		3	NO		●					
		4	NC	●						
45° 3-position	Contact Code (ASD)	Contact Block		Operator Position			Maintained	Spring Return from Right	Spring Return from Left	Spring Return Two-way
		Mounting Position	Type	L	C	R				
	20 (2NO)	1	NO	●			ASD3L20N	ASD31L20N	ASD32L20N	ASD33L20N
		2	NO			●				
	40 (4NO)	1	NO	●			ASD3L40N	ASD31L40N	ASD32L40N	ASD33L40N
		2	NO			●				
		3	NO	●						
		4	NO			●				
	22 (2NO-2NC)	1	NO	●			ASD3L22N	ASD31L22N	ASD32L22N	ASD33L22N
		2	NO			●				
		3	NC			■				
		4	NC	■						
	02 (2NC)	1	NC			■	ASD3L02N	ASD31L02N	ASD32L02N	ASD33L02N
		2	NC	■						
	04 (4NC)	1	NC			■	ASD3L04N	ASD31L04N	ASD32L04N	ASD33L04N
		2	NC	■						
		3	NC			■				
		4	NC	■						

- Lever: Black
- Round bezel (metal): Chrome-plated
- Selector switches with one contact block contain a dummy block.
- On the 2-position selector switches marked with * above, the contact operation is reversed as follows.

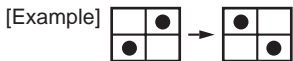

• Contact Block Mounting Position and Contact Arrangement Chart



		Left	Center	Right	
		L	C	R	Operator Position
1	NO	●			
2	NO			●	
3	NC			■	
4	NC	■			

• Dimensions

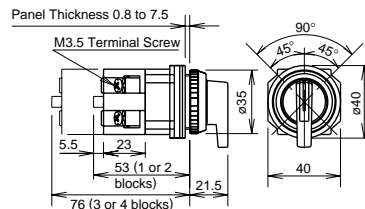

All dimensions in mm.

ASD Key Selector Switches

No. of Positions	Shape		ASD*K		Contact Arrangement Chart					
	UL LISTED	SP	CE							
90° 2-position	Contact Code (ASD)	Contact Block		Operator Position		Maintained	Spring Return from Right	Spring Return from Left		
		Mounting Position	Type	L	R					
	10 (1NO)	1	NO		●	ASD2K10N	ASD21K10N	ASD22K10N *	—	
		2	Dummy							
	11 (1NO-1NC)	1	NO		●	ASD2K11N	ASD21K11N	ASD22K11N *		
		2	NC	●						
	20 (2NO)	1	NO		●	ASD2K20N	ASD21K20N	ASD22K20N *		
		2	NO		●					
	22 (2NO-2NC)	1	NO		●	ASD2K22N	ASD21K22N	ASD22K22N *		
		2	NC	●						
3		NO		●						
4		NC	●							
45° 3-position	Contact Code (ASD)	Contact Block		Operator Position			Maintained	Spring Return from Right	Spring Return from Left	Spring Return Two-way
		Mounting Position	Type	L	C	R				
	20 (2NO)	1	NO	●			ASD3K20N	ASD31K20N	ASD32K20N	ASD33K20N
		2	NO			●				
	40 (4NO)	1	NO	●			ASD3K40N	ASD31K40N	ASD32K40N	ASD33K40N
		2	NO			●				
		3	NO	●						
		4	NO			●				
	22 (2NO-2NC)	1	NO	●			ASD3K22N	ASD31K22N	ASD32K22N	ASD33K22N
		2	NO			●				
		3	NC			●				
		4	NC	●						
	02 (2NC)	1	NC			●	ASD3K02N	ASD31K02N	ASD32K02N	ASD33K02N
		2	NC	●						
	04 (4NC)	1	NC			●	ASD3K04N	ASD31K04N	ASD32K04N	ASD33K04N
		2	NC	●						
3		NC			●					
4		NC	●							

- Cylinder: Black
- Round bezel (metal): Chrome-plated
- On the spring-returned types, the keys can be released only from the maintained positions. On the maintained types, the key can be released from every position. Key retained positions are also available. See page 12.
- Key selector switches are supplied with two standard keys.
- Key selector switches with one contact block contain a dummy block.
- On the 2-position selector switches marked with * above, the contact operation is reversed as follows.

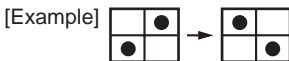

• Contact Block Mounting Position and Contact Arrangement Chart

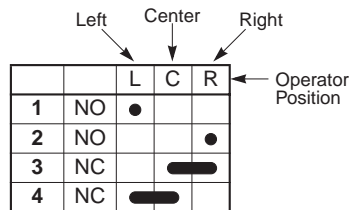
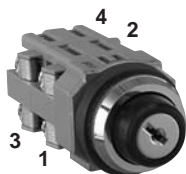

• Dimensions

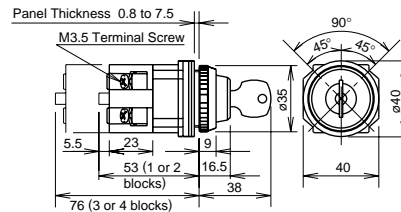





All dimensions in mm.

ø30 ø30 Diecast Zinc series Illuminated Selector Pushbuttons

Illuminated Selector Switches

90° 2-position

Shape		ASLD (Base BA9S)							
Contact Arrangement Chart		   							
Contact Code	Contact Block		Operator Position		Lamp	Input Type	Maintained	Spring Return from Right	Spring Return from Left
	Mounting Position	Type	L	R			L	R	L
11 (1NO-1NC)	1	NO		●	Without Lamp	Full Voltage	ASLD29911N②	ASLD219911N②	ASLD229911N② *
	2	NC	●		LED	Transformer	ASLD2③11DN②	ASLD21③11DN②	ASLD22③11DN② *
					Incandescent	Transformer	ASLD2③11N②	ASLD21③11N②	ASLD22③11N② *
20 (2NO)	1	NO		●	Without Lamp	Full Voltage	ASLD29920N②	ASLD219920N②	ASLD229920N② *
	2	NO		●	LED	Transformer	ASLD2③20DN②	ASLD21③20DN②	ASLD22③20DN② *
					Incandescent	Transformer	ASLD2③20N②	ASLD21③20N②	ASLD22③20N② *
22 (2NO-2NC)	1	NO		●	Without Lamp	Full Voltage	ASLD29922N②	ASLD219922N②	ASLD229922N② *
	2	NC	●						
	3	NO		●	LED	Transformer	ASLD2③22DN②	ASLD21③22DN②	ASLD22③22DN② *
	4	NC	●						
				Incandescent	Transformer	ASLD2③22N②	ASLD21③22N②	ASLD22③22N② *	

• Color Code and Operating Voltage Code

LED Illuminated Type	Incandescent Illuminated Type	③ Operating Voltage Code
② Lens/LED Color Code	② Lens Color Code	
Specify a lens/LED color code in place of ② in the Type No.	Specify a lens color code in place of ② in the Type No.	Specify an operating voltage code in place of ③ in the Type No.
A: amber G: green R: red S: blue W: white Y: yellow	A: amber G: green R: red S: blue W: white	16: 100/110V AC 156: 115V AC 136: 120V AC 26: 200/220V AC 236: 230V AC 256: 240V AC 386: 380V AC 46: 400/440V AC 486: 480V AC (incandescent only)

- Full voltage types do not contain a lamp. Order LED or incandescent lamps separately. For lamps, see page 63.
- LED illuminated transformer types contain an LED lamp (LSTD-6②), rated voltage 6V AC/DC).
- Incandescent illuminated transformer types contain an incandescent lamp (LS-6, rated voltage 6V AC/DC).
- On the 2-position selector switches marked with * above, the contact operation is reversed as follows.

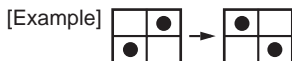

• Contact Block Mounting Position and Contact Arrangement Chart

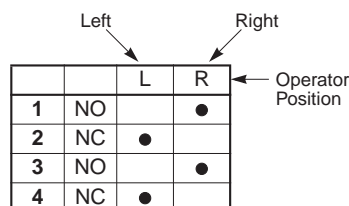
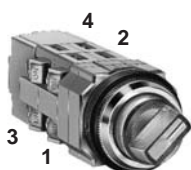

• Dimensions

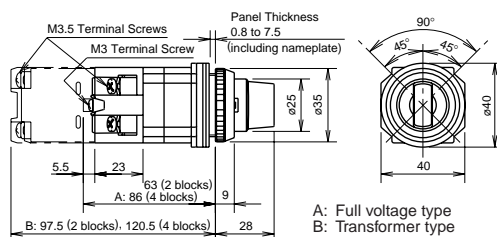

All dimensions in mm.

ø30 Diecast Zinc series Illuminated Selector Pushbuttons ø30

Illuminated Selector Switches

45° 3-position

Contact Code	Contact Block		Operator Position			Lamp Input Type	Maintained	Spring Return from Right	Spring Return from left	Spring Return Two-way
	Mounting Position	Type	L	C	R		L C R	L C R	L C R	L C R
20 (2NO)	1	NO	●			Without Lamp Full Voltage	ASLD39920N②	ASLD319920N②	ASLD329920N②	ASLD339920N②
	2	NO			●	LED Transformer	ASLD3③20DN②	ASLD31③20DN②	ASLD32③20DN②	ASLD33③20DN②
						Incandescent Transformer	ASLD3③20N②	ASLD31③20N②	ASLD32③20N②	ASLD33③20N②
02 (2NC)	1	NC		■		Without Lamp Full Voltage	ASLD39902N②	ASLD319902N②	ASLD329902N②	ASLD339902N②
	2	NC	■			LED Transformer	ASLD3③02DN②	ASLD31③02DN②	ASLD32③02DN②	ASLD33③02DN②
						Incandescent Transformer	ASLD3③02N②	ASLD31③02N②	ASLD32③02N②	ASLD33③02N②
22 (2NO-2NC)	1	NO	●			Without Lamp Full Voltage	ASLD39922N②	ASLD319922N②	ASLD329922N②	ASLD339922N②
	2	NO			●	Without Lamp Full Voltage	ASLD39922N②	ASLD319922N②	ASLD329922N②	ASLD339922N②
	3	NC		■		LED Transformer	ASLD3③22DN②	ASLD31③22DN②	ASLD32③22DN②	ASLD33③22DN②
	4	NC	■			LED Transformer	ASLD3③22DN②	ASLD31③22DN②	ASLD32③22DN②	ASLD33③22DN②
					Incandescent Transformer	ASLD3③22N②	ASLD31③22N②	ASLD32③22N②	ASLD33③22N②	
40 (4NO)	1	NO	●			Without Lamp Full Voltage	ASLD39940N②	ASLD319940N②	ASLD329940N②	ASLD339940N②
	2	NO			●	Without Lamp Full Voltage	ASLD39940N②	ASLD319940N②	ASLD329940N②	ASLD339940N②
	3	NO	●			LED Transformer	ASLD3③40DN②	ASLD31③40DN②	ASLD32③40DN②	ASLD33③40DN②
	4	NO			●	LED Transformer	ASLD3③40DN②	ASLD31③40DN②	ASLD32③40DN②	ASLD33③40DN②
					Incandescent Transformer	ASLD3③40N②	ASLD31③40N②	ASLD32③40N②	ASLD33③40N②	
04 (4NC)	1	NC		■		Without Lamp Full Voltage	ASLD39904N②	ASLD319904N②	ASLD329904N②	ASLD339904N②
	2	NC	■			Without Lamp Full Voltage	ASLD39904N②	ASLD319904N②	ASLD329904N②	ASLD339904N②
	3	NC		■		LED Transformer	ASLD3③04DN②	ASLD31③04DN②	ASLD32③04DN②	ASLD33③04DN②
	4	NC	■			LED Transformer	ASLD3③04DN②	ASLD31③04DN②	ASLD32③04DN②	ASLD33③04DN②
					Incandescent Transformer	ASLD3③04N②	ASLD31③04N②	ASLD32③04N②	ASLD33③04N②	

• Color Code and Operating Voltage Code

LED Illuminated Type	Incandescent Illuminated Type	③ Operating Voltage Code
② Lens/LED Color Code	② Lens Color Code	
Specify a lens/LED color code in place of ② in the Type No. A: amber G: green R: red S: blue W: white Y: yellow	Specify a lens color code in place of ② in the Type No. A: amber G: green R: red S: blue W: white	Specify an operating voltage code in place of ③ in the Type No. 16: 100/110V AC 156: 115V AC 136: 120V AC 26: 200/220V AC 236: 230V AC 256: 240V AC 386: 380V AC 46: 400/440V AC 486: 480V AC (incandescent only)

- Full voltage types do not contain a lamp. Order LED or incandescent lamps separately. For lamps, see page 63.
- LED illuminated transformer types contain an LED lamp (LSTD-6②, rated voltage 6V AC/DC).
- Incandescent illuminated transformer types contain an incandescent lamp (LS-6, rated voltage 6V AC/DC).

• Contact Block Mounting Position and Contact Arrangement Chart



	Left	Center	Right	Operator Position
	L	C	R	
1	NO	●		
2	NO		●	
3	NC		■	
4	NC	■		

• Dimensions

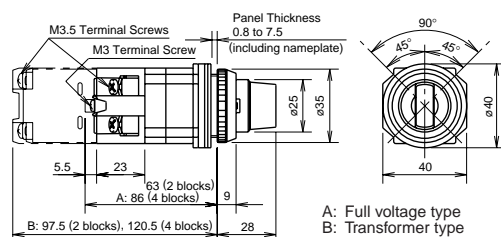





A: Full voltage type
B: Transformer type

All dimensions in mm.

ø30 ø30 Diecast Zinc series Selector Pushbutton Switches

Ring Operator Type / Lever Operator Type Selector Pushbuttons

Shape	Contact Code	Circuit Code	Contact Block		Ring/Lever				Ring Operator	Lever Operator	Color	
					Pushbutton							
			Mounting Position	Type	Normal	Push	Normal	Push	Type No.	Type No.		
   	11 (1NO-1NC)	A03	1	NO		●		●	ASBD211N-A03①	ASBD2L11N-A03①	B: black G: green R: red Y: yellow	
			2	NC	●							
		G03	1	NO		●			Blocked	ASBD211N-G03①		ASBD2L11N-G03①
			2	NC	●		●					
		A08	1	NO		●		●	ASBD222N-A08①	ASBD2L22N-A08①		
			2	NC	●							
	3		NO		●		●					
	4		NC	●								
	C10	1	NO		●		●	ASBD222N-C10①	ASBD2L22N-C10①			
		2	NO				●					
		3	NC	●								
		4	NC	■								
	D10	1	NO		●			ASBD222N-D10①	ASBD2L22N-D10①			
		2	NO				●					
		3	NC	●		■						
		4	NC	■		●						
	E10	1	NO		●			ASBD222N-E10①	ASBD2L22N-E10①			
		2	NO				●					
		3	NC			■						
		4	NC	■								
F10	1	NO		●		●	ASBD222N-F10①	ASBD2L22N-F10①				
	2	NO		●								
	3	NC			●							
	4	NC	●									
G10	1	NO		●			ASBD222N-G10①	ASBD2L22N-G10①				
	2	NO		●		Blocked						
	3	NC	●		●							
	4	NC	●		●							

- Specify a button color code in place of ① in the Type No.
- Ring/Lever (Metal): Chrome-plated

Notes :

1. Circuit Code G: The pushbutton does not operate when the ring or lever operator is turned to the right position.
2. Circuit Codes E and F: The right and left NC contact blocks on circuit code E or F may overlap each other while turning the ring or lever operator. The NO and NC contact blocks on circuit code F may overlap each other while pressing the button.
3. When using the selector pushbutton, do not turn the ring or lever operator with the pushbutton depressed. Otherwise, damage or failure may be caused.
4. When installing the lever operator, make sure that the lever is not in the horizontal position. Otherwise, shock resistance may be degraded.

• Contact Block Mounting Position and Contact Arrangement Chart



	Normal	Push
1		●
2	●	
3		●
4	●	

• Dimensions

Ring Operator
(90° 2-position)
ASBD2

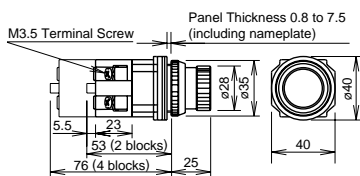

Lever Operator
(90° 2-position)
ASBD2L

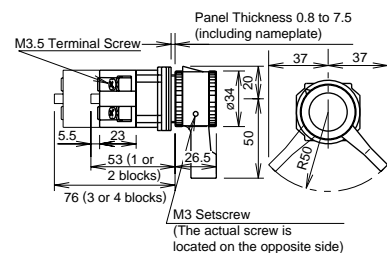

ø30 Diecast Zinc Series Accessories and Replacement Parts ø30

Accessories (For Diecast Zinc Series Only)

For other accessories, see pages 55 to 63.

Shape	Material	Type No.	Ordering Type No.	Package Quantity	Description
<p>Flush (Octagonal) Extended (Octagonal)</p>	Chrome-plated	OG-81	OG-81PN02	2	<ul style="list-style-type: none"> • Cannot be used with half-shrouds.
		OG-82	OG-82	1	
<p>Spare Key</p>	Metal	TW-SK-0	TW-SK-0PN02	2	<ul style="list-style-type: none"> • For key selector switches

Maintenance Parts (For Diecast Zinc Series Only)

Shape	Specification	Type No.	Ordering Type No.	Package Quantity	Description
<p>① Flush ② Extended ③ Mushroom</p>	Plastic	① ABN1BN-①	ABN1BN-①PN05	5	Specify a color code in place of ①. B (black), G (green), R (red), S (blue), W (white), Y (yellow) • Above colors are used for ø30 diecast zinc control units (light colored operator units).
		② ABN2BN-①	ABN2BN-①PN05	5	
		③ ABN3BN-①	ABN3BN-①PN02	2	
<p>Dummy Block</p>	Plastic	BST-D	BST-DPN10	10	<ul style="list-style-type: none"> • Used for 1NO or 1NC contact blocks. • Snaps on to the operator unit.
<p>① Knob ② Lever ③ Color Insert</p>	Plastic	① ASNHT-①	ASNHT-①PN02	2	Specify a color code in place of ①. B (blue), G (green), R (red)
		② ASNHL-①	ASNHL-①PN02		
	Color Insert	③ TW-HC1①	TW-HC1①PN05	5	Specify a color code in place of ①. B (black), G (green), R (red), S (blue), W (white), Y (yellow)

Safety Precautions

- Turn off the power to the ø30 diecast zinc control units before starting installation, removal, wiring, maintenance, and starting installation, removing, wiring, maintenance, and inspection of the products. Failure to turn power off may cause electrical shocks or fire hazard.
- To avoid a burn on your hand, use the lamp holder tool when replacing lamps.
- For wiring, use wires of a proper size to meet the voltage and current requirements. Tighten the M3.5 terminal screws to a tightening torque of 1.0 to 1.3 N·m. Failure to tighten terminal screws may cause overheat and fire.

Instructions

Tightening Torque for Terminal Screws

Tighten the M3.5 terminal screws to a torque of 1.0 to 1.3 N·m.

Replacement of Lamps

Lamps can be replaced by using the lamp holder tool (OR-55) from the front of the panel.

- How to remove
To remove, slip the lamp holder tool onto the lamp head lightly. Then push slightly, and turn the lamp holder tool counterclockwise.
- How to install
To install, insert the lamp head into the lamp holder tool. Place the pins on the lamp base to the grooves in the lamp socket. Inset the lamp and turn it clockwise.

Installation of LED Illuminated Units

- When using full voltage type LED illuminated units, provide protection against electrical noise, if necessary. See page 65 for notes on LED illuminated units.



OR-55



Specifications and other descriptions in this catalog are subject to change without notice.



IDEC IZUMI CORPORATION

7-31, Nishi-Miyahara 1-Chome, Yodogawa-ku, Osaka 532-8550, Japan
Tel: +81-6-6398-2571, Fax: +81-6-6392-9731
www.idec.com

IDEC CORPORATION (USA)

1175 Elko Drive, Sunnyvale, CA 94089-2209, USA
Tel: +1-408-747-0550, Toll Free: (800) 262-IDECE, Fax: +1-408-744-9055
E-mail: opencontact@idec.com, www.idec.com

IDEC CANADA LIMITED

Unit 22-151, Brunel Road Mississauga, Ontario, L4Z 1X3, Canada
Tel: +1-905-890-8561, Toll Free: (888) 317-4332, Fax: +1-905-890-8562

IDEC ELECTRONICS LIMITED

Unit 2, Beechwood, Chineham Business Park, Basingstoke, Hampshire
RG24 8WA, UK
Tel: +44-1256-321000, Fax: +44-1256-327755
E-mail: idec@uk.idec.com

IDEC ELEKTROTECHNIK GmbH

Wendenstrasse 331, D-20537 Hamburg, Germany
Tel: +49-40-25 30 54 10, Fax: +49-40-25 30 54 24
E-mail: service@idec.de, www.idec.de

IDEC AUSTRALIA PTY. LTD.

2/3 Macro Court, Rowville, Victoria 3178, Australia
Toll Free: 1-800-68-4332, Fax: +61-3-9763-3255
E-mail: sales@au.idec.com

IDEC IZUMI ASIA PTE. LTD.

No. 31, Tannery Lane #05-01, Dragon Land Building, Singapore 347788
Tel: +65-6746-1155, Fax: +65-6844-5995
E-mail: generalinfo@idecasia.com.sg

IDEC IZUMI (H.K.) CO., LTD.

Unit 1505-07, DCH Commercial Centre No. 25, Westlands Road,
Quarry Bay, Hong Kong
Tel: +852-2803-8989, Fax: +852-2565-0171
E-mail: idec@idechk.com

IDEC IZUMI (Shanghai) Co., Ltd.

Room E, 15F, Majesty Building, No. 138 Pudong Avenue,
Shanghai 200120, P.R.C.
Tel: +86-21-5887-9181, Fax: +86-21-5887-8930
E-mail: idec@cn.idec.com

IDEC TAIWAN CORPORATION

8F, No. 79, Hsin Tai Wu Road, Sec. 1, Hsi-Chih, Taipei County, Taiwan
Tel: +886-2-2698-3929, Fax: +886-2-2698-3931
E-mail: service@idectwn.com.tw