



Table of Contents



LINKOSITY®
Power Components



Control Connectors



DRUB and PANEL-SAFE®





Product	Page
LINKOSITY® Power Components	
Power Components	I-2
Control Integration Components	I-3
Power System Distribution Assemblies	I-4
MotorQuick® Disconnect Switches	I-7
Mini-Quick® Control Connectors	I-8
2-6 Pole Plugs and Receptacles	I-9
7-12 Pole Plugs and Receptacles	I-13
Field Attachable Connectors - Screw Terminal Style	I-17
Micro-Quick® Control Connectors	I-18
Single Key 3-5 Pole Plugs and Receptacles	I-19
Dual Key 2-6 Pole Plugs and Receptacles	I-23
Field Attachable Connectors - Screw Terminal Style	I-27
Field Attachable Connectors - IDC Style	I-28
Nano-Quick® Control Connectors	I-29
3-4 Pole Plugs and Receptacles	I-30
Field Attachable Connectors - IDC Style	I-32

Product	Page
Signal-Quick® Sensor Mounting Accessories	
Cushioned Sensor Mounts	I-33
Flat and Right Angle Adjustable and Fixed Brackets	I-34
End Caps and Block Mounts	I-35
Universal Aiming Brackets	I-36
CableTrak® Hose and Cable Carrier System	I-37
CableTrak® Kit with and without Brackets	I-38
Accessories	I-39
Mounting Options and Specifications	I-40
DIN Rail Utility Box	
Power and Data	I-41
PANEL-SAFE®	
Power and Data Access Ports	I-43
HI-Impact	
Industrial Ethernet Connector and Harsh Environment Connectors	I-44



Cables and Receptacles - Power Components

Device Type	Ratings	Wires	Conductor Colors**	Length (FT)
 PH = Double Ended Cable with Male/Female Straight PM = Male Single Ended Straight PN = Male Single Ended 90° PF = Female Single Ended Straight PG = Female Single Ended 90° PQ = Double Ended Cable with Female 90° PR = Double Ended Cable with Male 90° PS = Double Ended Cable with (2) 90° Connectors  RF = Female Receptacle*  RM = Male Receptacle (Inlet)*	20 = 20A up to 600V	02 03 04 05	PA = Green/Yellow Black (all others) PB = Green/Yellow White Black (all others)	001 = 1' 005 = 5' 010 = 10' 015 = 15' 020 = 20' 025 = 25' 030 = 30' 035 = 35' 040 = 40' 045 = 45' 050 = 50'
	20A up to 600V Specialty construction (Includes isolated ground on 6 wire and #10 AWG super neutral conductor on 5 and 6 wire devices, PB color code only)	03 04 05 06		
	30 = 30A up to 600V	04		

Example: PH

23

06

PB









005

Note: *1/2" NPT rear thread.

**Other color codes available upon request.

***Two wire only.

Configurations (Male face view shown, female view is opposite)

20 AMP				
20A SNIG (with super neutral and IG)				
30 AMP				



TX2304002304T00

Tees

Description	Catalog Number
LINKOSITY® M/F/F Tee, 20A, 2P	TX2002002002T00
LINKOSITY® M/F/F Tee, 20A, 3P	TX2003002003T00
LINKOSITY® M/F/F Tee, 20A, 4P	TX2004002004T00
LINKOSITY® M/F/F Tee, 20A, 5P	TX2005002005T00
LINKOSITY® M/F/F Tee, 20A SNIG, 4P	TX2304002304T00
LINKOSITY® M/F/F Tee, 20A SNIG, 6P	TX2306002306T00
LINKOSITY® M/F/F Tee, 20A SNIG, A Phase Tap	TX2306002304A00
LINKOSITY® M/F/F Tee, 20A SNIG, B Phase Tap	TX2306002304B00
LINKOSITY® M/F/F Tee, 20A SNIG, C Phase Tap	TX2306002304C00
LINKOSITY® M/F/F Tee, 30A, 4P	TX3004003004T00





CCMBC

Closure Caps

Description	For use with Female Receptacle	Male Inlet
20A and 30A Receptacle Closure Cap	CCMBC	CCFBC



Cables and Receptacles - Control Integration Components

Device Type	Ratings	Wires	Conductor Colors**	Length (FT)
 PH = Double Ended Cable with Male/Female Straight PM = Male Single Ended Straight PN = Male Single Ended 90° PF = Female Single Ended Straight PG = Female Single Ended 90° PQ = Double Ended Cable with Female 90° PR = Double Ended Cable with Male 90° PS = Double Ended Cable with (2) 90° Connectors  RF = Female Receptacle*  RM = Male Receptacle (Inlet)*	3A - 2W, 3W 03 = 3A - 4W up to 300V	02 03 04	PA = Green/Yellow Black (all others)	001 = 1' 005 = 5' 010 = 10' 015 = 15' 020 = 20' 025 = 25' 030 = 30' 035 = 35' 040 = 40' 045 = 45' 050 = 50'
	3A - 2W, 3W R3 = 3A - 4W up to 300V	02 03 04		
	10A - 2W, 3W 10A - 4W 10 = 10A - 5W, 6W, 7W 10A - 8W, 9W 7A - 10W, 12W up to 600V	02 03 04 05 06 07 08 09 10 12	PE = All Blue***	

Example: PH

10

06

PB



005

Note: **1/2" NPT rear thread.

**Other color codes available upon request.

***Two wire only.

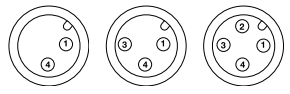
Configurations (Male face view shown, female view is opposite)

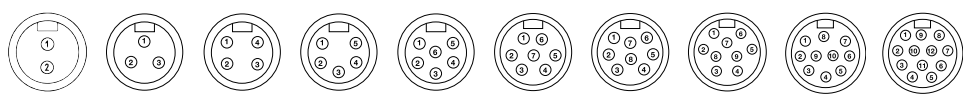
03		Typically used for inputs in DC control circuits
R3*		Typically used for outputs in DC control circuits
10		

Note: *Reverse key.

Splitters/Tees

Description	Catalog Number
LINKOSITY® M/F/F Splitter, 3A/4W	TX0304000304T00
LINKOSITY® M/F/F Tee, 10A, 2 Pole	TX1002001002T00
LINKOSITY® M/F/F Tee, 10A, 3 Pole	TX1003001003T00
LINKOSITY® M/F/F Tee, 10A, 4 Pole	TX1004001004T00
LINKOSITY® M/F/F Tee, 10A, 5 Pole	TX1005001005T00
LINKOSITY® M/F/F Tee, 10A, 6 Pole	TX1006001006T00



TX1004001004T00

Closure Caps

Description	For use with	
	Female Receptacle	Male Inlet
3A Closure Cap	CCM1C	CCF1C
10A Closure Cap, 2, 3, 4, 4, 5 and 6 Pole	CCMAC	CCFAC
10A Closure Cap, 7 and 8 Pole	CCMBC	CCFBC
10A Closure Cap, 9, 10, 12 Pole	CCMCC	CCFCC



CCFAC

Features and Benefits

Power System Distribution Assemblies

- Available with up to 5 receptacles, wide variety of NEMA 5-20 receptacle grades
- Power pass thru option
- 16 gauge sheet metal enclosure ANSI 61 gray powder coat NEMA 1
- Device identification marking
- Versatile mounting provision
- Local or master switch
- LINKOSITY® connection



MSL3L1IGP

Note: Accepts PH2304 series cables.

Straight Blade - UL Type 1

Device Type	Switch Types	# Recepts	Receptacle Type	Receptacle Feature	Pass-thru	Custom Configurations*
M	SL = Switch Local	1	SG = Spec Grade HG = Hospital Grade CR = Corrosion Resistant	IG = Isolated Ground GF = Ground Fault SS = Surge Suppression 00 = Standard	P = Pass-thru** 0 = No Pass-thru	D = 2 Circuit A = A Phase B = B Phase C = C Phase
	SM = Switch Master	2				
	00 = No Switch	3				
		4				
		5				

Example: M SL 1 SG 00 P

Twist-Lock® - UL Type 1

Device Type	Switch Types	# Recepts	Receptacle Type	Receptacle Feature	Pass-thru	Custom Configurations*
M	SL = Switch Local	1	L1 = 15A L2 = 20A	IG = Isolated Ground 00 = Standard	P = Pass-thru 0 = No Pass-thru	6 = 250V
	SM = Switch Master	2				
	00 = No Switch	3				
		4				
		5				

Example: M 00 3 L1 IG 0

Note: Local switches control all receptacles in a box. Master switches control local and downstream receptacles. Consult factory for alternate wiring schemes.

*Consult factory for wiring specifications and connecting cables.

**Pass-thru on phase tap boxes are 3Ø.

Switch Only (ON/OFF) - UL Type 1

Device Type	Switch Types	Switch Style	Poles
S	1 = 1 Gang	2W = ON/OFF	1P = Single Pole DP = Two Pole
	2 = 2 Gang		
	3 = 3 Gang		

Example: S 1 2W 1P

Switch Only (4-Way) - UL Type 1

Device Type	Switch Types	Switch Style
S	1 = 1 Gang	4W = 4 Way

Example: S 1 4W

Switch Only (3-Way) - UL Type 1

Device Type	Switch Types	Switch Style	Position
S	1 = 1 Gang	3W = 3 Way	M = Main R = Remote LM = Line to Main LR = Load to Remote

Example: S 1 3W M

Note: For use with Px2304PBxxx series cables.

Features

Receptacle Types	CR	HG	SG	L1
00 Standard	HBL53CM62	HBL8300GY	5362G	HBL4700
IG Isolated Ground	—	—	CR5352IGGY	IG4700A
GF Ground Fault	—	GFRST83GY	GFRST20GY	—
SS Surge Suppression	—	HBL8362GYSA	HBL5362GYSA	—
Switch Types	CR	HG	SG	L1
SL Local ON/OFF	—	—	HBL1221PL	—
SM Master ON/OFF	—	—	HBL1221PL	—



LINKOSITY® Feed - UL Type 3R Rated*

3R Rated Standard Items

Description	Catalog Number
20A 125V Ground Fault	M3R002SGGF0
20A 125V Switched, Spec Grade	M3RSL1SG000
20A 125V Switched, Ground Fault	M3RSL1SGGF0
20A 125V Spec Grade	M3R002SG000
20A 125V Ground Fault, Pass-Thru	M3R002SGGFP
20A 125V Switched, Spec Grade, Pass-Thru	M3RSL1SG00P
20A 125V Switched, Ground Fault Pass-Thru	M3RSL1SGGFP
20A 125V Switched, Ground Fault Pass-Thru	M3R002SG00P

Note: *When cover closed.
Accepts PH2304 series cables.

Device Type	Style	Type	No. of Devices	Device Type	Device Feature	Pass-Thru
M	3R - 3R Lids 3D - 3R Deep Cover	SL - Switch Local	1	SG - Spec Grade	IG - Isolated Ground	P - Pass-Thru
		SM - Switch Master	2	HG - Hospital Grade	GF - Ground Fault	0 - No Pass-Thru
		00 - None		CR - Corrosion Resistant	SI - Surge/IG	
				L1 - 15A Locking	SS - Surge	
					00 - Standard	



LINKOSITY® Feed - UL Type 4X Rated*

4X Rated NEMA Standard Items

Description	Catalog Number
20A 125V Straight Blade	MLWF2010
20A 125V WTSSTL	MLWF2020
20A 125V Straight Blade, Pass-Thru	MLWF201P
20A 125V WTSSTL, Pass-Thru	MLWF202P

Note: *Watertight Safety-Shroud® Twist-Lock® Plug required when in use.
**Straight Blade are UL Type 4X when not in use only.
WTSSTL is an abbreviation for Watertight Safety-Shroud® Twist-Lock®.
Accepts PH2304 series cables.

Device Type	Style	Type	No. of Devices	Device Type	Pass-Thru
M	L - LINKOSITY	WF - Watertight Safety-Shroud Receptacle	2	01 - 20A 125V Straight Blade**	P - Pass-Thru
		WM - Watertight Safety-Shroud Inlet		02 - 20A 125V Twist-Lock	0 - No Pass-Thru
				03 - 20A 250V Twist-Lock	
				04 - 20A 277V Twist-Lock	
				05 - 30A 125V Twist-Lock	
				06 - 30A 250V Twist-Lock	
				07 - 20A 125/250V Twist-Lock	
				08 - 20A 3Ø 250V Twist-Lock	
				09 - 20A 3Ø 480V Twist-Lock	
				10 - 30A 125/250V Twist-Lock	
				11 - 30A 3Ø 250V Twist-Lock	
				12 - 30A 3Ø 480V Twist-Lock	
				13 - 30A 3Ø 600V Twist-Lock	



All LINKOSITY® - UL Type 4X Rated*

4X Rated LINKOSITY Standard Items

Description	Catalog Number
20A 3W up to 600V, 4 Port	M4L2003PB0
20A 3W up to 600V, 4 Port Pass-Thru	M4L2003PBP

Note: *Closure Cap required when not in use.
Accepts PH2304 series cables.

Device Type	Style	Type	No. of Poles	Conductor Colors	Pass - Thru
M	4L - LINKOSITY	20 - 20A	02	PA - Green/Yellow	P - Pass-Thru
			03	Black (all others)	0 - No Pass-Thru
		23 - 20A Super Neutral Isolated Ground	04		
			05	PB - Green/Yellow	
			06	White	
		30 - 30A		Black (all others)	

Conduit Feed - UL Type 4X Rated*

Conduit Feed Standard Items

Description	Catalog Number
20A 125V Straight Blade	MCWF2010
20A 125V WTSSTL	MCWF2020
20A 250V WTSSTL	MCWF2030
20A 277V WTSSTL	MCWF2040
30A 125V WTSSTL	MCWF2050
30A 250V WTSSTL	MCWF2060
20A 125/250V WTSSTL	MCWF2070
20A 3Ø, 250V WTSSTL	MCWF2080
20A 3Ø, 480V WTSSTL	MCWF2090
30A 125/250V WTSSTL	MCWF2100
30A 3Ø 250V WTSSTL	MCWF2110
30A 3Ø 480V WTSSTL	MCWF2120
30A 3Ø 600V WTSSTL	MCWF2130

Note: *Watertight Safety-Shroud® Twist-Lock® Plug required when in use.
WTSSTL is an abbreviation for Watertight Safety-Shroud® Twist-Lock®.

Device Type	Style	Type	No. of Devices	NEMA Device Type	Pass-Thru
M	C - Conduit Feed	WF - Watertight Safety-Shroud Receptacles	2	01 - 20A 125V Straight Blade	0 - No Pass-Thru
		WM - Watertight Safety-Shroud Inlet		02 - 20A 125V Twist-Lock	
				03 - 20A 250V Twist-Lock	
				04 - 20A 277V Twist-Lock	
				05 - 30A 125V Twist-Lock	
				06 - 30A 250V Twist-Lock	
				07 - 20A 125/250V Twist-Lock	
				08 - 20A 3Ø 250V Twist-Lock	
				09 - 20A 3Ø 480V Twist-Lock	
				10 - 30A 125/250V Twist-Lock	
				11 - 30A 3Ø 250V Twist-Lock	
				12 - 30A 3Ø 480V Twist-Lock	
				13 - 30A 3Ø 600V Twist-Lock	



Replacement Mounting Feet

Description	Catalog Number
For Power Distribution Assemblies.	HBLRFT1^Δ

Note: ^Δ Package of 10 mounting feet and 10 screws.



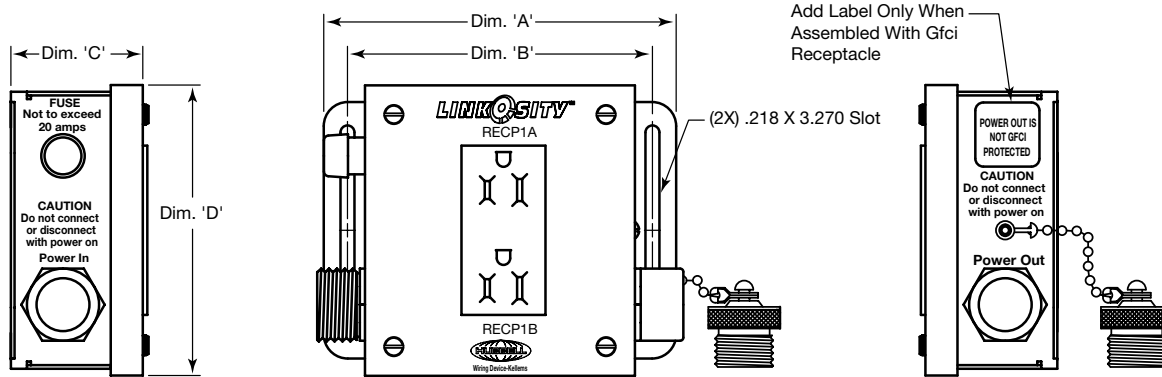

Catalog Number M001****P Shown

Catalog Number	Gangs	Dimension 'A'	Dimension 'B'	Dimension 'C'	Dimension 'D'
M001****P	1	5.50 (139.7)	4.75 (120.7)	2.25 (57.2)	4.53 (115.1)
M002****P	2	7.50 (190.5)	6.75 (171.5)	2.25 (57.2)	4.53 (115.1)
M003****P	3	9.50 (241.3)	8.75 (222.3)	2.25 (57.2)	4.53 (115.1)
M004****P	4	11.50 (292.1)	10.75 (273.1)	2.25 (57.2)	4.53 (115.1)
M005****P	5	13.50 (342.9)	12.75 (323.9)	2.25 (57.2)	4.53 (115.1)

LINKOSITY® Specifications

Certifications

System Level	ETL Classified to NEC
Component Assemblies (PSDA)	UL Listed
Connecting Components	Listed to UL2238 and UL 50
Cable (Up to #22 AWG)	UL 300V Type ITC/PLTC 105°C
Cable (#16 AWG and Up)	UL 600V Type TC-ER, MTW 90°C or ST00W 600V 105°C

Cable Diameter

Amps	Wires	O.D.
20	3	.595 (15.1)
20	4	.645 (16.4)
20	5	.710 (18.0)
20	6	.760 (19.3)
30	4	.710 (18.0)

Performance

Electrical	
Voltage	Up to 600V
Amperage	Up to 30A

Environmental

Connectivity System Components	
Moisture Resistance	UL Type 4, 4X, 12 and 13
Ingress Protection	IP66 Suitability
Flammability	UL94HB Cables/UL94V-0 receptacles

Power System Distribution Assemblies	
Moisture Resistance	NEMA Type 1, Type 3R, Type 4X

Dimensions in Inches (mm)



IP67
SUITABILITY

Housing Design

- Thermoplastic Cover on Plated Steel Base
- NEMA 1 Enclosure
- Pre-wired with LINKOSITY® Components
- Crush and Impact Resistance of MC Cable



HBL1389MQ5

Housing Design

- High Impact Valox® Enclosure
- Type 4X Enclosure
- Permanent Labelless Marking
- Lockable Handle to Meet OSHA Lockout/Tagout Regulations
- Cable Ratings: TC-ER, MTW, STOOW



HBLDS3MQ5

MotorQuick® Disconnect Switches

Type 1 Non-Metallic Enclosure 30A 3 Pole 600V AC	Catalog Number	
HBL1389D with one pre-wired LINKOSITY® female receptacle (load side).	HBL1389MQR	
HBL1389D with 5 foot pre-wired LINKOSITY® female cable (load side).	HBL1389MQ5	
HBL1389D with one pre-wired LINKOSITY® male receptacle (line side) and one pre-wired LINKOSITY® female receptacle (load side).	HBL1389MQR2	
Type 4X Non-Metallic Labelless Enclosure 30A 3 Pole 600V AC	Catalog Number	
HBLDS3 with one pre-wired LINKOSITY® female receptacle (load side).	HBLDS3MQR	
HBLDS3 with 5 foot pre-wired LINKOSITY® female cable (load side).	HBLDS3MQ5	
HBLDS3 with one pre-wired LINKOSITY® male receptacle (line side) and one pre-wired LINKOSITY® female receptacle (load side).	HBLDS3MQR2	
Type 4X Stainless Steel Enclosure 30A 3 Pole 600V AC	Sloped Top	Square Top
HBLDS3SS with one pre-wired LINKOSITY® female receptacle (load side).	HBLDS3SSRMQR	HBLDS3SSMQR
HBLDS3SS with 5 foot pre-wired LINKOSITY® female cable (load side).	HBLDS3SSRMQ5	HBLDS3SSMQ5
HBLDS3SS with one pre-wired LINKOSITY® male receptacle (line side) and one pre-wired LINKOSITY® female receptacle (load side).	HBLDS3SSRMQR2	HBLDS3SSMQR2



Accessories

Description	Catalog Number
3P 4W LINKOSITY® male receptacle for installation on motor.	RM3004PA001
3P 4W LINKOSITY® female receptacle for installation in switch.	RF3004PA001
3P 4W LINKOSITY® double ended (male/female) 5-50 foot cable.	PH3004PAxxx*
3P 4W LINKOSITY® single ended (female) 5-50 foot cable.	PF3004PAxxx*
Cord connector, 3/4 in. NPT .63-.75 in. (16.0-19.1) diameter.	SHC1037CR
Lock-on cover for LINKOSITY® connections.	PH2030C

Note: *Cables available from 5-50 feet in 5 foot increments. To purchase larger cable, replace the **xxx** with the required length in feet. (Examples: **PH3004PA005** = 5 foot cable, **PH3004PA050** = 50 foot cable.)

Sample Set Up

(1) HBLDS3MQR + (1) PH3004PAxxx + (1) RM3004PA001 = Total Set Up**

Note: ** Retrofit parts available for pre-existing disconnect switch installations. Please consult factory for availability.

Valox® is a trademark of SABIC Innovative Plastics, acquired from General Electric Company.

Features and Benefits

IP66
SUITABILITY

Mini-Quick® Control Connectors

- Nickel plated brass coupling nuts and receptacle shells
- Black overmold and cable
- Insulgrip connector body design
- UL Listed cable assemblies and receptacles
- Plating resists corrosion in high abuse environments
- Cable assembly resists dirt and blends with environment giving a clean look to the installation
- Third party certified for electrical, mechanical and environmental performance
- Ergonomic connector body has an industrial look



Housing Design

- Gated strain relief with graduated window sizes improves flexibility, strength and protects wire terminations; superior arc of bend control



Internal Design

- Leaded nickel copper sleeved contact extends contact life and continuity
- O-rings for moisture protection
- Anti-vibration coupling nut prevents connection from loosening under harsh vibration conditions
- Indicator ring ensures proper mating

Material Specifications

Insulator Materials	Nylon 6/6, White	Cable	#16 AWG SEOOW - TPE jacket, Black, PVC conductor insulation, Stranding - 65/34
Contact Materials	Pins - Brass, Sockets Leaded nickel copper w/ stainless steel sleeve		#18 AWG SEOOW - TPE jacket, Black, PVC conductor insulation, Stranding - 41/34
Contact Plating	Hard gold over palladium/nickel	Strain Relief	#16 AWG and #18 AWG - 30 pounds min per UL2238
Overmold Material	Polyurethane, Black		
Coupling Nut, Metallic	Nickel plated brass		
Coupling Nut, Nylon	Nylon 6/6, Black		
Receptacle Shell	Nickel plated brass, SST consult factory		
Receptacle Shell, Nylon	Nylon 6/6, Black		
Receptacle Shell, Right Angle	Nickel plated zinc alloy die cast, SST consult factory		

Electrical Specifications

Voltage Rating	600V DC/600V AC
Amperage	#16 AWG - 2&3P=15A, 4P=12A, 5&6P=10A 7P=10A, 8&9P=9A, 10&12P=8A #18 AWG - 2&3P=11A, 4P=8A, 5&6P=7A
Contact Resistance	≤ 5 mΩ
Isolation Resistance	≥ 1000 MΩ

Environmental Specifications

Moisture Protection	UL Type 4, 4X, 12 and 13
Ingress Protection	IP66 Suitability
Operating Temperature	SEOOW cable: -40°C to 105° C
Corrosion Resistance	500 hours salt spray per MIL-STD-1344, Method 1001
Vibration Resistance	10 - 2,000 Hz @15g per MIL-STD-1344, Method 2005

Certifications

UL 2238 and UL50E, File No. E192071

CSA Certified, C22.2 No. 182.3 and CSA C22.2 No. 94.2-07

Mini-Quick® 2 - 6 Pole Plugs

Choose the appropriate configuration from the Selector below.

Hubbell Logic Configurator

For example, catalog number **HCMA05112** is derived as follows:

DEVICE TYPE	COUPLING NUT MATERIAL	BODY STYLE	POLES	CONDUCTOR TYPE	CABLE LENGTH (ft)
HC = Plug, Female HP = Plug, Male HI = Plug, Male Inline♦ HE = Male/Female Extension Cable♦ HJ = Male/Female Jumper Cable	M = Metallic N = Nylon	A = Right Angle S = Straight	02 03 04 05 06	1 = #16 AWG SEOOW Cable 4 = #18 AWG SEOOW Cable *3 - 5 Pole Only	** 03 06 12 20 **Replace with Length
HC	M	A	05	1	12

Note: Availability of specific items may vary. Consult factory for delivery. Consult the factory for additional cable lengths or cable types.

♦ Available with metallic coupling nut only.

Mini-Quick® 2 - 6 Pole Plugs

Catalog numbers using #16 AWG SEOOW cable are listed below. For #18 AWG SEOOW cable, change the conductor type per the Hubbell Logic chart above.

Poles	Male Face Shown Female - mirror image	Cable Length	Female Plugs		Male Plugs		Male/Female JumperCables
			Straight	Right Angle	Straight	Right Angle	Straight
2		3 ft (0.91m) 6 ft (1.83m) 12 ft (3.66m) All other lengths▲	HCMS02103	HCMA02103	HPMS02103	HPMA02103	HJMS02103
			HCMS02106	HCMA02106	HPMS02106	HPMA02106	HJMS02106
			HCMS02112	HCMA02112	HPMS02112	HPMA02112	HJMS02112
			HCMS021**	HCMA021**	HPMS021**	HPMA021**	HJMS021**
3		3 ft (0.91m) 6 ft (1.83m) 12 ft (3.66m) All other lengths▲	HCMS03103	HCMA03103	HPMS03103	HPMA03103	HJMS03103
			HCMS03106	HCMA03106	HPMS03106	HPMA03106	HJMS03106
			HCMS03112	HCMA03112	HPMS03112	HPMA03112	HJMS03112
			HCMS031**	HCMA031**	HPMS031**	HPMA031**	HJMS031**
4		3 ft (0.91m) 6 ft (1.83m) 12 ft (3.66m) All other lengths▲	HCMS04103	HCMA04103	HPMS04103	HPMA04103	HJMS04103
			HCMS04106	HCMA04106	HPMS04106	HPMA04106	HJMS04106
			HCMS04112	HCMA04112	HPMS04112	HPMA04112	HJMS04112
			HCMS041**	HCMA041**	HPMS041**	HPMA041**	HJMS041**
5		3 ft (0.91m) 6 ft (1.83m) 12 ft (3.66m) All other lengths▲	HCMS05103	HCMA05103	HPMS05103	HPMA05103	HJMS05103
			HCMS05106	HCMA05106	HPMS05106	HPMA05106	HJMS05106
			HCMS05112	HCMA05112	HPMS05112	HPMA05112	HJMS05112
			HCMS051**	HCMA051**	HPMS051**	HPMA051**	HJMS051**
6		3 ft (0.91m) 6 ft (1.83m) 12 ft (3.66m) All other lengths▲	HCMS06103	HCMA06103	HPMS06103	HPMA06103	HJMS06103
			HCMS06106	HCMA06106	HPMS06106	HPMA06106	HJMS06106
			HCMS06112	HCMA06112	HPMS06112	HPMA06112	HJMS06112
			HCMS061**	HCMA061**	HPMS061**	HPMA061**	HJMS061**

Note: ▲ Replace ** with length required in feet. For nylon coupling nuts, replace "M" with "N" per the ordering chart above.
 Example: change **HPMA05106** to **HPNA05106**.



Mini-Quick® 2 - 6 Pole Plugs

Straight Plug

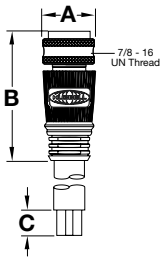

	MALE	FEMALE
A	0.99" (25.2)	0.99" (25.2)
B	2.44" (62.0)	2.40" (61.0)
C	2.75" (69.9)	2.75" (69.9)

Right Angle Plug

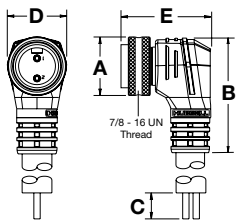

	MALE	FEMALE
A	0.99" (25.2)	0.99" (25.2)
B	2.14" (54.4)	2.14" (54.4)
C	2.75" (69.9)	2.75" (69.9)
D	1.03" (26.2)	1.03" (26.2)
E	1.64" (40.6)	1.60" (40.6)

Inline Plug

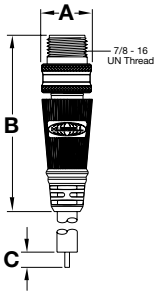

	MALE
A	0.99" (25.2)
B	2.47" (62.8)
C	2.75" (69.9)

Right Angle version also available.

Accessories

Closure caps protect plugs and receptacles when not in use. Adapter rings allow the mating of male and female plugs for in-line applications. Shell size is 1, and the thread is 7/8-16 UN.

Description	Catalog Number	
Closure Cap	HPCAP1	
Closure Cap	HRCAP1	
Adapter Ring	HMQAR1	

Dimensions in Inches (mm)

Jumper Cable

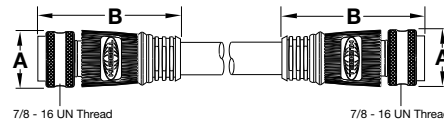

	MALE	FEMALE
A	0.99" (25.2)	0.99" (25.2)
B	2.44" (62.0)	2.40" (61.0)

Male/Female Extension Cable

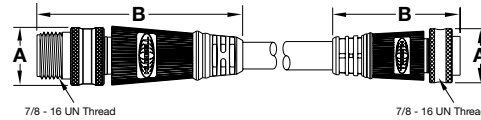

	MALE	FEMALE
A	0.99" (25.2)	0.99" (25.2)
B	2.47" (62.7)	2.40" (61.0)

Cable Diameters By Cable Type

Number of Conductors	#16 AWG SEOOW	#18 AWG SEOOW
2	0.37" (9.4)	0.35" (8.9)
3	0.39" (9.9)	0.37" (9.4)
4	0.42" (10.7)	0.39" (9.9)
5	0.50" (12.7)	0.47" (11.9)
6	0.52" (13.2)	0.48" (12.2)

Conductor Color Code

#16 AWG SEOOW Plugs

Contact Number	2 Pole	3 Pole	4 Pole	5 Pole	6 Pole
1	White	Green	Black	White	White
2	Black	Black	White	Red	Red
3		White	Red	Green	Green
4			Green	Orange	Orange
5				Black	Black
6					Blue

#18 AWG SEOOW Plugs

Contact Number	3 Pole	4 Pole	5 Pole
1	Green	Black	White
2	Black	White	Red
3	White	Red	Green
4		Green	Orange
5			Black

Mini-Quick® 2 - 6 Pole Receptacles

Choose the appropriate configuration from the Selector below.

Hubbell Logic Configurator

For example, catalog number **HBMS05501** is derived as follows:

DEVICE TYPE	SHELL MATERIAL	BODY STYLE	POLES	CONDUCTOR TYPE	LEAD WIRE LENGTH (ft)
HR = Receptacle, Female HB = Receptacle, Male	M = Metallic N = Nylon	A = Right Angle* S = Straight F = Flange Mount* <i>*Metallic Only</i>	02 03 04 05 06	5 = #16 AWG Discrete Wire 6 = #18 AWG IEC Discrete Wire (IEC colors)* <i>*3 - 5 Pole Only</i>	01 * ** <i>*1 Standard Length **Replace with Length</i>
HB	M	S	05	5	01

Note: Availability of specific items may vary. Consult factory for delivery. Use this chart to build receptacles to meet any application need. Consult the factory for additional wire lengths or wire types.

Mini-Quick® 2 - 6 Pole Receptacles

#16 AWG Discrete Wire ◆

Poles	Male Face Shown Female - mirror image	Female Receptacles				Male Receptacles			
		Straight	Nylon	Right Angle	Flange Mount	Straight	Nylon	Right Angle	Flange Mount
2		HRMS02501	HRNS02501	HRMA02501	HRMF02501	HBMS02501	HBNS02501	HBMA02501	HBMF02501
3		HRMS03501	HRNS03501	HRMA03501	HRMF03501	HBMS03501	HBNS03501	HBMA03501	HBMF03501
4		HRMS04501	HRNS04501	HRMA04501	HRMF04501	HBMS04501	HBNS04501	HBMA04501	HBMF04501
5		HRMS05501	HRNS05501	HRMA05501	HRMF05501	HBMS05501	HBNS05501	HBMA05501	HBMF05501
6		HRMS06501	HRNS06501	HRMA06501	HRMF06501	HBMS06501	HBNS06501	HBMA06501	HBMF06501

Note: ◆ For #18 AWG IEC discrete wire, change the conductor type using the Hubbell Logic chart above.

Mini-Quick® 2 - 6 Pole Receptacles

Straight Receptacles

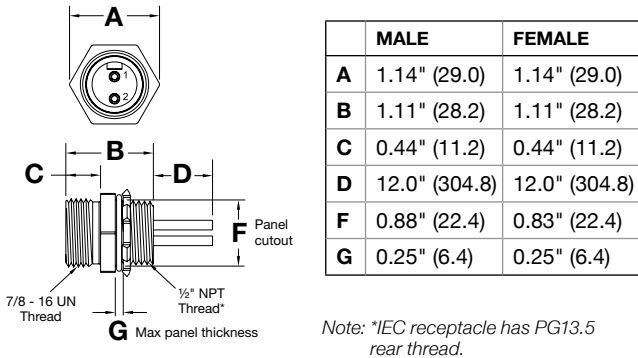

Flange Mount Receptacles

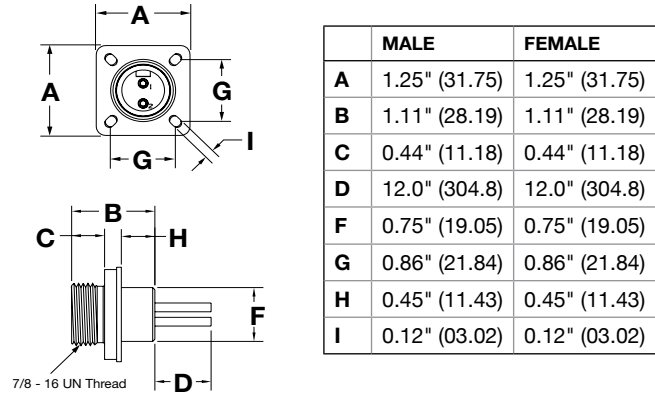

Right Angle Receptacles

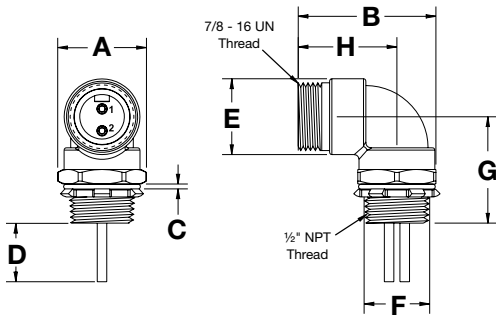

	MALE	FEMALE
A	1.14" (29.0)	1.14" (29.0)
B	1.76" (44.7)	1.76" (44.7)
C	0.25" (6.4)	0.25" (6.4)
D	12.0" (304.8)	12.0" (304.8)
E	0.97" (24.6)	0.97" (24.6)
F	0.83" (21.8)	0.83" (21.8)
G	1.36" (34.5)	1.36" (34.5)
H	1.26" (32.0)	1.26" (32.0)

Accessories

Closure caps protect plugs and receptacles when not in use. Shell size is 1, and the thread is 7/8-16 UN.

Description	Catalog Number
Closure Cap	HPCAP1
Closure Cap	HRCAP1

Dimensions in Inches (mm)

Color Code By Wire Type

#16 AWG Receptacles

Contact Number	2 Pole	3 Pole	4 Pole	5 Pole	6 Pole
1	White	Green	Black	White	White
2	Black	Black	White	Red	Red
3		White	Red	Green	Green
4			Green	Orange	Orange
5				Black	Black
6					Blue

#18 AWG Receptacles

Contact Number	3 Pole	4 Pole	5 Pole
1	Yellow/Green	Black	Black
2	Brown	Blue	Blue
3	Blue	Brown	Yellow/Green
4		White	Brown
5			White

Mini-Quick® 7 - 12 Pole Plugs

Choose the appropriate configuration from the Selector below.

Hubbell Logic Configurator

For example, catalog number **HCMA08112** is derived as follows:

DEVICE TYPE	COUPLING NUT MATERIAL	BODY STYLE	POLES	CONDUCTOR TYPE	CABLE LENGTH (ft)
HC = Plug, Female HP = Plug, Male HJ = Male/Female Jumper Cable	M = Metallic N = Nylon	A = Right Angle S = Straight	07 08 09 10 12	1 = #16 AWG SEOOW Cable	** 03 06 12 20 **Replace with Length
↓ HC	↓ M	↓ A	↓ 08	↓ 1	↓ 12

Note: Availability of specific items may vary. Consult factory for delivery. Consult the factory for additional cable lengths or cable types.

Mini-Quick® 7 - 12 Pole Plugs

Catalog numbers using #16 AWG SEOOW cable are listed below.

Poles	Male Face Shown Female - mirror image	Cable Length	Female Plugs		Male Plugs		Male/Female Jumper Cables
			Straight	Right Angle	Straight	Right Angle	Straight
7		3 ft (0.91m) 6 ft (1.83m) 12 ft (3.66m) All other lengths [▲]	HCMS07103	HCMA07103	HPMS07103	HPMA07103	HJMS07103
			HCMS07106	HCMA07106	HPMS07106	HPMA07106	HJMS07106
			HCMS07112	HCMA07112	HPMS07112	HPMA07112	HJMS07112
			HCMS071**	HCMA071**	HPMS071**	HPMA071**	HJMS071**
8		3 ft (0.91m) 6 ft (1.83m) 12 ft (3.66m) All other lengths [▲]	HCMS08103	HCMA08103	HPMS08103	HPMA08103	HJMS08103
			HCMS08106	HCMA08106	HPMS08106	HPMA08106	HJMS08106
			HCMS08112	HCMA08112	HPMS08112	HPMA08112	HJMS08112
			HCMS081**	HCMA081**	HPMS081**	HPMA081**	HJMS081**
9		3 ft (0.91m) 6 ft (1.83m) 12 ft (3.66m) All other lengths [▲]	HCMS09103	HCMA09103	HPMS09103	HPMA09103	HJMS09103
			HCMS09106	HCMA09106	HPMS09106	HPMA09106	HJMS09106
			HCMS09112	HCMA09112	HPMS09112	HPMA09112	HJMS09112
			HCMS091**	HCMA091**	HPMS091**	HPMA091**	HJMS091**
10		3 ft (0.91m) 6 ft (1.83m) 12 ft (3.66m) All other lengths [▲]	HCMS10103	HCMA10103	HPMS10103	HPMA10103	HJMS10103
			HCMS10106	HCMA10106	HPMS10106	HPMA10106	HJMS10106
			HCMS10112	HCMA10112	HPMS10112	HPMA10112	HJMS10112
			HCMS101**	HCMA101**	HPMS101**	HPMA101**	HJMS101**
12		3 ft (0.91m) 6 ft (1.83m) 12 ft (3.66m) All other lengths [▲]	HCMS12103	HCMA12103	HPMS12103	HPMA12103	HJMS12103
			HCMS12106	HCMA12106	HPMS12106	HPMA12106	HJMS12106
			HCMS12112	HCMA12112	HPMS12112	HPMA12112	HJMS12112
			HCMS121**	HCMA121**	HPMS121**	HPMA121**	HJMS121**

Note: [▲] Replace ** with length required in feet. For nylon coupling nuts, replace "M" with "N" per the ordering chart above.
Example: change **HPMA07106** to **HPNA07106**.



Mini-Quick® 7 - 12 Pole Plugs

Straight Plug

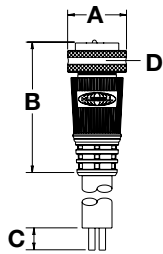

7 - 8 Pole

	MALE	FEMALE
A	1.12" (28.5)	1.12" (28.5)
B	2.53" (64.3)	2.49" (63.3)
C	2.75" (69.9)	2.75" (69.9)
D	1 - 16 UN Thread	

9 - 12 Pole

	MALE	FEMALE
A	1.25" (31.8)	1.25" (31.8)
B	2.77" (70.4)	2.73" (69.3)
C	2.75" (69.9)	2.75" (69.9)
D	1 1/8 - 16 UN Thread	

Right Angle Plug

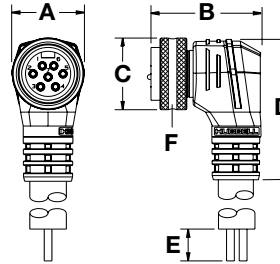

7 - 8 Pole

	MALE	FEMALE
A	1.14" (29.0)	1.14" (29.0)
B	1.73" (43.9)	1.69" (42.9)
C	1.12" (28.5)	1.12" (28.5)
D	2.22" (56.4)	2.22" (56.4)
E	2.75" (69.9)	2.75" (69.9)
F	1 - 16 UN Thread	

9 - 12 Pole

	MALE	FEMALE
A	1.25" (31.8)	1.25" (31.8)
B	1.84" (47.0)	1.80" (45.7)
C	1.25" (31.8)	1.25" (31.8)
D	2.54" (64.5)	2.54" (64.5)
E	2.75" (69.9)	2.75" (69.9)
F	1 1/8 - 16 UN Thread	

Jumper Cable

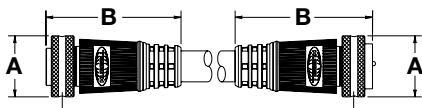

7 - 8 Pole

	MALE	FEMALE
A	1.12" (28.5)	1.12" (28.5)
B	2.53" (64.3)	2.49" (63.3)
C	1 - 16 UN Thread	

9 - 12 Pole

	MALE	FEMALE
A	1.25" (31.8)	1.25" (31.8)
B	2.77" (70.4)	2.73" (69.3)
C	1 1/8 - 16 UN Thread	

Cable Diameters By Cable Type

Number of Conductors	#16 AWG STOOW
7	0.52" (13.2)
8	0.56" (14.2)
9	0.60" (15.2)
10	0.65" (16.7)
12	0.70" (17.7)

Conductor Color Code

#16 AWG SEOOW Plugs

Contact Number	2 Pole	3 Pole	4 Pole	5 Pole	6 Pole	7 Pole	8 Pole	9 Pole	10 Pole	12 Pole
1	White	Green	Black	White	White	White/Black	Orange	Orange	Orange	Orange
2	Black	Black	White	Red	Red	Black	Blue	Blue	Blue	Blue
3		White	Red	Green	Green	White	White/Black	Red/Black	White/Black	White/Black
4			Green	Orange	Orange	Red	Black	Green/Black	Red/Black	Red/Black
5			Black	Black	Black	Orange	White	White	Green/Black	Green/Black
6					Blue	Blue	Red	Red	Orange/Black	Orange/Black
7						Green	Green	Green	Red	Blue/Black
8							Red/Black	White/Black	Green	Black/White
9								Black	Black	Green
10									White	Red
11										White
12										Black

Accessories

Closure caps protect plugs and receptacles when not in use. Adapter rings allow the mating of male and female plugs for in-line applications.

Description	Closure Cap			Closure Cap			Adapter Ring		
	Shell Size	Thread Size	Catalog Number	Shell Size	Thread Size	Catalog Number	Shell Size	Thread Size	Catalog Number
7 to 8 Pole	II	1 - 16 UN	HPCAP2	II	1 - 16 UN	HRCAP2	II	1 - 16 UN	HMQR2
9 to 12 Pole	III	1 1/8 - 16UN	HPCAP3	III	1 1/8 - 16UN	HRCAP3	III	1 1/8 - 16UN	HMQR3
Cap Size									
Cap Size	II- 1.12" (28.5), III- 1.25" (31.8)			II- 1.13" (28.6), III- 1.25" (31.8)			II- 1.00" (25.4), III- 1.13" (28.6)		

Dimensions in Inches (mm)

Mini-Quick® 7 - 12 Pole Receptacles

Choose the appropriate configuration from the Selector below.

Hubbell Logic Configurator





For example, catalog number **HRMS10501** is derived as follows:

DEVICE TYPE	SHELL MATERIAL	BODY STYLE	POLES	CONDUCTOR TYPE	LEAD WIRE LENGTH (ft)
HR = Receptacle, Female HB = Receptacle, Male	M = Metallic	S = Straight	07 08 09 10 12	5 = #16 AWG Discrete Wire	01* ** *1 Standard Length **Replace with Length
↓	↓	↓	↓	↓	↓
HR	M	S	10	5	01

Note: Availability of specific items may vary. Consult factory for delivery. Consult the factory for additional wire lengths or wire types.

Mini-Quick® 7 - 12 Pole Receptacles

#16 AWG Discrete Wire

Poles	Male Face Shown Female - mirror image	Female Receptacles	Male Receptacles
7		HRMS07501	HBMS07501
8		HRMS08501	HBMS08501
9		HRMS09501	HBMS09501
10		HRMS10501	HBMS10501
12		HRMS12501	HBMS12501



Mini-Quick® 7 - 12 Pole Receptacles

Straight Receptacles

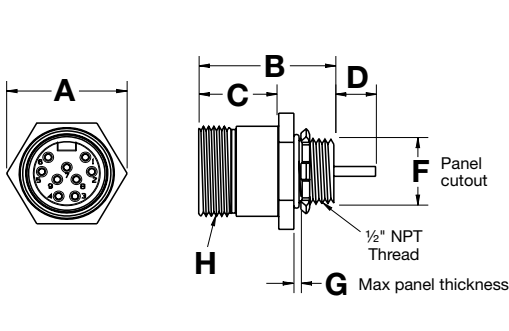

7 - 8 Pole

	MALE	FEMALE
A	1.29" (32.8)	1.29" (32.8)
B	1.44" (36.6)	1.44" (36.6)
C	0.80" (20.3)	0.80" (20.3)
D	12.0" (304.8)	12.0" (304.8)
F	0.83" (21.1)	0.83" (21.1)
G	0.25" (6.4)	0.25" (6.4)
H	1 - 16 UN Thread	

9 - 12 Pole

	MALE	FEMALE
A	1.44" (36.6)	1.44" (36.6)
B	1.62" (41.2)	1.62" (41.2)
C	0.96" (24.4)	0.96" (24.4)
D	12.0" (304.8)	12.0" (304.8)
F	0.83" (21.1)	0.83" (21.1)
G	0.25" (6.4)	0.25" (6.4)
H	1 1/8 - 16 UN Thread	

Conductor Color Code

#16 AWG Receptacles

Contact Number	2 Pole	3 Pole	4 Pole	5 Pole	6 Pole	7 Pole	8 Pole	9 Pole	10 Pole	12 Pole
1	White	Green	Black	White	White	White/Black	Orange	Orange	Orange	Orange
2	Black	Black	White	Red	Red	Black	Blue	Blue	Blue	Blue
3		White	Red	Green	Green	White	White/Black	Red/Black	White/Black	White/Black
4			Green	Orange	Orange	Red	Black	Green/Black	Red/Black	Red/Black
5				Black	Black	Orange	White	White	Green/Black	Green/Black
6					Blue	Blue	Red	Red	Orange/Black	Orange/Black
7						Green	Green	Green	Red	Blue/Black
8							Red/Black	White/Black	Green	Black/White
9								Black	Black	Green
10									White	Red
11										White
12										Black

Accessories

Closure caps protect plugs and receptacles when not in use. Adapter rings allow the mating of male and female plugs for in-line applications.

Description	Closure Cap			Closure Cap			Adapter Ring		
	Shell Size	Thread Size	Catalog Number	Shell Size	Thread Size	Catalog Number	Shell Size	Thread Size	Catalog Number
7 to 8 Pole	II	1 - 16 UN	HPCAP2	II	1 - 16 UN	HRCAP2	II	1 - 16 UN	HMQR2
9 to 12 Pole	III	1 1/8 - 16UN	HPCAP3	III	1 1/8 - 16UN	HRCAP3	III	1 1/8 - 16UN	HMQR3
Cap Size	II- 1.12" (28.5), III- 1.25" (31.8)			II- 1.13" (28.6), III- 1.25" (31.8)			II- 1.00" (25.4), III- 1.13" (28.6)		

Dimensions in Inches (mm)

Features and Benefits

IP66
SUITABILITY

Mini-Quick® Field Attachable Connectors - Screw Terminal Style

Electrical Specifications

Voltage Rating	250V
Amperage	3 Pin - 12A 4,5 Pin - 9A
Wire Size, Max	#16 AWG

Mechanical Specifications

Coupling Nut	Anodized aluminum, SST consult factory
Connector Shell	PBT
Connector Insert	PUR/PA
Contacts	Brass, gold plate over palladium nickel

Environmental Specifications

Moisture Resistance	IP66 Suitability
Operating Temperature	-40°C to 85°C



Housing Design

- High impact body design
- Strain relief protects terminations



Internal Design

- Superior contact design utilizing high performance gold over palladium nickel plating
- Coupling nut anodized aluminum, SST option consult factory
- Precision wire funnels eliminate stray strands

Mini-Quick® 3 - 5 Pole Field Attachable Connectors

Poles	Male Face Shown Female - mirror image	Cable Range	Female Connector		Male In-Line Connector		Male Connector	
			Straight	Right Angle	Straight	Right Angle	Straight	Right Angle
3		.24"-.32" (6.1-8.1)	HCMS03F9	HCMA03F9	HIMS03F9	HIMA03F9	HPMS03F9	HPMA03F9
		.39"-.47" (9.9-11.9)	HCMS03F13	—	HIMS03F13	—	HPMS03F13	—
		.47"-.55" (11.9-13.1)	—	—	—	—	—	—
4		.24"-.32" (6.1-8.1)	HCMS04F9	HCMA04F9	HIMS04F9	HIMA04F9	HPMS04F9	HPMA04F9
		.39"-.47" (9.9-11.9)	HCMS04F13	—	HIMS04F13	—	HPMS04F13	—
		.47"-.55" (11.9-13.1)	HCMS04F16	—	HIMS04F16	—	HPMS04F16	—
5		.24"-.32" (6.1-8.1)	HCMS05F9	HCMA05F9	HIMS05F9	HIMA05F9	HPMS05F9	HPMA05F9
		.39"-.47" (9.9-11.9)	HCMS05F13	—	HIMS05F13	—	HPMS05F13	—
		.47"-.55" (11.9-13.1)	HCMS05F16	—	HIMS05F16	—	HPMS05F16	—

Female, Straight Male, Straight



Female, Right Angle Male, Right Angle



Male In-Line, Straight



Male In-Line, Right Angle



Dimensions in Inches (mm)

Features and Benefits

IP66
SUITABILITY

Micro-Quick® Control Connectors

- Nickel plated brass coupling nuts and receptacle shells
- Black overmold and cable
- Insulgrip connector body design
- Beryllium copper socket contacts
- Standard #22 AWG cable 85% copper braid coverage
- Plating resists corrosion in high abuse environments
- Strong, resilient base metal ensures contacts maintain their shape and continuity over time.
- Cable resists nicks and abrasions and provides shielding when braid is terminated
- Resilient base metal maintains socket contact shape
- Ergonomic connector body has an industrial look



Housing Design

- Gated strain relief with graduated window sizes distributes force away from contacts to protect terminations



Internal Design

- Hard gold over palladium/nickel contact plating high mating cycles and longer contact life
- O-rings for moisture protection
- Custom knurled, anti-vibration coupling nut prevents connection from loosening under harsh vibration conditions
- Indicator ring ensures proper mating

Material Specifications

Insulator Materials	Nylon 6/6, White	Cable	#22 AWG - PVC jacket (black)
Contact Materials	Pins - Brass		PVC conductor insulation
	Sockets - Beryllium copper		Copper braid - 85% coverage
Contact Plating	Hard gold over palladium/nickel		Stranding - 19/34
Overmold Material	Glass filled polyurethane, Black		#18 AWG - TPE jacket (black)
Coupling Nut, Metallic	Nickel plated brass		PVC conductor insulation
Coupling Nut, Nylon	Nylon 6/6, Black		Stranding - 41/34
Receptacle Shell	Nickel plated brass	Strain Relief	#22 AWG - 20 pounds min per UL2238
			#18 AWG - 30 pounds min per UL 2238

Electrical Specifications

Voltage Rating	300V DC/300V AC
Amperage	#22 AWG - 2&3P=5A, 4&5P=4A, 6P=3A #18 AWG - 2&3P=8A, 4P=6A, 5P=5A
Contact Resistance	≤ 5 mΩ
Isolation Resistance	≥ 1000 MΩ

Environmental Specifications

Moisture Protection	UL Type 4, 4X, 12 and 13
Ingress Protection	IP66 Suitability
Operating Temperature	#22 AWG PVC cable: -20°C to 105° C #18 AWG TPE cable: -40°C to 105° C
Corrosion Resistance	500 hours salt spray per MIL-STD-1344, Method 1001
Vibration Resistance	10 - 2,000 Hz @15g per MIL-STD-1344, Method 2005

Certifications

UL 2238 and UL50E, File No. E192071

CSA Certified, C22.2 No. 182.3 and CSA C22.2 No. 94.2-07

Micro-Quick® Single Key 3 - 5 Pole Plugs

Choose the appropriate configuration from the Selector below.

Hubbell Logic Configurator

For example, catalog number **MCMS1312** is derived as follows:

DEVICE TYPE	COUPLING NUT MATERIAL	BODY STYLE	KEY STYLE	POLES	CONDUCTOR TYPE	CABLE LENGTH (m)
MC = Plug, Female MI = Plug, Male Inline ME = Male/Female Extension Cable	M = Metallic N = Nylon	A = Right Angle S = Straight	1 = Single	3 4 5	1 = #22 AWG PVC Cable 2 = #18 AWG TPE Cable* *2 - 4 Pole Only	** 2 4 5 **Replace with Length
MC	M	S	1	3	1	2

Note: Availability of specific items may vary. Consult factory for delivery. Consult the factory for additional cable lengths or cable types.

Micro-Quick® 3 - 5 Pole Single Key Plugs

Catalog numbers using #22 AWG PVC cable are listed below. For #18 AWG TPE cable, change the conductor type per the Hubbell Logic chart above.

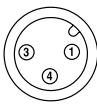
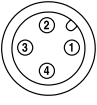
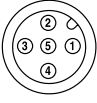
Poles	Male Face Shown Female - mirror image	Cable Length	Female Plugs		Male In-Line Plugs	Male/Female Extension Cables
			Straight	Right Angle	Straight	Straight
3		6.56 ft (2m)	MCMS1312	MCMA1312	MIMS1312	MEMS1312
		13.12 ft (4m)	MCMS1314	MCMA1314	MIMS1314	MEMS1314
		16.40 ft (5m)	MCMS1315	MCMA1315	MIMS1315	MEMS1315
		All other lengths▲	MCMS131**	MCMA131**	MIMS131**	MEMS131**
4		6.56 ft (2m)	MCMS1412	MCMA1412	MIMS1412	MEMS1412
		13.12 ft (4m)	MCMS1414	MCMA1414	MIMS1414	MEMS1414
		16.40 ft (5m)	MCMS1415	MCMA1415	MIMS1415	MEMS1415
		All other lengths▲	MCMS141**	MCMA141**	MIMS141**	MEMS141**
5		6.56 ft (2m)	MCMS1512	MCMA1512	MIMS1512	MEMS1512
		13.12 ft (4m)	MCMS1514	MCMA1514	MIMS1514	MEMS1514
		16.40 ft (5m)	MCMS1515	MCMA1515	MIMS1515	MEMS1515
		All other lengths▲	MCMS151**	MCMA151**	MIMS151**	MEMS151**

Note: ▲ Replace ** with length required in meters. For nylon coupling nuts, replace "M" with "N" per the ordering chart above.
 Example: change **MCMA1412** to **MCNA1412**.

Micro-Quick® Single Key 3 - 5 Pole Plugs

Straight Female Plug

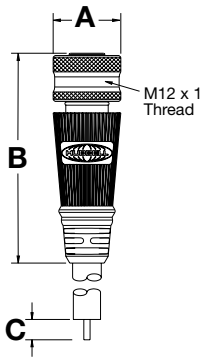

A	0.59" (15.0)
B	1.83" (46.5)
C	2.75" (69.9)

Right Angle Female Plug

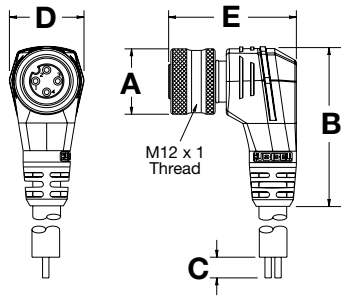

A	0.59" (15.0)
B	1.44" (36.6)
C	2.75" (69.9)
D	0.67" (17.0)
E	1.15" (29.2)

Right Male In-Line Plug

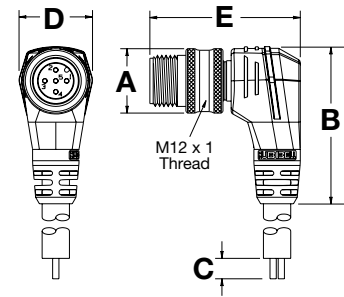

A	0.59" (15.0)
B	1.44" (36.6)
C	2.75" (69.9)
D	0.67" (17.0)
E	1.38" (35.1)

Straight Male In-Line Plug

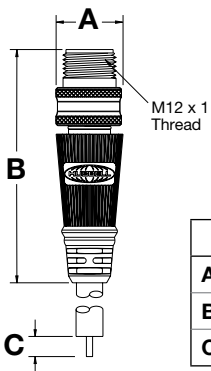

	MALE
A	0.59" (15.0)
B	2.06" (52.3)
C	2.75" (69.9)

Extension Cable

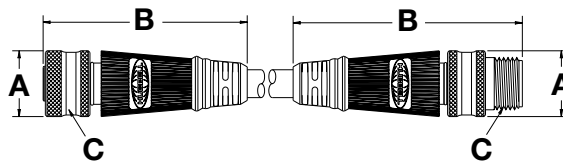

	FEMALE	MALE
A	0.59" (15.0)	0.59" (15.0)
B	1.83" (46.5)	2.06" (52.3)
C	M12 x 1	

Cable Diameters By Cable Type

Number of Conductors	#22 AWG PVC	#18 AWG TPE
3	0.21" (5.3)	0.24" (6.1)
4	0.22" (5.7)	0.26" (6.6)
5	0.26" (6.6)	0.28" (7.1)

Conductor Color Code

Contact Number	3 Pole	4 Pole	5 Pole
1	Brown	Brown	Brown
2	Not Used	White	White
3	Blue	Blue	Blue
4	Black	Black	Black
5	Not Used	Not Used	Gray

Accessories

Dust Caps

Closure caps protect plugs and receptacles when not in use. Thread is M12 x 1.

Catalog Number	
MRCM1	
MPCM1	

Dimensions in Inches (mm)

Micro-Quick® Single Key 3 - 5 Pole Receptacles

Choose the appropriate configuration from the Selector below.

Hubbell Logic Configurator

For example, catalog number **MRMS13314** is derived as follows:

DEVICE TYPE	COUPLING NUT MATERIAL	BODY STYLE	KEY STYLE	POLES	CONDUCTOR TYPE	REAR THREAD STYLE
MB = Receptacle, Male MF = Receptacle, Female Inverse	M = Metallic	S = Straight	1 = Single	3 4 5	3 = #22 AWG PVC Discrete Wire 4 = #18 AWG PVC Discrete Wire* *3 - 4 Pole Only	14 = M14x1* 25 = ¼" NPT** 50 = ½" NPT* *MB Style Only **MF Style Only
↓	↓	↓	↓	↓	↓	↓
MR	M	S	1	3	3	14

Note: Availability of specific items may vary. Consult factory for delivery. Consult the factory for additional cable lengths or cable types.

Micro-Quick® 3 - 5 Pole Single Key Receptacles- #22 AWG Discrete Wire*

Catalog numbers using #22 AWG PVC discrete wire are listed below. For #18 AWG PVC discrete wire, change the conductor type per the Hubbell Logic chart above.

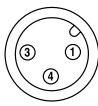
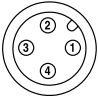
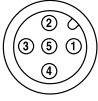
Poles	Male Face Shown Female - mirror image	Male Receptacle Rear Thread Style		Female Inverse Receptacles Rear Thread Style
		M14 x 1	½" NPT	¼" NPT
3		MBMS13314	MBMS13350	MFMS13325
4		MBMS14314	MBMS14350	MFMS14325
5		MBMS15314	MBMS15350	MFMS15325

Note: *For #18 AWG discrete wire, replace the conductor type per Hubbell Logic chart above.
 All receptacles available in 1ft. length standard. For additional lengths, please consult factory.



Micro-Quick® Single Key 3 - 5 Pole Receptacles

Male Receptacle Rear Thread - M14x1

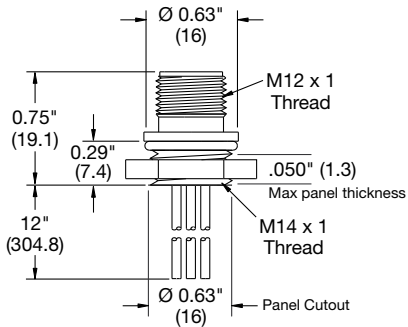

Male Receptacle Rear Thread - 1/2" NPT

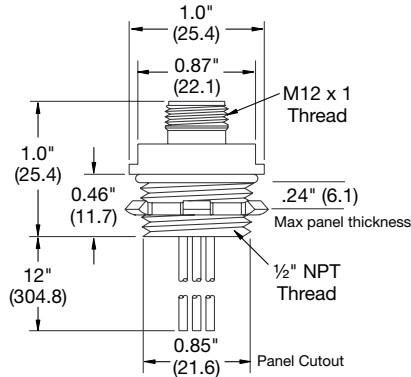

Female Inverse Receptacle Rear Thread - 1/4" NPT

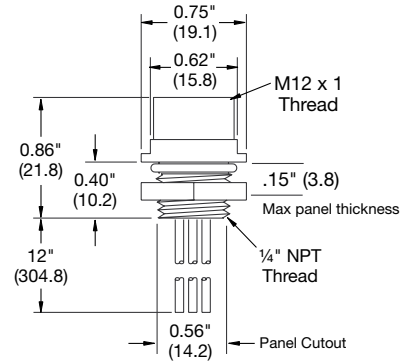

Conductor Color Code - Single Key

Contact Number	3 Pole	4 Pole	5 Pole
1	Brown	Brown	Brown
2	Not Used	White	White
3	Blue	Blue	Blue
4	Black	Black	Black
5	Not Used	Not Used	Gray

Accessories

Dust Caps

Closure caps protect plugs and receptacles when not in use. Thread is M12 x 1.

Catalog Number	
MRCM1	
MPCM1	

Dimensions in Inches (mm)

Micro-Quick® Dual Key 2 - 6 Pole Plugs

Choose the appropriate configuration from the Selector below.

Hubbell Logic Configurator

For example, catalog number **MPMS2512** is derived as follows:

DEVICE TYPE	COUPLING NUT MATERIAL	BODY STYLE	KEY STYLE	POLES	CONDUCTOR TYPE	CABLE LENGTH (m)
MC = Plug, Female MP = Plug, Male MI = Plug, Male Inline ME = Male/Female Extension Cable	M = Metallic N = Nylon	A = Right Angle S = Straight	2 = Dual	2 3 4 5 6	1 = #22 AWG PVC Cable 2 = #18 AWG TPE Cable* *2 - 5 Pole Only	** 2 4 5 **Replace with Length
MP	M	S	2	5	1	2

Note: Availability of specific items may vary. Consult factory for delivery. Consult the factory for additional cable lengths or cable types.

Micro-Quick® 2 - 6 Pole Dual Key Plugs

Catalog numbers using #22 AWG PVC cable are listed below. For #18 AWG TPE cable, change the conductor type per the Hubbell Logic chart above.

Poles	Male Face Shown Female - mirror image	Cable Length	Female Plugs		Male Plugs			Male/Female Extension Cables
			Straight	Right Angle	Straight	Right Angle	In-Line Straight	Straight
2		6.56 ft (2m) 13.12 ft (4m) 16.40 ft (5m) All other lengths▲	MCMS2212	MCMA2212	MPMS2212	MPMA2212	MIMS2212	MEMS2212
			MCMS2214	MCMA2214	MPMS2214	MPMA2214	MIMS2214	MEMS2214
			MCMS2215	MCMA2215	MPMS2215	MPMA2215	MIMS2215	MEMS2215
			MCMS221**	MCMA221**	MPMS221**	MPMA221**	MIMS221**	MEMS221**
3		6.56 ft (2m) 13.12 ft (4m) 16.40 ft (5m) All other lengths▲	MCMS2312	MCMA2312	MPMS2312	MPMA2312	MIMS2312	MEMS2312
			MCMS2314	MCMA2314	MPMS2314	MPMA2314	MIMS2314	MEMS2314
			MCMS2315	MCMA2315	MPMS2315	MPMA2315	MIMS2315	MEMS2315
			MCMS231**	MCMA231**	MPMS231**	MPMA231**	MIMS231**	MEMS231**
4		6.56 ft (2m) 13.12 ft (4m) 16.40 ft (5m) All other lengths▲	MCMS2412	MCMA2412	MPMS2412	MPMA2412	MIMS2412	MEMS2412
			MCMS2414	MCMA2414	MPMS2414	MPMA2414	MIMS2414	MEMS2414
			MCMS2415	MCMA2415	MPMS2415	MPMA2415	MIMS2415	MEMS2415
			MCMS241**	MCMA241**	MPMS241**	MPMA241**	MIMS241**	MEMS241**
5		6.56 ft (2m) 13.12 ft (4m) 16.40 ft (5m) All other lengths▲	MCMS2512	MCMA2512	MPMS2512	MPMA2512	MIMS2512	MEMS2512
			MCMS2514	MCMA2514	MPMS2514	MPMA2514	MIMS2514	MEMS2514
			MCMS2515	MCMA2515	MPMS2515	MPMA2515	MIMS2515	MEMS2515
			MCMS251**	MCMA251**	MPMS251**	MPMA251**	MIMS251**	MEMS251**
6		6.56 ft (2m) 13.12 ft (4m) 16.40 ft (5m) All other lengths▲	MCMS2612	MCMA2612	MPMS2612	MPMA2612	MIMS2612	MEMS2612
			MCMS2614	MCMA2614	MPMS2614	MPMA2614	MIMS2614	MEMS2614
			MCMS2615	MCMA2615	MPMS2615	MPMA2615	MIMS2615	MEMS2615
			MCMS261**	MCMA261**	MPMS261**	MPMA261**	MIMS261**	MEMS261**

Note: ▲ Replace ** with length required in meters. For nylon coupling nuts, replace "M" with "N" per the ordering chart above.
Example: change **MCMS2314** to **MCNS2314**.



Micro-Quick® Dual Key 2 - 6 Pole Plugs

Straight Plug

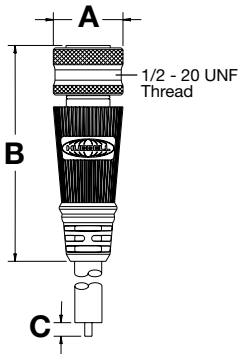

	MALE	FEMALE
A	0.59" (15.0)	0.59" (15.0)
B	1.83" (46.5)	1.83" (46.5)
C	2.75" (69.9)	2.75" (69.9)

Right Angle Plug

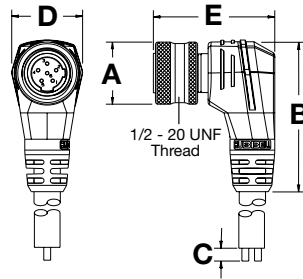

	MALE	FEMALE
A	0.59" (15.0)	0.59" (15.0)
B	1.44" (36.6)	1.44" (36.6)
C	2.75" (69.9)	2.75" (69.9)
D	0.67" (17.0)	0.67" (17.0)
E	1.15" (29.2)	1.15" (29.2)

Right Angle Male In-Line Plug

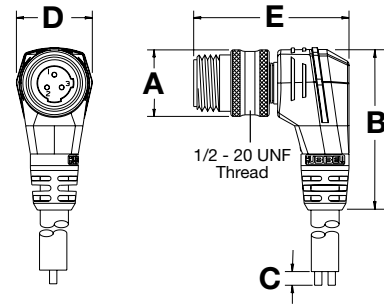

	MALE	FEMALE
A	0.59" (15.0)	0.59" (15.0)
B	1.44" (36.6)	1.44" (36.6)
C	2.75" (69.9)	2.75" (69.9)
D	0.67" (17.0)	0.67" (17.0)
E	1.38" (35.1)	1.38" (35.1)

Male In-Line Plug

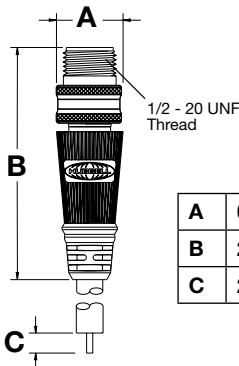

A	0.59" (15.0)
B	2.06" (52.3)
C	2.75" (69.9)

Extension Cable

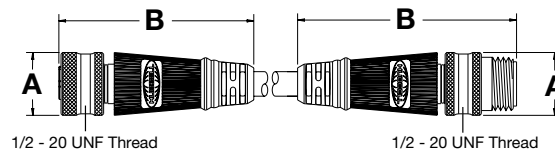

	MALE	FEMALE
A	0.59" (15.0)	0.59" (15.0)
B	2.06" (52.3)	1.83" (46.5)

Conductor Color Code - Dual Key

Contact Number	2 Pole	3 Pole	4 Pole	5 Pole	6 Pole
1	Brown	Green	Red/Black	Red/White	Red/White
2	Blue	Red/Black	Red/White	Red	Red
3		Red/White	Red	Green	Green
4			Green	Red/Yellow	Red/Yellow
5				Red/Black	Red/Black
6					Red/Blue

Cable Diameters By Cable Type

Number of Conductors	#22 AWG PVC	#18 AWG TPE
2	0.20" (5.1)	0.23" (5.8)
3	0.21" (5.3)	0.24" (6.09)
4	0.22" (5.7)	0.26" (6.6)
5	0.26" (6.7)	0.28" (7.1)
6	0.26" (6.5)	-

Dimensions in Inches (mm)

Accessories

Dust Caps

Closure caps protect plugs and receptacles when not in use. Key style is for dual with thread of 1/2"-20 UNF.

Catalog Number	
MRCM2	
MPCM2	

Micro-Quick® Dual Key 2 - 6 Pole Receptacles

Choose the appropriate configuration from the Selector below.

Hubbell Logic Configurator

For example, catalog number **MRMS22325** is derived as follows:

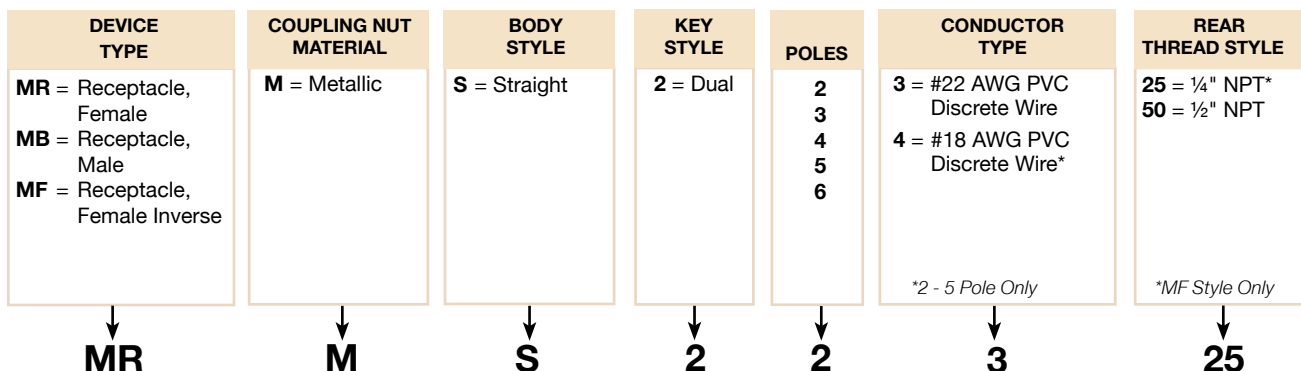





Note: Availability of specific items may vary. Consult factory for delivery. Consult the factory for additional cable lengths or cable types.

Male Receptacle Rear Thread Style		Female Inverse Receptacles Rear Thread Style	
M14 X 1	½" NPT	¼" NPT	

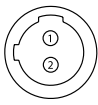
Micro-Quick® 2 - 6 Pole Dual Key Receptacles

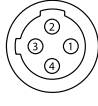
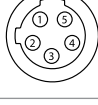
Catalog numbers using #22 AWG PVC cable are listed below. For #18 AWG PVC discrete wire, change the conductor type per the Hubbell Logic chart above.

Poles	Male Face Shown Female - mirror image	Female Receptacle Rear Thread Style		Male Receptacle Rear Thread Style		Female Inverse Receptacles
		¼" NPT	½" NPT	¼" NPT	½" NPT	¼" NPT
2		MRMS22325	MRMS22350	MBMS22325	MBMS22350	MFMS22325
3		MRMS23325	MRMS23350	MBMS23325	MBMS23350	MFMS23325
4		MRMS24325	MRMS24350	MBMS24325	MBMS24350	MFMS24325
5		MRMS25325	MRMS25350	MBMS25325	MBMS25350	MFMS25325
6		MRMS26325	MRMS26350	MBMS26325	MBMS26350	MFMS26325



Micro-Quick® Dual Key 2 - 6 Pole Receptacles

1/4" NPT Rear Thread Receptacle

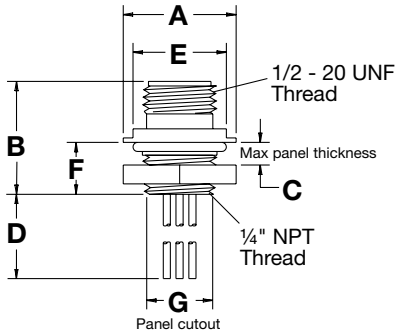

	MALE	FEMALE
A	0.75" (19.1)	0.75" (19.1)
B	0.75" (19.1)	0.86" (21.8)
C	0.10" (2.5)	0.10" (2.5)
D	12.0" (304.8)	12.0" (304.8)
E	0.62" (15.8)	0.62" (15.8)
F	0.35" (8.9)	0.38" (9.7)
G	0.56" (14.2)	0.56" (14.2)

Female Inverse Receptacle 1/4" NPT Rear Thread

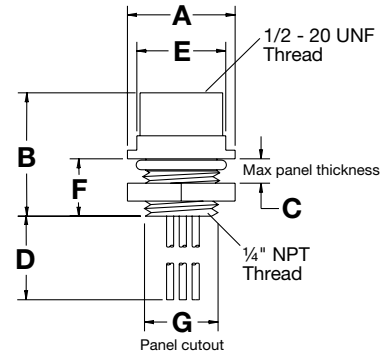

A	0.75" (19.1)
B	0.86" (21.8)
C	0.15" (3.8)
D	12.0" (304.8)
E	0.62" (15.8)
F	0.40" (10.2)
G	0.56" (14.2)

1/2" NPT Rear Thread Receptacle

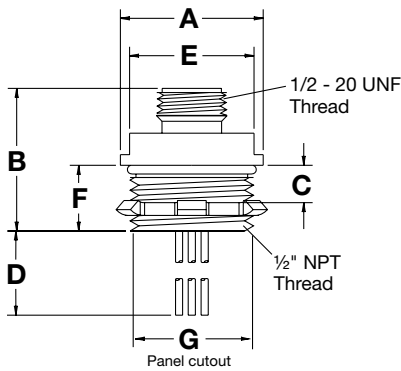

	MALE	FEMALE
A	1.00" (25.4)	1.00" (25.4)
B	1.00" (25.4)	1.00" (25.4)
C	0.24" (6.10)	0.24" (6.10)
D	12.0" (304.8)	12.0" (304.8)
E	0.87" (22.1)	0.87" (22.1)
F	0.46" (11.7)	0.46" (11.7)
G	0.85" (21.6)	0.85" (21.6)

Conductor Color Code - Dual Key

Contact Number	2 Pole	3 Pole	4 Pole	5 Pole	6 Pole
1	Brown	Green	Red/Black	Red/White	Red/White
2	Blue	Red/Black	Red/White	Red	Red
3		Red/White	Red	Green	Green
4			Green	Red/Yellow	Red/Yellow
5				Red/Black	Red/Black
6					Red/Blue

Accessories

Dust Caps

Closure caps protect plugs and receptacles when not in use. Key style is for dual with thread of 1/2"-20 UNF.

Catalog Number	
MRCM2	
MPCM2	

Dimensions in Inches (mm)

Features and Benefits

IP66
SUITABILITY

Micro-Quick® Field Attachable Connectors - Screw Terminal Style

Electrical Specifications

Voltage Rating	250V
Amperage	4A
Wire Size, Max	#18 AWG

Mechanical Specifications

Coupling Nut	Nickel plated brass, SST consult factory
Connector Shell	PBT
Connector Insert	Nylon
Contacts	Brass, gold plate over palladium nickel

Environmental Specifications

Moisture Resistance	IP66 Suitability
Operating Temperature	-40°C to 90°C



Housing Design

- High impact body design
- Strain relief protects terminations



Internal Design

- Superior contact design utilizing high performance gold over palladium nickel plating
- Coupling nut anodized aluminum, SST option consult factory
- Precision wire funnels eliminate stray strands

3 - 5 Pole Field Attachable Connectors

Poles	Male Face Shown Female - mirror image	Cable Range	Female Connector		Male In-Line Connector	
			Straight	Right Angle	Straight	Right Angle
3		.16"-.24" (4.1-6.1) .24"-.32" (6.1-8.1)	MCMS23F7	MCMA23F7	MIMS23F7	MIMA23F7
			MCMS23F9	MCMA23F9	MIMS23F9	MIMA23F9
4		.16"-.24" (4.1-6.1) .24"-.32" (6.1-8.1)	MCMS14F7	MCMA14F7	MIMS14F7	MIMA14F7
			MCMS14F9	MCMA14F9	MIMS14F9	MIMA14F9
5		.16"-.24" (4.1-6.1) .24"-.32" (6.1-8.1)	MCMS15F7	MCMA15F7	MIMS15F7	MIMA15F7
			MCMS15F9	MCMA15F9	MIMS15F9	MIMA15F9

Female, Straight



Female, Right Angle



Male In-Line, Straight



Male In-Line, Right Angle



Dimensions in Inches (mm)

Features and Benefits

IP66
SUITABILITY

Micro-Quick® Field Attachable Connectors - IDC Style

Allows field installation of control connector. Insulation Displacement Contacts do not require stripped conductors, greatly speeding installation.

Material Specifications

Housing	Polyester Elastomer, Black
Wire Guide	Nylon 6/6, Gray
Strain Relief Bushing	Neoprene, Black
Contact Materials	Copper Alloy
Contact Plating	Tin over Nickel
Coupling Nut	Zinc Alloy with Nickel Plating
O-ring	Neoprene, Black
Cable Compression Nut	Zinc Alloy with Nickel Plating

Electrical Specifications

Catalog Suffix	IDC	IDCL
Voltage Rating	32V AC/DC	50V AC/DC
Wire Range	#22 AWG max., #24 AWG min.	#18 AWG max., #22 AWG min.
Cable Diameters	.16" to .21" (4.1 to 5.3 mm)	.22" to .32" (5.6 to 8.1 mm)
Amperage	3A	6A
Contact Res.	< 5 mΩ	< 5 mΩ



Housing Design

- Rugged, nickel-plated hardware, excellent corrosion and abuse resistance
- Strain relief bushing protects terminations and provides IP66 ingress protection
- Operating temperature -20°C to 110°C



Internal Design

- Copper alloy insulation displacement contacts
- Wire guide for virtually toolless termination

Micro-Quick® IDC Style

Poles	Male Face Shown Female - mirror image	Cable Range	Wire Gauge	Female Connector		Male In-Line Connector	
				Straight	Right Angle	Straight	Right Angle
3		.16"-.21" (4.1-5.3) .22"-.32" (5.6-8.1)	22 - 24 18 - 22	MCMS13IDC	—	MIMS13IDC	—
				MCMS13IDCL	—	MIMS13IDCL	—
4		.16"-.21" (4.1-5.3) .22"-.32" (5.6-8.1)	22 - 24 18 - 22	MCMS14IDC	MCMA14IDC	MIMS14IDC	MIMA14IDC
				MCMS14IDCL	—	MIMS14IDCL	—

Female, Straight



Female, Right Angle



Male In-Line, Straight



Male In-Line, Right Angle



Dimensions in Inches (mm)

Features and Benefits

IP66
SUITABILITY

Nano-Quick® Control Connectors

- Nickel plated brass coupling nuts and receptacle shells
- Black overmold and cable
- Insulgrip connector body design
- UL Listed cable assemblies and receptacles
- Plating resists corrosion in high abuse environments
- Cable assembly resists dirt and blends with environment giving a clean look to the installation
- Third party certified for electrical, mechanical and environmental performance
- Ergonomic connector body has an industrial look
- Strong, resilient base metal ensures contacts maintain their shape and continuity over time



Housing Design

- Gated strain relief with graduated window sizes improves flexibility, strength and protects wire terminations; superior arc of bend control
- Operating temperature
 - PVC Cable: -20° to 105° C
 - TPE Cable: -40°C to 105° C



Internal Design

- Hard gold over palladium nickel contact plating; superior conductivity, extended contact life
- O-rings for moisture protection
- Anti-vibration coupling nut prevents connection from loosening under harsh vibration conditions
- Beryllium copper socket contacts ensures contacts maintain their shape and continuity

Material Specifications

Insulator Materials	Nylon 6/6, White	Cable	#24 AWG - PVC jacket, Black, PVC conductor insulation, Copper braid - 85% coverage, Stranding 19/36
Contact Materials	Pins - Brass, Sockets Sockets - Beryllium copper		#24 AWG - TPE jacket, Black, PVC conductor insulation, Stranding - 19/36
Contact Plating	Hard gold over palladium/nickel	Strain Relief	20 pounds min per UL 2238
Overmold Material	Polyurethane, Black		
Coupling Nut, Metallic	Nickel plated brass		
Receptacle Shell	Nickel plated brass		

Electrical Specifications

Voltage Rating	125V AC/75V DC
Amperage	3&4P=4A
Contact Resistance	≤ 5 mΩ
Isolation Resistance	≥ 1000 MΩ

Environmental Specifications

Moisture Protection	UL Type 4, 4X, 12 and 13
Ingress Protection	IP66 Suitability
Operating Temperature	PVC Cable: -20° to 105° C TPE Cable: -40°C to 105° C
Corrosion Resistance	500 hours salt spray per MIL-STD-1344, Method 1001
Vibration Resistance	10 - 2,000 Hz @15g per MIL-STD1344, Method 2005

Certifications

UL 2238 and UL50E, File No. E192071

CSA Certified, C22.2 No. 182.3 and CSA C22.2 No. 94.2-07



Nano-Quick® 3 - 4 Pole Plugs and Receptacles

Choose the appropriate configuration from the Selector below.

Hubbell Logic Configurator

For example, catalog number **NCTA3105** is derived as follows:

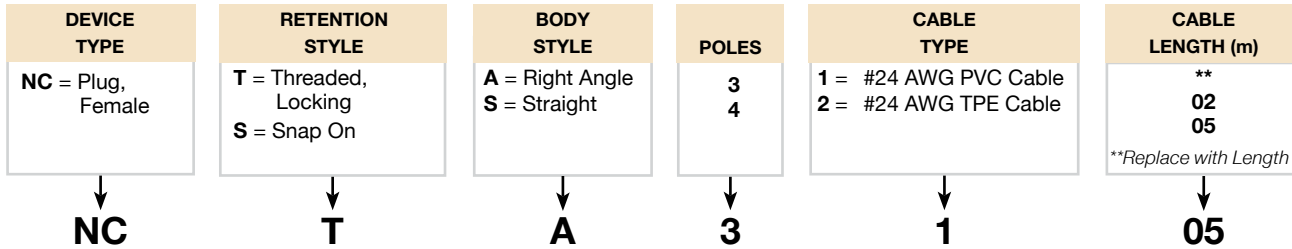

Note: Availability of specific items may vary. Consult factory for delivery. Use this chart to build plugs to meet any application need. Consult the factory for additional cable lengths or cable types.

3 - 4 Pole Female Plugs

Catalog numbers using #24 AWG PVC cable are listed below. For #24 AWG TPE cable, change the cable type per the Hubbell Logic chart above.

Poles	Female Face Shown	Cable Length	Threaded, Locking		Snap Together	
			Straight	Right Angle	Straight	Right Angle
3		6.56 ft (2m) 16.40 ft (5m) All other lengths ▲	NCTS3102	NCTA3102	NCSS3102	NCSA3102
			NCTS3105	NCTA3105	NCSS3105	NCSA3105
			NCTS31**	NCTA31**	NCSS31**	NCSA31**
4		6.56 ft (2m) 16.40 ft (5m) All other lengths ▲	NCTS4102	NCTA4102	NCSS4102	NCSA4102
			NCTS4105	NCTA4105	NCSS4105	NCSA4105
			NCTS41**	NCTA41**	NCSS41**	NCSA41**

Note: ▲ Replace ** with length required in feet. For snap on retention style, replace "T" with "S" per the ordering chart above.
Example: change NCTA3105 to NCSA3105.

Hubbell Logic Configurator

For example, Catalog Number **NBCS3D** is derived as follows:

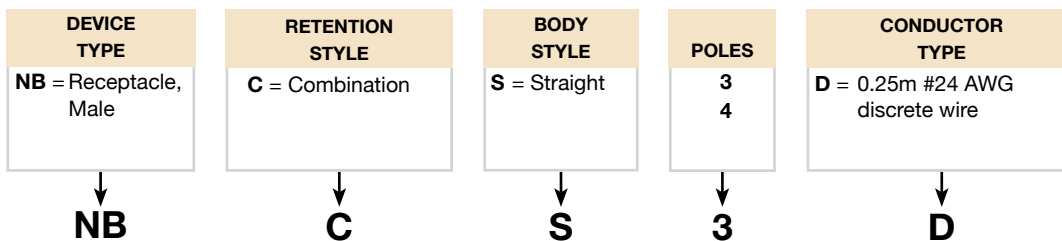

3 - 4 Pole Male Receptacles

Poles	Male Face Shown	Male Receptacle Rear Thread Style
		M8 x 1
3		NBCS3D

Poles	Male Face Shown	Male Receptacle Rear Thread Style
		M8 x 1
4		NBCS4D

Note: Replace ** with length required in feet.

Nano-Quick® 3 - 4 Pole Plugs and Receptacles

Straight Female Locking Plug

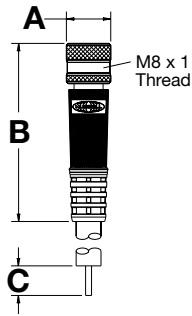

A	0.38" (9.7)
B	1.51" (38.4)
C	2.75" (69.9)

Right Angle Female Locking Plug

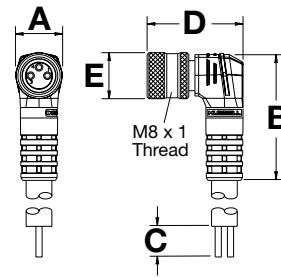

A	0.39" (9.9)
B	1.04" (26.4)
C	2.75" (69.9)
D	0.78" (19.8)
E	0.38" (9.7)

Straight Female Snap Together Plug

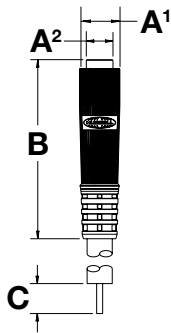

A¹	0.34" (8.6)
A²	0.22" (5.6)
B	1.50" (38.1)
C	2.75" (69.9)

Right Angle Female Snap Together Plug

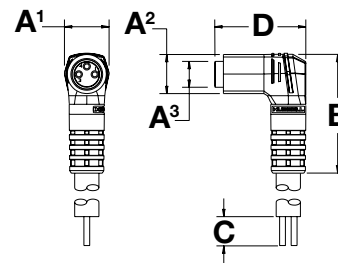

A¹	0.39" (9.9)
A²	0.38" (9.7)
A³	0.22" (5.6)
B	1.04" (26.4)
C	2.75" (69.9)
D	0.79" (20.1)

Male Combination Receptacle

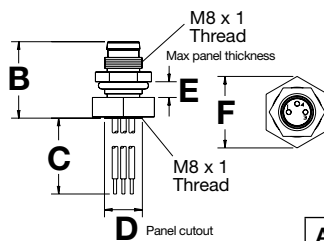

A	0.31" (7.9)
B	0.63" (16.0)
C	12.0" (304.8)
D	0.35" (8.8)
E	0.80" (2.0)
F	0.59" (15.0)

Cable Diameters By Cable Type

Number of Conductors	#24 AWG PVC	#24 AWG TPE
3	0.21" (5.3)	0.21" (5.3)
4	0.21" (5.3)	0.21" (5.3)

Conductor Color Code

Contact Number	3 Pole	4 Pole
1	Brown	Brown
2	Not Used	White
3	Blue	Blue
4	Black	Black

Dimensions in Inches (mm)



Features and Benefits

IP66
SUITABILITY

Nano-Quick® Field Attachable Connectors - IDC Style

Allows field installation of control connector. Insulation Displacement Contacts do not require stripped conductors, greatly speeding installation.

Material Specifications

Housing	Polyester Elastomer, Black
Wire Guide	Nylon 6/6, Gray
Strain Relief Bushing	Neoprene, Black
Contact Materials	Copper Alloy
Contact Plating	Tin over Nickel
Coupling Nut	Zinc Alloy with Nickel Plating
O-ring	Neoprene, Black
Cable Compression Nut	Zinc Alloy with Nickel Plating

Electrical Specifications

Voltage Rating	32VAC/DC
Wire Range	#22 AWG max., #24 AWG min.
Cable Diameters	.13" to .21" (3.3 to 5.3 mm)
Amperage	3A
Contact Resistance	< 5 mΩ



Housing Design

- Rugged, nickel-plated hardware, excellent corrosion and abuse resistance
- Strain relief bushing protects terminations and provides IP66 ingress protection
- Operating temperature -20°C to 110°C



Internal Design

- Copper alloy insulation displacement contacts
- Wire guide for virtually toolless termination

Nano-Quick® IDC

Poles	Male Face Shown Female - mirror image	Cable Range	Wire Gauge	Female Connector	Male Connector
				Straight	Straight
3		.13"-.21" (3.3-5.3)	22 - 24	NCTS13IDC	NITS13IDC
4		.13"-.21" (3.3-5.3)	22 - 24	—	NITS14IDC

Female, Straight



Male, Straight



Dimensions in Inches (mm)



IP66
SUITABILITY

Signal-Quick® Cushioned Sensor Mounts

Install tubular proximity sensors with a Cushioned Sensor Mount and protect against over-travel damage. Reduces replacement expenses and downtime. Hubbell's Cushioned Sensor Mounts feature:

- Spring-loaded housing eliminates impact damage
- Reduces downtime and replacement expenses
- Reduces spare sensor inventories
- Shielded and non-shielded end caps eliminate abrasion damage
- Block style or threaded housing designs
- Anodized aluminum or stainless steel

When something out of the ordinary happens or targets over-travel, the sensor simply retracts to avoid damage. The sensor returns to its original position and the equipment continues to operate.

Material Specifications

Material: Anodized aluminum housing
Zinc-plated brass jam nuts
CSM12LP is all Stainless Steel

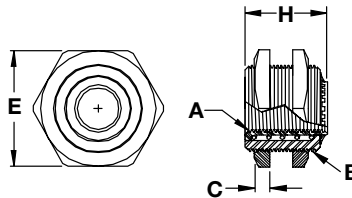

Threaded Style

Threaded Style

Catalog Number	A	B	C	E	H
CSM8	M8 x 1	M16 x 1.5	0.12" (3.1)	0.87" (22.1)	0.87" (22.1)
CSM12LP	M12 x 1	M18 x 1	0.16" (4.1)	0.95" (24)	0.83" (21.1)
CSM18	M18 x 1	M30 x 1.5	0.20" (5.1)	1.41" (35.8)	1.17" (29.7)
CSM30	M30 x 1.5	M47 x 1.5	0.20" (5.1)	2.01" (51)	1.47" (37.3)

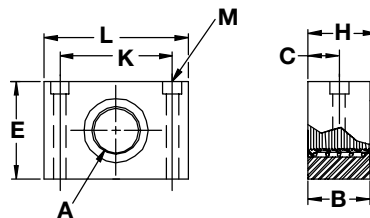

Block Style

Block Style

Catalog Number	A	B	C	E	H	K	L	M
BCSM8	M8 x 1	0.75" (19)	0.37" (9.5)	0.62" (15.8)	0.87" (22.1)	0.72" (18.4)	1.0" (25.4)	0.14" (3.6)
BCSM12	M12 x 1	0.75" (19)	0.37" (9.5)	1.0" (25.4)	0.87" (22.1)	0.98" (24.8)	1.5" (38.1)	0.20" (5.2)
BCSM18	M18 x 1	1.0" (25.4)	0.50" (12.7)	1.25" (31.7)	1.17" (29.7)	1.21" (30.7)	1.5" (38.1)	0.18" (4.6)
BCSM30	M30 x 1.5	1.38" (34.9)	0.68" (17.5)	2.0" (50.8)	1.47" (37.4)	2.03" (51.5)	2.5" (63.5)	0.26" (6.7)

Dimensions in Inches (mm)



Signal-Quick® Sensor Mounting Brackets

Eliminate design time and fabrication expense. Choose the Hubbell Angle Bracket or Flat Bracket to mount any tubular proximity sensor.

- Fixed mounting patterns or multi-slotted for positioning versatility.
- Industry standard mounting footprints.
- Rapid installation.
- Immediately available from stock.
- Cost savings over “make your own”.

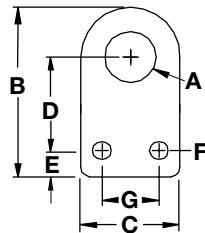

Material Specifications

Material: Stainless Steel

Flat Brackets

Catalog Number	A	B	C	D	E	F	G	Thickness
FB12	0.48" (12.1)	1.95" (49.6)	1.25" (31.8)	0.86" (21.8)	0.47" (11.9)	0.22" (5.54)	0.75" (19.1)	0.12" (3.02)
FB18	0.72" (18.2)	2.27" (57.6)	1.38" (34.9)	1.36" (34.6)	0.22" (5.56)	0.24" (6.05)	1.0" (25.4)	0.12" (3.02)
FB30	1.19" (30.1)	3.42" (86.9)	2.0" (50.8)	2.05" (52)	0.37" (9.40)	0.31" (7.94)	1.25" (31.8)	0.12" (3.02)

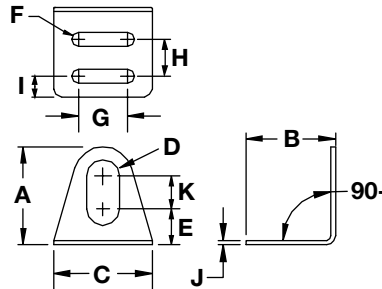

Material Specifications

Material: Stainless steel
Zinc-plated steel (AAB47)

Adjustable Angle Brackets

Catalog Number	A	B	C	D	E	F	G	H	I	J	K
AAB08	1.0" (25.4)	1.25" (31.8)	1.25" (31.8)	0.34" (8.74)	0.31" (7.92)	0.22" (5.54)	0.62" (15.9)	0.46" (11.9)	0.28" (7.14)	0.07" (1.78)	0.38" (9.53)
AAB12	1.5" (38.1)	1.37" (34.8)	1.5" (38.1)	0.50" (12.7)	0.55" (13.9)	0.22" (5.54)	0.75" (19.1)	0.56" (14.3)	0.31" (7.92)	0.07" (1.78)	0.50" (12.7)
AAB18	2.0" (50.8)	1.37" (34.8)	1.75" (44.5)	0.72" (18.3)	0.75" (19.1)	0.22" (5.54)	1.0" (25.4)	0.56" (14.3)	0.31" (7.92)	0.07" (1.78)	0.63" (15.9)
AAB22	2.0" (50.8)	1.37" (34.8)	1.75" (44.5)	0.88" (22.2)	0.69" (17.4)	0.22" (5.54)	1.0" (25.4)	0.56" (14.3)	0.31" (7.92)	0.07" (1.78)	0.63" (15.9)
AAB30	2.5" (63.5)	1.75" (44.5)	2.25" (57.2)	1.19" (30.1)	0.91" (23)	0.28" (7.11)	1.37" (34.8)	0.81" (20.6)	0.41" (10.3)	0.09" (2.29)	0.75" (19.1)

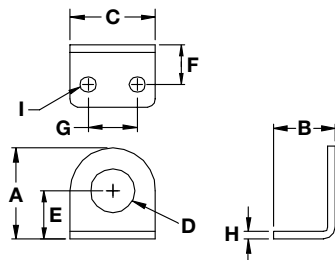

Material Specifications

Material: Stainless Steel

Angle Brackets

Catalog Number	A	B	C	D	E	F	G	H	I
AB12	1.16" (29.3)	1.0" (25.4)	1.25" (31.8)	0.48" (12.1)	0.53" (13.5)	0.53" (13.5)	0.75" (19.1)	0.12" (3.02)	0.22" (5.6)
AB18	1.47" (37.3)	1.0" (25.4)	1.38" (34.9)	0.48" (12.1)	0.53" (13.5)	0.78" (19.8)	1.0" (25.4)	1.12" (3.02)	0.24" (6.0)
AB30	2.13" (54.0)	1.50" (38.1)	2.00" (50.8)	1.19" (30.1)	1.13" (28.7)	1.13" (28.7)	1.25" (31.8)	0.12" (3.02)	0.31" (7.9)

Dimensions in Inches (mm)



Signal-Quick® End Caps

- Use alone or with Cushioned Sensor Mount.
- Beveled edge deflects lateral impacts.
- Reduces and or eliminates abrasion damage.
- Reduces downtime and sensor replacement expenses.



Specifications

Material: Delrin (Non-Shielded)
Glass-filled Nylon (Shielded)
Polypropylene (EC30)

Shielded

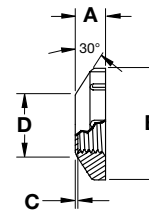

Non-Shielded

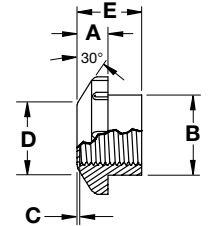

End Caps

Shielded	Style	A	B	C	D	E	Thread
EC08	8mm	0.21" (5.28)	0.60" (15.2)	0.015" (.38)	0.25" (6.45)	N/A	M8 x 1
EC12	12mm	0.25" (6.35)	0.96" (24.4)	0.015" (.38)	0.45" (11.4)	N/A	M12 x 1
EC18	18mm	0.33" (8.38)	1.23" (31.3)	0.03" (.76)	0.73" (17.5)	N/A	M18 x 1
EC30	30mm	0.30" (7.62)	1.72" (43.7)	0.03" (.76)	1.13" (28.6)	N/A	M30 x 1
Non-Shielded							
EC08N	8mm	0.20" (5.08)	0.57" (14.5)	0.015" (.38)	0.25" (6.45)	0.37" (9.50)	M8 x 2
EC12N	12mm	0.25" (6.35)	0.90" (22.9)	0.03" (.76)	0.45" (11.4)	0.68" (17.3)	M12 x 1
EC18N	18mm	0.33" (8.38)	1.34" (34.0)	0.025" (.64)	0.67" (17.0)	0.70" (17.8)	M18 x 1
EC30N	30mm	0.31" (7.87)	1.75" (44.5)	0.04" (1.02)	1.15" (29.2)	0.90" (22.9)	M30 x 1

Note: The wear surface thickness (Dimension C) does not reduce a sensor's sensing range, but will consume an equal amount of the gap required between the sensor and target.

Signal-Quick® Block Mounts

Bond to sensor face with any epoxy.

- Use when threads are inaccessible.
- Reduces and/or eliminates abrasion damage.
- Reduces downtime and sensor replacement expenses.



Specifications

Material: Glass-filled Nylon
Anodized aluminum

Metallic

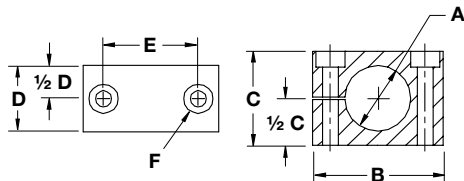

Nylon

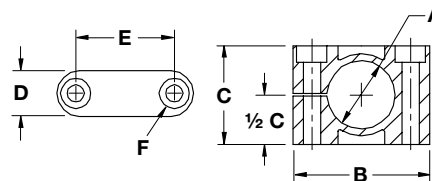

Block Mounts

Metallic	Style	A	B	C	D	E	F
BM08M	8mm	0.32" (8.05)	0.62" (15.8)	1.0" (25.4)	0.75" (19.0)	0.72" (18.4)	0.14" (3.58)
BM12M	12mm	0.48" (12.1)	1.0" (25.4)	1.5" (38.1)	0.75" (19.0)	0.98" (24.9)	0.20" (5.08)
BM18M	18mm	0.71" (18.1)	1.25" (31.7)	1.5" (38.1)	1.0" (25.4)	1.21" (30.7)	0.18" (4.58)
BM30M	30mm	1.19" (30.1)	2.0" (50.8)	2.5" (63.5)	1.38" (34.9)	2.03" (51.5)	0.26" (6.73)
Nylon							
BM08N	8mm	0.32" (8.05)	1.06" (27)	0.63" (16)	0.47" (12)	0.67" (17)	0.18" (4.5)
BM12N	12mm	0.48" (12.1)	1.26" (32)	0.79" (20)	0.47" (12)	0.87" (22)	0.18" (4.5)
BM16N	16mm	0.63" (16.1)	1.42" (36)	1.02" (26)	0.47" (12)	1.02" (26)	0.18" (4.5)
BM18N	18mm	0.71" (18.1)	1.42" (36)	1.02" (26)	0.47" (12)	1.02" (26)	0.18" (4.5)
BM20N	20mm	0.79" (20.1)	1.77" (45)	1.18" (30)	0.59" (15)	1.26" (32)	0.22" (5.5)
BM22N	22mm	0.87" (22.1)	1.77" (45)	1.18" (30)	0.59" (15)	1.26" (32)	0.22" (5.5)
BM30N	30mm	1.18" (30.1)	2.17" (55)	1.50" (38)	0.71" (18)	1.65" (42)	0.22" (5.5)

Dimensions in Inches (mm)



Signal-Quick® Universal Aiming Brackets

Attach limit switch style (30mm threaded base) or threaded barrel photoelectric and ultrasonic sensors. Achieve secure mounting quickly and with ease.

- Swivel action for aiming simplicity.
- Durable glass-filled nylon construction.
- Regular or extended base models.
- Sizes for 12, 18 and 30mm threaded sensors.



Material Specifications

Material: Glass-filled Nylon

Bracket, Standard

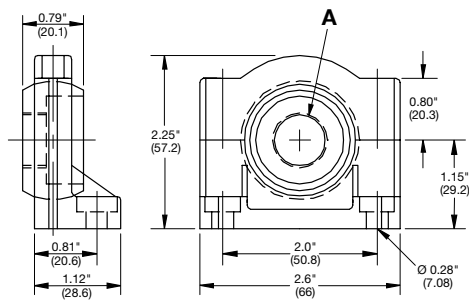

Bracket, Extended

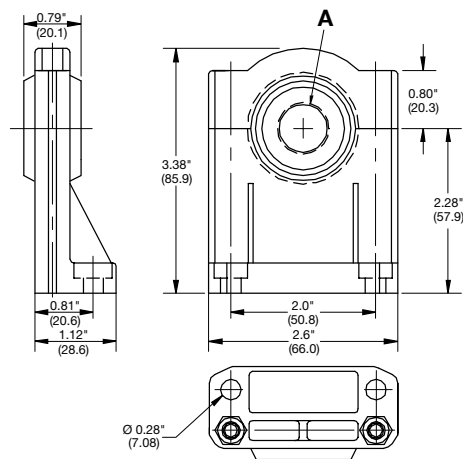

Universal Aiming Brackets

Catalog Number	Style	Description	Thread
UB12	12mm	Bracket	M12 x 1
UB12E	12mm	Bracket, Extended Base	M12 x 1
UB18	18mm	Bracket	M18 x 1
UB18E	18mm	Bracket, Extended Base	M18 x 1
UB30	30mm	Bracket	M30 x 1.5
UB30E	30mm	Bracket, Extended Base	M30 x 1.5

Dimensions in Inches (mm)



CableTrak® Hose and Cable Carrier System

The design of CableTrak carriers provides easy access to components during installation and repair. The track's flip top design allows the installer to lay cable and hose components directly into the track instead of pulling them through the length of the track. Hubbell CableTrak carriers can be ordered as assembled kits with brackets or by the foot without brackets. The final length of the track is easily customized by adding or removing sections of track or individual links with a flat head screwdriver.



CableTrak® Installation

1. Unlock Tab.
2. Locking tabs secure the retaining bar into place.
To unlock tabs, slide a flat head screwdriver under the tab and release it with a twisting motion.

Access/Install Cables and Hoses

3. Easy access is important, especially for pre-assembled cable/hose sets involving large O.D. plugs, receptacles, and couplings.
4. Lock Tab.
5. To re-secure retaining bars, engage the hinge and snap the locking tab into place.

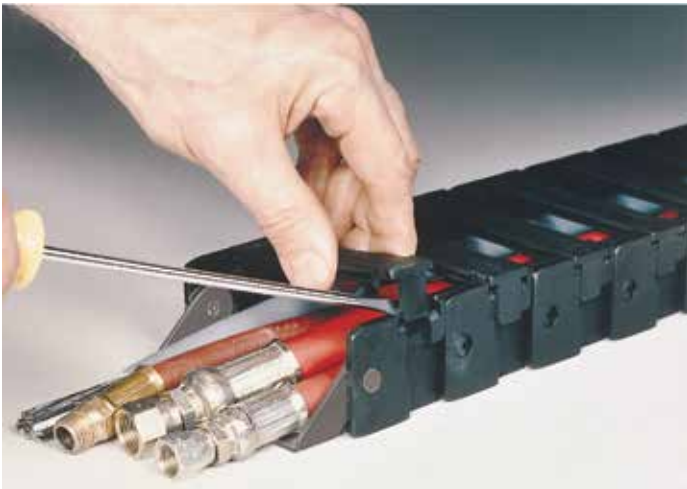



CableTrak® Kits

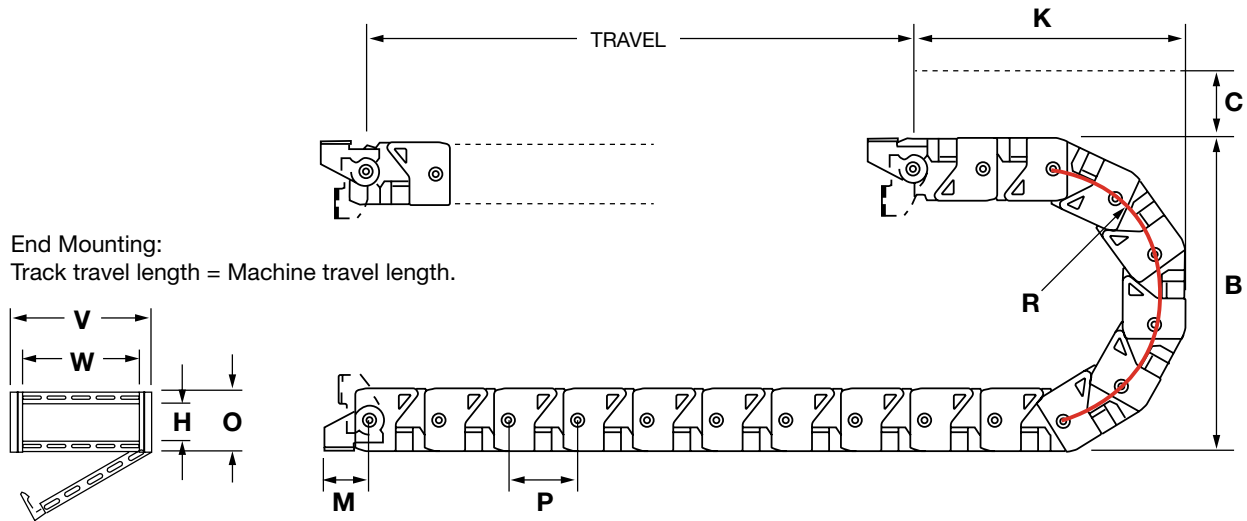

CableTrak® Kit with Brackets

Catalog Number	Track Length (ft)	W Inner Width	H Inner Height	A Max Hose/Cab O.D.	B Max Component Width	V Outer Width	O Outer Height	R Bend Radius	B Bend Height	C Clearance	K Min Brkt to Bend	M Brkt to Pivot	P Pitch	L* Curve Length (ft)
HCT10114K**	4.0'	0.59"	0.75"	0.286"	0.531"	1.03"	1.00"	1.44"	3.86"	2.00"	5.68"	1.33"	1.250"	1.000'
HCT10219K**	4.0'	1.00"	0.75"	0.382"	0.900"	1.44"	1.00"	1.91"	4.82"	2.00"	5.41"	1.33"	1.250"	1.000'
HCT16119K	4.0'	1.50"	1.00"	0.382"	1.350"	2.12"	1.62"	1.91"	5.44"	3.00"	5.72"	1.19"	1.812"	1.000'
HCT16134K	4.5'	1.50"	1.00"	0.688"	1.350"	2.12"	1.62"	3.44"	8.50"	3.00"	7.85"	1.19"	1.812"	1.500'
HCT16219K	4.0'	2.28"	1.00"	0.328"	2.052"	2.91"	1.62"	1.91"	5.44"	3.00"	5.72"	1.19"	1.812"	1.000'
HCT16234K	4.5'	2.28"	1.00"	0.688"	2.052"	2.91"	1.62"	3.44"	8.50"	3.00"	7.85"	1.19"	1.812"	1.500'
HCT16334K	4.5'	3.08"	1.00"	0.688"	2.772"	3.70"	1.62"	3.44"	8.50"	3.00"	7.85"	1.19"	1.812"	1.500'
HCT16434K	4.5'	4.06"	1.00"	0.688"	3.654"	4.69"	1.62"	3.44"	8.50"	3.00"	7.85"	1.19"	1.812"	1.500'
HCT25134K	4.5'	2.60"	1.75"	0.680"	2.340"	3.70"	2.50"	3.40"	9.30"	3.00"	8.31"	1.75"	2.500"	1.500'
HCT25234K	4.5'	4.25"	1.75"	0.680"	3.825"	5.36"	2.50"	3.40"	9.30"	3.00"	8.31"	1.75"	2.500"	1.500'
HCT25247K	5.0'	4.25"	1.75"	0.956"	3.825"	5.36"	2.50"	4.78"	12.06"	3.00"	10.52"	1.75"	2.500"	2.000'
HCT25347K	5.0'	6.60"	1.75"	0.956"	5.940"	7.70"	2.50"	4.78"	12.06"	3.00"	10.52"	1.75"	2.500"	2.000'

CableTrak® Kit without Brackets

Catalog Number	Track Length (ft)	W Inner Width	H Inner Height	A Max Hose/Cab O.D.	B Max Component Width	V Outer Width	O Outer Height	R Bend Radius	B Bend Height	C Clearance	P Pitch	L* Curve Length (ft)
HCT101141**	1.0'	0.59"	0.75"	0.286"	0.531"	1.03"	1.00"	1.44"	3.86"	2.00"	1.250"	1.000'
HCT102191**	1.0'	1.00"	0.75"	0.382"	0.900"	1.44"	1.00"	1.91"	4.82"	2.00"	1.250"	1.000'
HCT161191	1.0'	1.50"	1.00"	0.382"	1.350"	2.12"	1.62"	1.91"	5.44"	3.00"	1.812"	1.000'
HCT161341	1.0'	1.50"	1.00"	0.688"	1.350"	2.12"	1.62"	3.44"	8.50"	3.00"	1.812"	1.500'
HCT162191	1.0'	2.28"	1.00"	0.328"	2.052"	2.91"	1.62"	1.91"	5.44"	3.00"	1.812"	1.000'
HCT162341	1.0'	2.28"	1.00"	0.688"	2.052"	2.91"	1.62"	3.44"	8.50"	3.00"	1.812"	1.500'
HCT163341	1.0'	3.08"	1.00"	0.688"	2.772"	3.70"	1.62"	3.44"	8.50"	3.00"	1.812"	1.500'
HCT164341	1.0'	4.06"	1.00"	0.688"	3.654"	4.69"	1.62"	3.44"	8.50"	3.00"	1.812"	1.500'
HCT251341	1.0'	2.60"	1.75"	0.680"	2.340"	3.70"	2.50"	3.40"	9.30"	3.00"	2.500"	1.500'
HCT252341	1.0'	4.25"	1.75"	0.680"	3.825"	5.36"	2.50"	3.40"	9.30"	3.00"	2.500"	1.500'
HCT252471	1.0'	4.25"	1.75"	0.956"	3.825"	5.36"	2.50"	4.78"	12.06"	3.00"	2.500"	2.000'
HCT253471	1.0'	6.60"	1.75"	0.956"	5.940"	7.70"	2.50"	4.78"	12.06"	3.00"	2.500"	2.000'

Note: *L = Minimum length in feet to form CableTrak curve.

**These models do not have a flip top design and do not accept separators due to their small size.

Dimensions in Inches (mm)



CableTrak® Accessories

Center Mounting: Mounting the fixed track end in the center of the machine travel allows the track to travel beyond the fixed end. Center mounting effectively doubles the travel distance of the track requiring half the track length of an end mounted application.

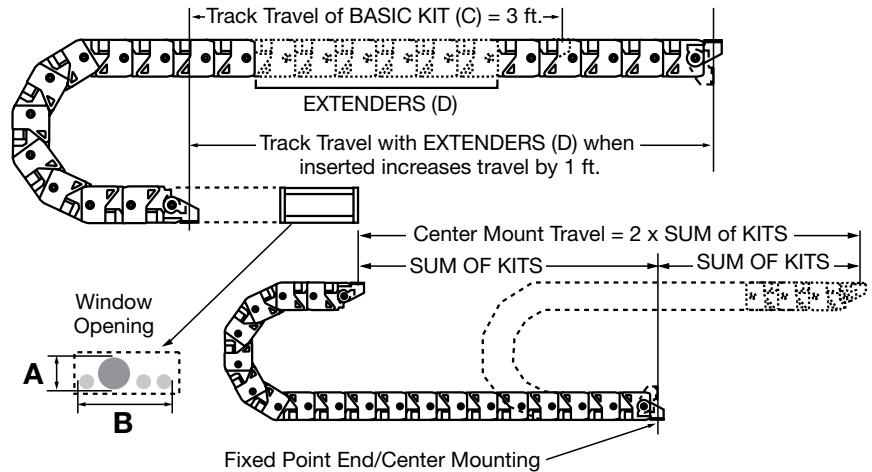

Calculating

Center Mount (Stationary bracket mounted in center of travel range): $\text{Track Length} = (\text{MT}/2) + L$

End Mount (Stationary bracket mounted off center of travel range): $\text{Track Length} = (\text{MT}/2) + L + \text{offset from center in feet}$

MT = Total machine travel distance in feet

L = Length of track taken up by the bend radius

Customizing Track Length

Hubbell CableTrak is easily customized by adding or subtracting links to the track. CableTrak kits provide 4 to 5 feet of track with brackets pre-installed. Track length can be increased by installing the required number of extenders to reach the required length. To further tune the length of track, individual links can be added or removed. To determine the number of links to add or remove, divide the length in inches to be added or subtracted by the pitch of the track and round up.

CableTrak® Accessories

Bracket Kits	For Use With	A	B	C	D	E	F	G	H
HCTBK101	HCT101 Series	.40" (10.2)	.81" (20.6)	.47" (12.0)	.94" (23.9)	–	–	–	–
HCTBK102	HCT102 Series	.44" (11.2)	1.22" (31.0)	.44" (11.2)	1.35" (34.3)	–	–	–	–
HCTBK161	HCT161 Series	.99" (25.2)	1.97" (50.1)	.87" (22.1)	1.84" (46.7)	1.19" (30.2)	.281" (7.1)	.75" (19.1)	.81" (20.6)
HCTBK162	HCT162 Series	1.78" (45.2)	2.75" (69.9)	1.65" (41.9)	2.63" (66.8)	1.19" (30.2)	.281" (7.1)	.75" (19.1)	.81" (20.6)
HCTBK163	HCT163 Series	2.57" (65.3)	3.55" (90.2)	2.44" (62.0)	3.42" (86.9)	1.19" (30.2)	.281" (7.1)	.75" (19.1)	.81" (20.6)
HCTBK164	HCT164 Series	3.56" (90.4)	4.53" (115.1)	3.47" (88.1)	4.41" (112.0)	1.19" (30.2)	.281" (7.1)	.75" (19.1)	.81" (20.6)
HCTBK251	HCT251 Series	2.08" (52.8)	3.21" (81.5)	1.80" (45.7)	3.03" (77.0)	1.75" (44.5)	.344" (8.7)	1.00" (25.4)	1.25" (31.8)
HCTBK252	HCT252 Series	3.74" (95.0)	4.87" (123.7)	3.46" (87.9)	4.69" (119.1)	1.75" (44.5)	.344" (8.7)	1.00" (25.4)	1.25" (31.8)
HCTBK253	HCT253 Series	6.08" (154.4)	7.21" (183.1)	5.80" (147.3)	7.03" (178.6)	1.75" (44.5)	.344" (8.7)	1.00" (25.4)	1.25" (31.8)
Separators	For Use With	A	B	C	D	E	F		
HCTSP16PK12	HCT16 Series	1.24" (31.5)	.82" (20.8)	.94" (23.9)	.27" (6.9)	.14" (3.6)	.50" (12.7)		
HCTSP25PK12	HCT25 Series	2.03" (51.6)	1.00" (25.4)	1.19" (30.2)	.35" (8.9)	.15" (3.8)	.62" (15.8)		

HCTBK101 – Brackets

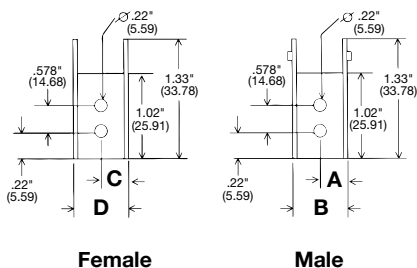

HCTBK102 – Brackets

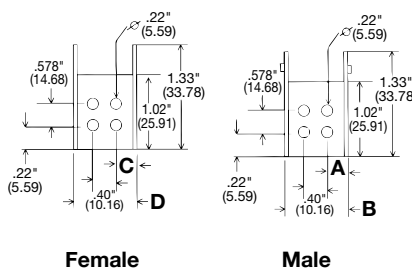

HCTBK161 – HCTGK253 Brackets

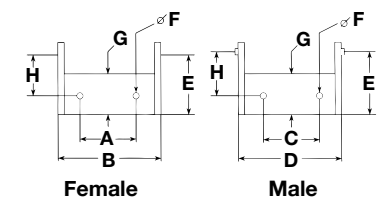

Separators

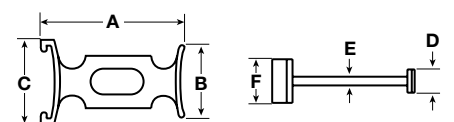

Dimensions in Inches (mm)



CableTrak® System Mounting Options

Horizontal Travel

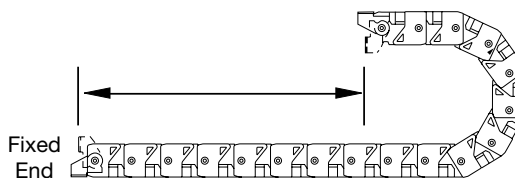
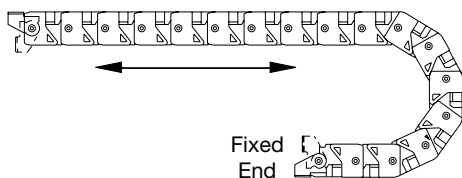

Combination Horizontal & Vertical Travel

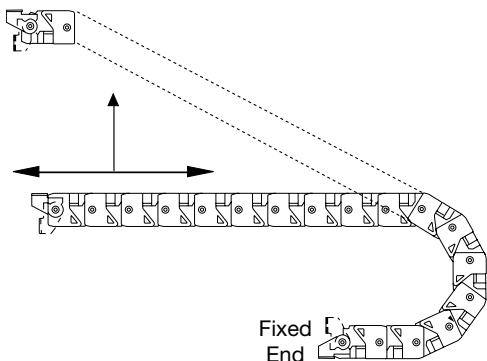

Opposed Travel



Vertical Travel

Curve Up

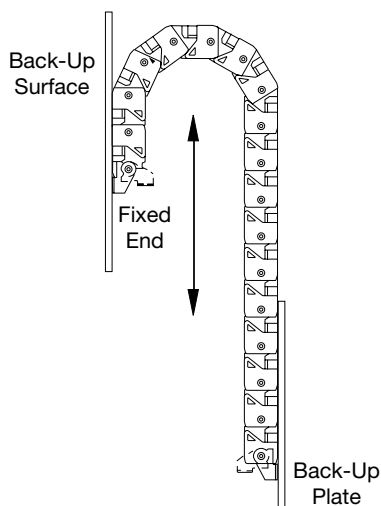

Curve Down

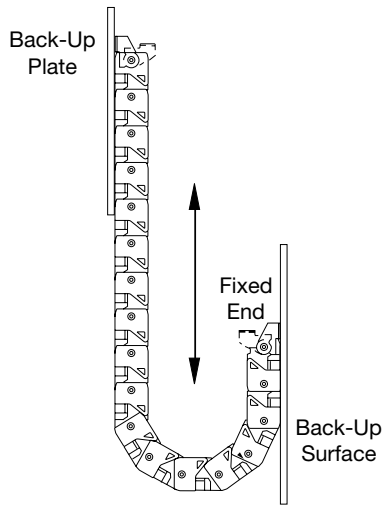

Specifications

Material	Fiberglass reinforced nylon.
Operating Temperature	Continuous +20°F to +100°F (-7°C to 38°C). Intermittent* -40°F to +220°F (-40°C to 104°C).
Maximum Operating Speed	600 FPM (feet per minute), 180 MPM (meters per minute). Operating speed is based on short lengths that are self supported (up to 9ft.).
Maximum Unsupported Travel Distance	HCT16 Series without sag 9 ft. (2.8 m) with sag 10.5 ft. (3.2 m). HCT25 Series without sag 13.5 ft. (4.1 m) with sag 17 ft. (5.2 m).
Applications	Machine tool, robotic automation, material handling.

Note: *Intermittent refers to the operating of the product outside the normal (continuous operating) temperature range momentarily before returning back to the normal range.

DIN Rail Utility Box

Hubbell's DIN Rail Utility Box offers a labor saving way to provide utility power to any control cabinet. Installing the DIN Rail Utility Box is as easy as snapping the box onto a 35mm DIN Rail and connecting the line, neutral and ground wires to the terminal block. Utility power for fans, lights, laptop computers, testers or any other power requirement. If load limiting is a concern, Hubbell's "CB" version comes with a 5 Amp circuit breaker that provides over-current protection to make sure that large loads are not drawn from the DIN Rail Utility Box. All Hubbell DIN Rail Utility Boxes may be mounted either vertically or horizontally on the DIN Rail; the "H" version comes with the terminal block mounted for easy wiring when the DIN Rail Utility Box is mounted horizontally.



15A 125V
NEMA 5-15R
UL CSA
0.5 HP



20A 125V
NEMA 5-20R
UL CSA
1 HP

Duplex Receptacles

Description	Color	Catalog Number	
Complete unit.	Gray	DRUB15	DRUB20
Complete unit, horizontal mount.	Gray	DRUB15H	-
Complete unit with 5A circuit breaker.	Gray	DRUB15CB5	-
Complete unit with 5A circuit breaker, horizontal.	Gray	DRUB15HCB5	-
Complete unit with aux.	Gray	-	DRUB20AC
Complete unit with aux and 5A circuit breaker.	Gray	-	DRUB20ACCB5
Complete unit with NEMA® 6-20R duplex (250V).	Gray	-	DRUB5462*

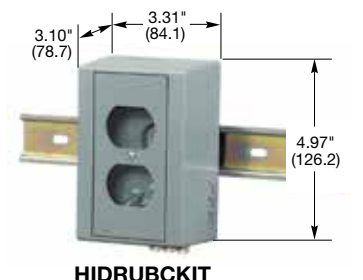
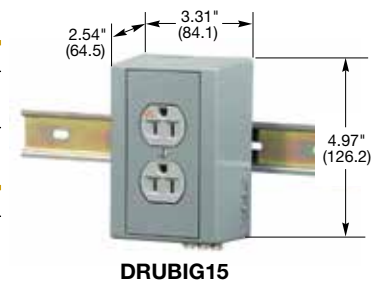
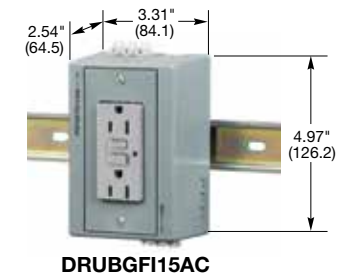
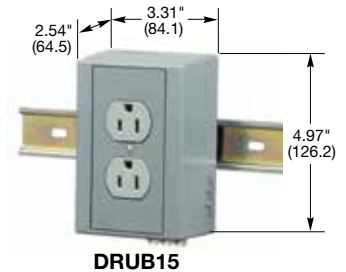

GFCI Duplex Receptacles

Description	Color	Catalog Number	
Complete unit.	Gray	DRUBGFI15	DRUBGFI20
Complete unit, horizontal.	Gray	DRUBGFI15H	-
Complete unit with 5A circuit breaker.	Gray	DRUBGFI15CB5	-
Complete unit with 5A circuit breaker, horizontal.	Gray	DRUBGFI15HCB5	-
Complete unit with aux GFCI contacts.	Gray	DRUBGFI15AC	DRUBGFI20AC
Complete unit, faceless with aux GFCI contacts.	Gray	-	DRUBGFI20BFAC

TVSS Duplex Receptacles

Description	Color	Catalog Number	
Complete unit.	Gray	DRUBTVSS15	-
Complete unit with aux contacts.	Gray	DRUBTVSS15AC	-

Isolated Ground^Δ Duplex Receptacles

Description	Color	Catalog Number	
Complete unit.	Gray	DRUBIG15	-

Toggle Switch Unit

Description	Color	Catalog Number	
Complete unit with HBL1221.	Gray	DRUB1221AC	
Complete unit with 15A 125V SW/REC.	Gray	DRUB6404	

DIN Rail Utility Box Components

Description	Color	Catalog Number	
Pre-wired kit without circuit breaker.	Gray	DRUBKIT	
Pre-wired kit with circuit breaker.	Gray	DRUBKITCB5	
Pre-wired kit with aux.	Gray	DRUBKITAC	
Pre-wired kit with circuit breaker and aux.	Gray	DRUBKITACCB5	
Communications kit (unloaded).	Gray	HIDRUBCKIT	
(For use with Network Wiring frames in section W).			
Switch plate only.	Gray	KP1GY**	
Rectangular opening plate only.	Gray	KP26GY**	
1.60 in. opening plate only.	Gray	KP720GY**	
1.40 in. opening plate only.	Gray	KP7GY**	
Duplex receptacle plate only.	Gray	KP8GY**	

Note: ^ΔSee section M for additional information on isolated ground devices.

*DRUB5462 configuration not pictured.

**UL Listed, CSA Certified.

NEMA® is a registered trademark of the National Electrical Manufacturers Association.

Dimensions in Inches (mm)

Features and Benefits

IP66
SUITABILITY

NFPA 70E Compliant

PANEL-SAFE® Power and Data

An arc flash is a short circuit that travels through air from one live circuit to another. Problems including gaps in insulation, dust or corrosion on the surface of a conductor, or even use of substandard components can cause a serious safety hazards and equipment failures. Arc flash incidents can be extremely costly to a business and can result in serious or even fatal burns, as well as damage to eyesight. Hubbell PANEL-SAFE® provides through door access to live electrical components without having to open the enclosure.

- Available in Type 4, 12 and 4X versions with protective clear cover
- Provides overcurrent protection for both power and data access ports
- Ensures safety with finger-safe contacts and Hubbell GFCI functionality



Available in
**NEMA TYPE 4, 12 and
NEMA TYPE 4X Versions!**



Housing Design

- Rugged, nickel-plated hardware, excellent corrosion and abuse resistance
- Protective clear cover
- Operating temperature -20°C to 110°C



Internal Design

- Hubbell GFCI with functionality indicator
- Cat. 5e Ethernet access*
- Overcurrent protection



Housing Design

- Locking Hasp accepts 5/32" padlock
- Supplemental "Tool" entry screw closure



Internal Design

- Additional convenience outlet on GFCI versions
- Finger-safe contacts
- Stainless steel snap latch

Note: *Additional computer interfaces and PLC connections available upon request.

Specifications

Electrical	GFCI - conforms to UL 943 2006 requirement In-Cabinet Receptacle - GFCI protected Data Jack - Cat. 5e Circuit Breaker - 3A
Mechanical	Cover - Clear Polycarbonate (UV Rated) Housing - Cast Aluminum Finish - Powder Coat Latch - Stainless steel
Environmental	Enclosure - NEMA Type 4, 12 and NEMA Type 4X
Certification	UL Recognized CSA Certified

Application



PANEL-SAFE® Power Only

Description	NEMA TYPE 4	NEMA TYPE 4X
20A 125V GFCI with In-Cabinet Receptacle.	PR20	—



PR20

PANEL-SAFE® Data Only

Description	NEMA TYPE 4	NEMA TYPE 4X
Cat. 5e Ethernet Access only.	P5E	P4X5E
DB9 Interface Connector only.	PDB9	—
PANEL-SAFE Data Port with DB9 Connector.	PDB9MF	—
DH + Combo (DB9/8M Din) and Cat. 5e Ethernet.	PDH5E	—
PANEL-SAFE Data Port, (2) USB, 3 ft. Cable.	—	P4XUSBA2C3



P5E

PANEL-SAFE® Power and Data

Description	NEMA TYPE 4	NEMA TYPE 4X
20A 125V GFCI with In-Cabinet Receptacle and Cat. 5e Ethernet Access.	PR205E	PR4X205E
20A 125V GFCI with In-Cabinet Receptacle, Cat. 5e Ethernet Access and 3A Circuit Breaker.	PR205EB	PR4X205EB
PANEL-SAFE with 20A GFCI and Cat.5e, DB9 and 3A Circuit Breaker.	PR205EDB9B	—
PANEL-SAFE with 20A GFCI and Cat.5e, (1) 3A USB.	PR205EUSBA	—
PANEL-SAFE with 20A GFCI and Cat.5e, (2) 3A USB.	PR205EUSBA2	—
PANEL-SAFE Data Access Port.	PR205EUSBA2VGA	—
20A 125V GFCI Power and Cat. 5e, DB9 and 3A Circuit Breaker.	PR205EDB9MFB	—
20A 125V GFCI Power and Cat. 5e Ethernet, DH + Combo (DB9/8M Din).	P20DH5E	—
PANEL-SAFE with 20A GFCI and Cat.5/DB9.	P205EDB9	—
15A 125V Power and Cat. 5e Ethernet Access.	P155E	P4X155E
15A 125V Power, Cat. 5e Ethernet Access and 3A Circuit Breaker.	P155EB	P4X155EB
15A 125V Power and (2) Cat. 5e Ethernet Access.	P155E2	—
15A 125V Power, Cat.5e and (1) 3A USB.	P155EUSB	—
15A 120V AC Power, NEMA 12/4, DB9 M/F, 10 ft. Cable.	P15DB9MFC10	—
15A 125V Power and DH485 Interface (RJ-45F to RJ-45M, 10 ft. Cable).	P15DH485C10	—
15A 125V Power and Micrologix 8M Din/F to 8M Din/M, 10 ft. Cable.	P15ML8F8MC10	—



PR205E



PR205EB



P155E



P155EB

Additional computer interfaces, PLC connections and configurations available upon request. Consult factory for catalog number and availability.

Features and Benefits

HI-Impact Industrial Ethernet Connectors

Hubbell's Industrial Ethernet System provides leading edge Category 5e and 6 network transmission performance suitable for industrial and other harsh environments. This system incorporates the use of our standard data connectivity jacks which feature our keystone latching mechanism, in a rugged sealed housing providing IP67 rated protection.

Extend your LAN to include automation equipment and manufacturing or process control equipment. Utilize the Hubbell system to provide added protection in harsh environments such as convention centers, food processing plants, outdoor billboards and display screens, medical and other environments which require added protection from moisture, corrosion, dust-debris, vibration and chemicals.



Housing Design

- Housing made from high impact polymer
- O-rings for moisture protection
- Sealed connection is IP67 rated



Internal Design

- Category 6 and 5e component connectors
- Standard Hubbell Keystone latching system



Industrial Ethernet Connectors

Description	Cat. 6	Cat. 6 Inline Coupler
Connector	HI6	HI6C



Industrial Ethernet Patch Cords and Plugs

Description	Catalog Number
HI-Impact RJ-45 to standard RJ-45.	HI6xxAE
HI-Impact RJ-45 on both ends.	HI6xxEE
Standard RJ-45 on both ends.	HI6xxAA

Note: Substitute "xx" with 03, 05, 07, 10, 15, 20, 25, 30, 35, 40, 45, 50 to indicate length in feet.



AE

Coupler Housing and Connector Cap

Description	Catalog Number
HI-Impact coupler housing is a perfect solution for temporary and flexible work areas where single port drops are needed. Add any HI-Impact connector to support your application.	HICH
Connector Cap	HIC

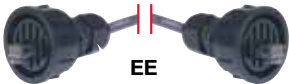

EE

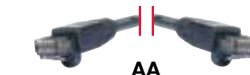

AA

HI-Impact Wallplates

Description	1-Gang 1-Port Opening	1-Gang 2-Port Openings	2-Gang 2-Port Openings	2-Gang 4-Port Openings
Stainless steel wallplate.	HISF11	HISF12	HISF22	HISF24

Valox® is a trademark of SABIC Innovative Plastics, acquired from General Electric Company.



HICH

Environmental Specifications

Ingress Protection:	NEMA TYPE 4X (connectors). IP67 and IP66 (dust/water). IP55 (plates).
Corrosion:	Resistant to most common chemicals, oils and cleaning agents.
HI-Impact Housing:	UV resistant.
Temperature Range:	TIA/EIA-568-B.2 -25°C to 70°C.

Mechanical

Vibration	
Frequency Range:	10-500Hz.
Acceleration:	5g (operational).
Mating Cycles:	750 minimum.
UL 1863 compliant.	



HIC

HISF11

Material

HI-Impact Housing:	Valox®, UL 94V-0.
Nose Contacts:	Beryllium copper with a minimum of 50 micro-inch gold plating over nickel under plating.

Electrical

ANSI/TIA/EIA-568-B.2-1 (Cat. 6 and 5e).
Supports TIA-1005 Industrial Telecommunications Infrastructure.