

HUBBELL

Entertainment Industry Products



**Wiring Devices That
Deliver High Performance
So the Show Can Go On!**



Wiring Device-Kellems

Hubbell Wiring Device-Kellems Entertainment Industry Products



At Hubbell, We're Never Satisfied, But Our Customers Always Are.

Hubbell Wiring Device-Kellems products have long set the standard for innovation, performance, durability, safety and convenience. But, there's an underlying secret to our continuing success. It's our philosophy of never leaving well enough alone. We believe we can always make our products better – and the record shows we have.

The dynamic environments the Entertainment Industry faces are unpredictable and therefore place high demands on all your equipment. Hubbell devices have the proven reliability to deliver secure connections that let you turn your attention to the critical details for a flawless show, no matter what the venue. We offer tailored products to the entertainment industry such as all black plugs and connectors that blend into the background, single pole devices with a double cam that stand up to repeated mating, angle plugs from 15 to 60 amps that fit into the tight spaces where cable management becomes a more critical issue, and the overall quality that can take on the harsh everyday abuse unique to producing a show. Safety is always a top priority, all Hubbell products are designed and manufactured with this in mind and exceed UL standards so the show can go on.

Since our company was founded more than 115 years ago, Hubbell Wiring Devices has become the standard in the industry. We pride ourselves with the quality and the detail built into every product we make.

We've put this brochure together so you can easily find in one place, all of the Hubbell devices that our experience tells us the Entertainment Industry needs to keep quality high and downtime low.

Hubbell Advantage



Hubbell First - Indicates a product that is the first in the industry to meet a new standard or solve key application needs.



Labor Savings - Indicates a unique feature that greatly simplifies assembly or reduces installation time.



Tips and Application Solutions - Describes ways to use Hubbell products to address demanding applications.

HUBBELL
 ADVANTAGE

Entertainment Industry Products Table of Contents



			Page
	Straight Blade	Plugs, Connectors, Receptacles and Inlets	2
	Twist-Lock®	Plugs, Connectors, Receptacles, Inlets, Outlets and Midget Twist-Lock	3
	Single Pole	Plugs, Receptacles, Caps, Tri-Tap, "T"s and Snap Back Covers	4, 5
	Pin & Sleeve	Plugs, Receptacles, Connectors, Inlets, Back Boxes, Low Profile and Short Pin & Sleeve	6, 7
	Modular Cable Protection Systems	TrukTrak®, TredTrak® and AccessTrak® Systems	8
	Lock-Out Tag-Out	PLUGOUT® and SWITCHOUT® Devices	9
	Ground Fault Circuit Interrupter Devices	Automatic and Manual Set Line Cords, Portable Multiple Outlets and GFCI Modules	10
	30 Amp Ground Fault Devices	Hard Wired and Portable GFCI	11
	Electric Cord and Cable Reels	Weatherproof Cable and Static Discharge Reels	12
	Portable Outlet Boxes and Plates	Boxes with Cord Strain Relief, Blank, Single and Duplex Plates	13
	Spider® II	50 Amp and 60 Amp Temporary Power Distribution Systems	13
	HI-Impact™ Industrial Ethernet	Connectors, Patch Cords, Plugs, Wall Plates and Accessories	14
	Voice, Data and Video	Jacks, Multimedia Connectors, Plates, Frames and Modules	15
	Convention Center Floor Box	Floor Box with Provisions for Power, Datacom, Water and Compressed Air	16, 17



Entertainment Industry Products

Straight Blade



Hubbell Insulgrip plugs and connectors continue our long-standing tradition of leadership as well as innovative design. The tough nylon body provides impact and chemical resistance commonly needed in the Entertainment Industry. The durable and powerful offsetting cord grip clamps on individual conductors and outer cord jackets prevent strain on the terminals. It's these and many other features that set Hubbell performance above all others.

Insulgrip Heavy Duty Plugs

2 Pole, 3 Wire Grounding
15 and 20 Amp, 125 Volts



NEMA 5-15P
15A 125V
0.5 HP



NEMA 5-20P
20A 125V
1 HP

Description	Cord Dia.	Catalog Numbers	
Black and white nylon.	.230"-.720" (5.8-18.3)	HBL5266C™	HBL5366C™
All black nylon.	.230"-.720" (5.8-18.3)	HBL5266CM2	HBL5366CM2
Corrosion resistant yellow nylon.	.230"-.720" (5.8-18.3)	HBL52CM66C	HBL53CM66C
8-position angle plug, black & white nylon.	.325"-.655" (8.3-16.6)	HBL5266CA	HBL5366CA
8-position angle plug, transparent enclosure.	.325"-.655" (8.3-16.6)	HBL5266CAT	-
Anchor lock, black and white nylon.*	.230"-.720" (5.8-18.3)	HBL5280C	-
Anchor lock, corrosion resistant yellow nylon.*	.230"-.720" (5.8-18.3)	HBL52CM80C	-
Finger grip, black neoprene, combination screws. CSA only.	.312"-.468" (7.9-11.9)	HBL5921	-
Fusible, black vinyl housing, slotted screws. CSA only.	.296"-.625" (7.5-15.9)	HBL5299	-

* Component

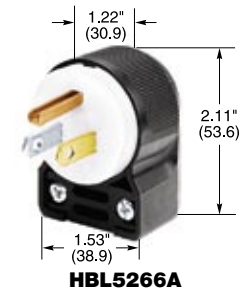

Insulgrip Heavy Duty Connector Bodies

2 Pole, 3 Wire Grounding
15 and 20 Amp, 125 Volts



NEMA 5-15R
15A 125V



NEMA 5-20R
20A 125V

Description	Cord Dia.	Catalog Numbers	
Black and white nylon.	.230"-.720" (5.8-18.3)	HBL5269C™	HBL5369C™
All black nylon.	.230"-.720" (5.8-18.3)	HBL5269CM2	HBL5369CM2
Corrosion resistant yellow nylon.	.230"-.720" (5.8-18.3)	HBL52CM69C	HBL53CM69C

Heavy Duty, Specification Grade Duplex Receptacles



NEMA 5-15R
15A 125V
0.5 HP



NEMA 5-20R
20A 125V
1HP

Description	Color	Catalog Numbers	
Flush, nylon face, back and side wired, multiple drive screws.	Brown	HBL5262	HBL5362
	Ivory	HBL5262I	HBL5362I
	Gray	HBL5262GY	HBL5362GY
	Red	HBL5262R	HBL5362R
	White	HBL5262W	HBL5362W
	Black	HBL5262BK	HBL5362BK
Corrosion resistant.	Yellow Ivory	HBL52CM62 HBL52CM62I	HBL53CM62 -
On 4" (101.6) round cover.	Brown	HBL5282	-
Isolated ground.	Orange	IG5262	IG5362
	Ivory	IG5262I	IG5362I
	Gray	IG5262GY	IG5362GY
	White	-	IG5362W
	Red	IG5262R	IG5362R

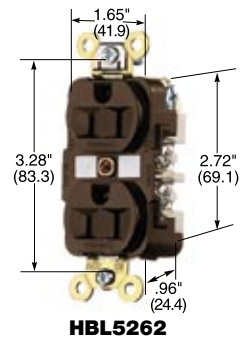

Flanged Inlets and Receptacles



NEMA 5-15R
15A 125V



NEMA 5-20R
20A 125V



NEMA 5-15R
15A 125V



NEMA 5-20R
20A 125V

Description	Flanged Inlet Catalog Numbers		Flanged Receptacle Catalog Numbers	
Nylon casing, back wired.	HBL5278C	HBL5378C	HBL5279C	HBL5379C
Weatherproof, gray nylon, w/lift cover & boot, multiple drive screws.	HBL61CM64	-	HBL61CM65	-

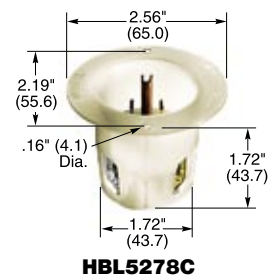

Entertainment Industry Products

Twist-Lock®



Since 1929, when Harvey Hubbell obtained the first patents on Twist-Lock® devices and introduced them to the market, they have been the standard for the Entertainment Industry. Today, Hubbell Insulgrip Twist-Lock Devices continue to set the standard against which all quality industrial wiring devices are measured. The Insulgrip® line includes plugs, connectors, flanged inlets and outlets and flush mounting receptacles. With a single piece dust shield, tough nylon housing, visible identification and a roomy wiring chamber, these devices offer the most powerful cord grip in the industry.



NEW!
All Black Devices!

The unparalleled acceptance and success of the Twist-Lock line is a tribute to the quality of this long lasting design. When selecting premium plugs and connectors for the Entertainment Industry, the decision is Hubbell.

Twist-Lock Devices Selection Chart

UL SF

NEMA Grounding Twist-Lock

Poles	Wires	Amps	Volts	NEMA Code No.	AC HP Rating†	Plug		Connector Body		Inlet	Outlet	Receptacles		
						Insulgrip	Insulgrip	Nylon	Nylon	Nylon	Single	Single	IG Single	
2	3	15	125	L5-15	0.5	HBL4720C	HBL4720CBK	HBL4729C	HBL4729CBK	HBL4716C	HBL4715C	HBL4710	IG4710	
			250	L6-15	1.5	HBL4570C		HBL4579C		HBL4586C	HBL4585C	HBL4560	IG4560	
			277AC	L7-15	2	HBL4770C		HBL4779C		HBL4786C	HBL4785C	HBL4760		
		20	125	L5-20	1	HBL2311	HBL2311BK	HBL2313	HBL2313BK	HBL2315	HBL2316	HBL2310	IG2310	
			250	L6-20	2	HBL2321	HBL2321BK	HBL2323	HBL2323BK	HBL2325	HBL2326	HBL2320	IG2320	
			277AC	L7-20	2	HBL2331		HBL2333		HBL2335	HBL2336	HBL2330		
	30	480AC	L8-20	3	HBL2341		HBL2343		HBL2345	HBL2346	HBL2340	IG2340		
		600AC	L9-20		HBL2351		HBL2353		HBL2355	HBL2356	HBL2350			
		125	L5-30	2	HBL2611	HBL2611BK	HBL2613	HBL2613BK	HBL2615	HBL2616	HBL2610	IG2610		
	3	4	20	125/250	L14-20	2 (1)	HBL2411	HBL2411BK	HBL2413	HBL2413BK	HBL2415	HBL2416	HBL2410	IG2410
				3Ø250AC	L15-20	3	HBL2421		HBL2423		HBL2425	HBL2426	HBL2420	IG2420
				3Ø480AC	L16-20	5	HBL2431		HBL2433		HBL2435	HBL2436	HBL2430	
30		125/250	L14-30	2	HBL2711	HBL2711BK	HBL2713	HBL2713BK	HBL2715	HBL2716	HBL2710	IG2710		
		3Ø250AC	L15-30	3	HBL2721		HBL2723		HBL2725	HBL2726	HBL2720	IG2720		
		3Ø480AC	L16-30	10	HBL2731		HBL2733		HBL2735	HBL2736	HBL2730			
4	5	20	3ØY120/208AC	L21-20	2	HBL2511	HBL2511BK	HBL2513	HBL2513BK	HBL2515	HBL2516	HBL2510	IG2510	
			3ØY277/480AC	L22-20	5	HBL2521		HBL2523		HBL2525	HBL2526	HBL2520		
			3ØY347/600AC	L23-20		HBL2531		HBL2533		HBL2535	HBL2536	HBL2530		
	30	3ØY120/208AC	L21-30	3	HBL2811	HBL2811BK	HBL2813	HBL2813BK	HBL2815	HBL2816	HBL2810	IG2810		
		3ØY277/480AC	L22-30	10	HBL2821		HBL2823		HBL2825	HBL2826	HBL2820			
		3ØY347/600AC	L23-30		HBL2831		HBL2833		HBL2835	HBL2836	HBL2830			

Flat Cable Cord Clamp Devices

Poles	Wires	Amps	Volts	NEMA Code No.	AC HP Rating†	Plug	Connector	Receptacle
4	5	20	3ØY120/208AC	L21-20	2	HBL2511FC		HBL2513FC
		30	3ØY120/208AC	L21-30	3	HBL2811FC		HBL2813FC



Midget Twist-Lock

Poles	Wires	Amps	Volts	NEMA Code No.	Plug	Plug Insulation Displacement	Connector	Connector Insulation Displacement	Nylon Inlet	Stainless Steel Inlet	Nylon Outlet	Stainless Steel Outlet
2	2	15	125	ML-1	HBL7465V		HBL7464V			HBL7467		HBL7468
2	3	15	125	ML-2	HBL7494	HBL7494V	HBL7593	HBL7593V	HBL7595N	HBL7595	HBL7596N	HBL7596
3	3	15	125/250	ML-3	HBL7485	HBL7485V	HBL7484	HBL7484V	HBL7486N	HBL7486	HBL7487N	HBL7487

†The Horsepower Ratings are the Phase Values. The Values in Parentheses are Phase to Neutral.
Note: Horsepower Ratings are Applicable to Plugs and Receptacles Only and Do Not Apply to Connectors, Flanged Inlets and Outlets.



Entertainment Industry Products

Single Pole



Hubbell's new Single Pole connectors are made from a specially formulated thermoset rubber that resists cracking in cold, hot or oily conditions as well as any other harmful environments that may be found within the Entertainment Industry. The connectors have been designed so they are easy to assemble, requiring no special tools. A high strength, non-conductive retaining screw will securely lock the contacts to the insulated sleeves. These Single Pole connectors are completely interchangeable with other manufacturers single pole products. The product is UL Enclosure Type 3R, 4X and 12K Rated.

Plugs

Amp	Color	Cable Size	Male Plug	Female Plug
300	Black	#4 - 2/0	HBL300MBK	HBL300FBK
300	White	#4 - 2/0	HBL300MW	HBL300FW
300	Red	#4 - 2/0	HBL300MR	HBL300FR
300	Blue	#4 - 2/0	HBL300MBL	HBL300FBL
300	Green	#4 - 2/0	HBL300MGN	HBL300FGN
300	Yellow	#4 - 2/0	HBL300MY	HBL300FY
300	Orange	#4 - 2/0	HBL300MO	HBL300FO
300	Brown	#4 - 2/0	HBL300MBN	HBL300FBN
400	Black	2/0 - 4/0	HBL400MBK	HBL400FBK
400	White	2/0 - 4/0	HBL400MW	HBL400FW
400	Red	2/0 - 4/0	HBL400MR	HBL400FR
400	Blue	2/0 - 4/0	HBL400MBL	HBL400FBL
400	Green	2/0 - 4/0	HBL400MGN	HBL400FGN
400	Yellow	2/0 - 4/0	HBL400MY	HBL400FY
400	Orange	2/0 - 4/0	HBL400MO	HBL400FO
400	Brown	2/0 - 4/0	HBL400MBN	HBL400FBN

Panel Mount Receptacles; Stud Type

Amp	Color	Male Plug	Female Plug
400	Black	HBLMRSBK	HBLFRSBK
400	White	HBLMRSW	HBLFRSW
400	Red	HBLMRSR	HBLFRSR
400	Blue	HBLMRSBL	HBLFRSBL
400	Green	HBLMRSGN	HBLFRSGN
400	Yellow	HBLMRSY	HBLFRSY
400	Orange	HBLMRSO	HBLFRSO
400	Brown	HBLMRSBN	HBLFRSBN

Panel Mount Receptacles; Double Set Screw

Amp	Color	Cable Size	Male Plug	Female Plug
400	Black	#4 - 4/0	HBLMRBK	HBLFRBK
400	White	#4 - 4/0	HBLMRW	HBLFRW
400	Red	#4 - 4/0	HBLMRR	HBLFRR
400	Blue	#4 - 4/0	HBLMRBL	HBLFRBL
400	Green	#4 - 4/0	HBLMRGN	HBLFRGN
400	Yellow	#4 - 4/0	HBLMRY	HBLFRY
400	Orange	#4 - 4/0	HBLMRO	HBLFRO
400	Brown	#4 - 4/0	HBLMRBN	HBLFRBN

Protective Caps

Color	Fits Male Devices	Fits Female Devices
Black	HBLMCAPBK	HBLFCAPBK
White	HBLMCAPW	HBLFCAPW
Red	HBLMCAPR	HBLFCAPR
Blue	HBLMCAPBL	HBLFCAPBL
Green	HBLMCAPGN	HBLFCAPGN
Yellow	HBLMCAPY	HBLFCAPY
Orange	HBLMCAPO	HBLFCAPO
Brown	HBLMCAPBN	HBLFCAPB



NEW!
for 2005!



HBL400MBK



HBL400FBK



HBLMRSR



HBLMRSBL



HBLMRBK



HBLFRO



HBLFCAPBK



HBLMCAPBK

Entertainment Industry Products Single Pole



NEW!
for 2005!

Tapping and Paralleling "T"

Color	Tapping "T" (Female-Female-Male) Catalog Numbers	Paralleling "T" (Female-Male-Male) Catalog Numbers
Black	HBLTBK	HBLPTBK
White	HBLTW	HBLPTW
Red	HBLTR	HBLPTR
Blue	HBLTBL	HBLPTBL
Green	HBLTGN	HBLPTGN
Yellow	HBLTY	HBLPTY
Orange	HBLTO	HBLPTO
Brown	HBLTBN	HBLPTBN



HBLTBN



HBLPTY

Tri-Tap

Color	Male-Female-Female-Female Catalog Numbers	Female-Male-Male-Male Catalog Numbers
Black	HBLM3FBK	HBLF3MBK
White	HBLM3FW	HBLF3MW
Red	HBLM3FR	HBLF3MR
Blue	HBLM3FBL	HBLF3MBL
Green	HBLM3FGN	HBLF3MGN
Yellow	HBLM3FY	HBLF3MY
Orange	HBLM3FO	HBLF3MO
Brown	HBLM3FBN	HBLF3MBN



HBLM3FBK



HBLF3MR

Double Male (Male-Male)

Color	Catalog Numbers
Black	HBLDMBK
White	HBLDMW
Red	HBLDMR
Blue	HBLDMBL
Green	HBLDMGN
Yellow	HBLDMY
Orange	HBLDMO
Brown	HBLDMBN



HBLDMBL

Double Female (Female-Female)

Color	Catalog Numbers
Black	HBLDFBK
White	HBLDFW
Red	HBLDFR
Blue	HBLDFBL
Green	HBLDFGN
Yellow	HBLDFY
Orange	HBLDFO
Brown	HBLDFBN



HBLDFBK

Snap Back Cover

Color	Catalog Numbers
Black	HBLSCBK
White	HBLSCW
Red	HBLSCR
Blue	HBLSCBL
Green	HBLSCGN
Yellow	HBLSCY
Orange	HBLSCO
Brown	HBLSCBN



HBLSCW



Wiring Device-Kellems
Wiring Device-Kellems

Entertainment Industry Products

Pin & Sleeve



Go ahead and dish it out. Immerse it in water, grind it with dirt or put it to the test on the longest cable runs. Run over it, bake it or freeze it. Hubbell Pin & Sleeve is designed and built for the most demanding Entertainment Industry applications. All of these Pin & Sleeve devices are designed to be safe, easy to use and reliable in any environment. These UL Listed and CSA Certified devices will interface with any Pin & Sleeve meeting International Standard IEC 60309-1 and IEC 60309-2.



IP67					Watertight Devices				Back Boxes		Replacement Interior Kits		
Amps	Poles and Wires	Configuration Recep./ Conn.	Plug/ Inlet	Voltage	Receptacle	Plug	Connector	Inlet	Nonmetallic	Metallic	Conn. Recep.	Plugs Inlets	
16	2P 3W			100-130	HBL316R4W	HBL316P4W	HBL316C4W	HBL316B4W†	BB2030N	BB201W BB301W	IN320BF	IN320BM	
	2P 3W			220-240	HBL316R6W	HBL316P6W	HBL316C6W	HBL316B6W	BB2030N	BB201W BB301W	IN320BF	IN320BM	
	3P 4W			380-415	HBL416R6W	HBL416P6W	HBL416C6W	HBL416B6W†	BB2030N	BB201W BB301W	IN420DF	IN420DM	
	4P 5W			220/380 240/415	HBL516R6W	HBL516P6W	HBL516C6W	HBL516B6W	BB2030N	BB201W BB301W	IN520EF†	IN520EM	
20	2P 3W			125	HBL320R4W	HBL320P4W	HBL320C4W	HBL320B4W	BB2030N	BB201W BB301W	IN320AF	IN320AM	
	2P 3W			250	HBL320R6W	HBL320P6W	HBL320C6W	HBL320B6W	BB2030N	BB201W BB301W	IN320BF	IN320BM	
	2P 3W			480	HBL320R7W	HBL320P7W	HBL320C7W	HBL320B7W	BB2030N	BB201W BB301W	IN320BF	IN320BM	
	3P 4W			125/250	HBL420R12W	HBL420P12W	HBL420C12W	HBL420B12W	BB2030N	BB201W BB301W	IN420CF	IN420CM	
	3P 4W			3Ø250	HBL420R9W	HBL420P9W	HBL420C9W	HBL420B9W	BB2030N	BB201W BB301W	IN420DF	IN420DM	
	3P 4W			3Ø480	HBL420R7W	HBL420P7W	HBL420C7W	HBL420B7W	BB2030N	BB201W BB301W	IN420DF	IN420DM	
	3P 4W			3Ø600	HBL420R5W	HBL420P5W	HBL420C5W	HBL420B5W	BB2030N	BB201W BB301W	IN420DF	IN420DM	
	4P 5W			3ØY120/208	HBL520R9W	HBL520P9W	HBL520C9W	HBL520B9W	BB2030N	BB201W BB301W	IN520EF†	IN520EM	
	4P 5W			3ØY277/480	HBL520R7W	HBL520P7W	HBL520C7W	HBL520B7W	BB2030N	BB201W BB301W	IN520EF†	IN520EM	
	4P 5W			3ØY347/600	HBL520R5W	HBL520P5W	HBL520C5W	HBL520B5W	BB2030N	BB201W BB301W	IN520EF†	IN520EM	
	30	2P 3W			125	HBL330R4W	HBL330P4W	HBL330C4W	HBL330B4W	BB2030N	BB201W BB301W	IN330AF	IN330AM
		2P 3W			250	HBL330R6W	HBL330P6W	HBL330C6W	HBL330B6W	BB2030N	BB201W BB301W	IN330BF	IN330BM
2P 3W				480	HBL330R7W	HBL330P7W	HBL330C7W	HBL330B7W	BB2030N	BB201W BB301W	IN330BF	IN330BM	
3P 4W				125/250	HBL430R12W	HBL430P12W	HBL430C12W	HBL430B12W	BB2030N	BB201W BB301W	IN430CF	IN430CM	
3P 4W				3Ø250	HBL430R9W	HBL430P9W	HBL430C9W	HBL430B9W	BB2030N	BB201W BB301W	IN430DF	IN430DM	
3P 4W				3Ø480	HBL430R7W	HBL430P7W	HBL430C7W	HBL430B7W	BB2030N	BB201W BB301W	IN430DF	IN430DM	
3P 4W				3Ø600	HBL430R5W	HBL430P5W	HBL430C5W	HBL430B5W	BB2030N	BB201W BB301W	IN430DF	IN430DM	
4P 5W				3ØY120/208	HBL530R9W	HBL530P9W	HBL530C9W	HBL530B9W	BB2030N	BB201W BB301W	IN530EF	IN530EM	
4P 5W				3ØY277/480	HBL530R7W	HBL530P7W	HBL530C7W	HBL530B7W	BB2030N	BB201W BB301W	IN530EF	IN530EM	
4P 5W				3ØY347/600	HBL530R5W	HBL530P5W	HBL530C5W	HBL530B5W	BB2030N	BB201W BB301W	IN530EF	IN530EM	
32		2P 3W			100-130	HBL332R4W†	HBL332P4W†	HBL332C4W†	HBL332B4W†	BB2030N	BB201W BB301W	IN330BF	IN330BM
		2P 3W			220-240	HBL332R6W	HBL332P6W	HBL332C6W	HBL332B6W	BB2030N	BB201W BB301W	IN330BF	IN330BM
	3P 4W			380-415	HBL432R6W	HBL432P6W	HBL432C6W	HBL432B6W	BB2030N	BB201W BB301W	IN430DF	IN430DM	
	3P 4W			380V 50Hz 440V 60Hz	HBL432R3W	HBL432P3W	HBL432C3W	-	BB2030N	BB201W BB301W	IN430DF	IN430DM	
	4P 5W			240/415 220/380	HBL532R6W	HBL532P6W	HBL532C6W	HBL532B6W	BB2030N	BB201W BB301W	IN530EF	IN530EM	

† Consult factory.

Entertainment Industry Products Pin & Sleeve



Wiring Device-Kallemis

Watertight Devices IP67					Watertight Devices				Back Boxes		Replacement Interior Kits	
Amps	Poles and Recept./ Wires	Configuration Plug/ Conn.	Inlet	Voltage	Receptacle	Plug	Connector	Inlet	Nonmetallic	Metallic	Conn. Recept.	Plugs Inlets
					60	2P 3W			125	HBL360R4W	HBL360P4W	HBL360C4W
	2P 3W			250	HBL360R6W	HBL360P6W	HBL360C6W	HBL360B6W	BB60N	BB601W BB602W	IN360BF	N360BM†
	2P 3W			480	HBL360R7W	HBL360P7W	HBL360C7W	HBL360B7W	BB60N	BB601W BB602W	IN360BF	N360BM†
	3P 4W			125/250	HBL460R12W	HBL460P12W	HBL460C12W	HBL460B12W	BB60N	BB601W BB602W	IN460CF	IN460CM
	3P 4W			30/250	HBL460R9W	HBL460P9W	HBL460C9W	HBL460B9W	BB60N	BB601W BB602W	IN460DF	IN460DM
	3P 4W			30/480	HBL460R7W	HBL460P7W	HBL460C7W	HBL460B7W	BB60N	BB601W BB602W	IN460DF	IN460DM
	3P 4W			30/600	HBL460R5W	HBL460P5W	HBL460C5W	HBL460B5W	BB60N	BB601W BB602W	IN460DF	IN460DM
	4P 5W			30Y120/208	HBL560R9W	HBL560P9W	HBL560C9W	HBL560B9W	BB60N	BB601W BB602W	IN560EF	N560EM†
	4P 5W			30Y277/480	HBL560R7W	HBL560P7W	HBL560C7W	HBL560B7W	BB60N	BB601W BB602W	IN560EF	N560EM†
	4P 5W			30Y347/600	HBL560R5W	HBL560P5W	HBL560C5W	HBL560B5W	BB60N	BB601W BB602W	IN560EF	N560EM†
63	2P 3W			220-240	HBL363R6W	HBL363P6W	HBL363C6W	HBL363B6W	BB60N	BB601W BB602W	IN360BFS	IN360BMS†
	3P 4W			380-415	HBL463R6W	HBL463P6W	HBL463C6W	HBL463B6W	BB60N	BB601W BB602W	IN460DFS	IN460DMS
	4P 5W			220/380 240/415	HBL563R6W	HBL563P6W	HBL563C6W	HBL563B6W	BB60N	BB601W BB602W	IN560EFS†	IN560EMS
100	2P 3W			125	HBL3100R4W	HBL3100P4W	HBL3100C4W	HBL3100B4W	BB100N	BB1001W BB1002W	IN3100AF	IN3100AM
	2P 3W			250	HBL3100R6W	HBL3100P6W	HBL3100C6W	HBL3100B6W	BB100N	BB1001W BB1002W	IN3100BF	IN3100BM†
	2P 3W			480	HBL3100R7W	HBL3100P7W	HBL3100C7W	HBL3100B7W	BB100N	BB1001W BB1002W	IN3100BF	IN3100BM†
	3P 4W			125/250	HBL4100R12W	HBL4100P12W	HBL4100C12W	HBL4100B12W	BB100N	BB1001W BB1002W	IN4100CF†	IN4100CM
	3P 4W			30/250	HBL4100R9W	HBL4100P9W	HBL4100C9W	HBL4100B9W	BB100N	BB1001W BB1002W	IN4100DF	IN4100DM
	3P 4W			30/480	HBL4100R7W	HBL4100P7W	HBL4100C7W	HBL4100B7W	BB100N	BB1001W BB1002W	IN4100DF	IN4100DM
	3P 4W			30/600	HBL4100R5W	HBL4100P5W	HBL4100C5W	HBL4100B5W	BB100N	BB1001W BB1002W	IN4100DF	IN4100DM
	4P 5W			30Y120/208	HBL5100R9W	HBL5100P9W	HBL5100C9W	HBL5100B9W	BB100N	BB1001W BB1002W	IN5100EF	IN5100EM
	4P 5W			30Y277/480	HBL5100R7W	HBL5100P7W	HBL5100C7W	HBL5100B7W	BB100N	BB1001W BB1002W	IN5100EF	IN5100EM
	4P 5W			30Y347/600	HBL5100R5W	HBL5100P5W	HBL5100C5W	HBL5100B5W	BB100N	BB1001W BB1002W	IN5100EF	IN5100EM
125	2P 3W			220-240	HBL3125R6W	HBL3125P6W	HBL3125C6W	HBL3125B6W	BB100N	BB1001W BB1002W	IN3100BFS	IN3100BMS
	3P 4W			380-145	HBL4125R6W	HBL4125P6W	HBL4125C6W	HBL4125B6W	BB100N	BB1001W BB1002W	IN4100DFS	IN4100DMS
	4P 5W			220/380 240/415	HBL5125R6W	HBL5125P6W	HBL5125C6W	HBL5125B6W	BB100N	BB1001W BB1002W	IN5100EFS	IN5100EMS

† Consult factory.

Low Profile Devices							
Amps	Poles & Wires	Configuration Recept./ Conn.	Plug/ Inlet	Voltage	Plug	Receptacle	Cord Diameter Min. Max.
20	3P 4W			30/250	L420P9	L420R9	.350"-.710" (8.3-15.9)
30	3P 4W			125/250	L430P12	L430R12	.390"-.775" (9.9-19.7)
	3P 4W			30/250	L430P9	L430R9	.390"-.775" (9.9-19.7)
60	3P 4W			30/250	A460P9	A460R9	.75"-1.25" (19.0-31.8)
60	4P 5W			30Y 120/208	A560P9	—	

Short Pin & Sleeve Plug					
Amps	Poles & Wires	Configuration Recept./ Conn.	Plug/ Inlet	Voltage	Plug
100	4P 5W			30Y 120/208	HBL5100P9WSH

Entertainment Industry Products Modular Cable Protection Systems



The Entertainment Industry is an ideal application for this Modular Cable Protection System. These products are designed to safeguard electrical cables and cords from vehicle and pedestrian traffic. This product line comes in three versions:

- **TredTrak® System** - comes as a 5-channel track that will protect cable diameters up to 1.28".
- **TrukTrak® System** - comes with 5 channels and will protect cables up to 3.25" in diameter.
- **AccessTrak® System** - comes with 5 channels and will protect cables up to 1.31" in diameter. Enables users to be ADAAG (American Disabilities Act Accessibility Guidelines) compliant.



TrukTrak® System

Description	Catalog Numbers	Length A	Width B	Height C	Channel		
					Width D	Height E	
5-Channel blue & yellow.	HBLTT5B	36" (914.4)	20" (508)	2.31" (58.7)	1.25" (31.8)	1.25" (31.8)	
5-Channel end caps (pair only), yellow.	HBLTT5ECB	(Female)	7.5" (190.5)	20" (508)	2.31" (58.7)	1.25" (31.8)	1.25" (31.8)
		(Male)	5.25" (133.3)	20" (508)	2.31" (58.7)	1.25" (31.8)	1.25" (31.8)
5-Channel 45° right turn blue & yellow.	HBLTT545RB	25" (635)	20" (508)	2.31" (58.7)	1.25" (31.8)	1.25" (31.8)	
5-Channel 45° left turn blue & yellow.	HBLTT545LB	25" (635)	20" (508)	2.31" (58.7)	1.25" (31.8)	1.25" (31.8)	
3-Channel, blue & yellow.	HBLTT3B	36" (914.4)	20" (508)	3.05" (77.5)	2.25" (57.2)	2.25" (57.2)	
3-Channel end caps (pair only), yellow.	HBLTT3ECB	(Female)	8.25" (209.6)	20" (508)	3.05" (77.5)	2.25" (57.2)	2.25" (57.2)
		(Male)	6.38" (161.9)	20" (508)	3.05" (77.5)	2.25" (57.2)	2.25" (57.2)
2-Channel, blue & yellow.	HBLTT2B	36" (914.1)	22" (558.8)	4.13" (104.9)	3.25" (82.6)	3.25" (82.6)	

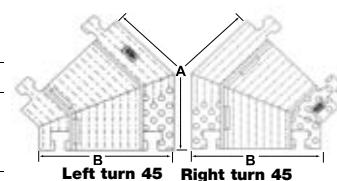

Female End



Male End



TredTrak® System

Description	Catalog Numbers	Length A	Width B	Height C	Channel		
					Width D	Height E	
5-Channel blue & yellow.	HBLTRED5B	36" (914.1)	17.5" (445)	1.95" (50)	1.30" (33)	1.30" (33)	
5-Channel end caps (pair only), yellow.	HBLTRED5ECB	(Female)	5.5" (138)	17.5" (445)	1.95" (50)	1.30" (33)	1.30" (33)
		(Male)	5.5" (138)	17.5" (445)	1.95" (50)	1.30" (33)	1.30" (33)
5-Channel female end caps (2 females), yellow.	HBLTRED5ECFB	5.5" (138)	17.5" (445)	1.95" (50)	1.30" (33)	1.30" (33)	
5-Channel "X" fitting, blue & yellow.	HBLTRED5XB	17.5" (445)	17.5" (445)	1.95" (50)	1.30" (33)	1.30" (33)	
5-Channel "Y" fitting, blue & yellow.	HBLTRED5YB	17.5" (445)	17.5" (445)	1.95" (50)	1.30" (33)	1.30" (33)	

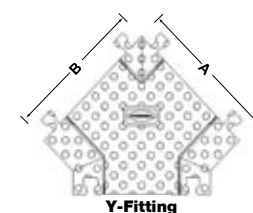
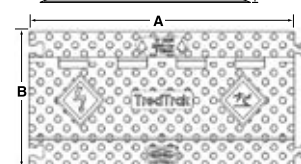

Y-Fitting

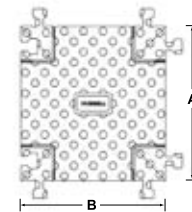

X-Fitting

AccessTrak® System

Description	Catalog Numbers	Length A	Width B	Height C	Channel	
					Width D	Height E
AccessTrak Kit*	HBLAT5KIT	41.06" (1043)	42.90" (1090)	4.00" (102)	1.34" (34)	1.31" (33)
Trough	HBLAT5	36.00" (914)	13.34" (339)	1.94" (49)	1.34" (34)	1.31" (33)
Trough End Rails (set)	HBLAT5ER	16.03" (407)	—	4.00" (102)	—	—
Ramps (set)	HBLAT5RAMP	36.00" (965)	—	1.94" (49)	—	—
Ramp End Rails (set)	HBLAT5RAMPER	—	14.75" (375)	4.00" (102)	—	—

*Consists of (1) HBLAT5, (1 set) HBLAT5ER, (1 set) HBLAT5RAMP and (2 sets) HBLAT5RAMPER

Trough

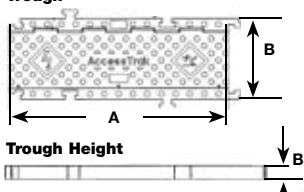

Trough Height

Ramp Side View



Ramp Top View

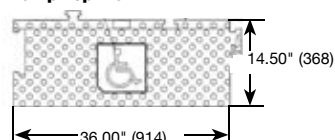

Trough Rails

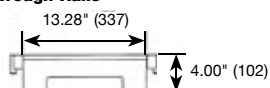

Ramp End Rails

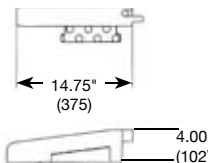

Assembled Kit

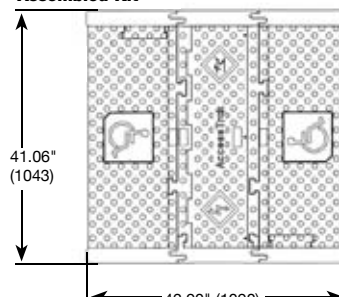

Entertainment Industry Products Lock-Out Tag-Out



All Hubbell Wiring Device-Kellems Lock-Out products comply with OSHA Lock-Out/Tag-Out Regulation 29CFR 1910.1478. The Plug-Out product line accommodates the broadest range of plugs in the market place today from 15A convenience plugs all the way up to and including 60A Pin & Sleeve devices. Use these devices below to work safe during set-ups or breakdowns by insuring circuits are not energized.



Lockout Devices For Electrical Safety

PLUGOUT®, Keyed PLUGOUT®, and SWITCHOUT™ safety devices provide an approved method of complying with OSHA Lockout/Tagout regulation 29CFR 1910.147.

PLUGOUT Devices

Description	Typical Devices Accommodated	Catalog Numbers
Small yellow lockout device.	15 and 20A molded on plugs.	HLDMP
Medium yellow lockout device.	20 and 30A Twist-Lock® plugs.	HLD
Large yellow lockout device.	20, 30 and 60A metallic and non-metallic Pin & Sleeve, Hubbellock® & 50A Twist-Lock plugs.	HLD2

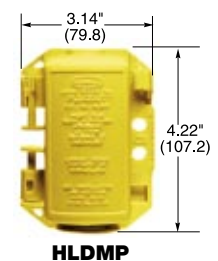

Description	Typical Devices Accommodated	Catalog Numbers
Yellow keyed PLUGOUT, keyed differently.	15 and 20A, 125V straight blade plugs with holes in blades.	HKLD
Yellow keyed PLUGOUT, keyed alike.	15 and 20A, 125V straight blade plugs with holes in blades.	HKLDPK2*

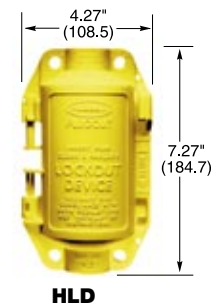

*Two devices per package.

SWITCHOUT Lockout Devices

Description	Typical Devices Accommodated	Catalog Numbers
Yellow SWITCHOUT device.	Toggle switch.	HSLDPK2*



*Two devices per package.

Lockout Device Kit

Description	Includes	Catalog Numbers
Yellow lockout kit.	HLDMP, HSLDPK2, HLD and HLD2.	HLDKIT



Entertainment Industry Products

GFCI



All Hubbell GFCI products are built for quality, designed for easy installation and packaged for convenience. The portable GFCI line cords provide ground fault protection both indoors and out. They are offered with an Automatic or Manual Set feature to meet all applications in the Entertainment Industry.



Circuit Guard® Automatic Set Portable GFCI Line Cords

Automatically energizes or sets the GFCI for use upon plug in and after the loss of primary power (power failure or unplugging the device). After a ground fault condition, unit must be reset by pushing the reset button. This feature eliminates the need for unit to be reset each time it is plugged in or powered up. Ideal for equipment intended for continuous use where a temporary power failure is likely and undesirable. Examples are pumps, pressure washers, portable signs or lighting and engine heaters.

Description	15A 120V AC	Catalog Numbers
18" (45.7 cm) GFCI line cord.		GFP4C15A
6' (182.9 cm) GFCI line cord.		GFP6C15A
25' (762 cm) GFCI line cord.		GFP25C15A
15' (457.2 cm) GFCI power supply cord with stripped leads.		GFPOEMA*



GFP4C15A



GFP6C15A



GFPOEMA

Circuit Guard® Manual Set Portable GFCI Line Cords

Requires the GFCI to be manually set for use by pressing the reset button upon plug in and after loss of primary power (power failure or unplugging the device). Must be manually reset after a ground fault condition. Ideal for applications where operator injury might occur if equipment were to restart after a power failure. Typical equipment includes power drills, saws, lathes and grinders.

Description	15A 120V AC		20A 120V AC	
	Catalog Numbers		Catalog Numbers	
18" (45.7 cm) GFCI line cord.	GFP4C15M	-		
3' (91.4 cm) GFCI line cord.	-		GFP3C20M	
6' (182.9 cm) GFCI line cord.	GFP6C15M	-		
25' (762 cm) GFCI line cord.	GFP25C15M	-		
15' (457.2 cm) GFCI power supply cord with stripped leads.	GFPOEMM*	-		
50' (1524 cm) GFCI power supply with Elastogrip® watertight straight blade.	GFP50C15WM	-		
100' (3048 cm) GFCI power supply with Elastogrip watertight straight blade.	GFP100C15WM	-		

*Total length is 15' 4.5" (468.6 cm) including leads: green 4.5" (114.3), black and white 3.5" (88.9). Each prestripped .375" (9.5).



GFP3C20MTL

Circuit Guard® Manual Set Twist-Lock® Portable GFCI Line Cords

Description	15A 120V AC		20A 120V AC	
	Catalog Numbers		Catalog Numbers	
3' (91.4 cm) GFCI line cord.	GFP3C15MTL		GFP3C20MTL	

Multiple Outlet Portable GFCI

Description	Rating	Receptacles	Plug	Catalog Numbers
4 outlet, yellow.	15A, 120V AC	2-Duplex 5-15R	NEMA 5-15P	GFP15M
4 outlet, yellow.	20A, 120V AC	2-Duplex 5-20R	NEMA 5-20P	GFP20M



GFP15M

GFCI Module

Description	Rating	Catalog Number
GFCI module, manual set, yellow.	20A, 120V AC, 60 Hz	GFM20



GFM20

Entertainment Industry Products

GFCI 30A Ground Fault Products



The GFCI offering consists of 30 hard-wired units that may be either surface or panel mounted. All models are available in 120, 240, 120/240V AC, 3Ø250V AC and 3Ø120/208V AC configurations and come in either automatic or manual reset. Hard-wired units are available with or without an audible alarm and may also be ordered with either a line voltage or low voltage output signal. All portables are also 30 amp max rated and come with pigtails on both the line and the load sides so that the end-user may install any plug and connector they may choose.



HUBBELL Exclusive!

Circuit Guard Hard Wired 30A GFCI

Description	Voltage	Alarm	Manual Set	Automatic Set
Hard wired, manual set and automatic set GFCIs.	120V AC	None	GFHW13005	GFHW13105
	120V AC	Audible	GFHW13015	GFHW13115
	240V AC	None	GFHW23005	GFHW23105
	240V AC	Audible	GFHW23015	GFHW23115
	120/240V AC	Audible	GFHW33015	GFHW33115
	3Ø250V AC	Audible	GFHW530	GFHW531
	3Ø120/208V AC	Audible	GFHW430	GFHW431

Note: All units above are stock items.

Build Your Own Catalog Number

Catalog Number Configurator:
Example: Catalog Number: GFHW23015

GF	HW	2	3	0	1	5
Ground Fault	Hard-Wired	Voltage	Amperage	Reset Type	Output Signal	Mounting Style
		1-120 V AC 2- 240 V AC 3-120/240V AC 4-3Ø120/208V AC 5-3Ø250V AC	3 - 30 Amp	0 - Manual 1 - Automatic	0 - none 1 - Audible Alarm 2 - Line Voltage 3 - 24 Volt DC 4 - 12 Volt DC	5 - Panel Mount/ Surface Mount

Note: 2 to 3 week lead time for all "build your own" catalog numbers.

Circuit Guard Portable 30A GFCI

Description	Cord Length	Voltage	Manual Set	Automatic Set
Portable, manual set and automatic set GFCIs.	2 Foot	120V AC	GFP1301	GFP1311
	25 Feet	120V AC	GFP1302	GFP1312
	2 Foot	240V AC	GFP2301	GFP2311
	25 Feet	240V AC	GFP2302	GFP2312
	6 Feet	120/240V AC	GFP3305	GFP3315
	6 Feet	3Ø250V AC	GFP5305	GFP5315
	6 Feet	3Ø120/208V AC	GFP4305	GFP4315

Note: All units above are stock items.

Catalog Number Configurator:
Example: Catalog Number: GFHW23015

GF	P	2	3	1	1
Ground Fault	Port-able	Voltage	Amperage	Reset Type	Cord Length
		1-120 V AC 2- 240 V AC 3-120/240V AC 4-3Ø120/208V AC 5-3Ø250V AC	3 - 30 Amp	0 - Manual 1 - Automatic	1 - 2 Feet 2 - 25 Feet 3 - 50 Feet 4 - 100 Feet 5 - 6 Feet

Note: 2 to 3 week lead time for all "build your own" catalog numbers.



Automatic Reset GFCI



Manual Reset GFCI



GFP1311

Dimensional Drawing

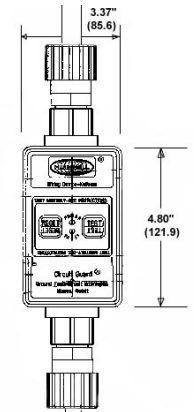

Entertainment Industry Products

Electric Cord and Cable Reels



Our cord and cable reels are an ideal addition for the Entertainment Industry. These reels will minimize unmanaged cords and cables, which can cause trip hazards or electric shock due to damaged wire insulation. They offer quick, convenient cord deployment and the reels provide a safe and effective wire management system for any location or facility.



Weatherproof Cable Reels are made for the most abusive and demanding environments. These reels feature a solid steel construction, a 600V rating with SOW - A type cable and Type 4X enclosure rating. They are designed for use with 15 & 20 amp industrial products such as portable outlet boxes, Insulgrip® and Twist-Lock® devices and pendant push-button stations.

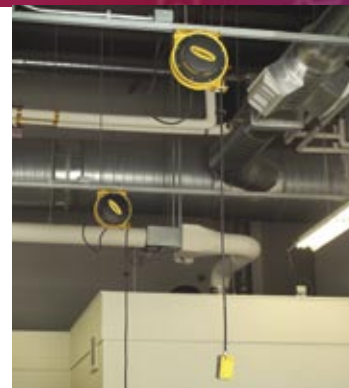

Weatherproof Cable & Static Discharge Reels

Description	Catalog Numbers	Cable Length			Cable Type	Amps	Weight	
		Feet	Meters	Volts			lbs.	kg
14" weatherproof reel.	HBL501431W*	50	15.2	600	14/3 SOW-A	15	55	24
16" weatherproof reel.	HBL501232W*	50	15.2	600	12/3 SOW-A	20	80	36.3
16" weatherproof reel.	HBL501242W*	50	15.2	600	12/4 SOW-A	16	86	38.7
16" weatherproof reel.	HBL501032W*	50	15.2	600	10/3 SOW-A	25	86	38.7
16" weatherproof reel.	HBL501042W*	50	15.2	600	10/4 SOW-A	20	92	41.1
Static discharge reel.	HBL50SD	50	15.2	-	Single 3/32" Steel	-	12	5.4
Static discharge reel.	HBL50YSD	50 [†]	15.2	-	Dual (Y) 3/32" Steel	-	13	5.9
14" pivot base.	HBL14PB	-	-	-	-	-	5	2.27
16" pivot base.	HBL16PB	-	-	-	-	-	13	5.9

Notes: * All weatherproof cable reels are supplied with wire leads. [†]35ft./10.6m + Dual 15ft./4.5m for "Y". Power supply cable not supplied.



Industrial Cord Reels are built to provide safe, convenient power and lighting for demanding entertainment applications and environments. The industrial reels are all steel construction, have a 300V rating with SJ cord and can be ceiling, wall or bench mounted. They are available with fluorescent or incandescent hand lamps as well as a HBL5269C connector body or portable outlet box versions.

Industrial Cord Reels

Description	Catalog Numbers	Cable Length			Cable Type	Amps	Weight		Watts (Max)
		Feet	Meters	Volts			lbs.	kg	
Reel with HBL5269C connector.	HBL45123C	45	13.7	125	12/3 SJEO	15	23	10.4	1875
Reel with portable outlet box.	HBL45123R	45	13.7	125	12/3 SJEO	15	23	10.4	1875
Reel with incandescent hand lamp.	HBL50163IN	50	15.2	125	16/3 SJT	0.8	21	9.5	100
Reel with fluorescent hand lamp.	HBL50162FL	50	15.2	120V AC	16/2 SJT	0.3	21	9.5	13
Pivot Base	HBL340PB	-	-	-	-	-	5	2.26	-

Note: Supplied with 5ft. power supply cord with HBL5266C, 15A straight blade plug.



Commercial Cord Reels are designed for the less demanding requirements of lighter duty environments. The commercial reels feature steel construction and have a 125V rating with SJT type cord. These reels are UL Listed and provide power and lighting for all your needs.

Commercial Cord Reels

Description	Catalog Numbers	Cable Length			Cable Type	Amps	Weight		Watts (Max)
		Feet	Meters	Volts			lbs.	kg	
Reel with fluorescent hand lamp & inline receptacle.	HBLC25163FL	25	7.62	120V AC	16/3 SJT	10	9	4.1	1200
Reel with fluorescent hand lamp & automatic shut off switch.	HBLC25162AFL	25	7.62	120V AC	16/2 SJT	0.3	8.2	3.7	13
Reel with non-metallic incandescent hand lamp & automatic shut off switch.	HBLC25163AIN	25	7.62	125	16/3 SJT	0.6	9	4.1	75
Reel with metallic incandescent hand lamp with receptacle & circuit breaker.	HBLC25143IN	25	7.62	125	14/3 SJT	13	9.5	4.3	1625
Reel with wire leads.	HBLC25163	25	7.62	125	16/3 SJT	10	8.5	3.9	1250
Reel with a Hubbell HBL5969VBLK connector.	HBLC25163C	25	7.62	125	16/3 SJT	10	8.5	3.9	1250

Note: Reels supplied with 2ft. power supply cord and molded on straight blade 15A plug.

Entertainment Industry Products Portable Outlet Box and Spider® II



Portable Outlet Box

Our portable outlet boxes were designed to provide a rugged enclosure for a variety of wiring devices. Their non-metallic construction is impact-resistant, non-conductive and corrosion-resistant. The boxes are field wired and are offered in a high visibility yellow color. Not only are these boxes easy to install anywhere but they are also highly durable.



Portable Outlet Boxes and Plates

Description	Catalog Numbers
Box with cord strain relief, with one blank cover plate.	HBLPOB1
Box with cord strain relief, with two duplex (indoor) cover plates.	HBLPOB1D
Blank, non-metallic FS cover plate with foam gasket, gray.	HBLP14FS
Duplex, non-metallic FS cover plate, gray.	HBLP8FS
Single receptacle (1.39"), non-metallic FS cover plate, gray.	HBLP7FS
Single receptacle (1.56"), non-metallic FS cover plate, gray.	HBLP720FS
Rectangular opening, non-metallic FS cover plate, gray.	HBLP26FS



Spider® II

Hubbell's new Spider II temporary power distribution system sets a new safety and performance standard for your temporary power needs. Outdoor events, unconditional venues and modern convenience place more demands on electrical power than ever before. Hubbell's new and improved Spider box steps up to this challenge by offering advanced electrical and safety features. The Spider II box incorporates the most advanced ground fault module technology available in the industry today ensuring safe and reliable distribution of electrical power. With the constant need for temporary power applications, this is one product the Entertainment Industry should not be without.



Spider® II Boxes

Rating	Type	Qty	Receptacle Ratings	Receptacle Components	Protection Overload	GFCI	Catalog Numbers
50A, 120/240V AC (max.)	Straight Blade	6	20A, 125V	HBL53R61	Yes	Yes	SBSB1
	Twist-Lock®	1	30A, 250V	HBL2620SW	Yes	No	
	Twist-Lock (Inlet)	1	50A, 125/250V	HBL6375S	No	No	
	Twist-Lock (Outlet)	1	50A, 125/250V	CS6369	No	No	
50A, 120/240V AC (max.)	Straight Blade	6	20A, 125V	HBL53R61	Yes	Yes	SBSB2
	Twist-Lock	1	30A, 250V	HBL2620SW	Yes	Yes	
	Twist-Lock (Inlet)	1	50A, 125/250V	HBL6375S	No	No	
	Twist-Lock (Outlet)	1	50A, 125/250V	CS6369	No	No	
50A, 120/240V AC (max.)	Twist-Lock	6	20A, 125V	HBL2310SW	Yes	Yes	SBTL1
	Twist-Lock	1	30A, 250V	HBL2620SW	Yes	No	
	Twist-Lock (Inlet)	1	50A, 125/250V	HBL6375S	No	No	
	Twist-Lock (Outlet)	1	50A, 125/250V	CS6369	No	No	
50A, 120/240V AC (max.)	Twist-Lock	6	20A, 125V	HBL2310SW	Yes	Yes	SBTL2
	Twist-Lock	1	30A, 250V	HBL2620SW	Yes	Yes	
	Twist-Lock (Inlet)	1	50A, 125/250V	HBL6375S	No	No	
	Twist-Lock (Outlet)	1	50A, 125/250V	CS6369	No	No	
60A, 3Ø 120/208V AC (max.)	Twist-Lock	6	20A, 125V	HBL2310SW	Yes	Yes	SCTL0
	Pin & Sleeve (Inlet)	1	60A, 3ØY 120/208V	HBL560B9R	No	No	
	Pin & Sleeve (Outlet)	1	60A, 3ØY 120/208V	HBL560R9W	No	No	
60A, 3Ø 120/208V AC (max.)	Straight Blade	6	20A, 125V	HBL53R61	Yes	Yes	SCSB0
	Pin & Sleeve (Inlet)	1	60A, 3ØY 120/208V	HBL560B9R	No	No	
	Pin & Sleeve (Outlet)	1	60A, 3ØY 120/208V	HBL560R9W	No	No	

Note: 60A units are UL and cUL only.



Entertainment Industry Products HI-Impact™ Ethernet



Hubbell's HI-Impact Ethernet System provides leading edge technology for Category 5e and 6-network transmission performance suitable for industrial and any other harsh environments. This system incorporates the use of our standard data connectivity jacks, which feature our keystone latching mechanism, in a rugged sealed housing that provides IP67 rated protection. This allows you to extend your LAN to include automation equipment and manufacturing or process control equipment. Utilize the Hubbell system to provide added protection within environments such as convention centers, food processing plants, medical industries, outdoor billboards, display screens or any other environment which requires added protection from moisture, corrosion, dust, debris, vibration and chemicals.



Industrial Ethernet Connectors

Type	Cat. No.
Cat 6 connector.	HBLHI6
Cat 5e connector.	HBLHI5E
Cat 5e in-line coupler.	HBLHI5EC
Cat 5e shielded.	HBLHI5ESC
M12 MicroQuick, 4-position, male.	MBMS14314



Industrial Ethernet Patch Cords and Plugs

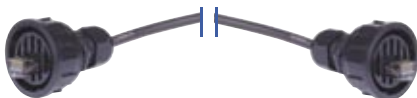

HI-Impact to HI-Impact Connector		
Type	Cat. No.	
Cat 6	HBLHI6xxEE	
Cat 5e	HBLHI5ExxEE	
Cat 5e, shielded	HBLHI5ESxxEE	
F-type	HBLHIFxxEE	



HI-Impact Connector to RJ-45		
Type	Cat. No.	
Cat 6	HBLHI6xxAE	
Cat 5e	HBLHI5ExxAE	
Cat 5e, shielded	HBLHI5ESxxAE	
F-type	HBLHIFxxAE	



HI-Impact RJ-45 to RJ-45		
Type	Cat. No.	
Cat 6	HBLHI6xxAA	
Cat 5e	HBLHI5ExxAA	
Cat 5e, shielded	HBLHI5ESxxAA	
F-type	HBLHIFxxAA	

XX = Length To order replace XX Suffix with the following: 03 = 3' 05 = 5' 07 = 7' 10 = 10' 12 = 12' 15 = 15' 20 = 20' 25 = 25'

Industrial Ethernet Wall Plates and Accessories

Stainless Steel Wall Plates

Gang	Openings	Catalog No.
1	1	HBLHISF11
1	2	HBLHISF12
2	2	HBLHISF22
2	4	HBLHISF24



Thermoplastic, 4-Point FSFS, 1-Gang

Ports	Color	Catalog No.
1	Gray	HBLHI14GY
2	Gray	HBLHI24GY
1	Yellow	HBLHI114PY
2	Yellow	HBLHI124PY



Secure-IT™ Weatherproof NEMA 3R Plate

Description	Gang	Catalog No.
Secure-IT™	1	HBLTWP1GY



Connector Cap

Description	Catalog No.
Connector Cap	HBLHIC



Entertainment Industry Products Voice, Data & Video



Category 6, 5e and USOC 6-Position Jacks

Category 6 Catalog No.	Category 5e Catalog No.	USOC Catalog No.
HBL6XX	HBL5EXX	HBLUXX

XX=Color; To order replace XX Suffix with the following:
BK (Black), B (Blue), EI (Electric Ivory), GY (Gray), GN (Green), R (Red), OW (Office White), OR (Orange), TI (Telco Ivory), W (White) and Y (Yellow)



HBL6GN



HBL6OR



HBL6W

Multimedia Snap In Connectors

Type	Available Colors	Catalog Numbers
Blank, 10 pack	OW, GY, I, W	SIBXXPK10
RCA 110 Punch Down, Black Housing	OW*, W*, Y*	SIRCAXX
RCA Gold Pass-Thru F/F Coupler Office White Housing	R*, W*, Y*, BK*	SIRCAFFXX
RCA Solder Coupler Termination Office White Housing	R*, W*, Y*, BK*	SIRCASXX
S-Video 110, Punchdown	Black only	SISVOW
F-Type Coupler, Bulkhead F/F	OW, GY, I, W	SIFXX
BNC F/F Coupler	OW, GY, I, W	SIBNCXX
ST-Style Adapter, Black*	OW, GY, I, W	SISTXX
S-Video F/F Coupler	Black only	SISVFFBK
SC Simplex Adapter Office White Housing	Blue only*	SIFSCOW

* Insulator Colors

XX=Color; To order replace XX Suffix with the available color:
BK (Black), GY (Gray), R (Red), OW (Office white), W (White) and Y (Yellow)

Outlet Frames

Style	Style Line	106 Duplex
2-port	FCX244XX	DJOXX
3-port	FCX344XX	—
4-port	FCX444XX	DJ106XX
6-port	FCX644XX	—

XX=Color; To order replace XX Suffix with the following:
BK (Black), GY (Gray), I (Ivory), OW (Office white) and W (White)

HP Single Gang Plates

Style	Available Colors	Catalog Numbers
Rectangular	B, G, DOW, WA, I	HPS1XX
Duplex	B, G, DOW, W	P8XX*

* for Ivory do not add suffix (P8)

XX=Color; To order replace XX Suffix with the available color:
B (Black), G (Gray), I (Ivory), DOW (Office white) and W or WA (White)

Data & Communication Rear-Loading Wall Plates

Gang	Color	Available Port Sizes	Catalog Numbers
One	Office White	1, 2, 3, 4, 6	DP1XOW
Two	Office White	6, 9, 12	DP2XOW
One	Stainless Steel	1, 2, 3, 4, 6	DP1XS
Two	Stainless Steel	4, 6, 9, 12	DP2XS

X=Port Size; To order replace X with the Port Size.



SIBOWPK10 SIRCAOW



SIRCAFFR SIRCASR



SISVOW SIFOW



SIBNCOW SISTOW



SISVFFBK SIFSCOW



FCX244OW FCX444OW



DJOOW DJ106OW



HPS1DOW P8DOW



DP12OW DP14OW

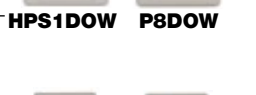

DP11S DP16S

Data Modular Face Plate Frames



Color	1 Gang	2 Gang
Office White	DF1OW	DF2OW

Data Plate Modules



Type	Port	Unit	Catalog No.
Blank	—	0.5	DFBM05OW*
Blank	—	1	DFBM10OW*
Blank	—	1.5	DFBM15OW*

* Sold in packages of five.

Keystone:



Type	Port	Unit	Catalog No.
Flat	1	1	DF1KOW
Flat	2	1	DF2KOW
Angled	1	1.5	DFA1KOW
Angled	2	1.5	DFA2KOW

SC Angled:



Type	Port	Unit	Catalog No.
1 Duplex	—	1.5	DFA1SCOW
2 Duplex	—	2	DFA2SCOW

Recessed:



Type	Port	Unit	Catalog No.
Keystone, Angled	1	1.5	DFRA1KOW
Keystone, Angled	2	2	DFRA2KOW

9 & 15 Pin Gender Changer:



Type	Port	Unit	Catalog No.
9 Pin F/F, D-Stub	1	1	DF19FFOW
15 Pin F/F, D-Stub	1	1	DF115FFOW

15 Pin Terminal SVGA:



Type	Port	Unit	Catalog No.
15 Pin F/Screw D-Stub	1	1	DF115SOW

SC Modules



Type	Color	Catalog No.
SC Duplex Adapter Screw Mount	Blue	SIFSC
SC to ST-Style, Duplex Adapter Screw Mount	Blue	SIFSCST

Entertainment Industry Products Convention Center Floor Box



 Hubbell has listened to the entertainment industry and we are now pleased to introduce the first UL Listed convention center floor box as a solution to safely deliver utilities to the exhibit floor. The floor boxes are custom manufactured with provisions for power, datacom, water and compressed air.

 Hubbell provides a unique solution in safely keeping power and water in separate enclosures. This is accomplished by having two boxes joined together, while maintaining separate drains and lift covers. Let Hubbell provide a custom floor box to fit your facility needs and also provide the safety that no other box can.

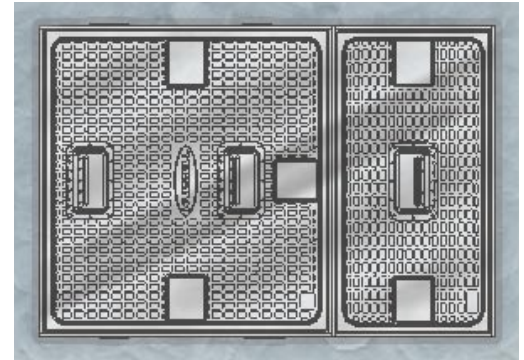

The Floor Box

A galvanized sheet steel concrete cover is provided with each box to protect the cast aluminum cover during the concrete pour.



Safety-bars are provided in each corner of the cover flange to prevent the cover from potentially falling into the box and damaging the panel components.

A steel frame provides structural support and is zinc-coated for corrosion resistance.

Conduit feeds can be easily field cut to the specified conduit size.

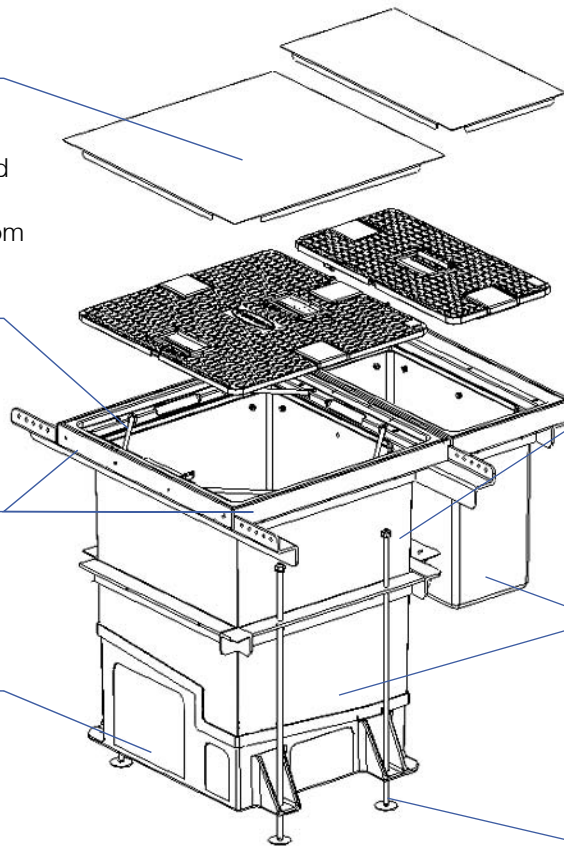

The box is constructed of polyurethane for resistance to rust and corrosion. The material meets UL94 V-0 and 5VA flammability requirements.

Power/datacom and water/compressed air are contained in separate enclosures to provide maximum safety.

The box can be easily leveled prior to the pour by simply adjusting the extra long threaded rods.

Entertainment Industry Products Convention Center Floor Box



The Interior

Circuit breaker protection is provided for 20 and 30 Amp receptacles. Circuit breaker protection is optional for the Pin & Sleeve receptacle.

The datacom panel can be provided with a variety of devices that are protected by weatherproof covers. Customers can specify fiber optic, A/V, Category 5e jacks, or other devices for communication.

The power panel can be provided with a combination of Hubbell Pin and Sleeve, Twist-Lock® and straight blade devices.

Panels are constructed of brushed stainless steel for durability and corrosion resistance. Panels are gasketed and angled toward the drain to prevent the ingress of water.

A two-inch drain with overflow protection can be optionally plumbed.

White walls provide increased visibility in the box interior.

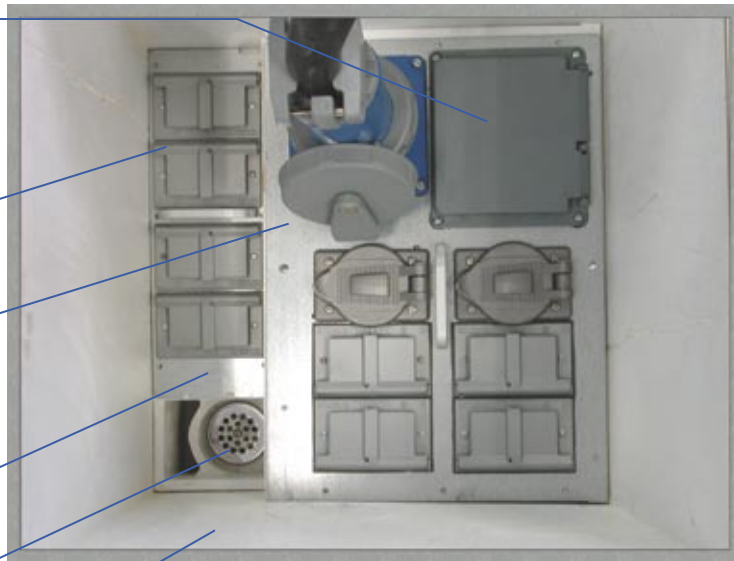

The Cover

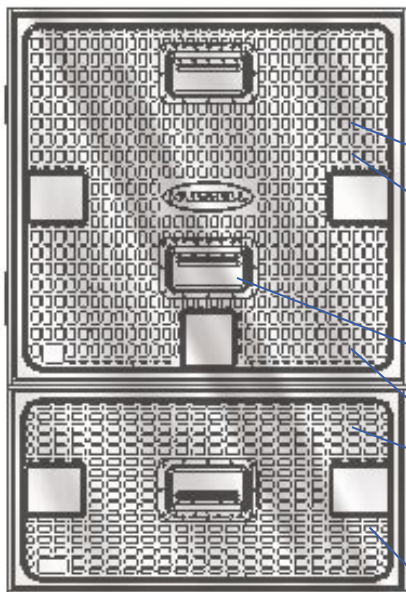

The cast aluminum cover is UL Listed, designed and tested with a 35,000 lb. load capacity. Load capacity is engraved on the cover. The gasketed cover meets UL requirements for scrubwater. The box and cover have been designed to allow a Pin & Sleeve plug/receptacle to be engaged while the cover remains closed to prevent accidents. The cover is removable for full access to the interior. The hingsless design eliminates components that can be easily broken in the convention center environment.

A textured surface provides skid resistance.

Large heavy-duty handles can easily be accessed with gloved hands to remove the cover. The handles are also spring loaded to prevent potential breakage.

Power/datacom and water/compressed air are accessed through separate covers. The cover flange is constructed of cast aluminum.

Multiple drop-down cable access doors provide various cable exits for separation of power/datacom. The cable doors enable radial bends for cable management of festoon and entertainment cable. All doors incorporate friction hinges and gasketed to prevent the ingress of water.



HUBBELL

Entertainment Industry Products

