

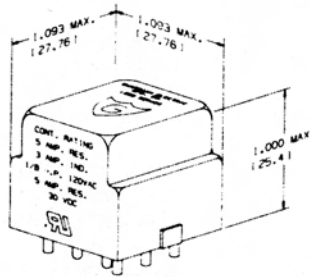

1360PC/1365PC SERIES - DPDT

- DPDT (2C)
- Rated: 5 amps at 30 VDC and 120 VAC Resistive load, 1/8 H.P., 120 VAC
- Termination suitable for socket or Printed circuit
- Standard/stock AC coil voltages 24, 120
- Standard/stock DC coil voltage 12, 24
- Sockets available
- Weight 1 oz. (28 grams)



5 AMPS

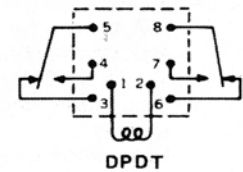
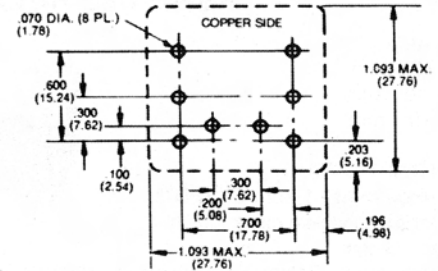

Coil Voltage	Coil Res. Ω	PART NUMBERS
24 VAC	150	1360PC-2C-24A
120 VAC	3500	1360PC-2C-120A
12 VDC	150	1365PC-2C-12D
24 VDC	600	1365PC-2C-24D

1330/1335 SERIES - DPDT

- DPDT (2C)
- Rated: 5 amps at 30 VDC & 120 VAC Resistive load; 3 amps at 120 VAC Inductive load; 1/8 H.P., 120 VAC.
- Sealed versions 1330S & 1335S
- Plug in/solder lug terminals 1330 & 1335
- Printed circuit terminals 1330P & 1335P
- Standard/stock AC coil voltages (1330) 12, 24, 120
- Standard/stock DC coil voltages (1335) 12, 24
- Sockets available
- Weight .75 oz. (21 grams)

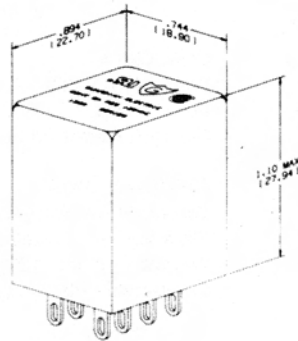

5 AMPS

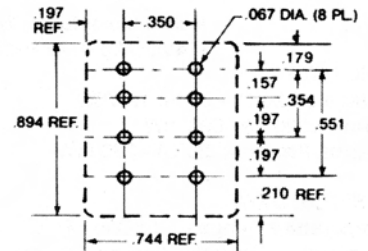

CIRCUIT DIAGRAM

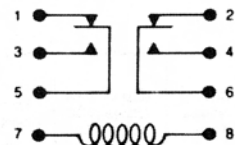

Coil Voltage	Coil Res. Ω	PART NUMBERS		
		Plug In	P.C.	P.C. Sealed
12VAC	49.5	1330-2C-12A	1330P-2C-12A	1330PS-2C-12A
24VAC	245	1330-2C-24A	1330P-2C-24A	1330PS-2C-24A
120VAC	5400	1330-2C-120A	1330P-2C-120A	1330PS-2C-120A
12VDC	125	1335-2C-12D	1335P-2C-12D	1335PS-2C-12D
24VDC	500	1335-2C-24D	1335P-2C-24D	1335PS-2C-24D

1310/1315 SERIES - DPDT & 4 PDT

- 4PDT (4C) or DPDT (2C)
- Rated: 5 amps at 30 VDC & 120 VAC Resistive load, 3 amps at 120 VAC Inductive load; 1/8 H.P., 120 VAC.
- Sealed versions 1310PS, 1315PS
- Plug in/solder lug terminals 1310, 1315
- Printed circuit terminal 1310P, 1315P
- Standard/stock AC coil voltages (1310) 12, 24, 120
- Standard/stock DC coil voltages (1315) 12, 24, 110
- Sockets available
- Weight 1.52 oz. (43 grams)

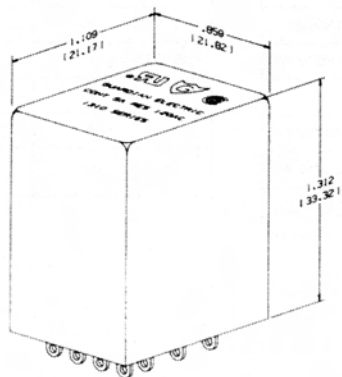

5 AMPS

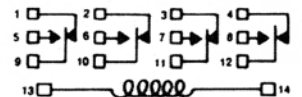
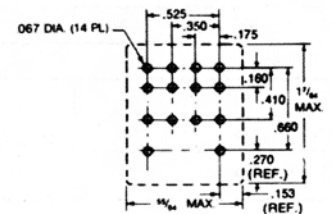

4PDT

Coil Voltage	Coil Res. Ω	PART NUMBERS		
		Plug In	P.C.	P.C. Sealed
12VAC	45	1310-4C-12A	1310P-4C-12A	1310PS-4C-12A
24VAC	160	1310-4C-24A	1310P-4C-24A	1310PS-4C-24A
120VAC	3900	1310-4C-120A	1310P-4C-120A	1310PS-4C-120A
12VDC	160	1315-4C-12D	1315P-4C-12D	1315PS-4C-12D
24VDC	650	1315-4C-24D	1315P-4C-24D	1315PS-4C-24D
110VDC	11000	1315-4C-110D	1315P-4C-110D	1315PS-4C-110D

DPDT

Coil Voltage	Coil Res. Ω	PART NUMBERS	
		Plug In	P.C.
12VAC	45	1310-2C-12A	1310P-2C-12A
24VAC	160	1310-2C-24A	1310P-2C-24A
120VAC	3900	1310-2C-120A	1310P-2C-120A
12VDC	160	1315-2C-12D	1315P-2C-12D
24VDC	650	1315-2C-24D	1315P-2C-24D
110VDC	11000	1315-2C-110D	1315P-2C-110D