

MM74HC4060 14 Stage Binary Counter

General Description

The MM74HC4060 is a high speed binary ripple carry counter. These counters are implemented utilizing advanced silicon-gate CMOS technology to achieve speed performance similar to LS-TTL logic while retaining the low power and high noise immunity of CMOS.

The MM74HC4060 is a 14-stage counter, which device increments on the falling edge (negative transition) of the input clock, and all their outputs are reset to a low level by applying a logical high on their reset input. The MM74HC4060 also has two additional inputs to enable easy connection of either an RC or crystal oscillator.

This device is pin equivalent to the CD4060. All inputs are protected from damage due to static discharge by protection diodes to V_{CC} and ground.

Features

- Typical propagation delay: 16 ns
- Wide operating voltage range: 2–6V
- Low input current: 1 μ A maximum
- Low quiescent current: 80 μ A maximum (74 Series)
- Output drive capability: 10 LS-TTL loads

Ordering Code:

Order Number	Package Number	Package Description
MM74HC4060M	M16A	16-Lead Small Outline Integrated Circuit (SOIC), JEDEC MS-012, 0.150" Narrow
MM74HC4060SJ	M16D	16-Lead Small Outline Package (SOP), EIAJ TYPE II, 5.3mm Wide
MM74HC4060MTC	MTC16	16-Lead Thin Shrink Small Outline Package (TSSOP), JEDEC MO-153, 4.4mm Wide
MM74HC4060N	N16E	16-Lead Plastic Dual-In-Line Package (PDIP), JEDEC MS-001, 0.300" Wide

Devices also available in Tape and Reel. Specify by appending the suffix letter "X" to the ordering code.

Connection Diagram

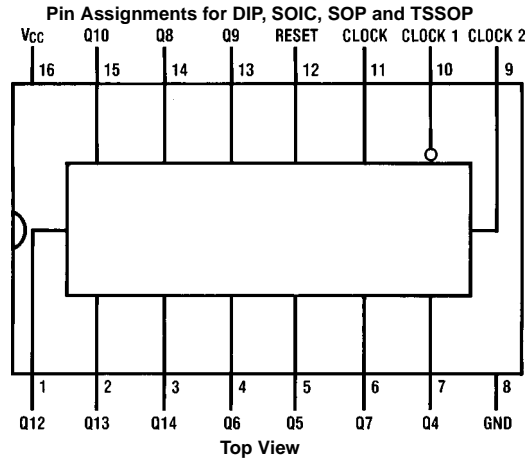

Logic Diagram

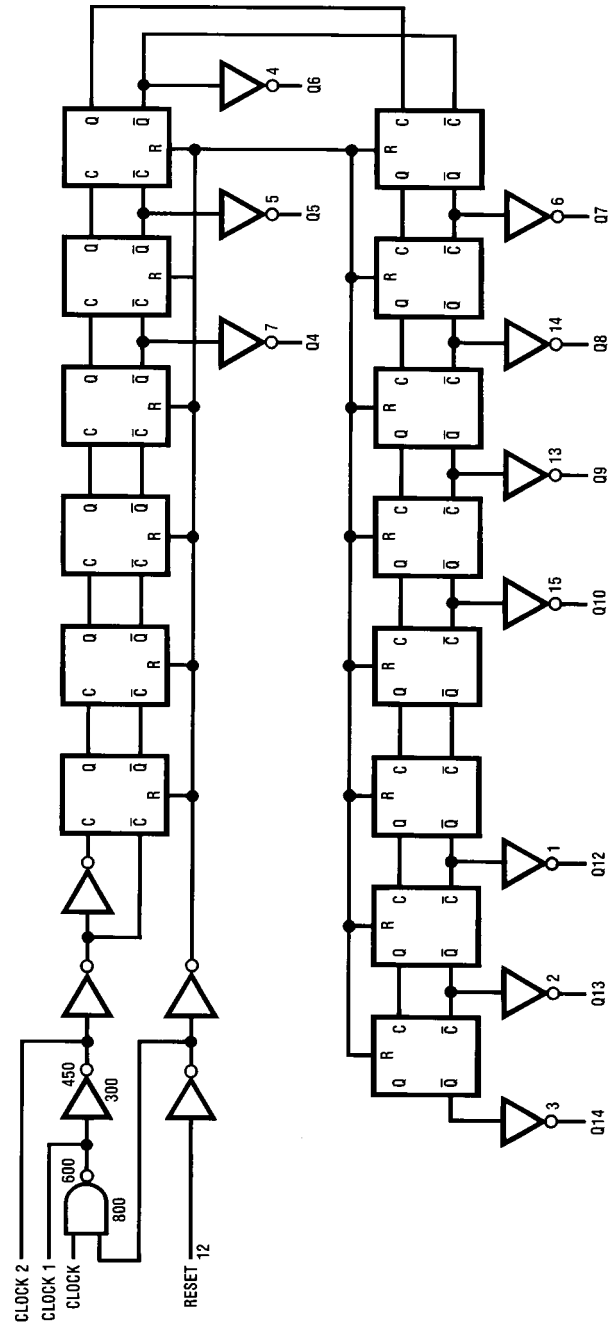

Absolute Maximum Ratings (Note 1)		Recommended Operating Conditions			
(Note 2)			Min	Max	Units
Supply Voltage (V_{CC})	-0.5 to +7.0V	Supply Voltage (V_{CC})	2	6	V
DC Input Voltage (V_{IN})	-1.5 to $V_{CC} + 1.5V$	DC Input or Output Voltage			
DC Output Voltage (V_{OUT})	-0.5 to $V_{CC} + 0.5V$	(V_{IN}, V_{OUT})	0	V_{CC}	V
Clamp Diode Current (I_{CD})	± 20 mA	Operating Temperature Range (T_A)	-40	+85	$^{\circ}C$
DC Output Current, per pin (I_{OUT})	± 25 mA	Input Rise or Fall Times			
DC V_{CC} or GND Current, per pin (I_{CC})	± 50 mA	(t_r, t_f) $V_{CC} = 2.0V$		1000	ns
Storage Temperature Range (T_{STG})	-65 $^{\circ}C$ to +150 $^{\circ}C$	$V_{CC} = 4.5V$		500	ns
Power Dissipation (P_D)		$V_{CC} = 6.0V$		400	ns
(Note 3)	600 mW				
S.O. Package only	500 mW				
Lead Temperature (T_L)					
(Soldering 10 seconds)	260 $^{\circ}C$				

Note 1: Maximum Ratings are those values beyond which damage to the device may occur.

Note 2: Unless otherwise specified all voltages are referenced to ground.

Note 3: Power Dissipation temperature derating: plastic "N" package: -12 mW/ $^{\circ}C$ from 65 $^{\circ}C$ to 85 $^{\circ}C$.

DC Electrical Characteristics (Note 4)

Symbol	Parameter	Conditions	V_{CC}	$T_A = 25^{\circ}C$			$T_A = -40$ to $85^{\circ}C$	$T_A = -55$ to $125^{\circ}C$	Units
				Typ	Guaranteed Limits				
V_{IH}	Minimum HIGH Level Voltage (Not Applicable to Pins 9 & 10)		2.0V		1.5	1.5	1.5	V	
			4.5V		3.15	3.15	3.15	V	
			6.0V		4.2	4.2	4.2	V	
V_{IL}	Maximum LOW Level Input Voltage (Not Applicable to Pins 9 & 10)		2.0V		0.5	0.5	0.5	V	
			4.5V		1.35	1.35	1.35	V	
			6.0V		1.8	1.8	1.8	V	
V_{OH}	Minimum HIGH Level Output Voltage	$V_{IN} = V_{IH}$ or V_{IL} $ I_{OUT} \leq 20 \mu A$	2.0V	2.0	1.9	1.9	1.9	V	
			4.5V	4.5	4.4	4.4	4.4	V	
			6.0V	6.0	5.9	5.9	5.9	V	
		Except Pins 9 & 10	$V_{IN} = V_{IH}$ or V_{IL} $ I_{OUT} \leq 4.0$ mA	4.5V	4.2	3.98	3.84	3.7	V
			$ I_{OUT} \leq 5.2$ mA	6.0V	5.7	5.48	5.34	5.2	V
		Pins 9 & 10	$V_{IN} = V_{IH}$ or V_{IL} $ I_{OUT} = 0.4$ mA $ I_{OUT} = 0.52$ mA			3.98	3.84	3.7	V
V_{OL}	Maximum LOW Level Output Voltage	$V_{IN} = V_{IH}$ or V_{IL} $ I_{OUT} \leq 20 \mu A$	2.0V	0	0.1	0.1	0.1	V	
			4.5V	0	0.1	0.1	0.1	V	
			6.0V	0	0.1	0.1	0.1	V	
		Except Pins 9 & 10	$V_{IN} = V_{IH}$ or V_{IL} $ I_{OUT} \leq 4.0$ mA	4.5V	0.2	0.26	0.33	0.4	V
			$ I_{OUT} \leq 5.2$ mA	6.0V	0.2	0.26	0.33	0.4	V
		Pins 9 & 10	$V_{IN} = V_{IH}$ or V_{IL} $ I_{OUT} = 0.4$ mA $ I_{OUT} = 0.52$ mA			0.26	0.33	0.4	V
I_{IN}	Maximum Input Current	$V_{IN} = V_{CC}$ or GND	6.0V		± 0.1	± 1.0	± 1.0	μA	
I_{CC}	Maximum Quiescent Supply Current	$V_{IN} = V_{CC}$ or GND $I_{OUT} = 0 \mu A$	6.0V		8.0	80	160	μA	

Note 4: For a power supply of 5V $\pm 10\%$ the worst case output voltages (V_{OH} , and V_{OL}) occur for HC at 4.5V. Thus the 4.5V values should be used when designing with this supply. Worst case V_{IH} and V_{IL} occur at $V_{CC} = 5.5V$ and 4.5V respectively. (The V_{IH} value at 5.5V is 3.85V.) The worst case leakage current (I_{IN} , I_{CC} , and I_{OZ}) occur for CMOS at the higher voltage and so the 6.0V values should be used.

AC Electrical Characteristics

$V_{CC} = 5V$, $T_A = 25^\circ C$, $C_L = 15$ pF, $t_r = t_f = 6$ ns

Symbol	Parameter	Conditions	Typ	Guaranteed Limit	Units
f_{MAX}	Maximum Clock Frequency			30	MHz
t_{PHL} , t_{PLH}	Maximum Propagation Delay to Q_4	(Note 5)	40	20	ns
t_{PHL} , t_{PLH}	Maximum Propagation Delay to any Q		16	40	ns
t_{REM}	Minimum Reset Removal Time		10	20	ns
t_W	Minimum Pulse Width		10	16	ns

AC Electrical Characteristics

$V_{CC} = 2.0V$ to $6.0V$, $C_L = 50$ pF, $t_r = t_f = 6$ ns (unless otherwise specified)

Symbol	Parameter	Conditions	V_{CC}	$T_A = 25^\circ C$		$T_A = -40$ to $85^\circ C$	$T_A = -55$ to $125^\circ C$	Units
				Typ	Guaranteed Limits			
f_{MAX}	Maximum Operating Frequency		2.0V		6	5	4	MHz
			4.5V		30	24	20	MHz
			6.0V		35	28	24	MHz
t_{PHL} , t_{PLH}	Maximum Propagation Delay Clock to Q_4		2.0V	120	380	475	171	ns
			4.5V	42	76	95	114	ns
			6.0V	35	65	81	97	ns
t_{PHL}	Maximum Propagation Delay Reset to any Q		2.0V	72	240	302	358	ns
			4.5V	24	48	60	72	ns
			6.0V	20	41	51	61	ns
t_{PHL} , t_{PLH}	Maximum Propagation Delay Between Stages Q_n to Q_{n+1}		2.0V		125	156	188	ns
			4.5V		25	31	38	ns
			6.0V		21	26	31	ns
t_{REM}	Minimum Reset Removal Time		2.0V		100	125	150	ns
			4.5V		20	25	30	ns
			6.0V		17	21	25	ns
t_W	Minimum Pulse Width		2.0V		80	100	120	ns
			4.5V		16	20	24	ns
			6.0V		14	17	20	ns
t_r , t_f	Maximum Input Rise and Fall Time		2.0V		1000	1000	1000	ns
			4.5V		500	500	500	ns
			6.0V		400	400	400	ns
t_{THL} , t_{TLH}	Maximum Output Rise and Fall Time		2.0V	30	75	95	110	ns
			4.5V	10	15	19	22	ns
			6.0V	9	13	16	19	ns
C_{PD}	Power Dissipation Capacitance (Note 6)	(per package)		55				pF
C_{IN}	Maximum Input Capacitance			5	10	10	10	pF

Note 5: Typical Propagation delay time to any output can be calculated using: $t_p = 17+12(N-1)$ ns; where N is the number of the output, Q_W , at $V_{CC} = 5V$.

Note 6: C_{PD} determines the no load dynamic power consumption, $P_D = C_{PD} V_{CC}^2 f + I_{CC} V_{CC}$, and the no load dynamic current consumption, $I_S = C_{PD} V_{CC} f + I_{CC}$.

Timing Diagram

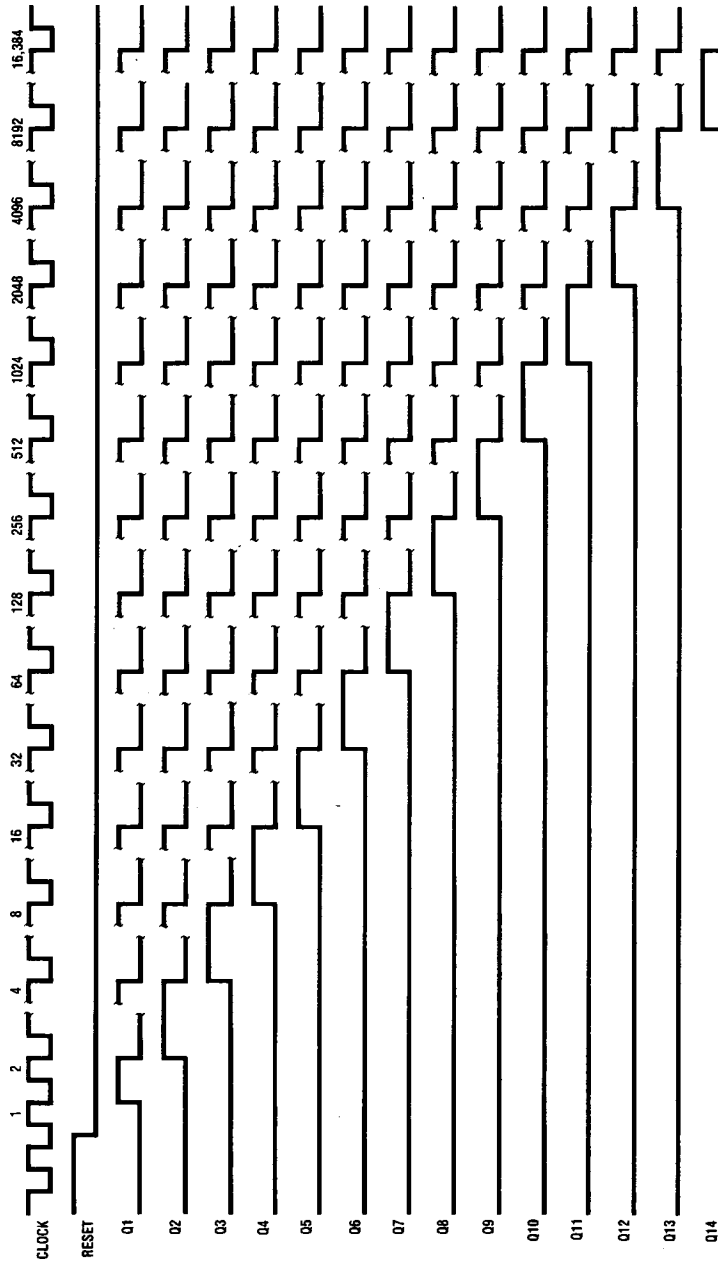

Physical Dimensions inches (millimeters) unless otherwise noted

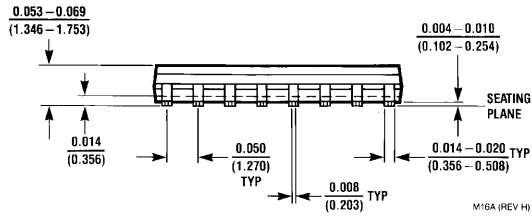
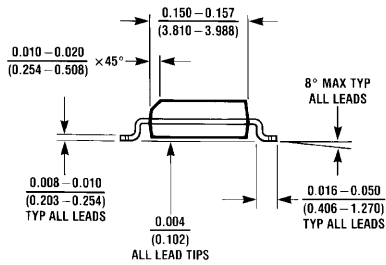
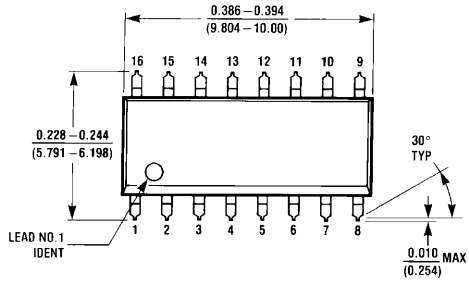

16-Lead Small Outline Integrated Circuit (SOIC), JEDEC MS-012, 0.150" Narrow Package Number M16A

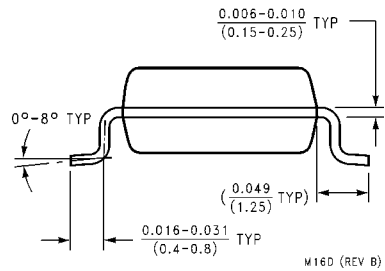
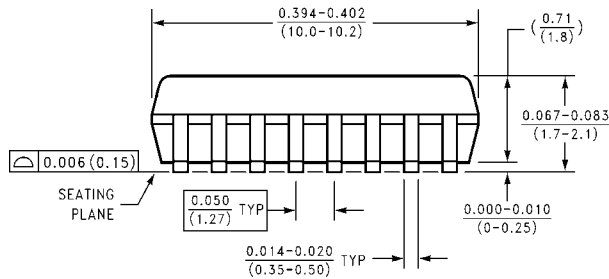
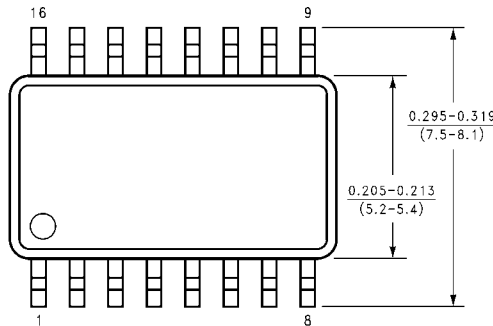

16-Lead Small Outline Package (SOP), EIAJ TYPE II, 5.3mm Wide Package Number M16D

Physical Dimensions inches (millimeters) unless otherwise noted (Continued)

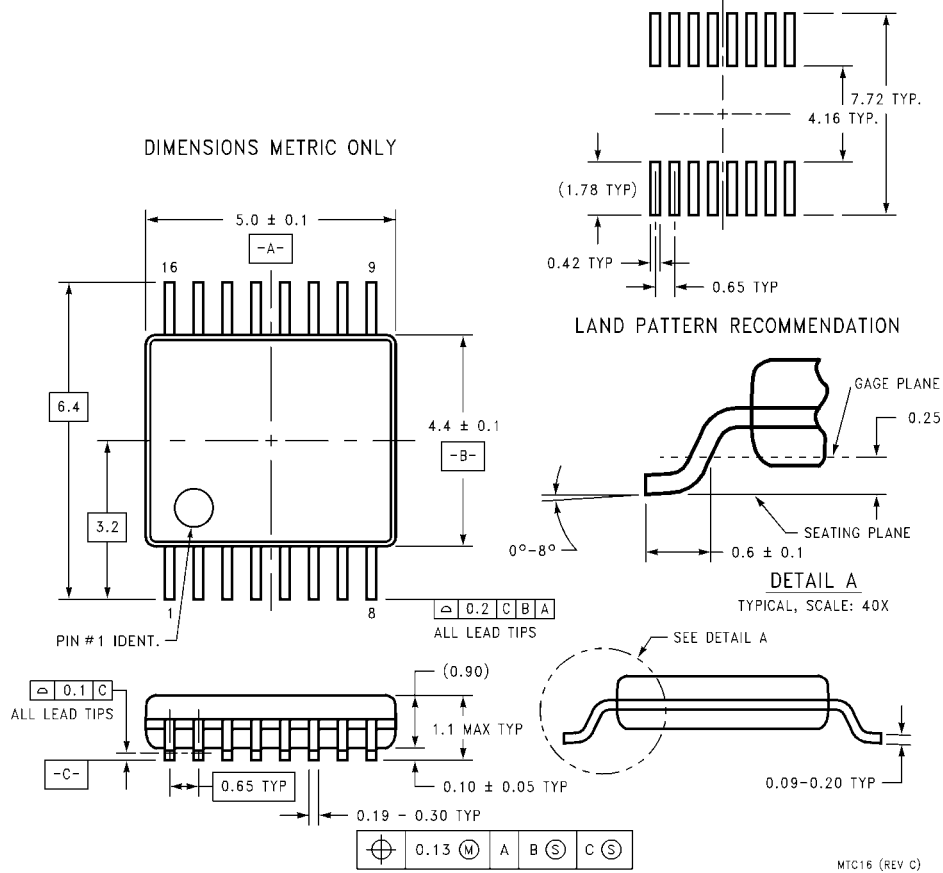

**16-Lead Thin Shrink Small Outline Package (TSSOP), JEDEC MO-153, 4.4mm Wide
Package Number MTC16**

