

# 287/289

True-rms Digital Multimeters

## Calibration Manual

## ***Lifetime Limited Warranty***

Each Fluke 20, 70, 80, 170, 180 and 280 Series DMM will be free from defects in material and workmanship for its lifetime. As used herein, "lifetime" is defined as seven years after Fluke discontinues manufacturing the product, but the warranty period shall be at least ten years from the date of purchase. This warranty does not cover fuses, disposable batteries, damage from neglect, misuse, contamination, alteration, accident or abnormal conditions of operation or handling, including failures caused by use outside of the product's specifications, or normal wear and tear of mechanical components. This warranty covers the original purchaser only and is not transferable.

For ten years from the date of purchase, this warranty also covers the LCD. Thereafter, for the lifetime of the DMM, Fluke will replace the LCD for a fee based on then current component acquisition costs.

To establish original ownership and prove date of purchase, please complete and return the registration card accompanying the product, or register your product on <http://www.fluke.com>. Fluke will, at its option, repair at no charge, replace or refund the purchase price of a defective product purchased through a Fluke authorized sales outlet and at the applicable international price. Fluke reserves the right to charge for importation costs of repair/replacement parts if the product purchased in one country is sent for repair elsewhere.

If the product is defective, contact your nearest Fluke authorized service center to obtain return authorization information, then send the product to that service center, with a description of the difficulty, postage and insurance prepaid (FOB Destination). Fluke assumes no risk for damage in transit. Fluke will pay return transportation for product repaired or replaced in-warranty. Before making any non-warranty repair, Fluke will estimate cost and obtain authorization, then invoice you for repair and return transportation.

THIS WARRANTY IS YOUR ONLY REMEDY. NO OTHER WARRANTIES, SUCH AS FITNESS FOR A PARTICULAR PURPOSE, ARE EXPRESSED OR IMPLIED. FLUKE SHALL NOT BE LIABLE FOR ANY SPECIAL, INDIRECT, INCIDENTAL OR CONSEQUENTIAL DAMAGES OR LOSSES, INCLUDING LOSS OF DATA, ARISING FROM ANY CAUSE OR THEORY. AUTHORIZED RESELLERS ARE NOT AUTHORIZED TO EXTEND ANY DIFFERENT WARRANTY ON FLUKE'S BEHALF. Since some states do not allow the exclusion or limitation of an implied warranty or of incidental or consequential damages, this limitation of liability may not apply to you. If any provision of this warranty is held invalid or unenforceable by a court or other decision-maker of competent jurisdiction, such holding will not affect the validity or enforceability of any other provision.

# Table of Contents

Title	Page
Lifetime Limited Warranty .....	2
Introduction.....	1
Contacting Fluke.....	1
Precautions and Safety Information.....	2
International Symbols .....	2
Safety Information .....	2
Hazardous Voltage.....	4
General Specifications .....	5
Detailed Specifications .....	5
AC Voltage Specifications .....	6
AC Current Specifications.....	6
DC Voltage Specification.....	7
DC Current Specifications.....	7
Resistance Specifications .....	7
Temperature Specifications .....	8
Capacitance and Diode Test Specifications.....	8
Frequency Counter Specifications.....	8
Frequency Counter Sensitivity .....	9
MIN MAX, Recording, and Peak Specifications .....	9
Input Characteristics.....	9
Burden Voltage (A, mA, $\mu$ A).....	10
Required Equipment .....	10
Basic Maintenance .....	11
Opening the Meter Case .....	11
Removing and Reinserting the Printed Circuit Assembly.....	11
Reassembling the Meter Case.....	12
Testing Fuses (F1 and F2) .....	12
Replacing Fuses.....	13
Replacing the Batteries .....	13
Cleaning.....	14
Performance Tests.....	14
Factory Default.....	15
Power LED Test .....	15
Backlight Test.....	15
Current Terminal Sensing Test.....	15
Keypad Test.....	15

LCD Test .....	15
IR Port Verification .....	16
Temperature Accuracy Test.....	16
Accuracy Tests for Volts, Current, $\Omega$ , $\rightarrow$ , and $\leftarrow$ Test Functions .....	17
Calibration Adjustment.....	20
Operation .....	21
Entering the Password .....	21
Changing the Password .....	21
Restoring Factory Default Password .....	21
Adjustment Procedure Operation .....	22
Screenshot Description.....	22
Softkeys.....	23
Navigation Buttons.....	23
Mode Buttons.....	23
Description of Calibration Adjustment Steps.....	23
Power Cycle .....	24
Calibration Adjustment Steps .....	24
Parts .....	29

# List of Tables

<b>Table</b>	<b>Title</b>	<b>Page</b>
1.	Symbols.....	2
2.	Required Equipment.....	10
3.	Temperature Test Input and Display .....	17
4.	287/289 Performance Test Steps.....	17
5.	Calibration Entry Soft Keys .....	21
6.	Softkey Functions during Calibration .....	23
7.	Calibration Adjustment Steps for Firmware Ver. 1.00 .....	24
8.	Calibration Adjustment Steps for Firmware Ver. 1.10 .....	26
9.	Replacement Parts .....	29



# List of Figures

<b>Figure</b>	<b>Title</b>	<b>Page</b>
1.	Testing the Current Fuses.....	13
2.	Battery and Fuse Replacement.....	14
3.	PCA Component Location .....	22
4.	Calibration Adjustment Screenshot.....	22
5.	Replacement Parts .....	30





# ***True-rms Digital Multimeters***

## ***Introduction***

### **⚠⚠ Warning**

**To avoid shock or injury, do not perform the verification tests or calibration procedures described in this manual unless you are qualified to do so.**

**The information provided in this document is for the use of qualified personnel only.**

### **⚠ Caution**

**The 287 & 289 True-rms Digital Multimeters contain parts that can be damaged by static discharge.**

**Follow the standard practices for handling static sensitive devices.**

The information in this manual deals with the Fluke Models 287 & 289 True-rms Digital Multimeters, (hereafter referred to as “the Meter”). Information provided includes:

- Precautions and safety information
- Specifications
- Basic maintenance (cleaning, replacing the battery and fuses)
- Performance test procedures
- Calibration and calibration adjustment procedures
- Accessories and replaceable parts

For complete operating instructions, refer to the *Model 287 & 289 Users Manual* located on the *287/289 CD ROM*.

## ***Contacting Fluke***

To order accessories, receive assistance, or locate the nearest Fluke distributor or Service Center, call:

USA: 1-888-99-FLUKE (1-888-993-5853)

Canada: 1-800-36-FLUKE (1-800-363-5853)

Europe: +31 402-678-200

Japan: +81-3-3434-0181

Singapore: +65-738-5655

Anywhere in the world: +1-425-446-5500

Address correspondence to:

Fluke Corporation  
P.O. Box 9090,  
Everett, WA 98206-9090  
USA

Fluke Europe B.V.  
P.O. Box 1186,  
5602 BD Eindhoven  
The Netherlands

Visit us on the World Wide Web at: [www.fluke.com](http://www.fluke.com)

## Precautions and Safety Information

### Warning

**To avoid possible electric shock or personal injury, use this Meter only as specified in this manual or the protection provided by the Meter might be impaired.**











Read the “Safety Information” page before servicing this product.

In this manual, a **Warning** identifies conditions and actions that pose hazard(s) to the user; a **Caution** identifies conditions and actions that may damage the Meter or the test instruments.

## International Symbols

International symbols used on the Meter and in this manual are explained in Table 1.

Table 1. Symbols

Symbol	Description	Symbol	Description
~	AC (Alternating Current or Voltage)		Fuse
≡	DC (Direct Current or Voltage)		Double Insulated
	Hazardous voltage		Important Information; refer to manual
	Battery (Low battery when shown on the display)		Earth ground
)	Continuity test or continuity beeper tone		Conforms to relevant Canadian and US standards
CE	Conforms to European Union directives		Conforms to relevant Australian standards
	Underwriters Laboratory listed product		Inspected and licensed by TÜV Product Services
<b>CAT III</b>	IEC Measurement Category III – CAT III equipment is designed to protect against transients in equipment in fixed equipment installations, such as distribution panels, feeders and short branch circuits, and lighting systems in large buildings.	<b>CAT IV</b>	IEC Measurement Category IV – CAT IV equipment is designed to protect against transients from the primary supply level, such as an electricity meter or an overhead or underground utility service.
	Do not dispose of this product as unsorted municipal waste. Go to Fluke’s website for recycling information.		

## Safety Information

The Meter complies with:

- ANSI/ISA 82.02.01 (61010-1) 2004
- UL 61010B (2003)

- CAN/CSA-C22.2 No. 61010-1-04
- IEC/EN 61010-1 2<sup>nd</sup> Edition Pollution Degree 2
- EMC EN 61326-1
- Measurement Category III, 1000V, Pollution Degree 2
- Measurement Category IV, 600 V, Pollution Degree 2

**⚠⚠ Warning**

**To avoid possible electric shock or personal injury, follow these guidelines:**

- **Use this Meter only as specified in this manual or the protection provided by the Meter might be impaired.**
- **Do not use the Meter if it is damaged. Before you use the Meter, inspect the case. Look for cracks or missing plastic. Pay particular attention to the insulation surrounding the connectors.**
- **Make sure the battery door is closed and latched before operating the Meter.**
- **Remove test leads from the Meter before opening the battery door.**
- **Inspect the test leads for damaged insulation or exposed metal. Check the test leads for continuity. Replace damaged test leads before using the Meter.**
- **Do not apply more than the rated voltage, as marked on the Meter, between the terminals or between any terminal and earth ground.**
- **Never operate the Meter with the cover removed or the case open.**
- **Use caution when working with voltages above 30 V ac rms, 42 V ac peak, or 60 V dc. These voltages pose a shock hazard.**
- **Use only the replacement fuses specified by the manual.**
- **Use the proper terminals, function, and range for measurements.**
- **Avoid working alone.**
- **When measuring current, turn off circuit power before connecting the Meter in the circuit. Remember to place the Meter in series with the circuit.**
- **When making electrical connections, connect the common test lead before connecting the live test lead; when disconnecting, disconnect the live test lead before disconnecting the common test lead.**
- **Do not use the Meter if it operates abnormally. Protection may be impaired. When in doubt, have the Meter serviced.**

- Do not operate the Meter around explosive gas, vapor, or dust.
- Use only 1.5 V AA batteries, properly installed in the Meter case, to power the Meter.
- When servicing the Meter, use only specified replacement parts.
- When using probes, keep fingers behind the finger guards on the probes.
- Do not use the Low Pass Filter option to verify the presence of hazardous voltages. Voltages greater than what is indicated may be present. First, make a voltage measurement without the filter to detect the possible presence of hazardous voltage. Then select the filter function.
- Only use test leads that have the same voltage, category, and amperage ratings as the meter and that have been approved by a safety agency.
- Use proper protective equipment, as required by local or national authorities when working in hazardous areas.
- Comply with local and national safety requirements when working in hazardous locations.

**⚠ Caution**

To avoid possible damage to the Meter or to the equipment under test, follow these guidelines:



- Disconnect circuit power and discharge all high-voltage capacitors before testing resistance, continuity, diodes, or capacitance.
- Use the proper terminals, function, and range for all measurements.
- Do not remove batteries while the Meter is turned on or a signal is applied to the Meter's input jacks.
- Before measuring current, check the Meter's fuses. (See "Testing the Fuses" in the Users Manual on the accompanying CD.)
- Do not use the LoZ mode to measure voltages in circuits that could be damaged by this mode's low impedance ( $\approx 3 \text{ k}\Omega$ ). (Model 289 only)

## **Hazardous Voltage**

To alert you to the presence of a potentially hazardous voltage, when the Meter detects a voltage  $\geq 30 \text{ V}$  or a voltage overload (OL), the ⚡ symbol is displayed.

## General Specifications

Maximum voltage between any Terminal and Earth Ground: 1000 V

▲ Fuse Protection for mA or $\mu$ A inputs	0.44 A (44/100 A, 440 mA), 1000 V FAST Fuse, Fluke specified part only
▲ Fuse Protection for A input	11 A, 1000 V FAST Fuse, Fluke specified part only
Battery Type	6 AA Alkaline batteries, NEDA 15A IEC LR6
Battery Life	100 hours minimum. 200 hours in Logging mode
<b>Temperature</b>	
Operating	-20 °C to 55 °C
Storage	-40 °C to 60 °C
Relative Humidity	0 % to 90 % (0 °C to 37 °C), 0 % to 65 % (37 °C to 45 °C), 0 % to 45 % (45 °C to 55 °C)
<b>Altitude</b>	
Operating	3,000 m
Storage	10,000 m
Temperature Coefficient	0.05 X (specified accuracy) /°C (<18 °C or >28 °C)
Vibration	Random Vibration per MIL-PRF-28800F Class 2
Shock	1 meter drop per IEC/EN 61010-1 2 <sup>nd</sup> Edition
Size (HxWxL)	8.75 in x 4.03 in x 2.38 in (22.2 cm x 10.2 cm x 6.0 cm)
Weight	28.0 oz (871 g)
<b>Safety Standards</b>	
US ANSI	Complies with ANSI/ISA 82.02.01 (61010-1) 2004
CSA	CAN/CSA-C22.2 No 61010-1-04 to 1000 V Measurement Category III and 600 V Measurement Category IV, Pollution Degree 2
UL	UL 61010 (2003)
CE European	IEC/EN 61010-1 2 <sup>nd</sup> Edition Pollution Degree 2
<b>Electromagnetic Compatibility Standards (EMC)</b>	
European EMC	EN61326-1
Australian EMC	 N10140
US FCC	FCC CFR47: Part 15 CLASS A
Certifications	UL, CE, CSA,  , 

## Detailed Specifications

### Accuracy:

Accuracy is specified for a period of one year after calibration, at 18 °C to 28 °C (64 °F to 82 °F), with relative humidity to 90 %. Accuracy specifications are given as:  $\pm$ ( [ % of reading ] + [ number of least significant digits ] ). Accuracy specification assumes ambient temperature stable at  $\pm 1$  °C. For ambient temperature changes of  $\pm 5$  °C, rated accuracy applies after 2 hours. To obtain full accuracy in DC mV, Temperature, Ohms and Lo (50) Ohms, let the meter stabilize 20 minutes after using LoZ.

### True-rms:

AC mV, AC V, AC  $\mu$ A, AC mA, and AC A specifications are ac-coupled, true rms, and are specified from 2 % of range to 100 % of range, except 10 A range is specified from 10 % to 100 % of range.

### Crest Factor:

Accuracy is specified with AC crest factor  $\leq 3.0$  at full-scale, increasing linearly to 5.0 at half-scale, except the 1000 V range, where it is 1.5 at full scale, increasing linearly to 3.0 at half-scale and 500 mV and 5000  $\mu$ A, where it is  $\leq 3.0$  at 80 % of full scale, increasing linearly to 5.0 at half-scale. For non-sinusoidal waveforms add  $\pm(0.3$  % of range and 0.1 % of reading).

### AC Floor:

When the input leads are shorted together in the ac functions, the Meter may display a residual reading up to 200 counts. A 200 count residual reading will cause only a 20 count change for readings at 2 % of range. Using REL to offset this reading may produce a much larger constant error in later measurements.

### AC+DC:

AC+DC is defined as  $\sqrt{ac^2 + dc^2}$

### AC Voltage Specifications

Function	Range	Resolution	Accuracy				
			20 to 45 Hz	45 to 65 Hz	65 Hz to 10 kHz	10 to 20 kHz	20 to 100 kHz
AC mV <sup>[5]</sup>	50 mV <sup>[1]</sup>	0.001 mV	1.5 % + 60	0.3 % + 25	0.4 % + 25	0.7 % + 40	3.5 % + 40 <sup>[5]</sup>
	500 mV	0.01 mV	1.5 % + 60	0.3 % + 25	0.4 % + 25	0.7 % + 40	3.5 % + 40
AC V	5 V <sup>[1]</sup>	0.0001 V	1.5 % + 60	0.3 % + 25	0.6 % + 25	1.5 % + 40	3.5 % + 40 <sup>[5]</sup>
	50 V <sup>[1]</sup>	0.001 V	1.5 % + 60	0.3 % + 25	0.4 % + 25	0.7 % + 40	3.5 % + 40
	500 V <sup>[1]</sup>	0.01 V	1.5 % + 60	0.3 % + 25	0.4 % + 25	Not Spec'd	Not Spec'd
	1000 V	0.1 V	1.5 % + 60	0.3 % + 25	0.4 % + 25	Not Spec'd	Not Spec'd
dBV	-70 to -62 dB <sup>[3]</sup>	0.01 dB	3 dB	1.5 dB	2 dB	2 dB	3 dB
	-62 to -52 dB <sup>[3]</sup>	0.01 dB	1.5 dB	1.0 dB	1 dB	1 dB	2 dB
	-52 to -6 dB <sup>[3]</sup>	0.01 dB	0.2 dB	0.1 dB	0.1 dB	0.2 dB	0.8 dB
	-6 to +34 dB <sup>[3]</sup>	0.01 dB	0.2 dB	0.1 dB	0.1 dB	0.2 dB	0.8 dB
	34 to 60 dB <sup>[3]</sup>	0.01 dB	0.2 dB	0.1 dB	0.1 dB	Not Spec'd	Not Spec'd
Low pass filter <sup>[4]</sup>			2 % + 80	2 % + 40	2 % +10 -6 % -60 <sup>[2]</sup>	Not Spec'd	Not Spec'd
LoZ <sup>[4]</sup>	1000 V	0.1 V	2 % + 80	2 % + 40	2 % + 40 <sup>[6]</sup>	Not Spec'd	Not Spec'd

[1] Below 5 % of range, add 20 counts.  
 [2] Specification increases linearly from -2 % at 200 Hz to -6 % at 440 Hz. Range is limited to 440 Hz.  
 [3] dBm (600 Ω) is specified by adding +2.2 dB to the dBV range values.  
 [4] 289 only.  
 [5] Add 2.5 % above 65 kHz.  
 [6] Range is limited to 440 Hz.  
 See Detailed Specifications introduction for additional information.

### AC Current Specifications

Function	Range	Resolution	Accuracy			
			20 to 45 Hz	45 to 1 kHz	1 to 20 kHz	20 to 100 kHz <sup>[4]</sup>
AC μA <sup>[3]</sup>	500 μA	0.01 μA	1 % + 20	0.6 % + 20	0.6 % + 20	5 % + 40
	5000 μA	0.1 μA	1 % + 5	0.6 % + 5	0.6 % + 10	5 % + 40
AC mA <sup>[3]</sup>	50 mA	0.001 mA	1 % + 20	0.6 % + 20	0.6 % + 20	5 % + 40
	400 mA	0.01 mA	1 % + 5	0.6 % + 5	1.5 % + 10	5 % + 40
AC A <sup>[2]</sup>	5 A	0.0001 A	1.5 % + 20	0.8 % + 20	3 % + 40 <sup>[4]</sup>	Not Spec'd
	10 A <sup>[1]</sup>	0.001 A	1.5 % + 5	0.8 % + 5	3 % + 10 <sup>[4]</sup>	Not Spec'd

[1] 10 A range (10 % to 100 % of range).  
 [2] 20 A for 30 seconds on, 10 minutes off. >10 A not specified.  
 [3] 400 mA continuous; 550 mA for 2 minutes on, 1 minute off.  
 [4] Verified by design and type tests.  
 See Detailed Specifications introduction for additional information.

### DC Voltage Specification

Function	Range	Resolution	Accuracy				
			DC <sup>[2]</sup>	AC over DC, DC over AC, AC + DC <sup>[2]</sup>			
				20 to 45 Hz	45 Hz to 1 kHz	1 to 20 kHz	20 to 35 kHz
DC mV	50 mV <sup>[3]</sup>	0.001 mV	0.05 % + 20 <sup>[4]</sup>	2 % + 80	0.5 % + 80	1.5 % + 40	5 % + 40
	500 mV	0.01 mV	0.025 % + 2 <sup>[5]</sup>			1.5 % + 40	5 % + 40
DC V <sup>[1]</sup>	5 V	0.0001 V	0.025 % + 2			1.5 % + 40	5 % + 40
	50 V	0.001 V	0.025 % + 2			1.5 % + 40	5 % + 40
	500 V	0.01 V	0.03 % + 2			Not Spec'd	Not Spec'd
	1000 V	0.1 V	0.03 % + 2			Not Spec'd	Not Spec'd
LoZ <sup>[1]</sup>	1000 V	0.1 V	1 % + 20	Not Spec'd	Not Spec'd	Not Spec'd	Not Spec'd

[1] Add 20 counts in dual display ac over dc, dc over ac or ac+dc.  
 [2] AC+DC ranges are specified from 2 % to 140 % of range, except 1000 V is specified from 2 % to 100 % of range.  
 [3] When using the relative mode (REL  $\Delta$ ) to compensate for offsets.  
 [4] Add 4 counts/10 mV AC in dual display ac over dc, dc over ac or ac + dc  
 [5] Add 10 counts/100 mV AC in dual display ac over dc, dc over ac or ac + dc.

### DC Current Specifications

Function	Range	Resolution	Accuracy				
			DC <sup>[1][3]</sup>	AC over DC, DC over AC, AC + DC <sup>[1]</sup>			
				20 to 45 Hz	45 Hz to 1 kHz	1 to 20 kHz	20 to 100 kHz <sup>[5]</sup>
DC $\mu$ A <sup>[4]</sup>	500 $\mu$ A	0.01 $\mu$ A	0.075 % + 20	1 % + 20	0.6 % + 20	0.6 % + 20	5 % + 40
	5000 $\mu$ A	0.1 $\mu$ A	0.075 % + 2	1 % + 5	0.6 % + 5	0.6 % + 10	5 % + 40
DC mA <sup>[4]</sup>	50 mA	0.001 mA	0.05 % + 10 <sup>[6]</sup>	1 % + 20	0.6 % + 20	0.6 % + 20	5 % + 40
	400 mA	0.01 mA	0.15 % + 2	1 % + 5	0.6 % + 5	1.5 % + 10	5 % + 40
DC A <sup>[2]</sup>	5 A	0.0001 A	0.3 % + 10	1.5 % + 20	0.8 % + 20	3 % + 40 <sup>[5]</sup>	Not Spec'd
	10 A	0.001 A	0.3 % + 2	1.5 % + 10	0.8 % + 10	3 % + 10 <sup>[5]</sup>	Not Spec'd

[1] AC+DC ranges are specified from 2 % to 140 % of range.  
 [2] 20 A for 30 seconds on, 10 minutes off. >10 A not specified.  
 [3] Add 20 counts in dual display ac over dc, dc over ac or ac+dc.  
 [4] 400 mA continuous; 550 mA for 2 minutes on, 1 minute off.  
 [5] Verified by design and type tests.  
 [6] Temperature coefficient: 0.1 X (specified accuracy)/ °C (<18 °C or > 28 °C)

### Resistance Specifications

Function	Range	Resolution	Accuracy
Resistance	50 $\Omega$ <sup>[1][3]</sup>	0.001 $\Omega$	0.15 % + 20
	500 $\Omega$ <sup>[1]</sup>	0.01 $\Omega$	0.05 % + 10
	5 k $\Omega$ <sup>[1]</sup>	0.0001 k $\Omega$	0.05 % + 2
	50 k $\Omega$ <sup>[1]</sup>	0.001 k $\Omega$	0.05 % + 2
	500 k $\Omega$	0.01 k $\Omega$	0.05 % + 2
	5 M $\Omega$	0.0001 M $\Omega$	0.15 % + 4
	30 M $\Omega$	0.001 M $\Omega$	1.5 % + 4
	50 M $\Omega$	0.01 M $\Omega$	1.5 % + 4
	50 M $\Omega$ up to 100 M $\Omega$	0.1 M $\Omega$	3.0 % + 2
	100 M $\Omega$ up to 500 M $\Omega$	0.1 M $\Omega$	8 % + 2
Conductance	50 nS <sup>[2]</sup>	0.01 nS	1 % + 10

[1] When using the relative mode (REL  $\Delta$ ) to compensate for offsets.  
 [2] Add 20 counts above 33 nS in 50 nS range.  
 [3] 289 only.

### Temperature Specifications

Temperature	Resolution	Accuracy <sup>[1,2]</sup>
-200 °C to +1350 °C	0.1 °C	1 % + 10
-328 °F to +2462 °F	0.1 °F	1 % + 18

[1] Does not include error of the thermocouple probe.  
[2] Accuracy specification assumes ambient temperature stable to ±1 °C. For ambient temperature changes of ±5 °C, rated accuracy applies after 2 hours.

### Capacitance and Diode Test Specifications

Function	Range	Resolution	Accuracy
Capacitance	1 nF <sup>[1]</sup>	0.001 nF	1 % + 5
	10 nF <sup>[1]</sup>	0.01 nF	1 % + 5
	100 nF <sup>[1]</sup>	0.1 nF	1 % + 5
	1 µF	0.001 µF	1 % + 5
	10 µF	0.01 µF	1 % + 5
	100 µF	0.1 µF	1 % + 5
	1000 µF	1 µF	1 % + 5
	10 mF	0.01 mF	1 % + 5
100 mF	0.1 mF	2 % + 20	
Diode Test	3.1 V	0.0001 V	1 % + 20

[1] With a film capacitor or better, using relative mode (REL Δ) to zero residual.

### Frequency Counter Specifications

Function	Range	Resolution	Accuracy
Frequency (0.5 Hz to 999.99 kHz, pulse width >0.5 µs)	99.999 Hz	0.001 Hz	0.02 % + 5
	999.99 Hz	0.01 Hz	0.005 % + 5
	9.9999 kHz	0.0001 kHz	0.005 % + 5
	99.999 kHz	0.001 kHz	0.005 % + 5
	999.99 kHz	0.01 kHz	0.005 % + 5
Duty Cycle <sup>[1][2]</sup>	1.00 % to 99.00 %	0.01 %	0.2 % per kHz + 0.1 %
Pulse Width <sup>[1][2]</sup>	0.1000 ms	0.0001 ms	0.002 ms + 3 counts
	1.000 ms	0.001 ms	0.002 ms + 3 counts
	10.00 ms	0.01 ms	0.002 ms + 3 counts
	1999.9 ms	0.1 ms	0.002 ms + 3 counts

[1] For rise times <1 µs. Signals centered around trigger levels.  
[2] 0.5 to 200 kHz, pulse width >2 µs. Pulse width range is determined by the frequency of the signal.



### Frequency Counter Sensitivity

Input Range	Approximate Voltage Sensitivity (rms sine wave) <sup>[1]</sup>	AC Bandwidth <sup>[2]</sup>	Approximate DC Trigger Levels	DC Bandwidth <sup>[2]</sup>
	15 Hz to 100 kHz			
50 mV	5 mV	1 MHz	5 mV & 20 mV	600 kHz
500 mV	25 mV	1 MHz	20 mV & 60 mV	1 MHz
5 V	0.25 V	700 kHz	1.4 V & 2.0 V	80 kHz
50 V	2.5 V	1 MHz	0.5 V & 6.5 V	1 MHz
500 V	25 V	300 kHz	5 V & 40 V	300 kHz
1000 V	50 V	300 kHz	5 V & 100 V	300 kHz
Input Range	Approximate Current Sensitivity (rms sine wave)	AC Bandwidth	Approximate DC Trigger Levels	DC Bandwidth
	15 Hz to 10 kHz			
500 $\mu$ A	25 $\mu$ A	100 kHz	NA	NA
5000 $\mu$ A	250 $\mu$ A	100 kHz		
50 mA	2.5 mA	100 kHz		
400 mA	25 mA	100 kHz		
5 A	0.25 A	100 kHz		
10 A	1.0 A	100 kHz		

[1] Maximum input = 10 x range (1000 V maximum,  $2 \times 10^7$  V-Hz product maximum). Noise at low frequencies and amplitudes may affect accuracy.  
 [2] Typical frequency bandwidth with full scale (or maximum  $2 \times 10^7$  V-Hz product) rms sine wave.

### MIN MAX, Recording, and Peak Specifications

Function	Nominal Response	Accuracy
MIN MAX, Recording	200 ms to 80% (dc function)	Specified accuracy $\pm 12$ counts for changes $> 425$ ms in duration in manual range.
	350 ms to 80% (ac function)	Specified Accuracy $\pm 40$ counts for changes $> 1.5$ s in duration in manual range.
Peak	250 $\mu$ S (peak) <sup>[1]</sup>	Specified accuracy $\pm 100$ counts <sup>[2]</sup> up to 5,000 count (full range) reading. For higher peak reading (to 12,000 counts), specified accuracy $\pm 2\%$ <sup>[3]</sup> of reading.
Crest Factor	350 ms to 80%	For periodic waveforms from 50 to 440 Hz $\pm (4\% + 1 \text{ count})$ .

[1] For repetitive peaks; 2.5 ms for single events. Peak not specified for 500  $\mu$ A DC, 50 mA DC, 5 A DC.  
 [2] 200 counts in 500 mV AC, 500  $\mu$ A AC, 50 mA AC, 5 A AC.  
 [3] 3% in 500 mV AC, 500  $\mu$ A AC, 50 mA AC, 5 A AC.

### Input Characteristics

Function	Overload Protection <sup>[1]</sup>	Input Impedance	Common Mode Rejection Ratio (1 k $\Omega$ unbalance)	Normal Mode Rejection							
$\overline{\text{V}}$	1000 V	10 M $\Omega$ < 100 pF	$> 120$ dB at dc, 50 Hz or 60 Hz	$> 60$ dB at 50 Hz or 60 Hz							
$\overline{\text{mV}}$	1000 V <sup>[2]</sup>	10 M $\Omega$ < 100 pF	$> 120$ dB at dc, 50 Hz or 60 Hz	$> 60$ dB at 50 Hz or 60 Hz							
$\tilde{\text{V}}$	1000 V	10 M $\Omega$ < 100 pF (ac-coupled)	$> 60$ dB, dc to 60 Hz								
$\text{LoZ}$ $\tilde{\text{V}}$	1000 V	3.2 k $\Omega$ < 100 pF (ac-coupled)	Not specified	Not specified							
Function	Overload Protection <sup>[1]</sup>	Open Circuit Test Voltage	Full Scale Voltage		Typical Short Circuit Current						
			To 500 k $\Omega$	$\geq 5$ M $\Omega$ or 50 nS	500 $\Omega$	5 k $\Omega$	50 k $\Omega$	500 k $\Omega$	5 M $\Omega$	50 M $\Omega$	500 M $\Omega$
$\Omega$	1000 V <sup>[2]</sup>	5 V dc	550 mV	$< 5$ V	1 mA	100 $\mu$ A	10 $\mu$ A	1 $\mu$ A	0.3 $\mu$ A	0.3 $\mu$ A	0.3 $\mu$ A
50 $\Omega$	1000 V <sup>[2]</sup>	20 V decreasing to 2.5 V	500 mV		10 mA						
$\rightarrow$	1000 V <sup>[2]</sup>	5 V dc	3.1 V dc		1 mA						

[1] Input is limited to the product of a V rms sinewave times frequency of  $2 \times 10^7$  V-Hz.  
 [2] For circuits  $< 0.5$  A short circuit. 660V for high energy circuits.

**Burden Voltage (A, mA,  $\mu$ A)**

Function	Range	Burden Voltage
mA, $\mu$ A	500 $\mu$ A	102 $\mu$ V/ $\mu$ A
	5000 $\mu$ A	102 $\mu$ V/ $\mu$ A
	50.000 mA	1.8 mV/mA
	400.00 mA	1.8 mV/mA
A	5.0000 A	0.04 V/A
	10.000 A	0.04 V/A

**Required Equipment**

Required equipment is listed in Table 2. If the recommended models are not available, equipment with equivalent specifications may be used.

Repairs or servicing should be performed only by qualified personnel.

**Table 2. Required Equipment**

Equipment	Required Characteristics	Recommended Model
Calibrator	AC Voltage Range: 0-1000 Vac Accuracy: +/- 0.0875 % Frequency Range: 20 Hz – 100 kHz Accuracy: +/-3 %  DC Voltage Range: 0-1000 Vdc Accuracy: +/- 0.0075 %  Current Range: 0-10A Accuracy: AC mA - +/-0.15 % AC A - +/- 0.21 % Frequency range: 1 kHz – 30 kHz DC mA - + 0.0175 % DC A - +/- 0.08 %  Frequency Source: 45 Hz-950 kHz Accuracy: +/- 0.0026 % Amplitude: 600 mV Accuracy: +/- 5 %  Ohms Range: 0 $\Omega$ - 300 M $\Omega$ Accuracy: +/- 0.0135 %  Capacitance Range: 5 nF Accuracy: +/-0.55%  Temperature Range: 0 to 1000 $^{\circ}$ C Accuracy: 0.2%	Fluke 5520A
Thermocouple Adapter Accessory	K-type	Fluke 80AK
K-type Thermocouple wire	K-type, mini-plug on both ends	N/A
Serial Cable, Infrared	Cable, Adapter, Fluke-Custom IRDA Optical to USB,2M	Fluke P/N 2166275

## Basic Maintenance

### **⚠ ⚠ Warning**

To avoid electrical shock or personal injury, remove the test leads and any input signals before opening the case or replacing the battery or fuses. To prevent damage or injury, install **ONLY** batteries or fuses specified for this product.

### Opening the Meter Case

#### **⚠ Caution**

To avoid unintended circuit shorting, always place the uncovered Meter assembly on a protective surface. When the case of the Meter is open, circuit connections are exposed.

To open the Meter case, do the following:

1. Disconnect test leads from any live source, turn the Meter **off**, and remove the test leads from the input terminals.
2. Use a flat-blade screwdriver to turn the battery door fastener counterclockwise until the arrow points to unlock position.
3. Lift up on the bottom of the battery pack and slide down to remove as shown in Figure 2.
4. The case bottom is secured to the case top by six screws. Remove the screws with a Phillips-head screwdriver.
5. Pull the two halves of the case apart.

### Removing and Reinserting the Printed Circuit Assembly

The circuit board assembly (PCA) must be removed to access and replace the LCD. Refer to Figure 5 while performing the following procedure.

#### **⚠ Caution**

**The PCA is extremely susceptible to contamination. Handle it by the fuse clips or edges of the PCA only. Use clean surgical gloves to help avoid contamination.**

**The LCD cable is very delicate. Use extreme caution and do not exert excess force or strain on the cable or mating connector when removing.**

1. Put the Meter's rotary switch knob in the  $\overline{\text{mV}}$  position.
2. Refer to the "Opening the Meter Case" section and remove the case bottom to access the PCA.
3. Remove six Phillips-head screws securing the PCA to the case top and input terminals.
4. Remove the bottom shield.
5. Before lifting out the PCA, **very carefully** remove the fragile LCD cable from the LCD connector without excessive bending of the cable or connector. Remove the PCA.
6. Remove the top shield.
7. The LCD is now accessible and may be removed easily.

### Reassembling the Meter Case

To reassemble the Meter case, do the following:

1. Verify the rotary switch knob is in the  $\overline{\text{mV}}$  position (arrow on the rotary switch detent points straight up to the LCD).
2. Install the display bezel, LCD, and top shield into the top case.
3. On the PCA, align the RSOB housing so that the arrow is in the same orientation as the rotary switch knob (arrow points straight up to the LCD).
4. Place the PCA onto the top shield, making sure the RSOB alignment holes mate with the rotary switch detent alignment studs.
5. Very carefully insert the LCD cable stiffener vertically into the mating PCA connector.
6. Replace the bottom shield.

#### **⚠ Caution**

**To avoid damage to the Meter, do not over-torque the six Phillips-head screws when attaching the PCA and shields to the case top. Use 5 to 7 inch-lb of torque.**

7. Carefully replace the six Phillips-head screws that secure the PCA and shields to the case top and input terminals.
8. Hold the Meter face down and place the case bottom onto the case top. Make sure the LCD cable is not caught between the case halves.

#### **⚠ Caution**

**Do not over-torque the six Phillips-head case screws when attaching the case bottom. Use 5 to 7 inch-lb of torque.**

9. Reinstall the six case screws and the battery door.
10. Secure the battery door by turning the battery door fastener clockwise to the lock position.
11. Go to the “Performance Test” section in this document, and perform the procedures described.

### Testing Fuses (F1 and F2)

Before measuring current, using Figure 1 as a reference, test the fuses by following the instructions below.

#### **⚠⚠ Warning**

**To avoid electrical shock or personal injury, remove the test leads and any input signals before replacing the battery or fuses. To prevent damage or injury, install ONLY specified replacement fuses with the amperage, voltage, and speed ratings shown in the specifications.**

With the Meter in the  $\Omega$  function, insert a test lead into the V/ $\Omega$  jack and place the probe tip at the other end of the test lead against the metal at the top of the current input jack. If the message “Leads Connected Incorrectly” should appear, the tip of the probe is inserted too far into the jack and is activating the input alert. The resistance value should be between 0.00 and 0.50  $\Omega$  for the A jack and 10.00  $\pm$ 0.05 k $\Omega$  for the mA/ $\mu$ A jack. If the tests give readings other than those shown, have the Meter serviced.

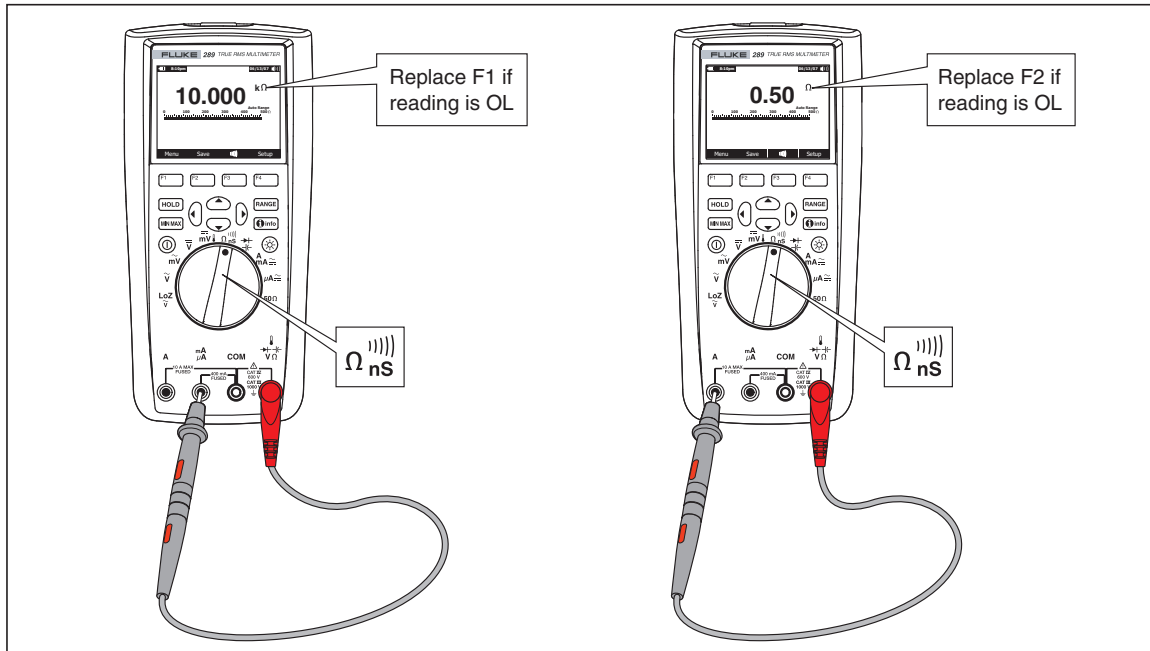

Figure 1. Testing the Current Fuses

est33.eps

## Replacing Fuses

### ⚠ ⚠ Warning

To avoid electrical shock, remove the test leads and any input signals before replacing the battery or fuses. To prevent damage or injury, install **ONLY** specified fuses and batteries.

To replace the fuses, refer to Figure 2 and do the following:

1. Turn the meter off and remove test leads from the input terminals
2. Remove the battery door by using a standard-blade screwdriver to turn the battery door fastener to the unlock position.
3. Remove either fuse by gently prying one end loose, then lifting the fuse out of the fuse contacts.
4. Install only Fluke specified replacement fuses with the amperage, voltage, and interrupt ratings shown in the replacement parts list (see Table 9).
5. Replace the battery door and secure it by turning the battery door fastener to the lock position.

## Replacing the Batteries

The Meter is powered by 6 AA batteries (NEDA 15A or IEC LR6).

### ⚠ Caution

**Be sure to observe proper polarity when replacing batteries. Incorrect battery polarity may seriously damage the Meter.**

To replace the batteries, refer to Figure 2 and do the following:

1. Turn the meter off and remove test leads from the input terminals.
2. Remove the battery door by using a standard-blade screwdriver to the turn the battery door fastener to the unlock position.

3. Replace the batteries, observing proper polarity. Replace the battery door and secure it by turning the fastener to the lock position.

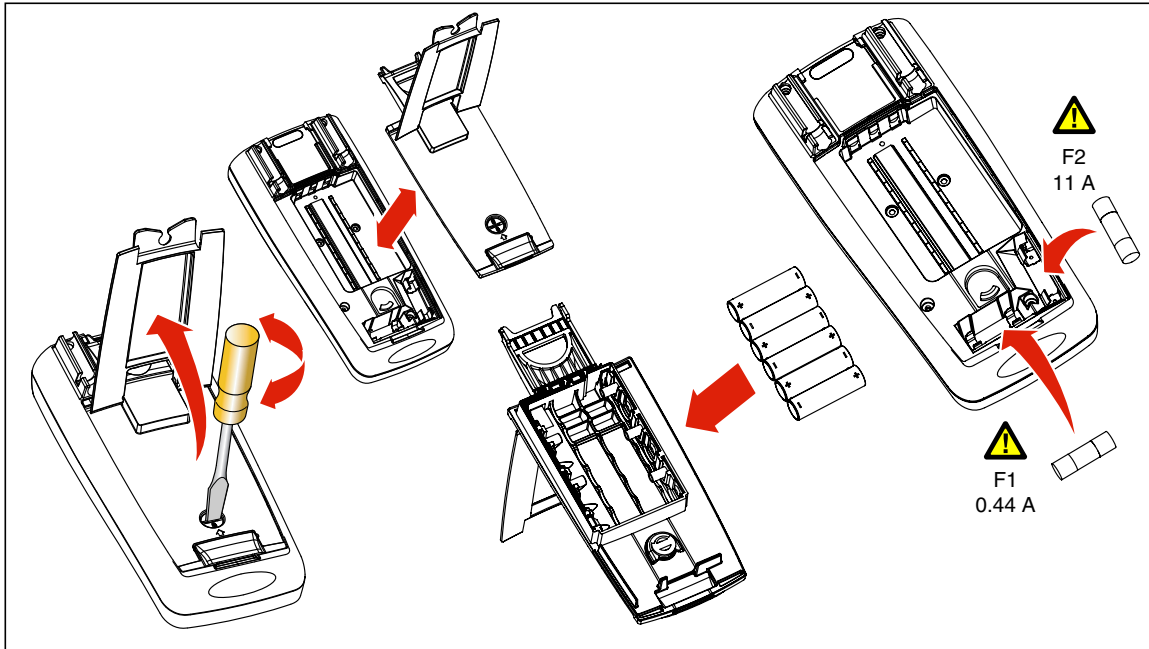

Figure 2. Battery and Fuse Replacement

### Cleaning

Periodically wipe the case with a damp cloth and mild detergent. Do not use abrasives, isopropyl alcohol, or solvents.

### **⚠ ⚠ Warning**

**To avoid electrical shock or damage to the Meter, never allow water inside the case. To avoid damaging the housing, never apply solvents to the Meter.**

Dirt or moisture in the input terminals can affect readings and can falsely activate the Input Alert feature. Clean the terminals as follows:

1. Turn the Meter off and remove all test leads.
2. Shake out any dirt that may be in the terminals.
3. Soak a clean swab with mild detergent and water. Work the swab around in each terminal. Dry each terminal using canned air to force the water and detergent out of the terminals.

### Performance Tests

The following performance tests will ensure that the Meter is in proper operating condition and will check the accuracy of each meter function against its specifications. To perform the tests you will need a Fluke 5520A Calibrator or equipment meeting the minimum specification given in Table 2. Prior to beginning the accuracy tests, allow for the Meter to stabilize to room temperature. Depending on temperature gradient this could take up to several hours.

If the Meter fails any of these tests, it needs calibration adjustment or repair.

### Factory Default

Prior to completing the Performance tests Reset the Meter to the factory defaults as follows:

1. Power the Meter on in any function.
2. Press F4 (Setup) and select Reset using arrow keys.
3. Press F3 (Meter).
4. Press F1 (OK). The Meter should go through power up routine.

### Power LED Test

The Meter's power button has an LED backlight. To test the LED, power on the meter, verify that the power button lights for approximately 4 seconds, and then extinguishes.

### Backlight Test

To test the backlight, press the  button twice. Note that the backlight comes on at two different intensity levels.

### Current Terminal Sensing Test

This test determines whether or not the Input Alert™ is functioning properly.

*Note*

*Before conducting this test, make sure the beeper is not disabled in setup.*

1. Turn the Meter on.
2. Install a test lead in the mA/μA input terminal.
3. Turn the rotary switch to all functions, except current functions. Note that the beeper chirps continuously and the LCD displays a warning.
4. Turn the rotary switch to the A/mA position. Note that the beeper does not chirp and the leads warning is not displayed.
5. Remove the test lead and install it into the A terminal. Repeat steps 3 and 4.

### Keypad Test

*Note*

*Before conducting this test, make sure the beeper is not disabled in setup mode.*

To test that the keypad buttons are active Turn the Meter on and push each button separately. Each button push should cause the Meter to beep.

### LCD Test

The Meter uses a dot matrix LCD. To best test the LCD pixels, use the following procedure.

1. Turn the rotary switch knob to  $\overline{\text{mV}}$  and turn the Meter on.
2. Push F4 for Setup and select contrast.
3. Push the Backlight button twice for max brightness and use the F1 and F2 softkeys to adjust Contrast for the brightest display.
4. Push the “i Info” button and scroll the text with F1 and F2. Inspect the LCD display for missing pixels or areas of the display that may be unreadable due to pixel defects.

## IR Port Verification

### Note

*If you are using MET/CAL to do performance testing over the Meter's IR port, it is not necessary to perform this verification test.*

1. Connect the Infrared Serial Cable to the USB port of a PC, with windows 98 or later, and the Meter's IR port at the top of the Meter.
2. Turn the Meter on, and set the rotary switch to any function.
3. On the PC, go to "Start", and under Programs, Accessories, open "HyperTerminal"
4. Setup the following:

Name: 289, 287 IR Port Test  
Connect using: ComX  
Bits per second: 115200  
Data bits: 8  
Parity: None  
Stop bits: 1  
Flow control: None

5. Go to the Properties ICON on the tool bar.
6. Click on the "Settings" tab and leave the default settings.
7. Select "ASCII Setup."
8. Set the following:

Send line ends with line feed  
Echo typed characters locally

Append line feeds to incoming line ends  
Wrap lines that exceed terminal width

9. Enter the identification command <ID> followed by carriage return (Enter)
10. The Meter should return the response: FLUKE 289, VX.XX, X, indicating the model, software version, and serial number.

### Note

*If the PC indicates that the Meter is not connected, ensure that the COM port is correct and that the IR Serial Cable is properly connected to the Meter's IR window.*

## Temperature Accuracy Test

### Note

*Prior to performing the following tests, the meter must be allowed to stabilize to within  $\pm 1$  °C of the ambient temperature. This could take several hours depending on temperature gradient.*

Connect K-type thermocouple and Fluke 80Ak to the temperature input on the Meter. Connect the other end to the 5520A TC output. Allow connections to stabilize for two minutes before proceeding.



1. Turn the Meter on and position the rotary switch to  $\overline{\text{mV}}$  and select the temperature function. Select the degrees C function key.
2. On the Meter, select Offset. Adjust the offset to 000.0 using keypad edit buttons.
3. Close the Offset window.
4. Set the 5520A for K-type thermocouple and an output of 0 °C.
5. Perform the measurement steps in Table 3.

**Table 3. Temperature Test Input and Display**

Input	Display	
	Lower Limit	Upper Limit
0.0 °C	-1.0 °C	1.0 °C
100.0 °C	98.0 °C	102.0 °C
1000.0 °C	989.0 °C	1011.0 °C

**Accuracy Tests for Volts, Current,  $\Omega$ ,  $\nabla$ , and  $\nabla$  Test Functions**

To verify the accuracy of Meter functions, do the following:

1. Connect the Calibrator Normal terminals to the Meter's V and COM input terminals.
2. Turn on the Meter.
3. Turn the rotary switch to  $\overline{\text{mV}}$ .

*Note*

*The DC mV measurements in Table 4 are subject to offsets caused by thermals due to temperature gradients between connecting materials. After connecting the calibrator to the Meter terminals, allow time (could be several minutes) for the thermals to dissipate. When readings are stable, perform a REL and record the Meter reading.*

4. Apply the Input Level and frequency for step 1 of Table 4.
5. Compare the Meter's display reading with the Display Limits in Table 4.
6. If the display reading falls outside of the Display Reading Limits shown in Table 4, the Meter does not meet specification and requires adjustment or repair.
7. Complete the remaining test steps for each function listed in Table 4.

**Table 4. 287/289 Performance Test Steps**

Step	Function	Range	Input Level	Frequency or Model	Display Reading <sup>[1]</sup>	
					Lower Limit	Upper Limit
1.	DC mV	50.000 mV	0 mV		Allow reading to stabilize	
REL Offsets						
2.	DC mV	50.000 mV	0 mV <sup>[2]</sup>		-0.020	0.020
3.	DC mV	50.000 mV	0.025 mV <sup>[2]</sup>		0.005	0.045
4.	DC mV	50.000 mV	-0.025 mV <sup>[2]</sup>		-0.045	-0.005

Table 4. 287/289 Performance Test Steps (cont.)

Step	Function	Range	Input Level	Frequency or Model	Display Reading <sup>[1]</sup>	
					Lower Limit	Upper Limit
5.	DC mV	50.000 mV	50 mV <sup>[2]</sup>		49.955	50.045
Discontinue REL Offsets						
6.	DC mV	500.00 mV	500 mV		499.85	500.15
7.	DC mV	500.00 mV	-250 mV		-250.08	-249.92
8.	mV DC/AC	500.00 mV	50 mV	0 Hz	49.97	50.03
9.	mV AC/DC	500.00 mV	250 mV	35 kHz	237.10	262.90
Set 5520A for 2-Wire COMP and Connect in 4-Wire configuration						
10.	Ohms	500.00 Ω	0 Ω		-0.10	0.10
REL Offset						
11.	Ohms	500.00 Ω	0.2 Ω <sup>[2]</sup>		0.10	0.30
12.	Ohms	500.00 Ω	500 Ω <sup>[2]</sup>		499.65	500.35
Discontinue REL Offsets						
13.	Ohms	5.0000 kΩ	5 kΩ		4.9973	5.0027
14.	Ohms	50.000 kΩ	50 kΩ		49.973	50.027
Set 5520A for COMP OFF and Remove Auxiliary Test Cable						
15.	Ohms	500.00 kΩ	500 kΩ		499.73	500.27
16.	Ohms	5.0000 MΩ	5 MΩ		4.9921	5.0079
17.	Ohms	30.000 MΩ	30 MΩ		29.546	30.454
18.	Ohms	500.0 MΩ	300 MΩ		275.8	324.2
19.	AC mV	50.000 mV	5 mV	20 Hz	4.865	5.135
20.	AC mV	50.000 mV	50 mV	65 kHz	48.210	51.790
21.	AC mV	500.00 mV	50 mV	100 kHz	47.85	52.15
22.	AC mV	500.00 mV	250 mV	65 Hz	240.85	259.15
23.	AC mV	500.00 mV	500 mV	45 Hz	498.25	501.75
24.	AC mV, Hz	500.00 mV	500 mV	45 Hz	44.986	45.014
25.	AC mV, Hz	500.00 mV	600 mV	950 kHz	949.90	950.10
26.	VAC	5.0000 V	0.1 V	60 Hz	0.0952	0.1048
27.	VAC	5.0000 V	0.5 V	10 kHz	0.4945	0.5055
28.	VAC	5.0000 V	3 V	100 kHz	2.8160	3.1840
29.	VAC, HZ, % (Duty Cycle)	5.0000 V	5 V p-p, Sq. wave @15 %	50 kHz	4.90	25.10
30.	VAC	50.000 V	15 V	100 kHz	14.435	15.565

**Table 4. 287/289 Performance Test Steps (cont.)**

Step	Function	Range	Input Level	Frequency or Model	Display Reading <sup>[1]</sup>	
					Lower Limit	Upper Limit
31.	VAC, Lo Pass (289)	500.00 V	50 V	60 Hz	48.60	51.40
32.	VAC, Lo Pass (289)	500.00 V	50 V	1600 Hz <sup>[3]</sup>	0.00	8.00
33.	VAC	500.00 V	500 V	10 kHz	497.75	502.25
34.	VAC	1000.0 V	1000 V	10 kHz	993.5	1006.5
35.	DC V	5.0000 V	4 V		3.9988	4.0012
36.	DC V	50.000 V	-40 V		-40.012	-39.988
37.	DC V	500.00 V	400 V		399.86	400.14
38.	DC V	1000.0 V	600 V		599.6	600.4
39.	DC V, DC/AC	5.0000 V	200 mV	0 Hz	0.1977	0.2023
40.	DC V, AC/DC	5.0000 V	2 V	5 kHz	1.9640	2.0360
41.	ACV, Peak	5.000 V	4 V p-p, Sq. wave, +1 V offset	2 kHz	1.863	2.137
Put Meter's rotary switch to Capacitance function and Range to 10 nF						
Remove Test Leads from 5520A and REL offset						
Reconnect Test Leads to 5520A						
42	Capacitance	10.00 nF <sup>[4]</sup>	5 nF		4.90	5.10
43	Diode Test	3.1000 V	3.5 k $\Omega$		2.0000	3.1000
44	Diode Test	3.1000 V	0 $\Omega$		N/A	N/A
Set 5520A for 2-Wire COMP and Connect in 4-Wire configuration						
45	Lo $\Omega$ (289)	50.000 $\Omega$ <sup>[1]</sup>	0 $\Omega$		Allow reading to stabilize (5-10 seconds)	
REL offset						
46	Lo $\Omega$ (289)	50.000 $\Omega$	0.2 $\Omega$ <sup>[2]</sup>		0.180	0.220
47	Lo $\Omega$ (289)	50.000 $\Omega$	50 $\Omega$ <sup>[2]</sup>		49.905	50.095
Set 5520A for COMP off						
Connect 5520A Auxiliary Output to Meter's mA/ $\mu$ A and COM Input Terminals						
48	$\mu$ A AC	500.00 $\mu$ A	500 $\mu$ A	60 Hz	496.80	503.20
49	$\mu$ A AC	500.00 $\mu$ A	500 $\mu$ A	30 kHz	492.85 <sup>[5]</sup>	507.15 <sup>[5]</sup>
50	$\mu$ A AC	5000.0 $\mu$ A	5000 $\mu$ A	30 kHz	4928.5 <sup>[5]</sup>	5071.5 <sup>[5]</sup>
51	$\mu$ A DC	500.00 $\mu$ A	500 $\mu$ A		499.42	500.58

Table 4. 287/289 Performance Test Steps (cont.)

Step	Function	Range	Input Level	Frequency or Model	Display Reading <sup>[1]</sup>	
					Lower Limit	Upper Limit
52	μA DC	5000.0 μA	5000 μA		4996.0	5004.0
53	mA AC	50.000 mA	4 mA	20 Hz	3.940	4.060
54	mA AC	50.000 mA	30 mA	30 kHz	29.375 <sup>[5]</sup>	30.625 <sup>[5]</sup>
55	mA AC	400.00 mA	300 mA	30 kHz	284.60	315.40
56	mA AC	400.00 mA	400 mA	60 Hz	397.55	402.45
57	mA DC	50.000 mA	0.1 mA		0.090	0.110
58	mA DC	50.000 mA	50 mA		49.965	50.035
59	mA DC	400.00 mA	400 mA		399.38	400.62
Connect 5520A, Auxiliary 20A output, to Meter's A and COM Input Terminals						
60	AAC	5.0000 A	5 A	1 kHz	4.9580	5.0420
61	AAC	10.000 A	5 A	1 kHz	4.955	5.045
62	ADC	5.0000 A	5 A		4.9840	5.0160
63	ADC	10.000 A	10 A		9.968	10.032
Connect 5520A Normal Output to Meter's V Input Terminal						
64	LoZ (289) <sup>[6]</sup>	1000 V	120 V <sup>[7]</sup>	60 Hz	113.6	126.4
<p>[1] Must allow for source and Meter settling before recording reading.</p> <p>[2] When using the relative mode (RELΔ) to compensate for offsets.</p> <p>[3] The Meter accuracy is not specified at this frequency with Low-pass filter on. The display reading limits shown in table 4, checks that the Low-pass filter is active and follows an expected roll-off curve.</p> <p>[4] With a film capacitor or better, using relative mode (REL Δ) to zero residual.</p> <p>[5] Test limits are mathematically guard banded to ensure performance, at 20 kHz and lower.</p> <p>[6] To obtain full accuracy in DC mV, Temperature, ohms, and LoZ, let the Meter stabilize for 20 minutes after using LoZ.</p> <p>[7] To avoid calibrator overload/current limit condition, step the calibrator output to 60 V and then 120 V.</p>						

## Calibration Adjustment

The Meter features closed-case calibration adjustment using known reference sources. The Meter measures the applied reference source, calculates correction factors and stores the correction factors in nonvolatile memory.

The following sections present the features and Meter pushbutton functions that can be used during the Calibration Adjustment Procedure.

Before you begin the adjustment procedure, the Meter must be allowed to reach the ambient temperature of the lab environment. Depending on temperature gradient, this could take up to several hours.

Perform the Calibration Adjustment Procedure should the Meter fail any performance test steps listed in Table 4.

## Operation

Calibration adjustment is started by pressing the F1 [Setup] softkey, and then navigating to “Calibration” on the Setup menu.

### *Note*

*Calibration will **not** be allowed with a low battery condition.*

When “Calibration” is selected in the Setup menu, the F1-F4 softkeys function as shown in Table 5.

**Table 5. Calibration Entry Softkeys**

Key	Function	Description
F1	Calibrate	Starts calibration after successful password entry.
F2	Password	Change the calibration password after successful password entry.
F4	Close	Return to Setup Screen.

## Entering the Password

A four digit numeric password is required to access the Meter calibration adjustment procedure. The default password is “1234”.

When “Calibrate” [F1 key] is selected from the Calibration “Setup” menu, a dialog box titled "Enter Password" is displayed.

The Meter’s arrow keys are used to edit each or the 4 digits to arrive at the correct password.

To enter the password the F1 [OK] key is pressed:

To abort the password attempt the F4 [Cancel] key is pressed.

If an incorrect password is entered then “Incorrect password entered” message is displayed. Press OK to return to the “Enter Password” screen.

## Changing the Password

When F2 key “Password” is selected from the Calibration “Setup” menu, a dialog box titled "Enter Password", is displayed.

Enter the current password using the same method described in the “Entering the Password” section above.

After the current password is entered, a dialog box titled "Enter New Password" is displayed. Entering the new password is done using the same dialog described in the “Entering the Password” section above.

When the new password is accepted then the message “Password changed” is displayed.

The F1 key [OK] is used to return to the measurement mode.

## Restoring Factory Default Password

Restoring the factory default password [1234] can be done as follows:

1. Remove the Meter’s bottom case as described under “Disassembly”.
2. Locate the PCA Battery Terminals as shown in Figure 3. Observing correct polarity, use an external lab supply or battery to apply 9 volts to the PCA battery terminals. TP8 and TP10 can also be used to apply power to the PCA.
3. Power the Meter on using the front panel power button.

4. Locate the PCA CAL key pad as shown in Figure 3.
5. Short the CAL key pad terminals to reset the password. When the password is reset, the Meter beeps to indicate that the action is complete.

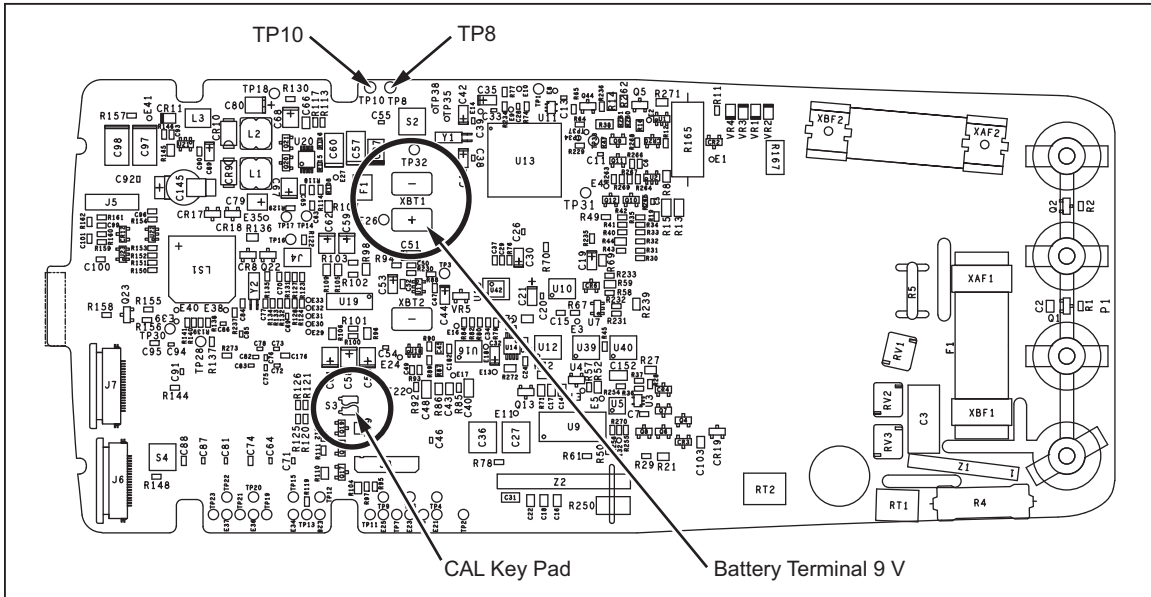

Figure 3. PCA Component Location

est90.eps

### Adjustment Procedure Operation

The Meter will prompt the user through steps in the Calibration Adjustment Procedure with screens showing the live reading, source value for the step, and the calibration step number. Figure 4 shows a screen shot of the first step of the calibration adjustment procedure.

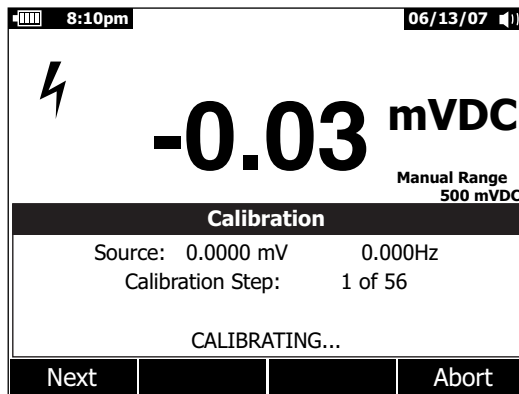

Figure 4. Calibration Adjustment Screenshot

est91.eps

### Screenshot Description

The following describes the Meter dialog shown in Figure 4 Screenshot.

1. Live Reading measurement shown in the Primary display is using default calibration constants. The measurement is likely to be slightly different from the applied signal, because it is an uncalibrated measurement.
2. **Bolt** icon is shown at all times during the calibration procedure.
3. **Source-** value for Calibrator shown in the Secondary measurement portion of the

screen.

4. **Calibration Step** progress indicator.
5. **Calibration status message.** Usually blank, but displays one of the following messages when the given condition occurs:
  - “**Calibrating**”... is shown while measurements are being made after Next is pressed. All softkeys except for ABORT are disabled during this time.
  - An error message is shown if the rotary switch is in an incorrect position for the present step.
  - An error message is shown if the source jacks are in an incorrect position for the present step.

### Softkeys

Table 6 describes the Meter’s softkey functions during the calibration adjustment routine.





**Table 6. Softkey Functions during Calibration**

Key	Function	Description
F1	Next	Used to go to next calibration step if present reading is validated. Otherwise shows error message if invalid measurement. Disabled during calibration computation or with an error message
F4	Abort	Return to Measurement Screen without changing stored calibration constants. This softkey is always available during the calibration procedure.

### Navigation Buttons

The UP and DOWN Arrow buttons can be used to adjust display contrast while in the calibration mode. The RIGHT and LEFT Arrow buttons are disabled.

### Mode Buttons

The mode buttons ( , , , and  ) are disabled during calibration adjustment.

### Description of Calibration Adjustment Steps

The general calibration procedure is as follows:

1. Move the rotary switch to the function that you are calibrating as indicated by the calibration procedure.
2. Apply the source value indicated by the secondary display.
3. Wait for the measurement on the primary display to settle to its final value. There is no internal control or wait time. It is up to the user to determine that the measurement is settled.
4. Press the NEXT softkey to calculate calibration constants for the current step. During calculation of calibration constants the secondary display will show Calibrating.... Some calibration measurements take longer to execute than others (up to 115 seconds). If the measurement is within calibration tolerance the Meter records the new constant(s) and proceeds to the next calibration step, giving a single beep to prompt the user to proceed.

*Note*

*The frequency value for AC functions will not be validated.*

*If the measurement is not within calibration tolerance then after pressing NEXT an error message will be shown and the calibration step will not proceed. The operator can adjust input signal if needed and attempt NEXT again.*

*If the meter continues to give an error message after the source is validated then the calibration procedure may not proceed and the meter will need service. User should select the Abort softkey to exit the calibration procedure. Any calculated calibration constants will be discarded.*

5. If there are more functions to be calibrated, move the rotary switch to the appropriate function, and continue from step one.
6. Repeat steps 1 through 5 until the secondary display shows the **Cal Complete** message. This indicates that the calibration procedure is complete and the new calibration constants will be saved. The new constants will be used after selecting F1 softkey [OK] and the Meter restarts.

A counter records the number of completed calibrations that have been performed. The counter is updated at the end of the calibration procedure. To review the calibration adjustment counter go to the Setup “Meter Info” screen.

### Power Cycle

If the Meter power is turned off during calibration the procedure will be aborted, and any calibration constants calculated during the procedure will be discarded. Previously stored calibration constants will be used after power-on.

### Calibration Adjustment Steps

Table 7 shows the calibration adjustment steps and the corresponding Meter settling/calibrating time for a Meter with version 1.00 firmware while Table 8 is for firmware version 1.10.

#### Note

*Before starting the adjustment procedure, set the present time and date, so, the stored calibration date is accurate. The calibration date can be found in the Setup menu under “Meter Info”.*

*The Meter must be allowed to reach the ambient temperature of the lab environment before you begin the adjustment procedure. Depending on temperature gradient, this could take up to several hours.*

**Table 7. Calibration Adjustment Steps for Firmware Version 1.00**

Step	Rotary Switch Position	Source Value	Settling Time (seconds)	Calibrating Time <sup>[1]</sup> (seconds)
1	mV DC	0.0 V, 0 Hz	2	10
2	mV DC	500.0 mV, 0 Hz	2	15
3	mV DC	50.0 mV, 0 Hz	2	2
4	mV DC	0.0 V, 0 Hz	7	15
5	mV AC	5.0 mV, 60 Hz	4	4
6	mV AC	50.0 mV, 60 Hz	4	2
7	mV AC	500.0 mV, 60 Hz	4	5
8	mV AC	50.0 mV, 60 Hz	10	5



**Table 7. Calibration Adjustment Steps for Firmware Version 1.00 (cont.)**

Step	Rotary Switch Position	Source Value	Settling Time (seconds)	Calibrating Time <sup>[1]</sup> (seconds)
9	mV AC	0.0 V, 0 Hz	10	5
10	VAC	0.0 V, 0 Hz	4	10
11	VAC	5.0000 V, 60 Hz	10	5
12	VAC	5.0000 V, 65 kHz <sup>[2]</sup>	5	35
13	VAC	50.000 V, 60 Hz	6	10
14	VAC	50.000 V, 100 kHz	6	120
15	VAC	250.00 V, 60 Hz	8	2
16	VAC	500.00 V, 60 Hz	6	5
17	VAC	1000.0 V, 60 Hz	7	4
18	VDC	0.0 V, 0 Hz	3	30
19	VDC	5.0000 V, 0 Hz	3	5
20	VDC	5.0 V, 60.0 Hz	4	5
21	VDC	5.0 V, 20.0 kHz	3	35
22	VDC	50.000 V, 0 Hz	3	8
23	VDC	50.0 V, 60.0 Hz	5	15
24	VDC	50.0 V, 20.0 kHz	7	115
25	VDC	500.00 V, 0 Hz	3	7
26	VDC	500.0 V, 60.0 Hz	4	5
27	VDC	1000.0 V, 0 Hz	2	5
28	VDC	1000.0 V, 60.0 Hz	4	5
29	mV DC	50.0 mV, 60.0 Hz	4	3
30	mV DC	500.0 mV, 60.0 Hz	5	3
Connect the 5520A in a 4-Wire configuration and select COMP 2-Wire				
31	Ω	0 Ω, zcomp wire2	4	20
32	Ω	500 Ω, zcomp wire2	5	2
33	Ω	5 kΩ, zcomp wire2	5	2
34	Ω	50 kΩ, zcomp wire2	5	2
Disconnect 5520A 4-Wire configuration and turn COMP off				
35	Ω	500 kΩ	5	5
36	Ω	5.0 MΩ	5	5
37	Ω	50.0 MΩ	5	5
38	Ω	500.0 MΩ	5	2

Table 7. Calibration Adjustment Steps for Firmware Version 1.00 (cont.)

Step	Rotary Switch Position	Source Value	Settling Time (seconds)	Calibrating Time <sup>[1]</sup> (seconds)
Connect the 5520A in a 4-Wire configuration and select COMP 2-Wire				
39	Diode Test	0 Ω, zcomp wire2	2	2
40	Diode Test	3.1 V, 0 Hz	2	2
41	μA DC	500.0 μA, 0 Hz	3	4
42	μA DC	5000.0 μA, 0 Hz	3	4
43	μA AC	500.0 μA, 60 Hz	10	4
44	μA AC	5000.0 μA, 60 Hz	10	3
45	mA DC	50.0 mA, 0 Hz	5	4
46	mA AC	400.0 mA, 0 Hz	3	4
47	mA AC	50.0 mA, 60 Hz	10	3
48	mA AC	400.0 mA, 60 Hz	10	4
49	ADC	5.0 A, 0 Hz	8	4
50	ADC	10.0 A, 0 Hz	3	2
51	AAC	5.0 A, 60 Hz	10	4
52	AAC	10.0 A, 60 Hz	9	4
Connect the 5520A in a 4-Wire configuration and select COMP 2-Wire				
To reduce settling time, apply 10 ohms to Meter before setting Rotary Switch to LoΩ				
53	LoΩ (289)	10.000 Ω	30	2
54	LoΩ (289)	50.000 Ω	15	3
Disconnect 5520A 4-Wire configuration and turn COMP off				
55	LoZ (289)	10.0 V, 0 Hz	2	2
56	mV AC (289)	500.00 mV, 60 Hz	5	5
<p>[1] Meter is "Calibrating" after "Next" is pressed.                  [2] For software version 1.00, the instrument display indicates 60 kHz. Use 65 kHz.</p>				

Table 8. Calibration Adjustment Steps for Firmware Version 1.10

Step	Rotary Switch Position	Source Value	Settling Time (seconds)	Calibrating Time <sup>[1]</sup> (seconds)
1	mV DC	0.0 V, 0 Hz	2	7
2	mV DC	500.0 mV, 0 Hz	3	6
3	mV DC	0 mV, 0 Hz	2	8
4	mV DC	50.0 V, 0 Hz	2	1
5	mV DC	100.0 mV, 0 Hz	2	1

**Table 8. Calibration Adjustments Steps for Firmware Version 1.10 (cont.)**

Step	Rotary Switch Position	Source Value	Settling Time (seconds)	Calibrating Time <sup>[1]</sup> (seconds)
6	mV DC	500.0 mV, 0 Hz	2	1
7	mV AC	5.0 mV, 700 Hz	4	2
8	mV AC	50.0 mV, 700 Hz	3	3
9	mV AC	500.0 mV, 700 Hz	3	2
10	mV AC	500.0 mV, 55 Hz	2	3
11	mV AC	50.0 mV, 55 Hz	10	6
12	mVAC	0.0 V, 0 Hz	2	6
13	VAC	0.0 V, 0 Hz	2	15
14	VAC	5.0 V, 55 Hz	3	7
15	VAC	5.0000 V, 60 kHz	3	42
16	VAC	50.0 V, 55 Hz	2	10
17	VAC	50.000 V, 100 kHz	4	94
18	VAC	500.0 V, 55 Hz	5	2
19	VAC	1000.0 V, 55 Hz	3	2
20	VDC	0.0 V, 0 Hz	2	8
21	VDC	5.0 V, 0 Hz	2	1
22	VDC	50.0 V, 0 Hz	2	1
23	VDC	500.0 V, 0 Hz	2	1
24	VDC	1000.0 V, 0 Hz	3	1
25	VDC	5.0 V, 55 Hz	3	12
26	VDC	5.0 V, 20.0 kHz	3	13
27	VDC	50.0 V, 55 Hz	5	16
28	VDC	50.0 V, 20.0 kHz	5	32
29	VDC	1000.0 V, 55 Hz	5	7
30	mV DC	500.0 mV, 55 Hz	5	8
Connect the 5520A in a 4-Wire configuration and select COMP 2-Wire				
31	$\Omega$	0 $\Omega$ , zcomp wire2	2	15
32	$\Omega$	500 $\Omega$ , zcomp wire2	3	1
33	$\Omega$	5 k $\Omega$ , zcomp wire2	3	1
34	$\Omega$	50 k $\Omega$ , zcomp wire2	2	1
Disconnect 5520A 4-Wire configuration and turn COMP off				
35	$\Omega$	500 k $\Omega$	2	13

Table . Calibration Adjustments Steps for Firmware Version 1.10 (cont.)

Step	Rotary Switch Position	Source Value	Settling Time (seconds)	Calibrating Time <sup>[1]</sup> (seconds)
36	$\Omega$	5.0 M $\Omega$	2	9
37	$\Omega$	50.0 M $\Omega$	2	9
38	$\Omega$	500.0 M $\Omega$	2	2
Connect the 5520A in a 4-Wire configuration and select COMP 2-Wire				
39	Diode Test	0.0 $\Omega$ , zcomp wire2	2	1
40	Diode Test	3.1 V, 0 Hz	2	1
41	$\mu$ A DC	5000 $\mu$ A, 0 Hz	2	1
42	$\mu$ A AC	5000 $\mu$ A, 55 Hz	2	1
43	mA DC	400.0 mA, 0 Hz	2	1
44	mA AC	400.0 mA, 55 Hz	2	1
45	ADC	10.0 A, 0 Hz	2	1
46	AAC	10.0 A, 55 Hz	2	2
Connect the 5520A in a 4-Wire configuration and select COMP 2-Wire				
To reduce settling time, apply 10 ohms to Meter before setting Rotary Switch to Lo $\Omega$				
47	Lo $\Omega$ (289)	10.000 $\Omega$	2	2
48	Lo $\Omega$ (289)	50.000 $\Omega$	2	2
Disconnect 5520A 4-Wire configuration and turn COMP off				
49	LoZ (289)	10.0 V, 0 Hz	2	1
50	mV AC (289)	500.00 mV, 55 Hz	2	5
[1] Meter is "Calibrating" after "Next" is pressed.				

**Parts**

Table 9 lists that available replacement parts shown in Figure 5.

**Table 9. Replacement Parts**

Ref Des.	Description	Fluke Part No.
MP1	FLUKE-28X-4001,PCA MAIN	Not available
MP2	FLUKE-287-2004-01,SKIN, PADXFER	2798418 (289) 2798429 (287)
MP3	FLUKE-28X-2001,CASE TOP	2578178
MP4	FLUKE-28X-2002,CASE BOTTOM	2578184
MP5	FLUKE-28X-2501,MASK, LCD, PADXFER	2760673 (289) 2798407 (287)
MP6	FLUKE-28X-2006,SHIELD, UPPER	2578252
MP7	FLUKE-28X-2008-01,KNOB, PADXFER	2798434
MP8	FLUKE-28X-2009,HOUSING, RSOB, UPPER	2578283
MP9	FLUKE-28X-2010,HOUSING, RSOB, LOWER	2578290
MP12	FLUKE-28X-2015,SPRING DETENT	2723772
MP16	FLUKE-28X-8002,KEYPAD	2578234
F1	FUSE, .440A,1000V,FAST,.406X1.375,BULK	943121
F2	FUSE,11A,1000V,FAST.406INX1.5IN,BULK	803293
XBT1	FLUKE-28X-8006,BATTERY CONTACT, POSITIVE, BOTTOM CASE	2578353
XBT2-3	FLUKE-28X-8007,BATTERY CONTACT,NEGATIVE,BOTTOM CASE	2578375
DS1	LCD MODULE,289,320X240,FSTN,3.5 MONO GRAPHIC,TRANSFLCTV,WHITE LED,0.22MM PITCH	2734828
H15-18	SCREW,M3X0.5,6MM,PAN,PHILLIPS,STEEL,ZINC-CHROMATE	2743764
H7-14	SCREW,4-14,.510,PAN,PHILLIPS,STEEL,ZINC-CHROMATE,TYPE BT THREAD CUT	853668
H1-6	BATTERY,PRIMARY,MNO2-ZN,1.5V,2.24AH,15A,LR6,ALKALINE,AA,14X50MM,BULK	376756
MP30	O-RING,NITRILE,SHORE A 90,AS 568A-905,.414 ID,.072 W	2740185
MP42-44	FLUKE-28X-8013,SHOCK ABSORBER, LCD	2793516
MP49	FLUKE-28X-2007,SHIELD, LOWER	2578265
MP45	FLUKE-28X-8014,SHOCK ABSORBER, BATTERY COMPARTMENT	2793525
MP46	FLUKE-28X-2019,BATTERY DOOR ASSEMBLY	2824477

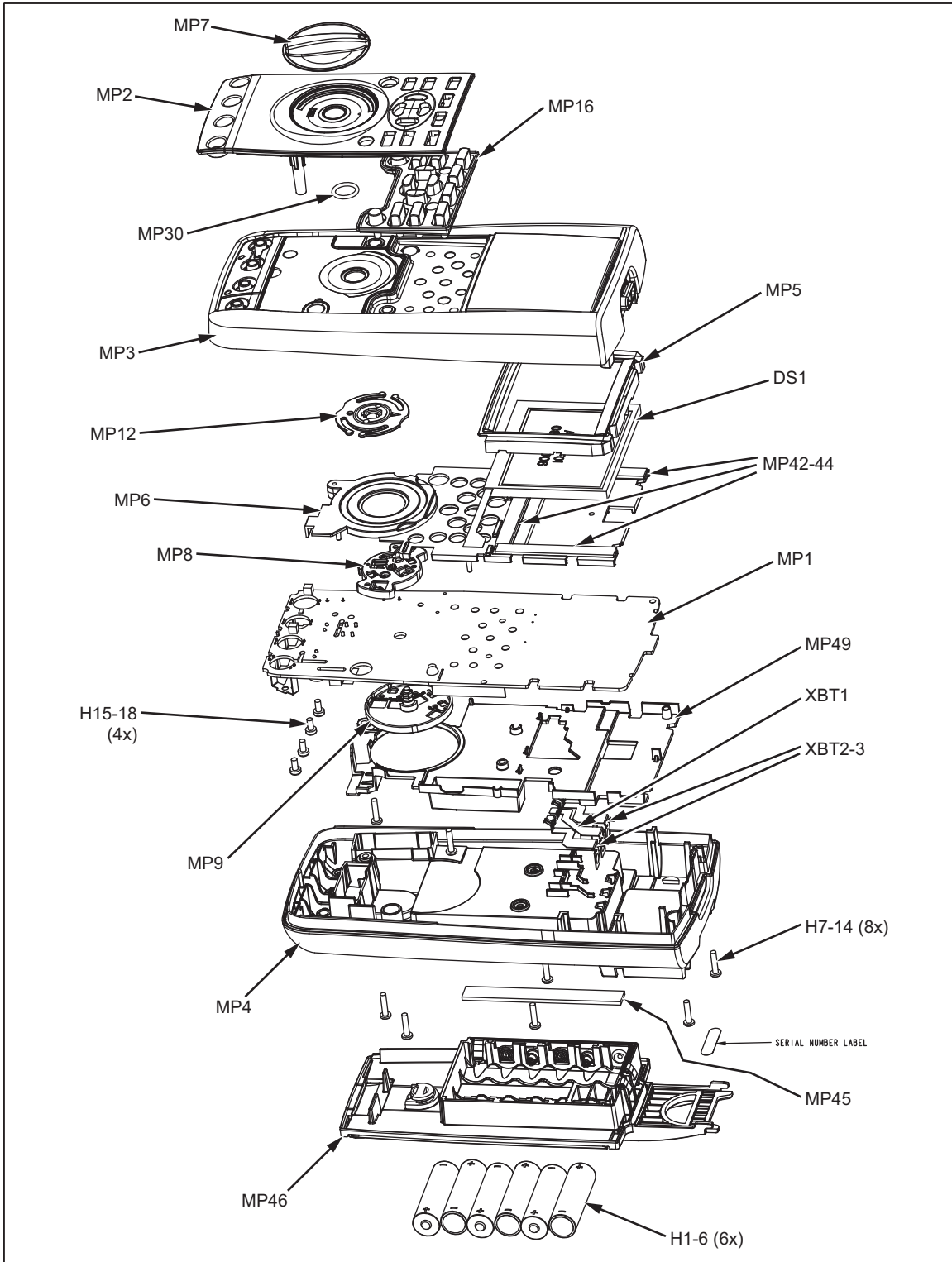

Figure 5. Replacement Parts

est34.eps