

114, 115, 116, and 117

Digital Multimeters

Calibration Information

Introduction

⚠ ⚠ Warning

To avoid electric shock or injury, do not perform the performance tests or calibration adjustment procedures unless qualified to do so.

The information provided in this document is for the use of qualified personnel only.

The *114, 115, 116, & 117 Calibration Information* provides the information necessary to adjust and verify the performance of the Fluke Models 114, 115, 115C, 116, 116C, 117, and 117C True RMS Multimeters (hereafter known as the Meter). When specific models are noted in this manual, the “C” version is also included. For example, when the listed model is 115, the instructions are applicable to the 115C as well.

The following information is included in this document:

- Safety Information and International Electrical Symbols (page 2)
- Specifications (page 3)
- Testing the Fuse (page 5)
- Replacing the Fuse and the Battery (page 6)
- Cleaning (page 7)
- Performance Tests (page 7)
- Calibration Adjustment (page 12)
- Replacement Parts and Accessories (page 17)
- Complete Warranty (page 19)

See the *114, 115, 117 Users Manual* or the *115C, 117C Users Manual* or the *116 Users Manuals* or the *116C Users Manual* for complete operating instructions.

Contact Information

To contact Fluke, call one of the following telephone numbers:

USA: 1-888-99-FLUKE (1-888-993-5853)

Canada: 1-800-36-FLUKE (1-800-363-5853)

Europe: +31 402-675-200

Japan: +81-3-3434-0181

Singapore: +65-738-5655

Anywhere in the world: +1-425-446-5500

Or, visit Fluke's Web site at www.fluke.com.

To register your product, visit register.fluke.com

Safety Information

"Warning" and "Caution" Statements

A “ Warning” identifies hazardous conditions and actions that could cause bodily harm or death.

A “ Caution” identifies conditions and actions that could damage the Meter, the equipment under test, or cause permanent loss of data.

Warnings and Precautions







To avoid possible electric shock or personal injury, follow these guidelines:

- **Use the Meter only as specified in this manual or the protection provided by the Meter might be impaired.**
- **Do not use the Meter or test leads if they appear damaged, or if the Meter is not operating properly.**
- **Always use proper terminals, switch position, and range for measurements.**
- **Verify the Meter's operation by measuring a known voltage. If in doubt, have the Meter serviced.**
- **Do not apply more than the rated voltage, as marked on Meter, between terminals or between any terminal and earth ground.**
- **Use caution with voltages above 30 V ac rms, 42 V ac peak, or 60 V dc. These voltages pose a shock hazard.**
- **Disconnect circuit power and discharge all high-voltage capacitors before testing resistance, continuity, diodes, or capacitance.**
- **Do not use the Meter around explosive gas or vapor.**
- **When using test leads or probes, keep your fingers behind the finger guards.**
- **Remove test leads from Meter before opening the battery door or Meter case.**
- **Comply with local and national safety requirements when working in hazardous locations.**
- **Use proper protective equipment, as required by local or national authorities when working in hazardous areas.**
- **Avoid working alone.**
- **Use only the replacement fuse specified or the protection may be impaired.**
- **Check the test leads for continuity before use. Do not use if the readings are high or noisy.**
- **Do not use the Auto-V LoZ function to measure voltages in circuits that could be damaged by this function's low input impedance ($\approx 3\text{ k}\Omega$) (114, 116 and 117).**

International Electrical Symbols

Table 1 lists the international symbols that appear in this document and on the Meter.

Table 1. Electrical Symbols

Symbol	Description	Symbol	Description
~	AC (Alternating Current)		Fuse
—	DC (Direct Current)		Double Insulated
	Hazardous voltage		Important Information; Refer to manual
	Battery (Low battery when shown on the display.)		Earth ground
	Do not dispose of this product as unsorted municipal waste. Go to Fluke's website for recycling information.		

General Specifications

Accuracy is specified for 1 year after calibration, at operating temperatures of 18 °C to 28 °C, with relative humidity at 0 % to 90 %.

Extended specifications are available at www.Fluke.com.

Maximum voltage between any

terminal and earth ground 600 V

Surge Protection 6 kV peak per IEC 61010-1 600 V CAT III,
Pollution Degree 2

△ Fuse for A input (115 & 117 only): 11 A, 1000 V FAST 17 kA Fuse (Fluke PN 803293)

Display Digital: 6,000 counts, updates 4/sec
Bar Graph: 33 segments, updates 32/sec

Temperature Operating: -10 °C to + 50 °C
Storage: -40 °C to + 60 °C

Temperature Coefficient 0.1 x (specified accuracy)/°C (<18 °C or >28 °C)

Operating Altitude 2,000 meters

Battery 9 Volt Alkaline, NEDA 1604A / IEC 6LR61

Battery Life Alkaline: 400 hours typical, without backlight

Safety Compliances Complies with ANSI/ISA 82.02.01 (61010-1) 2004, CAN/CSA-C22.2 No 61010-1-04, UL 6101B (2003) and IEC/EN 61010-1 2nd Edition for measurement Category III, 600 V, Pollution Degree 2, EMC EN61326-1

Certifications UL, CE, CSA, TÜV,  (N10140), VDE

IP Rating (dust and water protection) IP42

Table 2. Accuracy Specifications

Function	Range	Resolution	Accuracy ± ([% of Reading] + [Counts])		Model
DC millivolts	600.0 mV	0.1 mV	0.5 % + 2		114, 115, 117
DC Volts	6.000 V	0.001 V	0.5 % + 2		114, 115, 117
	60.00 V	0.01 V			
	600.0 V	0.1 V			
			DC, 45 to 500 Hz	500 Hz to 1 kHz	
Auto-V LoZ ⁽¹⁾ True-rms	600.0 V	0.1 V	2.0 % + 3	4.0 % + 3	114, 117
			45 to 500 Hz	500 Hz to 1 kHz	
AC millivolts ⁽¹⁾ True-rms	600.0 mV	0.1 mV	1.0 % + 3	2.0 % + 3	114, 115, 117
AC Volts ⁽¹⁾ True-rms	6.000 V	0.001 V	1.0 % + 3		114, 115, 117
	60.00 V	0.01 V			
	600.0 V	0.1 V			
Continuity	600 Ω	1 Ω	Beeper on < 20 Ω, off > 250 Ω; detects opens or shorts of 500 μs or longer.		114, 115, 117
Ohms	600.0 Ω	0.1 Ω	0.9 % + 2		114, 115, 117
	6.000 kΩ	0.001 kΩ	0.9 % + 1		
	60.00 kΩ	0.01 kΩ	0.9 % + 1		
	600.0 kΩ	0.1 kΩ	0.9 % + 1		
	6.000 MΩ	0.001 MΩ	0.9 % + 1		
	40.00 MΩ	0.01 MΩ	5.0 % + 2		
Diode test	2.000 V	0.001 V	0.9 % + 2		115, 117
Capacitance	1000 nF	1 nF	1.9 % + 2		115, 117
	10.00 μF	0.01 μF	1.9 % + 2		
	100.0 μF	0.1 μF	1.9 % + 2		
	9999 μF	1 μF	100 μF - 1000 μF: 1.9 % + 2		
			> 1000 μF: 5 % + 20		
Lo-Z Capacitance (Power-up option)	1 nF to 500 μF	10 % + 2 typical	115, 117		Lo-Z Capacitance (Power-up option)
AC Amps True-rms ⁽¹⁾ (45 Hz to 500 Hz)	6.000 A	0.001 A	1.5 % + 3		115, 117
	10.00 A ⁽³⁾	0.01 A			
DC Amps	20 A for 30 seconds max., 10 minutes rest min.		1.0 % + 3		115, 117
	6.000 A	0.001 A			
	10.00 A ⁽³⁾	0.01 A			

Function	Range	Resolution	Accuracy ± ([% of Reading] + [Counts])	Model
Hz (V or A input) ^[2]	99.99 Hz	0.01 Hz	0.1 % + 2	115, 117
	999.9 Hz	0.1 Hz		
	9.999 kHz	0.001 kHz		
	50.00 kHz	0.01 kHz		
Notes:				
[1] All ac ranges except Auto-V LoZ are specified from 1 % to 100 % of range. Auto-V LoZ is specified from 0.0 V. Because inputs below 1 % of range are not specified, it is normal for this and other true-rms meters to display non-zero readings when the test leads are disconnected from a circuit or are shorted together. For volts, crest factor of ≤3 at 4000 counts, decreasing linearly to 1.5 at full scale. For amps, crest factor of ≤3. AC volts is ac-coupled. Auto-V LoZ, AC mV, and AC amps are dc-coupled.				
[2] AC Volts Hz is ac-coupled and specified from 5 Hz to 50 kHz. AC Amps Hz is dc-coupled and specified from 45 Hz to 5 kHz.				
[3] >10 A unspecified.				

Table 3. Input Characteristics

Function	Input Impedance (Nominal)	Common Mode Rejection Ratio (1 kΩ Unbalanced)		Normal Mode Rejection
Volts AC	>5 MΩ <100 pF	>60 dB at dc, 50 or 60 Hz		
Volts DC	>10 MΩ <100 pF	>100 dB at dc, 50 or 60 Hz		>60 dB at 50 or 60 Hz
Auto-V LoZ	~3 kΩ <500 pF	>60 dB at dc, 50 or 60 Hz		
	Open Circuit Test Voltage	Full Scale Voltage		Short Circuit Current
Ohms	<2.7 V dc	To 6.0 MΩ	40 MΩ	<350 μA
		<0.7 V dc	<0.9 V dc	
Diode Test	<2.7 V dc	2.000 V dc		<1.2 mA

Basic Maintenance

Testing the Fuse (115 & 117 only)

To test the fuse:

1. Set the rotary switch to Ω .
2. Plug a test lead into the V_{Ω} jack and touch the probe to the 10A jack, as shown in Figure 1.

If the display shows a resistance value in the range of that shown in Figure 1, the fuse is good.

If the display reads OL, replace the fuse and test again.

If the display shows any other value, have the Meter serviced. See “Contact Information” earlier in this document.

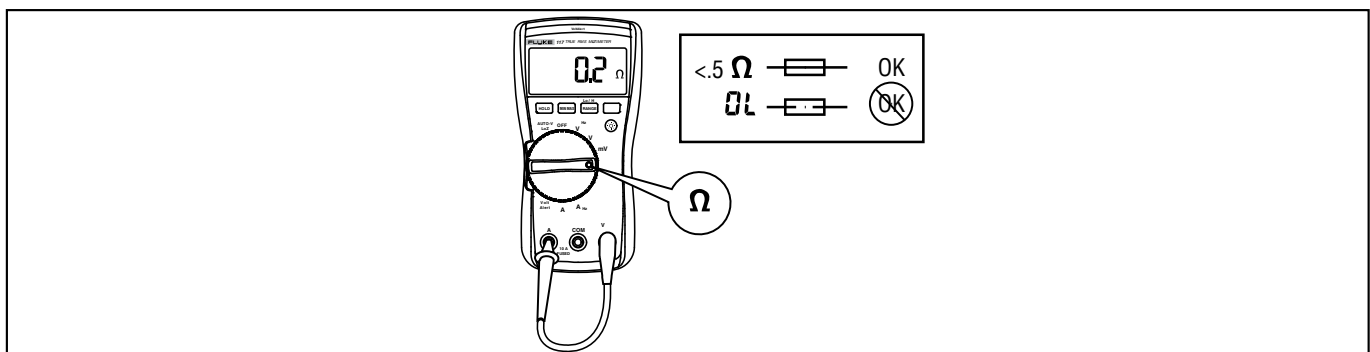

Figure 1. Fuse Testing

erc010f.emf

Replacing the Battery and Fuse

⚠ ⚠ Warning

To avoid shock, injury, or damage to the Meter:

- Remove test leads from the Meter before opening the case or battery door.
- Use **ONLY** a fuse with the amperage, interrupt voltage, and speed ratings specified.

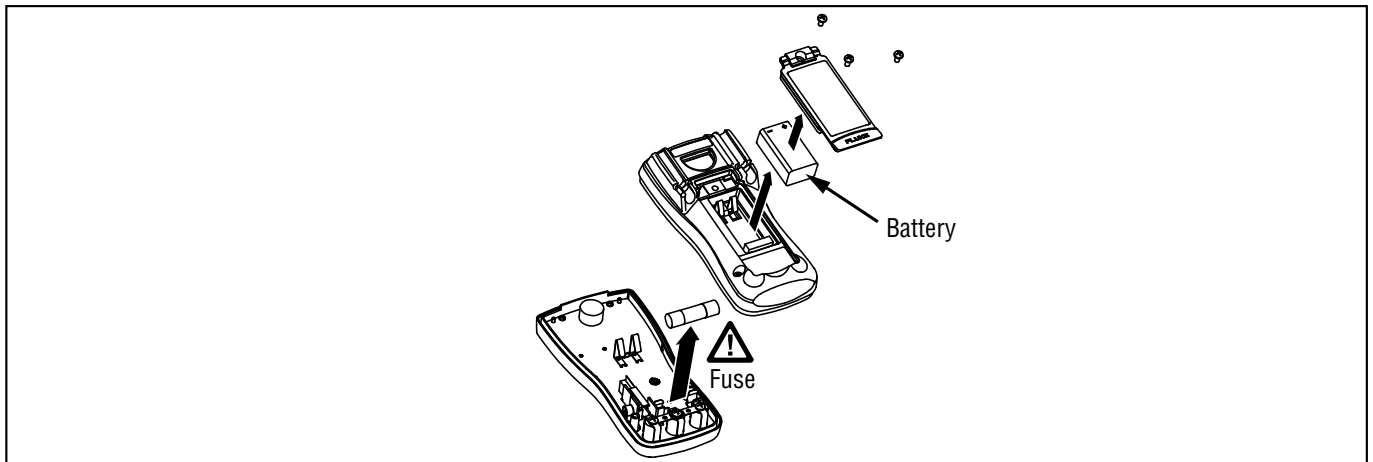

Figure 2. Battery and Fuse Replacement

erc011f.emf

To remove the battery door for battery replacement, refer to Figure 2 while performing the following:

1. Remove the test leads from the Meter.
2. Remove the battery door screw.
3. Use the finger recess to lift the door slightly.
4. Lift the door straight up to separate it from the case.
5. The battery fits inside the battery door, which is then inserted into the case, bottom edge first, until it is fully seated. Do not attempt to install the battery directly into the case.
6. Install and tighten battery door screw.

To open the case for fuse replacement, refer to Figure 2 while performing the following:

1. Remove the test leads from the Meter.
2. Remove the Meter from its holster.
3. Remove two screws from the case bottom.
4. Separate the case bottom from the case top.
5. Remove the fuse from its holder and replace with an 11 A, 1000 V, FAST fuse having a minimum interrupt rating of 17,000 A. Use only Fluke PN 803293.
6. To re-assemble the Meter, attach the case bottom to the case top and secure with the two screws. Insert the Meter into its holster.

Cleaning the Meter

Wipe the case with a damp cloth and mild detergent. Do not use abrasives or solvents. Dirt or moisture in the terminals can affect readings.

Performance Tests

⚠⚠ Warning

To avoid electric shock, do not perform the performance test procedures unless the Meter is fully assembled.

The following performance tests verify the complete operation of the Meter and check the accuracy of each Meter function against its specifications. The recommended calibration interval is 12 months. If the Meter fails any part of the test, calibration adjustment and/or repair is indicated.

In the performance tests, the Meter is referred to as the unit under test (UUT).

Required Equipment

Table 4 lists the equipment required to conduct a performance test on the Meter.

Table 4. Required Equipment

Recommended Equipment	Measurement Function	Accuracy
5500A Multi-product Calibrator (or equivalent)	DC Volts	10 mV to 600 V ±0.125 %
	DC Current (115, 116, and 117)	600 µA to 10 A ±0.25 %
	AC Volts	6 mV to 600 V ±0.25 % @ 45 Hz to 1 kHz
	AC Current (115, 116, and 117)	600 µA to 10 A ±0.375 % @ 45 Hz to 1 kHz
	Resistance	0 to 5 MΩ ±0.225 % 10 to 30 MΩ ±0.375 %
	Capacitance (115, 116, and 117)	9 to 900 µF ±0.475 %
	Temperature (116)	0 °C to 400 °C ±0.25 %

Table 2. Required Equipment (cont)

Recommended Equipment	Measurement Function	Accuracy
5500A Multi-product Calibrator (or equivalent)	Frequency (115, 116, and 117)	2 V, 50 kHz ±0.025 %
Fluke 80 AK K-type Thermocouple Adapter Accessory	Temperature (116)	
K-type Thermocouple, mini-plug on both ends	Temperature (116)	
Double Banana plug	VoltAlert (117)	

Testing the Display

Push **HOLD** and turn the rotary switch to the \tilde{v}^{Hz} position. Compare the display with the example in Figure 3. Check all segments for clarity and contrast.

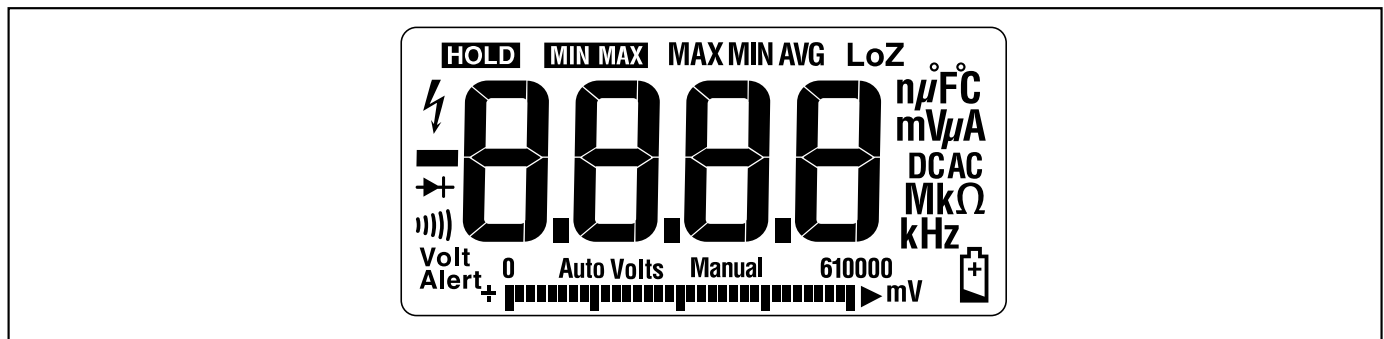

Figure 3. Display Segments

erc022f.emf

Backlight Test

To Test the Backlight, press the ☉ button and verify that the backlight comes on.

Keypad Test

To test the keypad, turn the Meter to ACV and push each button separately. Each button push should cause the Meter to beep and activate a display annunciator.

Reset the Meter by turning it **Off** and then back to an On position.

Preparing for the Performance Tests

⚠️⚠️ Warning

To avoid possible electric shock or personal injury:

- Do not perform the following procedures unless qualified to do so. Some procedures involve the use of high voltages.
- Before handling the test connections and in between tests, make sure the calibrator is in standby mode (STBY).

To prepare for the performance test:

1. Make sure that you have the required equipment (refer to Table 4).

2. Warm up the calibrator as required by its specifications.
3. Allow the temperature of the UUT to stabilize at room temperature ($23\text{ }^{\circ}\text{C} \pm 5\text{ }^{\circ}\text{C}$ [$73\text{ }^{\circ}\text{F} \pm 9\text{ }^{\circ}\text{F}$]).
4. Check the fuses and Battery, and replace them if necessary. Refer to “Testing the Fuses”, and “Replacing the Battery and Fuse”.

To verify the accuracy of the DMM functions, do the following:

1. Connect the Calibrator to the $V\Omega$ and COM input terminals on the Meter.
2. Turn the rotary switch to the function listed in each step of Table 5.
3. Apply the input level for each step listed in Table 5.
4. Compare the reading on the Meter display with the Display Reading in Table 5.
5. If the display reading falls outside of the range shown in Table 5, the Meter requires calibration adjustment or repair.

Testing Temperature (116 only)

Connect the K-type thermocouple to the temperature input of the Meter and temperature calibrator. To ensure an accurate measurement, the Meter and the thermocouple connector must be at the same temperature. After connecting the thermocouple to the Meter, allow the junctions to stabilize before recording the displayed reading. This can take several minutes, depending on temperature gradients.

Table 5. DMM Performance Tests

Step	Function	Range	Applied	Display Reading			
				114 ^[1]	115 ^[1]	116 ^[1]	117 ^[1]
1	Ω Ohms	600.0	0.0 Ω	0.0 to 0.2			
2		600.0	500 Ω	495.3 to 504.7			
3		6.000 k	5 k Ω	4.954 to 5.046			
4		60.00 k	50 k Ω	49.54 to 50.46			
5		600.0 k	500 k Ω	495.4 to 504.6			
6		6.000 M	5 M Ω	4.954 to 5.046			
7		40.00 M	10 M Ω	9.48 to 10.52			
8		40.00 M	30 M Ω	28.48 to 31.52			
9))) Continuity	600 Ω	20 Ω	Beeper On			
10		600 Ω	250 Ω	Beeper Off			
11	\tilde{V} AC Volts	6.000 V	5V, 45 Hz	4.947 to 5.053			
12		6.000 V	5V, 1 kHz	4.897 to 5.103			
13		60.00 V	50 V, 45 Hz	49.47 to 50.53			
14		60.00 V	50V, 1 kHz	48.97 to 51.03			
15		600.0 V	600V, 45 Hz	593.7 to 606.3			
16		600.0 V	600V, 1kHz	587.7 to 612.3			
17	\tilde{V} Hz AC Volts + Hz	6.000V	2 v, 50 kHz ^[1]	NA	49.93 to 50.07		

Table 5. DMM Performance Tests (cont)

Step	Function	Range	Applied	Display Reading			
				114 ^[1]	115 ^[1]	116 ^[1]	117 ^[1]
18	$\overline{\text{V}}$ DC Volts	6.000V	0V	-0.002 to 0.002			
19		6.000V	5V	4.973 to 5.027			
20		60.00V	50V	49.73 to 50.27			
21		600.0V	600V	596.8 to 603.2			
22		600.0V	-600V	-596.8 to -603.2			
23	$\widetilde{\text{mV}}$ AC Millivolts	600.0 mV	6 mV, 45 Hz	5.6 to 6.4			
24		600.0 mV	600mV, 1 kHz	587.7 to 612.3			
25	$\overline{\text{mV}}$ DC Millivolts	600.0 mV	10 mV	9.7 to 10.3			
26		600.0 mV	600mV	596.8 to 603.2			
27	\rightarrow Diode	2.000 V	1.9V	N/A	1.881 to 1.919		
28	+ Capacitance	1000 nF	Open	N/A	0 to 2	0 to 2	0 to 2
29		9999 μ F	900 μ F	N/A	881 to 919	881 to 919	881 to 919
30	LoZ Capacitance	10.00 μ F	9 μ F	N/A	7.18 to 10.82		
Set calibrator to standby, reconfigure leads, and program for amps output							
31	$\overline{\text{A}}$ DC Amps	10.00 A	10A	N/A	9.87 to 10.13	N/A	9.87 to 10.13
32	$\widetilde{\text{A}}$ AC Amps	6.000 A	5.0A, 45 Hz	N/A	4.922 to 5.078	N/A	4.922 to 5.078
33	$\overline{\mu\text{A}}$ DC μ amps	600.0 μ A	600 μ ADC	N/A	N/A	593.8 to 606.2	N/A
34	$\overline{\mu\text{A}}$ AC μ amps	600.0 μ A	600 μ AAC, 45 Hz	N/A	N/A	590.7 to 609.3	N/A
35	Temperature		Open input	N/A	N/A	OFF_n	N/A
36			0.0 °C	N/A	N/A	-1.0 to 1.0	N/A
37				400 °C	N/A	N/A	395.0 to 405.0
38	AUTO-V LoZ		0.5 V, 45 Hz	0.2 to 0.8, AC Annunciator On	N/A	0.2 to 0.8, AC Annunciator On	0.2 to 0.8, AC Annunciator On
39			0.5 V, 0 Hz	0.2 to 0.8, DC Annunciator On	N/A	0.2 to 0.8, DC Annunciator On	0.2 to 0.8, DC Annunciator On
40				500 V ^[2] , 500 Hz	489.7 to 510.3	N/A	489.7 to 510.3

Table 5. DMM Performance Tests (cont)

Step	Function	Range	Applied	Display Reading			
				114 ^[1]	115 ^[1]	116 ^[1]	117 ^[1]
41	VoltAlert	Hi		N/A	N/A	N/A	Refer to steps 1 – 5 in the procedure below
42	VoltAlert	Lo		N/A	N/A	N/A	Refer to steps 6 – 9 in the procedure below

[1] If using a Fluke 9100 calibrator, the Calibrator Frequency mode must be used to obtain accurate frequency.
 [2] To keep from tripping the calibrator to standby, ramp up the voltage in 50 V increments with a 5 second delay between increments.

Testing the VoltAlert Function (117 only)

Use the following procedure to verify that VoltAlert functions properly.

Note

- *Ensure the instrument is REMOVED from the holster prior to performing the test.*
- *Keep the meter away from electrical noise sources during the tests, i.e., florescent lights, dimmable lights, motors, etc.. These sources can trigger VoltAlert and invalidate the test.*
- *It may be necessary in steps 4 and 8 below to slightly adjust the Meter’s position for maximum signal strength, in order to get the Meter’s beeper to sound continuously.*

Refer to Figure 4 while performing the following steps.

1. Select the VoltAlert function, and verify that “Hi” is on the display. Verify that the beeper is silent and the red LED is off.
2. Connect a double banana plug to the output voltage terminals of the calibrator (Fluke 5500A or equivalent).
3. Set the calibrator output to 10 V at 60 Hz.
4. Hold the Meter so that the Meter’s top is vertically and horizontally centered and contacting the banana plug’s Hi terminal. Verify that the Meter’s beeper is on continuously, and the red LED, at the top of the display, lights up.
5. Place the calibrator in standby mode and verify that the beeper is now silent and the red LED is off.
6. Press the **RANGE** (display should indicate ‘Lo’ range).
7. Set the calibrator’s output to 30 V at 60 Hz.

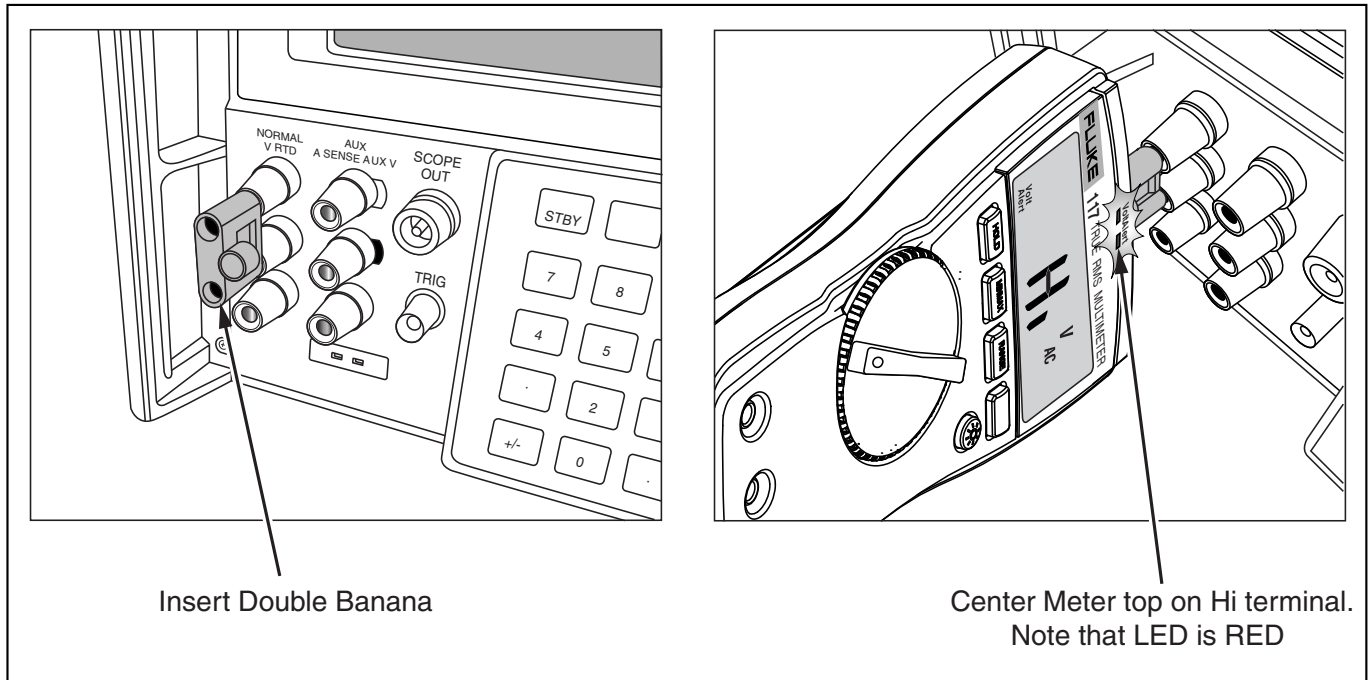

Figure 4. VoltAlert Testing

erc013f.emf

8. Hold the Meter so that the top is vertically and horizontal centered to the banana plug's Hi terminal. Verify that the Meter's beeper is sounding continuously and the red LED at the top of the display lights.
9. Return the calibrator to standby mode and verify the Meter's beeper is silent and the red LED is off.

Calibration Adjustment

The Meter features closed-case calibration adjustment using known reference sources. The Meter measures the applied reference source, calculates correction factors, and stores the correction factors in nonvolatile memory.

The following sections present the features and Meter pushbutton functions available during the Calibration Adjustment Procedure. Should the Meter fail any of the performance tests, perform the Calibration Adjustment Procedure.

Use the following steps to view the Meter's calibration counter.

1. While pressing **HOLD**, turn the rotary switch from **OFF** to Ω function. The Meter should display "CAL".
2. Press once to view the calibration counter. For example, "0000".
3. Turn the rotary switch to **OFF**.

Calibration Adjustment Password

To start the Calibration Adjustment Procedure, the correct 4-digit password must be entered. The default password is "1234". The password can be changed or reset to the default as described in following paragraphs.

Changing the Password

Use the following steps to change the Meter's password:

1. While pressing **HOLD**, turn the rotary switch from **OFF** to Ω function. The Meter should display "CAL".

2. Press once to see the calibration counter.
3. Press again to start the password entry. The Meter displays “□□□□”
4. The Meter buttons indicated below represent the numbers 1 through 5 when entering or changing the password:
HOLD = 1 **MIN MAX** = 2 **RANGE** = 3 = 4 = 5
5. Press 4 buttons to enter the current password. If changing the password for the first time, enter **HOLD** (1), **MIN MAX** (2), **RANGE** (3), and (4).
6. Press **RANGE** to change the password. The Meter displays “□□□□” if the entered password is correct. If the password is not correct, the Meter emits a double beep, displays “□□□□”, and the password must be entered again. Repeat step 5.
7. Press the 4 buttons of the new password.
8. Press to store the new password.

Restoring the Default Password

If the calibration password is forgotten, the default password (1234) can be manually restored using the following steps:

⚠ ⚠ Warning

To avoid electric shock or personal injury, remove the test leads and any input signal before removing the Meter’s back case.

1. Remove the Meter’s back case. Leave the pca in the top case.
2. Apply 9.0V across the battery contacts (XBT1) + and (XBT2) – on the back of the PCA. See Figure 5.
3. Turn the rotary switch from **OFF** to any on position.
4. Short across the S7 CAL keypad on the back of the PCA. See Figure 5. The Meter should beep. The default password is now restored.
5. Remove the 9.0V supply and replace the Meter’s back case.

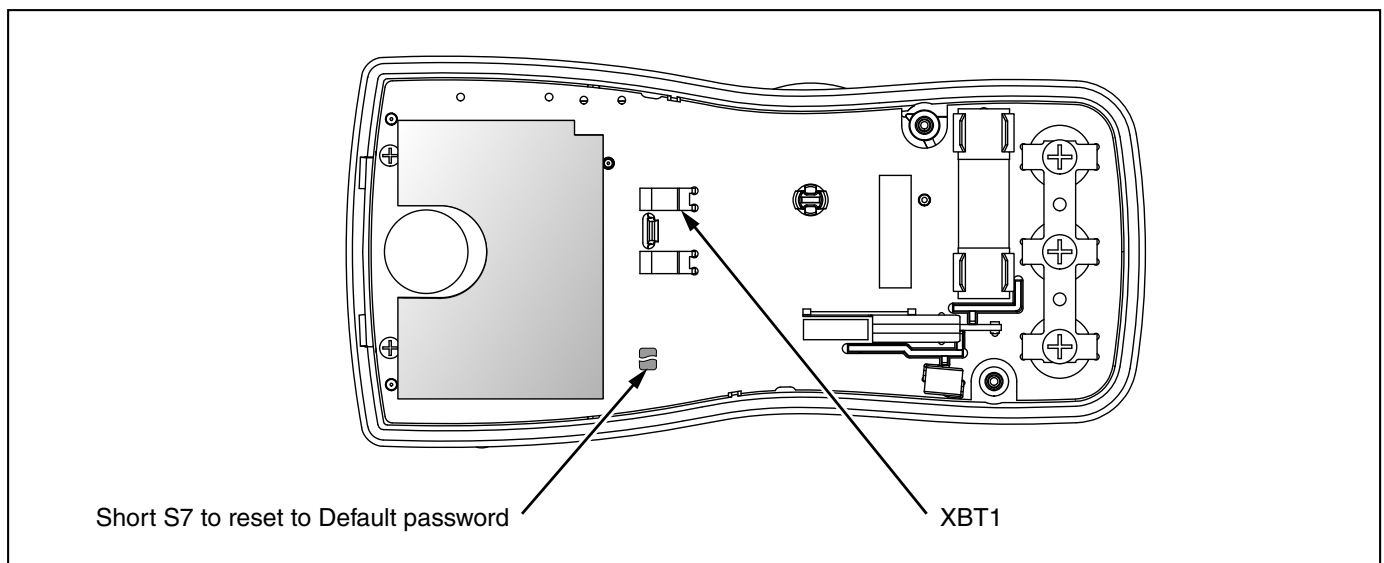

Figure 5. Calibration Password Reset

erc12f.enf

Meter Buttons Used in the Calibration Steps

When performing the Calibration Adjustment Procedure, the Meter buttons behave as follows. This may be of help determining why a calibration step is not accepted and for determining the input value without referring to Table 6.

Press and hold **HOLD** to show the measured value. The measured value is not calibrated so it may not match the input value. This is normal.

Press and hold **MIN MAX** to display the required input value.

Press to store the calibration value and advance to the next step. This button is also used to exit calibration mode after the calibration adjustment sequence is complete.

Press  to toggle the backlight on and off.

Calibration Adjustment Procedure

To adjust the Meter's calibration, use the following steps. If the Meter is turned off before completion of the adjustment procedure, the calibration constants are not changed.

1. While holding down **HOLD**, turn the rotary switch from **OFF** to **Ω** function. The Meter should display “**ΩCAL**”.
2. Press once to see the calibration counter.
3. Press again to start the password entry. The Meter displays “□□□□”.
4. Press the 4 button password.
5. Press to go to the first calibration step. The Meter displays “**1 000**” if the password is correct. If the password is not correct, the Meter emits a double beep, displays “□□□□” and the password must be entered again. Repeat step 4.
6. Apply the input value listed for each calibration adjustment step. For each step, select the rotary switch position and apply the input to the terminals as indicated in the Table 4.

Note

Some adjustment steps require additional wait time after the calibrator settles, as noted in Table 6.

7. After each input value is applied, press to accept the value and proceed to the next step (**1 000** and so forth).

Notes

After pressing , wait until the step number advances before changing the calibrator source or turning the Meter's rotary knob. Some adjustment steps can take up to several seconds to execute before moving to the next step.

If the knob is not in the correct position for a given step, the meter will flash the unit annunciators until the knob is put in a valid position. The keys that show the reading and required input values are not allowed until the knob is correct.

Likewise, if the rotary switch is not in the correct position or the measured value is not within the anticipated range of the input value, the Meter will emit a double beep and will not continue to the next step when is pressed.

8. After the final step, the display shows “**End**” to indicate that the calibration adjustment is complete. Press to return to meter mode.

Notes

Set the calibrator to Standby prior to changing the function switch position and after completing adjustment of each function.

If the calibration adjustment procedure is not properly completed, the Meter will not operate correctly.

Table 6. Calibration Adjustment Steps

Rotary Switch Position	Calibration Steps				Input Terminals	Calibrator Source Value
	114	115 ^[1]	116 ^[1]	117 ^[1,2]		
Ω Ohms	N/A	001	001	001 ^[2]	No leads	No leads
$m\tilde{V}$	001	002	002	002	V Ω /+ and COM	0 V, 0 Hz
	002	003	003	003	V Ω /+ and COM	300 mV, 0 Hz
	003	004	004	004	V Ω /+ and COM	100 mV, 0 Hz
	004	005	005	005	V Ω /+ and COM	-300 mV, 0 Hz
	005	006	006	006	V Ω /+ and COM	60 mV, 0 Hz
	006	007	007	007	V Ω /+ and COM	600 mV, 0 Hz
	007	008	008	008	V Ω /+ and COM	600 mV, 60 Hz
Ω Ohms	008	009	009	009	V Ω /+ and COM	600 Ω , 2-wire comp
	009	010	010	010	V Ω /+ and COM	6 k Ω
	010	011	011	011	V Ω /+ and COM	60 k Ω
	011	012	012	012	V Ω /+ and COM	600 k Ω
	012	013	013	013	V Ω /+ and COM	6 M Ω ^[3]
	013	014	014	014	V Ω /+ and COM	Short ^[3]
	014	015	015	015	V Ω /+ and COM	40 M Ω ^[3]
\tilde{V}	015	016	016	016	V Ω /+ and COM	6 V, 60 Hz
	016	017	017	017	V Ω /+ and COM	60 V, 60 Hz
	017	018	018	018	V Ω /+ and COM	600 V, 60 Hz
	018	019	019	019	V Ω /+ and COM	6 V, 0 Hz
	019	020	020	020	V Ω /+ and COM	60 V, 0 Hz
	020	021	021	021	V Ω /+ and COM	600 V, 0 Hz
Set calibrator to standby, reconfigure leads, and program for amps output.						
\tilde{A}	N/A	022	N/A	022	A and COM	6 A, 60 Hz ^[3]
\overline{A}	N/A	023	N/A	023	A and COM	6 A, 0 Hz
$\mu\tilde{A}$ AC μ amps	N/A	N/A	022	N/A	+ and COM	600 μ A, 60 Hz

Table 4. Calibration Adjustment Steps (cont)

Rotary Switch Position	Calibration Steps				Input Terminals	Calibrator Source Value
	114	115 ^[1]	116 ^[1]	117 ^[1,2]		
 DC μamps	N/A	N/A	[]	N/A	+ and COM	600 μA, 0 Hz
[1] Models listed in this column also refer to the "C" version of the model. For example, model 115 steps are valid for the 115C. [2] Do not calibrate the 117 or 117C with a line-frequency power source nearby (e.g. fluorescent light, power strip, etc.). These devices can produce errors in the VoltAlert calibration. [3] Wait an additional 5 seconds after calibrator has settled before pressing <input type="checkbox"/> .						

Replacement Parts

Table 7 lists the Meter's replaceable parts identified in Figure 6.

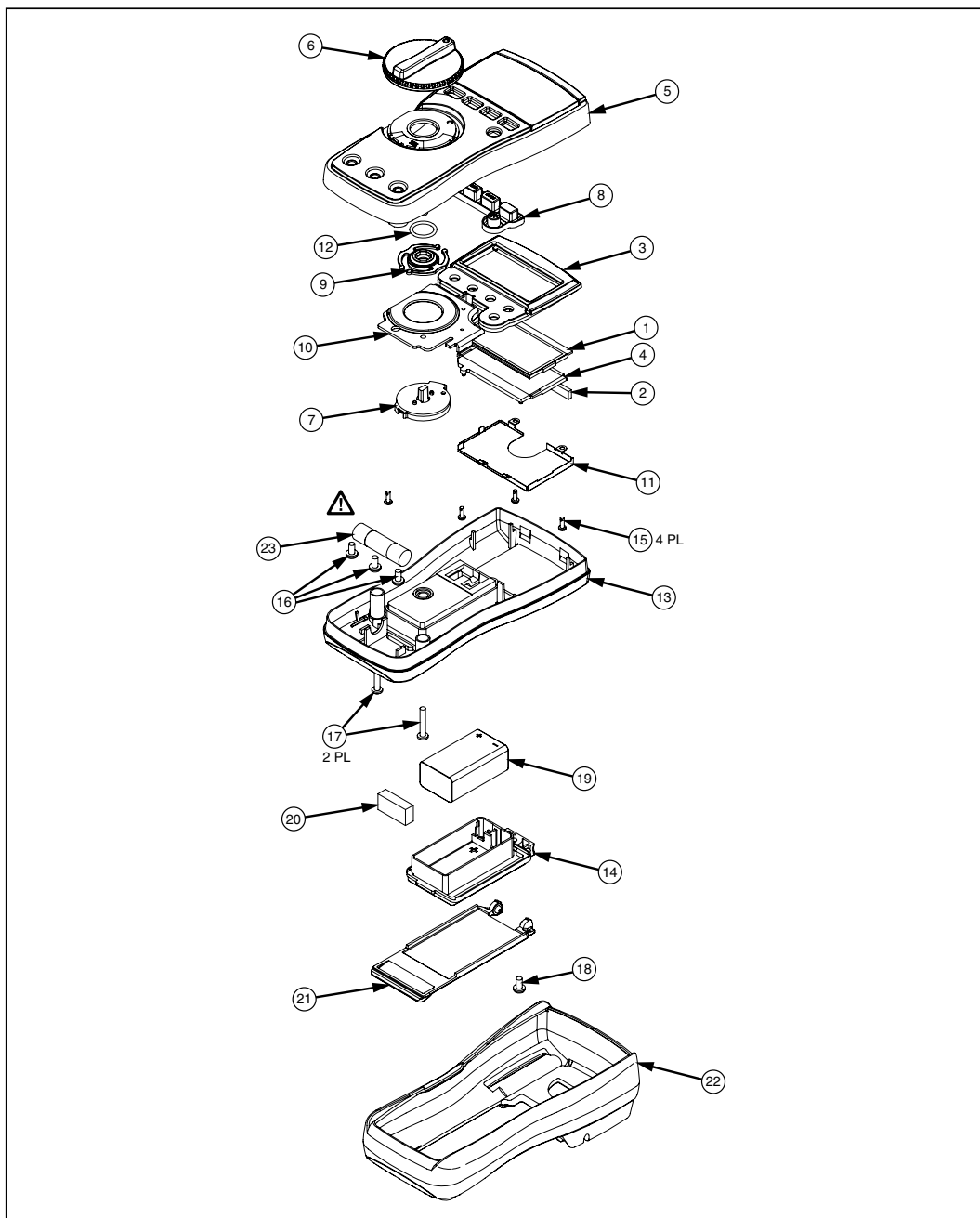

Figure 6. Exploded View of Meter

erc14.emf

Table 7. Replaceable Parts List

Item	Description	Part Number	Qty.
1	LCD,FLUKE-11X,3.2V,TN,4-DIGIT,1/4-DUTY,1/3-BIAS,LEPTON	2509955	1
2	CONNECTOR,ELASTOMERIC,.010 IN CTR,.218 IN HIGH,.090 IN THK,2.284 IN LONG,BULK	2534229	1
3	FLUKE-117-2006,BRACKET MASK, 117	2525608	1
	FLUKE-117-2006-06,BRACKET MASK, 117 China	2631059	1
	FLUKE-117-2006-01,BRACKET MASK, 114	2527431	1
	FLUKE-117-2006-02,BRACKET MASK, 115	2527446	1
	FLUKE-117-2006-04,BRACKET MASK, 115 China	2631032	1
	FLUKE-117-2006-03,BRACKET MASK, 116	2527454	1
	FLUKE-117-2006-05,BRACKET MASK, 116 China	2631044	1
4	FLUKE-117-8005,DIFFUSER, BACKLIGHT	2535203	1
5	FLUKE-117-2001,CASE TOP, 117	2525553	1
	FLUKE-117-2001-01,CASE TOP, 114	2527405	1
	FLUKE-117-2001-02,CASE TOP, 115	2527410	1
	FLUKE-117-2001-03,CASE TOP, 116	2527422	1
6	FLUKE-117-2008,KNOB	2525624	1
7	FLUKE-117-7602,RSOB HOUSING ASSEMBLY	2787083	1
8	FLUKE-117-8001,KEYPAD	2526276	1
9	FLUKE-117-2009,SPRING DETENT	2525636	1
10	FLUKE-117-8009,SHIELD, TOP	2571277	1
11	FLUKE-117-8010,IC SHIELD	2571292	1
12	O-RING,NITRILE,SHORE A 70,15.6MM OD,12.0MM ID ,1.8MM W	2535215	1
13	FLUKE-117-2002,CASE BOTTOM	2525566	1
	FLUKE-117-2002,CASE BOTTOM, 11X China	2631098	1
14, 21	FLUKE-117-2003,BATTERY DOOR,TILT STAND	2720600	1
	FLUKE-117-2003,BATTERY DOOR, TILT STAND, 11X China	2720617	1
15	SCREW,2-28,.250,PAN,PHILLIPS,STEEL,ZINC-CHROMATE,PLASTITE 48 THREAD FORMING	2516493	4
16	SCREW,M3,4MM,PAN,PHILLIPS,STEEL,ZINC-CHROMATE	2032811	2 (114, 116) 3 (115, 117)
17	SCREW,5-14,.750,PAN,PHILLIPS,STEEL,BLACK CHROMATE,THD FORMING	832246	2
18	SCREW,M3X0.5,6MM,PAN,PHILLIPS,STEEL,ZINC-BLACK CHROMATE	2032792	1

Table 5. Replaceable Parts List

Item	Description	Part Number	Qty.
19	BATTERY, PRIMARY, MNO2-ZN, 9V, 505MAH, 6LR61, ALKALINE, 17X26X48MM, BULK	614487	1
20	FLUKE 12-8004, SHOCK ABSORBER	878983	1
22	FLUKE-117-2010, HOLSTER	2525649	1
	FLUKE-117-2010, HOLSTER, 11X China	2631080	1
23	FUSE, 11A, 1000V, FAST. 406INX1.5IN, BULK	803293	1 (115, 117)
Not shown	MANUAL, 114/115/117 USERS MANUAL, EFSPAsia	2538674	1
Not shown	MANUAL, 114/115/117 USERS MANUAL, EFG(Eur)	2572573	1
Not shown	MANUAL, 115C/117C USERS MANUAL	2538695	1
Not shown	MANUAL, 116 USERS MANUAL, EFSPAsia	2538688	1
Not shown	MANUAL, 116 USERS MANUAL, EFG(Eur)	2572586	1
Not shown	MANUAL, 116C USERS MANUAL	2538707	1

Warranty

This Fluke product will be free from defects in material and workmanship for three years from the date of purchase. This warranty does not cover fuses, disposable batteries, or damage from accident, neglect, misuse, alteration, contamination, or abnormal conditions of operation or handling. Resellers are not authorized to extend any other warranty on Fluke's behalf. To obtain service during the warranty period, contact your nearest Fluke authorized service center to obtain return authorization information, then send the product to that Service Center with a description of the problem.

THIS WARRANTY IS YOUR ONLY REMEDY. NO OTHER WARRANTIES, SUCH AS FITNESS FOR A PARTICULAR PURPOSE, ARE EXPRESSED OR IMPLIED. FLUKE IS NOT LIABLE FOR ANY SPECIAL, INDIRECT, INCIDENTAL OR CONSEQUENTIAL DAMAGES OR LOSSES, ARISING FROM ANY CAUSE OR THEORY. Since some states or countries do not allow the exclusion or limitation of an implied warranty or of incidental or consequential damages, this limitation of liability may not apply to you.

Fluke Corporation
P.O. Box 9090
Everett, WA 98206-9090
U.S.A.

Fluke Europe B.V.
P.O. Box 1186
5602 BD Eindhoven
The Netherlands

