

Pushbuttons/Selectors/Pilot Lights/Buzzers

AH164, AH165 and AH165-2

General information

■ Features

Design basis

The 16mm dia. series of compact size pushbuttons are 'finger-size', and consequently take up little panel space. AH165-2 series operators are about twice as large as the AH164 and AH165 series operators for easier operation. With many types of operator available, the most suitable switch can be identified by color, shape and legend, and have a smooth, quality "snap-action". In spite of their small size they have a highly reliable mechanism, and are eminently suited for solid state and other electronic circuits. AH164, AH165 and AH165-2 series contact block holders can easily be removed manually. Moreover, the contact block can be easily attached or detached without using any special tools, thus facilitating addition or replacement of contact.

Selector switches

Selector switches can also be supplied in either knob-handle operated or key operated types.

Strong construction

The operator and contact blocks are molded from an excellent thermal resistance resin and can withstand the heat at the time of soldering. Since these pushbuttons are manufactured to industrial standards they can withstand vibration or shock thus eliminating lamp failure due to such causes as loose bases. With regard to the degree of protection, standard types which met the requirements of IP40 of IEC 60529, and oil tight types which meet the requirements of IP65 of the said, are available. This permits the application to various fields, from machine tools to OA (Office Automation) facilities.

Quality feel tough

Both the operator and contact block are precisely engineered. There is no fear of the switch malfunction even after long use and it continues to operate smoothly for its service life of about 1,000,000 operations.

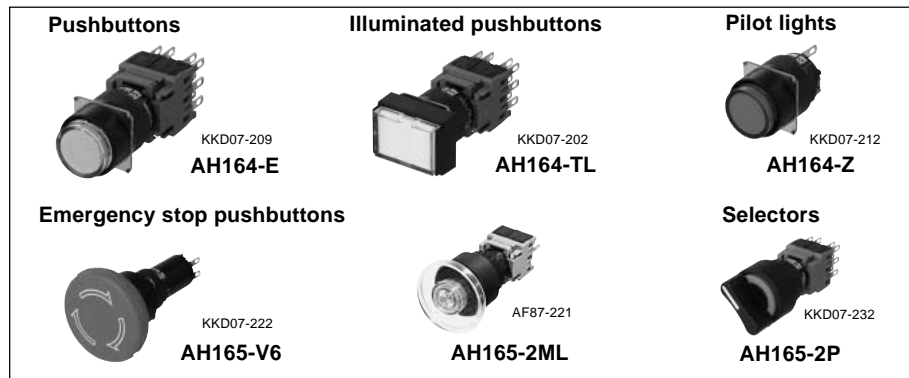

Easy color change

Color lenses fit over the inner button. The lens can easily be removed using a small screwdriver

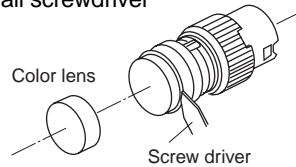

Note: The luminous color of LEDs and neon illumination types varies with the body color of the product.

Visible inscription

Button legends are printed on legend sheet, which is stuck to the legend plate on the inner button. The lettering is back lit by the switch lamp and the inscription is highly visible through the color lens. Contact FUJI for your lettering requirements.

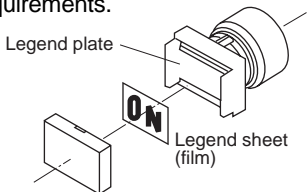

Excellent switch reliability

The switch uses a snap-action mechanism. The pushbuttons are available with either momentary or alternative actions. The snap-action switch has a double break movement which operates independently of the speed of switching. The contacts are made from gold-flashed silver. High contact reliability of 1mA at 5V AC/DC is assured. Contact blocks are available in 1NO+1NC to 3NO+3NC arrangement.

Large terminals

Solder/tab terminal is provided as standard. Wire-wrap terminal is available on request.

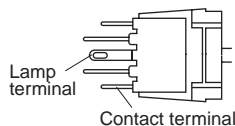

Safety

FUJI's original Trigger Action mechanism is used in the emergency stop pushbuttons. They are suitable for emergency stop and safety. This mechanism prevents the contacts from moving until the button is pushed and locked.

- Provided with a trigger action mechanism conforming to EN418.
- Provided with direct opening action (approved by TÜV) conforming to EN60947-5-1 and EN60947-5-5.

Alternate action

In the case of alternate action when the button is depressed the contacts are maintained and remain so even if the finger is removed. The button will not return to its free position. In order to remove the lock, the button must be given a second pressure before the button will return to its free position. This makes it most suitable as the switch for a power source.

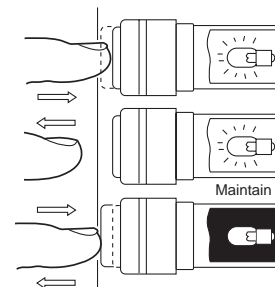

Pushbutton with finger guards

Finger guards are provided for square or rectangular type pushbuttons (SF, TF, SL and TL types) in order to prevent operational error of adjacent buttons.











Approvals



For further information related to approved type, see page 04/187 to 04/190.





















AH164 (standard) / AH165 (oil-tight)

■ **Illuminated pushbutton switches**

Operator	Type	Operator	Type	Operator	Type
Extended round head <i>See page 04/195</i> 	AH164-L, L5 AH165-L, L5  KKD07-205	Flush square head <i>See page 04/195</i> 	AH164-SL, SL5 AH165-SL, SL5  KKD07-204	Flush rectangular head <i>See page 04/195</i> 	AH164-TL, TL5 AH165-TL, TL5  KKD07-202
Flush rectangular head with guard <i>See page 04/196</i> 	AH164-TGL, TGL5 AH165-TGL, TGL5  KKD07-203	Flush square head with guard <i>See page 04/196</i> 	AH164-SGL, SGL5 AH165-SGL, SGL5  KKD05-075b		

Note: Spot LED and red/green LED types: Not approved standard

■ **Pushbutton switches**

Operator	Type	Operator	Type	Operator	Type
Extended round head <i>See page 04/199</i> 	AH164-E, E5 AH165-E, E5  KKD07-209	Mushroom head <i>See page 04/199</i> 	AH164-M, M5 AH165-M, M5  KKD07-210	Flush square head <i>See page 04/199</i> 	AH164-SF, SF5 AH165-SF, SF5  KKD07-208
Flush rectangular head <i>See page 04/199</i> 	AH164-TF, TF5 AH165-TF, TF5  KKD07-206	Flush rectangular head with guard <i>See page 04/199</i> 	AH164-TGF, TGF5 AH165-TGF, TGF5  KKD05-176	Flush square head with guard <i>See page 04/199</i> 	AH164-SGF, SGF5 AH165-SGF, SGF5  KKD05-075b
Convex square head <i>See page 04/199</i> 	AH164-SM, SM5 AH165-SM, SM5  KKD05-081b	Convex rectangular head <i>See page 04/199</i> 	AH164-TM, TM5 AH165-TM, TM5  KKD05-082b	Push-lock, turn-reset (32mm dia.) ⊖ (Direct opening action) <i>See page 04/200</i> 	AH165-VR  AF91-584
Push-lock, turn-reset (40mm dia.) ⊖ (Direct opening action) <i>See page 04/200</i> 	AH165-V1R  AF91-583				

■ **Emergency stop pushbutton switches** ⊖ (Direct opening action), conform to EN418

Operator	Type	Operator	Type
Push-lock, turn-reset (32mm dia.) <i>See page 04/200</i> 	AH165-V5R  KKD07-221	Push-lock, turn-reset (40mm dia.) <i>See page 04/200</i> 	AH165-V6R  KKD07-222













Note: (CCC): *See page 04/292*

Pushbuttons/Selectors/Pilot Lights/Buzzers









AH164, AH165 and AH165-2

Quick reference guide







■ Selector switches

Operator	Type	Operator	Type	Operator	Type
Knob with rectangular bezel <i>See page 04/201</i> 	AH164-P AH165-P  KKD07-213	Knob with square bezel <i>See page 04/201</i> 	AH164-SP AH165-SP  KKD07-215	Key with rectangular bezel <i>See page 04/201</i> 	AH164-J AH165-J  KKD09-001L
Key with square bezel <i>See page 04/201, 04/204</i> 	AH164-SJ AH165-SJ  KKD09-001R	Key with rectangular bezel ⊖ (Direct opening action) <i>See page 04/202</i> 	AH165-JM  KKD09-006	Key ⊖ (Direct opening action) <i>See page 04/202</i> 	AH165-RJM  KKD09-007

■ Pilot lights

Lens	Type	Lens	Type	Lens	Type
Extended round <i>See page 04/206</i> 	AH164-Z AH165-Z  KKD07-212	Flush square <i>See page 04/206</i> 	AH164-ZS AH165-ZS  KKD05-094b	Flush rectangular <i>See page 04/206</i> 	AH164-ZT AH165-ZT  KKD07-211
Dome <i>See page 04/206</i> 	AH165-ZM  AF87-45				

■ Buzzers

Sound	Type	Sound	Type	Sound	Type
Standard <i>See page 04/208</i>	AH164-TX  AF87-317	Loud sound <i>See page 04/208</i>	AH164-TX1  AF87-44	Loud sound with volume control <i>See page 04/208</i> 	AH164-TX2B  KKD07-223
Standard sound with volume control (IP54) <i>See page 04/208</i> 	AH165-X  KKD05-096b				

Note: (CCC): *See page 04/292*

AH165-2 (oil-tight)

■ **Illuminated pushbutton switches**

Operator	Type	Operator	Type	Operator	Type
Flush round head <i>See page 04/213</i> 	AH165-2FL, 2FL5  <small>AF87-211</small>	Extended round head <i>See page 04/213</i> 	AH165-2EL, 2EL5  <small>AF87-210</small>	Mushroom head <i>See page 04/213</i> 	AH165-2ML  <small>AF87-221</small>
Mushroom head with square bezel <i>See page 04/213</i> 	AH165-2YML  <small>AF87-220</small>	Flush square head <i>See page 04/214</i> 	AH165-2SFL, 2SFL5  <small>AF87-201</small>	Extended square head <i>See page 04/214</i> 	AH165-2SEL, 2SEL5  <small>AF87-200</small>
Concave square head <i>See page 04/214</i> 	AH165-2SCL, 2SCL5  <small>AF87-199</small>	Push-lock, turn-reset <i>See page 04/215</i> 	AH165-2VL  <small>AF87-219</small>	Push-lock, turn-reset with square bezel <i>See page 04/215</i> 	AH165-2YVL  <small>AF87-218</small>

Note: : *See page 04/292*

■ **Pushbutton switches**













Operator	Type	Operator	Type	Operator	Type
Flush round head <i>See page 04/216</i> 	AH165-2F, 2F5  <small>AF87-211</small>	Extended round head <i>See page 04/216</i> 	AH165-2E, 2E5  <small>AF87-210</small>	Mushroom head <i>See page 04/216</i> 	AH165-2M  <small>AF87-215</small>
Mushroom head with square bezel <i>See page 04/216</i> 	AH165-2YM  <small>AF87-214</small>	Flush square head <i>See page 04/216</i> 	AH165-2SF, 2SF5  <small>AF87-201</small>	Concave square head <i>See page 04/216</i> 	AH165-2SCE, 2SCE5  <small>AF87-199</small>
Extended square head <i>See page 04/216</i> 	AH165-2SE, 2SE5  <small>AF87-200</small>	With selector ring <i>See page 04/217</i> 	AH165-2S2  <small>AF87-207</small>	With selector ring with square bezel <i>See page 04/217</i> 	AH165-2YS2  <small>AF87-206</small>
Push-lock, turn-reset <i>See page 04/217</i> 	AH165-2V  <small>AF87-217</small>	Push-lock, turn-reset with square bezel <i>See page 04/217</i> 	AH165-2YV  <small>AF87-216</small>		

Pushbuttons/Selectors/Pilot Lights/Buzzers

AH164, AH165 and AH165-2

Quick reference guide









■ Selector switches

Operator	Type	Operator	Type	Operator	Type
Knob	AH165-2P  KKD07-232	Knob with square bezel	AH165-2YP  KKD07-234	Key	AH165-2J  KKD09-003L
<i>See page 04/218</i> 		<i>See page 04/218</i> 		<i>See page 04/218</i> 	
Key with square bezel	AH165-2YJ  KKD09-003R	Lever	AH165-2H  AF87-209	Lever with square bezel	AH165-2SH  AF87-203
<i>See page 04/218</i> 		<i>See page 04/219</i> 		<i>See page 04/219</i> 	

■ Illuminated selector switches

Operator	Type
Knob	AH165-2PL  KKD07-240
<i>See page 04/221</i> 	

■ Pilot lights

Lens	Type	Lens	Type	Lens	Type
Flush round	AH165-2Z  AF87-213	Extended round	AH165-2ZE  AF87-212	Flush square	AH165-2SZ  AF87-205
<i>See page 04/222</i> 		<i>See page 04/222</i> 		<i>See page 04/222</i> 	
Extended square	AH165-2SZE  AF87-204				
<i>See page 04/222</i> 					

Note: (CCC): See page 04/292

Pushbuttons/Selectors/Pilot Lights

AH165-2

Type number nomenclature

■ Type number nomenclature

Pushbuttons, illuminated pushbuttons and pilot lights

AH165-2 FL R 11 E 3 - W
 ① ② ③ ④ ⑤ ⑥ ⑦

① Product category

AH165-2: Oil-tight (Large operator)

② Operator or lens

• Operator for illuminated pushbutton

FL: Flush round head
 FL5: Flush round head (Alternate)
 SFL: Flush square head
 SFL5: Flush square head (Alternate)
 EL: Extended round head
 EL5: Extended round head (Alternate)
 SEL: Extended square head
 SEL5: Extended square head (Alternate)
 SCL: Concave square head
 SCL5: Concave square head (Alternate)
 ML: Mushroom head
 YML: Mushroom head with square bezel
 VL: Push-lock, turn-reset
 YVL: Push-lock, turn-reset with square bezel

• Operator for pushbuttons

F: Flush round head
 F5: Flush round head (Alternate)
 SF: Flush square head
 SF5: Flush square head (Alternate)
 E: Extended round head
 E5: Extended round head (Alternate)
 SE: Extended square head
 SE5: Extended square head (Alternate)
 SCE: Concave square head
 SCE5: Concave square head (Alternate)
 M: Mushroom head
 YM: Mushroom head with square bezel
 V: Push-lock, turn-reset
 YV: Push-lock, turn-reset with square bezel
 S2: With selector ring
 YS2: With selector ring with square bezel

• Lens for pilot lights

Z: Flush round
 SZ: Flush square
 ZE: Extended round
 SEZ: Extended square

③ Color of button or lens

Code	Color	Button	LED	Incandescent	Neon
G	Green	○	○	○	○
R	Red	○	○	○	○ (Orange)
B	Black*	○	—	—	—
Y	Yellow	○	○	○	○ (Orange)
W	White	○	○ (Orange)	○	○ (Orange)
S	Blue	○	○	○	○ (Green)
O	Orange	○	○ (Amber)	○	○

Notes: • (): indicates luminous color

* Not available for illuminated types

④ Contact arrangement (except pilot lights)

11: 1NO+1NC
 22: 2NO+2NC
 33: 3NO+3NC

⑤ Lamp voltage

Code	LED	Incandescent	Neon
AA	5V DC	—	—
A	6V DC	5V AC/DC	—
B	12V DC	12V AC/DC	—
E	24V DC	24V AC/DC	—
H	—	—	110V AC
K	—	—	120V AC
M	—	—	220V AC
P	—	—	240V AC

⑥ Type of lamp

Blank: Incandescent

1: Neon

3: Flat LED

⑦ Terminal

Blank: Solder/tab

W: Wire-wrap

■ **Type number nomenclature**

Selector switches

AH165-2 J 2 B 11 A - W
 ① ② ③ ④ ⑤ ⑥ ⑦

① **Product category**
 AH165-2: Oil-tight (Large operator)

② **Operator**
 • Knob and key type
 2-position (operating angle 90°)
 P: Knob
 YP: Knob with square bezel
 J: Key
 YJ: Key with square bezel

3-position (operating angle 45°)
 P: Knob
 YP: Knob with square bezel
 J: Key
 YJ: Key with square bezel

• Lever type
 2-position (operating angle 45°)
 H: Lever
 SH: Lever with square bezel
 Note: The operation angle is 45° on the upper and lower side.

③ **Operation**
 2: 2-position, maintained
 0: 2-position, spring return*
 3: 3-position, maintained
 6: 3-position, spring/manual return (Left to center)
 7: 3-position, spring/manual return (Right to center)
 1: 3-position, spring return
 Note: * Except for H and SH types

④ **Color of knob, lever or key removable position**

• Color of knob or lever
 B: Black

• Key removable position

Code	2-position		3-position			
	2	0	1	3	6	7
A	⊙	⊙	—	⊙	—	⊙
B	⊗	—	—	⊗	—	—
C	—	—	—	⊗	—	—
D	⊙	—	—	⊙	—	—
E	—	—	①			
F	—	—	—	⊙	—	—
G	—	—	—	⊙	—	⊙

⑤ **Contact arrangement**

11: 1NO+1NC*
 22: 2NO+2NC
 33: 3NO+3NC
 Note: * Except for 3-position

⑥ **Key type No.**

A (standard), B, C, D, E, F

⑦ **Terminal**

Blank: Solder/tab
 W: Wire-wrap

Illuminated selector switches

AH165-2 PL 2 G 11 E 3
 ① ② ③ ④ ⑤ ⑥ ⑦

① **Product category**
 AH165-2: Oil-tight (Large operator)

② **Operator**
 • 2-position (operating angle 90°)
 PL: Knob

• 3-position (operating angle 45°)
 PL: Knob

③ **Operation**

2: 2-position, maintained
 3: 3-position, maintained

④ **Color of knob**

Code	Color	LED	Incandescent	Neon
G	Green	○	○	○
R	Red	○	○	○ (Orange)
Y	Yellow	○	○	○ (Orange)
W	White	○ (Orange)	○	○ (Orange)
S	Blue	○	○	○ (Green)
O	Orange	○ (Amber)	○	○

Notes: • () : indicates luminous color
 • The part other than the arrow of the knob is black.

⑤ **Contact arrangement**

11: 1NO+1NC*
 22: 2NO+2NC
 Note: * Except for 3-position

⑥ **Lamp voltage**

Code	LED	Incandescent	Neon
AA	5V DC	—	—
A	6V DC	5V AC/DC	—
B	12V DC	12V AC/DC	—
E	24V DC	24V AC/DC	—
H	—	—	110V AC
K	—	—	120V AC
M	—	—	220V AC
P	—	—	240V AC

⑦ **Type of lamp**

Blank: Incandescent
 1: Neon
 3: Flat LED
 Note: Terminal with solder/tab only

Pushbuttons/Selectors/Pilot Lights

AH165-2

Ratings and specifications

■ Standards approved

UL508	File No. E44592
CSA C22.2 No.14	File No. LR20479 (except for AH165-2Z, 2ZE, 2SZ, 2SZE) File No. LR84365 (for AH165-2Z, 2ZE, 2SZ, 2SZE)
TÜV: EN60947-5-1	Pushbutton, illuminated pushbutton: R9250087 Selector (except for AH165-2H, SH), illuminated selector: R9250088 Selector (for AH165-2H, SH): R9250087 Pilot lights: R9250089

■ Specifications (Indoor use)

Item	AH165-2	
Rated insulation voltage	250V AC/DC	
Ambient temperature (no condensation or no icing)	-10 to +70°C *1	
Humidity	45 to 85%RH (at -5 to +40°C), no condensation or no icing	
Durability (operations)	Mechanical	Pushbutton and illuminated pushbutton switch Momentary action: 1 million Alternate action: 250,000 Push-lock, turn-reset: 100,000 With selector ring: 250,000
	Electrical	Selector and illuminated selector switch: 250,000*2 100,000 (220V AC 0.7A)
Dielectric strength	2000V AC, 1 minute (Between lamp and contact terminals: 1500V AC, 1 minute)	
Conditional short-circuit current	1000A	
Short-circuit protective device	Fuse 1A	
Pollution degree	3	
Vibration	Resonance: 10 to 55Hz, double amplitude 0.1mm Constant: 16.7Hz, double amplitude 3mm	
Shock	Malfunction durability: 100m/s ² Mechanical durability: 500m/s ²	
Operating frequency	1200 operation/hour (on-load factor: 40%)	
Insulation resistance	100MΩ or more (500V DC megger)	
Operator protection	IP65	

Notes: *1 For illuminated pushbutton, illuminated selector switch and pilot light: -10 to +55°C

*2 Key insertion/removal durability for selector switch key types: 10,000

■ Contact ratings

See page 04/194

■ Lamp ratings







Rated operational voltage	Consumption		
	LED DC	Incandescent AC/DC	Neon AC
5V	7mA (Yellow: 28mA)	0.45W (6V)	—
6V	7mA (Yellow: 28mA)	—	—
12V	7mA	0.55W (14V)	—
24V	7mA	0.55W (28V)	—
110V	—	—	0.19VA
120V	—	—	0.21VA
220V	—	—	0.38VA
240V	—	—	0.42VA

Notes: For the incandescent lamps, the values in parentheses indicate the rated voltage of the lamps.

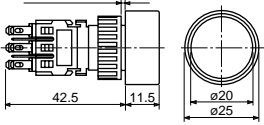
■ Contact reliability

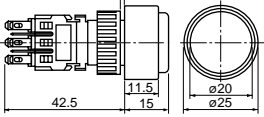
FUJI has confirmed that the unit can be used in 1mA circuit conditions at 5V AC or DC. The operable range may vary depending on the ambient conditions and type of load.

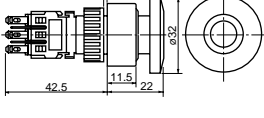
■ **Illuminated pushbutton switches**

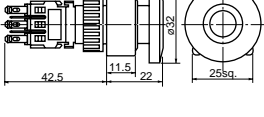



Operator	Lamp	Voltage	Contact	Momentary action	Alternate action	Dimensions, mm		
				Type	Type			
 AF87-211	Flat LED	24V DC	1NO+1NC 2NO+2NC 3NO+3NC	AH165-2FL□11E3 AH165-2FL□22E3 AH165-2FL□33E3	AH165-2FL5□11E3 AH165-2FL5□22E3 AH165-2FL5□33E3	Panel thickness 1 to 5 		
	Incandescent	24V AC/DC	1NO+1NC 2NO+2NC 3NO+3NC	AH165-2FL□11E AH165-2FL□22E AH165-2FL□33E	AH165-2FL5□11E AH165-2FL5□22E AH165-2FL5□33E			
	Neon	110V AC	1NO+1NC 2NO+2NC 3NO+3NC	AH165-2FL□11H1 AH165-2FL□22H1 AH165-2FL□33H1	AH165-2FL5□11H1 AH165-2FL5□22H1 AH165-2FL5□33H1			
		220V AC	1NO+1NC 2NO+2NC 3NO+3NC	AH165-2FL□11M1 AH165-2FL□22M1 AH165-2FL□33M1	AH165-2FL5□11M1 AH165-2FL5□22M1 AH165-2FL5□33M1			
	 AF87-210	Flat LED	24V DC	1NO+1NC 2NO+2NC 3NO+3NC	AH165-2EL□11E3 AH165-2EL□22E3 AH165-2EL□33E3		AH165-2EL5□11E3 AH165-2EL5□22E3 AH165-2EL5□33E3	Panel thickness 1 to 5 
		Incandescent	24V AC/DC	1NO+1NC 2NO+2NC 3NO+3NC	AH165-2EL□11E AH165-2EL□22E AH165-2EL□33E		AH165-2EL5□11E AH165-2EL5□22E AH165-2EL5□33E	
Neon		110V AC	1NO+1NC 2NO+2NC 3NO+3NC	AH165-2EL□11H1 AH165-2EL□22H1 AH165-2EL□33H1	AH165-2EL5□11H1 AH165-2EL5□22H1 AH165-2EL5□33H1			
		220V AC	1NO+1NC 2NO+2NC 3NO+3NC	AH165-2EL□11M1 AH165-2EL□22M1 AH165-2EL□33M1	AH165-2EL5□11M1 AH165-2EL5□22M1 AH165-2EL5□33M1			
 AF87-221		Flat LED	24V DC	1NO+1NC 2NO+2NC 3NO+3NC	AH165-2ML□11E3 AH165-2ML□22E3 AH165-2ML□33E3	— — —	Panel thickness 1 to 5 	
		Incandescent	24V AC/DC	1NO+1NC 2NO+2NC 3NO+3NC	AH165-2ML□11E AH165-2ML□22E AH165-2ML□33E	— — —		
	Neon	110V AC	1NO+1NC 2NO+2NC 3NO+3NC	AH165-2ML□11H1 AH165-2ML□22H1 AH165-2ML□33H1	— — —			
		220V AC	1NO+1NC 2NO+2NC 3NO+3NC	AH165-2ML□11M1 AH165-2ML□22M1 AH165-2ML□33M1	— — —			
	 AF87-220	Flat LED	24V DC	1NO+1NC 2NO+2NC 3NO+3NC	AH165-2YML□11E3 AH165-2YML□22E3 AH165-2YML□33E3	— — —		Panel thickness 1 to 5 
		Incandescent	24V AC/DC	1NO+1NC 2NO+2NC 3NO+3NC	AH165-2YML□11E AH165-2YML□22E AH165-2YML□33E	— — —		
Neon		110V AC	1NO+1NC 2NO+2NC 3NO+3NC	AH165-2YML□11H1 AH165-2YML□22H1 AH165-2YML□33H1	— — —			
		220V AC	1NO+1NC 2NO+2NC 3NO+3NC	AH165-2YML□11M1 AH165-2YML□22M1 AH165-2YML□33M1	— — —			

Note: Replace the □ mark by the following color code, see page 04/215.

Illuminated Pushbutton Switches

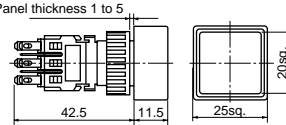

AH165-2

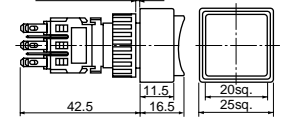
■ Illuminated pushbutton switches

Operator	Lamp	Voltage	Contact	Momentary action	Alternate action	Dimensions, mm		
				Type	Type			
 <p>AF87-201</p>	Flat LED	24V DC	1NO+1NC 2NO+2NC 3NO+3NC	AH165-2SFL□11E3 AH165-2SFL□22E3 AH165-2SFL□33E3	AH165-2SFL5□11E3 AH165-2SFL5□22E3 AH165-2SFL5□33E3			
	Incandescent	24V AC/DC	1NO+1NC 2NO+2NC 3NO+3NC	AH165-2SFL□11E AH165-2SFL□22E AH165-2SFL□33E	AH165-2SFL5□11E AH165-2SFL5□22E AH165-2SFL5□33E			
	Neon	110V AC	1NO+1NC 2NO+2NC 3NO+3NC	AH165-2SFL□11H1 AH165-2SFL□22H1 AH165-2SFL□33H1	AH165-2SFL5□11H1 AH165-2SFL5□22H1 AH165-2SFL5□33H1			
		220V AC	1NO+1NC 2NO+2NC 3NO+3NC	AH165-2SFL□11M1 AH165-2SFL□22M1 AH165-2SFL□33M1	AH165-2SFL5□11M1 AH165-2SFL5□22M1 AH165-2SFL5□33M1			
	 <p>AF87-200</p>	Flat LED	24V DC	1NO+1NC 2NO+2NC 3NO+3NC	AH165-2SEL□11E3 AH165-2SEL□22E3 AH165-2SEL□33E3		AH165-2SEL5□11E3 AH165-2SEL5□22E3 AH165-2SEL5□33E3	
		Incandescent	24V AC/DC	1NO+1NC 2NO+2NC 3NO+3NC	AH165-2SEL□11E AH165-2SEL□22E AH165-2SEL□33E		AH165-2SEL5□11E AH165-2SEL5□22E AH165-2SEL5□33E	
Neon		110V AC	1NO+1NC 2NO+2NC 3NO+3NC	AH165-2SEL□11H1 AH165-2SEL□22H1 AH165-2SEL□33H1	AH165-2SEL5□11H1 AH165-2SEL5□22H1 AH165-2SEL5□33H1			
		220V AC	1NO+1NC 2NO+2NC 3NO+3NC	AH165-2SEL□11M1 AH165-2SEL□22M1 AH165-2SEL□33M1	AH165-2SEL5□11M1 AH165-2SEL5□22M1 AH165-2SEL5□33M1			
 <p>AF87-199</p>		Flat LED	24V DC	1NO+1NC 2NO+2NC 3NO+3NC	AH165-2SCL□11E3 AH165-2SCL□22E3 AH165-2SCL□33E3	AH165-2SCL5□11E3 AH165-2SCL5□22E3 AH165-2SCL5□33E3		
		Incandescent	24V AC/DC	1NO+1NC 2NO+2NC 3NO+3NC	AH165-2SCL□11E AH165-2SCL□22E AH165-2SCL□33E	AH165-2SCL5□11E AH165-2SCL5□22E AH165-2SCL5□33E		
	Neon	110V AC	1NO+1NC 2NO+2NC 3NO+3NC	AH165-2SCL□11H1 AH165-2SCL□22H1 AH165-2SCL□33H1	AH165-2SCL5□11H1 AH165-2SCL5□22H1 AH165-2SCL5□33H1			
		220V AC	1NO+1NC 2NO+2NC 3NO+3NC	AH165-2SCL□11M1 AH165-2SCL□22M1 AH165-2SCL□33M1	AH165-2SCL5□11M1 AH165-2SCL5□22M1 AH165-2SCL5□33M1			

Note: Replace the □ mark by the following color code, see page 04/215.

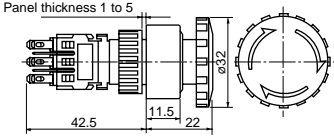
■ **Illuminated pushbutton switches**

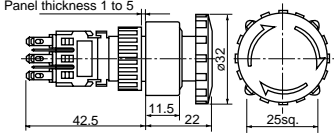
Operator	Lamp	Voltage	Contact	Type	Dimensions, mm			
 AF87-219	Push-lock, turn-reset	Flat LED	24V DC	1NO+1NC 2NO+2NC 3NO+3NC	AH165-2VL□11E3 AH165-2VL□22E3 AH165-2VL□33E3			
		Incandescent	24V AC/DC	1NO+1NC 2NO+2NC 3NO+3NC	AH165-2VL□11E AH165-2VL□22E AH165-2VL□33E			
		Neon	110V AC	1NO+1NC 2NO+2NC 3NO+3NC	AH165-2VL□11H1 AH165-2VL□22H1 AH165-2VL□33H1			
			220V AC	1NO+1NC 2NO+2NC 3NO+3NC	AH165-2VL□11M1 AH165-2VL□22M1 AH165-2VL□33M1			
	 AF87-218	Push-lock, turn-reset with square bezel	Flat LED	24V DC	1NO+1NC 2NO+2NC 3NO+3NC		AH165-2YVL□11E3 AH165-2YVL□22E3 AH165-2YVL□33E3	
			Incandescent	24V AC/DC	1NO+1NC 2NO+2NC 3NO+3NC		AH165-2YVL□11E AH165-2YVL□22E AH165-2YVL□33E	
		Neon	110V AC	1NO+1NC 2NO+2NC 3NO+3NC	AH165-2YVL□11H1 AH165-2YVL□22H1 AH165-2YVL□33H1			
			220V AC	1NO+1NC 2NO+2NC 3NO+3NC	AH165-2YVL□11M1 AH165-2YVL□22M1 AH165-2YVL□33M1			

04

• **Button color**

Replace the □ mark by the following button color code

Color	Green	Red	White	Yellow	Blue	Orange
Code	G	R	W	Y	S	O

• With wire-wrap pin terminals have a depth of 47mm.

- A white illuminated pushbutton is fitted with a transparent color lens.
- The color lens is made of a tinted transparent material.

• **Lamp voltage**











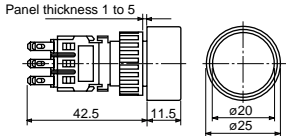

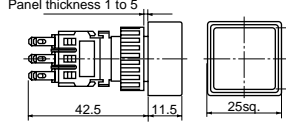
Voltages other than above are available

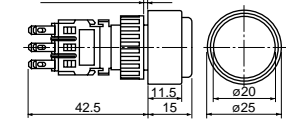
Code	LED	Incandescent	Neon
AA	5V DC	—	—
A	6V DC	5V AC/DC	—
B	12V DC	12V AC/DC	—
K	—	—	120V AC
P	—	—	240V AC

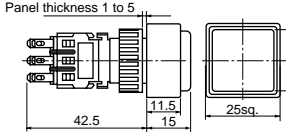
Pushbutton Switches

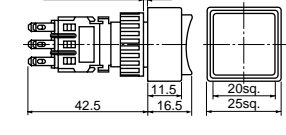

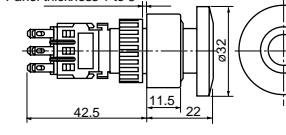

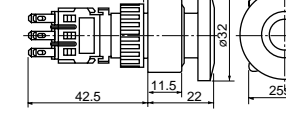

AH165-2

■ Pushbutton switches

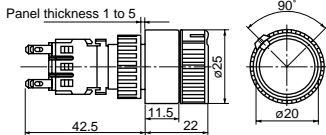
Operator	Contact	Momentary action	Alternate action	Dimensions, mm
		Type	Type	
 <p>AF87-211</p>	1NO+1NC	AH165-2F□11	AH165-2F5□11	
	2NO+2NC	AH165-2F□22	AH165-2F5□22	
	3NO+3NC	AH165-2F□33	AH165-2F5□33	
 <p>AF87-201</p>	1NO+1NC	AH165-2SF□11	AH165-2SF5□11	
	2NO+2NC	AH165-2SF□22	AH165-2SF5□22	
	3NO+3NC	AH165-2SF□33	AH165-2SF5□33	
 <p>AF87-210</p>	1NO+1NC	AH165-2E□11	AH165-2E5□11	
	2NO+2NC	AH165-2E□22	AH165-2E5□22	
	3NO+3NC	AH165-2E□33	AH165-2E5□33	
 <p>AF87-200</p>	1NO+1NC	AH165-2SE□11	AH165-2SE5□11	
	2NO+2NC	AH165-2SE□22	AH165-2SE5□22	
	3NO+3NC	AH165-2SE□33	AH165-2SE5□33	
 <p>AF87-199</p>	1NO+1NC	AH165-2SCE□11	AH165-2SCE5□11	
	2NO+2NC	AH165-2SCE□22	AH165-2SCE5□22	
	3NO+3NC	AH165-2SCE□33	AH165-2SCE5□33	
 <p>AF87-215</p>	1NO+1NC	AH165-2M□11	—	
	2NO+2NC	AH165-2M□22	—	
	3NO+3NC	AH165-2M□33	—	
 <p>AF87-214</p>	1NO+1NC	AH165-2YM□11	—	
	2NO+2NC	AH165-2YM□22	—	
	3NO+3NC	AH165-2YM□33	—	

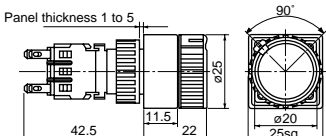
Note: Replace the □ mark by the following color code, see page 04/217.

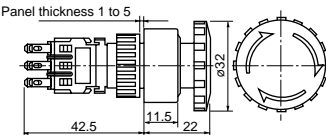
■ Pushbutton switches

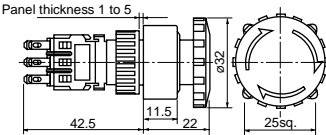
Operator	Contact	Type	Dimensions, mm
 <p>AF87-207</p>	2NO+2NC	AH165-2S2□22	
 <p>AF87-206</p>	2NO+2NC	AH165-2YS2□22	
 <p>AF87-210</p>	1NO+1NC 2NO+2NC 3NO+3NC	AH165-2V□11 AH165-2V□22 AH165-2V□33	
 <p>AF87-200</p>	1NO+1NC 2NO+2NC 3NO+3NC	AH165-2YV□11 AH165-2YV□22 AH165-2YV□33	



• Button color

Replace the □ mark by the following button color code

Color	Green	Red	Black	White	Blue	Yellow	Orange
Code	G	R	B	W	S	Y	O

• Contact arrangement and operator position

AH165-2S, 2YS

Button	Ring	Left	Right
			
Free		U L 1O ——— 02 1O ——— 02 3O 04 3O 04	U L 1O ——— 02 1O ——— 02 3O 04 3O 04
Depressed		1O ——— 02 1O ——— 02 3O 04 3O 04	1O ——— 02 1O 02 3O 04 3O ——— 04

U: Upper contact block
L: Lower contact block





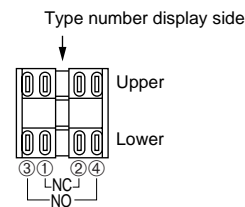

- The color lens is made of a tinted transparent material. (Except for M, YM, V, YV, types)
- A white pushbutton is fitted with a transparent color lens. A black pushbutton consists of a transparent color lens and an attached black legend plate. (Except for M, YM, V, YV, types)
- With wire-wrap pin terminals have a depth of 47mm.

• Terminal number and contact block position

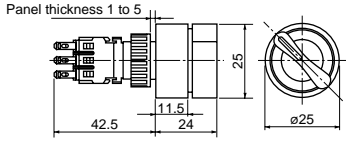

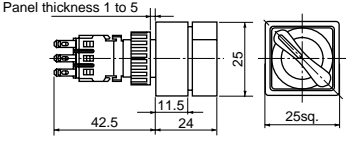
Selector Switches AH165-2

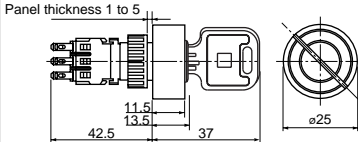
■ Selector switches/2-position (90-degree)

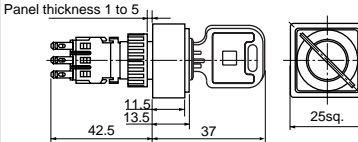
Operator	Operation	Key removable position	Contact	Type	Dimensions, mm
 KKD07-232	Maintained	—	1NO+1NC 2NO+2NC 3NO+3NC	AH165-2P2B11 AH165-2P2B22 AH165-2P2B33	
	Spring return	—	1NO+1NC 2NO+2NC 3NO+3NC	AH165-2P0B11 AH165-2P0B22 AH165-2P0B33	
 KKD07-234	Maintained	—	1NO+1NC 2NO+2NC 3NO+3NC	AH165-2YP2B11 AH165-2YP2B22 AH165-2YP2B33	
	Spring return	—	1NO+1NC 2NO+2NC 3NO+3NC	AH165-2YP0B11 AH165-2YP0B22 AH165-2YP0B33	
 KKD09-003L	Maintained	⊖ A	1NO+1NC 2NO+2NC 3NO+3NC	AH165-2J2A11A AH165-2J2A22A AH165-2J2A33A	
		⊗ B	1NO+1NC 2NO+2NC 3NO+3NC	AH165-2J2B11A AH165-2J2B22A AH165-2J2B33A	
		⊘ D	1NO+1NC 2NO+2NC 3NO+3NC	AH165-2J2D11A AH165-2J2D22A AH165-2J2D33A	
	Spring return	⊖ A	1NO+1NC 2NO+2NC 3NO+3NC	AH165-2J0A11A AH165-2J0A22A AH165-2J0A33A	
		⊗ B	1NO+1NC 2NO+2NC 3NO+3NC	AH165-2YJ2B11A AH165-2YJ2B22A AH165-2YJ2B33A	
		⊘ D	1NO+1NC 2NO+2NC 3NO+3NC	AH165-2YJ2D11A AH165-2YJ2D22A AH165-2YJ2D33A	
 KKD09-003R	Maintained	⊖ A	1NO+1NC 2NO+2NC 3NO+3NC	AH165-2YJ2A11A AH165-2YJ2A22A AH165-2YJ2A33A	
		⊗ B	1NO+1NC 2NO+2NC 3NO+3NC	AH165-2YJ2B11A AH165-2YJ2B22A AH165-2YJ2B33A	
		⊘ D	1NO+1NC 2NO+2NC 3NO+3NC	AH165-2YJ2D11A AH165-2YJ2D22A AH165-2YJ2D33A	
	Spring return	⊖ A	1NO+1NC 2NO+2NC 3NO+3NC	AH165-2YJ0A11A AH165-2YJ0A22A AH165-2YJ0A33A	

• The key can be removed only at the following positions:

A: ⊖ B: ⊗ D: ⊘

- For spring-return selector switches, the key can be removed at position A.
- There are 6 available key types; A, B, C, D, E and F. Standard key code is A.
- With wire-wrap pin terminals have a depth of 47mm.

• Terminal number and contact block position

Type number display side

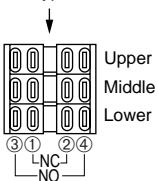

Contact arrangement (terminal No.: common)

- 1NO+1NC: Middle
- 2NO+2NC: Upper, lower
- 3NO+3NC: Upper, middle, lower



• Contact arrangement and operator positions:

2-position

Contact arrangement	1NO+1NC	2NO+2NC	3NO+3NC	
Operator position	Left	M 1O ——— 02 3O ——— 04	U 1O ——— 02 3O ——— 04 L 1O ——— 02 3O ——— 04	U 1O ——— 02 3O ——— 04 M 1O ——— 02 3O ——— 04 L 1O ——— 02 3O ——— 04
	Right	M 1O ——— 02 3O ——— 04	U 1O ——— 02 3O ——— 04 L 1O ——— 02 3O ——— 04	U 1O ——— 02 3O ——— 04 M 1O ——— 02 3O ——— 04 L 1O ——— 02 3O ——— 04

U: Upper contact block
M: Middle contact block
L: Lower contact block

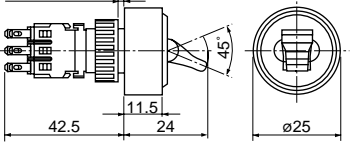
■ Selector switches/2-position

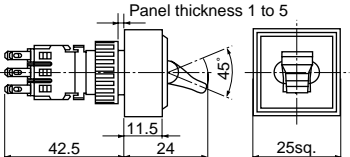
Operator	Lever color	Operation	Contact	Type	Dimensions, mm
 AF87-209	Black	Maintained	1NO+1NC 2NO+2NC 3NO+3NC	AH165-2H2B11 AH165-2H2B22 AH165-2H2B33	Panel thickness 1 to 5 
 AF87-203	Black	Maintained	1NO+1NC 2NO+2NC 3NO+3NC	AH165-2SH2B11 AH165-2SH2B22 AH165-2SH2B33	Panel thickness 1 to 5 

04

• Contact arrangement and operator position

AH165-2H, 2SH

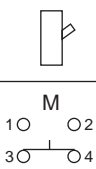
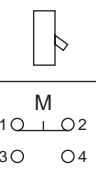
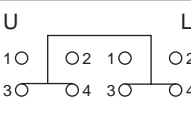
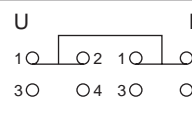
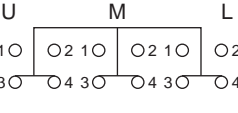
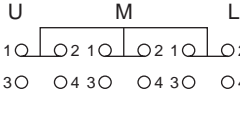
Contact block	Lever	
	Up	Down
1NO+1NC		
2NO+2NC		
3NO+3NC		

U: Upper contact block
M: Middle contact block
L: Lower contact block

• Terminal number and contact block position

Type number display side

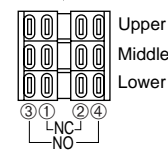





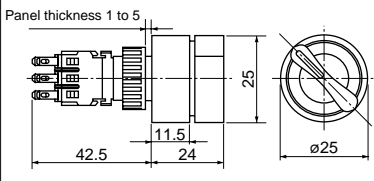

Contact arrangement (terminal No.: common)
 1NO+1NC: Middle
 2NO+2NC: Upper, lower
 3NO+3NC: Upper, middle, lower

- With wire-wrap pin terminals have a depth of 47mm.

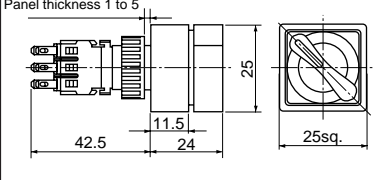
Selector Switches AH165-2

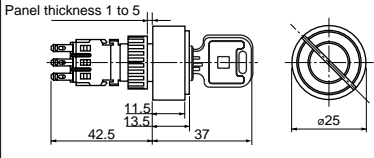
■ Selector switches/3-position (45-degree)

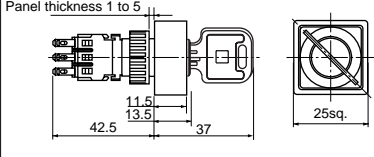
Operator	Operation	Key removable position	Contact	Type	Dimensions, mm		
 KKD07-233	Maintained	—	2NO+2NC 3NO+3NC	AH165-2P3B22 AH165-2P3B33			
	Spring/ manual return	⌚	2NO+2NC 3NO+3NC	AH165-2P6B22 AH165-2P6B33			
	Spring/ manual return	⌚	2NO+2NC 3NO+3NC	AH165-2P7B22 AH165-2P7B33			
	Spring return	⌚	2NO+2NC 3NO+3NC	AH165-2P1B22 AH165-2P1B33			
 KKD07-235	Maintained	—	2NO+2NC 3NO+3NC	AH165-2YP3B22 AH165-2YP3B33			
	Spring/ manual return	⌚	2NO+2NC 3NO+3NC	AH165-2YP6B22 AH165-2YP6B33			
	Spring/ manual return	⌚	2NO+2NC 3NO+3NC	AH165-2YP7B22 AH165-2YP7B33			
	Spring return	⌚	2NO+2NC 3NO+3NC	AH165-2YP1B22 AH165-2YP1B33			
 KKD09-003R	Maintained	⌚ A	2NO+2NC 3NO+3NC	AH165-2J3A22A AH165-2J3A33A			
		⌚ E	2NO+2NC 3NO+3NC	AH165-2J3E22A AH165-2J3E33A			
		⌚ D	2NO+2NC 3NO+3NC	AH165-2J3D22A AH165-2J3D33A			
		⌚ C	2NO+2NC 3NO+3NC	AH165-2J3C22A AH165-2J3C33A			
	Spring/ manual return	⌚ E	2NO+2NC 3NO+3NC	AH165-2J6E22A AH165-2J6E33A			
		⌚ D	2NO+2NC 3NO+3NC	AH165-2J6D22A AH165-2J6D33A			
	Spring/ manual return	⌚ A	2NO+2NC 3NO+3NC	AH165-2J7A22A AH165-2J7A33A			
		⌚ E	2NO+2NC 3NO+3NC	AH165-2J7E22A AH165-2J7E33A			
	Spring return	⌚ E	2NO+2NC 3NO+3NC	AH165-2J1E22A AH165-2J1E33A			
	 KKD09-003L	Maintained	⌚ A	2NO+2NC 3NO+3NC		AH165-2YJ3A22A AH165-2YJ3A33A	
			⌚ E	2NO+2NC 3NO+3NC		AH165-2YJ3E22A AH165-2YJ3E33A	
			⌚ D	2NO+2NC 3NO+3NC		AH165-2YJ3D22A AH165-2YJ3D33A	
⌚ C			2NO+2NC 3NO+3NC	AH165-2YJ3C22A AH165-2YJ3C33A			
Spring/ manual return		⌚ E	2NO+2NC 3NO+3NC	AH165-2YJ6E22A AH165-2YJ6E33A			
		⌚ D	2NO+2NC 3NO+3NC	AH165-2YJ6D22A AH165-2YJ6D33A			
Spring/ manual return		⌚ A	2NO+2NC 3NO+3NC	AH165-2YJ7A22A AH165-2YJ7A33A			
		⌚ E	2NO+2NC 3NO+3NC	AH165-2YJ7E22A AH165-2YJ7E33A			
Spring return		⌚ E	2NO+2NC 3NO+3NC	AH165-2YJ1E22A AH165-2YJ1E33A			

• The Key can be removed at the following positions:

A: ⌚ B: ⊗ C: ⊛ D: ⌚ E: ⌚ F: ⌚ G: ⊛

For spring-return selector switches, the key can be removed only at position E. For manual/spring-return selector switches, the key can be removed at positions D, E and F for type J6, and position A, E and G for type J7.

- There are 6 available key types; A, B, C, D, E and F. Standard key code is A.
- With wire-wrap pin terminals have a depth of 47mm.

• Contact arrangement and operator positions:

Contact arrangement		2NO+2NC	3NO+3NC
Operator position	Left ⌚	1 _U 0 ₂ 1 ₀ L 0 ₂ 3 ₀ 0 ₄ 3 ₀ 0 ₄	1 _U 0 ₂ 1 ₀ M 0 ₂ 1 ₀ L 0 ₂ 3 ₀ 0 ₄ 3 ₀ 0 ₄ 3 ₀ 0 ₄
	Center ⌚	1 ₀ 0 ₂ 1 ₀ 0 ₂ 3 ₀ 0 ₄ 3 ₀ 0 ₄	1 ₀ 0 ₂ 1 ₀ 0 ₂ 1 ₀ 0 ₂ 3 ₀ 0 ₄ 3 ₀ 0 ₄ 3 ₀ 0 ₄
	Right ⌚	1 ₀ 0 ₂ 1 ₀ 0 ₂ 3 ₀ 0 ₄ 3 ₀ 0 ₄	1 ₀ 0 ₂ 1 ₀ 0 ₂ 1 ₀ 0 ₂ 3 ₀ 0 ₄ 3 ₀ 0 ₄ 3 ₀ 0 ₄

U: Upper contact block M: Middle contact block L: Lower contact block

• Contact block positions: See page 04/219

Fuji Electric FA Components & Systems Co., Ltd./D & C Catalog
Information subject to change without notice

■ Illuminated selector switches

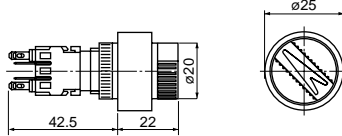
Operator	Operation	Lamp voltage	No. of positions	Contact	Type	Dimensions, mm
 <p>KKD07-240</p>	Maintained	Flat LED 24V DC	2	1NO+1NC 2NO+2NC	AH165-2PL2□11E3 AH165-2PL2□22E3	
			3	2NO+2NC	AH165-2PL3□22E3	
			2	1NO+1NC 2NO+2NC	AH165-2PL2□11E AH165-2PL2□22E	
		Incandescent 24V AC/DC	3	2NO+2NC	AH165-2PL3□22E	
			2	1NO+1NC 2NO+2NC	AH165-2PL2□11H1 AH165-2PL2□22H1	
					AH165-2PL3□22H1	
		Neon 110V AC	2	1NO+2NC 2NO+2NC	AH165-2PL2□11M1 AH165-2PL2□22M1	
			3	2NO+2NC	AH165-2PL3□22M1	
			Neon 220V AC	2	1NO+1NC 2NO+2NC	
		3		2NO+2NC	AH165-2PL3□22E3	
		2		1NO+1NC 2NO+2NC	AH165-2PL2□11E AH165-2PL2□22E	

04

• Knob color (arrow)

Replace the □ mark by the following color code

Color	Green	Red	White	Blue	Yellow	Orange
Code	G	R	W	S	Y	O

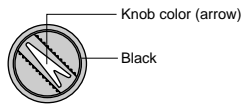

• Lamp voltage

Voltages other than above are available

Code	LED	Incandescent	Neon
AA	5V DC	—	—
A	6V DC	5V AC/DC	—
B	12V DC	12V AC/DC	—
K	—	—	120V AC
P	—	—	240V AC

• Terminal number and contact block position

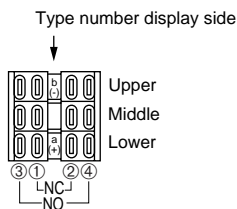

Contact arrangement (terminal No.: common)
1NO+1NC: Middle
2NO+2NC: Upper, lower

• Contact arrangement and operator positions:

2-position

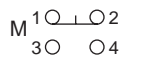
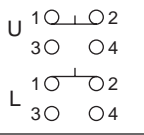
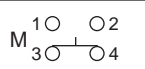
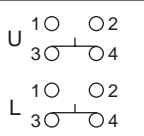
Contact arrangement	1NO+1NC	2NO+2NC
Operator position	Left (⊖)	 
	Right (⊕)	 



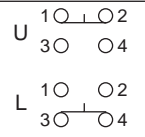
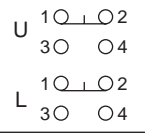
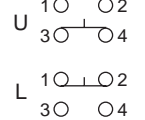



3-position

Contact arrangement	2NO+2NC	
Operator position	Left (⊖)	
	Center (⊕)	
	Right (⊕)	

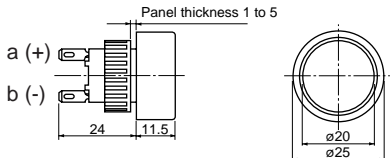
U: Upper contact block
M: Middle contact block
L: Lower contact block

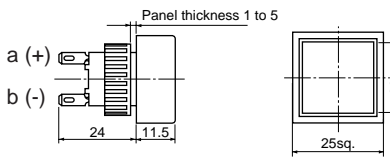
Pilot Lights AH165-2

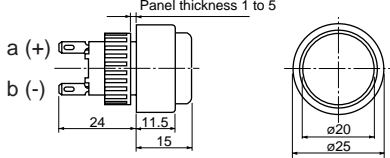
■ Pilot lights

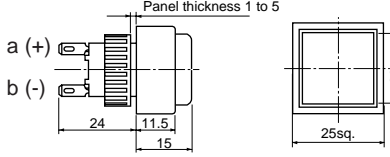
Lens	Lamp	Voltage	Type	Dimensions, mm
 AF87-213	Flat LED	24V DC	AH165-2Z□E3	
	Incandescent	24V AC/DC	AH165-2Z□E	
	Neon	110V AC	AH165-2Z□H1	
		220V AC	AH165-2Z□M1	
 AF87-205	Flat LED	24V DC	AH165-2SZ□E3	
	Incandescent	24V AC/DC	AH165-2SZ□E	
	Neon	110V AC	AH165-2SZ□H1	
		220V AC	AH165-2SZ□M1	
 AF87-212	Flat LED	24V DC	AH165-2ZE□E3	
	Incandescent	24V AC/DC	AH165-2ZE□E	
	Neon	110V AC	AH165-2ZE□H1	
		220V AC	AH165-2ZE□M1	
 AF87-204	Flat LED	24V DC	AH165-2SZE□E3	
	Incandescent	24V AC/DC	AH165-2SZE□E	
	Neon	110V AC	AH165-2SZE□H1	
		220V AC	AH165-2SZE□M1	

• Lens color

Replace the □ mark by the following lens color code

Color	Green	Red	White	Yellow	Blue	Orange
Code	G	R	W	Y	S	O

• Lamp voltage

Voltage other than above is available

Code	LED	Incandescent	Neon
AA	5V DC	—	—
A	6V DC	5V AC/DC	—
B	12V DC	12V AC/DC	—
K	—	—	120V AC
P	—	—	240V AC

- The color lens is made of a tinted transparent material.
- A white lens is fitted with a transparent color lens.
- With wire-wrap pin terminals have a depth of 29mm.

■ **Mounting space, mm**

- Illuminated pushbuttons, pushbuttons, selector switches, illuminated selector switches and pilot lights

Round head

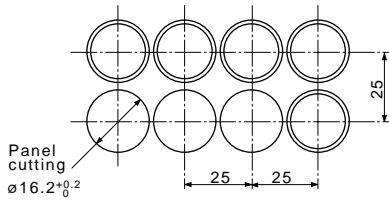

Square head

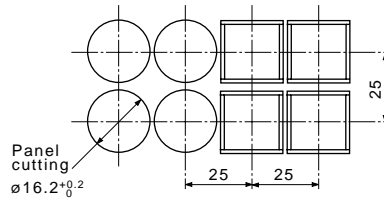

**Mushroom head
 Push-lock, turn-reset**

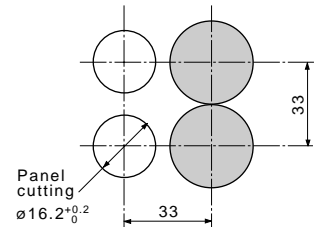

■ **Terminal number**

Type	Wiring	Terminal position
Illuminated pushbuttons, Illuminated selector switches	<p>a (+) b (-)</p> <p>① ——— ② ③ ○ ○ ④</p>	<p>Type number display side</p>
Pushbuttons Selector switches	<p>① ——— ② ③ ○ ○ ④</p>	
Pilot lights (without transformer)	<p>a (+) b (-)</p>	<p>Type number display side</p>

Pushbuttons/Selectors/Pilot Lights/Buzzers AH164, AH165 and AH165-2 Notes on use

Notes on use

■ Installation on panel

- For installation, use dedicated wrench AHX601. The appropriate tightening torque is 0.6 to 1N·cm.
- The installation sequence is as follows:
Pass the operator base through the hole in the panel and secure it by tightening the bezel. Properly position the catch arms and the catch legs of the operator base and push the contact holder onto the operator base. To remove the contact holder, pull it while pressing the catch arms inward.

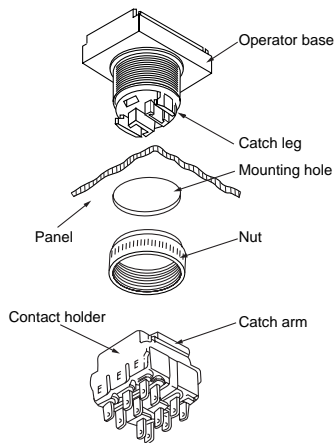

■ Mounting steps of switch with transformer

- Pass the switch operator through the panel hole and secure with a nut by way of the retainer metal from the front of the panel.
- Align the position of the catch arm of the contact block holder with that of the catch leg of the switch operator. Engage these two catches by pushing them together.
- Insert and secure the transformer unit while assembling the contact block holder with the retainer metal.
- Connect the receptacle terminal with lead wires extending from the transformer to the lamp terminal of the contact block holder. (Be care on the polarity of the LED. Red: +, Black: -)
- Push in and secure the standard accessory insulation cover by aligning its position with each terminal. To replace the transformer, remove the transformer by widening the catch leg of the contact block holder. Pay attention not to excessively widen the catch leg. Mounting steps are the same as the above steps ③, ④, and ⑤.

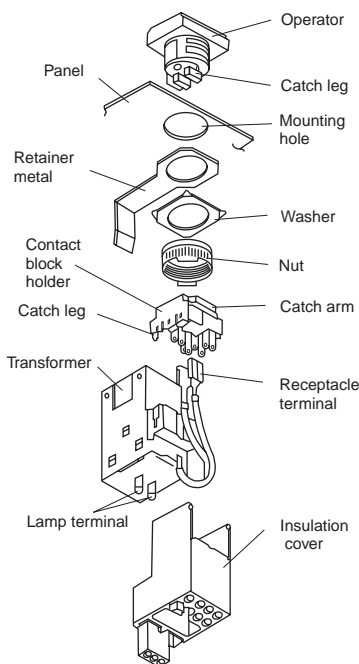

■ Installing the protection cover / dust-tight cover, guard-ring

- Be careful that the panel thickness does not exceed the following:
- Panel thickness
 - Protection cover: 2.6mm max.
 - Dust-tight cover: 2.0mm max.
 - Guard ring: 2.5mm max.

■ Operating voltage and rated voltage of incandescent lamps

Rated voltage	Operating voltage
6V	4 to 5V
14V	10 to 12V
28V (Standard)	20 to 24V

Incandescent lamps should be operated at the operating voltages if a lamp service life of 5,000 to 10,000 hours are needed. The ambient temperature must not exceed 30°C if the lamp is used at the rated voltage continuously.

■ Method of replacing lamp

- Incandescent lamps/LED lamps/neon lamps
Remove the color lens and inner button with a remover AHX618. Then draw out the lamp with a lamp changer AHX672. When installing lamps, do it manually and in the reverse order of removing.
- Products with blue and green LEDs
The LED devices on products with high-brightness (blue and green) LEDs are very sensitive to static electricity. When replacing LED lamps do not allow static electricity to come into direct contact with the metal frame on the upper side of the LED lamp. The LED device may be damaged if this part is subjected to static electricity. When installing or removing an LED lamp, it is recommended that you use the lamp changer (AHX672).

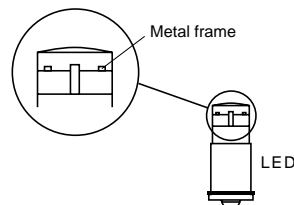

- To replace the lamp of a AH165-2 illuminated pushbutton switch (ML, VL), remove the button and draw out the oil-tight cap.

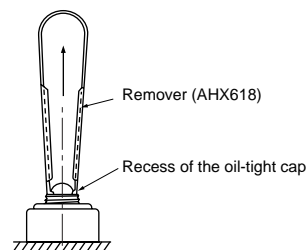

- Then, replace the lamp using a lamp changer (AHX672) and push the oil-tight cap into its original position with its engaging projection properly adjusted (see the figure below).

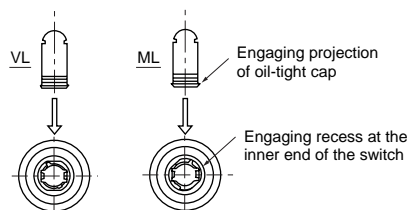

Note: Lamp of AH165-ZM type can not be replaced.

■ **Method of replacing color lens**

- To remove the color lens, insert a small screwdriver into the color lens and twist in direction of the arrow.

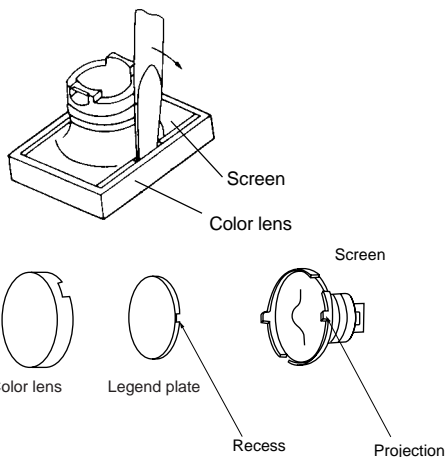

- For an AH165-2, use a small standard screwdriver or a similar tool with a flat end. If one side of the color lens is removed from the screen, insert the screwdriver or a similar tool deeper and remove the color lens together with the screen.

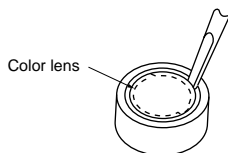

■ **Replacing pushbuttons**

In the case of alternative action type pushbutton switches and illuminated pushbutton switches, be sure not to replace the pushbuttons in their locked state. This could result in internal damage to the mechanism.

■ **Description sheet**

The Fuji description sheet is 25µm thick. If preparing custom description sheets, make sure that the thickness is 0.1mm or less.

■ **Contact block**

To replace a contact block, use removing tool AGX012. If excessive force is applied when attempting to open the support legs for the contact block holder, deformation or damage may occur.

■ **Handling precautions**

- Do not apply torque in excess of 1.0 N•m to operate the selectors switch (Type "P"). Required operating force of switches is less than 0.1 N•m.
- Do not tap on a pushbutton to turn it ON or OFF, such handling may damage it. Be sure to operate the pushbutton by hand.

■ **Key type selector switch**

- Five key types (Type B to Type F) are available besides Type A, which is the standard key type.

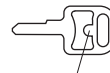

Symbol on the key



Symbol on the main unit

Be sure to use a key with a symbol which is matched with the symbol on the main unit.

- Fully insert the key into the main unit before turning the key.
- The key turning force should not exceed 0.1 N•m.
- Do not pull out or insert the key forcibly.

■ **Wiring connections**

- Use a soldering iron with a wattage of not more than 30W and a tip length of more than 20mm.

Use a rosin-core solder

With a 30W iron complete soldering within 5 seconds, or 10 seconds with a 20W iron. Do not apply external force to the terminals. Do not deform the terminals.

Because lead-free solder's melting point is slightly high, soldering work may be difficult. Use a soldering iron whose tip is rather large or whose calorie is rather high.

- Wires that can be connected
 - Two solid wires with a maximum diameter of 0.8mm (solder)
 - One stranded wire with a maximum area of 0.75mm² (solder)
- Flat connection terminal
 - (2.8□-1.25-5) 0.5 to 1.25mm²
 - (2.8□-0.5-5) 0.2 to 0.5mm²
- Using contact blocks
 - When using NO and NC contacts in the same contact block, avoid connection that involves opposite polarity or wiring from different types of power supply.
- For wiring to adjacent terminals, use insulated tubing to prevent short-circuit and to assure isolation. For solder terminals, be careful when connecting thick wires. Do not use too much solder.
- Wiring to wire-wrap pin terminals
 - Select the appropriate wire sizes and tools from the table below.

Wire size	Bit	Sleeve	Number of effective wraps
0.4mm dia.	3-A	1-B	About 8
0.5mm dia.	1-A	1-B	About 6
(0.65mm dia.)	(2-A)	(2-B)	(About 6)

Use ordinary wrapping for connection.

Wires of 0.65mm dia. must not be used on adjacent terminals. However, 0.65mm dia. wire can be mixed with 0.4 and 0.5mm dia. wires.

- Wiring to tab terminals
 - Use receptacles, No. 110.

■ **Installing lamps in close order**

When continuously lighting pilot lights or pressing illuminated pushbuttons installed in close order, care must be taken that the ambient temperature does not exceed the rated value.

Pushbuttons/Selectors/Pilot Lights/Buzzers

AH164, AH165 and AH165-2

Notes on use

■ LEDs

• LED Lamp Malfunctioning

The LED lamp is lit by a very small level of current (approximately 0.01mA). Therefore, the it may be erroneously lit by a current leaking from the surge absorption circuit or semiconductor circuit or due to stray capacitance between cables. In that case, provide a countermeasure (e.g., connect a resistor in parallel with the LED lamp).

• Countermeasure for Malfunctioning

Shunt Resistor R or CR elements connected in parallel Lamp malfunctions can be prevented by connecting a shunt resistor (R) or CR elements (a capacitor and resistor) in parallel with the LED lamp terminal. The resistance and CR values vary depending on the model and the operating conditions.

Example 1

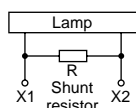

- 24V DC
R: 10k Ω (1W)

Example 2

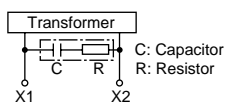

- 110V AC
C: 0.33 μ F (250V AC)
R: 120 Ω (0.25W)
- 220V AC
C: 0.33 μ F (250V AC)
R: 120 Ω (0.25W)

• Incoming surge

Be careful that since high luminance LED products use an element sensitive to static electricity, they may not be lit by an abnormal voltage like surge.

■ Using a flat LED in 48V DC circuit

When a flat LED lamps having a rated voltage of 24V DC is used with 48V DC circuit, connect an external resistor of 3,500 Ω (1W).

■ Preventing the neon lamp from incorrectly turning ON

The neon lamp may incorrectly turn ON due to current leakage or voltage induction. In such a case, connect a shunt resistor in parallel with the lamp.

Example) 110V AC: 100k (0.25W)
220V AC: 50k (2W)

If an external surge of 3kV or more may occur, connect a surge absorption element in parallel with the lamp.

■ Operation

Do not use a hitting or bouncing action to operate the button, or the switch may break. Always operate the switch by hand.

■ Storage and operation site

- Use the unit within the rated operating ambient temperature and humidity ranges.
- Do not use the enclosed type in places where oil or water is sprayed or where dust accumulates. In places such as these, use the oil-tight type or provide a dust cover.
- The oil-tight type is evaluated with standard cutting oil and cooling oil applied. The oil-tight type cannot be used with some special oils.

■ Buzzer

• Noise







If the application circuit is likely to generate excessively strong noise, connect a surge absorber (e.g., FUJI'S ENC390D, provided that the switch is a 24V type) in parallel with the buzzer.



• Place of Use

The buzzer does not have a drip-proof construction. Do not use the buzzer in places where oil or water is sprayed or where dust accumulates. If the buzzer is a splash-proof type, it will resist sprays of water.

- Do not use the buzzer in places that are subject to an excessive amount of corrosive gas.
- Be careful that the buzzer is likely to sound erroneously due to leakage current or the like.

■ Accessories for AH164 and AH165



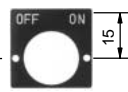
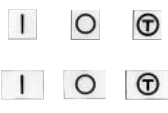

Description	Type	
Color chips (Round)	Color	Type
 <p>L, L5, E E5, Z</p>	Green	AHX631-G
	Red	AHX631-R
	White (For Neon)	AHX631-W
	Blue	AHX631-S
	Yellow	AHX631-Y
	Orange	AHX631-O
	Clear	AHX631-C
SF-682	For LED, Neon	Green AHX653-G
Color chips (Square)	Color	Type
 <p>SL, SL5, SGL, SGL5, SF, SF5, SGF, SGF5, ZS</p>	Green	AHX632-G
	Red	AHX632-R
	White (For Neon)	AHX632-W
	Blue	AHX632-S
	Yellow	AHX632-Y
	Orange	AHX632-O
	Clear	AHX632-C
SF-681	For LED, Neon	Green AHX653-SG
Color chips (Rectangular)	Color	Type
 <p>TL, TL5, TGL TGL5, TF, TF5 TGF, TGF5, ZT</p>	Green	AHX633-G
	Red	AHX633-R
	White (For Neon)	AHX633-W
	Blue	AHX633-S
	Yellow	AHX633-Y
	Orange	AHX633-O
	Clear	AHX633-C
SF-680	For LED, Neon	Green AHX653-TG
Mushroom head button	Color	Type
 <p>M, M5</p>	Green	AHX682-G
	Red	AHX682-R
	White	AHX682-W
	Blue	AHX682-S
	Yellow	AHX682-Y
	Orange	AHX682-O
	Black	AHX682-B
SI-40		
Convex square head button	Color	Type
 <p>SM, SM5</p>	Green	AHX683-G
	Red	AHX683-R
	White	AHX683-W
	Blue	AHX683-S
	Yellow	AHX683-Y
	Orange	AHX683-O
	Black	AHX683-B
SI-43		
Convex rectangular head button	Color	Type
 <p>TM, TM5</p>	Green	AHX684-G
	Red	AHX684-R
	White	AHX684-W
	Blue	AHX684-S
	Yellow	AHX684-Y
	Orange	AHX684-O
	Black	AHX684-B
SI-44		

Description	Type			
Legend sheet	Round	Type: AHX615-□ Legend: ON, OFF, UP, DOWN		
	Square	Type: AHX616-□ Legend: ON, OFF, UP, DOWN START, STOP, OPEN CLOSE, AUTO, MAN, RESET, POWER, REV, FWD, HIGH, LOW		
	Rectangular	Type: AHX617-□ Legend: ON, OFF, UP, DOWN START, STOP, AUTO, MAN, FOWARD, REVERSE		
	When ordering, specify desired legend in the □ at the end of ordering code, Transparent blank sheets are also available.			
	Use black oil ink.			
	SH-165			
	Legend plate (Acrylic resin)	Type	Color Dimensions, mm	
		Round	AHX665 White AHX665-C Transparent AHX665-B Black	ø12.2 x 0.9
		Square	AHX666 White AHX666-C Transparent AHX666-B Black	12.2sq. x 0.9
		Rectangular	AHX667 White AHX667-C Transparent AHX667-B Black	12.2 x 18.2 x 0.9
	SH-164			
Legend plate for spot LED (Acrylic resin)	Type	Dimensions, mm		
	Round	AHX650 ø12.2 x 0.9		
	Square	AHX651 12.2sq. x 0.9		
	Rectangular	AHX652 12.2 x 18.2 x 0.9		
SP-113				
Legend plate for selector switch (2-position)	Type: AHX664 Legend: ON-OFF Legend: Blank	Dimensions, mm: 24sq. x 0.5		
				
	SH-226A			
Legend plate for symbol mark	Mark	Type		
	Square	○ AHX666-E		
	Rectangular	AHX667-E		
	Square	AHX666-H		
	Rectangular	AHX667-H		
	Square	⊕ AHX666-T		
	Rectangular	AHX667-T		
AF87-74				

Pushbuttons/Selectors/Pilot Lights/Buzzers

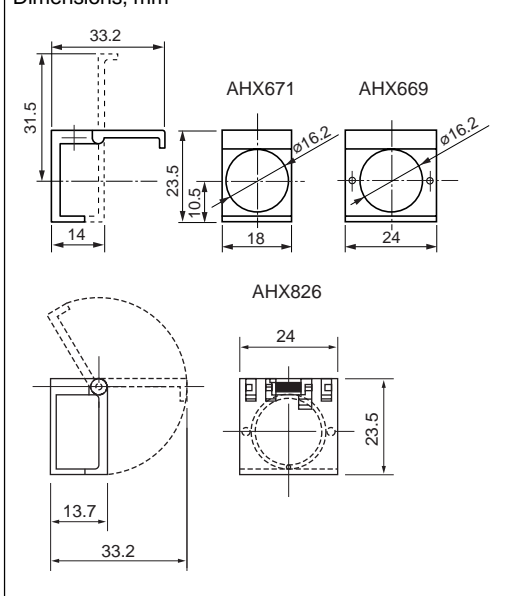
AH164 and AH165

Accessories

Description	Type															
<p>Protection cover</p>  <p>KKD07-246</p> <p>KKD07-248</p> <p>KKD07-247</p>	<p>For round and square head button Type: AHX671</p> <p>For rectangular head button Type: AHX669 AHX826</p> <p>This cover protect against accidental operation. Note: Not used for illuminated pushbuttons with guard. Applicable panel thickness is 2.6mm max.</p> <p>Dimensions, mm</p> 															
<p>Dust-tight cover</p>  <p>AF91-123, SI-41</p>	<p>For round and square head button Type: AHX822 Dimensions, mm: 24sq. x 14.2</p> <p>For rectangular head button Type: AHX668 Dimensions, mm: 24 x 30 x 14.2</p> <p>For mushroom head button Type: AHX649 Dimensions, mm: $\varnothing 30$ x 18</p> <p>These covers protect against dust. Note: Applicable panel thickness is 2.0mm max.</p>															
<p>Guard ring</p>  <p>SI-42</p>	<table border="1"> <thead> <tr> <th>Type</th> <th>Color</th> <th>Dimensions, mm</th> </tr> </thead> <tbody> <tr> <td>AHX676-B</td> <td>Black</td> <td>$\varnothing 21$ x 12</td> </tr> <tr> <td>AHX676-GY</td> <td>Gray</td> <td></td> </tr> </tbody> </table> <p>This guard ring is used in combination with an extended round head pushbutton (L or E). Note: Applicable panel thickness is 2.5mm max. Please place an order for a packing (AHX685) separately when you intend to use for AH165 series.</p>	Type	Color	Dimensions, mm	AHX676-B	Black	$\varnothing 21$ x 12	AHX676-GY	Gray							
Type	Color	Dimensions, mm														
AHX676-B	Black	$\varnothing 21$ x 12														
AHX676-GY	Gray															
<p>Transformer</p>  <p>AF90-949</p>	<table border="1"> <thead> <tr> <th>Voltage</th> <th>Type</th> <th>Lamp</th> </tr> </thead> <tbody> <tr> <td>100 to 110V AC</td> <td>AHX805-H</td> <td>LED</td> </tr> <tr> <td>200 to 220V AC</td> <td>AHX805-M</td> <td></td> </tr> <tr> <td>100 to 110V AC</td> <td>AHX806-H</td> <td>Incandescent</td> </tr> <tr> <td>200 to 220V AC</td> <td>AHX806-M</td> <td></td> </tr> </tbody> </table>	Voltage	Type	Lamp	100 to 110V AC	AHX805-H	LED	200 to 220V AC	AHX805-M		100 to 110V AC	AHX806-H	Incandescent	200 to 220V AC	AHX806-M	
Voltage	Type	Lamp														
100 to 110V AC	AHX805-H	LED														
200 to 220V AC	AHX805-M															
100 to 110V AC	AHX806-H	Incandescent														
200 to 220V AC	AHX806-M															

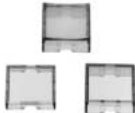

Pushbuttons/Selectors/Pilot Lights/Buzzers AH165-2 Accessories

■ Accessories for AH165-2

Description	Type														
Color lens (Round) 	For flush head (Used with 2F, 2F5, 2FL, 2FL5, 2Z)														
	<table border="0"> <tr><td>Color</td><td>Type</td></tr> <tr><td>Green</td><td>AHX2604-G</td></tr> <tr><td>Red</td><td>AHX2604-R</td></tr> <tr><td>Yellow</td><td>AHX2604-Y</td></tr> <tr><td>Blue</td><td>AHX2604-S</td></tr> <tr><td>Orange</td><td>AHX2604-O</td></tr> <tr><td>Clear</td><td>AHX2604-C</td></tr> </table>	Color	Type	Green	AHX2604-G	Red	AHX2604-R	Yellow	AHX2604-Y	Blue	AHX2604-S	Orange	AHX2604-O	Clear	AHX2604-C
Color	Type														
Green	AHX2604-G														
Red	AHX2604-R														
Yellow	AHX2604-Y														
Blue	AHX2604-S														
Orange	AHX2604-O														
Clear	AHX2604-C														
Color lens (Square) 	For flush head (Used with 2SF, 2SF5, 2SFL, 2SFL5, 2SZ)														
	<table border="0"> <tr><td>Color</td><td>Type</td></tr> <tr><td>Green</td><td>AHX2606-G</td></tr> <tr><td>Red</td><td>AHX2606-R</td></tr> <tr><td>Yellow</td><td>AHX2606-Y</td></tr> <tr><td>Blue</td><td>AHX2606-S</td></tr> <tr><td>Orange</td><td>AHX2606-O</td></tr> <tr><td>Clear</td><td>AHX2606-C</td></tr> </table>	Color	Type	Green	AHX2606-G	Red	AHX2606-R	Yellow	AHX2606-Y	Blue	AHX2606-S	Orange	AHX2606-O	Clear	AHX2606-C
Color	Type														
Green	AHX2606-G														
Red	AHX2606-R														
Yellow	AHX2606-Y														
Blue	AHX2606-S														
Orange	AHX2606-O														
Clear	AHX2606-C														
	For extended head (Used with 2E, 2E5, 2EL, 2EL5, 2ZE)														
	<table border="0"> <tr><td>Color</td><td>Type</td></tr> <tr><td>Green</td><td>AHX2605-G</td></tr> <tr><td>Red</td><td>AHX2605-R</td></tr> <tr><td>Yellow</td><td>AHX2605-Y</td></tr> <tr><td>Blue</td><td>AHX2605-S</td></tr> <tr><td>Orange</td><td>AHX2605-O</td></tr> <tr><td>Clear</td><td>AHX2605-C</td></tr> </table>	Color	Type	Green	AHX2605-G	Red	AHX2605-R	Yellow	AHX2605-Y	Blue	AHX2605-S	Orange	AHX2605-O	Clear	AHX2605-C
Color	Type														
Green	AHX2605-G														
Red	AHX2605-R														
Yellow	AHX2605-Y														
Blue	AHX2605-S														
Orange	AHX2605-O														
Clear	AHX2605-C														
	For extended head (Used with 2SE, 2SE5, 2SEL, 2SEL5, 2SZE)														
	<table border="0"> <tr><td>Color</td><td>Type</td></tr> <tr><td>Green</td><td>AHX2607-G</td></tr> <tr><td>Red</td><td>AHX2607-R</td></tr> <tr><td>Yellow</td><td>AHX2607-Y</td></tr> <tr><td>Blue</td><td>AHX2607-S</td></tr> <tr><td>Orange</td><td>AHX2607-O</td></tr> <tr><td>Clear</td><td>AHX2607-C</td></tr> </table>	Color	Type	Green	AHX2607-G	Red	AHX2607-R	Yellow	AHX2607-Y	Blue	AHX2607-S	Orange	AHX2607-O	Clear	AHX2607-C
Color	Type														
Green	AHX2607-G														
Red	AHX2607-R														
Yellow	AHX2607-Y														
Blue	AHX2607-S														
Orange	AHX2607-O														
Clear	AHX2607-C														
	For concave head (Used with 2SCE, 2SCE5, 2SCL, 2SCL5)														
	<table border="0"> <tr><td>Color</td><td>Type</td></tr> <tr><td>Green</td><td>AHX2608-G</td></tr> <tr><td>Red</td><td>AHX2608-R</td></tr> <tr><td>Yellow</td><td>AHX2608-Y</td></tr> <tr><td>Blue</td><td>AHX2608-S</td></tr> <tr><td>Orange</td><td>AHX2608-O</td></tr> <tr><td>Clear</td><td>AHX2608-C</td></tr> </table>	Color	Type	Green	AHX2608-G	Red	AHX2608-R	Yellow	AHX2608-Y	Blue	AHX2608-S	Orange	AHX2608-O	Clear	AHX2608-C
Color	Type														
Green	AHX2608-G														
Red	AHX2608-R														
Yellow	AHX2608-Y														
Blue	AHX2608-S														
Orange	AHX2608-O														
Clear	AHX2608-C														

AF87-631

AF87-632

Description	Type																
Legend plate 	For flush head																
	<table border="0"> <tr><td>Color</td><td>Type</td><td>Used with</td></tr> <tr><td>White</td><td>AHX2609-W</td><td>Incandescent lamp, LED lamp, Pushbutton *1</td></tr> <tr><td>Clear</td><td>AHX2609-C</td><td>Neon lamp *2</td></tr> <tr><td>Black</td><td>AHX2609-B</td><td>Pushbutton *3</td></tr> </table> <p>Dimensions, mm: $\phi 18 \times 0.9$</p>	Color	Type	Used with	White	AHX2609-W	Incandescent lamp, LED lamp, Pushbutton *1	Clear	AHX2609-C	Neon lamp *2	Black	AHX2609-B	Pushbutton *3				
Color	Type	Used with															
White	AHX2609-W	Incandescent lamp, LED lamp, Pushbutton *1															
Clear	AHX2609-C	Neon lamp *2															
Black	AHX2609-B	Pushbutton *3															
	For extended head																
	<table border="0"> <tr><td>Color</td><td>Type</td><td>Used with</td></tr> <tr><td>White</td><td>AHX2610-W</td><td>Incandescent lamp, LED lamp, Pushbutton *1</td></tr> <tr><td>Clear</td><td>AHX2610-C</td><td>Neon lamp *2</td></tr> <tr><td>Black</td><td>AHX2610-B</td><td>Pushbutton *3</td></tr> </table> <p>Dimensions, mm: $\phi 18 \times 4.4$</p>	Color	Type	Used with	White	AHX2610-W	Incandescent lamp, LED lamp, Pushbutton *1	Clear	AHX2610-C	Neon lamp *2	Black	AHX2610-B	Pushbutton *3				
Color	Type	Used with															
White	AHX2610-W	Incandescent lamp, LED lamp, Pushbutton *1															
Clear	AHX2610-C	Neon lamp *2															
Black	AHX2610-B	Pushbutton *3															
	For flush square																
	<table border="0"> <tr><td>Color</td><td>Type</td><td>Used with</td></tr> <tr><td>White</td><td>AHX2611-W</td><td>Incandescent lamp, LED lamp, Pushbutton *1</td></tr> <tr><td>Clear</td><td>AHX2611-C</td><td>Neon lamp *2</td></tr> <tr><td>Black</td><td>AHX2611-B</td><td>Pushbutton *3</td></tr> </table> <p>Dimensions, mm: 17sq. x 0.9</p>	Color	Type	Used with	White	AHX2611-W	Incandescent lamp, LED lamp, Pushbutton *1	Clear	AHX2611-C	Neon lamp *2	Black	AHX2611-B	Pushbutton *3				
Color	Type	Used with															
White	AHX2611-W	Incandescent lamp, LED lamp, Pushbutton *1															
Clear	AHX2611-C	Neon lamp *2															
Black	AHX2611-B	Pushbutton *3															
	For extended square, concave square																
	<table border="0"> <tr><td>Color</td><td>Type</td><td>Used with</td></tr> <tr><td>White</td><td>AHX2612-W</td><td>Incandescent lamp, LED lamp, Pushbutton *1</td></tr> <tr><td>Clear</td><td>AHX2612-C</td><td>Neon lamp *2</td></tr> <tr><td>Black</td><td>AHX2612-B</td><td>Pushbutton *3</td></tr> </table> <p>Dimensions, mm: 17sq. x 4.4</p>	Color	Type	Used with	White	AHX2612-W	Incandescent lamp, LED lamp, Pushbutton *1	Clear	AHX2612-C	Neon lamp *2	Black	AHX2612-B	Pushbutton *3				
Color	Type	Used with															
White	AHX2612-W	Incandescent lamp, LED lamp, Pushbutton *1															
Clear	AHX2612-C	Neon lamp *2															
Black	AHX2612-B	Pushbutton *3															
	*1 Illuminated pushbutton switches and pilot lights with incandescent lamps or LED lamps, Pushbutton switches (excluding).																
	*2 Illuminated pushbutton switches and pilot lights with neon lamps.																
	*3 Pushbutton switches (black)																
	*4 Engraved range: 17mm dia.																
Mushroom head button 	For illuminated pushbuttons (Used with 2ML, 2YML)																
	<table border="0"> <tr><td>Color</td><td>Type</td></tr> <tr><td>Green</td><td>AHX2614-G</td></tr> <tr><td>Red</td><td>AHX2614-R</td></tr> <tr><td>White</td><td>AHX2614-W</td></tr> <tr><td>Yellow</td><td>AHX2614-Y</td></tr> <tr><td>Blue</td><td>AHX2614-S</td></tr> <tr><td>Orange</td><td>AHX2614-O</td></tr> </table>	Color	Type	Green	AHX2614-G	Red	AHX2614-R	White	AHX2614-W	Yellow	AHX2614-Y	Blue	AHX2614-S	Orange	AHX2614-O		
Color	Type																
Green	AHX2614-G																
Red	AHX2614-R																
White	AHX2614-W																
Yellow	AHX2614-Y																
Blue	AHX2614-S																
Orange	AHX2614-O																
	For non-illuminated pushbuttons (Used with 2M, 2YM)																
	<table border="0"> <tr><td>Color</td><td>Type</td></tr> <tr><td>Green</td><td>AHX2613-G</td></tr> <tr><td>Red</td><td>AHX2613-R</td></tr> <tr><td>White</td><td>AHX2613-W</td></tr> <tr><td>Yellow</td><td>AHX2613-Y</td></tr> <tr><td>Blue</td><td>AHX2613-S</td></tr> <tr><td>Orange</td><td>AHX2613-O</td></tr> <tr><td>Black</td><td>AHX2613-B</td></tr> </table>	Color	Type	Green	AHX2613-G	Red	AHX2613-R	White	AHX2613-W	Yellow	AHX2613-Y	Blue	AHX2613-S	Orange	AHX2613-O	Black	AHX2613-B
Color	Type																
Green	AHX2613-G																
Red	AHX2613-R																
White	AHX2613-W																
Yellow	AHX2613-Y																
Blue	AHX2613-S																
Orange	AHX2613-O																
Black	AHX2613-B																

AF87-631
AF87-630



AF87-633

04





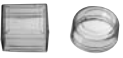

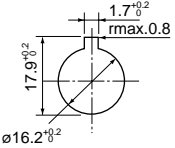

Pushbuttons/Selectors/Pilot Lights/Buzzers





AH165-2

Accessories

Description	Type																				
<p>Push-lock, turn-reset button</p>  <p>AF87-634</p>	<p>For illuminated pushbuttons (Used with 2VL, 2YVL)</p> <table border="0"> <tr> <td>Color</td> <td>Type</td> </tr> <tr> <td>Green</td> <td>AHX2616-G</td> </tr> <tr> <td>Red</td> <td>AHX2616-R</td> </tr> <tr> <td>White</td> <td>AHX2616-W</td> </tr> <tr> <td>Yellow</td> <td>AHX2616-Y</td> </tr> </table> <p>For pushbuttons (Used with 2V, 2YV)</p> <table border="0"> <tr> <td>Color</td> <td>Type</td> </tr> <tr> <td>Green</td> <td>AHX2615-G</td> </tr> <tr> <td>Red</td> <td>AHX2615-R</td> </tr> <tr> <td>Yellow</td> <td>AHX2615-Y</td> </tr> <tr> <td>Black</td> <td>AHX2615-B</td> </tr> </table>	Color	Type	Green	AHX2616-G	Red	AHX2616-R	White	AHX2616-W	Yellow	AHX2616-Y	Color	Type	Green	AHX2615-G	Red	AHX2615-R	Yellow	AHX2615-Y	Black	AHX2615-B
Color	Type																				
Green	AHX2616-G																				
Red	AHX2616-R																				
White	AHX2616-W																				
Yellow	AHX2616-Y																				
Color	Type																				
Green	AHX2615-G																				
Red	AHX2615-R																				
Yellow	AHX2615-Y																				
Black	AHX2615-B																				
<p>Dust-tight cover</p>  <p>AF87-636</p>	<p>For flush round (Used with 2F, 2FL, 2F5, 2FL5) Type: AHX2603-2</p> <p>For flush square (Used with 2SF, 2SFL, 2SF5, 2SFL5) Type: AHX2603-2S</p> <p>These covers protect against dust.</p>																				
<p>Key washer</p>  <p>AF87-635</p>	<p>Type: AHX2601</p> <p>Mounting hole, mm</p> 																				

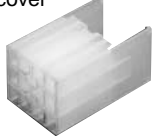
■ Accessories for AH164, AH165 and AH165-2

Description	Type		
Incandescent lamp  <small>KKD06-333</small>	Voltage	Type	
	6V, 0.6W 14V, 0.7W 28V, 0.7W	AHX641 AHX642 AHX643	
LED lamp  <small>KKD06-206</small>	Voltage	Type	
	5V DC 6V DC 12V DC 24V DC	AHX695-5 □ AHX695-6 □ AHX695-12 □ AHX695-24 □	
Neon lamp  <small>KKD06-306</small>	Voltage	Type	Luminous color
	110V AC 120V AC 220V AC 240V AC	AHX655-H AHX654-H AHX655-K AHX654-K AHX655-M AHX654-M AHX655-P AHX654-P	Green Orange Green Orange Green Orange Green Orange
Panel plug  <small>KKD07-262</small>	Round	Color	Type
		Black Gray	AHX622-B IP40 AHX622-GY IP40
 <small>KKD07-261</small>	Square	Color	Type
		Black Gray	AHX644-B IP40 AHX644-GY IP40
 <small>KKD07-260</small>	Rectangular	Color	Type
		Black Gray Black	AHX645-B IP40 AHX645-GY IP40 AHX850-B IP65
Lamp changer  <small>KKD07-259</small>	Type: AHX672		
If the switch is fitted with a lamp, use this tool to remove the lamp. The tool is unnecessary when installing a lamp.			
Remover  <small>KKD07-258</small>	Type: AHX618		
This tool is used for replacing the color chips or screens.			
Contact holder remover  <small>SP-522</small>	Type: AHX699		
This tool is used to remove a contact holder when switches are densely installed.			

Description	Type	
Wrench  <small>KKD07-257</small>	Type: AHX601	
	When installing a command switch on a panel, this tool is useful for tightening the switch firmly and efficiently.	
Terminal cover  <small>AF87-637</small>	Type: AHX2602	
	This cover is used with AH164 and AH165 and AH165-2 (except pilot lights). Pass the wires through the cover, then mount the cover in position.	
Contact block  <small>KKD06-305, KKD06-304</small>	Terminal	Type
	Solder/Tab Wire-wrap	AGX001 AGX001-W
Dummy unit  <small>SK-1141</small>	Type: AGX002	
	A dummy unit is used to fill the space where no contact blocks are installed. For example, two dummy units are used if 1NO+1NC contact block is installed, and one dummy unit is used if 2NO+2NC contact blocks are installed.	
Remover  <small>SM-334</small>	Type: AGX012	
	This tool is used for replacing the contact blocks or dummy units.	

Pushbuttons/Selectors/Pilot Lights/Buzzers

AH164, AH165 and AH165-2

Accessories

Description	Type		
Sockets	Terminal	Type	Used with
	Solder/Tab Wire-wrap PC board	AHX697-S AHX697-W AHX697-P	Pushbuttons
Sockets for LED	Terminal	Type	
	Solder/Tab Wire-wrap	AHX697-SH3 AHX697-WH3	

SM-1097

Contact arrangement is 2NO+2NC only.
Except for AH165-2PL types

SM-1098

- Contact arrangement is 2NO+2NC only.
- These sockets are used only when LED lamps rated for 24V DC are used under 110V AC/DC.
- Except for AH164, 165 and 165-2 series pilot lights or AH165-2PL type.
- When side-by-side mounting and continuous lighting, note that a socket has higher temperature over the ambient temperature.

Dimensions, mm

Solder/Tab

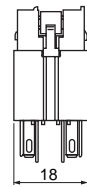
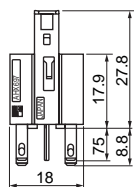

PC board mounting Pushbuttons

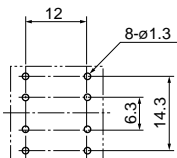

Wire-wrap

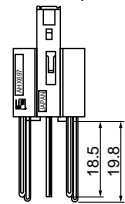

PC board

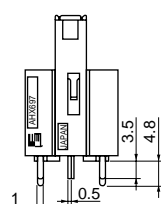

Illuminated pushbuttons

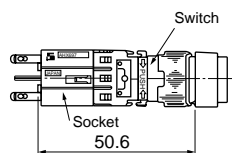
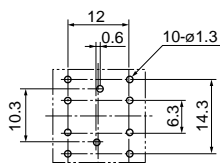

For wiring to wire-wrap pin terminals, select appropriate wire sizes and tool from the table below.

Wire size	Bit	Sleeve	Number of effective wraps
0.4mm dia.	3-A	1-B	About 8
0.5mm dia. (0.65mm dia.)	1-A (2-A)	1-B (2-B)	About 6 (About 6)

Use ordinary wrapping for connection. Wires of 0.65mm dia. must not be used on adjacent terminals. However, 0.65mm dia. wire can be mixed with 0.4mm and 0.5mm dia. wires.

■ Mass, gram
AH164 series

Type	1NO + 1NC	2NO + 2NC	3NO + 3NC
AH164-L,L5 (Without transformer)	12.5	13.5	14.5
L,L5 (With transformer)	53.5	54.5	-
SL,SL5 (Without transformer)	13.1	14.1	15.1
SL,SL5 (With transformer)	54.1	55.1	-
TL,TL5 (Without transformer)	13.9	14.9	15.9
TL,TL5 (With transformer)	54.9	55.9	-
TGL,TGL5 (Without transformer)	13.9	14.9	15.9
TGL,TGL5 (With transformer)	54.9	55.9	-
SGL,SGL5 (Without transformer)	13.1	14.1	15.1
SGL,SGL5 (With transformer)	54.1	55.1	-
AH164-E,E5	10.5	11.5	12.5
M,M5	12.5	13.5	14.5
SF,SF5	11.1	12.1	13.1
TF,TF5	11.9	12.9	13.9
TGF,TGF5	11.9	12.9	13.9
SGF,SGF5	11.1	12.1	13.1
SM,SM5	13.4	14.4	15.4
TM,TM5	13.1	14.1	15.1
AH164-P2,P0	16.1	17.1	18.1
P3,P6,P7,P1	-	17.1	18.1
PK3,PK6,PK7,PK1	-	17.1	18.1
SP2,SP0	15.8	16.8	17.8
SP3,SP6,SP7,SP1	-	16.8	17.8
SPK3,SPK6,SPK7,SPK1	-	16.8	17.8
J2,J0	30.6	31.6	32.6
J3,J6,J7,J1	-	31.6	32.6
JK3,JK6,JK7,JK1	-	31.9	32.9
SJ2,SJ0	30.3	31.3	32.3
SJ3,SJ6,SJ7,SJ1	-	31.3	32.3
SJK3,SJK6,SJK7,SJK1	-	31.6	32.6
AH164-Z (Without transformer)	6.9		
Z (With transformer)	50.9		
ZS (Without transformer)	7.5		
ZS (With transformer)	51.5		
ZT (Without transformer)	8.2		
ZT (With transformer)	52.2		
AH164-TX	16		
TX1	17.5		
TX2B	13		

AH165 series

Type	1NO + 1NC	2NO + 2NC	3NO + 3NC
AH165-L,L5 (Without transformer)	12.5	13.5	14.5
L,L5 (With transformer)	53.5	54.5	-
SL,SL5 (Without transformer)	13.1	14.1	15.1
SL,SL5 (With transformer)	54.1	55.1	-
TL,TL5 (Without transformer)	13.9	14.9	15.9
TL,TL5 (With transformer)	54.9	55.9	-
TGL,TGL5 (Without transformer)	13.9	14.9	15.9
TGL,TGL5 (With transformer)	54.9	55.9	-
SGL,SGL5 (Without transformer)	13.1	14.1	15.1
SGL,SGL5 (With transformer)	54.1	55.1	-
AH165-E,E5	10.5	11.5	12.5
M,M5	12.5	13.5	14.5
SF,SF5	11.1	12.1	13.1
TF,TF5	11.9	12.9	13.9
TGF,TGF5	11.9	12.9	13.9
SGF,SGF5	11.1	12.1	13.1
SM,SM5	13.4	14.4	15.4
TM,TM5	13.1	14.1	15.1
VR	13.4 *	14 *	-
V1R	14.4 *	15 *	-
AH165-V5R	18.1 *	18.7 *	-
V6R	18.9 *	19.5 *	-
AH165-P2,P0	16.7	17.7	18.7
P3,P6,P7,P1	-	17.7	18.7
PK3,PK6,PK7,PK1	-	17.7	18.7
SP2,SP0	16.1	17.1	18.1
SP3,SP6,SP7,SP1	-	17.1	18.1
SPK3,SPK6,SPK7,SPK1	-	17.1	18.1
J2,J0	31.2	32.2	33.2
J3,J6,J7,J1	-	32.2	33.2
JK3,JK6,JK7,JK1	-	32.5	33.5
SJ2,SJ0	30.6	31.6	32.6
SJ3,SJ6,SJ7,SJ1	-	31.6	32.6
SJK3,SJK6,SJK7,SJK1	-	31.9	32.9
AH165-JM2	30	33.9	-
RJM2	29.6	34	-
AH165-Z (Without transformer)	6.9		
Z (With transformer)	50.9		
ZS (Without transformer)	7.5		
ZS (With transformer)	51.5		
ZT (Without transformer)	8.2		
ZT (With transformer)	52.2		
ZM (Without transformer)	5.4		
AH165-X	13.7		

Note: *1 For 1NC
*2 For 2NC

Pushbuttons/Selectors/Pilot Lights/Buzzers
AH164, AH165 and AH165-2
Mass

■ Mass, gram
AH165-2 series

Type	1NO + 1NC	2NO + 2NC	3NO + 3NC
AH165-2FL,FL5	15.3	16.3	17.3
2EL,EL5	15.8	16.8	17.8
2ML	18.7	19.7	20.7
2YML	20.2	21.2	22.2
2SFL,SFL5	16.6	17.6	18.6
2SEL,SEL5	17.4	18.4	19.4
2SCL,SCL5	17.6	18.6	19.6
2VL	20.7	21.7	22.7
2YVL	21.4	22.4	23.4
AH165-2F,F5	13.4	14.4	15.4
2E,E5	13.9	14.9	15.9
2M	17.8	18.8	19.8
2YM	18.2	19.2	20.2
2SF,SF5	14.6	15.6	16.6
2SE,SE5	15.4	16.4	17.4
2SCE,SCE5	15.6	16.6	17.6
2S2	-	19	-
2YS2	-	20.6	-
2V	18	19	20
2YV	19.4	20.4	21.4
AH165-2P2,P0	16.6	17.6	18.6
2P3,P6,P7,P1	-	17.6	18.6
2YP2,YP0	18.3	19.3	20.3
2YP3,YP6,YP7,YP1	-	19.3	20.3
2J2,J0	40.9	41.9	42.9
2J3,J6,J7,J1	-	41.9	42.9
2YJ2	42.6	43.6	44.6
2YJ3,YJ6,YJ7,YJ1	-	43.6	44.6
2H	14.3	15.3	16.3
2SH	16.1	17.1	18.1
AH165-2PL2	17.4	18.4	-
2PL3	-	18.4	-
AH165-2Z	9.7		
2ZE	10.2		
2SZ	11		
2SZE	11.6		