

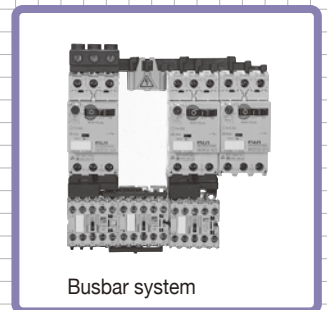

■ MANUAL MOTOR STARTERS AND CONTACTORS



■ COMBINATION STARTERS



LOW VOLTAGE EQUIPMENT Up to 600 Volts

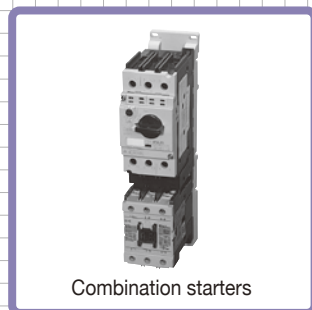

INDIVIDUAL CATALOG **02**
from D&C CATALOG 20th Edition

01 **02** 03 04 05 06 07 08 09 10 11 12

02

DUO series Manual Motor Starters and Contactors Combination Starters



	Page
DUO Series MMS and Contactors	
General information	02/1
Manual motor starters	
General information	02/2
Quick reference guide	02/5
Adjustable thermal-magnetic trip types	02/8
Instantaneous trip types	02/10
Ring terminal connection types	02/11
UL listed	02/13
Characteristic curves	02/14
Optional accessories	02/15
Dimensions	02/21
Wiring diagrams	02/24
Operating conditions	02/25
Busbar system	02/26
Enclosures	02/30
DUO Series Contactors	
SC-M and SC-E series	
General information	02/32
SC-M series contactors	02/35
Optional accessories	02/39
Dimensions	02/40
SC-E series contactors	02/43
Optional accessories	02/51
Dimensions	02/53
Operating conditions	02/63
Thermal overload relays TK-E series	02/65
DUO Series Combination Starters	
Features	02/71
Protective coordination	02/72
Combinations meeting for UL market	02/76
Optional accessories	02/77
Dimensions	02/80
DUO Series MMS and Contactors	
CCC approved	02/85

MINIMUM ORDERS

Orders amounting to **less than ¥10,000** net per order will be charged as ¥10,000 net per order plus freight and other charges.

WEIGHTS AND DIMENSIONS

Weights and dimensions appearing in this catalog are the best information available at the time of going to press.

FUJI ELECTRIC FA has a policy of continuous product improvement, and design changes may make this information out of date.

Please confirm such details before planning actual construction.

INFORMATION IN THIS CATALOG IS SUBJECT TO CHANGE WITHOUT NOTICE.

■ Description

FUJI offers a new motor control system – DUO series for the international market, designed to IEC standards. The DUO series adds a new family of compact, high-performance combination starters to its IEC-compliant manual motor starters BM3 series, magnetic contactors SC series and thermal overload relays TK series to form a complete line-up of motor control products.

- Short-circuit protective coordination between protective devices and the equipment to be protected
- Conformance to IEC, UL, CSA and other international standards
- Safety and ecological consideration – safety features such as terminals with finger protection, use of recyclable materials, and resources-saving

Manual motor starters (MMS) BM3 series

New circuit breakers for motor use that provide optimal protection by integrating the functions of a molded case circuit breaker and thermal overload relay into a highly compact unit. See page 02/2

Contactors and thermal overload relays SC-M and SC-E series

SC-M series compact magnetic contactors for small capacity motor control for 400V AC, 2.2 to 4kW.

SC-E series magnetic contactors and thermal overload relays featuring terminals with finger protection for 400V AC, 4 to 75kW. See page 02/32

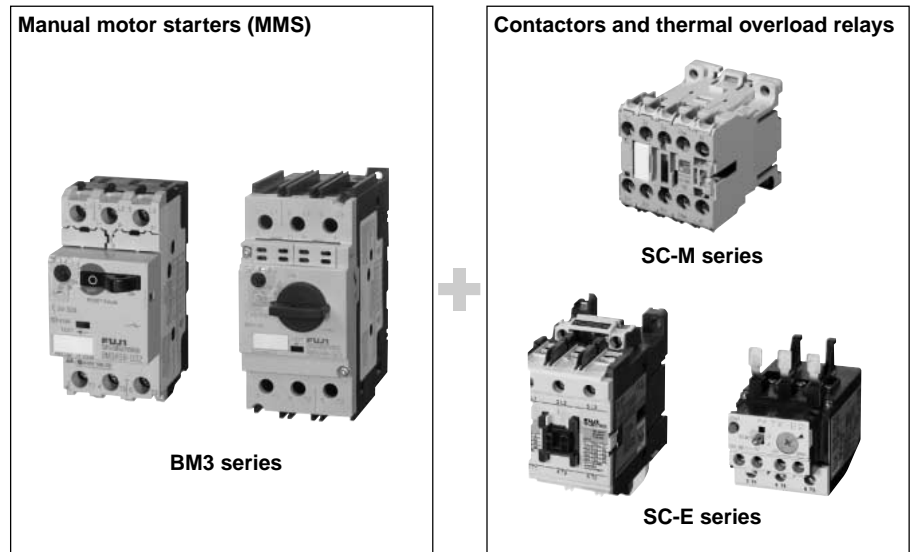

Combination starters

The ability to configure combination starters for compact, reliable motor protection by combining a manual motor starter and a magnetic contactor. See page 02/74

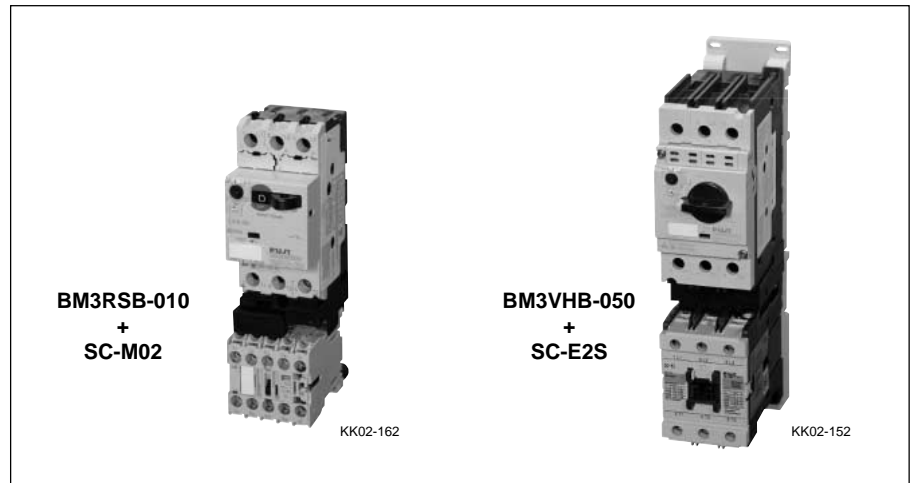

DUO series Manual Motor Starters

General information

Manual motor starters BM3 series

■ Description

Conforming to international standards and combining compactness with high breaking performance, this versatile series features leading-edge motor protection. Molded case circuit breaker and thermal overload relay functions are integrated into a highly compact unit.

■ Features

- Eight types available in two different frame sizes-32AF for the 45mm width and 63AF for the 55mm width
- A wide motor capacity range up to 30kW (400/415V AC, 63A)
- High breaking capacity
Standard breaking capacity: 25, 50, 100kA 400V AC
High breaking capacity: 50, 100kA 400V AC
- Adjustable thermal-magnetic trip types
32AF: BM3RSB and BM3RHB
63AF: BM3VSB and BM3VHB
- Instantaneous trip types
32AF: BM3RSBK and BM3RHBK
63AF: BM3VSBK and BM3VHBK
- Common accessories to reduce inventory
- Short-circuit protective coordination
IEC 60947-4-1 Type1, 2
- Standards
IEC 60947-1, 60947-2, 60947-4-1, UL 508, CSA C22.2 No.14
- Ecological design
Recyclable thermoplastic resin used in plastic parts
Indication of materials used
Cadmium-free contacts
- Both rocker and rotary handle
- ON/OFF and trip state indication for all frames



Circuit breaker functions

- Short-circuit protection
- Overcurrent protection
- Line protection

Thermal overload relay functions

- Overload protection
- Phase-loss protection
- Rated current adjustment
- Ambient temperature compensation



Compactness:
57% reduction

Wiring work:
50% reduction

Manual motor starters BM3 series



KK01-317

BM3RSB and BM3RSBK

Rated current: 0.16 to 32A
Rated insulation voltage: 690V
Operation handle: Rocker handle
Breaking capacity Icu at 400/415V:
• 100kA up to 10A
• 50kA up to 13A
• 25kA up to 32A



AF01-47

BM3VSB and BM3VSBK

Rated current: 10 to 63A
Rated insulation voltage: 1000V
Operation handle: Rotary handle
Breaking capacity Icu at 400/415V:
• 100kA up to 10A
• 50kA up to 13A
• 25kA up to 63A



AF01-42

BM3RHB and BM3RHBK

Rated current: 0.16 to 32A
Rated insulation voltage: 690V
Operation handle: Rotary handle
Breaking capacity Icu at 400/415V:
• 100kA up to 13A
• 50kA up to 32A



AF01-43

BM3VHB and BM3VHBK

Rated current: 10 to 63A
Rated insulation voltage: 1000V
Operation handle: Rotary handle
Breaking capacity Icu at 400/415V:
• 100kA up to 13A
• 50kA up to 63A

■ Manual motor starters for branch circuit protection

The MMS provides reliable protection for overloading and short-circuiting in motor branch circuits.

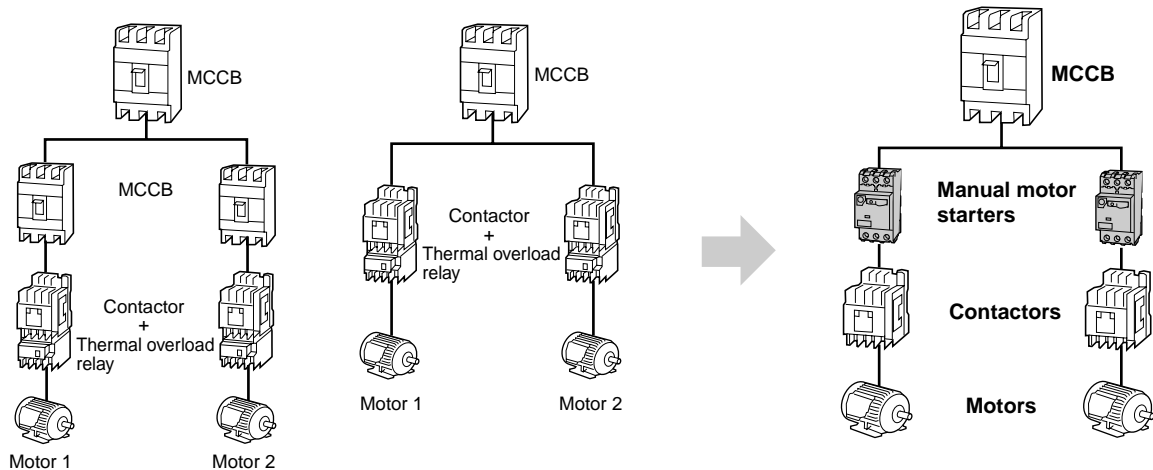

Typical problem in the conventional system



Solution by using MMS system

Short-circuit breaking protection

When numerous small and medium motor loads exist in a circuit requiring high breaking capacity, there is no high-breaking capacity circuit breaker with a small rated current for short-circuit protection.

The MMS can be used in 100kA short-circuit current circuits for three-phase, 240V motors with rated capacity up to 15kW, and in 50kA short-circuit current circuits for three-phase, 415V motors with rated capacity up to 30kW.

Back-up breaking system

When a back-up MCCB is installed upstream to solve the problem described in "short-circuit breaking protection" above, an occurrence of short-circuit failure in a single load circuit also trips the upstream breaker and stops the other operating load circuits.

Despite their compact size, the 32AF and 63AF MMS provide high-performance short-circuit current breaking. They eliminate the need for an upstream circuit breaker for back-up use.

Overload protection

Motor protection breakers cannot be adjusted to match the rated current of the motor being protected.

Equipped with a wide-range current adjustment dial (with maximum/minimum ratio of 1.4 to 1.6), the MMS easily adjusts to match the rated current of the motor, for optimum protection.

Control panel size

Considerable space is required to install a back-up circuit breaker or a combination starter consisting of a circuit breaker and a thermal overload relay. As a result, the panel size has to be increased.

The compact size of the MMS, including thermal overload relay functions, enables a smaller installation area with less wiring space, for a reduction in panel size.

DUO series Manual Motor Starters

General information



■ Accessories

A wide variety of accessories enables a flexible response to changes in specifications.

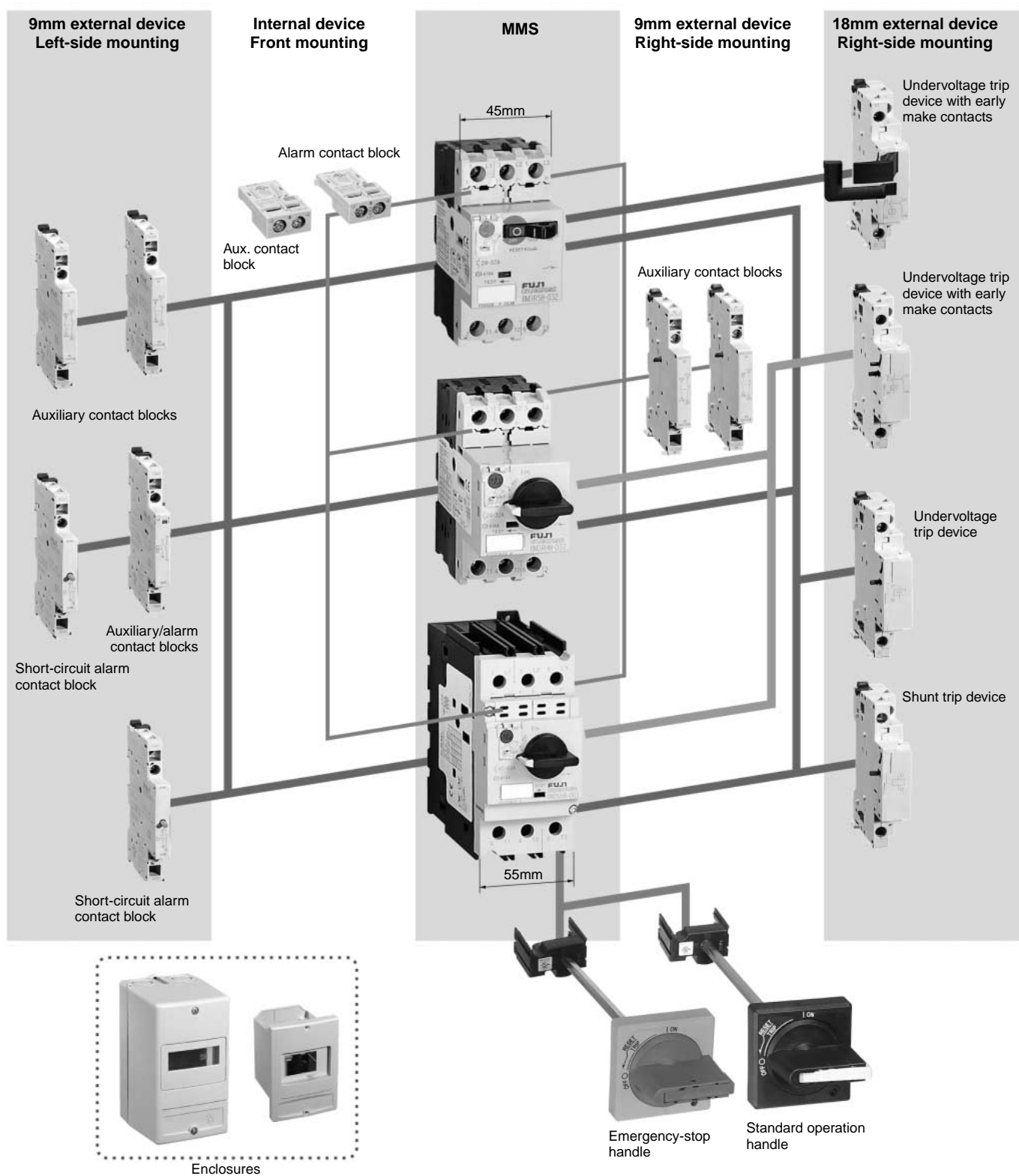
Snap-on fittings speed up mounting.



■ 32AF types and ratings

Adjustable thermal-magnetic trip type Instantaneous trip type		Standard breaking capacity BM3RSB-□  KK01-317						High breaking capacity BM3RHB-□ BM3RHBK-□  AF01-42								
Number of poles		3						3								
Handle type		Rocker						Rotary								
Rated current I _n (A)		0.16 to 32														
Rated operational voltage U _e (V)		200 to 690														
Rated frequency (Hz)		50/60														
Rated insulation voltage U _i (V)		690														
Rated impulse withstand voltage U _{imp} (kV)		6														
Utilization IEC 60947-2 Circuit breaker category		Cat. A														
IEC 60947-4-1 Motor starter		AC-3														
Trip class IEC 60947-4-1 *1		10														
Instantaneous trip characteristic		13 × I _n max.														
Power loss (total of 3-pole)		7W: I _n =0.16 to 25A 8.5W: I _n =32A														
Mechanical durability (operations)		100,000: I _n =0.16 to 25A 70,000: I _n =32A														
Electrical durability (operations)		100,000: I _n =0.16 to 25A 70,000: I _n =32A														
Max. operations per hour (motor start-up)		25														
Phase-loss protection		Provided														
Tripping state indication		Provided														
Test trip function		Provided														
Rated breaking capacity (kA)	Adjustable current range	240V	415V	460V	500V	690V	240V	415V	460V	500V	690V					
	Code I _e : Min.–Max. (A)	230V	400V	440V		600V	230V	400V	440V		600V					
IEC 60947-2 <i>Replace the □ mark in the type number by current range codes.</i>		I _{cu}	I _{cs}	I _{cu}	I _{cs}	I _{cu}	I _{cs}	I _{cu}	I _{cs}	I _{cu}	I _{cs}	I _{cu}	I _{cs}	I _{cu}	I _{cs}	
	P16	0.1–0.16	100 100	100 100	100 100	100 100	100 100	100 100	100 100	100 100	100 100	100 100	100 100	100 100	100 100	100 100
	P25	0.16–0.25	100 100	100 100	100 100	100 100	100 100	100 100	100 100	100 100	100 100	100 100	100 100	100 100	100 100	100 100
	P40	0.25–0.4	100 100	100 100	100 100	100 100	100 100	100 100	100 100	100 100	100 100	100 100	100 100	100 100	100 100	100 100
	P63	0.4–0.63	100 100	100 100	100 100	100 100	100 100	100 100	100 100	100 100	100 100	100 100	100 100	100 100	100 100	100 100
	001	0.63–1	100 100	100 100	100 100	100 100	100 100	100 100	100 100	100 100	100 100	100 100	100 100	100 100	100 100	100 100
	1P6	1–1.6	100 100	100 100	100 100	100 100	100 100	100 100	100 100	100 100	100 100	100 100	100 100	100 100	100 100	100 100
	2P5	1.6–2.5	100 100	100 100	100 100	100 100	100 100	3 2	100 100	100 100	100 100	100 100	100 100	100 100	8 6	8 6
	004	2.5–4	100 100	100 100	100 100	100 100	100 100	3 2	100 100	100 100	100 100	100 100	100 100	100 100	8 6	8 6
	6P3	4–6.3	100 100	100 100	50 38	50 38	3 2	100 100	100 100	100 100	100 100	100 100	100 100	6 5	6 5	6 5
	010	6.3–10	100 100	100 100	15 11	10 8	3 2	100 100	100 100	50 38	50 38	6 5	6 5	6 5	6 5	6 5
	013	9–13	100 100	50 38	10 8	6 5	3 2	100 100	100 100	50 38	42 32	6 5	6 5	6 5	6 5	6 5
	016	11–16	100 100	25 19	10 8	6 5	3 2	100 100	50 38	35*2 27	10 8	4 3	4 3	4 3	4 3	4 3
	020	14–20	50 38	25 19	10 8	6 5	3 2	100 100	50 38	35*2 27	10 8	4 3	4 3	4 3	4 3	4 3
	025	19–25	50 38	25 19	10 8	6 5	3 2	100 100	50 38	35*2 27	10 8	4 3	4 3	4 3	4 3	4 3
	032	24–32	50 38	25 19	10 8	6 5	3 2	100 100	50 38	35*2 27	10 8	4 3	4 3	4 3	4 3	4 3
040	28–40	–	–	–	–	–	–	–	–	–	–	–	–	–	–	
050	35–50	–	–	–	–	–	–	–	–	–	–	–	–	–	–	
063	45–63	–	–	–	–	–	–	–	–	–	–	–	–	–	–	
Dimensions (mm) W×H×D		45×90×66						45×90×79								
Mass (g)		350						370								
Optional accessory	Auxiliary contact block	○						○								
	Alarm contact block	○						○								
	Auxiliary and alarm contact block	○						○								
	Short-circuit alarm contact block	○						○								
	Shunt trip device	○						○								
	Undervoltage trip device	○						○								
External operating handle		–						○								
Standard		IEC 60947-1, 60947-2, 60947-4-1, UL 508, CSA C22.2 No.14, TÜV														

Note: *1 Adjustable thermal-magnetic trip type only

*2 When the breaking duty is once "0" in JEM 1195, the breaking capacity is 50kA.



○ Available

– Not available

DUO series Manual Motor Starters

Quick reference guide

■ 63AF types and ratings

Adjustable thermal-magnetic trip type Instantaneous trip type		Standard breaking capacity BM3VSB-□  AF01-47						High breaking capacity BM3VHB-□ BM3VHBK-□  AF01-43														
Number of poles		3						3														
Handle type		Rotary						Rotary														
Rated current I_n (A)		10 to 63																				
Rated operational voltage U_e (V)		200 to 690																				
Rated frequency (Hz)		50/60																				
Rated insulation voltage U_i (V)		1000																				
Rated impulse withstand voltage U_{imp} (kV)		8																				
Utilization category		IEC 60947-2 Circuit breaker Cat. A						IEC 60947-4-1 Motor starter AC-3														
Trip class IEC 60947-4-1 *1		10																				
Instantaneous trip characteristic		13 × I_n max.																				
Power loss (total of 3-pole)		11W: $I_n=10$ to 32A 15W: $I_n=40$ to 50A 17W: $I_n=63$ A																				
Mechanical durability (operations)		50,000																				
Electrical durability (operations)		25,000																				
Max. operations per hour (motor start-up)		25																				
Phase-loss protection		Provided																				
Tripping state indication		Provided																				
Test trip function		Provided																				
Rated breaking capacity (kA)	Adjustable current range	240V	415V	460V	500V	690V	240V	415V	460V	500V	690V	240V	415V	460V	500V	690V						
	Code I_e : Min.–Max. (A)	230V	400V	440V		600V	230V	400V	440V		600V	230V	400V	440V		600V						
IEC 60947-2		I_{cu}	I_{cs}	I_{cu}	I_{cs}	I_{cu}	I_{cs}	I_{cu}	I_{cs}	I_{cu}	I_{cs}	I_{cu}	I_{cs}	I_{cu}	I_{cs}	I_{cu}	I_{cs}					
Replace the □ mark in the type number by current range codes.	P16	0.1–0.16	–	–	–	–	–	–	–	–	–	–	–	–	–	–	–					
	P25	0.16–0.25	–	–	–	–	–	–	–	–	–	–	–	–	–	–	–					
	P40	0.25–0.4	–	–	–	–	–	–	–	–	–	–	–	–	–	–	–					
	P63	0.4–0.63	–	–	–	–	–	–	–	–	–	–	–	–	–	–	–					
	001	0.63–1	–	–	–	–	–	–	–	–	–	–	–	–	–	–	–					
	1P6	1–1.6	–	–	–	–	–	–	–	–	–	–	–	–	–	–	–					
	2P5	1.6–2.5	–	–	–	–	–	–	–	–	–	–	–	–	–	–	–					
	004	2.5–4	–	–	–	–	–	–	–	–	–	–	–	–	–	–	–					
	6P3	4–6.3	–	–	–	–	–	–	–	–	–	–	–	–	–	–	–					
	010	6.3–10	100	100	100	100	15	12	10	8	4	3	100	100	100	100	50	38	50	38	6	5
	013	9–13	100	100	50	38	10	8	6	5	4	3	100	100	100	100	50	38	42	32	6	5
	016	11–16	100	100	25	19	10	8	6	5	4	3	100	100	50	38	50	38	12	9	5	4
	020	14–20	50	38	25	19	10	8	6	5	4	3	100	100	50	38	50	38	12	9	5	4
025	19–25	50	38	25	19	10	8	6	5	4	3	100	100	50	38	35*2	27	12	9	5	4	
032	24–32	50	38	25	19	10	8	6	5	4	3	100	100	50	38	35*2	27	10	8	5	4	
040	28–40	50	38	25	19	10	8	6	5	4	3	100	100	50	38	35*2	27	10	8	5	4	
050	35–50	50	38	25	19	10	8	6	5	4	3	100	100	50	38	35*2	27	10	8	5	4	
063	45–63	50	38	25	19	10	8	6	5	4	3	100	100	50	38	35*2	27	10	8	5	4	
Dimensions (mm) W×H×D		55×110×96																				
Mass (g)		780																				
Optional accessory	Auxiliary contact block	○																				
	Alarm contact block	○																				
	Auxiliary and alarm contact block	○																				
	Short-circuit alarm contact block	○																				
	Shunt trip device	○																				
	Undervoltage trip device	○																				
External operating handle		○																				
Standard		IEC 60947-1, 60947-2, 60947-4-1, UL 508, CSA C22.2 No.14, TÜV																				



Note: * 1 Adjustable thermal-magnetic trip type only

○ Available

– Not available

* 2 When the breaking duty is once "0" in JEM 1195, the breaking capacity is 50kA.

■ 32AF types and ratings, with ring terminal connection

Adjustable thermal-magnetic trip type Instantaneous trip type		Standard breaking capacity BM3RSR-□  KK05-197						High breaking capacity BM3RHR-□ BM3RHRK-□  KK05-198										
Number of poles		3						3										
Handle type		Rocker						Rotary										
Rated current I _n (A)		0.16 to 32																
Rated operational voltage U _e (V)		200 to 690																
Rated frequency (Hz)		50/60																
Rated insulation voltage U _i (V)		690																
Rated impulse withstand voltage U _{imp} (kV)		6																
Utilization IEC 60947-2 Circuit breaker category		Cat. A																
IEC 60947-4-1 Motor starter		AC-3																
Trip class IEC 60947-4-1 *1		10																
Instantaneous trip characteristic		13 × I _n max.																
Power loss (total of 3-pole)		7W: I _n =0.16 to 25A 8.5W: I _n =32A																
Mechanical durability (operations)		100,000: I _n =0.16 to 25A 70,000: I _n =32A																
Electrical durability (operations)		100,000: I _n =0.16 to 25A 70,000: I _n =32A																
Max. operations per hour (motor start-up)		25																
Phase-loss protection		Provided																
Tripping state indication		Provided																
Test trip function		Provided																
Rated breaking capacity (kA)	Adjustable current range	240V	415V	460V	500V	690V	240V	415V	460V	500V	690V	240V	415V	460V	500V	690V		
	Code I _e : Min.–Max. (A)	230V	400V	440V		600V	230V	400V	440V		600V	230V	400V	440V		600V		
IEC 60947-2 <i>Replace the □ mark in the type number by current range codes.</i>		I _{cu}	I _{cs}	I _{cu}	I _{cs}	I _{cu}	I _{cs}	I _{cu}	I _{cs}	I _{cu}	I _{cs}	I _{cu}	I _{cs}	I _{cu}	I _{cs}	I _{cu}	I _{cs}	
	P16	0.1–0.16	100	100	100	100	100	100	100	100	100	100	100	100	100	100	100	100
	P25	0.16–0.25	100	100	100	100	100	100	100	100	100	100	100	100	100	100	100	100
	P40	0.25–0.4	100	100	100	100	100	100	100	100	100	100	100	100	100	100	100	100
	P63	0.4–0.63	100	100	100	100	100	100	100	100	100	100	100	100	100	100	100	100
	001	0.63–1	100	100	100	100	100	100	100	100	100	100	100	100	100	100	100	100
	1P6	1–1.6	100	100	100	100	100	100	100	100	100	100	100	100	100	100	100	100
	2P5	1.6–2.5	100	100	100	100	100	100	3	2	100	100	100	100	100	100	8	6
	004	2.5–4	100	100	100	100	100	100	3	2	100	100	100	100	100	100	8	6
	6P3	4–6.3	100	100	100	100	50	38	50	38	3	2	100	100	100	100	100	100
	010	6.3–10	100	100	100	100	15	11	10	8	3	2	100	100	50	38	50	38
	013	9–13	100	100	50	38	10	8	6	5	3	2	100	100	50	38	42	32
	016	11–16	100	100	25	19	10	8	6	5	3	2	100	100	50	38	35 ^{*2}	27
	020	14–20	50	38	25	19	10	8	6	5	3	2	100	100	50	38	35 ^{*2}	27
	025	19–25	50	38	25	19	10	8	6	5	3	2	100	100	50	38	35 ^{*2}	27
	032	24–32	50	38	25	19	10	8	6	5	3	2	100	100	50	38	35 ^{*2}	27
040	28–40	–	–	–	–	–	–	–	–	–	–	–	–	–	–	–	–	
050	35–50	–	–	–	–	–	–	–	–	–	–	–	–	–	–	–	–	
063	45–63	–	–	–	–	–	–	–	–	–	–	–	–	–	–	–	–	
Dimensions (mm) W×H×D		45×90×66						45×90×79										
Mass (g)		350						370										
Optional accessory	Auxiliary contact block	○						○										
	Alarm contact block	○						○										
	Auxiliary and alarm contact block	○						○										
	Short-circuit alarm contact block	○						○										
	Shunt trip device	○						○										
	Undervoltage trip device	○						○										
External operating handle		–						○										
Standard		IEC 60947-1, 60947-2, 60947-4-1, UL 508, CSA C22.2 No.14, TÜV																

Note: *1 Adjustable thermal-magnetic trip type only

*2 When the breaking duty is once "0" in JEM 1195, the breaking capacity is 50kA.

○ Available

– Not available

DUO series Manual Motor Starters

Adjustable thermal-magnetic trip types

Adjustable thermal-magnetic trip types

■ Features

- A wide rated operational current range of up to 32A for the 45mm wide and 63A for the 55mm wide starters.
- ON/OFF and trip indications ensure instant status recognition.
- Suitable for 3-phase motors up to 30kW at 440V AC, AC-3.
- Accessories like auxiliary contact blocks, shunt trip devices, and undervoltage trip devices have been standardized for the 45mm and 55mm wide frame sizes of the BM3R and BM3V.
- Enclosures and external operating handles are available as optional accessories.

■ Standards

IEC 60947-1, 60947-2, 60947-4-1, UL 508, CSA C22.2 No.14, TÜV, CCC

■ Types and ratings

• 32AF standard breaking capacity, rocker handle types

Max. motor capacity and full-load current 3-phase *1				Rated current *2 In (A)	Thermal current setting range Ie (A)	Instantaneous trip current (A)	Rated breaking capacity Icu (kA)			Type
200-240V AC (kW) (A)		380-440V AC (kW) (A)					240V AC	415V AC	440V AC	
–	–	0.02	0.1	0.16	0.1–0.16	2.1	100	100	100	BM3RSB-P16
0.03	0.24	0.06	0.21	0.25	0.16–0.25	3.3	100	100	100	BM3RSB-P25
0.06	0.37	0.1	0.34	0.4	0.25–0.4	5.2	100	100	100	BM3RSB-P40
0.06	0.37	0.12	0.41	0.63	0.4–0.63	8.2	100	100	100	BM3RSB-P63
0.1	0.68	0.2	0.65	1	0.63–1	13	100	100	100	BM3RSB-001
0.2	1.3	0.4	1.15	1.6	1–1.6	20.8	100	100	100	BM3RSB-1P6
0.4	2.3	0.75	1.8	2.5	1.6–2.5	32.5	100	100	100	BM3RSB-2P5
0.75	3.6	1.5	3.1	4	2.5–4	52	100	100	100	BM3RSB-004
1.5	6.1	2.2	4.6	6.3	4–6.3	81.9	100	100	50	BM3RSB-6P3
2.2	9.2	3.7	7.5	10	6.3–10	130	100	100	15	BM3RSB-010
2.2	9.2	5.5	11.5	13	9–13	169	100	50	10	BM3RSB-013
3.7	15	7.5	14.5	16	11–16	208	100	25	10	BM3RSB-016
3.7	15	7.5	14.5	20	14–20	260	50	25	10	BM3RSB-020
5.5	22.5	11	21	25	19–25	325	50	25	10	BM3RSB-025
7.5	29	15	27.5	32	24–32	416	50	25	10	BM3RSB-032

• 32AF high breaking capacity, rotary handle types

Max. motor capacity and full-load current 3-phase *1				Rated current *2 In (A)	Thermal current setting range Ie (A)	Instantaneous trip current (A)	Rated breaking capacity Icu (kA)			Type
200-240V AC (kW) (A)		380-440V AC (kW) (A)					240V AC	415V AC	440V AC	
–	–	0.02	0.1	0.16	0.1–0.16	2.1	100	100	100	BM3RHB-P16
0.03	0.24	0.06	0.21	0.25	0.16–0.25	3.3	100	100	100	BM3RHB-P25
0.06	0.37	0.1	0.34	0.4	0.25–0.4	5.2	100	100	100	BM3RHB-P40
0.06	0.37	0.12	0.41	0.63	0.4–0.63	8.2	100	100	100	BM3RHB-P63
0.1	0.68	0.2	0.65	1	0.63–1	13	100	100	100	BM3RHB-001
0.2	1.3	0.4	1.15	1.6	1–1.6	20.8	100	100	100	BM3RHB-1P6
0.4	2.3	0.75	1.8	2.5	1.6–2.5	32.5	100	100	100	BM3RHB-2P5
0.75	3.6	1.5	3.1	4	2.5–4	52	100	100	100	BM3RHB-004
1.5	6.1	2.2	4.6	6.3	4–6.3	81.9	100	100	100	BM3RHB-6P3
2.2	9.2	3.7	7.5	10	6.3–10	130	100	100	50	BM3RHB-010
2.2	9.2	5.5	11.5	13	9–13	169	100	100	50	BM3RHB-013
3.7	15	7.5	14.5	16	11–16	208	100	50	35	BM3RHB-016
3.7	15	7.5	14.5	20	14–20	260	100	50	35	BM3RHB-020
5.5	22.5	11	21	25	19–25	325	100	50	35	BM3RHB-025
7.5	29	15	27.5	32	24–32	416	100	50	35	BM3RHB-032

Notes: *1 Motor full-load currents are based on FUJI's standard type totally-enclosed induction motors.

*2 Max. thermal current setting value

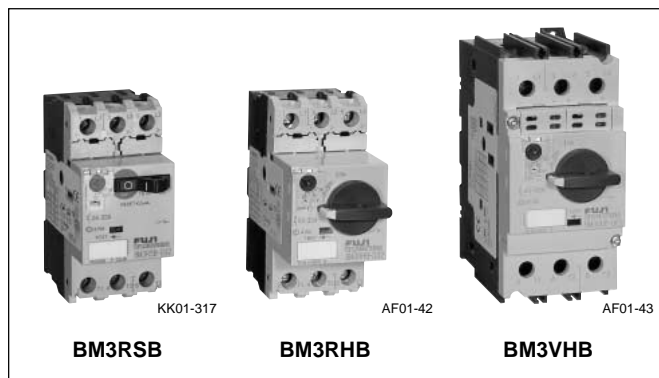

• **63AF standard breaking capacity, rotary handle types**

Max. motor capacity and full-load current 3-phase *1				Rated current *2 In (A)	Thermal current setting range Ie (A)	Instantaneous trip current (A)	Rated breaking capacity Icu (kA)			Type
200-240V AC (kW) (A)		380-440V AC (kW) (A)					240V AC	415V AC	440V AC	
2.2	9.2	3.7	7.5	10	6.3-10	130	100	100	15	BM3VSB-010
2.2	9.2	5.5	11.5	13	9-13	169	100	50	10	BM3VSB-013
3.7	15	7.5	14.5	16	11-16	208	100	25	10	BM3VSB-016
3.7	15	7.5	14.5	20	14-20	260	50	25	10	BM3VSB-020
5.5	22.5	11	21	25	19-25	325	50	25	10	BM3VSB-025
7.5	29	15	27.5	32	24-32	416	50	25	10	BM3VSB-032
7.5	29	18.5	34	40	28-40	520	50	25	10	BM3VSB-040
11	42	22	39	50	35-50	650	50	25	10	BM3VSB-050
15	55	30	54	63	45-63	819	50	25	10	BM3VSB-063

• **63AF high breaking capacity, rotary handle types**

Max. motor capacity and full-load current 3-phase *1				Rated current *2 In (A)	Thermal current setting range Ie (A)	Instantaneous trip current (A)	Rated breaking capacity Icu (kA)			Type
200-240V AC (kW) (A)		380-440V AC (kW) (A)					240V AC	415V AC	440V AC	
2.2	9.2	3.7	7.5	10	6.3-10	130	100	100	50	BM3VHB-010
2.2	9.2	5.5	11.5	13	9-13	169	100	100	50	BM3VHB-013
3.7	15	7.5	14.5	16	11-16	208	100	50	50	BM3VHB-016
3.7	15	7.5	14.5	20	14-20	260	100	50	50	BM3VHB-020
5.5	22.5	11	21	25	19-25	325	100	50	35	BM3VHB-025
7.5	29	15	27.5	32	24-32	416	100	50	35	BM3VHB-032
7.5	29	18.5	34	40	28-40	520	100	50	35	BM3VHB-040
11	42	22	39	50	35-50	650	100	50	35	BM3VHB-050
15	55	30	54	63	45-63	819	100	50	35	BM3VHB-063

Notes: *1 Motor full-load currents are based on FUJI's standard type totally-enclosed induction motors.
*2 Max. thermal current setting value

■ **Type number nomenclature**

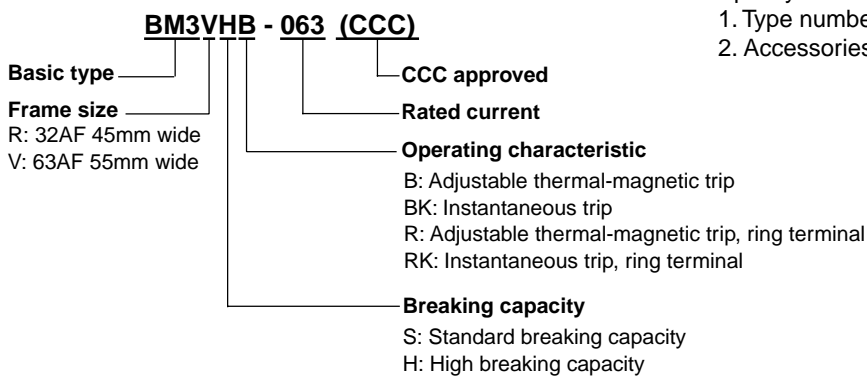

■ **Ordering information**

- Specify the following:
1. Type number
 2. Accessories if required

DUO series Manual Motor Starters

Instantaneous trip types

Instantaneous trip types

■ Features

- Instantaneous trip type for short-circuit or overcurrent protection of three-phase motors up to 63A (240V AC, 15kW, or 440V AC, 30kW).
- A motor overload protection function is not provided. Protecting the motor circuits is possible by using the starter together with a thermal overload relay that is matched to the thermal characteristics and startup time of the motor.
- Two modules, 45mm or 55mm wide, cover current ratings from 0.1 to 63A.
RHBK: 45mm wide, rated current of 0.1 to 32A
VHBK: 55mm wide, rated current of 6.3 to 63A
- Rotary handle
- Versatile accessories
Internal and external auxiliary contact blocks, alarm contact block
Short-circuit alarm contact block
Shunt trip device
Undervoltage trip device

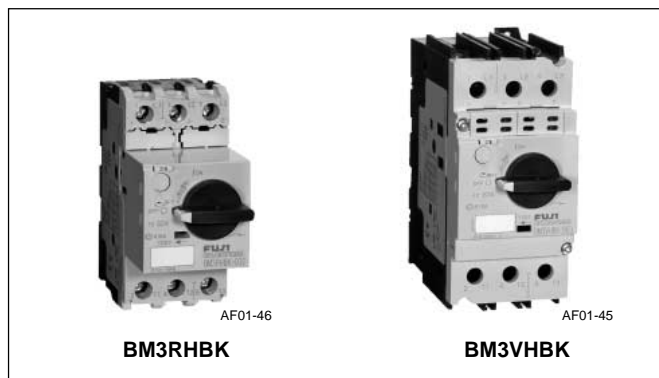

■ Standards

IEC 60947-1, 60947-2, 60947-4-1, UL 508
CSA C22.2 No.14, TÜV, CCC

■ Types and ratings

• 32AF high breaking capacity, rotary handle type

Max. motor capacity and full-load current 3-phase *				Rated current In (A)	Instantaneous trip current (A)	Rated breaking capacity Icu (kA)			Type
200-240V AC		380-440V AC				240V AC	415V AC	440V AC	
(kW)	(A)	(kW)	(A)						
–	–	0.02	0.1	0.16	2.1	100	100	100	BM3RHBK-P16
0.03	0.24	0.06	0.21	0.25	3.3	100	100	100	BM3RHBK-P25
0.06	0.37	0.1	0.34	0.4	5.2	100	100	100	BM3RHBK-P40
0.06	0.37	0.12	0.41	0.63	8.2	100	100	100	BM3RHBK-P63
0.1	0.68	0.2	0.65	1	13	100	100	100	BM3RHBK-001
0.2	1.3	0.4	1.15	1.6	20.8	100	100	100	BM3RHBK-1P6
0.4	2.3	0.75	1.8	2.5	32.5	100	100	100	BM3RHBK-2P5
0.75	3.6	1.5	3.1	4	52	100	100	100	BM3RHBK-004
1.5	6.1	2.2	4.6	6.3	81.9	100	100	100	BM3RHBK-6P3
2.2	9.2	3.7	7.5	10	130	100	100	50	BM3RHBK-010
2.2	9.2	5.5	11.5	13	169	100	100	50	BM3RHBK-013
3.7	15	7.5	14.5	16	208	100	50	35	BM3RHBK-016
3.7	15	7.5	14.5	20	260	100	50	35	BM3RHBK-020
5.5	22.5	11	21	25	325	100	50	35	BM3RHBK-025
7.5	29	15	27.5	32	416	100	50	35	BM3RHBK-032

Notes: * Motor full-load currents are based on FUJI's standard type totally-enclosed induction motors.

- Select appropriate thermal overload relay for starter.

• 63AF high breaking capacity, rotary handle type

Max. motor capacity and full-load current 3-phase *				Rated current In (A)	Instantaneous trip current (A)	Rated breaking capacity Icu (kA)			Type
200-240V AC		380-440V AC				240V AC	415V AC	440V AC	
(kW)	(A)	(kW)	(A)						
2.2	9.2	3.7	7.5	10	130	100	100	50	BM3VHBK-010
2.2	9.2	5.5	11.5	13	169	100	100	50	BM3VHBK-013
3.7	15	7.5	14.5	16	208	100	50	50	BM3VHBK-016
3.7	15	7.5	14.5	20	260	100	50	50	BM3VHBK-020
5.5	22.5	11	21	25	325	100	50	35	BM3VHBK-025
7.5	29	15	27.5	32	416	100	50	35	BM3VHBK-032
7.5	29	18.5	34	40	520	100	50	35	BM3VHBK-040
11	42	22	39	50	650	100	50	35	BM3VHBK-050
15	55	30	54	63	819	100	50	35	BM3VHBK-063

Notes: *1 Motor full-load currents are based on FUJI's standard type totally-enclosed induction motors.

- Select appropriate thermal overload relay for starter.

DUO series Manual Motor Starters

Ring terminal connection types

Adjustable thermal-magnetic trip types

Ring terminal connection types Adjustable thermal-magnetic trip types

■ Features

- Similar to FUJI MCCBs, the new type allows easy mounting and removal of the terminal cover, and up to two ring crimp terminals can be connected from the upper terminal part.
- Straight wiring connection is also possible in addition to ring terminal connection.
- The BM3RSR (0.16 to 32A rocker handle types) and BM3RHR (0.16 to 32A rotary handle types) are available.
- All optional accessories for standard manual motor starters can be mounted.
- The series conforms to IEC, UL and JIS standards, as do the standard manual motor starters.
- Crimp terminal insulation and a long terminal cover conforming to UL508 type E and F standards are available. (Purchased separately.)



■ Types and ratings

• 32AF standard breaking capacity, rocker handle types

Max. motor capacity and full-load current 3-phase *1				Rated current *2 In (A)	Thermal current setting range le (A)	Instantaneous trip current (A)	Rated breaking capacity Icu (kA)			Type
200-240V AC (kW) (A)		380-440V AC (kW) (A)					240V AC	415V AC	440V AC	
–	–	0.02	0.1	0.16	0.1–0.16	2.1	100	100	100	BM3RSR-P16
0.03	0.24	0.06	0.21	0.25	0.16–0.25	3.3	100	100	100	BM3RSR-P25
0.06	0.37	0.1	0.34	0.4	0.25–0.4	5.2	100	100	100	BM3RSR-P40
0.06	0.37	0.12	0.41	0.63	0.4–0.63	8.2	100	100	100	BM3RSR-P63
0.1	0.68	0.2	0.65	1	0.63–1	13	100	100	100	BM3RSR-001
0.2	1.3	0.4	1.15	1.6	1–1.6	20.8	100	100	100	BM3RSR-1P6
0.4	2.3	0.75	1.8	2.5	1.6–2.5	32.5	100	100	100	BM3RSR-2P5
0.75	3.6	1.5	3.1	4	2.5–4	52	100	100	100	BM3RSR-004
1.5	6.1	2.2	4.6	6.3	4–6.3	81.9	100	100	50	BM3RSR-6P3
2.2	9.2	3.7	7.5	10	6.3–10	130	100	100	15	BM3RSR-010
2.2	9.2	5.5	11.5	13	9–13	169	100	50	10	BM3RSR-013
3.7	15	7.5	14.5	16	11–16	208	100	25	10	BM3RSR-016
3.7	15	7.5	15	20	14–20	260	50	25	10	BM3RSR-020
5.5	22.5	11	21	25	19–25	325	50	25	10	BM3RSR-025
7.5	29	15	27.5	32	24–32	416	50	25	10	BM3RSR-032

Notes: *1 Motor full-load currents are based on FUJI's standard type totally-enclosed induction motors.
*2 Max. thermal current setting value

• 32AF high breaking capacity, rotary handle types

Max. motor capacity and full-load current 3-phase *1				Rated current *2 In (A)	Thermal current setting range le (A)	Instantaneous trip current (A)	Rated breaking capacity Icu (kA)			Type
200-240V AC (kW) (A)		380-440V AC (kW) (A)					240V AC	415V AC	440V AC	
–	–	0.02	0.1	0.16	0.1–0.16	2.1	100	100	100	BM3RHR-P16
0.03	0.24	0.06	0.21	0.25	0.16–0.25	3.3	100	100	100	BM3RHR-P25
0.06	0.37	0.1	0.34	0.4	0.25–0.4	5.2	100	100	100	BM3RHR-P40
0.06	0.37	0.12	0.41	0.63	0.4–0.63	8.2	100	100	100	BM3RHR-P63
0.1	0.68	0.2	0.65	1	0.63–1	13	100	100	100	BM3RHR-001
0.2	1.3	0.4	1.15	1.6	1–1.6	20.8	100	100	100	BM3RHR-1P6
0.4	2.3	0.75	1.8	2.5	1.6–2.5	32.5	100	100	100	BM3RHR-2P5
0.75	3.6	1.5	3.1	4	2.5–4	52	100	100	100	BM3RHR-004
1.5	6.1	2.2	4.6	6.3	4–6.3	81.9	100	100	100	BM3RHR-6P3
2.2	9.2	3.7	7.5	10	6.3–10	130	100	100	50	BM3RHR-010
2.2	9.2	5.5	11.5	13	9–13	169	100	100	50	BM3RHR-013
3.7	15	7.5	14.5	16	11–16	208	100	50	35	BM3RHR-016
3.7	15	7.5	14.5	20	14–20	260	100	50	35	BM3RHR-020
5.5	22.5	11	21	25	19–25	325	100	50	35	BM3RHR-025
7.5	29	15	27.5	32	24–32	416	100	50	35	BM3RHR-032

Notes: *1 Motor full-load currents are based on FUJI's standard type totally-enclosed induction motors.
*2 Max. thermal current setting value

DUO series Manual Motor Starters

Ring terminal connection types

Instantaneous trip types

• 32AF high breaking capacity, rotary handle type

Max. motor capacity and full-load current 3-phase *1				Rated current In (A)	Instantaneous trip current (A)	Rated breaking capacity Icu (kA)			Type
200-240V AC (kW) (A)		380-440V AC (kW) (A)				240V AC	415V AC	440V AC	
–	–	0.02	0.1	0.16	2.1	100	100	100	BM3RHRK-P16
0.03	0.24	0.06	0.21	0.25	3.3	100	100	100	BM3RHRK-P25
0.06	0.37	0.1	0.34	0.4	5.2	100	100	100	BM3RHRK-P40
0.06	0.37	0.12	0.41	0.63	8.2	100	100	100	BM3RHRK-P63
0.1	0.68	0.2	0.65	1	13	100	100	100	BM3RHRK-001
0.2	1.3	0.4	1.15	1.6	20.8	100	100	100	BM3RHRK-1P6
0.4	2.3	0.75	1.8	2.5	32.5	100	100	100	BM3RHRK-2P5
0.75	3.6	1.5	3.1	4	52	100	100	100	BM3RHRK-004
1.5	6.1	2.2	4.6	6.3	81.9	100	100	100	BM3RHRK-6P3
2.2	9.2	3.7	7.5	10	130	100	100	50	BM3RHRK-010
2.2	9.2	5.5	11.5	13	169	100	100	50	BM3RHRK-013
3.7	15	7.5	14.5	16	208	100	50	35	BM3RHRK-016
3.7	15	7.5	14.5	20	260	100	50	35	BM3RHRK-020
5.5	22.5	11	21	25	325	100	50	35	BM3RHRK-025
7.5	29	15	27.5	32	416	100	50	35	BM3RHRK-032

Notes: *1 Motor full-load currents are based on FUJI's standard type totally-enclosed induction motors.

*2 Max. thermal current setting value

■ Wirings

	Wire size (mm ²)	Ring crimp terminal max. width (mm)	Terminal screw	Tightening torque (N·m)
Line side	1 to 8	11 (R1.25-4 to R8-4)	M4	2
Load side	1 to 8	11 (R1.25-4 to R8-4)	M4	2

■ **UL listed**

FUJI MMS is certified for Group Installation according to UL508.

When it is used with a specific current rated BCP (Branch Circuit Protective Device) such as MCCB and Fuse, two or more motors can be connected to one branch circuit as in NEC 430.53.

The followings are some of the major rules for this application.

1. The Conductor size to the motor shall be the same as the branch circuit.

2. The Conductor size to the motor shall not be less than 1/3 of the branch circuit and the length from the BCP to the MMS must not be more than 7.5m (25 feet).

3. The MMS must be "Suitable for tap conductor Protection" and the Conductor size between the BCP and MMS shall not be less than 1/10 of the BCP and the length from the BCP to the MMS must not be more than 3m (10 feet).

4. The rating of the Fuse or MCCB must be smaller than the following table.

BM3RSB, BM3RSR

Adjustable current range Ie (A)	3-pole motor capacity in horsepower (HP)				Group installation			Max. Fuse / MCCB Rated current (A)
	AC				Breaking capacity (kA)			
	200-208V	220-240V	440-480V	550-600V	240V AC	480V AC	600V AC	
0.1-0.16	-	-	-	-	100	50	10	500
0.16-0.25	-	-	-	-	100	50	10	500
0.25-0.4	-	-	-	-	100	50	10	500
0.4-0.63	-	-	-	-	100	50	10	500
0.63-1	-	-	1/2	1/2	100	50	10	500
1-1.6	1/4	1/3	3/4	3/4	100	50	10	500
1.6-2.5	1/2	1/2	1	1-1/2	100	50	10	500
2.5-4	3/4	3/4	2	3	100	50	10	500
4-6.3	1	1-1/2	3	5	100	50	10	500
6.3-10	2	3	5	7-1/2	100	22	10	500
9-13	3	3	7-1/2	10	100	22	10	500
11-16	3	5	10	10	100	22	10	500
14-20	5	5	10	15	50	22	10	500
19-25	7-1/2	7-1/2	15	20	50	22	10	500
24-32	10	10	20	30	50	22	10	500

BM3RHB, BM3RHR

Adjustable current range Ie (A)	3-pole motor capacity in horsepower (HP)				Group installation			Max. Fuse / MCCB Rated current (A)
	AC				Breaking capacity (kA)			
	200-208V	220-240V	440-480V	550-600V	240V AC	480V AC	600V AC	
0.1-0.16	-	-	-	-	100	50	10	500
0.16-0.25	-	-	-	-	100	50	10	500
0.25-0.4	-	-	-	-	100	50	10	500
0.4-0.63	-	-	-	-	100	50	10	500
0.63-1	-	-	1/2	1/2	100	50	10	500
1-1.6	1/4	1/3	3/4	3/4	100	50	10	500
1.6-2.5	1/2	1/2	1	1-1/2	100	50	10	500
2.5-4	3/4	3/4	2	3	100	50	10	500
4-6.3	1	1-1/2	3	5	100	50	10	500
6.3-10	2	3	5	7-1/2	100	50	10	500
9-13	3	3	7-1/2	10	100	50	10	500
11-16	3	5	10	10	100	50	10	500
14-20	5	5	10	15	100	50	10	500
19-25	7-1/2	7-1/2	15	20	100	50	10	500
24-32	10	10	20	30	100	50	10	500

BM3VSB, BM3VHB

Adjustable current range Ie (A)	3-pole motor capacity in horsepower (HP)				Group installation			Max. Fuse / MCCB Rated current (A)
	AC				Breaking capacity (kA)			
	200-208V	220-240V	440-480V	550-600V	240V AC	480V AC *	600V AC	
6.3-10	2	3	5	7-1/2	100	50 (22)	10	600
9-13	3	3	7-1/2	10	100	50 (22)	10	600
11-16	3	5	10	10	100	50 (22)	10	600
14-20	5	5	10	15	100	50 (22)	10	600
19-25	7-1/2	7-1/2	15	20	100	50 (22)	10	600
24-32	10	10	20	30	100	50 (22)	10	600
28-40	10	10	30	30	100	50 (22)	10	600
35-50	15	15	30	40	100	50 (22)	10	600
45-63	20	20	40	60	100	50 (22)	10	600

* Value in () is for BM3VSB.

DUO series Manual Motor Starters

Characteristics curves

■ Characteristics curves

• BM3RSB, RHB, RSR, RHR

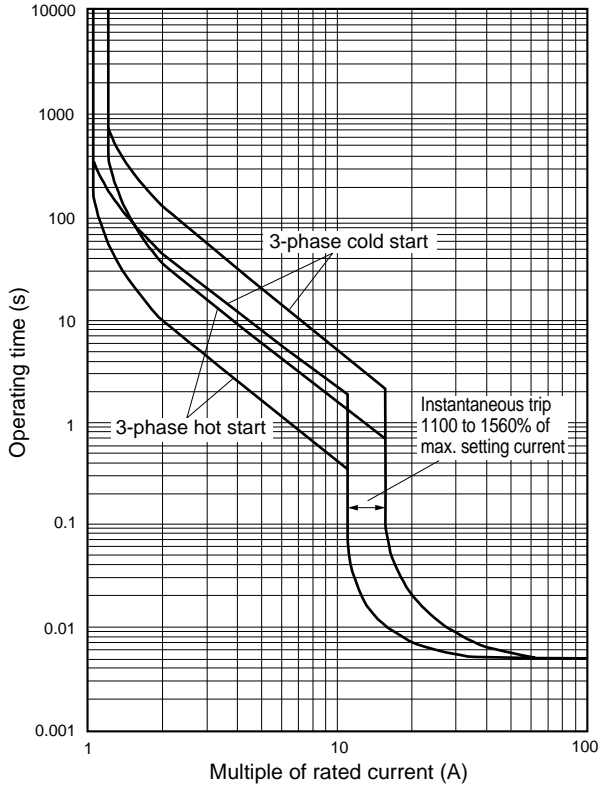

• BM3VSB, VHB

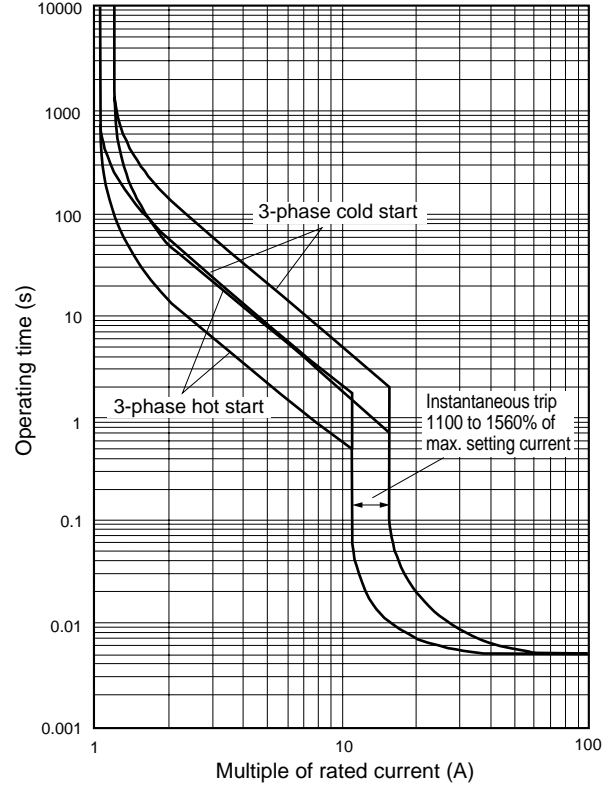

• BM3RHBK, RHRK

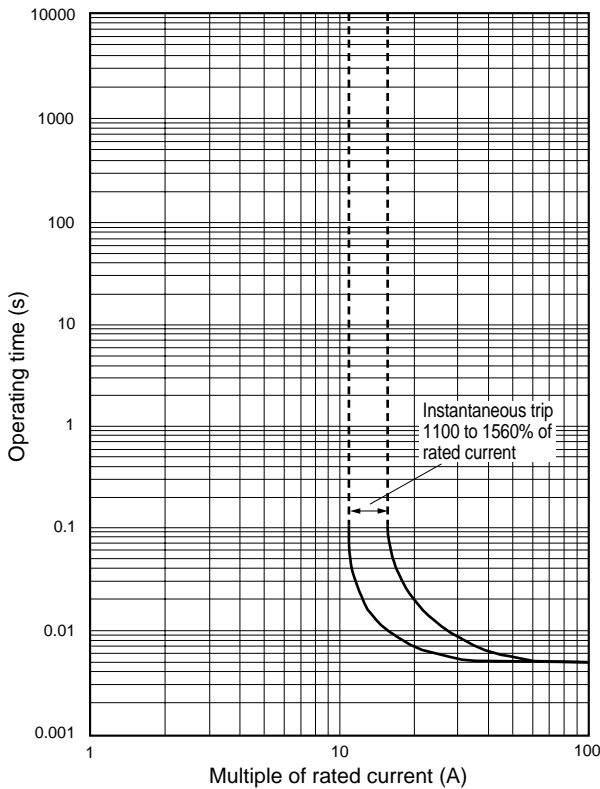

• BM3VHBK

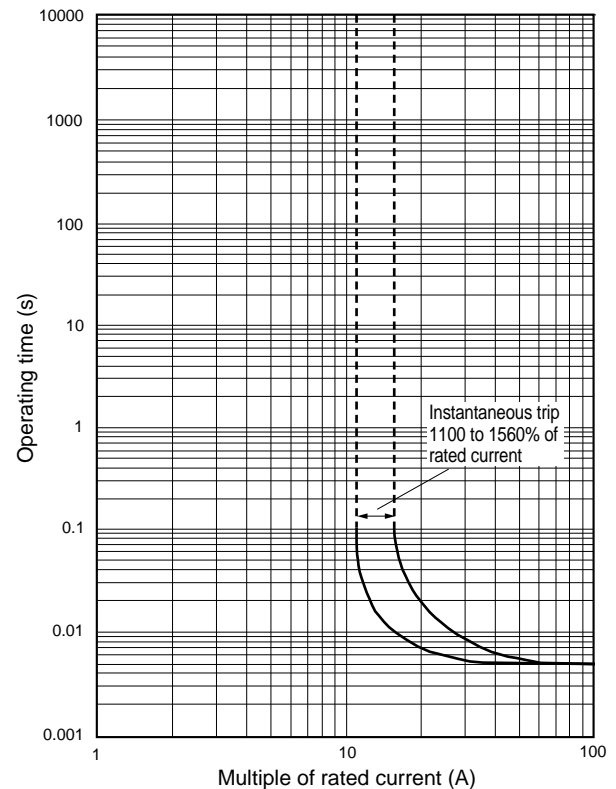

Optional accessories

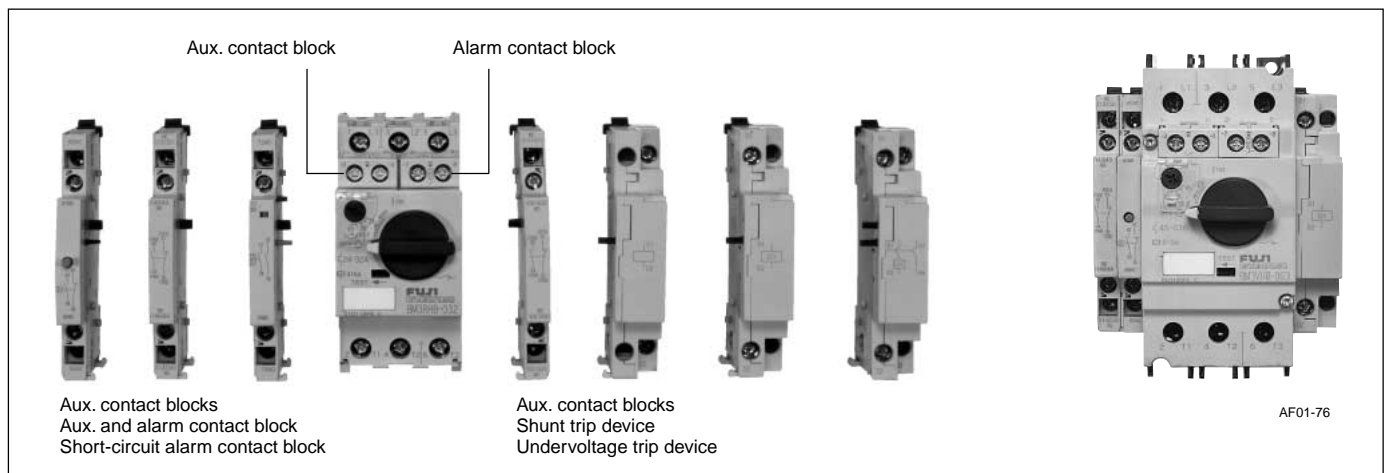

■ **Features**

- Auxiliary contact blocks, alarm contact blocks, and shunt/undervoltage trip devices can be used with BM3R (45mm wide) and BM3V (55mm wide) frames.
- Accessories are easily mounted.
- Internally mountable auxiliary contact blocks and alarm contact blocks can be frontally mounted.
- Externally mountable auxiliary contact blocks can be mounted on either the right or left side.
- Shunt trip and undervoltage trip devices are available in a wide operating coil voltage range.
- Standard and emergency external handles are available.
- IP20 terminal cover prevents accidental finger touch to electrically charged parts.



■ **Types and ratings**

• **Auxiliary contact blocks/W**

Description	Starter type	Mounting	Contact arrangement	Type	Mass (g)
 AF01-60L  AF01-59, 01-58 These blocks are linked to the ON/OFF operation of the MMS. Up to two internally mountable contact blocks can be mounted to the right/left front, and up to two externally mountable contact blocks can be mounted to the right/left sides.	BM3R BM3V	Front	1NO 1NC	BZ0WIA BZ0WIB	9
		Left side	2NO 1NO+1NC 2NC	BZ0WUABL BZ0WUBBL	45
		Right side	2NO 1NO+1NC 2NC	BZ0WUAAR BZ0WUABR BZ0WUBBR	45

• **Alarm contact blocks/K**

Description	Starter type	Mounting	Contact arrangement	Type	Mass (g)
 AF01-60R This block operates when the MMS trips due to overload, phase-loss, or short-circuit. It is not linked to the ON/OFF operation of the MMS. Note: Operation can be checked with the test trip function.	BM3R BM3V	Front (Right side only)	1NO 1NC	BZ0KIA BZ0KIB	9

DUO series Manual Motor Starters

Optional accessories

• Auxiliary and alarm contact blocks/WK

Description	Starter type	Mounting	Contact arrangement	Type	Mass (g)
 <p>• This contact block combines auxiliary contact and alarm contact that operates in the event of an overload, phase-loss, or short-circuit. Alarm contact is not linked to the ON/OFF operation of the MMS.</p> <p>• An alarm is displayed in the contact block's indicator when the alarm contact operates.</p> <p>Note: Operation can be checked with the test trip function.</p> <p>AF01-57</p>	BM3R BM3V	Left	1NO (Aux.)+ 1NO (Alarm)	BZ0WKUAA	45
			1NC (Aux.)+ 1NO (Alarm)	BZ0WKUBA	
			1NO (Aux.)+ 1NC (Alarm)	BZ0WKUAB	
			1NC (Aux.)+ 1NC (Alarm)	BZ0WKUBB	

• Short-circuit alarm contact blocks/KI

Description	Starter type	Mounting	Contact arrangement	Type	Mass (g)
 <p>• The contacts operate only when the MMS has tripped due to a short-circuit.</p> <p>• When these contacts operate, the blue reset button extends out, and a trip indication is displayed.</p> <p>• The power to the MMS can be ready to be turned on after pressing the reset button.</p> <p>Note: Operation can not be checked with the test trip function. Be sure to press the reset button before mounting to the MMS.</p> <p>AF01-56</p>	BM3R BM3V	Left	1NO+1NC	BZ0TKUAB	45

• Shunt trip devices/F



Description	Starter type	Mounting	Coil voltage	Type	Mass (g)
 <p>This device is used to remotely trip the MMS.</p> <p>Notes:</p> <ul style="list-style-type: none"> • This device cannot be used together with an undervoltage trip device. • When the MMS has been tripped with the shunt trip device, press the reset button before turning on the power. <p>AF01-55</p>	BM3R BM3V	Right	24V 50/60Hz 48V 60Hz 48V 50Hz/60V 60Hz	BZ0FAZU BZ0FBZU BZ0FCZU	115
			100V 50Hz/100–110V 60Hz 110–127V 50Hz/120V 60Hz 200V 50Hz/200–220V 60Hz 220–230V 50Hz/240–260V 60Hz 240V 50Hz/277V 60Hz	BZ0F1ZU BZ0FDZU BZ0FEZU BZ0FFZU BZ0FGZU	
			380–400V 50Hz/400–440V 60Hz 415–440V 50Hz/460–480V 60Hz 500V 50Hz/600V 60Hz 24–60V DC * 110–240V DC *	BZ0FHZU BZ0F4ZU BZ0FJZU BZ0FKZUD BZ0FLZUD	

Note: * The time rating of coil is 5s.

• Undervoltage trip devices/R



Description	Starter type	Mounting	Coil voltage	Type	Mass (g)
 <p>R types This device automatically trips the MMS when the control circuit voltage drops below the specified value.</p> <p>Notes:</p> <ul style="list-style-type: none"> • This device cannot be used together with a shunt trip device. • When the MMS has been tripped with the undervoltage trip device, press the reset button before turning on the power. <p>AF01-54</p>	BM3R BM3V	Right	24V 50Hz 24V 60Hz 48V 50Hz 48V 60Hz	BZ0RAZ1U BZ0RAZ2U BZ0RBZ1U BZ0RBZU	115
			100V 50Hz/100–110V 60Hz 110–127V 50Hz/120V 60Hz 200V 50Hz/200–220V 60Hz 220–230V 50Hz/240–260V 60Hz 240V 50Hz/277V 60Hz	BZ0R1ZU BZ0RDZU BZ0REZU BZ0RFZU BZ0RGZU	
			380–400V 50Hz/400–440V 60Hz 415–440V 50Hz/460–480V 60Hz 500V 50Hz/600V 60Hz	BZ0RHZU BZ0R4ZU BZ0RJZU	

• Undervoltage trip device with early make contacts/Re



Description	Starter type	Mounting	Coil voltage	Type	Mass (g)
 <p>AF01-52</p> <p>This device automatically trips the MMS when the control circuit voltage drops below the specified value. The control circuit voltage can be turned completely off by turning off the MMS.</p> <p>Notes:</p> <ul style="list-style-type: none"> • This device cannot be used together with a shunt trip device. • When the MMS has been tripped with the undervoltage trip device, press the reset button before turning on the power. 	BM3RS	Right	24V 50Hz 24V 60Hz 48V 50Hz 48V 60Hz 100V 50Hz/100–110V 60Hz 110–127V 50Hz/120V 60Hz 200V 50Hz/200–220V 60Hz 220–230V 50Hz/240–260V 60Hz 240V 50Hz/277V 60Hz 380–400V 50Hz/400–440V 60Hz 415–440V 50Hz/460–480V 60Hz 500V 50Hz/600V 60Hz	BZ0RAZ1LKU BZ0RAZ2LKU BZ0RBZ1LKU BZ0RBZLKU BZ0R1ZLKU BZ0RDZLKU BZ0REZLKU BZ0RFZLKU BZ0RGZLKU BZ0RHZLKU BZ0R4ZLKU BZ0RJZLKU	115
	 <p>AF01-53</p>	BM3RH BM3V	Right	24V 50Hz 24V 60Hz 48V 50Hz 48V 60Hz 100V 50Hz/100–110V 60Hz 110–127V 50Hz/120V 60Hz 200V 50Hz/200–220V 60Hz 220–230V 50Hz/240–260V 60Hz 240V 50Hz/277V 60Hz 380–400V 50Hz/400–440V 60Hz 415–440V 50Hz/460–480V 60Hz 500V 50Hz/600V 60Hz	BZ0RAZ1LTU BZ0RAZ2LTU BZ0RBZ1LTU BZ0RBZLTU BZ0R1ZLTU BZ0RDZLTU BZ0REZLTU BZ0RFZLTU BZ0RGZLTU BZ0RHZLTU BZ0R4ZLTU BZ0RJZLTU

Note: Refer to page 02/24 for details on how this device operates with the MMS, and on its external connection.

• External operating handles

Description	Starter type	Handle type	Type	Mass (g)	
 <p>KK02-305</p>  <p>KK02-306</p> <ul style="list-style-type: none"> • Used to operate an MMS installed inside a panel, from the outside of the panel. • Equipped with an interlock mechanism that prevents someone from mistakenly opening the panel door when the MMS is in the ON state. • The shaft can be cut to match the distance between the MMS and the panel door. • Door interlock function • OFF lock function • Can be locked OFF with up to three padlocks. Note: Padlocks are to be provided by the customer. • Release screw allows the door to be opened with the handle in the ON position. • IP54 protection degree 	BM3RH	Standard (black)	BZ0VBBL	160	
			Emergency (red handle on yellow plate)	BZ0VYRL	160
		BM3V	Standard (black)	BZ0VBMM	160
			Emergency (red handle on yellow plate)	BZ0VYRM	160



• Others

Description	Starter type	Type	Mass (g)
<p>Push-in lug</p>  <p>Used for screw mounting.</p>	BM3R	BZ0SET (10 pcs)	2.0 piece
<p>Terminal cover for IP20</p>  <p>Prevents accidental finger touch to charged parts.</p>	BM3V	BZ0TCV (6 pcs)	0.6 piece
<p>Open space cover</p>  <p>KK02-39</p> <ul style="list-style-type: none"> • Used to cover the open space if an internally mountable accessory become unnecessary. • Mounts to either the left-front or right-front position. 	BM3R BM3V	BZ0CFG (10 pcs)	1.4 piece

DUO series Manual Motor Starters

Optional accessories

• Others

Description	Starter type	Type	Mass (g)
Power supply side terminal cover  <ul style="list-style-type: none"> When mounted on the power supply side and combined with the optional BZ0TKUAB short-circuit alarm contact block, the configuration conforms to UL508 type E and F standards. 	BM3RSB BM3RHB	BZ0TCRE	30 per piece
Long terminal cover  <p style="text-align: center;">KK04-059</p> <ul style="list-style-type: none"> Prevents exposure between crimp terminals and finger contact Mountable to both power supply and load sides Straight wiring connection is also possible in addition to ring terminal connection. When mounted on the power supply side and combined with the optional BZ0TKUAB short-circuit alarm contact block, the configuration conforms to UL508 type E and F standards. Minimum quantity: 2 pieces (1 set) 	BM3RSR BM3RHR	BZ0RCRE	11 per piece

■ Ratings of accessories

Accessory type		Auxiliary contact block/front	Auxiliary contact block/side	Alarm contact block	Aux. and alarm contact block	Short-circuit alarm contact block
		BZ0WI	BZ0WU	BZ0KI	BZ0WKU	BZ0TKUAB
Standard		IEC 60947-5-1, UL 508				
Rated operational current (A)	48V AC AC-15	5	6	5	6	6
	125V AC	3	4	3	4	4
	230V AC	1.5	4	1.5	4	4
	400V AC	–	2.2	–	2.2	2.2
	500V AC	–	1.5	–	1.5	1.5
	690V AC	–	0.6	–	0.6	0.6
	48V DC DC-13	1.38	5	1.38	5	5
110V DC	0.55	1.3	0.55	1.3	1.3	
220V DC	0.27	0.5	0.27	0.5	0.5	
Contact rating code UL 508		B300 Q300	A600 P300	B300 Q300	A600 P300	A600 P300
Min. voltage and current		17V 5mA				

Accessory type		Shunt trip device	Undervoltage device
		BZ0F	BZ0R
Standard		IEC 60947-1, UL 508	
Rated insulation voltage (V AC)	IEC 60947	690	
	UL 508	600	
Operation performance capability (operations)		5000	
Operating time (ms)		20	
Power consumption	Inrush (VA/W)	21/12	
	Shealed (VA/W)	8/1.2	
Voltage range	Tripping voltage (V)	0.7 to 1.1Ue	
	Closing voltage (V)	–	
Time rating of coil (s)	AC	Continuous	
	DC	5	
		AC: Continuous DC: –	

■ Available accessory configuration

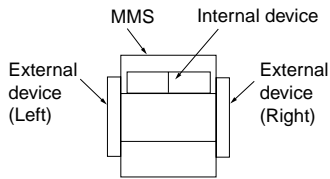

Internal devices

- Auxiliary contact block (W)
- Alarm contact block (K)

External devices

- Auxiliary contact (W2)
- Auxiliary and alarm contact block (WK)
- Short-circuit alarm contact block (KI)
- Shunt trip device (F)
- Undervoltage trip device (R) or undervoltage trip device with early make contacts (Re)

Adj. thermal-magnetic trip type MMS		BM3RSB, BM3RHB, BM3RSR, BM3RHR						BM3VSB, BM3VHB					
Instantaneous trip type MMS		BM3RHBK, BM3RHRK						BM3VHBK					
Internal accessory		<input type="checkbox"/>	<input type="checkbox"/>	<input type="checkbox"/>	<input checked="" type="checkbox"/>	<input type="checkbox"/>	<input type="checkbox"/>	<input type="checkbox"/>	<input type="checkbox"/>	<input type="checkbox"/>	<input checked="" type="checkbox"/>	<input type="checkbox"/>	<input type="checkbox"/>
			W	W	K	W+W	W+K		W	W	K	W+W	W+K
External accessory	W2 (Left)	<input type="checkbox"/>	<input type="checkbox"/>	<input type="checkbox"/>	<input checked="" type="checkbox"/>	<input type="checkbox"/>	<input type="checkbox"/>	<input type="checkbox"/>	<input type="checkbox"/>	<input type="checkbox"/>	<input checked="" type="checkbox"/>	<input type="checkbox"/>	<input type="checkbox"/>
	W2 (Right)	<input type="checkbox"/>	<input type="checkbox"/>	<input type="checkbox"/>	<input checked="" type="checkbox"/>	<input type="checkbox"/>	<input type="checkbox"/>	<input type="checkbox"/>	<input type="checkbox"/>	<input type="checkbox"/>	<input checked="" type="checkbox"/>	<input type="checkbox"/>	<input type="checkbox"/>
	WK (Left)	<input type="checkbox"/>	<input type="checkbox"/>	<input type="checkbox"/>	<input checked="" type="checkbox"/>	<input type="checkbox"/>	<input type="checkbox"/>	<input type="checkbox"/>	<input type="checkbox"/>	<input type="checkbox"/>	<input checked="" type="checkbox"/>	<input type="checkbox"/>	<input type="checkbox"/>
	KI (Left)	<input type="checkbox"/>	<input type="checkbox"/>	<input type="checkbox"/>	<input checked="" type="checkbox"/>	<input type="checkbox"/>	<input type="checkbox"/>	<input type="checkbox"/>	<input type="checkbox"/>	<input type="checkbox"/>	<input checked="" type="checkbox"/>	<input type="checkbox"/>	<input type="checkbox"/>
	F (Right)	<input type="checkbox"/>	<input type="checkbox"/>	<input type="checkbox"/>	<input checked="" type="checkbox"/>	<input type="checkbox"/>	<input type="checkbox"/>	<input type="checkbox"/>	<input type="checkbox"/>	<input type="checkbox"/>	<input checked="" type="checkbox"/>	<input type="checkbox"/>	<input type="checkbox"/>
	R (Re) (Right)	<input type="checkbox"/>	<input type="checkbox"/>	<input type="checkbox"/>	<input checked="" type="checkbox"/>	<input type="checkbox"/>	<input type="checkbox"/>	<input type="checkbox"/>	<input type="checkbox"/>	<input type="checkbox"/>	<input checked="" type="checkbox"/>	<input type="checkbox"/>	<input type="checkbox"/>
	W2 (Left)+F	<input type="checkbox"/>	<input type="checkbox"/>	<input type="checkbox"/>	<input checked="" type="checkbox"/>	<input type="checkbox"/>	<input type="checkbox"/>	<input type="checkbox"/>	<input type="checkbox"/>	<input type="checkbox"/>	<input checked="" type="checkbox"/>	<input type="checkbox"/>	<input type="checkbox"/>
	W2 (Left)+R (Re)	<input type="checkbox"/>	<input type="checkbox"/>	<input type="checkbox"/>	<input checked="" type="checkbox"/>	<input type="checkbox"/>	<input type="checkbox"/>	<input type="checkbox"/>	<input type="checkbox"/>	<input type="checkbox"/>	<input checked="" type="checkbox"/>	<input type="checkbox"/>	<input type="checkbox"/>
	WK+F	<input type="checkbox"/>	<input type="checkbox"/>	<input type="checkbox"/>	<input checked="" type="checkbox"/>	<input type="checkbox"/>	<input type="checkbox"/>	<input type="checkbox"/>	<input type="checkbox"/>	<input type="checkbox"/>	<input checked="" type="checkbox"/>	<input type="checkbox"/>	<input type="checkbox"/>
	WK+R (Re)	<input type="checkbox"/>	<input type="checkbox"/>	<input type="checkbox"/>	<input checked="" type="checkbox"/>	<input type="checkbox"/>	<input type="checkbox"/>	<input type="checkbox"/>	<input type="checkbox"/>	<input type="checkbox"/>	<input checked="" type="checkbox"/>	<input type="checkbox"/>	<input type="checkbox"/>
	KI+F	<input type="checkbox"/>	<input type="checkbox"/>	<input type="checkbox"/>	<input checked="" type="checkbox"/>	<input type="checkbox"/>	<input type="checkbox"/>	<input type="checkbox"/>	<input type="checkbox"/>	<input type="checkbox"/>	<input checked="" type="checkbox"/>	<input type="checkbox"/>	<input type="checkbox"/>
	KI+R (Re)	<input type="checkbox"/>	<input type="checkbox"/>	<input type="checkbox"/>	<input checked="" type="checkbox"/>	<input type="checkbox"/>	<input type="checkbox"/>	<input type="checkbox"/>	<input type="checkbox"/>	<input type="checkbox"/>	<input checked="" type="checkbox"/>	<input type="checkbox"/>	<input type="checkbox"/>
	W2 (Left)+W2 (Left)	<input type="checkbox"/>	<input type="checkbox"/>	<input type="checkbox"/>	<input checked="" type="checkbox"/>	<input type="checkbox"/>	<input type="checkbox"/>	<input type="checkbox"/>	<input type="checkbox"/>	<input type="checkbox"/>	<input checked="" type="checkbox"/>	<input type="checkbox"/>	<input type="checkbox"/>
	W2 (Left)+W2 (Right)	<input type="checkbox"/>	<input type="checkbox"/>	<input type="checkbox"/>	<input checked="" type="checkbox"/>	<input type="checkbox"/>	<input type="checkbox"/>	<input type="checkbox"/>	<input type="checkbox"/>	<input type="checkbox"/>	<input checked="" type="checkbox"/>	<input type="checkbox"/>	<input type="checkbox"/>

Note: Do not use an alarm contact block/K together with an undervoltage trip device with early make contacts/Re for the BM3RSB frame. If used together, the alarm contact block will not operate correctly when the MMS is automatically tripped due to undervoltage.

DUO series Manual Motor Starters

Optional accessories

■ Available accessory configuration (continued)

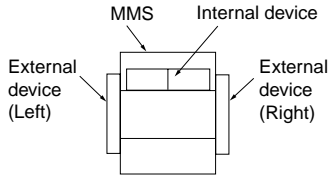

Internal devices

□ Auxiliary contact block (W) ◻ Alarm contact block (K)

External devices

◻ Auxiliary contact (W2) ◻ Auxiliary and alarm contact block (WK) ◻ Short-circuit alarm contact block (KI)
 ◻ Shunt trip device (F) ◻ Undervoltage trip device (R) or undervoltage trip device with early make contacts (Re)

Adj. thermal-magnetic trip type MMS	BM3RSB, BM3RHB, BM3RSR, BM3RSHR						BM3VSB, BM3VHB						
Instantaneous trip type MMS	BM3RHBK, BM3RHRK						BM3VHBK						
Internal accessory													
External accessory	W2 (Right)+ W2 (Right)												
	W2 (Left)+ WK												
	W2 (Right)+ WK												
	W2 (Left)+ KI												
	W2 (Right)+ KI												
	KI+WK												
	W2 (Left)+ W2 (Left)+F												
	W2 (Left)+ W2 (Left)+R (Re)												
	W2 (Left)+ WK+F												
	W2 (Left)+ WK+R (Re)												
	W2 (Left)+ KI+F												
	W2 (Left)+ KI+R (Re)												
	KI+WK+F												
	KI+WK+R (Re)												

Note: Do not use an alarm contact block/K together with an undervoltage trip device with early make contacts/Re for the BM3RSB frame. If used together, the alarm contact block will not operate correctly when the MMS is automatically tripped due to undervoltage.

■ Dimensions, mm

• Rocker handle types **BM3RSB, BM3RSR**

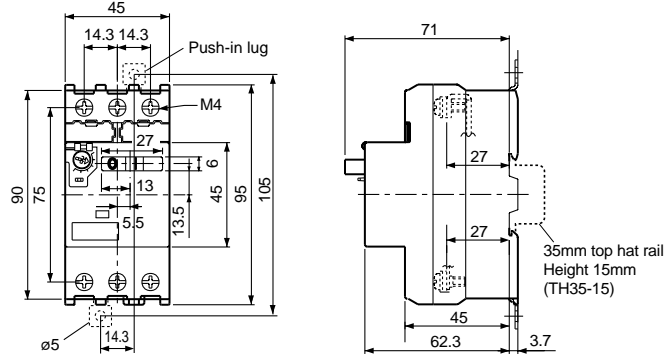

• Rotary handle types **BM3RHB, BM3RHR**

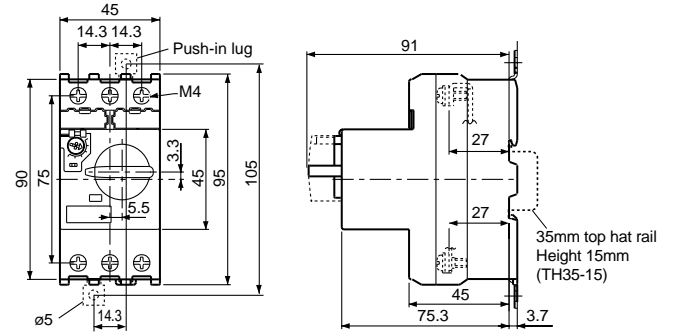

• Rotary handle types **BM3VSB, BM3VHB**

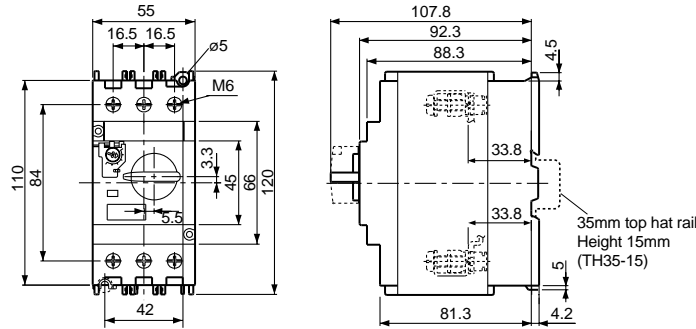

Accessories

• Auxiliary contact blocks, front mounting
BZ0WI

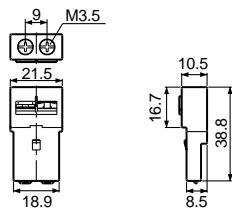

• Auxiliary contact blocks, side mounting
BZ0WU

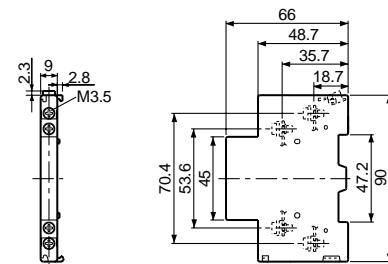

• Alarm contact blocks, front mounting
BZ0KI

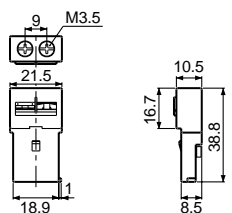

• Auxiliary and alarm contact blocks
BZ0WКУ

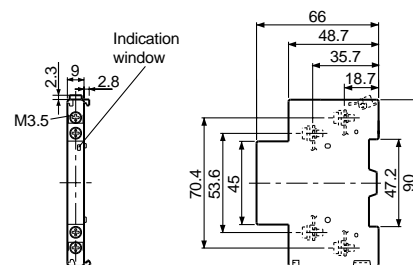

DUO series Manual Motor Starters

Dimensions

■ Dimensions, mm

Accessories

- Short-circuit alarm contact block
BZ0TKUAB

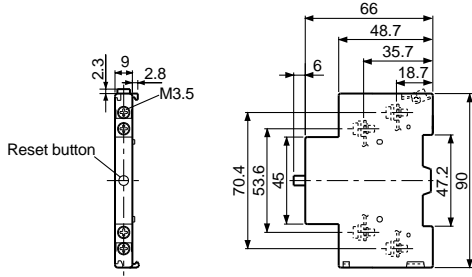

- Shunt trip devices BZ0F
- Undervoltage trip devices BZ0R

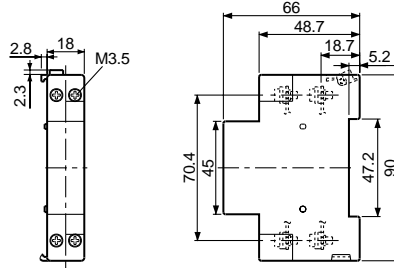

MMS with accessories

- BM3RSB + BZ0
- BM3RSR + BZ0

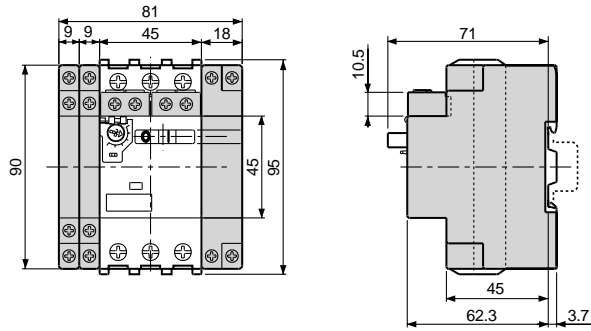

- BM3RSB + BZ0□LKU (Undervoltage trip device)
- BM3RSR + BZ0□LKU

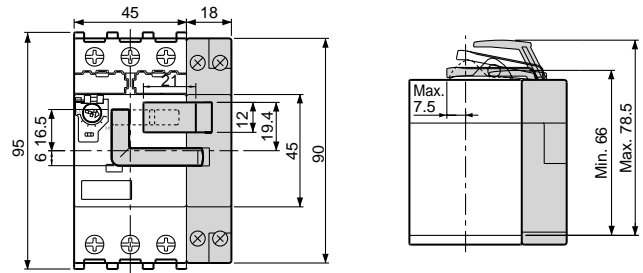

- BM3RHB + BZ0
- BM3RHR + BZ0

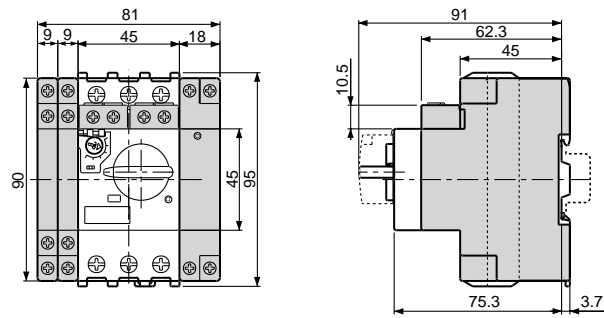

- BM3V□B + BZ0

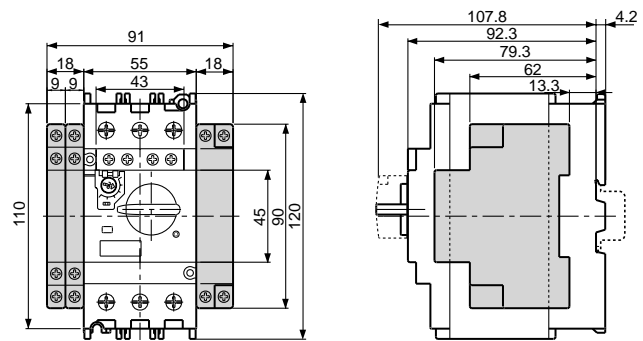

External operation handle BZ0V

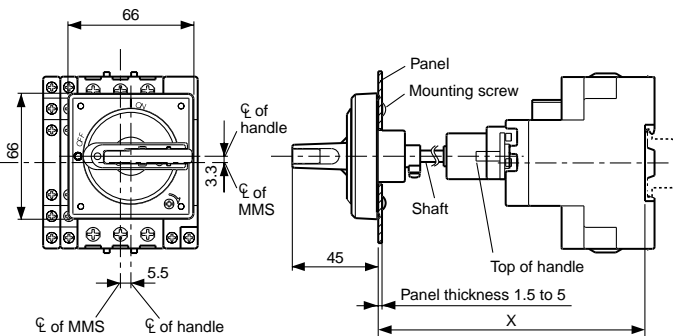

Type	X min.	X max.
BZ0VBBL, BZ0VYRL	139±2	289±2
BZ0VBBL, BZ0VYRM	156±2	306±2

Panel drilling

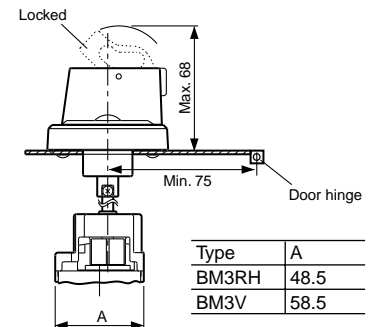
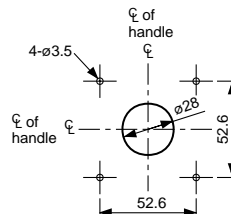

Type	A
BM3RH	48.5
BM3V	58.5

■ Dimensions, mm

• UL508 Type E

MMS + Terminal cover + short-circuit alarm contact block

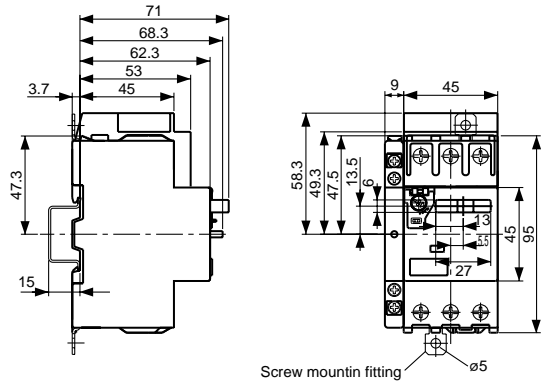

Terminal cover

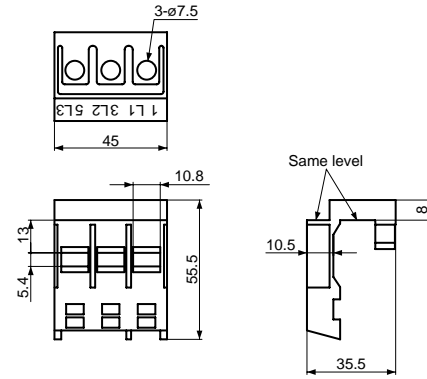

• MMS with long terminal cover

MMS + long terminal cover

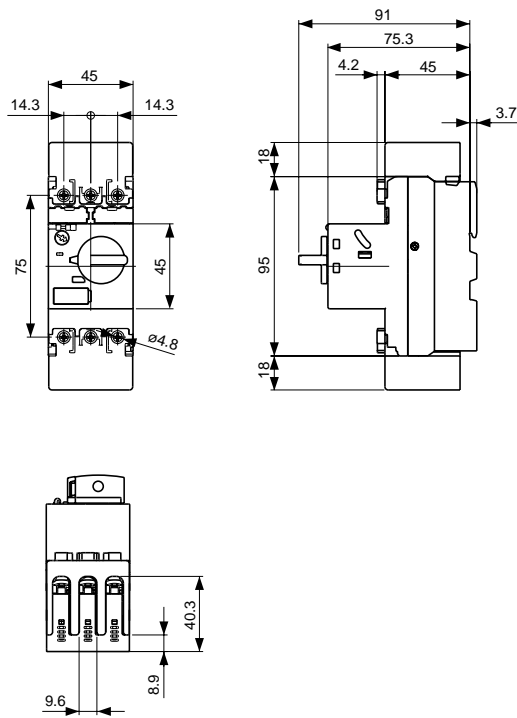

Long terminal cover

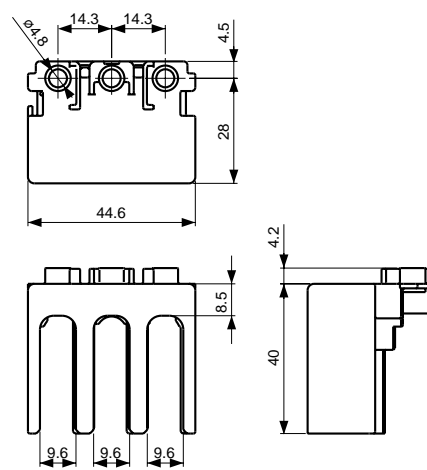

DUO series Manual Motor Starters

Wiring diagrams

■ Wiring diagrams

• MMS

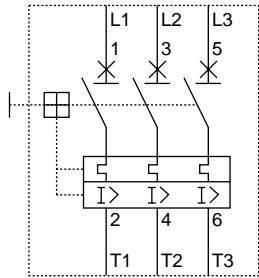

• Auxiliary contact blocks

Front mounting

BZ0WIA

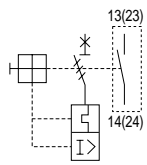

BZ0WIB

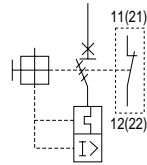

• Alarm contact blocks

Front mounting

BZ0KIA

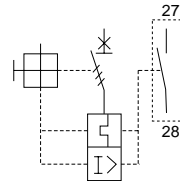

BZ0KIB

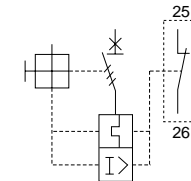

Side mounting

BZ0WUAAL

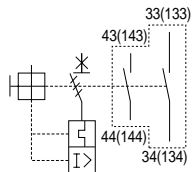

BZ0WUABL

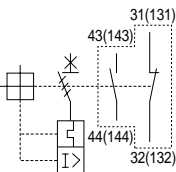

BZ0WUBBL

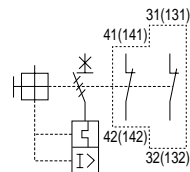

• Auxiliary and alarm contact blocks

BZ0WKUAA

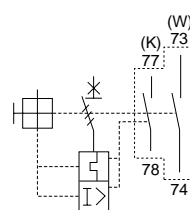

BZ0WKUBA

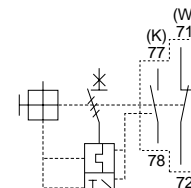

BZ0WUAAR

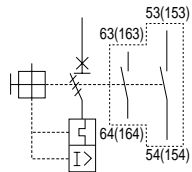

BZ0WUABR

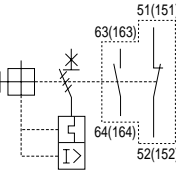

BZ0WUBBR

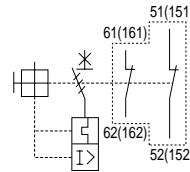

BZ0WKUAB

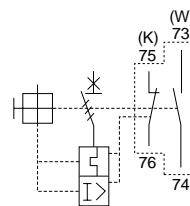

BZ0WKUBB

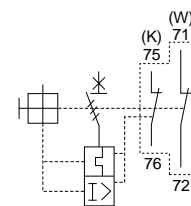

• Short-circuit alarm contact blocks

BZ0TKUAB

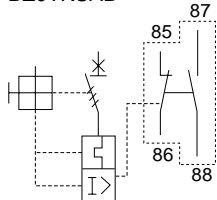

• Shunt trip devices

BZ0F

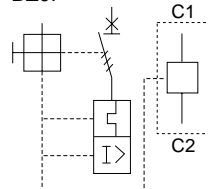

• Undervoltage trip devices

BZ0R

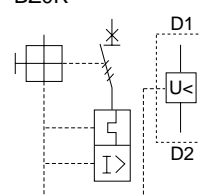

• Undervoltage trip devices with early make contacts

BZ0R

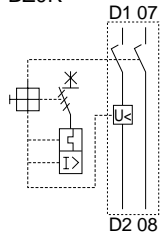

There may be no trip indication and no opening of the auxiliary contact even though the MMS is tripped due to short-circuit, overcurrent, or phase-loss.

External connection

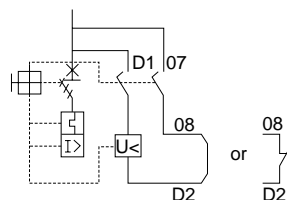

In addition to the functions of the undervoltage trip device, this device completely opens the main circuit and control circuit when the MMS is turned OFF. However, when the MMS is tripped by a drop in the control circuit voltage, it must be reset.

Standard operating conditions

Ambient temperature	Operating: -5 to +55°C Storage: -40 to +65°C	No sudden temperature changes resulting in condensation or icing.
Humidity	45 to 85%RH	
Altitude	2000m or lower	
Atmosphere	No excessive dust, smoke, corrosive gases, flammable gases, steam or salt.	
Vibration	10 to 55Hz 15m/s ²	No abnormal shock or vibration
Shock	50m/s ²	

Mountings

Rail mounting

The MMS can be mounted to a 35mm top hat rail. Secure the rail with screws at mounting pitch of less than 400mm for the BM3R type and less than 300mm for the BM3V type.

Applicable rail:

Use a 15mm-high TH35-15 rail conforming to EN-50022 and IEC715.

The standard rail mounting direction is horizontal. When using the MMS on a vertically mounted rail, use FUJI end clamp kits.

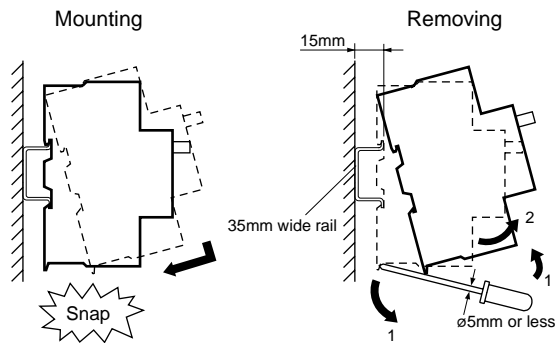

Screw mounting

The separately sold push-in lug (BZ0SET) is required for screw mounting the BM3R frame. The BM3V frame can be screw mounted directly to the panel.

BM3RSB, RSBK
BM3RHB, RHBK

BM3VSB, VSBK
BM3VHB, VHBK

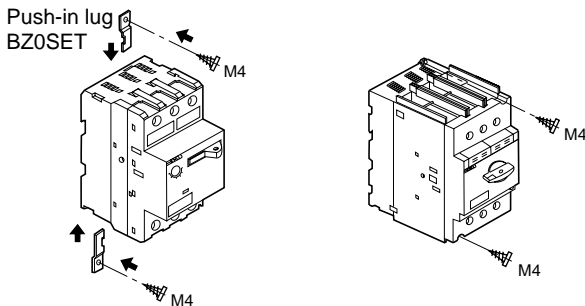

Mounting angle

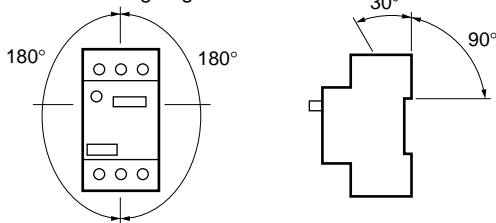

Arc space

The arc space required when mounting is shown in the table below.

Type	Rated operational voltage U _e (V)	Min. distance to grounded metal (mm)	
		A, B	C, D
BM3RS	Up to 460	15	20
	500	15	30
	Up to 690	40	40
BM3RH	Up to 500	15	30
	Up to 690	40	50
BM3V	Up to 500	15	40
	Up to 690	40	50

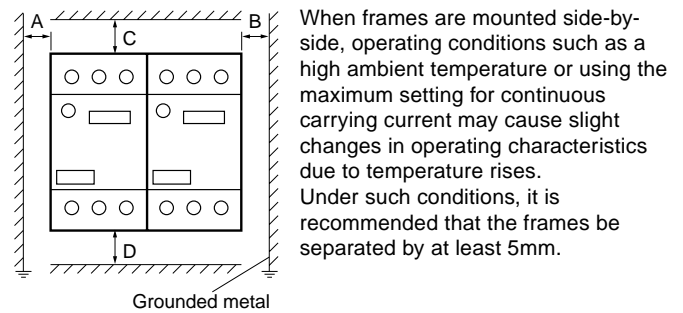

Wirings

While pressing the wire with a screwdriver, tighten the screw to the specified tightening torque.

Type	BM3R	BM3V	BZ0 Accessories
Solid wire (mm)	ø1.6 to 2.6	ø1.6 to 2.6	ø1 to 1.6
Stranded wire (mm ²)	Single-wire	1 to 10	1 to 25
	2-wire	1 to 6	1 to 16
AWG	Single-wire	18 to 8	18 to 4
	2-wire	18 to 10	18 to 4
Sheath stripping length (mm)	Approx.10	Approx.13	Approx.10
Terminal screw	Pan head screw (PZ2)	Pan head screw (PZ2)	Pan head screw (PZ2)
	M4	M6	M3.5
Tightening torque (N·m)	2	4	0.8

Note: There is no need for a crimp terminal or any other terminal on the end of the connection wire.

DUO series Manual Motor Starters

Busbar system



Busbar system

■ Features

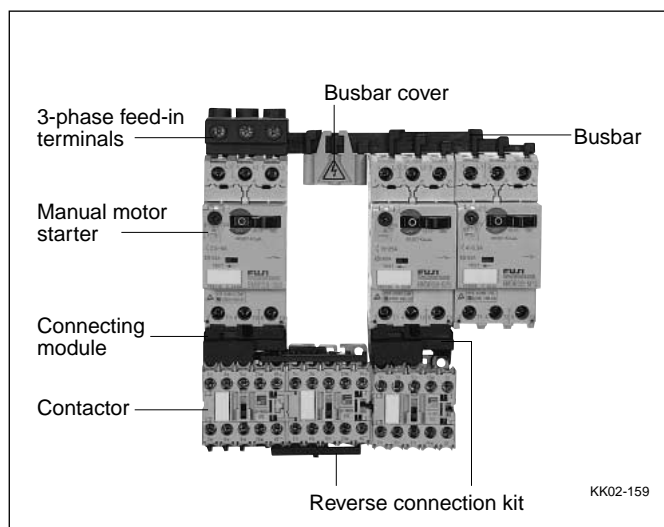
- The busbar system reduces wiring time and saves floorspace.
- The busbar makes it easy to power from 2 to 5 manual motor starters – with no wiring needed.
- The 3-phase feed-in terminals are used to connect the wire for the power supply circuit.
- The busbar cover guards against accidental touching of non-connected busbar terminals (charged parts).

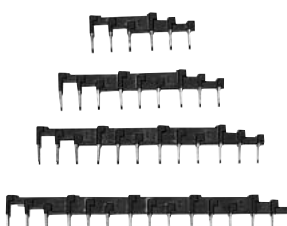

■ Types and ratings

Description	Used with	Specification	Type	Mass (g)	
 KK02-164	BM3R	Continuous current: 64A max. Pin connection *	2-BM3R, modular space: 45mm 3-BM3R, modular space: 45mm 4-BM3R, modular space: 45mm 5-BM3R, modular space: 45mm	BZ0BR02A BZ0BR03A BZ0BR04A BZ0BR05A	30 50 70 90
	BM3R+1-external accessory, 9mm wide		2-BM3R, modular space: 54mm 3-BM3R, modular space: 54mm 4-BM3R, modular space: 54mm 5-BM3R, modular space: 54mm	BZ0BR12A BZ0BR13A BZ0BR14A BZ0BR15A	30 55 80 105
	BM3R+2-external accessory, 9mm wide or BM3R+1-external accessory, 18mm wide	Continuous current: 64A max. Fork connection	2-BM3R, modular space: 63mm 4-BM3R, modular space: 63mm	BZ0BR22A BZ0BR24A	45 100
	BM3V	Continuous current: 126A max. Pin connection	2-BM3V, modular space: 55mm 3-BM3V, modular space: 55mm 4-BM3V, modular space: 55mm	BZ0BV02A BZ0BV03A BZ0BV04A	140 240 340
	BM3V+1-external accessory, 9mm wide		2-BM3V, modular space: 64mm 3-BM3V, modular space: 64mm 4-BM3V, modular space: 64mm	BZ0BV12A BZ0BV13A BZ0BV14A	150 270 380
	BM3V+2-external accessory, 9mm wide or BM3V+1-external accessory, 18mm wide		2-BM3V, modular space: 73mm 4-BM3V, modular space: 73mm	BZ0BV22A BZ0BV24A	165 425
	 AF01-70R	BM3R	Continuous current: 64A max. Applicable cable size: 25mm ² max.	BZ0BFRA	40
		BM3V	Continuous current: 126A max. Applicable cable size: 50mm ² max.	BZ0BFVA	170
	 AF01-70L	BZ0BR	For pin connection For fork connection	BZ0BCRA BZ0BCRB	10 5
		BZ0BV	For pin connection	BZ0BCVA	5

Notes: • When three or more busbar are used, a gap of 6mm will occur between the MMS at the connector point.
* Maximum number of MMS that can be mounted side by side using the two busbar (ex. BZ0BR05A × 2)

■ Dimensions, mm

• For BM3R

BZ0BR0 Without external accessory

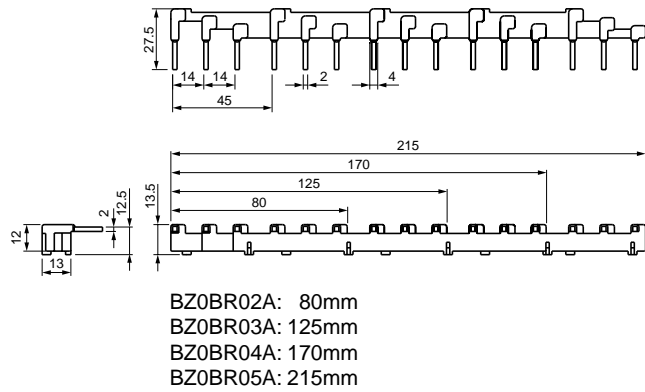

• For BM3V

BZ0BV0 Without external accessory

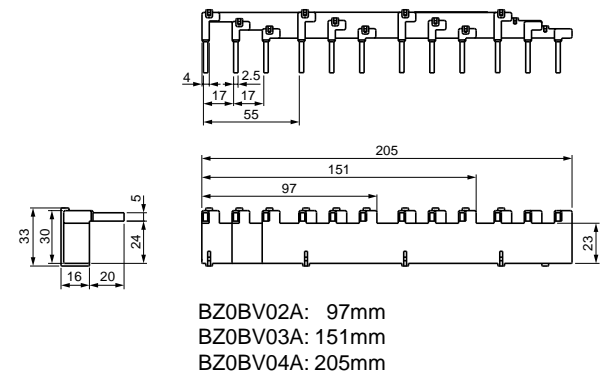

BZ0BR1 With 1-external accessory

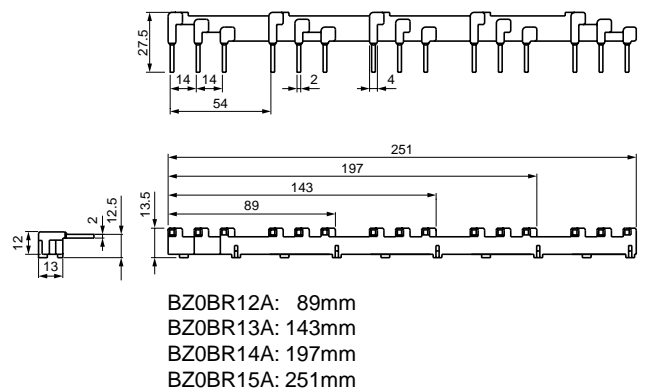

BZ0BV1 With 1-external accessory, 9mm wide

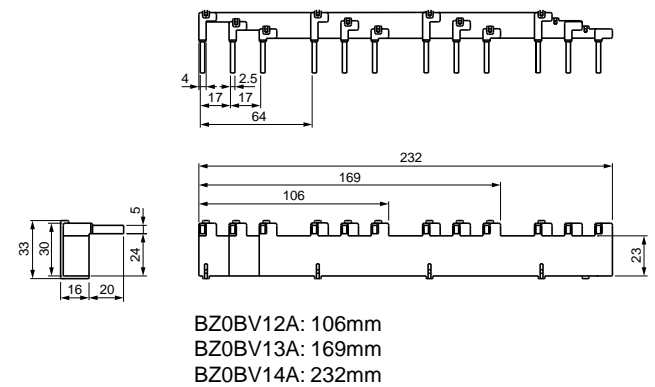

**BZ0BR2 With 2-external accessory, 9mm wide
 With 1-external accessory, 18mm wide**

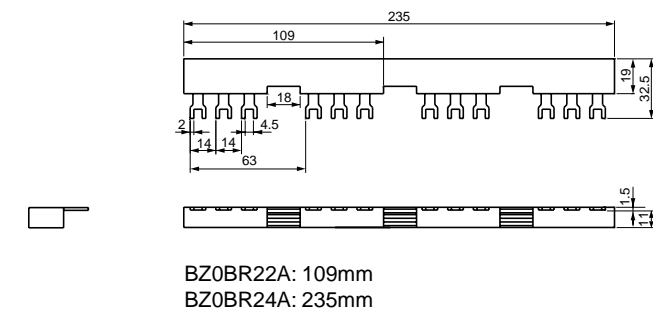

**BZ0BV2 With 2-external accessory, 9mm wide
 With 1-external accessory, 18mm wide**

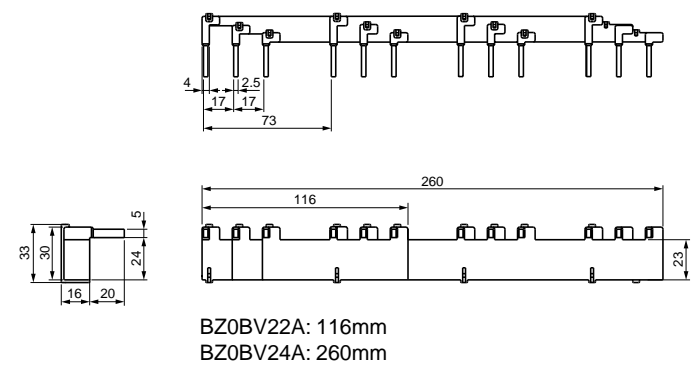

DUO series Manual Motor Starters Busbar system

■ Dimensions, mm
• 3-phase feed-in terminals
BZ0BFRA

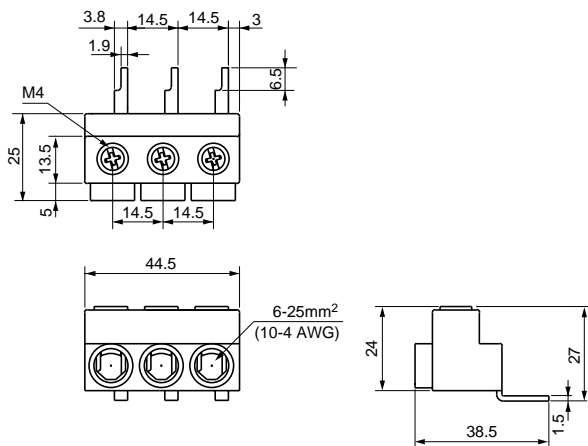

BZ0BFVA

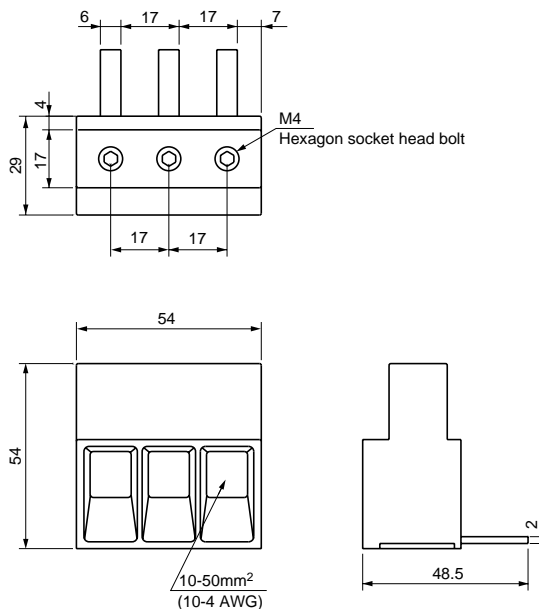

■ Busbar connection

• For BM3R

Example of two pin-connection busbars + 3-phase feed-in terminal

- (1) Insert the busbar 1 in the left side of MMS terminal screw. (2) Insert the busbar 2 in the right side of MMS terminal screw.

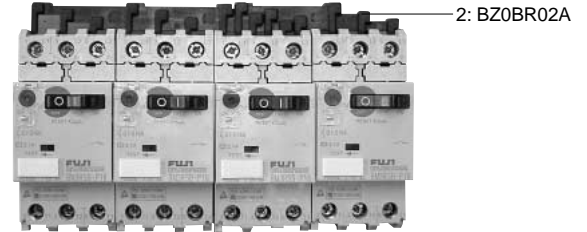

- (3) Attach the 3-phase feed-in terminal (BZ0BFRA) to the MMS from which the busbar has been inserted in the right side of terminal screw. (The mounting position of 3-phase feed-in terminal is same too even if one busbar is to be attached.)



Note: When three or more busbars are used, a gap of 6mm will occur as shown below. Please ask FUJI for details.

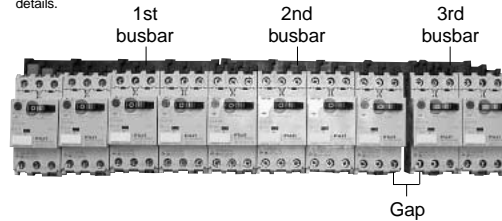

Example of two fork-connection busbars + 3-phase feed-in terminal



Note: When three or more busbars are to be connected, attach them on MMS, piling up and down as well as two busbars.

• For BM3V

Example of two busbars + 3-phase feed-in terminal

- (1) Insert the busbar 1 in the lower side of MMS terminal plate. (2) Insert the busbar 2 in the upper side of MMS terminal plate.

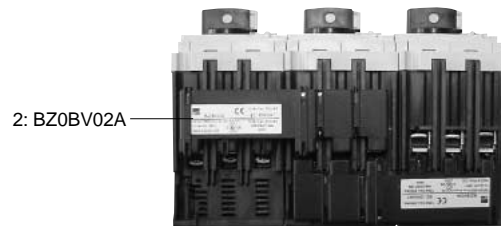

- (3) Attach the 3-phase feed-in terminal (BZ0BFVA) to the MMS from which the busbar has been inserted in the lower side of terminal plate. (The mounting position of 3-phase feed-in terminal is same too even if one busbar is to be attached.)



Note: When three or more busbars are to be connected, insert 3rd busbar or later up and down of the terminal plate alternately. (The MMSs are capable of side-by-side mounting.)

DUO series Manual Motor Starters Enclosures

Enclosures

■ Features

- Accommodates a variety of manual motor starters (BM3RSB-P16 to 025). Put the manual motor starter inside an enclosure for use in harsh environments. Surface mounting and flush mounting types available.
- IP41 and IP55 enclosure protection degree available
- Manual motor starters (BM3RSB-P16 to 025) equipped with internal accessories and the following external accessories can be used inside an enclosure.
 Left side: One auxiliary contact block or one auxiliary/ alarm contact block
 Right side: One shunt trip device or one undervoltage trip device
- A wide variety of enclosure accessories are available. Padlocking device, emergency mushroom pushbutton, conversion kit, and indicator lamps

■ Types and ratings

Enclosures for BM3RSB-P16 to 025

Mounting	Specification	Type	Mass (g)
Surface	IP41	BZ0CSLA	320
	IP55 (with conversion kit)	BZ0CSLB	340
Flush	IP41	BZ0CFLA	240
	IP55 (with conversion kit)	BZ0CFLB	260

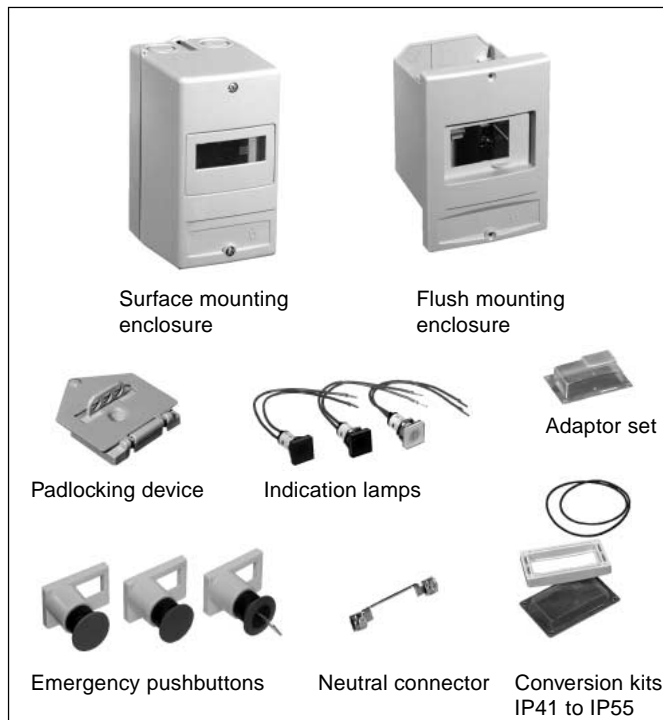

Accessories for enclosures

Description	Specification	Type	Mass (g)
Padlocking device	OFF locking possible using up to three padlocks with a 5 to 8mm shackle diameter.	BZ0CKA	90
Emergency stop pushbutton	Momentary Push-lock turn reset Key operated	BZ0CPM	55
		BZ0CPL	55
		BZ0CPK	90
Conversion kit	Converts IP41 to IP55	BZ0CCA	25
Adaptor set	For BM3RS + undervoltage trip device with auxiliary contact.	BZ0CUA	20
Neutral connector	Used inside the enclosure for neutral and ground connection.	BZ0CNA	10
Indication lamp	Green, 100–120V AC	BZ0CLGA	15
	Green, 200–240V AC	BZ0CLGB	15
	Green, 380–440V AC	BZ0CLGC	15
	Green, 480–500V AC	BZ0CLGD	15
	Green, 500–600V AC	BZ0CLGE	15
	Red, 100–120V AC	BZ0CLRA	15
	Red, 200–240V AC	BZ0CLRB	15
	Red, 380–440V AC	BZ0CLRC	15
	Red, 480–500V AC	BZ0CLRD	15
	Red, 500–600V AC	BZ0CLRE	15
	White, 100–120V AC	BZ0CLCA	15
	White, 200–240V AC	BZ0CLCB	15
	White, 380–440V AC	BZ0CLCC	15
	White, 480–500V AC	BZ0CLCD	15
	White, 500–600V AC	BZ0CLCE	15

Notes: • The padlocking device cannot be used together with the emergency stop pushbutton or undervoltage trip device with early make contact Re.
 • The emergency stop pushbutton cannot be used together with the undervoltage trip device with early make contact Re.

■ Dimensions, mm
• Surface mounting
For without accessory

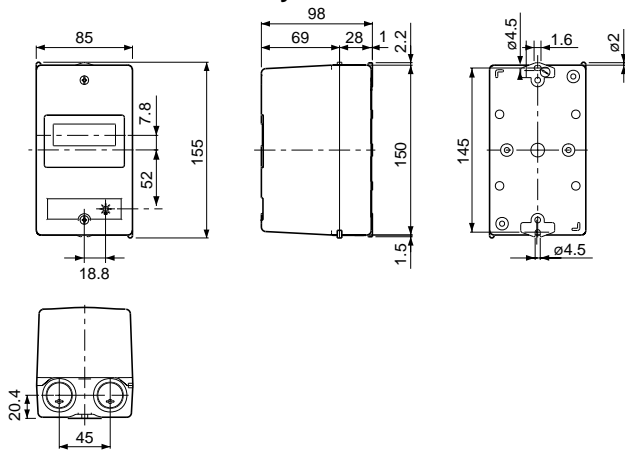

• Flush mounting
For without accessory

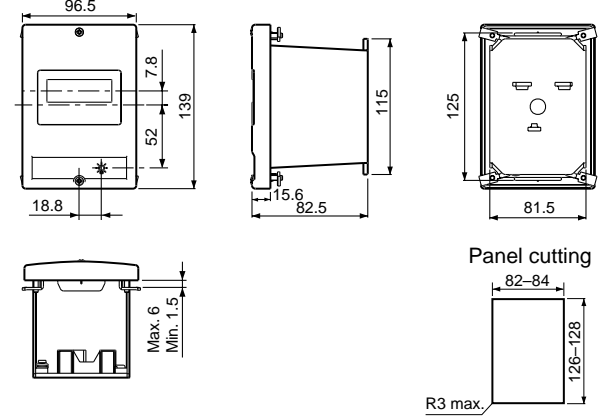

For with padlocking device

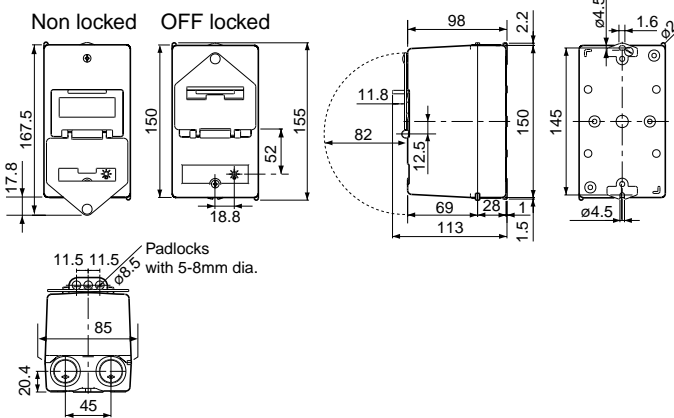

For with padlocking device

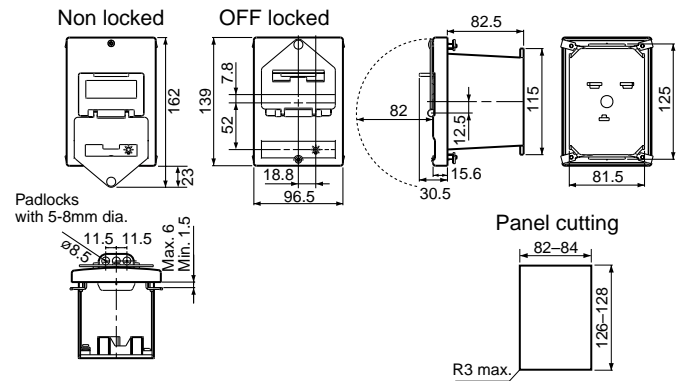

For with emergency pushbutton

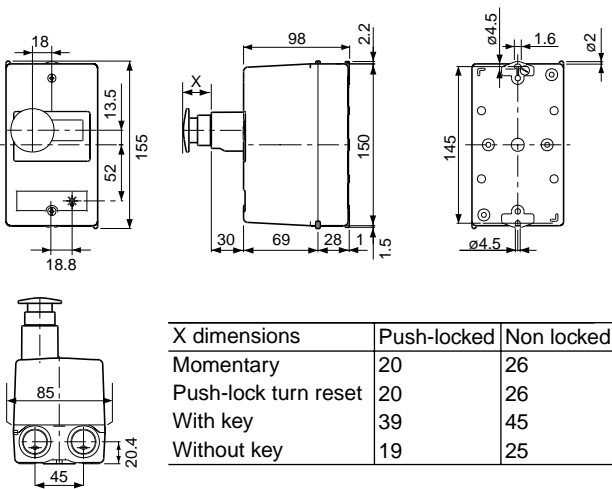

X dimensions	Push-locked	Non locked
Momentary	20	26
Push-lock turn reset	20	26
With key	39	45
Without key	19	25

For with emergency pushbutton

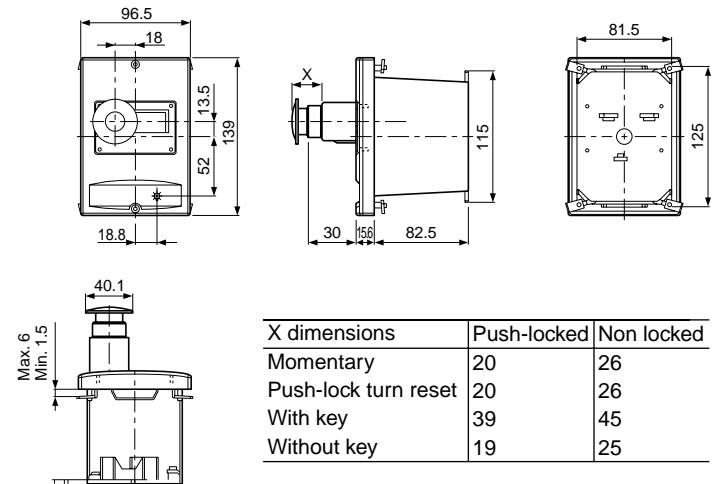

X dimensions	Push-locked	Non locked
Momentary	20	26
Push-lock turn reset	20	26
With key	39	45
Without key	19	25

Panel cutting

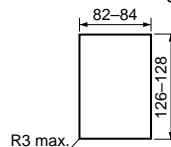

DUO series Contactors

SC-M and SC-E series

General information

In addition to the five basic concepts of the existing SC series of magnetic contactors and motor starters — international standardization, compactness, safety, utility, and ecology — the SC-M and SC-E series take the line-up to the next step in utility with a new finger protection terminal and box lug terminal construction.

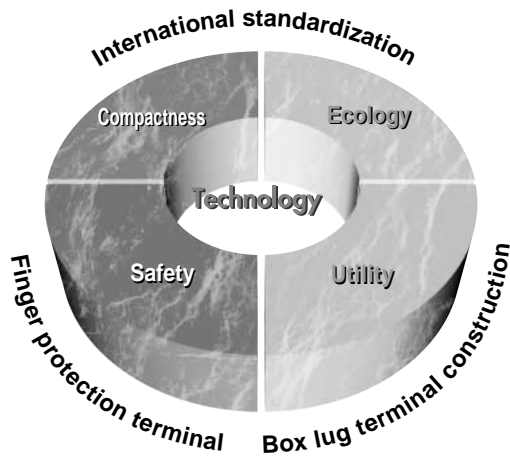

International standardization

IEC 60947-4-1, EN 60947-4-1, VDE 0660
UL 508, CSA C 22.2, JIS C 8201-4-1

Compactness

- SC-M01, M02: 45mm wide
- SC-E02 to E05: 43mm wide, SC-E1 to E2S: 54mm wide
- SC-E3, E4: 67mm wide, SC-E5: 88mm wide
- Reducing mounting area

Safety

- Terminals with finger-touch protection (DIN 57106/ VDE 0106 Teil100)

Utility

- Box lug terminal construction
- Long electrical life
- Reduction of wiring work

Ecology

- Reducing power consumption
- Recycled thermoplastic resin used for plastic parts.
- The names of materials are indicated on all major parts to facilitate their recycling.

SC-M series

2.2 to 4kW, 400V AC

■ Description

Optimal 45mm-wide mini-magnetic contactors for small-capacity induction motor control. A wide range of accessories ensures the flexibility to meet user needs.

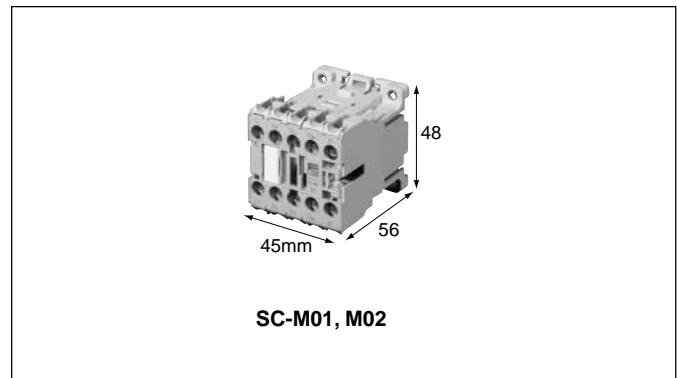

SC-E series







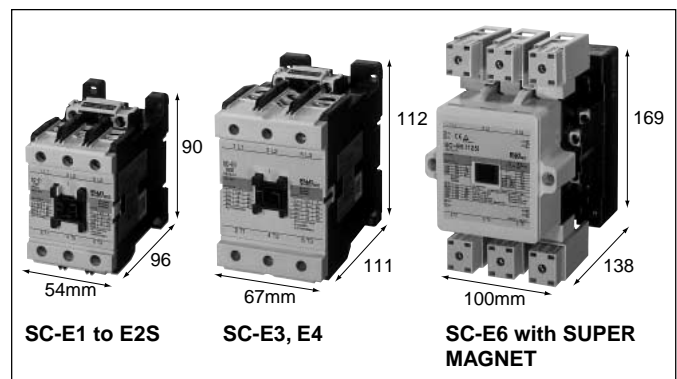



4 to 75kW, 400V AC

■ Description

Models SC-E02 to SC-E4 have a 3-pole main circuit structure. Available in three frame sizes, 43mm, 54mm, and 67mm wide, they enable a significantly reduced mounting area. Models SC-E5 to SC-E7 use an IC-controlled SUPER MAGNET to ensure high operating reliability.



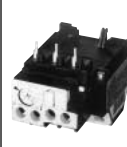
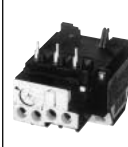
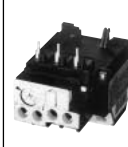
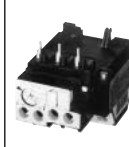













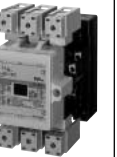

■ Quick reference guide

Contactor	Non-reversing Reversing	SC-M01 SC-M01RM	SC-M02 SC-M02RM	SC-E02 SC-E02RM	SC-E03 SC-E03RM	SC-E04 SC-E04RM	SC-E05 SC-E05RM	SC-E1 SC-E1RM
								
		KK02-292	KK02-292	AF01-12	AF01-11	AF01-10	KK01-105	AF01-8
Motor capacity 3-phase AC-3 (kW)		1.5 2.2	3 4	2.2 4	3 5.5	4 7.5	5.5 11	7.5 15
Rated operational current AC-3 (A)		6 6	9 9	9 9	12 12	18 18	25 25	32 32
Rated thermal current AC-1 (A)		20	20	20	20	25	32	50
Auxiliary contact	Non-reversing	1NO, 1NC	1NO, 1NC	–	–	–	–	–
Dimensions (mm) W×H×D	AC operated Non-reversing	45×48×56		43×81×81				54×90×96
	DC operated	45×48×68		43×81×108				54×90×121.5
Standard		IEC 60947-4-1, EN 60947-4-1, VDE 0660, UL 508, CSA C22.2						
Further information		Page 02/35		Page 02/43				
Thermal overload relay (standard type)				TK-E02	TK-E02	TK-E02	TK-E02	TK-E2
								
				KK01-86	KK01-86	KK01-86	KK01-86	KK01-88
Ampere setting range (A)		–	–	0.1–0.15 0.13–0.2 0.15–0.24 0.2–0.3 0.24–0.36 0.3–0.45 0.36–0.54 0.48–0.72 0.64–0.96 0.8–1.2 0.95–1.45 1.4–2.2 1.7–2.6 2.2–3.4 2.8–4.2 4–6 5–8 6–9 7–11	0.1–0.15 0.13–0.2 0.15–0.24 0.2–0.3 0.24–0.36 0.3–0.45 0.36–0.54 0.48–0.72 0.64–0.96 0.8–1.2 0.95–1.45 1.4–2.2 1.7–2.6 2.2–3.4 2.8–4.2 4–6 5–8 6–9 7–11 9–13	0.1–0.15 0.13–0.2 0.15–0.24 0.2–0.3 0.24–0.36 0.3–0.45 0.36–0.54 0.48–0.72 0.64–0.96 0.8–1.2 0.95–1.45 1.4–2.2 1.7–2.6 2.2–3.4 2.8–4.2 4–6 5–8 6–9 7–11 9–13 12–18	0.1–0.15 0.13–0.2 0.15–0.24 0.2–0.3 0.24–0.36 0.3–0.45 0.36–0.54 0.48–0.72 0.64–0.96 0.8–1.2 0.95–1.45 1.4–2.2 1.7–2.6 2.2–3.4 2.8–4.2 4–6 5–8 6–9 7–11 9–13 12–18 16–22 20–25	4–6 5–8 6–9 7–11 9–13 12–18 18–26 24–36
Dimensions W×H×D (mm)				53×60.5×80.5				54×78.5×97
Standard		IEC 60947-1, EN 60947-4-1, VDE 0660, UL 508, CSA C22.2						
Further information		Page 02/65						

DUO series Contactors

SC-M and SC-E series

General information

Contactors	Non-reversing Reversing	SC-E2	SC-E2S	SC-E3	SC-E4	SC-E5	SC-E6	SC-E7
		SC-E2RM	SC-E2SRM	SC-E3RM	SC-E4RM	SC-E5RM	SC-E6RM	SC-E7RM
								
		AF01-7	AF01-6	AF01-5	AF01-4	AF01-3	AF01-2	AF01-1
Motor capacity 3-phase AC-3 (kW)								
200–240V		11	15	18.5	22	30	37	45
380–440V		18.5	22	30	40	55	60	75
Rated operational current AC-3 (A)								
200–240V		40	50	68	80	105	125	150
380–440V		40	50	65	80	105	125	150
Rated thermal current AC-1 (A)		60	65	100	105	150	150	200
Auxiliary contact Non-reversing		–	–	–	–	2NO+2NC	2NO+2NC	2NO+2NC
Dimensions (mm) W×H×D AC operated		54×90×96		67×112×111		88×155×132	100×169×138	115×175×140
Non-reversing DC operated		54×90×121.5		67×112×130				
Standard		IEC 60947-4-1, EN 60947-4-1, VDE 0660, UL 508, CSA C22.2						
Further information		Page 02/43						
Thermal overload relay (standard type)		TK-E2	TK-E2	TK-E3	TK-E3	TK-E5	TK-E6	TK-E6
		KK01-88	KK01-88	KK01-87	KK01-87	KK01-85	KK01-84	KK01-84
								
Ampere setting range (A)		4–6 5–8 6–9 7–11 9–13 12–18 18–26 24–36 32–42	4–6 5–8 6–9 7–11 9–13 12–18 18–26 24–36 32–42 40–50 44–54	7–11 9–13 12–18 18–26 24–36 34–50 45–65 48–68	7–11 9–13 12–18 18–26 24–36 34–50 45–65 48–68 64–80	18–26 24–36 28–40 34–50 45–65 65–95 85–105	45–65 53–80 65–95 85–125	45–65 53–80 65–95 85–125 110–160
Dimensions W×H×D (mm)		54×78.5×97		68×89.5×107.5		76.5×105×106	100×122×123	
Standard		IEC 60947-1, EN 60947-4-1, VDE 0660, UL 508, CSA C22.2						
Further information		Page 02/65						

SC-M series magnetic contactors / Non-reversing

■ Features

- 45mm-wide compact magnetic contactors
- Terminal block with easy wiring that prevents the accidental finger touch to live parts.
- Snap-on mounting to 35mm-wide top hat rail (DIN)
- Electrical durability of one million operations
- Two models with low power consumption (1.2W and 2W at 24V DC) as well as standard DC-operation models
- Many optional accessories: Auxiliary contact block, coil surge suppression unit, and solid-state time-delay unit

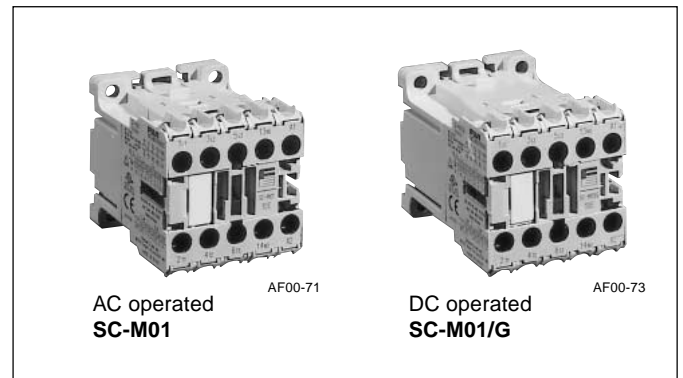

■ Standards

IEC 60947-4-1, EN 60947-4-1, VDE 0660
UL 508, CSA C 22.2, JIS C 8201-4-1, JEM 1038

■ Types and ratings

• Non-reversing

Operating coil	Max. motor capacity (kW)				Rated operational current (A)				Rated thermal current (A)	Auxiliary contact arrangement	Type		
	3-phase motor AC-3				3-phase motor AC-3							Resistive load AC-1	
	200 240V	380 440V	500V 690V	600 690V	200 240V	380 440V	500V 690V	600 690V	200 240V	380 440V			
AC operated	1.5	2.2	3	3	6	6	5	3.5	20	20	20	1NO 1NC	SC-M01
	3	4	4	4	9	9	6.5	5	20	20	20	1NO 1NC	SC-M02
DC operated	1.5	2.2	3	3	6	6	5	3.5	20	20	20	1NO 1NC	SC-M01/G
	3	4	4	4	9	9	6.5	5	20	20	20	1NO 1NC	SC-M02/G
DC operated (Low power consumption 24V DC 1.2W)	1.5	2.2	3	3	6	6	5	3.5	20	20	20	1NO 1NC	SC-M01/G1
	3	4	4	4	9	9	6.5	5	20	20	20	1NO 1NC	SC-M02/G1
DC operated (Low power consumption 24V DC 2W)	1.5	2.2	3	3	6	6	5	3.5	20	20	20	1NO 1NC	SC-M01/G2
	3	4	4	4	9	9	6.5	5	20	20	20	1NO 1NC	SC-M02/G2

Note: Ratings conform to IEC 60947-4-1

■ Accessories

A full range of accessories with the emphasis on utility.

Contactors: SC-M series

Thermal overload relays: TK-M series

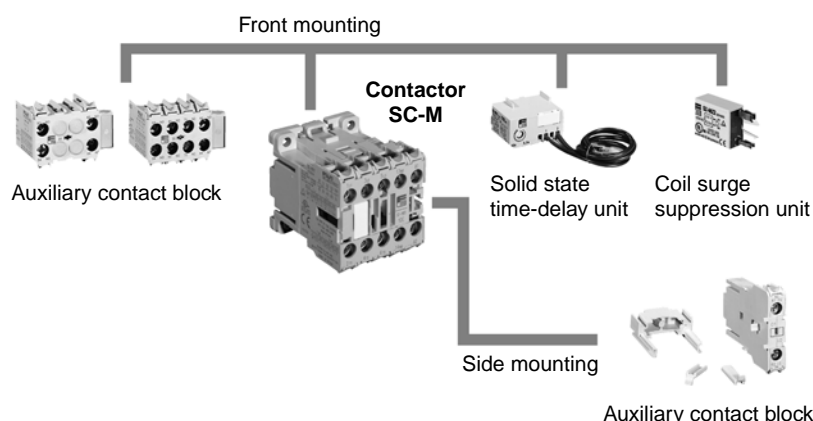

■ Type number nomenclature

SC-M01/G

Operating coil

- Blank: AC operated
- G: 12–220V DC operated, power consumption 3W
- G1: 24V DC operated, power consumption 1.2W
- G2: 24V DC operated, power consumption 2W

Max. motor capacity

- M01: 2.2kW at 380–440V
- M02: 4kW at 380–440V

■ Ordering information

Specify the following:

1. Type number
2. Operating coil order voltage (See page 02/37)
3. Auxiliary contact arrangement

DUO series Contactors

SC-M series

SC-M series magnetic contactors/Reversing

■ Features

- Ideal for the forward-reverse operation of 3-phase motors or plugging stops.
- Mechanical interlock
- 90mm wide (same as two magnetic contactors)
- Snap-on mounting to 35mm-wide top hat rail (DIN).

■ Standards

IEC 60947-4-1, EN 60947-4-1, VDE 0660
UL 508, CSA C 22.2, JIS C 8201-4-1, JEM 1038

■ Types and ratings

• Reversing

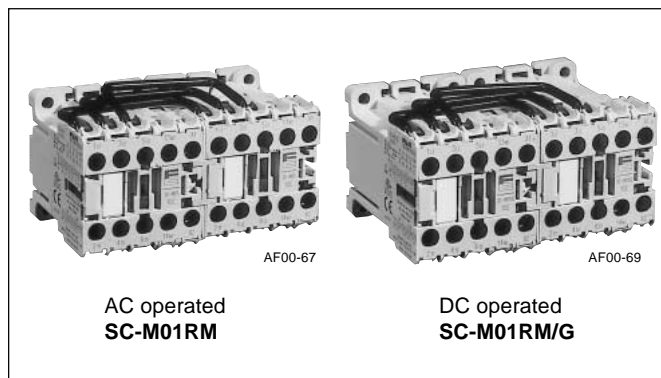

Operating coil	Max. motor capacity (kW)				Rated operational current (A)				Rated thermal current (A)		Auxiliary contact arrangement	Type		
	3-phase motor AC-3				3-phase motor AC-3								Resistive load AC-1	
	200 240V	380 440V	500V 690V	600 690V	200 240V	380 440V	500V 690V	600 690V					200 240V	380 440V
AC operated	1.5	2.2	3	3	6	6	5	3.5	20	20	20	1NO × 2 ^{*1} 1NC × 2 ^{*2}	SC-M01RM	
	3	4	4	4	9	9	6.5	5	20	20	20	1NO × 2 ^{*1} 1NC × 2 ^{*2}	SC-M02RM	
DC operated	1.5	2.2	3	3	6	6	5	3.5	20	20	20	1NO × 2 ^{*1} 1NC × 2 ^{*2}	SC-M01RM/G	
	3	4	4	4	9	9	6.5	5	20	20	20	1NO × 2 ^{*1} 1NC × 2 ^{*2}	SC-M02RM/G	
DC operated (Low power consumption 24V DC 1.2W)	1.5	2.2	3	3	6	6	5	3.5	20	20	20	1NO × 2 ^{*1} 1NC × 2 ^{*2}	SC-M01RM/G1	
	3	4	4	4	9	9	6.5	5	20	20	20	1NO × 2 ^{*1} 1NC × 2 ^{*2}	SC-M02RM/G1	
DC operated (Low power consumption 24V DC 2W)	1.5	2.2	3	3	6	6	5	3.5	20	20	20	1NO × 2 ^{*1} 1NC × 2 ^{*2}	SC-M01RM/G2	
	3	4	4	4	9	9	6.5	5	20	20	20	1NO × 2 ^{*1} 1NC × 2 ^{*2}	SC-M02RM/G2	

Notes: Ratings conform to IEC 60947-4-1

^{*1} The reversing magnetic contactors with 1NOx2 auxiliary contacts cannot be arranged to form an electrical interlock circuit by themselves. When using the contactors, be sure to arrange an electrical interlock circuit externally to prevent short-circuit accidents from simultaneous switching.

^{*2} The reversing magnetic contactors with 1NCx2 auxiliary contacts can be arranged to form an electrical interlock circuit with additional wiring. When using the contactors, arrange an electrical interlock circuit internally or externally to prevent short-circuit accidents from simultaneous switching.

■ Type number nomenclature

SC-M01RM/G

Operating coil

Blank: AC operated
G: 12–220V DC operated,
power consumption 3W
G1: 24V DC operated,
power consumption 1.2W
G2: 24V DC operated,
power consumption 2W

Max. motor capacity

M01RM: 2.2kW at 380–440V
M02RM: 4kW at 380–440V

■ Ordering information

Specify the following:

1. Type number
2. Operating coil order voltage (See page 02/37)
3. Auxiliary contact arrangement

■ Performance data

Frame size	Making capacity (A)	Breaking capacity (A)	Operating cycles per hour	Voltage	Durability (operations)	
					Electrical	Mechanical
M01	72	60	1200	200/240V AC 380/440V AC	1 million	5 million
M02	108	90	1200	200/240V AC 380/440V AC	1 million	5 million

■ Auxiliary contact ratings

Conforming to IEC 60947 5-1, BSEN 60947 5-1 VDE 0660

Rated thermal current	Making and breaking current	Rated operational current				Minimum voltage and current
		AC		DC		
		Voltage	AC-15(Ind. load)	Voltage	DC-13(Ind. load)	
16A	120V AC 60A 220V AC 60A 440V AC 30A 600V AC 15A	120V	6A	24V	5A	17V DC 5mA
		220V	6A	48V	3.5A	
		440V	3A	110V	1.2A	
		600V	1.5A	220V	0.6A	

■ Operating coil

• AC coil

Order voltage	Coil operating voltage and frequency
AC24V	24V AC 50Hz / 24–26V AC 60Hz
AC48V	48V AC 50Hz / 48–52V AC 60Hz
AC100V	100V AC 50Hz / 100–110V AC 60Hz
AC110V	100–110V AC 50Hz / 110–120V AC 60Hz
AC120V	110–120V AC 50Hz / 120–130V AC 60Hz
AC200V	200V AC 50Hz / 200–220V AC 60Hz
AC220V	200–220V AC 50Hz / 220–240V AC 60Hz
AC240V	220–240V AC 50Hz / 240–260V AC 60Hz
AC380V	346–380V AC 50Hz / 380–420V AC 60Hz
AC400V	380–400V AC 50Hz / 400–440V AC 60Hz
AC440V	415–440V AC 50Hz / 440–480V AC 60Hz
AC500V	480–500V AC 50Hz / 500–550V AC 60Hz

• DC coil

Order voltage	Coil operating voltage
DC12V	12V DC
DC24V	24V DC
DC48V	48V DC
DC60V	60V DC
DC100V	100V DC
DC110V	110V DC
DC120V	120V DC
DC200V	200V DC
DC210V	210V DC
DC220V	220V DC

Note: For G1, G2 types, 24V DC only

■ Coil characteristics

• AC operated

Type	Power consumption (VA) *1		Watt loss (W)	Operating voltage range (V)		Operating time (ms)	
	Inrush	Sealed		Pick-up voltage	Drop-out voltage	Coil ON	Coil OFF
SC-M01	32/36	6/6	1.5/1.6	0.8–1.1Us *2	0.35–0.55Us *1	7–12	6–13
SC-M02						Contact ON	Contact OFF

Notes: *1 Coil ratings: 200V 50Hz, 220V 60Hz

*2 Us: Coil rated voltage

• DC operated

Type	Power consumption (W)		Time constant (ms)	Operating voltage range (V)		Operating time (ms)	
	Inrush	Sealed		Pick-up voltage	Drop-out voltage	Coil ON	Coil OFF
SC-M01/G	3	3	35	0.8–1.1Us *	0.2–0.4Us *	24–27	5–8
SC-M02/G						Contact ON	Contact OFF
SC-M01/G1	1.2	1.2	55	0.8–1.25Us *	0.2–0.3Us *	25–45	5–9
SC-M02/G1							
SC-M01/G2	2	2	45	0.7–1.25Us *	0.2–0.35Us *	25–45	5–8
SC-M02/G2							

Note: * Us: Coil rated voltage

DUO series Contactors

SC-M series

■ UL and CSA approved

• Contactor ratings Conforming to UL 508, CSA 22.2

Operating coil	Max. motor capacity (Hp)				Rated operational current (A)				Rated thermal current (A)	Auxiliary contact arrangement	Type
	3-phase motor				3-phase motor						
	200V	220 240V	400 480V	550 600V	200V	220 240V	400 480V	550 600V			
AC operated	1.5	1.5	3	3	6.9	6	4.8	3.9	20	1NO 1NC	SC-M01
	3	3	5	5	11	9.6	7.6	6.1	20	1NO 1NC	SC-M02
DC operated	1.5	1.5	3	3	6.9	6	4.8	3.9	20	1NO 1NC	SC-M01/G
	3	3	5	5	11	9.6	7.6	6.1	20	1NO 1NC	SC-M02/G
DC operated (Low power consumption 24V DC 1.2W)	1.5	1.5	3	3	6.9	6	4.8	3.9	20	1NO 1NC	SC-M01/G1
	3	3	5	5	11	9.6	7.6	6.1	20	1NO 1NC	SC-M02/G1
DC operated (Low power consumption 24V DC 2W)	1.5	1.5	3	3	6.9	6	4.8	3.9	20	1NO 1NC	SC-M01/G2
	3	3	5	5	11	9.6	7.6	6.1	20	1NO 1NC	SC-M02/G2

• Auxiliary contact ratings

Rated thermal current (A)	Making and breaking current (A)					
	AC (Rating code: A600)			DC (Rating code: Q600)		
	Volts	Make	Break	Volts	Make	Break
16	120	60	6	125	0.55	0.55
	240	30	3	250	0.27	0.27
	480	15	1.5	301-600	0.1	0.1
	600	12	1.2			

■ Electrical durability

• AC-1 duty / 380 to 440V AC

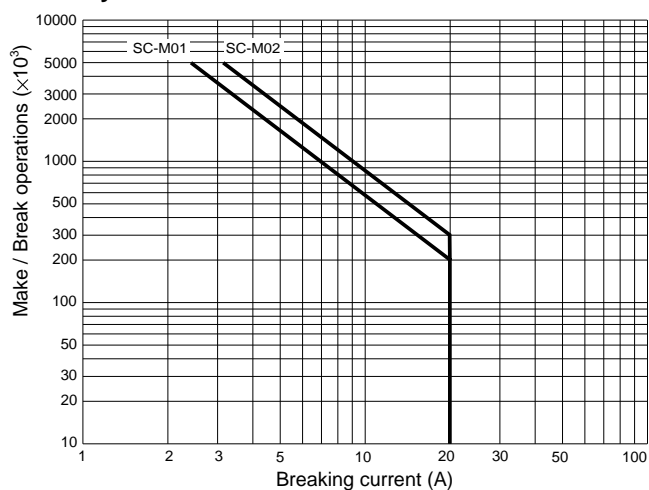

• AC-3 duty / 380 to 440V AC

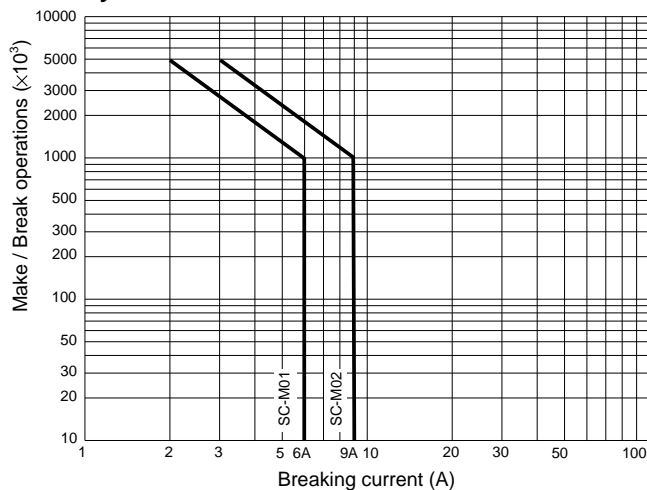

■ **Optional accessories**

• **Auxiliary contact blocks**

The front mounting auxiliary contact block allows two or four auxiliary contacts to be added without increasing the mounting area of the magnetic contactors. The side mounting auxiliary

contact block allows two auxiliary contacts to be added to the magnetic contactors without increasing the depth.

Mounting	No. of contacts	Contact arrangement	Type
Front mounting	4	4NO	SZ-MA40
		3NO+1NC	SZ-MA31
		2NO+2NC	SZ-MA22
		1NO+3NC	SZ-MA13
	2	4NC	SZ-MA04
		2NO	SZ-MA20
Side mounting	1	1NO+1NC	SZ-MA11
		2NC	SZ-MA02
		1NO	SZ-MAS10
		1NC	SZ-MAS01

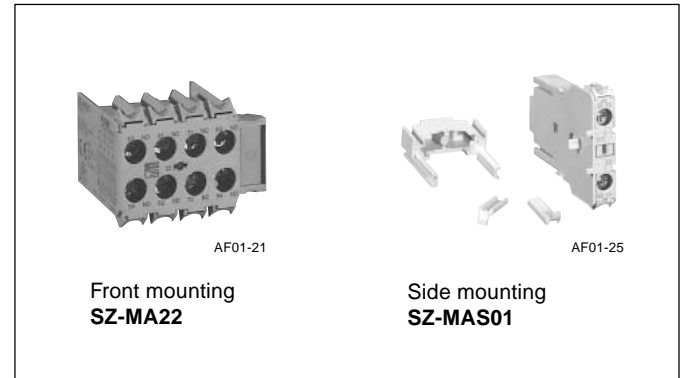

The auxiliary contact blocks can be used in combination with the magnetic contactors listed in the following table. The front mounting and side mounting auxiliary contact blocks cannot be used together.

Auxiliary contact block				Used with							
Mounting	No. of additional contacts	Contact arrangement	Type	SC-M01, SC-M02		SC-M01/G, SC-M02/G		SC-M01/G1, SC-M02/G1		SC-M01/G2, SC-M02/G2	
				1NO	1NC	1NO	1NC	1NO	1NC	1NO	1NC
Front mounting	4	4NO	SZ-MA40	5NO	4NO+1NC	5NO	4NO+1NC	-	-	-	-
		3NO+1NC	SZ-MA31	4NO+1NC	3NO+2NC	4NO+1NC	3NO+2NC	-	-	-	-
		2NO+2NC	SZ-MA22	3NO+2NC	2NO+3NC	3NO+2NC	2NO+3NC	-	-	-	-
		1NO+3NC	SZ-MA13	2NO+3NC	1NO+4NC	2NO+3NC	1NO+4NC	-	-	-	-
	2	4NC	SZ-MA04	1NO+4NC	5NC	1NO+4NC	5NC	-	-	-	-
		2NO	SZ-MA20	3NO	2NO+1NC	3NO	2NO+1NC	-	-	3NO	2NO+1NC
Side mounting	1	1NO+1NC	SZ-MA11	2NO+1NC	1NO+2NC	2NO+1NC	1NO+2NC	-	-	2NO+1NC	1NO+2NC
		2NC	SZ-MA02	1NO+2NC	3NC	1NO+2NC	3NC	-	-	1NO+2NC	3NC
		1NO	SZ-MAS10	2NO	1NO+1NC	2NO	1NO+1NC	-	-	2NO	1NO+1NC
	2	1NC	SZ-MAS01	1NO+1NC	2NC	1NO+1NC	2NC	-	-	1NO+1NC	2NC
		2×1NO	2×SZ-MAS10	3NO	2NO+1NC	3NO	2NO+1NC	-	-	3NO	2NO+1NC
		1NO+1NC	SZ-MAS10	2NO+1NC	1NO+2NC	2NO+1NC	1NO+2NC	-	-	2NO+1NC	1NO+2NC
	2×1NC	2×SZ-MAS01	1NO+2NC	3NC	1NO+2NC	3NC	-	-	1NO+2NC	3NC	

• **Coil surge suppression unit**

The coil surge suppression unit on to the magnetic contactor.

Device	Operating coil voltage and frequency	Type
CR	12–60V AC 50/60Hz	SZ-MZ1
	72–250V AC 50/60Hz	SZ-MZ2
Diode	6–250V DC	SZ-MZ3

• **Power connection kit for reversing / SZ-MRWC**

This kit includes an electrical interlock circuit to convert a magnetic contactor into a reversing magnetic contactor.

• **Solid-state time-delay unit**

The solid-state time-delay unit used with the magnetic contactor works as an on-delay timer.

Operation	Operating coil voltage and frequency	Timing range	Type
On-delay	24–250V AC/DC 50/60Hz	0.2–24s	SZ-MT2
		0.5–60s	SZ-MT5

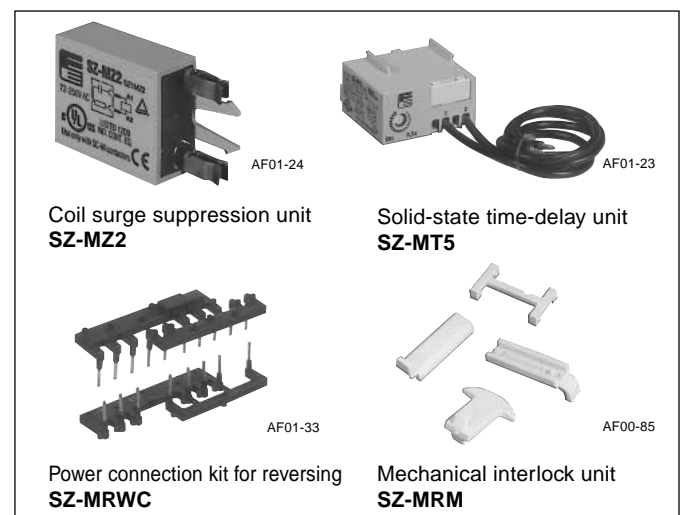

• **Mechanical interlock unit / SZ-MRM**

The mechanical interlock unit provides a mechanical interlock with assembly parts to convert a magnetic contactor into a reversing magnetic contactor.

DUO series Contactors

SC-M series

Dimensions

■ Dimensions, mm

• Non-reversing/AC operated

SC-M01, SC-M02

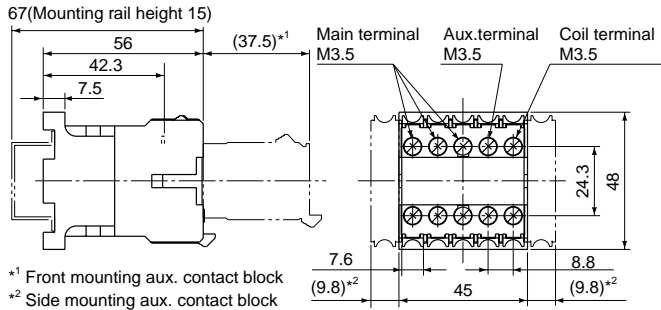

*1 Front mounting aux. contact block
*2 Side mounting aux. contact block

Mass: 0.17kg

• Non-reversing/DC operated

SC-M01/G, M01/G1, M01/G2

SC-M02/G, M02/G1, M02/G2

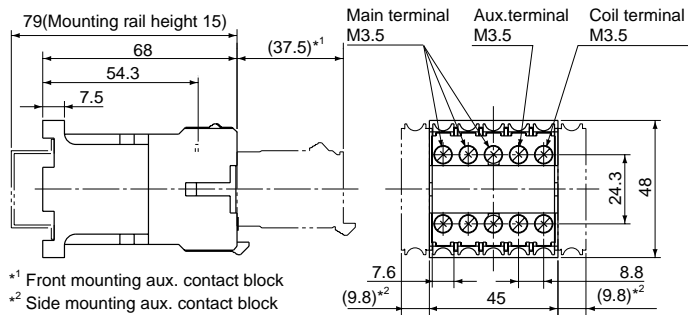

*1 Front mounting aux. contact block
*2 Side mounting aux. contact block

Mass: 0.23kg

• Reversing/AC operated

SC-M01RM, SC-M02RM

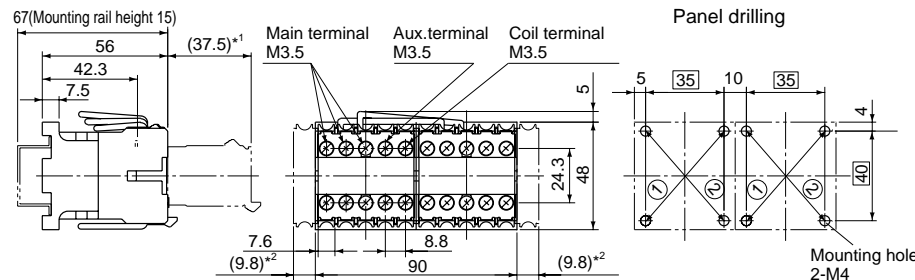

*1 Front mounting aux. contact block
*2 Side mounting aux. contact block

Mass : 0.36kg

• Reversing/DC operated

SC-M01RM/G, M01RM/G1, M01RM/G2

SC-M02RM/G, M02RM/G1, M02RM/G2

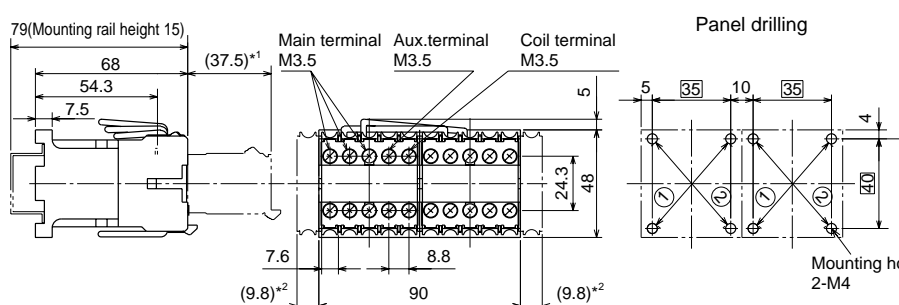

*1 Front mounting aux. contact block
*2 Side mounting aux. contact block

Mass : 0.48kg

■ Wiring diagrams

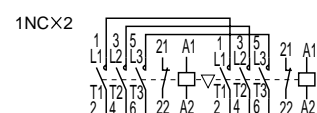
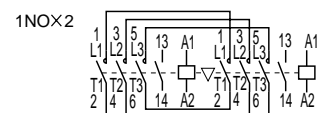
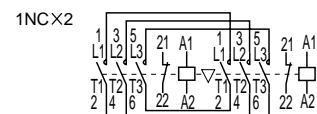
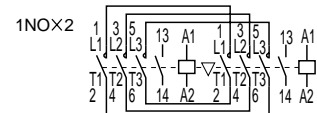
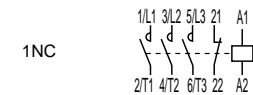
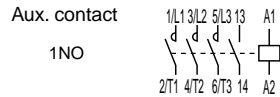
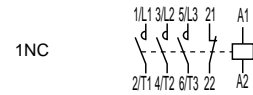
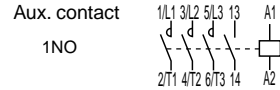

Use the two mounting holes on a diagonal line ① or ② to mount a contactor.

Use the two mounting holes on a diagonal line ① or ② to mount a contactor.

Use the two mounting holes on a diagonal line ① or ② to mount a contactor.

Use the two mounting holes on a diagonal line ① or ② to mount a contactor.

■ Dimensions, mm

• Auxiliary contact blocks/Front mounting
SZ-MA40, MA31, MA22, MA13, MA04

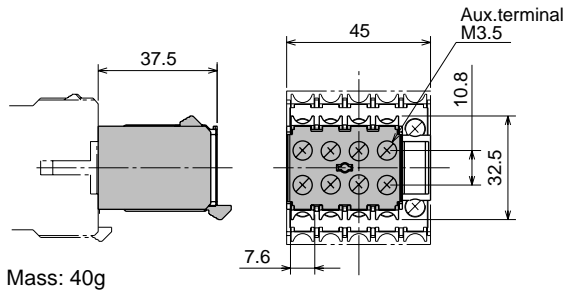

SZ-MA20, MA11, MA02

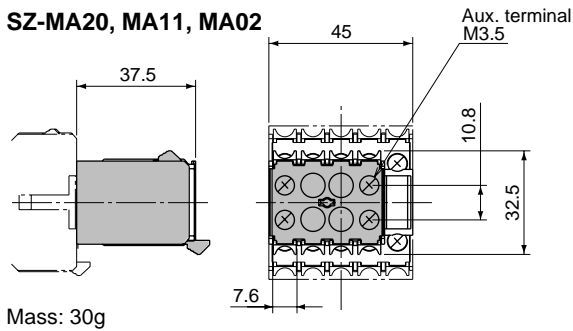

• Aux. contact blocks / Side mounting
SZ-MAS10, MAS01

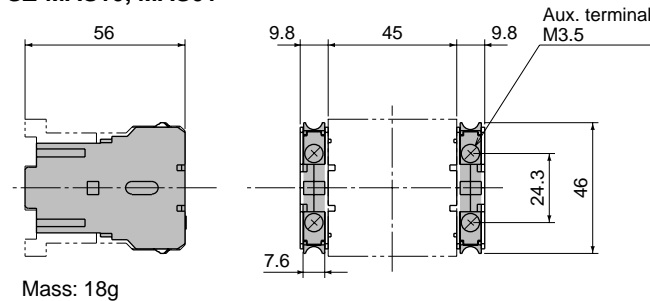

• Coil surge suppression unit
SZ-MZ1, MZ2, MZ3

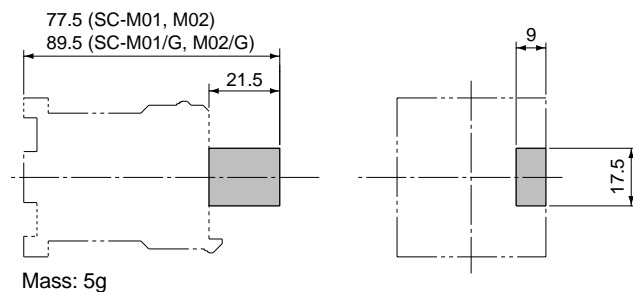

■ Wiring diagrams

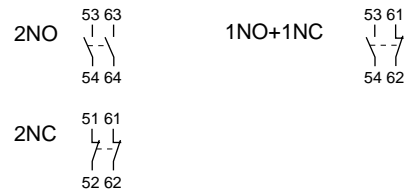
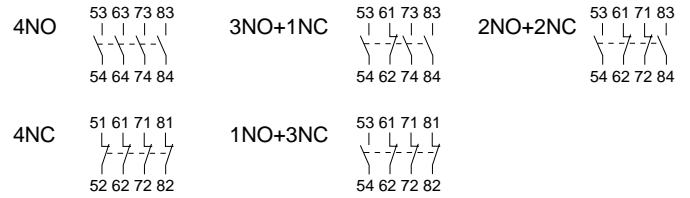

Aux. contact
 • Mounted on the right side

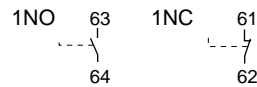

• Mounted on the left side

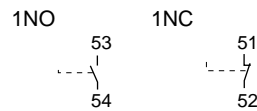

Internal circuit

• Built-in CR

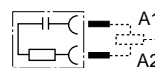

• Built-in diode

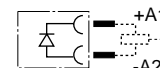

DUO series Contactors

SC-M series

Dimensions

■ Dimensions, mm

• Mechanical interlock unit SZ-MRM

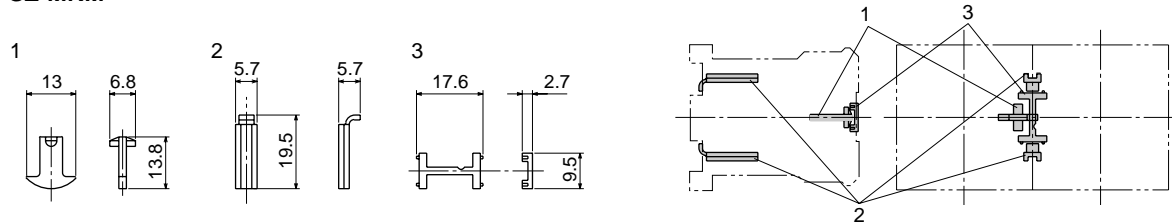

Mass: 1g (3-set)

• Power connection kit for reversing SZ-MRM

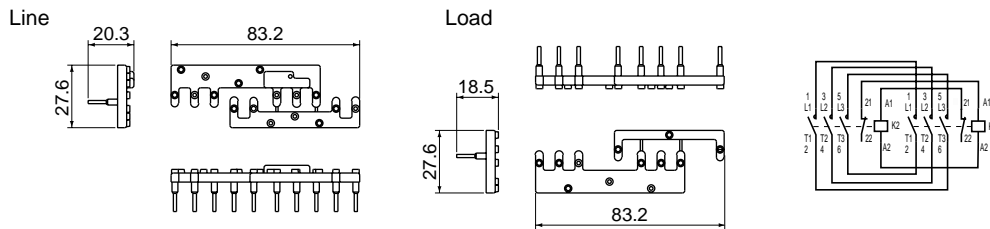

Mass: 27g

• Solid-state time-delay unit SZ-MT2, MT5

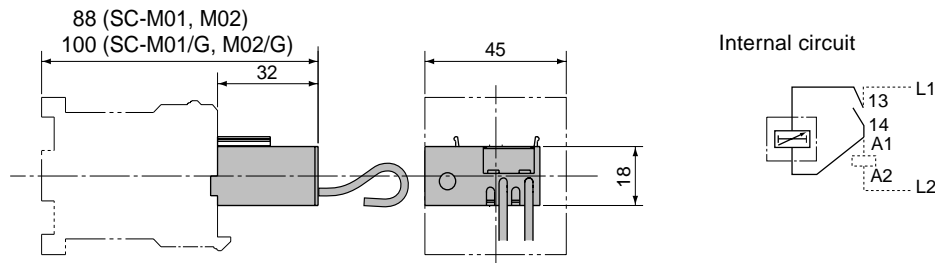

Mass: 38g

■ Standard operating conditions

Ambient temperature	Operating: -5 to 55°C No sudden temperature changes resulting in condensation or icing (The average temperature over a 24-hour period must not exceed 35°C) Storage: -40 to 65°C
Humidity	45 to 85%RH
Altitude	2000m or lower
Atmosphere	No excessive dust, smoke, corrosive gases, flammable gases, steam, or salt.
Vibration	10 to 55Hz 15m/s ²
Shock	50m/s ²
Mounting	Screw mounting, 35mm-wide top hat rail (DIN)
Mounting angle	
Standard	IEC 60947-4-1, EN 60947-4-1, VDE 0660 JIS C 8201-4-1, UL 508, CSA C22.2 TÜV (EN60947-4-1)

■ Wiring

Terminal screw	M3.5
Connectable wire size	1.25 to 2mm ² (ø1.2 to 2mm)
Applicable round crimp terminal	7.5mm (R2-3.5)
Tightening torque	0.8 to 1.0N·m
Tool	Pozi-drive screwdriver

SC-E series magnetic contactors/non-reversing

■ Features

- Models SC-E02 to SC-E4 have 3-pole main circuits and come in three sizes with widths of 43mm (up to 25A), 54mm (up to 50A), and 67mm (up to 80A).
- Models SC-E1 to SC-E7 employ a box type terminal that allows wires to be connected directly to the main circuit.
- Equipped with a finger-protection terminal structure (IP20) that prevents accidental finger touch to live parts.
- Models SC-E5 to SC-E7 use a SUPER MAGNET (AC/DC-input/DC-operate) to achieve high operating reliability.

■ Standards

IEC 60947-4-1, EN 60947-4-1, VDE 0660, JIS C 8201-4-1
UL 508, CSA C22.2

■ Type number nomenclature

SC-E02 P/G

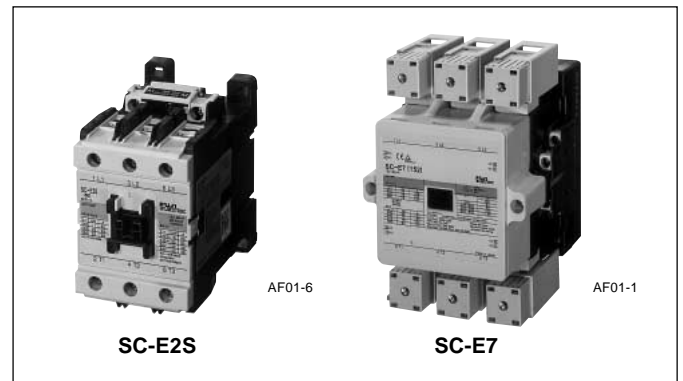
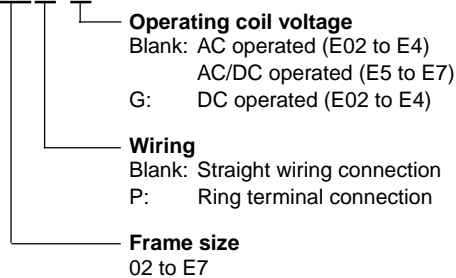

■ Ordering information

Specify the following:

1. Type number
2. Operating coil order voltage (See page 02/51)

■ Accessories

A full range of accessories with the emphasis on utility.

Contactors: SC-E series

Thermal overload relays: TK-E series

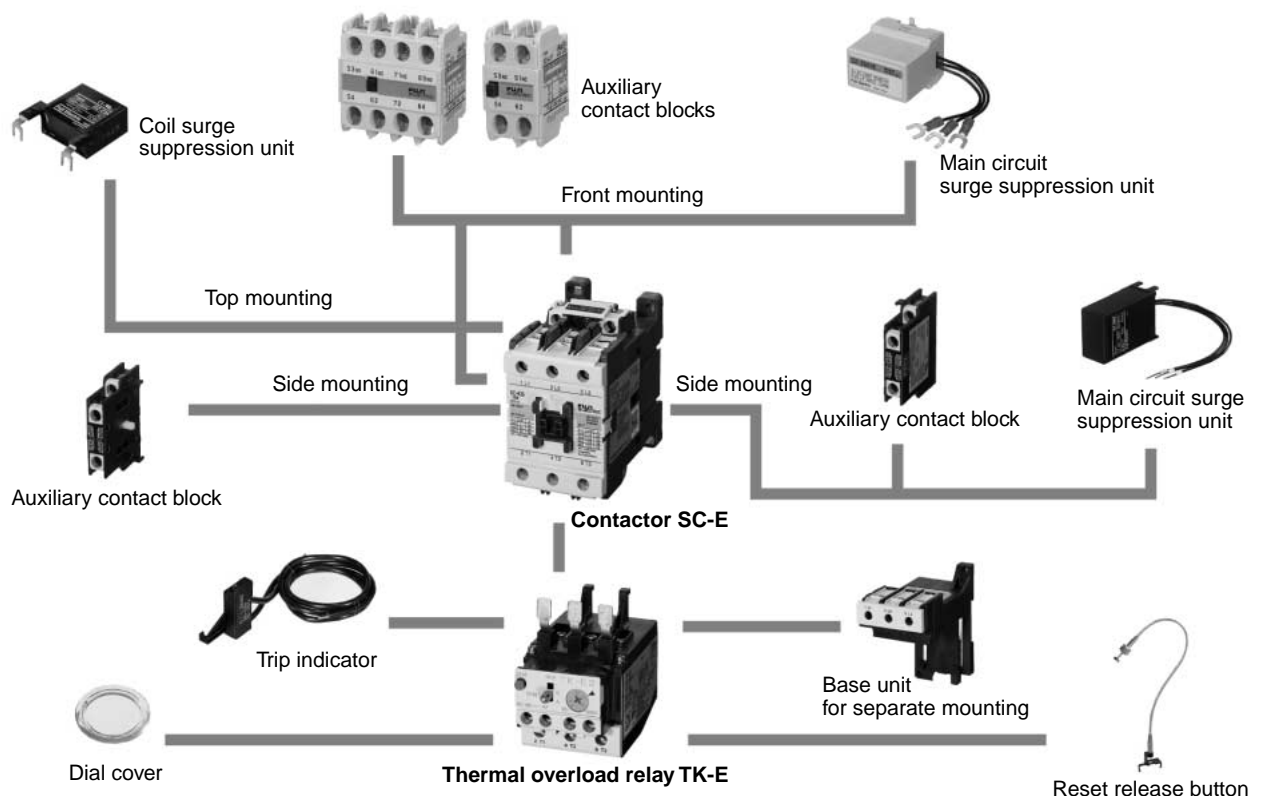

DUO series Contactors

SC-E series

Types and ratings

Operating coil	Max. motor capacity (kW)				Rated operating current (A)						Rated thermal current (A)	Aux. contact arrangement	Contactor type
	3-phase AC-3				3-phase AC-3				Resistive load AC-1				
	200 240V	380 440V	500 550V	600 690V	200 240V	380 440V	500 550V	600 690V	200 240V	380 440V			
AC operated	2.2	4	4	4	9	9	7	5	20	20	20	–	SC-E02
	3	5.5	5.5	5.5	12	12	9	7	20	20	20	–	SC-E03
	4	7.5	7.5	7.5	18	18	13	9	25	25	25	–	SC-E04
	5.5	11	11	7.5	25	25	17	9	32	32	32	–	SC-E05
	7.5	15	15	11	32	32	24	15	50	50	50	–	SC-E1
	11	18.5	18.5	15	40	40	29	19	60	60	60	–	SC-E2
	15	22	25	22	50	50	38	26	65	65	65	–	SC-E2S
	18.5	30	37	30	68	65	60	38	100	100	100	–	SC-E3
AC/DC operated	22	40	37	37	80	80	60	44	105	105	105	–	SC-E4
	30	55	55	55	105	105	85	64	150	150	150	2NO+2NC	SC-E5
	37	60	60	60	125	125	90	72	150	150	150	2NO+2NC	SC-E6
DC operated	45	75	75	90	150	150	120	103	200	200	200	2NO+2NC	SC-E7
	2.2	4	4	4	9	9	7	5	20	20	20	–	SC-E02/G
	3	5.5	5.5	5.5	12	12	9	7	20	20	20	–	SC-E03/G
	4	7.5	7.5	7.5	18	18	13	9	25	25	25	–	SC-E04/G
	5.5	11	11	7.5	25	25	17	9	32	32	32	–	SC-E05/G
	7.5	15	15	11	32	32	24	15	50	50	50	–	SC-E1/G
	11	18.5	18.5	15	40	40	29	19	60	60	60	–	SC-E2/G
	15	22	25	22	50	50	38	26	65	65	65	–	SC-E2S/G
18.5	30	37	30	68	65	60	38	100	100	100	–	SC-E3/G	
22	40	37	37	80	80	60	44	105	105	105	–	SC-E4/G	

Note :Ratings conform to IEC 60947-4-1

Performance data

Frame size	Making current (A)		Breaking current (A)		Operating cycles per hour	Durability (operations)	
	220V	440V	220V	440V		Electrical	Mechanical
SC-E02	108	108	90	90	1800	2 million	10 million
SC-E03	144	144	120	120	1800	1.5 million	10 million
SC-E04	216	216	180	180	1800	1.5 million	10 million
SC-E05	250	250	200	200	1200	1.5 million	10 million
SC-E1	384	384	320	320	1200	1.5 million	10 million
SC-E2	480	480	400	400	1200	1.5 million	10 million
SC-E2S	500	500	400	400	1200	1.5 million	10 million
SC-E3	816	780	680	650	1200	1.5 million	5 million
SC-E4	816	800	680	650	1200	1 million	5 million
SC-E5	1260	1260	1050	1050	1200	1 million	5 million
SC-E6	1500	1500	1250	1250	1200	1 million	5 million
SC-E7	1800	1800	1500	1500	1200	1 million	5 million

SC-E series magnetic contactors/reversing

■ Features

- Ideal for the forward-reverse operation of 3-phase motors or plugging stops.
- Mechanical interlock
- Snap-on mounting to 35mm-wide top hat rail (DIN). (E02 to E4)

■ Type number nomenclature

SC-E2RM/G

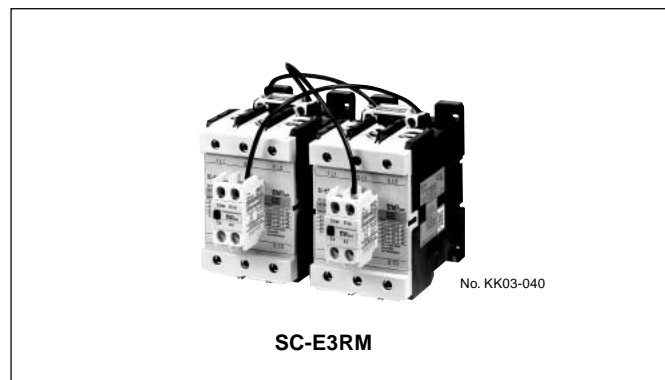
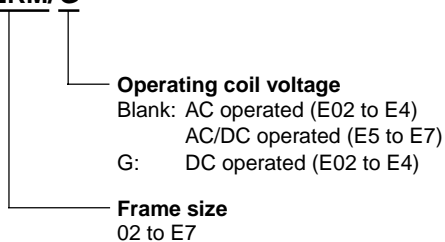

■ Ordering information

Specify the following:

1. Type number
2. Operating coil order voltage (See page 02/51)
3. Auxiliary contact arrangement

■ Types and ratings

Operating coil	Max. motor capacity (kW)				Rated operating current (A)				Rated thermal current (A)	Aux. contact arrangement	Contactor type		
	3-phase AC-3				3-phase AC-3							Resistive load AC-1	
	200	380	500	600	200	380	500	600	200	380			
	240V	440V	550V	690V	240V	440V	550V	690V	240V	440V			
AC operated	2.2	4	4	4	9	9	7	5	20	20	20	(1NO+1NC) × 2, 2NC × 2 (3NO+1NC) × 2, (2NO+2NC) × 2	SC-E02RM*1
	3	5.5	5.5	5.5	12	12	9	7	20	20	20	(1NO+1NC) × 2, 2NC × 2 (3NO+1NC) × 2, (2NO+2NC) × 2	SC-E03RM*1
	4	7.5	7.5	7.5	18	18	13	9	25	25	25	(1NO+1NC) × 2, 2NC × 2 (3NO+1NC) × 2, (2NO+2NC) × 2	SC-E04RM*1
	5.5	11	11	7.5	25	25	17	9	32	32	32	(1NO+1NC) × 2, 2NC × 2 (3NO+1NC) × 2, (2NO+2NC) × 2	SC-E05RM*1
	7.5	15	15	11	32	32	24	15	50	50	50	(1NO+1NC) × 2, 2NC × 2 (3NO+1NC) × 2, (2NO+2NC) × 2	SC-E1RM*1
	11	18.5	18.5	15	40	40	29	19	60	60	60	(1NO+1NC) × 2, 2NC × 2 (3NO+1NC) × 2, (2NO+2NC) × 2	SC-E2RM*1
	15	22	25	22	50	50	38	26	65	65	65	(1NO+1NC) × 2, 2NC × 2 (3NO+1NC) × 2, (2NO+2NC) × 2	SC-E2SRM*1
	18.5	30	37	30	68	65	60	38	100	100	100	(1NO+1NC) × 2, 2NC × 2 (3NO+1NC) × 2, (2NO+2NC) × 2	SC-E3RM*1
	22	40	37	37	80	80	60	44	105	105	105	(1NO+1NC) × 2, 2NC × 2 (3NO+1NC) × 2, (2NO+2NC) × 2	SC-E4RM*1
AC/DC operated	30	55	55	55	105	105	85	64	150	150	150	(2NO+2NC) × 2	SC-E5RM
	37	60	60	60	125	125	90	72	150	150	150	(2NO+2NC) × 2	SC-E6RM
	45	75	75	90	150	150	120	103	200	200	200	(2NO+2NC) × 2	SC-E7RM

Notes: • Ratings conform to IEC 60947-4-1

- *1 The above types are shipped in a set containing two magnetic contactors, one SZ-RM mechanical interlock unit, two front mounting auxiliary contact blocks, and electrical interlock wiring. The power connection kit for the reversing contactor is sold separately.
- To prevent short-circuit faults when using SC-E02R to SC-E04RM types for high-speed switching, provide a time delay relay or other electrical interlock to ensure that the switching time is 15ms min.
- For combined use with an MMS, instead of ordering a reversing type, order and assemble the individual components (two magnetic contactors, one SZ-RM mechanical interlock unit, two auxiliary contact blocks, and the power connection kit (SZ-ERW□/A, SZ-ERW□/B)).

*1 Equipped with the SZ-A11/T, SZ-A02/T, SZ-A31/T, or SZ-A22/T front mounting auxiliary contact block.

• For motor starter use, order the power connection kit and thermal overload relay.

Type	TOR
SC-E02RM to SC-E05RM	TK-E02
SC-E1RM to SC-E2SRM	TK-E2
SC-E3RM to SC-E4RM	TK-E3
SC-E5RM to SC-E7RM	TK-E6H

DUO series Contactors

SC-E series

Types and ratings

Operating coil	Max. motor capacity (kW)				Rated operating current (A)				Rated thermal current (A)	Aux. contact arrangement	Contactor type		
	3-phase AC-3				3-phase AC-3							Resistive load AC-1	
	200 240V	380 440V	500 550V	600 690V	200 240V	380 440V	500 550V	600 690V				200 240V	380 440V
DC operated	2.2	4	4	4	9	9	7	5	20	20	20	(1NO+1NC) × 2, 2NC × 2 (3NO+1NC) × 2, (2NO+2NC) × 2	SC-E02RM/G*1
	3	5.5	5.5	5.5	12	12	9	7	20	20	20	(1NO+1NC) × 2, 2NC × 2 (3NO+1NC) × 2, (2NO+2NC) × 2	SC-E03RM/G*1
	4	7.5	7.5	7.5	18	18	13	9	25	25	25	(1NO+1NC) × 2, 2NC × 2 (3NO+1NC) × 2, (2NO+2NC) × 2	SC-E04RM/G*1
	5.5	11	11	7.5	25	25	17	9	32	32	32	(1NO+1NC) × 2, 2NC × 2 (3NO+1NC) × 2, (2NO+2NC) × 2	SC-E05RM/G*1
	7.5	15	15	11	32	32	24	15	50	50	50	(1NO+1NC) × 2, 2NC × 2 (3NO+1NC) × 2, (2NO+2NC) × 2	SC-E1RM/G*1
	11	18.5	18.5	15	40	40	29	19	60	60	60	(1NO+1NC) × 2, 2NC × 2 (3NO+1NC) × 2, (2NO+2NC) × 2	SC-E2RM/G*1
	15	22	25	22	50	50	38	26	65	65	65	(1NO+1NC) × 2, 2NC × 2 (3NO+1NC) × 2, (2NO+2NC) × 2	SC-E2SRM/G*1
	18.5	30	37	30	68	65	60	38	100	100	100	(1NO+1NC) × 2, 2NC × 2 (3NO+1NC) × 2, (2NO+2NC) × 2	SC-E3RM/G*1
22	40	37	37	80	80	60	44	105	105	105	(1NO+1NC) × 2, 2NC × 2 (3NO+1NC) × 2, (2NO+2NC) × 2	SC-E4RM/G*1	

Notes: • Ratings conform to IEC 60947-4-1

*1 The above types are shipped in a set containing two magnetic contactors, one SZ-RM mechanical interlock unit, two front mounting auxiliary contact blocks, and electrical interlock wiring. The power connection kit for the reversing contactor is sold separately.

• To prevent short-circuit faults when using SC-E02R/G to SC-E04RM/G types for high-speed switching, provide a time delay relay or other electrical interlock to ensure that the switching time is 15ms min.

• For combined use with an MMS, instead of ordering a reversing type, order and assemble the individual components (two magnetic contactors, one SZ-RM mechanical interlock unit, two auxiliary contact blocks, and the power connection kit (SZ-ERW□/A, SZ-ERW□/B)).

*1 Equipped with the SZ-A11/T, SZ-A02/T, SZ-A31/T, or SZ-A22/T front mounting auxiliary contact block.

• For motor starter use, order the power connection kit and thermal overload relay.

Type	TOR
SC-E02RM/G to SC-E05RM/G	TK-E02
SC-E1RM/G to SC-E2SRM/G	TK-E2
SC-E3RM/G to SC-E4RM/G	TK-E3
SC-E5RM/G to SC-E7RM/G	TK-E6H

Performance data

Frame size	Making current (A)		Breaking current (A)		Operating cycles per hour	Durability (operations)	
	220V	440V	220V	440V		Electrical	Mechanical
SC-E02	108	108	90	90	1800	2 million	10 million
SC-E03	144	144	120	120	1800	1.5 million	10 million
SC-E04	216	216	180	180	1800	1.5 million	10 million
SC-E05	250	250	200	200	1200	1.5 million	10 million
SC-E1	384	384	320	320	1200	1.5 million	10 million
SC-E2	480	480	400	400	1200	1.5 million	10 million
SC-E2S	500	500	400	400	1200	1.5 million	10 million
SC-E3	816	780	680	650	1200	1.5 million	5 million
SC-E4	816	800	680	650	1200	1 million	5 million
SC-E5	1260	1260	1050	1050	1200	1 million	5 million
SC-E6	1500	1500	1250	1250	1200	1 million	5 million
SC-E7	1800	1800	1500	1500	1200	1 million	5 million

SC-E series contactors, ring terminal connection types

■ Features

- The new type allows wiring with ring crimp terminals in addition to the conventional straight wiring connection. Types SC-E02P to SC-E2SP also enable straight wiring connection.
- A new slide-type terminal cover is easy to mount and remove. Up to two ring crimp terminals can be connected from the upper terminal part.
- Three module designs with widths of 43mm (up to 25A), 54mm (up to 50A), and 67mm (up to 80A) provide an ideal combination with manual motor starters for ring terminal connection.
- UL, CSA (cUL) approval is pending.



■ Types and rings

• Magnetic contactors

Operating coil	Max. motor capacity (kW)		Rated operational current (A)				Rated thermal current (A)	Aux. contact arrangement	Type
	3-phase AC-3		3-phase AC-3		3-phase AC-1				
	200V	380V	200V	380V	200V	380V			
	240V	440V	240V	440V	240V	440V			
AC operated	2.2	4	9	9	20	20	20	—	SC-E02P
	3	5.5	12	12	20	20	20	—	SC-E03P
	4	7.5	18	18	25	25	25	—	SC-E04P
	5.5	11	25	25	32	32	32	—	SC-E05P
	7.5	15	32	32	50	50	50	—	SC-E1P
	11	18.5	40	40	60	60	60	—	SC-E2P
	15	22	50	50	65	65	65	—	SC-E2SP
	18.5	30	68	65	100	100	100	—	SC-E3P
DC operated	2.2	4	9	9	20	20	20	—	SC-E02P/G
	3	5.5	12	12	20	20	20	—	SC-E03P/G
	4	7.5	18	18	25	25	25	—	SC-E04P/G
	5.5	11	25	25	32	32	32	—	SC-E05P/G
	7.5	15	32	32	50	50	50	—	SC-E1P/G
	11	18.5	40	40	60	60	60	—	SC-E2P/G
	15	22	50	50	65	65	65	—	SC-E2SP/G
	18.5	30	68	65	100	100	100	—	SC-E3P/G
	22	40	80	80	105	105	105	—	SC-E4P/G

• Thermal overload relays

Applicable contactor	Type	Auxiliary contact arrangement	Trip category (JIS) Resistive load AC-1	No. of heater elements
Non-reversing SC-E02P, E02P/G SC-E03P, E03P/G SC-E04P, E04P/G SC-E05P, E05P/G	TK-E02	1NO+1NC	10A	3
SC-E1P, E1P/G SC-E2P, E2P/G SC-E2SP, E2SP/G	TK-N2/T	1NO+1NC	10A	3
SC-E3P, E3P/G SC-E4P, E4P/G	TK-N3/T	1NO+1NC	10A	3

• **Coil characteristics:** See page 02/50

• **dimensions:** See page 02/55

DUO series Contactors

SC-E series

■ Operating coil

• AC coil, SC-E02 to SC-E4

Order voltage	Coil operating voltage and frequency
AC24V	24V AC 50Hz / 24–26V AC 60Hz
AC48V	48V AC 50Hz / 48–52V AC 60Hz
AC100V	100V AC 50Hz / 100–110V AC 60Hz
AC110V	100–110V AC 50Hz / 110–120V AC 60Hz
AC120V	110–120V AC 50Hz / 120–130V AC 60Hz
AC200V	200V AC 50Hz / 200–220V AC 60Hz
AC220V	200–220V AC 50Hz / 220–240V AC 60Hz
AC240V	220–240V AC 50Hz / 240–260V AC 60Hz
AC380V	346–380V AC 50Hz / 380–420V AC 60Hz
AC400V	380–400V AC 50Hz / 400–440V AC 60Hz
AC440V	415–440V AC 50Hz / 440–480V AC 60Hz
AC500V	480–500V AC 50Hz / 500–550V AC 60Hz

Note: Other voltages are available in 24 to 600V AC on request.

• DC coil, SC-E02/G to SC-E4/G

Order voltage	Coil operating voltage
DC12V	12V DC
DC24V	24V DC
DC48V	48V DC
DC60V	60V DC
DC100V	100V DC
DC110V	110V DC
DC120V	120V DC
DC200V	200V DC
DC210V	210V DC
DC220V	220V DC

Note: Other voltages are available in 12 to 250V DC on request.

• AC/DC coil (SUPER MAGNET), SC-E5 to SC-E7

Order voltage	Coil operating voltage and frequency
24V	24–25V AC 50/60Hz, 24V DC
48V	48–50V AC 50/60Hz, 48V DC
100V	100–127V AC 50/60Hz, 100–120V DC *1
200V	200–250V AC 50/60Hz, 200–240V DC *2
400V	380–450V AC 50/60Hz
500V	460–575V AC 50/60Hz

Notes: • Other voltages are available in 24 to 575V AC (24 to 240V DC) on request.

*1 The coil voltage from DC power supply with single-phase full-wave rectification will be 100–110V.

*2 The coil voltage from DC power supply with single-phase full-wave rectification will be 200–220V.

■ Coil characteristics

• AC operated

Frame size	Power consumption (VA)		Power loss (W)		Pick-up voltage (V)		Drop-out voltage (V)		Operating time (ms)	
	Inrush	Sealed	200V	220V	200V	220V	200V	220V	Coil ON →	Coil OFF →
	200V 50Hz	200V 50Hz	50Hz	60Hz	50Hz	60Hz	50Hz	60Hz	Contact ON	Contact OFF
E02 to E05	90	9	2.7	2.8	105–136	116–146	75–106	88–120	9–20	5–16
E1 to E2S	120	12.7	3.6	3.8	110–130	120–140	75–105	85–115	10–17	6–13
E3, E4	180	13.3	4.5	5	115–135	130–150	85–110	100–125	10–18	8–18
E5	80	4	3.2	3.6	140–150	140–150	60–100	60–100	39–45	27–33
E6, E7	190	4.9	3.4	3.7	140–150	140–150	60–100	60–100	31–37	30–36

• DC operated

Frame size	Power consumption (W)		Time constant (ms)	Pick-up voltage (V)	Drop-out voltage (V)	Operating time (ms)	
	Inrush	Sealed				Coil ON →	Coil OFF →
	200V	200V				Contact ON	Contact OFF
E02/G to E05/G	7	7	50	92–130	30–60	45–49	10–26
E1/G to E2S/G	9	9	60	80–120	30–70	40–50	8–17
E3/G, E4/G	12	12	70	80–120	24–60	60–70	14–21
E5	90	2.8	1	140–160	40–100	35–41	26–32
E6, E7	225	3.2	1	140–160	40–100	28–34	27–33

■ Auxiliary contact ratings

Based on IEC 60974-4-1, EN 60947-4-1, JIS C 8201-4-1

Frame size	Rated insulation voltage (V)	Rated thermal current (A)	Making and breaking capacity at AC (A)	Rated operational current (A)				Minimum operating voltage and current
				AC Voltage	AC-15 Ind. load	DC Voltage	DC-13 Ind. load	
E02 to E4 E02/G to E4/G	–	–	–	–	–	–	–	–
E5 to E7	690	10	120V 60 220V 30 440V 15 600V 12	120V 6 220V 3 440V 1.5 600V 1.2	24V 3 48V 1.5 110V 0.55 220V 0.27	3 1.5 0.27	5V DC, 3mA	

■ Types and ratings for UL and CSA

Operating coil	Rated insulation voltage (V)	Max. motor capacity (Hp)				Rated operating current (A)				Rated thermal current (A)	Type
		3-phase motor				3-phase motor					
		200V	220 240V	400 480V	550 600V	200V	220 240V	400 480V	550 600V		
AC operated	600	2	2	5	5	7.8	6.8	7.6	6.1	20	SC-E02
		3	3	7.5	7.5	11	9.6	11	9	20	SC-E03
		5	5	10	10	17.5	15.2	14	11	25	SC-E04
		5	7.5	15	15	17.5	22	21	17	32	SC-E05
		7.5	10	25	25	25.3	28	34	27	50	SC-E1
		10	15	30	30	32.2	42	40	32	60	SC-E2
		15	20	30	30	48.3	54	40	32	65	SC-E2S
		20	25	50	50	62.1	68	65	52	100	SC-E3
AC/DC operated	600	25	30	50	50	78.2	80	65	52	105	SC-E4
		30	30	60	75	92	80	77	77	150	SC-E5
		40	40	75	100	119.6	104	96	99	150	SC-E6
DC operated	600	50	50	100	125	149.5	130	124	125	200	SC-E7
		2	2	5	5	7.8	6.8	7.6	6.1	20	SC-E02/G
		3	3	7.5	7.5	11	9.6	11	9	20	SC-E03/G
		5	5	10	10	17.5	15.2	14	11	25	SC-E04/G
		5	7.5	15	15	17.5	22	21	17	32	SC-E05/G
		7.5	10	25	25	25.3	28	34	27	50	SC-E1/G
		10	15	30	30	32.2	42	40	32	60	SC-E2/G
15	20	30	30	48.3	54	40	32	65	SC-E2S/G		
20	25	50	50	62.1	68	65	52	100	SC-E3/G		
25	30	50	50	78.2	80	65	52	105	SC-E4/G		

■ Auxiliary contact ratings for UL and CSA

Frame size	Rated insulation voltage (V)	Rated thermal current (A)	Making and breaking current (A)						
			AC (rating code A600)			DC (rating code Q300)			
			Voltage	Making	Breaking	Voltage	Making	Breaking	
E02 to E4 E02/G to E4/G	–	–	–	–	–	–	–	–	–
E5 to E7	600	10	120V 240V 480V 600V	60 30 15 12	6 3 1.5 1.2	125V 250V	0.55 0.27	0.55 0.27	

DUO series Contactors

SC-E series

■ Electrical durability

• AC-3 duty / SC-E02 to SC-E05

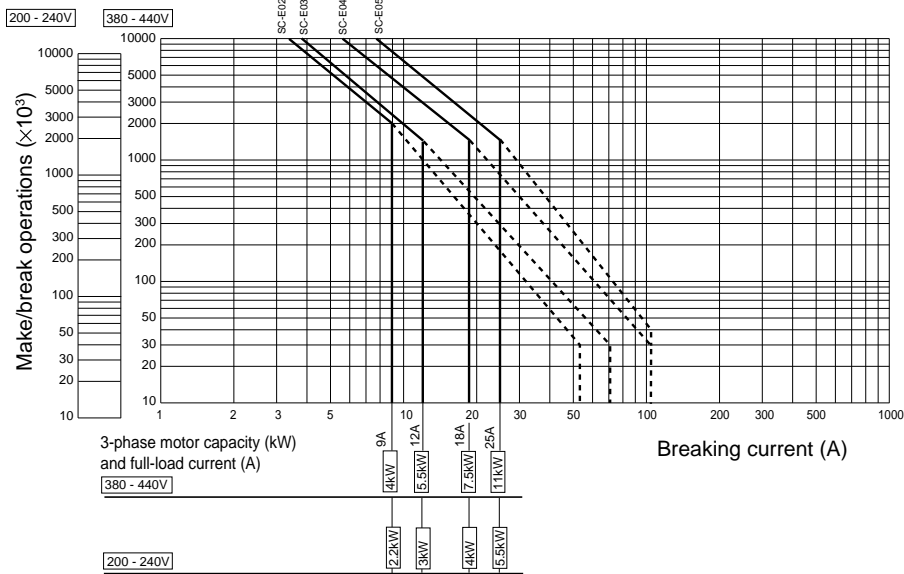

• AC-3 duty / SC-E1 to SC-E7

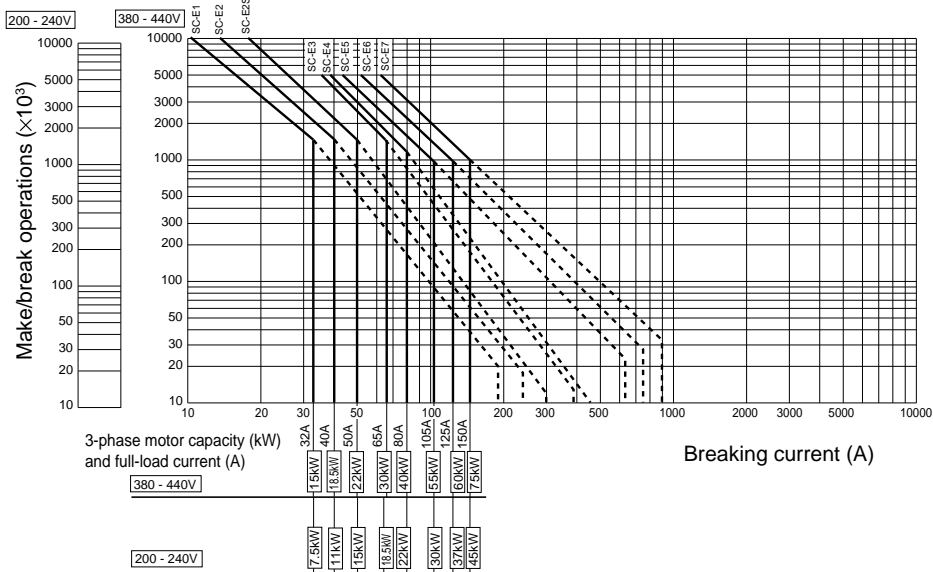

• AC-1 duty / SC-E02 to SC-E7

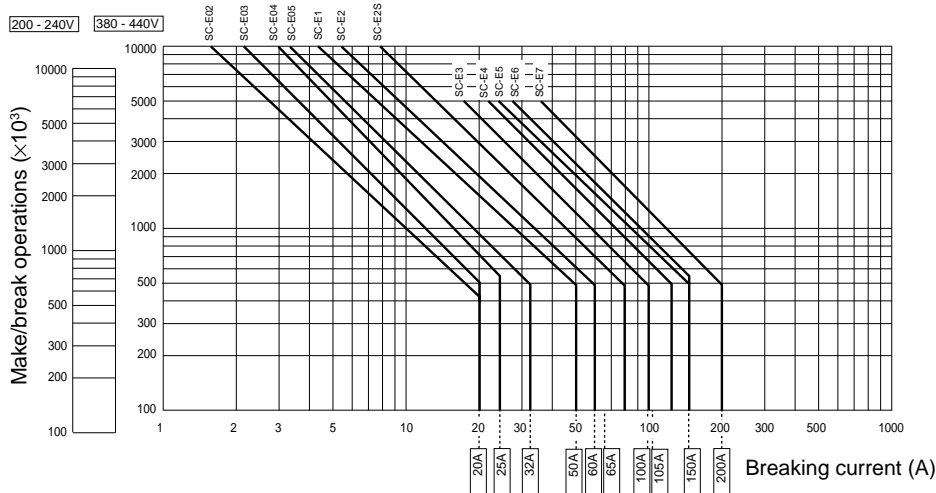

■ **Optional accessories**

• **Auxiliary contact blocks with terminal covers**

The front mounting auxiliary contact block allows two or four auxiliary contacts to be added without increasing the mounting area of the magnetic contactors. The side mounting auxiliary contact block allows two auxiliary contacts to be added to the magnetic contactors without increasing the depth.

Applicable contactor	Mounting	No. of contacts	Contact arrangement	Type
SC-E02 to E4	Front mounting	4	4NO 3NO+1NC 2NO+2NC	SZ-A40/T SZ-A31/T SZ-A22/T
		2	2NO 1NO+1NC 2NC	SZ-A20/T SZ-A11/T SZ-A02/T
SC-E02 to E4 SC-E5, E6, E7	Side mounting	2	1NO+1NC	SZ-AS1/T
		2	1NO+1NC	SZ-AS2/T

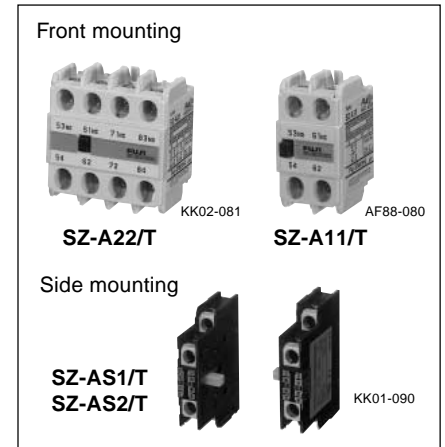

Auxiliary contact blocks

Contact ratings

• Based on IEC and JIS

Rated thermal current (A)	Making and breaking capacity at AC (A)	Rated operational current (A)				Minimum operating voltage and current
		AC		DC		
		Voltage	AC-15 Ind. load	Voltage	DC-13 Ind. load	
10	120V 60	120V	6	24V	3	5V DC 3mA
	220V 30	220V	3	48V	1.5	
	440V 15	440V	1.5	110V	0.55	
	600V 12	600V	1.2	220V	0.27	

• Based on UL and CSA

Rated thermal current (A)	Making and breaking current (A)					
	AC (rating code A600)			DC (rating code Q300)		
	Volts	Making	Breaking	Volts	Making	Breaking
10	120V	60	6	125V	0.55	0.55
	240V	30	3	250V	0.27	0.27
	480V	15	1.5			
	600V	12	1.2			

• **Main circuit surge suppression units**

When contactor is energized or de-energized, a surge voltage is generated from motor circuit. This unit suppresses this surge voltage and protects electronic equipment from malfunction or damage.

Applicable contactor	Mounting	Rated voltage and frequency	CR constant	Applicable 3-phase motor	Type
SC-E02 to E05	Front mounting	250V AC	C=0.22μF	200–240V AC	SZ-ZM1E
	Side mounting	50/60Hz	R=100Ω	0.1–5.5kW	SZ-ZM2E
SC-E1 to E4	Front mounting	250V AC	C=0.33μF	200–240V AC	SZ-ZM3E
	Side mounting	50/60Hz	R=47Ω	0.1–22kW	SZ-ZM4E

• **Coil surge suppression units**

This unit suppresses surge voltage due to contactor ON-OFF operations, and can be easily connected to contactor coil terminals.

Applicable contactor		Operating coil voltage	Device	Operation indicator	Type
AC operated	DC operated				
SC-E02 to E05	SC-E02/G to E05/G	24–48V AC/DC	Varistor	–	SZ-Z1
	–	100–250V AC/DC		–	SZ-Z2
	–	380–440V AC		–	SZ-Z3
SC-E02 to E05	SC-E02/G to E05/G	24–48V AC/DC	CR	Red LED	SZ-Z6
	–	100–250V AC/DC		Red LED	SZ-Z7
	–	380–440V AC		–	SZ-Z33
SC-E1 to E4	SC-E1/G to E4/G	24–48V AC/DC	CR	–	SZ-Z31
	–	100–250V AC/DC		–	SZ-Z32
	–	380–440V AC		–	SZ-Z33
SC-E02 to E05	SC-E02/G to E05/G	24–48V AC/DC	CR	–	SZ-Z4
	–	100–250V AC/DC		–	SZ-Z5
	–	380–440V AC		Red LED	SZ-Z8
SC-E02 to E05	SC-E02/G to E05/G	24–48V AC/DC	CR	Red LED	SZ-Z9
	–	100–250V AC/DC		–	SZ-Z34
	–	380–440V AC		–	SZ-Z35
SC-E1 to E4	–	24–48V AC	CR	–	SZ-Z36
	–	100–250V AC		–	SZ-Z37
–	SC-E1/G to E4/G	24–48V DC	CR	–	SZ-Z36
–	–	100–250V DC	CR	–	SZ-Z37

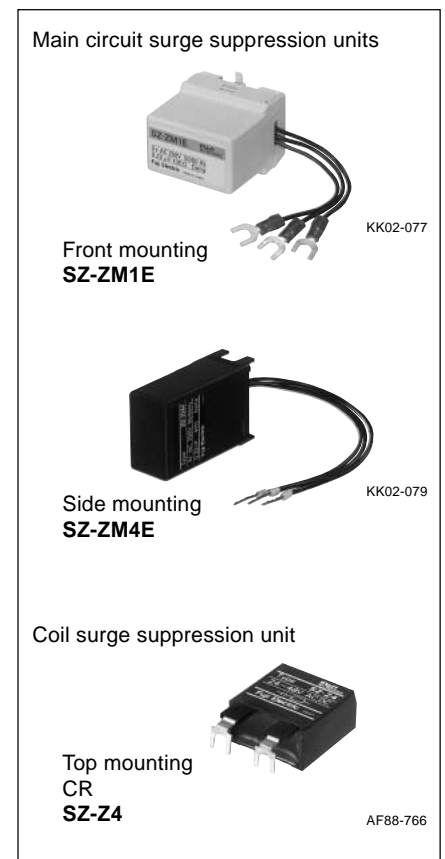

DUO series Contactors

SC-E series

Optional accessories

• Mechanical interlock unit

The mechanical interlock unit provides a mechanical interlock with assembly parts to convert a magnetic contactor into a reversing magnetic contactor.

Applicable contactor	Type
SC-E02 to E4	SZ-RM
SC-E02/G to E4/G	

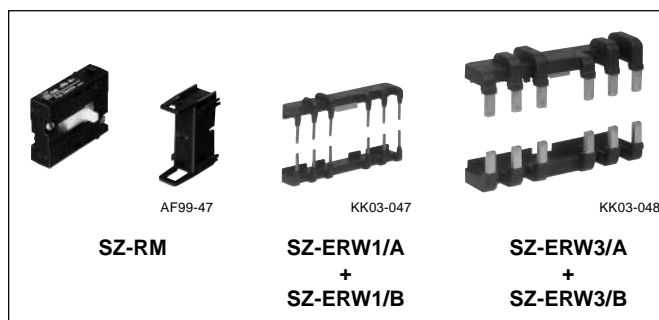

• Power connection kit for reversing (For direct connection)

Applicable contactor	Power connection kit for reversing					
	Contactor separately fig 1		Combination using thermaloverload relay fig 2		Combination using MMS fig 3	
	Line side ③	Load side ④	Line side ⑤	Load side ⑥	Line side ⑦	Load side ⑧
SC-E02RM,SC-E02RM/G	SZ-ERW1/A	SZ-ERW1/B	SZ-ERW1/A	SZ-ERW1/D	SZ-ERW1/A	SZ-ERW1/B
SC-E03RM,SC-E03RM/G						
SC-E04RM,SC-E04RM/G						
SC-E05RM,SC-E05RM/G						
SC-E1RM,SC-E1RM/G	SZ-ERW2/A	SZ-ERW2/B	SZ-ERW2/A	SZ-ERW2/D	SZ-ERW2/A	SZ-ERW2/B
SC-E2RM,SC-E2RM/G						
SC-E2SRM,SC-E2SRM/G						
SC-E3RM,SC-E3RM/G	SZ-ERW3/A	SZ-ERW3/B	SZ-ERW3/A	SZ-ERW3/D	SZ-ERW3/A	SZ-ERW3/B
SC-E4RM,SC-E4RM/G					—	—
SC-E5RM	SZ-ERW4/A	SZ-ERW4/B	—	—	—	—
SC-E6RM	SZ-ERW5/A	SZ-ERW5/B	—	—	—	—
SC-E7RM	SZ-ERW6/A	SZ-ERW6/B	—	—	—	—

• Power connection kit for reversing (For crimp terminal)

Applicable contactor	Power connection kit for reversing					
	Contactor separately fig 1		Combination using thermaloverload relay fig 2		Combination using MMS fig 3	
	Line side ③	Load side ④	Line side ⑤	Load side ⑥	Line side ⑦	Load side ⑧
SC-E02PRM,SC-E02PRM/G	SZ-EPRW1/C	SZ-EPRW1/D	SZ-EPRW1/C	SZ-EPRW1/D	SZ-ERW1/A	SZ-EPRW1/D
SC-E03PRM,SC-E03PRM/G						
SC-E04PRM,SC-E04PRM/G						
SC-E05PRM,SC-E05PRM/G						
SC-E1PRM,SC-E1PRM/G	SZ-EPRW2/C	SZ-EPRW2/D	SZ-EPRW2/C	SZ-EPRW2/D	—	—
SC-E2PRM,SC-E2PRM/G						
SC-E2SPRM,SC-E2SPRM/G						
SC-E3PRM,SC-E3PRM/G	SZ-EPRW3/C	SZ-EPRW3/D	SZ-EPRW3/C	SZ-EPRW3/D	—	—
SC-E4PRM,SC-E4PRM/G						

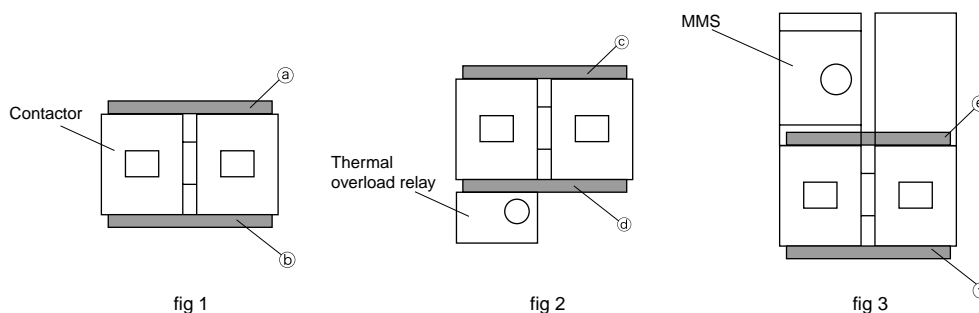

■ Dimensions, mm
 • Non-reversing/AC operated
SC-E02, E03, E04, E05

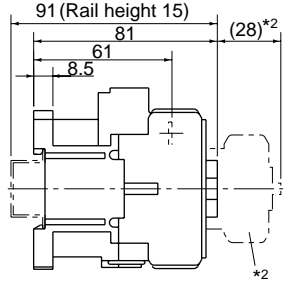

Mass: 0.33kg

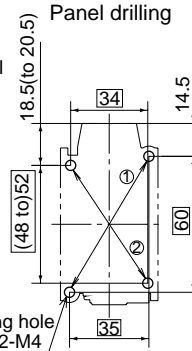
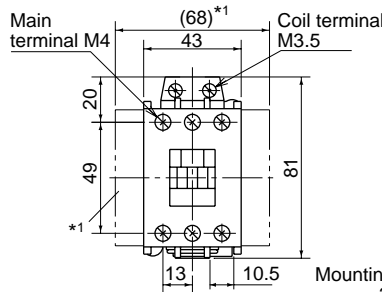

■ Wiring diagrams

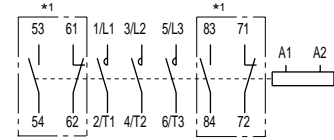

*1 In case of aux. contact 2NO+2NC

Use the two mounting holes on a diagonal line
 ① or ② to mount contactor
 ①: 35 × 60 ②: 34 × (48 to 52)

SC-E1, E2, E2S

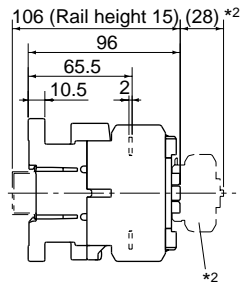

Mass : 0.58kg

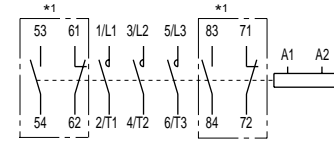
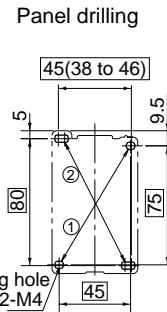
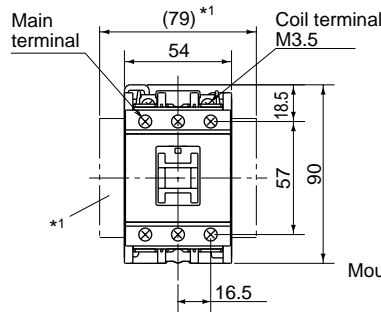

*1 In case of aux. contact 2NO+2NC

Use the two mounting holes on a diagonal line
 ① or ② to mount contactor
 ①: 45 × 75 ②: 45 (38 to 46) × 80

SC-E3, E4

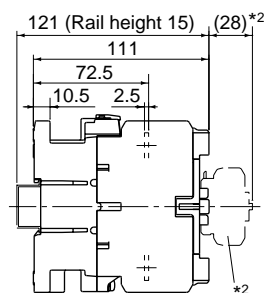

Mass: 1.05kg

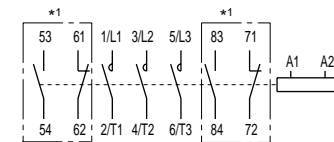
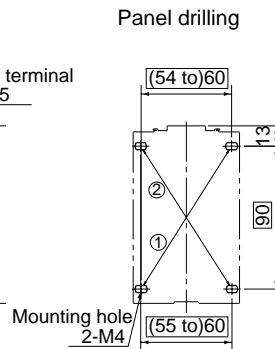
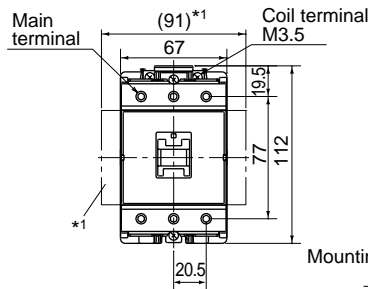

*1 In case of aux. contact 2NO+2NC

Use the two mounting holes on a diagonal line
 ① or ② to mount contactor
 ①: (55 to 60) × 90 ②: (54 to 60) × 90

SC-E5

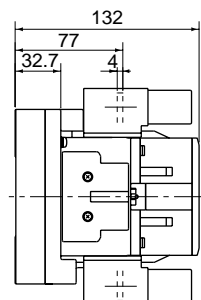

Mass: 2.04kg

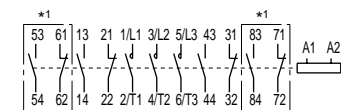
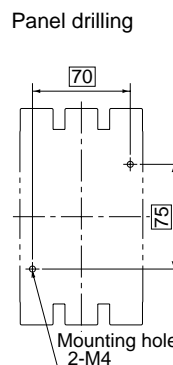
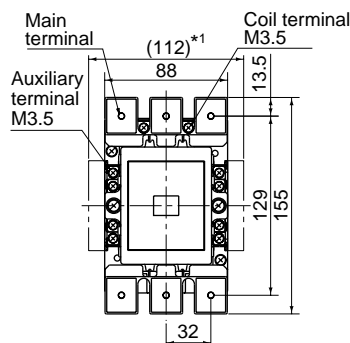

*1 In case of aux. contact 4NO+4NC

*1 Side mounting aux. contact block
 *2 Front mounting aux. contact block

DUO series Contactors

SC-E series

Dimensions

■ Dimensions, mm

• Non-reversing/AC operated

SC-E6

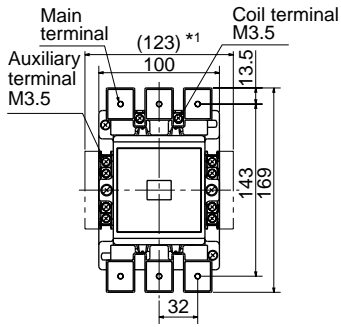
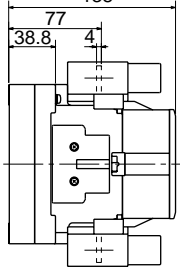

Panel drilling

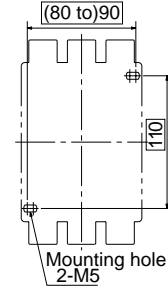

Mass: 2.55kg

■ Wiring diagrams

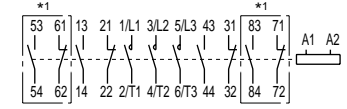

*1 In case of aux. contact 4NO+4NC

SC-E7

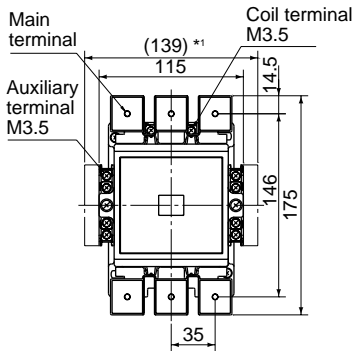
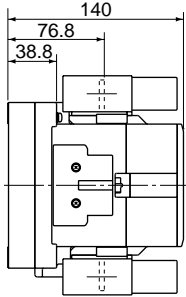

Panel drilling

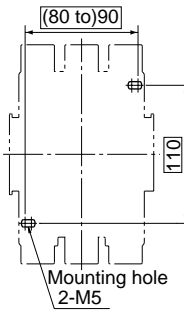

Mass: 2.86kg

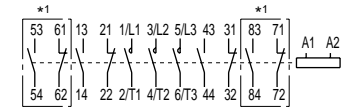

*1 In case of aux. contact 4NO+4NC

• Non-reversing/DC operated

SC-E02/G, E03/G, E04/G, E05/G

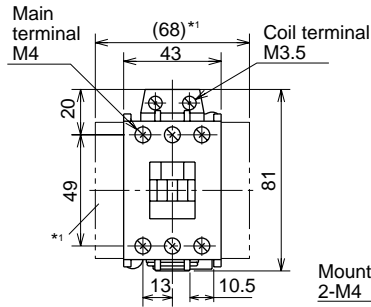
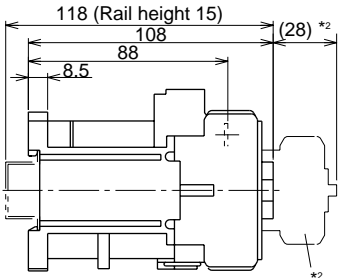

Panel drilling

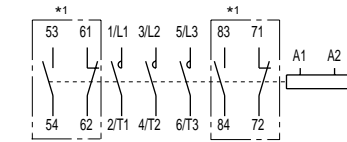
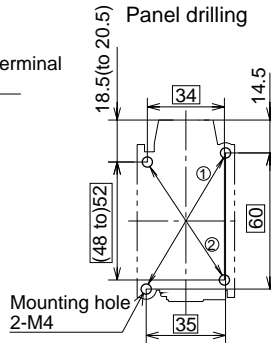

*1 In case of aux. contact 2NO+2NC

Mass: 0.59kg

Use the two mounting holes on a diagonal line
① or ② to mount contactor
①: 35 × 60 ②: 34 × (48 to 52)

SC-E1/G, E2/G, E2S/G

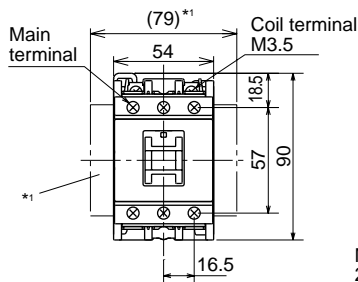
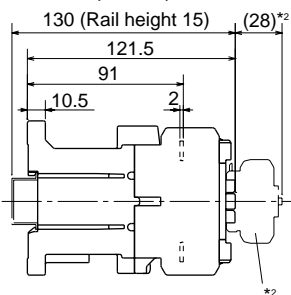

Panel drilling

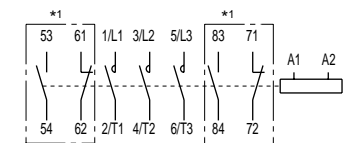
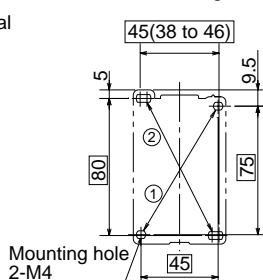

*1 In case of aux. contact 2NO+2NC

Mass: 0.79kg

Use the two mounting holes on a diagonal line
① or ② to mount contactor
①: 45 × 75 ②: 45 (38 to 46) × 80

*1 Side mounting aux. contact block
*2 Front mounting aux. contact block

DUO series Contactors SC-E series Dimensions

■ Dimensions, mm • Non-reversing/DC operated SC-E3/G, E4/G

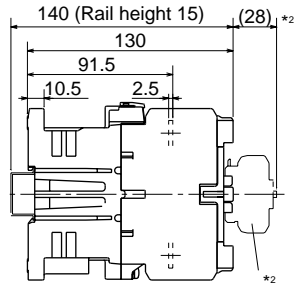

Mass: 1.4kg

*1 Side mounting aux. contact block
*2 Front mounting aux. contact block

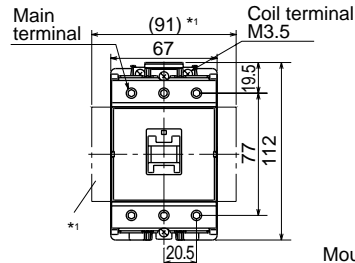

Panel drilling

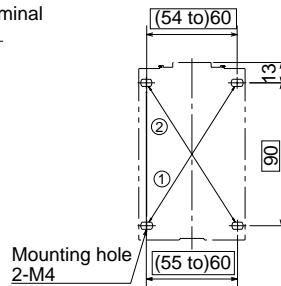

■ Wiring diagrams SC-E02RM to E4RM

(1NO+1NC) × 2

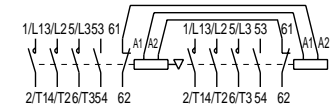

2NC × 2

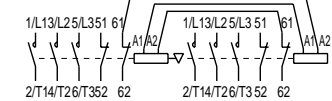

• Reversing/AC operated SC-E02RM, E03RM, E04RM, E05RM

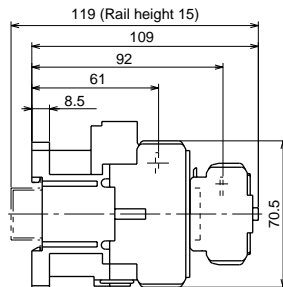

Mass : 0.8kg (AUX.4P)
0.77kg(AUX.2P)

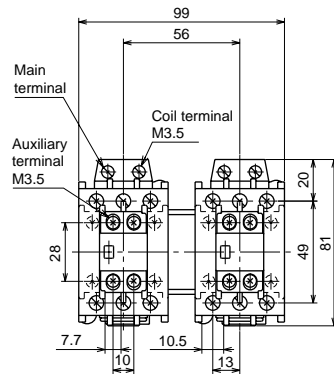

Panel drilling

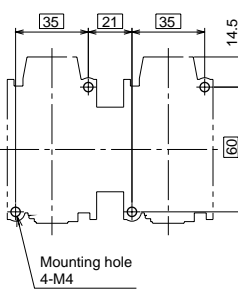

(2NO+2NC) × 2

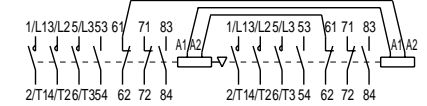

(3NO+NC) × 2

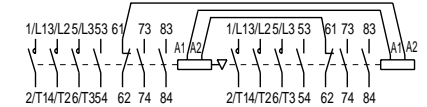

SC-E1RM, E2RM, E2SRM

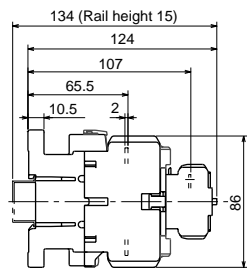

Mass : 1.3kg (AUX.4P)
1.27kg(AUX.2P)

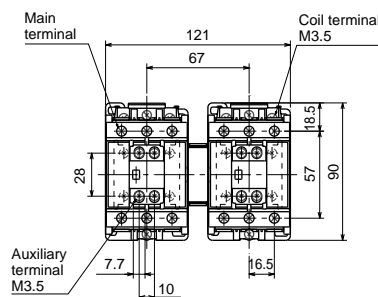

Panel drilling

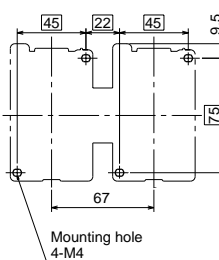

SC-E3RM, E4RM

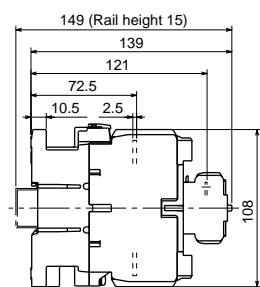

Mass : 2.24kg(AUX.4P)
2.21kg(AUX.2P)

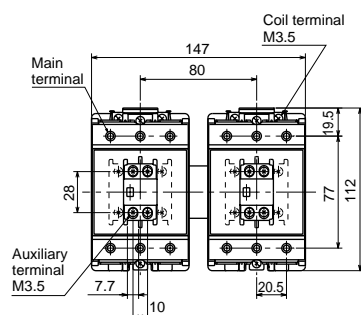

Panel drilling

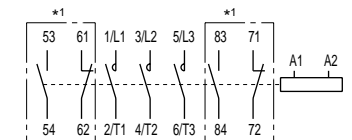
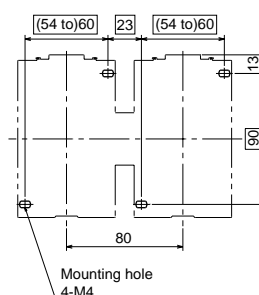

*1 In case of aux. contact 2NO+2NC

Use the two mounting holes on a diagonal line

① or ② to mount contactor

①: (55 to 60) × 90 ②: (54 to 60) × 90

DUO series Contactors

SC-E series

Dimensions

- Dimensions, mm
 - Reversing/AC operated
- #### SC-E5RM

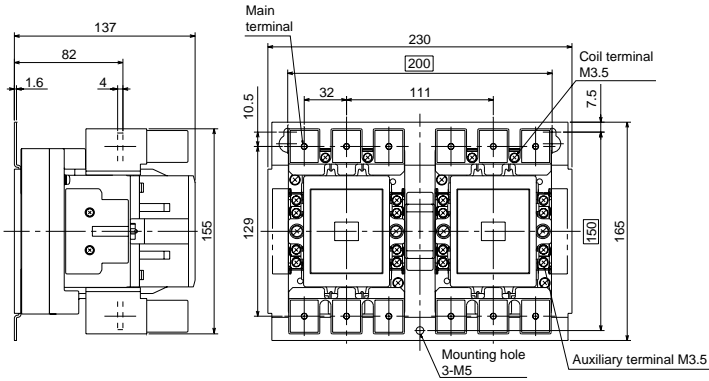

Mass : 4.64kg

SC-E6RM

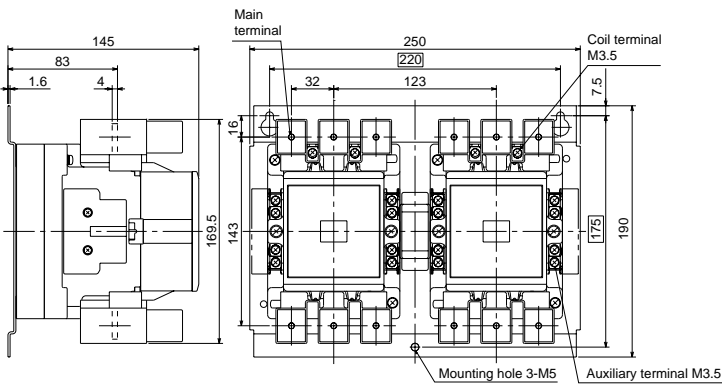

Mass : 5.8kg

SC-E7RM

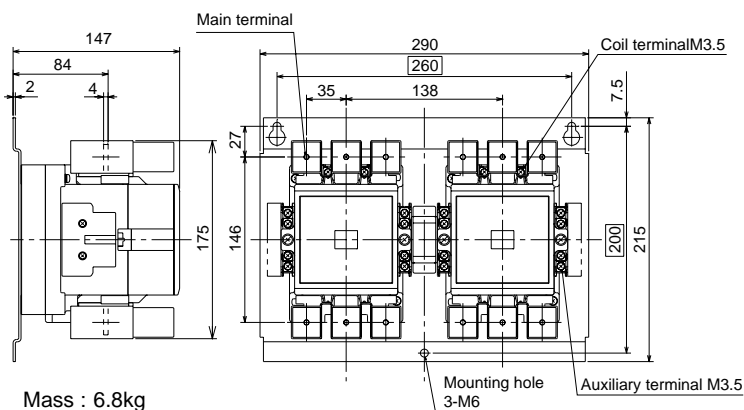

Mass : 6.8kg

- Wiring diagrams
- #### SC-E5RM to E7RM

(1NO+1NC) × 2

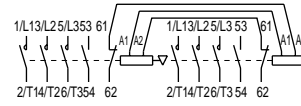

2NC × 2

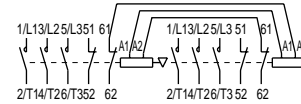

(2NO+2NC) × 2

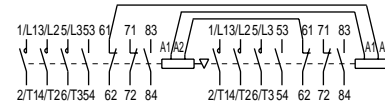

(3NO+NC) × 2

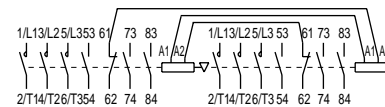

■ Dimensions, mm

• Reversing/DC operated

SC-02RM/G, 03RM/G, 04RM/G, 05RM/G

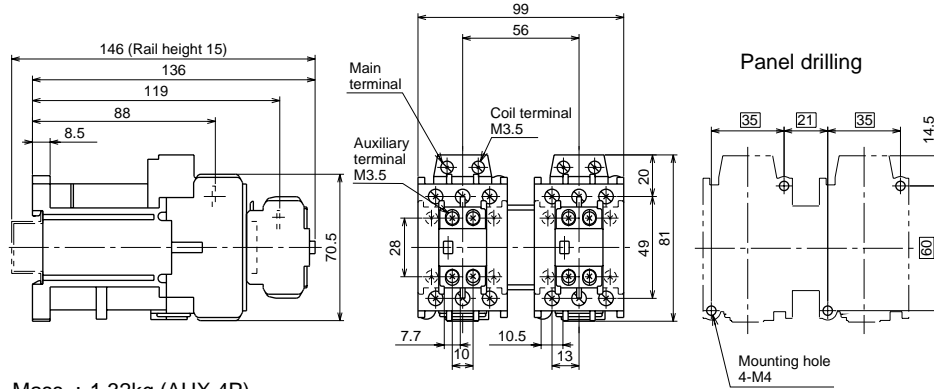

Mass : 1.32kg (AUX.4P)
 1.29kg(AUX.2P)

■ Wiring diagrams
 SC-E5RM to E7RM

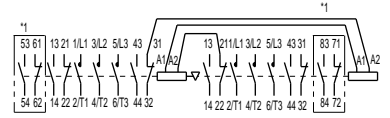

02

SC-E1RM/G, E2RM/G, E2SRM/G

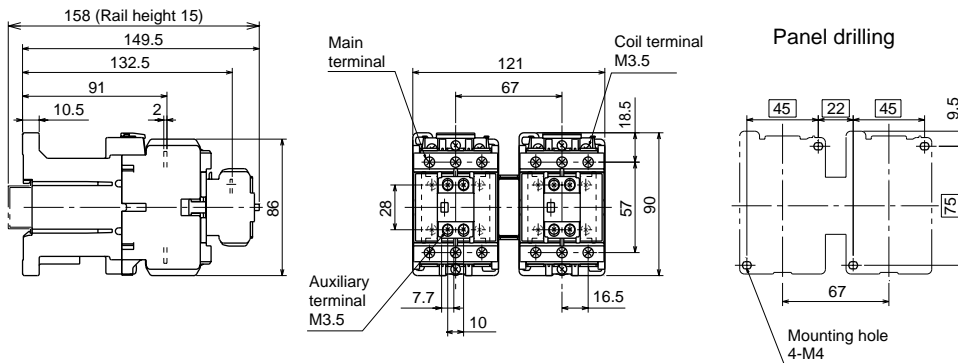

Mass : 1.72kg (AUX.4P)
 1.69kg(AUX.2P)

SC-E3RM/G, E4RM/G

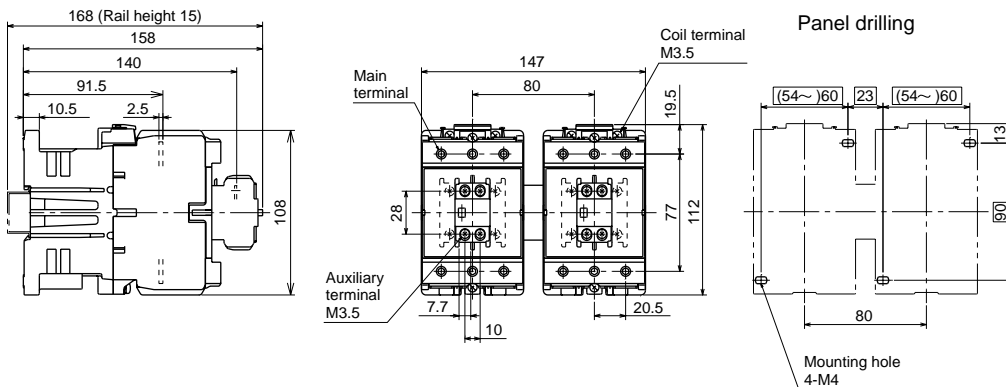

Mass : 2.84kg (AUX.4P)
 2.81kg(AUX.2P)

DUO series Contactors

SC-E series

Dimensions

■ Dimensions, mm

• Auxiliary contact blocks/Front mounting

SZ-A40/T, A31/T, A22/T, A20/T, A11/T, A02/T for SC-E02 to E4

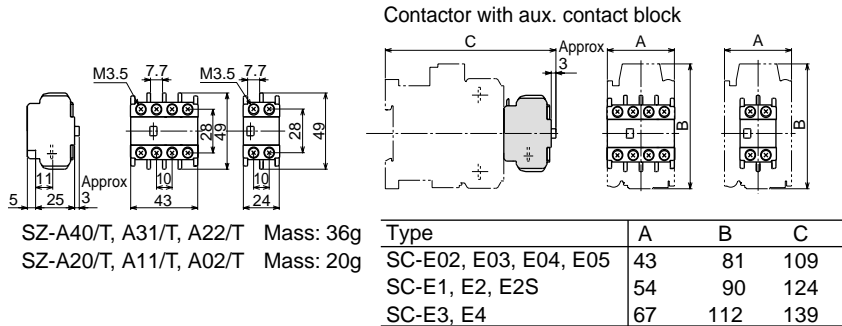

■ Wiring diagrams

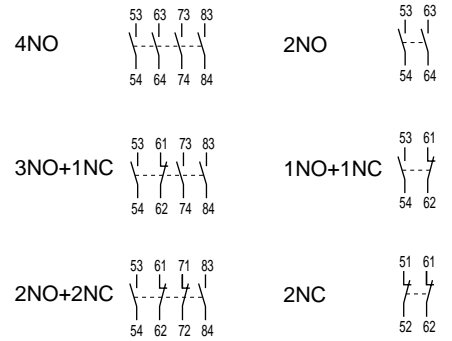

• Auxiliary contact blocks/Side mounting

SZ-AS1/T, for SC-E02 to E4

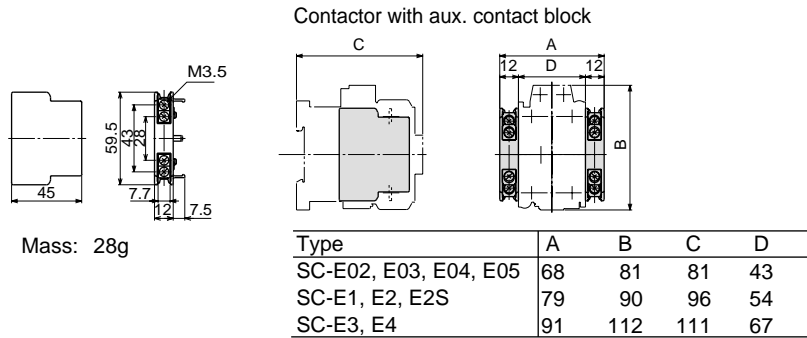

1NO+1NC

Mounted on right side



Mounted on left side



SZ-AS2/T, for SC-E5 to E7

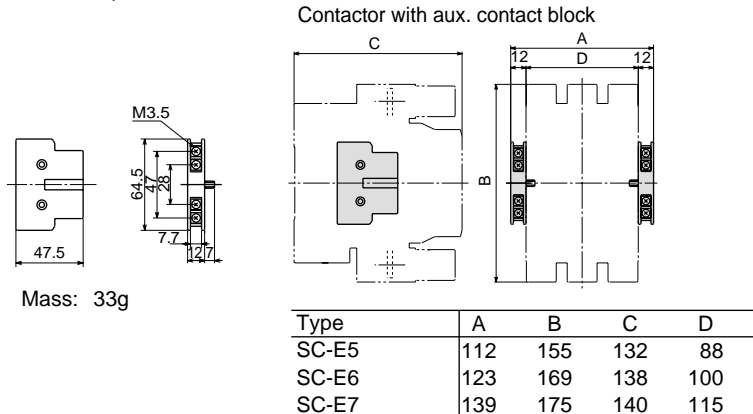

1NO+1NC

Mounted on right side



Mounted on left side



■ Dimensions, mm

• Main circuit surge suppression units

SZ-ZM1E

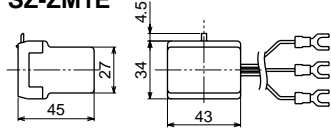

Contactor with surge suppression unit

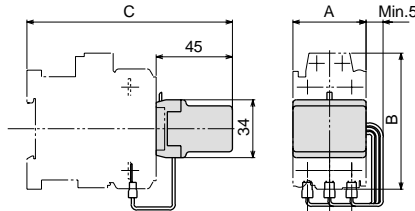

Type	A	B	C
SC-E02+SZ-ZM1E	43	81	121
SC-E03+SZ-ZM1E			
SC-E04+SZ-ZM1E			
SC-E05+SZ-ZM1E			
SC-E1+SZ-ZM3E	54	90	136
SC-E2+SZ-ZM3E			
SC-E2S+SZ-ZM3E			
SC-E3+SZ-ZM3E	67	112	151
SC-E4+SZ-ZM3E			

SZ-ZM3E

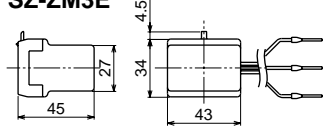

Mass: 60g

SZ-ZM2E

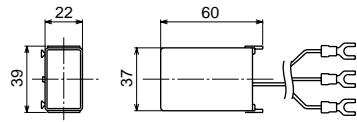

Contactor with surge suppression unit

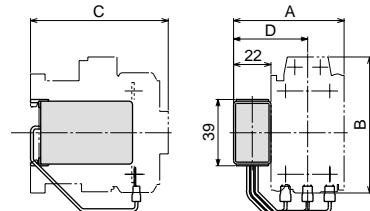

Type	A	B	C	D
SC-E02+SZ-ZM2E	65	81	81	43.5
SC-E03+SZ-ZM2E				
SC-E04+SZ-ZM2E				
SC-E05+SZ-ZM2E				
SC-E1+SZ-ZM2E				
SC-E2+SZ-ZM4E	76	90	96	49
SC-E2S+SZ-ZM4E				
SC-E3+SZ-ZM4E	89	112	111	55.5
SC-E4+SZ-ZM4E				

SZ-ZM4E

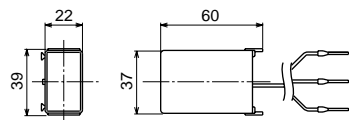

Mass: 60g

Connection diagram

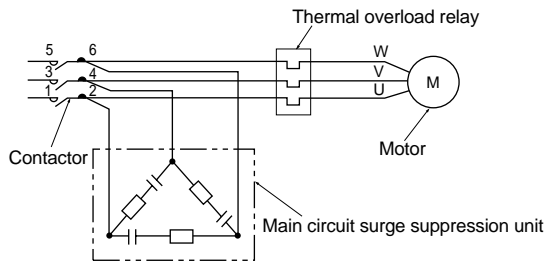

• Coil surge suppression units

SZ-Z1, Z2, Z3, Z4, Z5

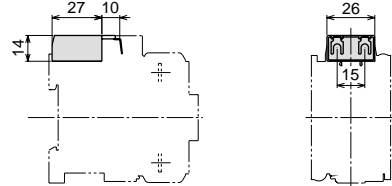

Mass: 14g

SZ-Z6, Z7, Z8, Z9

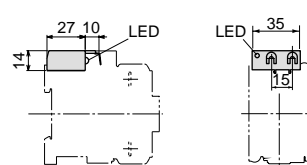

Mass: 16g

SZ-Z31, Z32, Z33, Z34, Z35, Z36, Z37

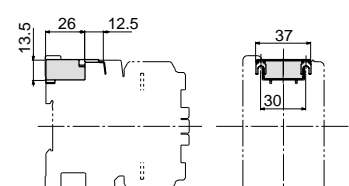

Mass: 15g

SC-E02 to E05 + SZ-Z1 to Z3
 (Built-in varistor)

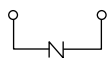

SC-E02 to E05 + SZ-Z6, Z7
 (Built-in varistor with operating indicator)

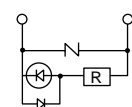

SC-E1 to E4 + SZ-Z31 to Z33
 (Built-in varistor)

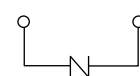

SC-E02 to E05 + SZ-Z4, Z5
 (Built-in CR)



SC-E02 to E05 + SZ-Z8, Z9
 (Built-in CR with operating indicator)

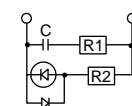

SC-E1 to E4 + SZ-Z34, Z35
 (Built-in CR)
 SC-E1/G to E4/G + SZ-Z36, Z37
 (Built-in CR)

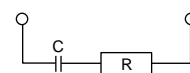

DUO series Contactors

SC-E series

Dimensions

■ Dimensions, mm

• Mechanical interlock unit SZ-RM

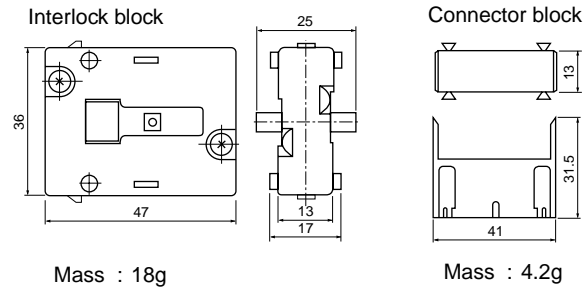

• Power connection kit for reversing For crossover wiring/SZ-ERW1/A

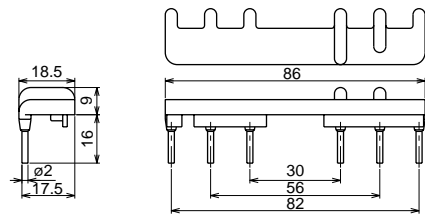

Mass : 19g

Used with	Wiring side	Wiring
SC-E02RM, E03RM, E04RM, E05RM	Line side	
SC-E02RM/G, E03RM/G, E04RM/G, E05RM/G		

Note : When using this connection kit, use a separate mounting thermal overload relay to connect to the magnetic contactor. If the attachment tab is used for assembly to the magnetic contactor, interference by components will make assembly impossible. To assemble using the attachment tab, use the SZ-ERW1/D type power connection kit.

For phase replacing wiring/SZ-ERW1/B

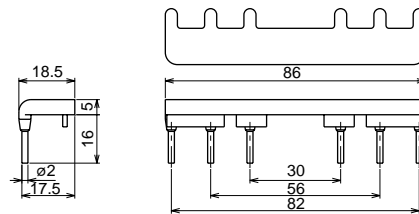

Mass : 17g

Used with	Wiring side	Wiring
SC-E02RM, E03RM, E04RM, E05RM	Load side	
SC-E02RM/G, E03RM/G, E04RM/G, E05RM/G		

Note : When using this connection kit, use a separate mounting thermal overload relay to connect to the magnetic contactor. If the attachment tab is used for assembly to the magnetic contactor, interference by components will make assembly impossible. To assemble using the attachment tab, use the SZ-ERW1/D type power connection kit.

For phase replacing wiring/SZ-ERW1/D

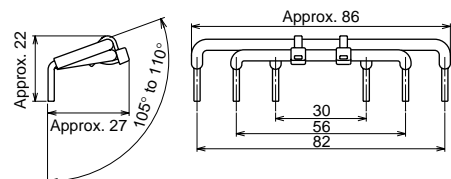

Mass : 13g

Used with	Wiring side	Wiring	Cable
SC-E02RM, E03RM, E04RM, E05RM	Load side		UL No3271 AWG12(Dia. Ø2) Color : Black
SC-E02RM/G, E03RM/G, E04RM/G, E05RM/G			

Note : Use this connection kit for assembly using the attachment tab of the thermal overload relay.

For crossover wiring/SZ-ERW2/A

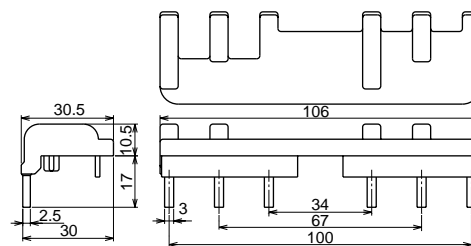

Mass : 48g

Used with	Wiring side	Wiring
SC-E1RM, E2RM, E2SRM	Line side	
SC-E1RM/G, E2RM/G, E2SRM/G		

Note : When using this connection kit, use a separate mounting thermal overload relay to connect to the magnetic contactor. If the attachment tab is used for assembly to the magnetic contactor, interference by components will make assembly impossible. To assemble using the attachment tab, use the SZ-ERW2/D type power connection kit.

■ Dimensions, mm

For phase replacing wiring/SZ-ERW2/B

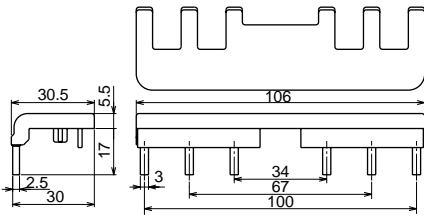

Mass : 42g

Used with	Wiring side	Wiring
SC-E1RM, E2RM, E2SRM	Load side	
SC-E1RM/G, E2RM/G, E2SRM/G		

Note : When using this connection kit, use a separate mounting thermal overload relay to connect to the magnetic contactor. If the attachment tab is used for assembly to the magnetic contactor, interference by components will make assembly impossible. To assemble using the attachment tab, use the SZ-ERW2/D type power connection kit.

For crossover wiring/SZ-ERW3/A

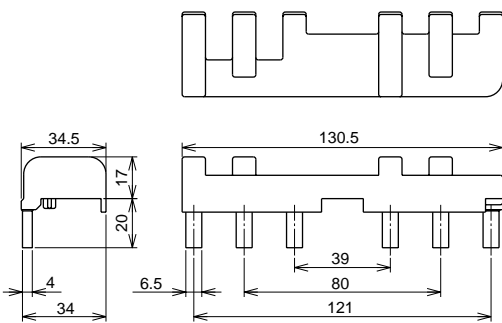

Mass : 162g

Used with	Wiring side	Wiring
SC-E3RM, E4RM	Line side	
SC-E3RM/G, E4RM/G		

Note : When using this connection kit, use a separate mounting thermal overload relay to connect to the magnetic contactor. If the attachment tab is used for assembly to the magnetic contactor, interference by components will make assembly impossible. To assemble using the attachment tab, use the SZ-ERW3/D type power connection kit.

For phase replacing wiring/SZ-ERW3/B

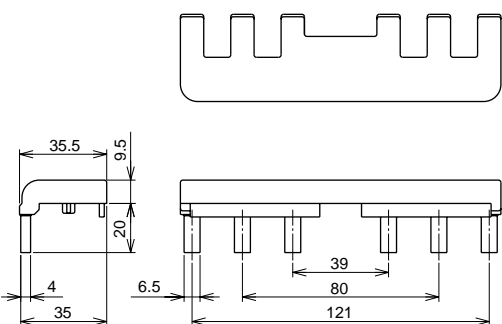

Mass : 138g

Used with	Wiring side	Wiring
SC-E3RM, E4RM	Load side	
SC-E3RM/G, E4RM/G		

Note : When using this connection kit, use a separate mounting thermal overload relay to connect to the magnetic contactor. If the attachment tab is used for assembly to the magnetic contactor, interference by components will make assembly impossible. To assemble using the attachment tab, use the SZ-ERW3/D type power connection kit.

For phase replacing wiring/SZ-ERW2/D

Terminal No. : 6/T3 – 2/T1

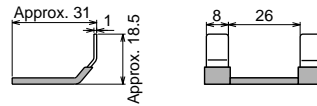

Terminal No. : 4/T2 – 4/T2

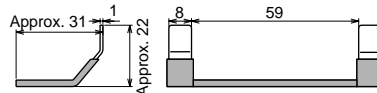

Terminal No. : 2/T1 – 6/T3

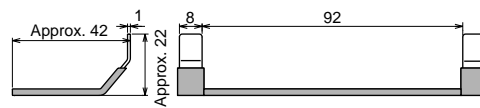

Mass : 31g

Used with	Wiring side	Wiring
SC-E1RM, E2RM, E2SRM	Load side	
SC-E1RM/G, E2RM/G, E2SRM/G		

Note : Use this connection kit for assembly using the attachment tab of the thermal overload relay.

For phase replacing wiring/SZ-ERW3/D

Terminal No. : 6/T3 – 2/T1

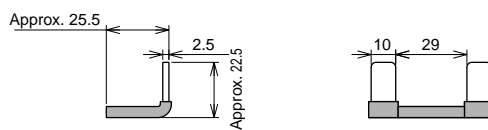

Terminal No. : 4/T2 – 4/T2

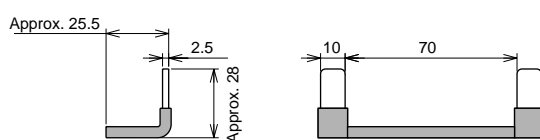

Terminal No. : 2/T1 – 6/T3

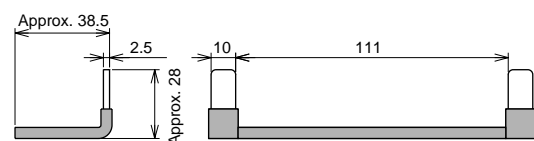

Mass : 110g

Used with	Wiring side	Wiring
SC-E3RM, E4RM	Load side	
SC-E3RM/G, E4RM/G		

Note : Use this connection kit for assembly using the attachment tab of the thermal overload relay.

DUO series Contactors

SC-E series

Dimensions

■ Dimensions, mm

For crossover wiring/SZ-ERW4/A

For phase replacing wiring/SZ-ERW4/B

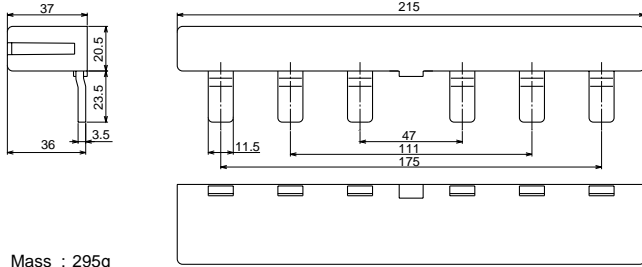

Mass : 295g

Used with	Type	Wiring side	Wiring
SC-E5RM	SZ-ERW4/A	Line side	
	SZ-ERW4/B	Load side	

Note : When using this connection kit, use a separate mounting thermal overload relay to connect to the magnetic contactor.

For crossover wiring/SZ-ERW5/A

For phase replacing wiring/SZ-ERW5/B

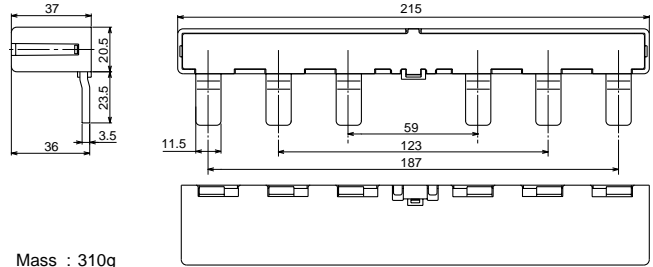

Mass : 310g

Used with	Type	Wiring side	Wiring
SC-E6RM	SZ-ERW5/A	Line side	
	SZ-ERW5/B	Load side	

Note : When using this connection kit, use a separate mounting thermal overload relay to connect to the magnetic contactor.

For crossover wiring/SZ-ERW6/A

For phase replacing wiring/SZ-ERW6/B

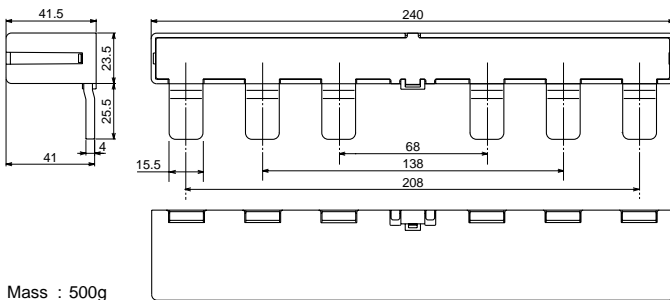

Mass : 500g

Used with	Type	Wiring side	Wiring
SC-E7RM	SZ-ERW6/A	Line side	
	SZ-ERW6/B	Load side	

Note : When using this connection kit, use a separate mounting thermal overload relay to connect to the magnetic contactor.

For crossover wiring (crimp terminal) /SZ-ERW1/A

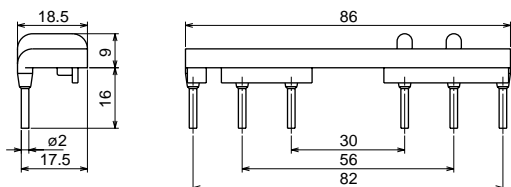

Mass:19g

Used with	Wiring side	Wiring
SC-E02PRM, E03PRM, E04PRM, E05PRM	Line side	
SC-E02PRM/G, E03PRM/G, E04PRM/G, E05PRM/G		

For phase replacing (crimp terminal) /SZ-EPRW1/C

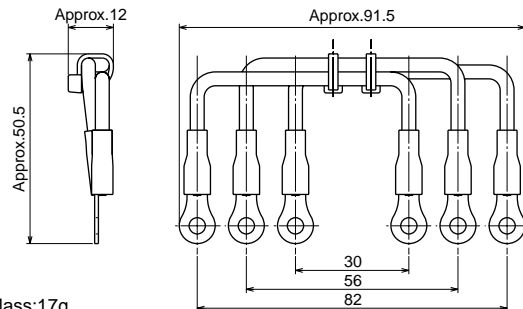

Mass:17g

Used with	Wiring side	Wiring
SC-E02PRM, E03PRM, E04PRM, E05PRM	Line side	
SC-E02PRM/G, E03PRM/G, E04PRM/G, E05PRM/G		

■ **Standard operating conditions**

The magnetic contactors are manufactured for use in the standard operating conditions given in the table at the right. Consult FUJI before using the magnetic contactors in different conditions.

■ **Wirings**

• **Connection wires and terminal processing**

Be sure to perform wiring correctly with reference to the connections diagram. Main terminals for models SC-E02 to SC-E7 are wired using solid wires or stranded wires. Stranded wires or flexible stranded wires can be connected by twisting them together, crimping a sleeve (ferrule) onto them before connecting.

• **Tightening torque**

If wires are not tightened sufficiently, they may become hot or come loose and result in a fire, short-circuit, electric shock, or some other potentially dangerous situation. Be sure to tighten the wires to the torques specified in the tables below.

• **Connectable wire sizes, tightening tools, tightening torques**



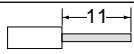

Main circuit

Contactor type	SC-E02, SC-E03, SC-E04, SC-E05	
Solid wire (mm ²)	One	0.75 to 6
	Two	1 to 4 or 1.5 to 6
Stranded wire (mm ²) *1	One	0.75 to 6
	Two	1 to 4 or 1.5 to 6
AWG	One	18 to 10
	Two	18 to 12 or 16 to 10
Sheath stripping length (mm)		
Terminal screw size	M4	
Tool	⊕ Phillips screwdriver, H-type, No. 2 (ISO 8764) ⊖ Flat-blade screwdriver, 1×5.5×L-type, B (ISO 2830)	
Tightening torque (N·m)	1.2 to 1.5	

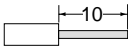
Ambient temperature	Operating: -5 to 55°C No sudden temperature changes resulting in condensation or icing (The average temperature over a 24-hour period must not exceed 35°C) Storage: -40 to 65°C	
Humidity	45 to 85%RH	
Altitude	2000m or lower	
Atmosphere	No excessive dust, smoke, corrosive gases, flammable gases, steam, or salt	
Vibration	10 to 55Hz 15m/s ²	
Shock	50m/s ²	
Mounting	Screw mounting, 35mm IEC top hat rail mounting (SC-E02 to SC-E4)	
Mounting angle		
Standard	IEC 60947-4-1, EN 60947-4-1, VDE 0660 JIS C 8201-4-1, UL 508, CSA C22.2 TÜV (EN60947-4-1)	

Control circuit

Solid or stranded wire (mm ²)	One	0.75 to 2.5 (ø1 to 1.6)
	Two	0.75 to 1.5 or 1.5 to 2.5
AWG	One	18 to 14
	Two	18 to 14
Sheath stripping length (mm)		
Fork terminal	Max. 7.7mm wide	
Terminal screw size	M3.5	
Tool	⊕ Phillips screwdriver, H-type, No. 2 (ISO 8764) ⊖ Flat-blade screwdriver, 1×5.5×L-type, B (ISO 2830)	
Tightening torque (N·m)	0.8 to 1	

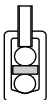
Contactor type	SC-E1, E2, E2S		SC-E3, E4	SC-E5, E6	SC-E7
Top-only connection 	Solid or stranded wire (mm ²) *1	0.75 to 35	1 to 70	2.5 to 70	4 to 120
	Flexible stranded wire with sleeve (mm ²)	0.75 to 25	1 to 50	2.5 to 50	2.5 to 95
	Flexible stranded wire without sleeve (mm ²)	0.75 to 25	1 to 50	2.5 to 50	4 to 95
	AWG	18 to 2	16 to 2/0	12 to 2/0	12 to 250MCM
	Sheath stripping length (mm) 	15	19.5	26.5	28.5
Bottom-only connection 	Solid or stranded wire (mm ²) *1	0.75 to 25	1 to 50	2.5 to 70	4 to 120
	Flexible stranded wire with sleeve (mm ²)	0.75 to 16	1 to 35	2.5 to 50	2.5 to 95
	Flexible stranded wire without sleeve (mm ²)	0.75 to 16	1 to 35	2.5 to 50	4 to 95
	AWG	18 to 3	16 to 1/0	12 to 2/0	12 to 250MCM
	Sheath stripping length (mm) 	12.5	16	26.5	28.5
Top/bottom connection 	Solid or stranded wire (mm ²) *1	Top/bottom 0.75 to 25	1 to 50	2.5 to 70	4 to 120
	Flexible stranded wire with sleeve (mm ²)	Top/bottom 0.75 to 16	1 to 35	2.5 to 50	2.5 to 95
	Flexible stranded wire without sleeve (mm ²)	Top/bottom 0.75 to 16	1 to 35	2.5 to 50	4 to 95
	AWG	Top/bottom 18 to 3	16 to 1/0	12 to 2/0	12 to 250MCM
	Tool	⊕ Phillips screwdriver, H-type, No. 2 (ISO 8764) ⊖ Flat-blade screwdriver, 1×5.5×L-type, B (ISO 2830)		⊙ Hex. wrench 4 (ISO 2936)	
Tightening torque (N·m)	2.5		8		10
Self-locking torque (N·m) *2	1		2		

Notes: *1 Stranded wire (0 to 35mm²) consists of 7 wires or less.
 Stranded wire (38 to 120mm²) consists of 19 wires or less.
 Flexible stranded wire consists of more number wires than the above.

*2 The tightening bolt must be loosened in order to insert the wire. However, stop loosening the bolt when the anti-drop attachment on the bottom of the bolt reaches the top edge of the terminal. If a torque exceeding that given in the table is applied in this state, the retaining plate may come loose.







DUO series Contactors

SC-E series



Operating conditions



• Connectable wire size and tightening torque (Ring terminal connection type)

Main circuit

Contactor type	Terminal screw *1	Connectable wire size (mm ²)	Applicable ring terminal max. width (mm) *2 *4	Tightening torque (N·m)
SC-E02P to E05P	M4  	1.25 to 6	9.7 (R1.25-4 to R5.5-4)	1.2 to 1.5
SC-E1P to E2SP	M5  	2 to 22	12.4 *3 (R2-5 to R22-5)	2.0 to 2.5
SC-E3P, E4P	M6  	2 to 38	16.7 *3 (R2-6 to R38-6)	4.0 to 5.0



Control circuit

Contactor type	Terminal screw *1	Connectable wire size (mm ²)	Applicable ring terminal max. width (mm) *2	Tightening torque (N·m)
	Coil terminal (Contactor)	Coil terminal (Contactor)	Coil terminal (Contactor)	Coil terminal (Contactor)
SC-E02P to E4P	M3.5  	1.25 to 2 (1.2 to 2mm dia.)	7.7 (R1.25-3.5 to R2-3.5)	0.8 to 1.0

Note 1 The motor starter has plus-minus shaped terminal screws of   (M4, M5).

Note 2 Two wires or two crimp terminals can be connected to each terminal.

Note 3 Use insulation caps to use ring crimp terminals.

*1  : Cross-recessed pan-head screw  : Non-oriented square washer, turtleback washer

– : Circular bright plain washer  : Cross-recessed hexagonal head bolt

*2 Round crimp terminal JIS C 2805

*3 Use crimp terminals of max. width or less. (Use narrow-width terminals made by crimp terminal manufacturers.)

*4 Use crimp terminal manufacturers' standard models.

TK-E series with phase-loss protective device

■ **Features**

- This relay protects motor windings from burning due to overloads, locked rotor current, or phase-loss.
- Maintenance and inspection safety has been improved by employing a finger protection mechanism to cover exposed terminals (conforms to DIN 57106, VDE 0106 Teil 100).
- Isolated NO and NC contacts can be used with different potentials.
- A high-precision scale for the current adjustment dial enables easy and exact current setting.
- The operating status can be visually checked with ease.
- The relays can be manually tripped. A trip-free mechanism is also provided.
- Base unit can be added to enable separate-mounting types of the TK-E02, E2, and E3 models.

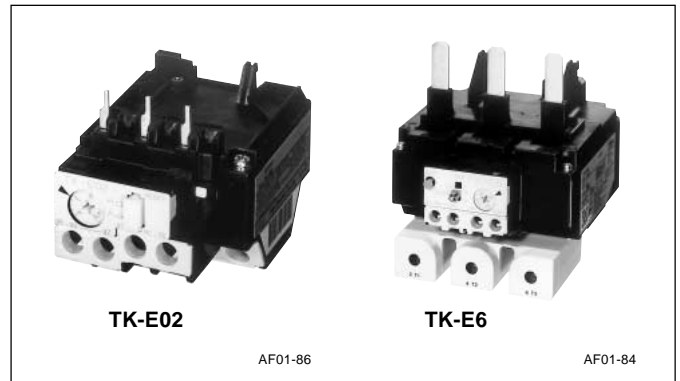

■ **Types and specifications**

Applicable contactor Non-reversing	Type	Aux. contact	Trip category (JIS)	No. of heater elements	Power consumption per pole	Provided functions
SC-E02, E03, E04, E05 SC-E1, E2, E2S SC-E3, E4 SC-E5 SC-E6, E7 Separate mounting type	TK-E02 TK-E2 TK-E3 TK-E5 TK-E6 TK-E6H	1NO+1NC	10A	3	2.2VA 3.8VA 6.6VA 6.6VA 8.0VA	Overload, phase-loss protection Ambient temperature compensation Manual/auto reset selectable Manual trip mechanism Trip indicator

■ **Ampere setting range**

Order current (A)	Thermal overload relay type				
	TK-E02	TK-E2	TK-E3	TK-E5	TK-E6, E6H *
0.1	0.1–0.15				
0.13	0.13–0.2				
0.15	0.15–0.24				
0.2	0.2–0.3				
0.24	0.24–0.36				
0.3	0.3–0.45				
0.36	0.36–0.54				
0.48	0.48–0.72				
0.64	0.64–0.96				
0.8	0.8–1.2				
0.95	0.95–1.45				
1.4	1.4–2.2				
1.7	1.7–2.6				
2.2	2.2–3.4				
2.8	2.8–4.2				
4	4–6	4–6			
5	5–8	5–8			
6	6–9	6–9			
7	7–11	7–11	7–11		
9	9–13	9–13	9–13		
12	12–18	12–18	12–18		
16	16–22				
18		18–26	18–26	18–26	
20	20–25				
24		24–36	24–36	24–36	
28			28–40	28–40	
32		32–42			
34			34–50	34–50	
40		40–50			
44		44–54			
45			45–65	45–65	45–65
48			48–68		
53					53–80
64			64–80		
65			65–95 *	65–95	65–95
85			85–105 *	85–105	
85					85–125
110					110–160

Note: * Applicable only for separate-mounting type. Not applicable for use in combination with a magnetic contactor.

■ **Standards**

IEC 60947-4-1, EN60947-4-1
 VDE 0660, JIS C 8201-4-1
 UL 508, CSA C22.2
 TÜV (EN60947-4-1)

■ **Ordering information**

Specify the following:

1. Type number
2. Ampere setting range order current

DUO series Contactors

SC-E series

Thermal overload relays

■ Auxiliary contact ratings

• Based on JIS and IEC

Type	Rated insulation voltage (V)	Rated thermal current (A)	Rated operational current (A)				Minimum voltage and current
			AC Voltage (V)	AC-15 Ind. load	DC Voltage (V)	DC-13 Ind. load	
TK-E02	690	5	24	3 (0.3) *	24	1.1 (0.3)	3V DC, 5mA
			100-120	2.5 (0.3) *	100-120	0.28	
			200-240	2 (0.3) *	200-240	0.14	
			380-440	1 (0.3) *			
			500-600	0.6 (0.3) *			
TK-E2	690	5	24	3 (0.5) *	24	1.1 (0.3)	3V DC, 5mA
TK-E3			100-120	2.5 (0.5) *	100-120	0.28	
TK-E5			200-240	2 (0.5) *	200-240	0.14	
TK-E6			380-440	1 (0.5) *			
			500-600	0.6 (0.5) *			

Note: * In case of auto reset type NO contact.

• Based on UL and CSA

Type	Rated insulation voltage (V)	Rated thermal current (A)	Making and breaking current (A)			DC (rating code R300)		
			AC (rating code B600) Voltage (V)	Making (A)	Breaking (A)	Voltage (V)	Making (A)	Breaking (A)
TK-E02	600	5	120	30	3	120	0.22	0.22
TK-E2, E3			240	15	1.5	250	0.11	0.11
TK-E5			480	7.5	0.75			
TK-E6			600	6	0.6			

■ Operating characteristics (mean value)

• TK-E02

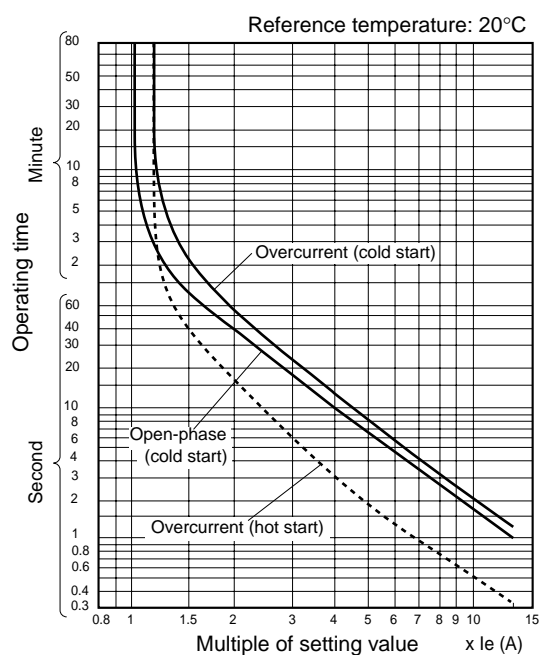

• TK-E2 to E6, E6H

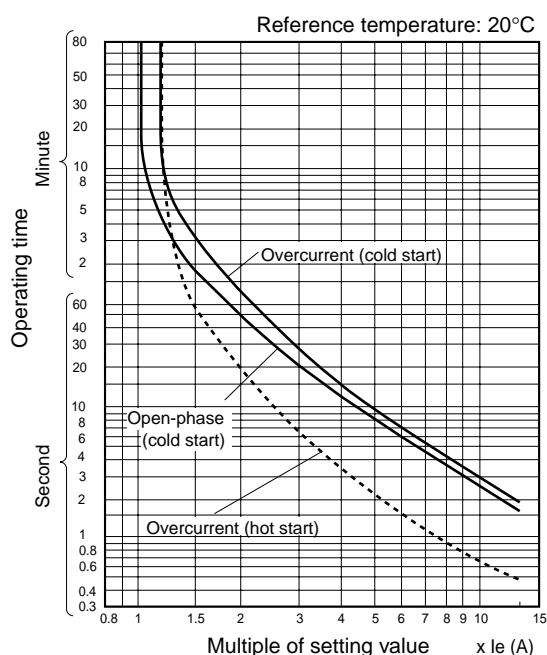

■ **Optional accessories**

• **Base units for separate mounting**

The base unit modifies thermal overload relays to separate mounting types that can be mounted to 35mm-wide IEC top hat rail or secured with screws.

Applicable thermal overload relay	Type
TK-E02	SZ-HCE
TK-E2	SZ-HDE
TK-E3	SZ-HEE

• **Trip indicator**

Reports any tripping action at a thermal overload relay through its LED display.

Applicable thermal overload relay	Rated voltage	Type
TK-E02	100–110V AC, 50/60Hz	SZ-L100
	200–220V AC, 50/60Hz	SZ-L200
TK-E2 to TK-E6	100–110V AC, 50/60Hz	SZ-L100N2
	200–220V AC, 50/60Hz	SZ-L200N2

• **Reset release button**

Reset a thermal overload relay from the rear side of the board or a distant location.

Applicable thermal overload relay	Load length (mm)	Type
TK-E02	300	SZ-R1
	500	SZ-R2
	700	SZ-R3
TK-E2 to TK-E6	300	SZ-R4
	500	SZ-R5
	700	SZ-R6

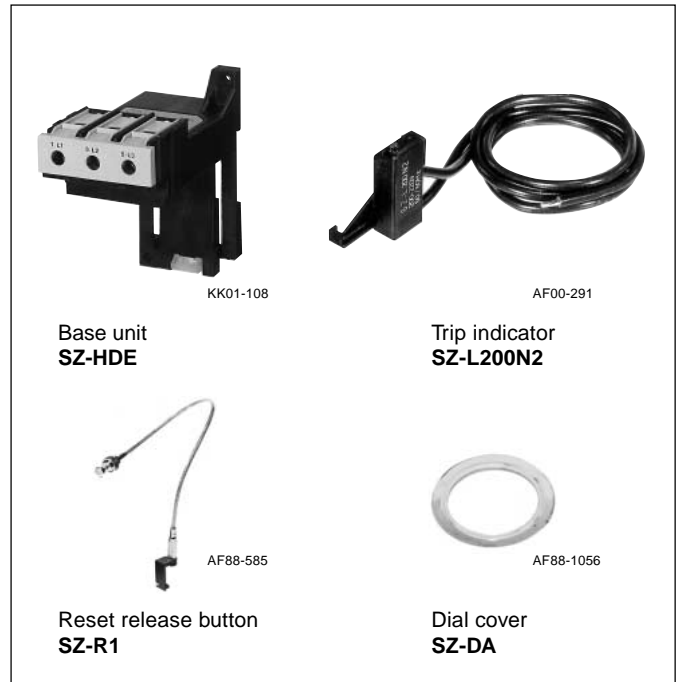

• **Dial cover**

Protects the setting current value of a thermal overload relay from being changed unintentionally.

Applicable thermal overload relay	Type
TK-E02 to TK-E6	SZ-DA

DUO series Contactors

SC-E series

Thermal overload relays

■ Dimensions, mm

TK-E02

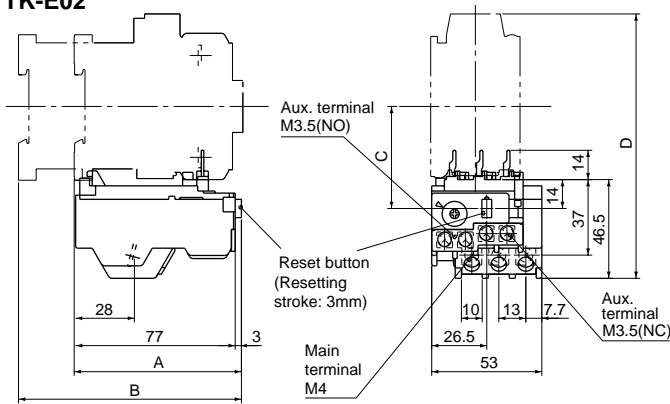

Contactor	A	B	C	D	Mass
SC-E02 to 05	80.5	—	49	127.5	0.13kg
SC-E02/G to 05/G	—	107.5	49	127.5	

TK-E2

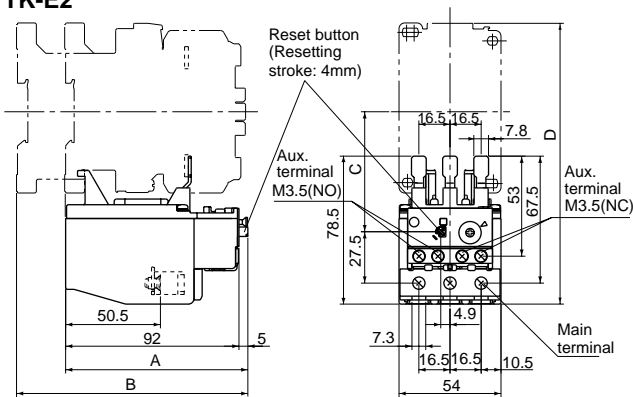

Contactor	A	B	C	D	Mass
SC-E1 to E2S	97	—	63.5	149	0.25kg
SC-E1/G to E2S/G	—	123	63.5	149	

TK-E3

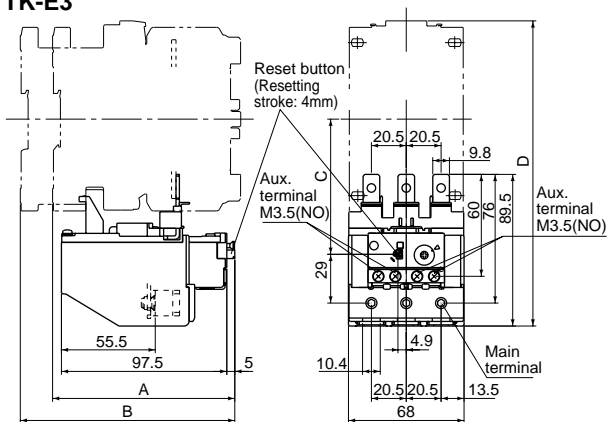

Contactor	A	B	C	D	Mass
SC-E3, E4	107.5	—	79.5	180	0.34kg
SC-E3/G, E4/G	—	126.5	79.5	180	

TK-E5 On-contactor mounting only

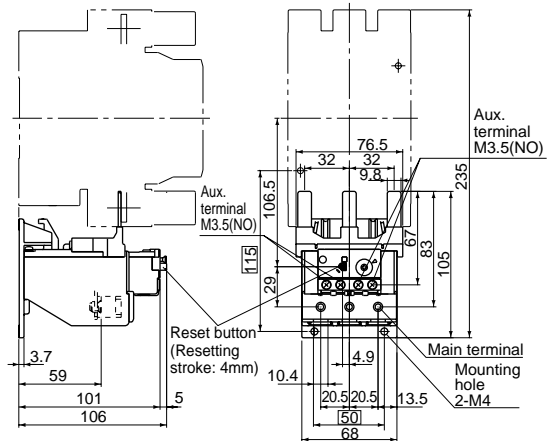

Mass: 0.37kg

TK-E6 On-contactor mounting only

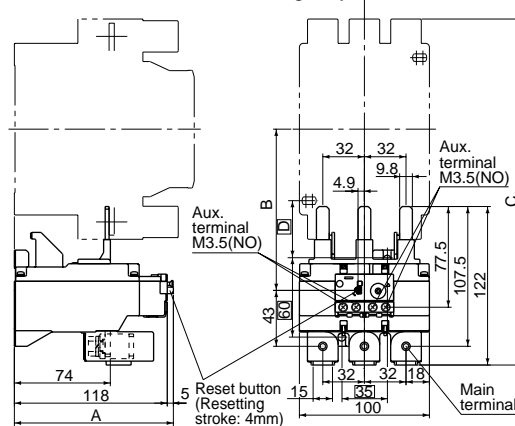

Contactor	A	B	C	D	Mass
SC-E6	123	124	266.5	45	0.71kg
SC-E7	123	129	274	50	

TK-E6H For separate mounting only

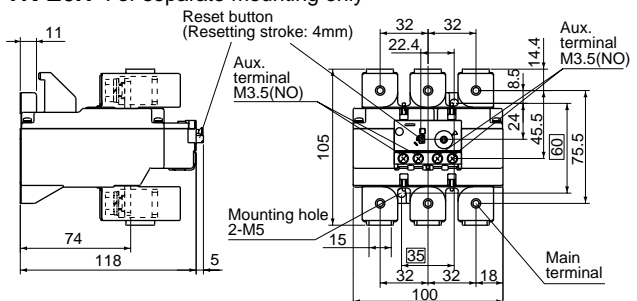

Mass: 0.82kg

■ Wiring diagrams

3-heater element

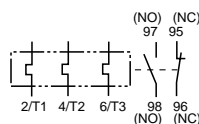

■ Dimensions, mm

• Base units for separate mounting

SZ-HCE

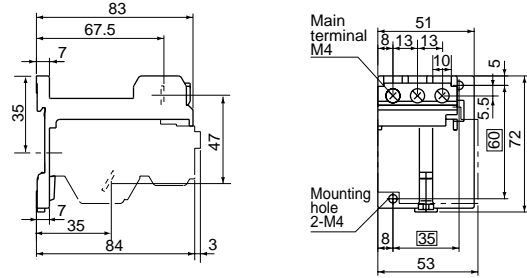

Mass: 55g

SZ-HDE

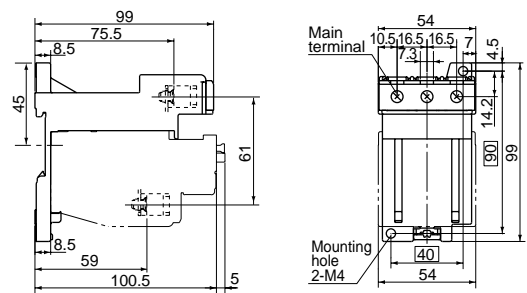

Mass: 0.1kg

SZ-HEE

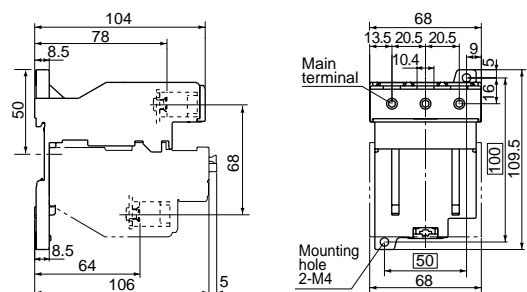

Mass: 0.15kg

• Trip indicators
SZ-L100, L200

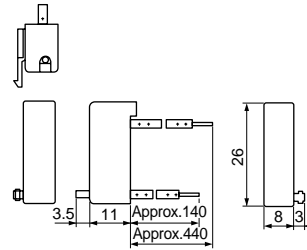

SZ-L100N2, L200N2

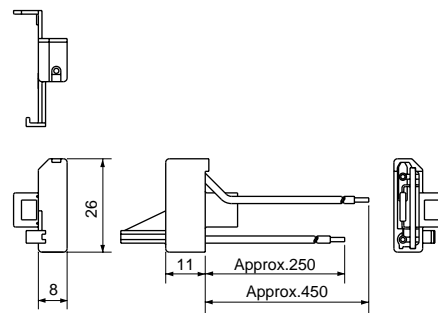

• Reset release button

SZ-R1, R2, R3

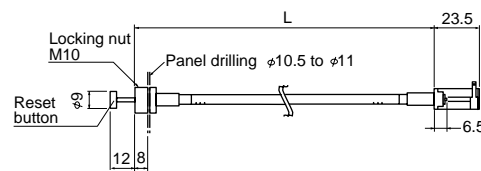

Type	L
SZ-R1	300
SZ-R2	500
SZ-R3	700

SZ-R4, R5, R6

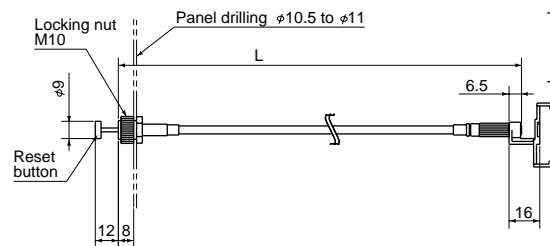

Type	L
SZ-R4	300
SZ-R5	500
SZ-R6	700

• Dial cover

SZ-DA

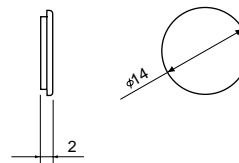

DUO series Contactors

SC-E series

Thermal overload relays

■ Standard operating conditions

The thermal overload relays are manufactured for use in the standard operating conditions given in the table at the right. Consult FUJI before using the thermal overload relays in different conditions.

Ambient temperature	Operating: -5 to 55°C No sudden temperature changes resulting in condensation or icing (The average temperature over a 24-hour period must not exceed 35°C) Storage: -40 to 65°C
Humidity	45 to 85%RH
Atmosphere	No excessive dust, smoke, corrosive gases, flammable gases, steam, or salt
Vibration	10 to 55Hz 15m/s ²
Shock	50m/s ²

■ Wirings

• Connection-wires and terminal processing

Be sure to perform wiring correctly with reference to the connections diagram. Main terminals for models TK-E02 to TK-E6 are wired using solid wires or stranded wires. Stranded wires or flexible stranded wires can be connected by twisting them together, crimping a sleeve (ferrule) onto them before connecting.

• Tightening torque

If wires are not tightened sufficiently, they may become hot or come loose and result in a fire, short-circuit, electric shock, or some other potentially dangerous situation. Be sure to tighten the wires to the torques specified in the tables below.

• Connectable wire sizes, tightening tools, tightening torques

Main circuit

Thermal overload relay type	TK-E02	
Base unit type	SZ-HCE	
Solid wire (mm ²)	One	0.75 to 4
	Two	1 to 4
Stranded wire (mm ²) *1	One	0.75 to 4
	Two	1 to 4
AWG	One	18-12
	Two	18-12
Sheath stripping length (mm)		
Terminal screw size	M4	
Tool	⊕ Phillips screwdriver, H-type, No. 2 (ISO 8764) ⊖ Flat-blade screwdriver, 1×5.5×L-type, B (ISO 2830)	
Tightening torque [N·m]	1.2 to 1.5	

Control circuit

Solid or stranded wire (mm ²)	One	0.75 to 2.5 (ø1 to ø1.6)
	Two	0.75 to 1.5 or 1.5 to 2.5
AWG	One	18 to 14
	Two	18 to 14
Sheath stripping length (mm)		
Fork terminal	Max. 7.7mm wide (R2-3.5)	
Terminal screw size	M3.5	
Tool	⊕ Phillips screwdriver, H-type, No. 2 (ISO 8764) ⊖ Flat-blade screwdriver, 1×5.5×L-type, B (ISO 2830)	
Tightening torque [N·m(lb·in)]	0.8 to 1	

Thermal overload relay type	TK-E2	TK-E3	TK-E5	TK-E6, E6H	
Base unit type	SZ-HDE	SZ-HEE	-	-	
	Solid or stranded wire (mm ²) *1	0.75 to 22	1 to 38	16 to 70	
	Flexible stranded wire with sleeve (mm ²)	0.75 to 22	1 to 38	16 to 70	
	Flexible stranded wire without sleeve (mm ²)	0.75 to 22	1.5 to 38	16 to 70	
	AWG	18-4	18-0	6-3/0	
	Sheath stripping length (mm)	18	21	23	
	Tool	⊕ Phillips screwdriver, H-type, No. 2 (ISO 8764) ⊖ Flat-blade screwdriver, 1×5.5×L-type, B (ISO 2830)	⊙ Hex. wrench 4 (ISO 2936)		
	Tightening torque (N·m)	2.5	6	10	

Notes: *1 Stranded wire (0 to 35mm²) consists of 7 wires or less.
Stranded wire (38 to 120mm²) consists of 19 wires or less.
Flexible stranded wire consists of more number wires than the above.

■ **Description**

- The combination starter protects the motor from short-circuit and overcurrent accidents in the three-phase motor circuit within a range between 15kW at 240V AC and 22kW at 415V AC, up to a current level of 50A.
- The manual motor starter provides overload, phase-loss, and short-circuit protections for the motor circuit, and incorporates a dial for flexible adjustment to match the total load current of the motor.
- The magnetic contactor allows remote ON/OFF operation of the motor circuit with high frequency, and features a electrical durability of one million operations.
- The manual motor starter and magnetic contactor are connected via link module and mounted to a base plate.

■ **Features**

Reduction and space-saving design

- The combination starter consists of a manual motor starter and magnetic contactor that can be assembled by the user to achieve a compact motor control circuit.
- The modular wiring system reduces wiring works, shortens required mounting time, and decreases the mounting area.
- The busbar system and connecting modules make it possible to reduce complicated wiring work.

Comforms to IEC standard

- The combination starter conforms to IEC 60947 requirements for magnetic motor starters and short circuit protective device of coordination types 1 and 2, thus greatly reducing the possibility of an accident spreading to affect other equipment.
- The combination starter can be mounted to IEC top hat rail using the base plate.

Protection against exposure to charged parts

- A busbar system, busbar cover, and terminals with finger protection prevent exposure to charged parts.

■ **Busbar system**

Various wiring materials available to reduce both wiring and wiring steps.

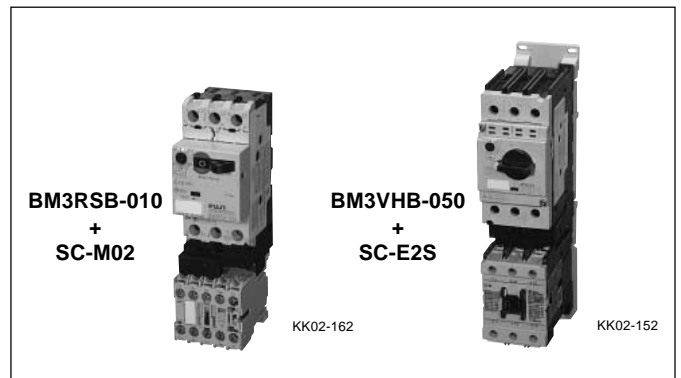
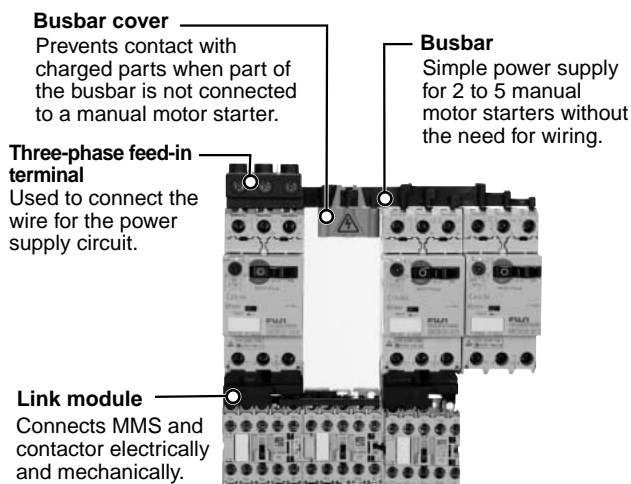

■ **Application example**

Combining modular equipment enables compact control panel configurations.

Combination starters and busbar systems help to downsize equipment.

• **Example of 8-motor control circuit**

Conventional control panel

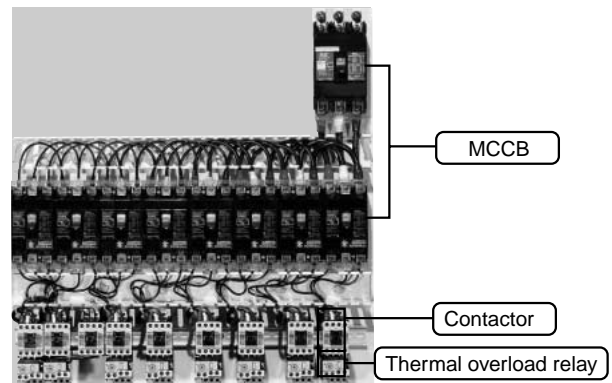

New control panel

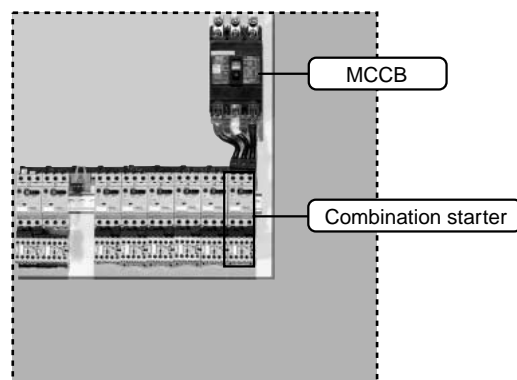

Mounting space: 52% reduction

Wiring space: 90% reduction

DUO series Combination Starters

Protective coordination

■ Protective coordination between MMSs and contactors/combination starters

• IEC 60947-4-1 Type 1 The rated conditional short-circuit current $I_q=50kA/240V$ AC, 415V AC

Motor capacity and full load current 3-phase				Manual motor starter		Magnetic contactor		Link module	Base plate
200–240V AC		380–415V AC		Type	Adjustable current range (A)	Type	Rated operational current AC-3 (A)		
Capacity (kW)	Current (A)	Capacity (kW)	Current (A)						
0.03	0.24	0.06	0.23	BM3RSB-P25 BM3RHB-P25	0.16 to 0.25	SC-M01 SC-E02	6 9	BZ0LRC09AA BZ0LRE22AA	*1 (BZ0BPVE22A) BZ0BPVE22A
0.06	0.37	0.09	0.32	BM3RSB-P40 BM3RHB-P40	0.25 to 0.4	SC-M01 SC-E02	6 9	BZ0LRC09AA BZ0LRE22AA	*1 (BZ0BPVE22A) BZ0BPVE22A
–	–	0.12	0.5	BM3RSB-P63 BM3RHB-P63	0.4 to 0.63	SC-M01 SC-E02	6 9	BZ0LRC09AA BZ0LRE22AA	*1 (BZ0BPVE22A) BZ0BPVE22A
0.12	0.68	0.18	0.65	BM3RSB-001 BM3RHB-001	0.63 to 1.0	SC-M01 SC-E02	6 9	BZ0LRC09AA BZ0LRE22AA	*1 (BZ0BPVE22A) BZ0BPVE22A
–	–	0.25	0.9	BM3RSB-001 BM3RHB-001	0.63 to 1.0	SC-M01 SC-E02	6 9	BZ0LRC09AA BZ0LRE22AA	*1 (BZ0BPVE22A) BZ0BPVE22A
0.2	1.3	0.37	1.25	BM3RSB-1P6 BM3RHB-1P6	1.0 to 1.6	SC-M01 SC-E02	6 9	BZ0LRC09AA BZ0LRE22AA	*1 (BZ0BPVE22A) BZ0BPVE22A
–	–	0.55	1.6	BM3RSB-2P5 BM3RHB-2P5	1.0 to 1.6	SC-M01 SC-E02	6 9	BZ0LRC09AA BZ0LRE22AA	*1 (BZ0BPVE22A) BZ0BPVE22A
0.4	2.3	0.75	2	BM3RSB-2P5 BM3RHB-2P5	1.6 to 2.5	SC-M01 SC-E02	6 9	BZ0LRC09AA BZ0LRE22AA	*1 (BZ0BPVE22A) BZ0BPVE22A
–	–	1.1	2.5	BM3RSB-004 BM3RHB-004	2.5 to 4.0	SC-M01 SC-E02	6 9	BZ0LRC09AA BZ0LRE22AA	*1 (BZ0BPVE22A) BZ0BPVE22A
0.75	3.6	1.5	3.5	BM3RSB-004 BM3RHB-004	2.5 to 4.0	SC-M01 SC-E02	6 9	BZ0LRC09AA BZ0LRE22AA	*1 (BZ0BPVE22A) BZ0BPVE22A
–	–	2.2	5	BM3RSB-6P3 BM3RHB-6P3	4.0 to 6.3	SC-M01 SC-E02	6 9	BZ0LRC09AA BZ0LRE22AA	*1 (BZ0BPVE22A) BZ0BPVE22A
1.5	6.1	3	6.5	BM3RSB-010 BM3RHB-010	6.3 to 10	SC-M02 SC-E02	9 9	BZ0LRC09AA BZ0LRE22AA	*1 (BZ0BPVE22A) BZ0BPVE22A
2.2	9	4	9	BM3RSB-010 BM3RHB-010	6.3 to 10	SC-M02 SC-E02	9 9	BZ0LRC09AA BZ0LRE22AA	*1 (BZ0BPVE22A) BZ0BPVE22A
3	12	5.5	12	BM3RSB-013 BM3RHB-013	9 to 13	SC-E03	12	BZ0LRE22AA	BZ0BPVE22A
4	16	7.5	16	BM3RHB-020	14 to 20	SC-E04	18	BZ0LRE22AA	BZ0BPVE22A
5.5	22	11	22	BM3RHB-025	19 to 25	SC-E05	25	BZ0LRE22AA	BZ0BPVE22A
7.5	29	15	30	BM3RHB-032 BM3VHB-032	24 to 32	SC-E1	32	BZ0LRE32AA BZ0LVE51AA	BZ0BPVE32A BZ0BPVE51A
11	40	18.5	37	BM3VHB-040	28 to 40	SC-E2	40	BZ0LVE51AA	BZ0BPVE51A
15	50	22	48	BM3VHB-050	35 to 50	SC-E2S	50	BZ0LVE51AA	BZ0BPVE51A

Notes: • The full-load current of each three-phase motor is a reference value. Check the actual full-load current of the motor before use.

• The above table shows combinations with AC operated type magnetic contactors. The link module will differ if the magnetic contactor is a DC operated type.

*1 Use the base plate type in () when you use the base plate.

• IEC 60947-4-1 Type 2 The rated conditional short-circuit current Iq=50kA/240V AC, 415V AC

Motor capacity and full load current 3-phase				Manual motor starter		Magnetic contactor		Link module	Base plate
200–240V AC		380–415V AC		Type	Adjustable current range (A)	Type	Rated operational current AC-3 (A)		
Capacity (kW)	Current (A)	Capacity (kW)	Current (A)						
0.03	0.24	0.06	0.23	BM3RSB-P25	0.16 to 0.25	SC-M01	6	BZ0LRC09AA	*1 (BZ0BPVE22A)
				BM3RHB-P25		SC-E02	9	BZ0LRE22AA	BZ0BPVE22A
0.06	0.37	0.09	0.32	BM3RSB-P40	0.25 to 0.4	SC-M01	6	BZ0LRC09AA	*1 (BZ0BPVE22A)
				BM3RHB-P40		SC-E02	9	BZ0LRE22AA	BZ0BPVE22A
–	–	0.12	0.5	BM3RSB-P63	0.4 to 0.63	SC-M01	6	BZ0LRC09AA	*1 (BZ0BPVE22A)
				BM3RHB-P63		SC-E02	9	BZ0LRE22AA	BZ0BPVE22A
0.12	0.68	0.18	0.65	BM3RSB-001	0.63 to 1.0	SC-M01	6	BZ0LRC09AA	*1 (BZ0BPVE22A)
				BM3RHB-001		SC-E02	9	BZ0LRE22AA	BZ0BPVE22A
–	–	0.25	0.9	BM3RSB-001	0.63 to 1.0	SC-M01	6	BZ0LRC09AA	*1 (BZ0BPVE22A)
				BM3RHB-001		SC-E02	9	BZ0LRE22AA	BZ0BPVE22A
0.2	1.3	0.37	1.25	BM3RSB-1P6	1.0 to 1.6	SC-M01	6	BZ0LRC09AA	*1 (BZ0BPVE22A)
				BM3RHB-1P6		SC-E02	9	BZ0LRE22AA	BZ0BPVE22A
–	–	0.55	1.6	BM3RSB-1P6	1.0 to 1.6	SC-M01	6	BZ0LRC09AA	*1 (BZ0BPVE22A)
				BM3RHB-1P6		SC-E02	9	BZ0LRE22AA	BZ0BPVE22A
0.4	2.3	0.75	2	BM3RSB-2P5	1.6 to 2.5	SC-M01	6	BZ0LRC09AA	*1 (BZ0BPVE22A)
				BM3RHB-2P5		SC-E02	9	BZ0LRE22AA	BZ0BPVE22A
–	–	1.1	2.5	BM3RSB-004	2.5 to 4.0	SC-M01	6	BZ0LRC09AA	*1 (BZ0BPVE22A)
				BM3RHB-004		SC-E02	9	BZ0LRE22AA	BZ0BPVE22A
0.75	3.6	1.5	3.5	BM3RSB-004	2.5 to 4.0	SC-E03	12	BZ0LRE22AA	BZ0BPVE22A
				BM3RHB-004					
–	–	2.2	5	BM3RSB-6P3	4.0 to 6.3	SC-E04	18	BZ0LRE22AA	BZ0BPVE22A
				BM3RHB-6P3					
1.5	6.1	3	6.5	BM3RSB-010	6.3 to 10	SC-E04	18	BZ0LRE22AA	BZ0BPVE22A
				BM3RHB-010					
2.2	9	4	9	BM3RSB-010	6.3 to 10	SC-E04	18	BZ0LRE22AA	BZ0BPVE22A
				BM3RHB-010					
3	12	5.5	12	BM3RSB-013	9 to 13	SC-E05	25	BZ0LRE22AA	BZ0BPVE22A
				BM3RHB-013					
4	16	7.5	16	BM3RHB-020	14 to 20	SC-E05	25	BZ0LRE22AA	BZ0BPVE22A
5.5	22	11	22	BM3RHB-025	19 to 25	SC-E1	32	BZ0LRE32AA	BZ0BPVE32A
				BM3VHB-025				BZ0LVE51AA	BZ0BPVE51A
7.5	29	15	30	BM3RHB-032	24 to 32	SC-E1	32	BZ0LRE32AA	BZ0BPVE32A
				BM3VHB-032				BZ0LVE51AA	BZ0BPVE51A
11	40	18.5	37	BM3VHB-040	28 to 40	SC-E2	40	BZ0LVE51AA	BZ0BPVE51A

Notes: • The full-load current of each three-phase motor is a reference value.
Check the actual full-load current of the motor before use.

• The above table shows combinations with AC operated type magnetic contactors.
The link module will differ if the magnetic contactor is a DC operated type.

*1 Use the base plate type in () when you use the base plate.

DUO series Combination Starters

Protective coordination

■ Protective coordination between MMSs and contactors/combination starters (ring terminal connection type)

• IEC 60947-4-1 Type 1 The rated conditional short-circuit current $I_q=50\text{kA}/240\text{V AC}$, 415V AC

Motor capacity and full load current 3-phase				Manual motor starter (ring terminal connection type)		Magnetic contactor (ring terminal connection type)		Link module (ring terminal connection type)	Base plate
200–240V AC		380–415V AC		Type	Adjustable current range (A)	Type	Rated operational current AC-3 (A)	Type	
Capacity (kW)	Current (A)	Capacity (kW)	Current (A)						
0.03	0.24	0.06	0.23	BM3RSR-P25 BM3RHR-P25	0.16 to 0.25	SC-M01 SC-E02P	6 9	BZ0LRC09AA BZ0LRE22AA	*1 (BZ0BPPE22A) BZ0BPPE22A *3
0.06	0.37	0.09	0.32	BM3RSR-P40 BM3RHR-P40	0.25 to 0.4	SC-M01 SC-E02P	6 9	BZ0LRC09AA BZ0LRE22AA	*1 (BZ0BPPE22A) BZ0BPPE22A *3
–	–	0.12	0.5	BM3RSR-P63 BM3RHR-P63	0.4 to 0.63	SC-M01 SC-E02P	6 9	BZ0LRC09AA BZ0LRE22AA	*1 (BZ0BPPE22A) BZ0BPPE22A *3
0.1	0.68	0.18	0.65	BM3RSR-001 BM3RHR-001	0.63 to 1.0	SC-M01 SC-E02P	6 9	BZ0LRC09AA BZ0LRE22AA	*1 (BZ0BPPE22A) BZ0BPPE22A *3
–	–	0.25	0.9	BM3RSR-001 BM3RHR-001	0.63 to 1.0	SC-M01 SC-E02P	6 9	BZ0LRC09AA BZ0LRE22AA	*1 (BZ0BPPE22A) BZ0BPPE22A *3
0.2	1.3	0.37	1.25	BM3RSR-1P6 BM3RHR-1P6	1.0 to 1.6	SC-M01 SC-E02P	6 9	BZ0LRC09AA BZ0LRE22AA	*1 (BZ0BPPE22A) BZ0BPPE22A *3
–	–	0.55	1.5	BM3RSR-2P5 BM3RHR-2P5	1.0 to 1.6	SC-M01 SC-E02P	6 9	BZ0LRC09AA BZ0LRE22AA	*1 (BZ0BPPE22A) BZ0BPPE22A *3
0.4	2.3	0.75	2	BM3RSR-2P5 BM3RHR-2P5	1.6 to 2.5	SC-M01 SC-E02P	6 9	BZ0LRC09AA BZ0LRE22AA	*1 (BZ0BPPE22A) BZ0BPPE22A *3
–	–	1.1	2.5	BM3RSR-004 BM3RHR-004	2.5 to 4.0	SC-M01 SC-E02P	6 9	BZ0LRC09AA BZ0LRE22AA	*1 (BZ0BPPE22A) BZ0BPPE22A *3
0.75	3.6	1.5	3.5	BM3RSR-004 BM3RHR-004	2.5 to 4.0	SC-M01 SC-E02P	6 9	BZ0LRC09AA BZ0LRE22AA	*1 (BZ0BPPE22A) BZ0BPPE22A *3
–	–	2.2	5	BM3RSR-6P3 BM3RHR-6P3	4.0 to 6.3	SC-M01 SC-E02P	6 9	BZ0LRC09AA BZ0LRE22AA	*1 (BZ0BPPE22A) BZ0BPPE22A *3
1.5	6.1	3	6.5	BM3RSR-010 BM3RHR-010	6.3 to 10	SC-M02 SC-E02P	9 9	BZ0LRC09AA BZ0LRE22AA	*1 (BZ0BPPE22A) BZ0BPPE22A *3
2.2	9	4	9	BM3RSR-010 BM3RHR-010	6.3 to 10	SC-M02 SC-E02P	9 9	BZ0LRC09AA BZ0LRE22AA	*1 (BZ0BPPE22A) BZ0BPPE22A *3
3	12	5.5	12	BM3RSR-013 BM3RHR-013	9 to 13	SC-E03P	12	BZ0LRE22AA	(BZ0BPPE22A) *3
4	16	7.5	16	BM3RHR-020	14 to 20	SC-E04P	18	BZ0LRE22AA	(BZ0BPPE22A) *3
5.5	22	11	22	BM3RHR-025	19 to 25	SC-E05P	25	BZ0LRE22AA	(BZ0BPPE22A) *3
7.5	29	15	30	BM3RHR-032	24 to 32	SC-E1P	32	*2	(BZ0BPPE32A) *3

Notes: • The full-load current of each three-phase motor is a reference value. Check the actual full-load current of the motor before use.

• The above table shows combinations with AC operated type magnetic contactors. The link module will differ if the magnetic contactor is a DC operated type.

*1 Use the base plate type in () when you use the base plate.

*2 Use electric wire.

*3 If you do not use the base plate, use two mounting rails.

• IEC 60947-4-1 Type 2 The rated conditional short-circuit current I_q=50kA/240V AC, 415V AC

Motor capacity and full load current 3-phase				Manual motor starter (ring terminal connection type)		Magnetic contactor (ring terminal connection type)		Link module (ring terminal connection type)	Base plate
200–240V AC		380–415V AC		Type	Adjustable current range (A)	Type	Rated operational current AC-3 (A)	Type	
Capacity (kW)	Current (A)	Capacity (kW)	Current (A)						
0.03	0.24	0.06	0.23	BM3RSR-P25	0.16 to 0.25	SC-M01	6	BZ0LRC09AA	*1 (BZ0BPRES22A)
				BM3RHR-P25		SC-E02P		BZ0LRE22AA	BZ0BPRES22A *3
0.06	0.37	0.09	0.32	BM3RSR-P40	0.25 to 0.4	SC-M01	6	BZ0LRC09AA	*1 (BZ0BPRES22A)
				BM3RHR-P40		SC-E02P		BZ0LRE22AA	BZ0BPRES22A *3
–	–	0.12	0.5	BM3RSR-P63	0.4 to 0.63	SC-M01	6	BZ0LRC09AA	*1 (BZ0BPRES22A)
				BM3RHR-P63		SC-E02P		BZ0LRE22AA	BZ0BPRES22A *3
0.12	0.68	0.18	0.65	BM3RSR-001	0.63 to 1.0	SC-M01	6	BZ0LRC09AA	*1 (BZ0BPRES22A)
				BM3RHR-001		SC-E02P		BZ0LRE22AA	BZ0BPRES22A *3
–	–	0.25	0.9	BM3RSR-001	0.63 to 1.0	SC-M01	6	BZ0LRC09AA	*1 (BZ0BPRES22A)
				BM3RHR-001		SC-E02P		BZ0LRE22AA	BZ0BPRES22A *3
0.2	1.3	0.37	1.25	BM3RSR-1P6	1.0 to 1.6	SC-M01	6	BZ0LRC09AA	*1 (BZ0BPRES22A)
				BM3RHR-1P6		SC-E02P		BZ0LRE22AA	BZ0BPRES22A *3
–	–	0.55	1.6	BM3RSR-2P5	1.0 to 1.6	SC-M01	6	BZ0LRC09AA	*1 (BZ0BPRES22A)
				BM3RHR-2P5		SC-E02P		BZ0LRE22AA	BZ0BPRES22A *3
0.4	2.3	0.75	2	BM3RSR-2P5	1.6 to 2.5	SC-M01	6	BZ0LRC09AA	*1 (BZ0BPRES22A)
				BM3RHR-2P5		SC-E02P		BZ0LRE22AA	BZ0BPRES22A *3
–	–	1.1	2.5	BM3RSR-004	2.5 to 4.0	SC-M01	6	BZ0LRC09AA	*1 (BZ0BPRES22A)
				BM3RHR-004		SC-E02P		BZ0LRE22AA	BZ0BPRES22A *3
0.75	3.6	1.5	3.5	BM3RSR-004	2.5 to 4.0	SC-E03P	12	BZ0LRE22AA	(BZ0BPRES22A) *3
				BM3RHR-004					
–	–	2.2	5	BM3RSR-6P3	4.0 to 6.3	SC-E04P	18	BZ0LRE22AA	(BZ0BPRES22A) *3
				BM3RHR-6P3					
1.5	6.1	3	6.5	BM3RSR-010	6.3 to 10	SC-E04P	18	BZ0LRE22AA	(BZ0BPRES22A) *3
				BM3RHR-010					
2.2	9	4	9	BM3RSR-010	6.3 to 10	SC-E04P	18	BZ0LRE22AA	(BZ0BPRES22A) *3
				BM3RHR-010					
3	12	5.5	12	BM3RSR-013	9 to 13	SC-E05P	25	BZ0LRE22AA	(BZ0BPRES22A) *3
				BM3RHR-013					
4	16	7.5	16	BM3RHR-020	14 to 20	SC-E05P	25	BZ0LRE22AA	(BZ0BPRES22A) *3
5.5	22	11	22	BM3RHR-025	19 to 25	SC-E1P	32	*2	(BZ0BPRES32A)
7.5	29	15	30	BM3RHR-032	24 to 32	SC-E1P	32	*2	(BZ0BPRES32A)

Notes: • The full-load current of each three-phase motor is a reference value. Check the actual full-load current of the motor before use.

• The above table shows combinations with AC operated type magnetic contactors. The link module will differ if the magnetic contactor is a DC operated type.

*1 Use the base plate type in () when you use the base plate.

*2 Use electric wire.

*3 If you do not use the base plate, use two mounting rails.

DUO series Combination Starters

Combinations meeting for UL market

■ Combinations meeting for UL market

• BM3RSB, BM3RHB, BM3RSR, BM3RHR

3-phase motor				Manual motor starters		Adjustable current range (A)	Magnetic contactor	Link module	Base plate
Rated capacity (HP) 220–240V AC	Rated operational current (A)	Rated capacity (HP) 440–480V AC	Rated operational current (A)						
–	–	–	–	BM3RSB-P16	BM3RHB-P16	0.1 to 0.16	SC-M01	BZ0LRC09AA	*1 (BZ0BPVE22A)
							SC-E02	BZ0LRE22AA	BZ0BPVE22A
–	–	–	–	BM3RSB-P25	BM3RHB-P25	0.16 to 0.25	SC-M01	BZ0LRC09AA	*1 (BZ0BPVE22A)
							SC-E02	BZ0LRE22AA	BZ0BPVE22A
–	–	–	–	BM3RSB-P40	BM3RHB-P40	0.25 to 0.4	SC-M01	BZ0LRC09AA	*1 (BZ0BPVE22A)
							SC-E02	BZ0LRE22AA	BZ0BPVE22A
–	–	–	–	BM3RSB-P63	BM3RHB-P63	0.4 to 0.63	SC-M01	BZ0LRC09AA	*1 (BZ0BPVE22A)
							SC-E02	BZ0LRE22AA	BZ0BPVE22A
–	–	–	–	BM3RSB-001	BM3RHB-001	0.63 to 1.0	SC-M01	BZ0LRC09AA	*1 (BZ0BPVE22A)
							SC-E02	BZ0LRE22AA	BZ0BPVE22A
–	–	0.75	1.6	BM3RSB-1P6	BM3RHB-1P6	1.0 to 1.6	SC-M01	BZ0LRC09AA	*1 (BZ0BPVE22A)
							SC-E02	BZ0LRE22AA	BZ0BPVE22A
0.5	2.2	1	2.1	BM3RSB-2P5	BM3RHB-2P5	1.6 to 2.5	SC-M01	BZ0LRC09AA	*1 (BZ0BPVE22A)
							SC-E02	BZ0LRE22AA	BZ0BPVE22A
0.75	3.2	2	3.4	BM3RSB-004	BM3RHB-004	2.5 to 4	SC-M01	BZ0LRC09AA	*1 (BZ0BPVE22A)
							SC-E02	BZ0LRE22AA	BZ0BPVE22A
1.5	6	3	4.8	BM3RSB-6P3	BM3RHB-6P3	4 to 6.3	SC-M01	BZ0LRC09AA	*1 (BZ0BPVE22A)
							SC-E02	BZ0LRE22AA	BZ0BPVE22A
–	–	5	7.6	BM3RSB-010	BM3RHB-010	6.3 to 10	SC-M02	BZ0LRC09AA	*1 (BZ0BPVE22A)
							SC-E02	BZ0LRE22AA	BZ0BPVE22A
3	9.6	7.5	11	BM3RSB-013	BM3RHB-013	9 to 13	SC-E03	BZ0LRE22AA	BZ0BPVE22A
5	15.2	10	14	BM3RSB-016	BM3RHB-016	11 to 16	SC-E04	BZ0LRE22AA	BZ0BPVE22A
5	15.2	10	14	BM3RSB-020	BM3RHB-020	14 to 20	SC-E04	BZ0LRE22AA	BZ0BPVE22A
7.5	22	15	21	BM3RSB-025	BM3RHB-025	19 to 25	SC-E05	BZ0LRE22AA	BZ0BPVE22A
10	28	20	27	BM3RSB-032	BM3RHB-032	24 to 32	SC-E1	BZ0LRE32AA	BZ0BPVE32A

Note: *1 Use the base plate type in () when you use the base plate.

• BM3VSB, BM3VHB

3-phase motor				Manual motor starters		Adjustable current range (A)	Magnetic contactor	Link module	Base plate
Rated capacity (HP) 220–240V AC	Rated operational current (A)	Rated capacity (HP) 440–480V AC	Rated operational current (A)						
3	9.6	5	7.6	BM3VSB-010	BM3VHB-010	6.3 to 10	SC-E1	BZ0LVE51AA	BZ0BPVE51A
3	9.6	7.5	11	BM3VSB-013	BM3VHB-013	9 to 13	SC-E1	BZ0LVE51AA	BZ0BPVE51A
5	15.2	10	14	BM3VSB-016	BM3VHB-016	11 to 16	SC-E1	BZ0LVE51AA	BZ0BPVE51A
5	15.2	10	14	BM3VSB-020	BM3VHB-020	14 to 20	SC-E1	BZ0LVE51AA	BZ0BPVE51A
7.5	22	15	21	BM3VSB-025	BM3VHB-025	19 to 25	SC-E1	BZ0LVE51AA	BZ0BPVE51A
10	28	20	27	BM3VSB-032	BM3VHB-032	24 to 32	SC-E1	BZ0LVE51AA	BZ0BPVE51A
10	28	30	40	BM3VSB-040	BM3VHB-040	28 to 40	SC-E2	BZ0LVE51AA	BZ0BPVE51A
15	42	30	40	BM3VSB-050	BM3VHB-050	35 to 50	SC-E2S	BZ0LVE51AA	BZ0BPVE51A
20	54	40	52	BM3VSB-063	BM3VHB-063	45 to 63	SC-E3	BZ0LVE65AA	BZ0BPVE65A

■ Optional accessories

• Link modules

Description	Applicable MMS	Applicable magnetic contactor	Operating coil	Type	Mass (g)
 <p>The link module connects the manual motor starter and magnetic contactor electrically and mechanically.</p> <p>(No.KK01-153)</p>	BM3RSB BM3RHB	SC-M01, M02	AC	BZ0LRC09AA	25
		SC-M01/G, M02/G	DC		
		SC-E02, E03, E04, E05	AC	BZ0LRE22AA	25
		SC-E02/G, E03/G, E04/G, E05/G	DC		
		SC-E1	AC	BZ0LRE32AA	45
		SC-E1/G	DC		
	BM3RSR BM3RHR	SC-M01, M02	AC	BZ0LRC09AA	25
		SC-M01/G, M02/G	DC		
		SC-E02P, E03P, E04P, E05P	AC	BZ0LRE22AA	25
		SC-E02P/G, E03P/G, E04P/G, E05P/G	DC		
	BM3V	SC-E1, E2, E2S	AC	BZ0LVE51AA	45
		SC-E1/G, E2/G, E2S/G	DC		
SC-E3		AC	BZ0LVE65AA	65	
SC-E3/G		DC			

• Base plates

Description	Applicable MMS	Applicable magnetic contactor	Operating coil	Type	Mass (g)
 <p>The base plate is a plastic plate to which the combination starter is mounted. The base plate can then be mounted to a panel with screws or to a IEC top hat rail.</p> <p>(No.KK01-155)</p>	BM3RSB BM3RHB	SC-M01, M02	AC	(BZ0BPRE22A)	100
		SC-M01/G, M02/G	DC		
		SC-E02, E03, E04, E05	AC	BZ0BPRE22A	100
		SC-E02/G, E03/G, E04/G, E05/G	DC		
		SC-E1	AC	BZ0BPRE32A	160
		SC-E1/G	DC		
	BM3RSR BM3RHR	SC-M01, M02	AC	(BZ0BPRE22A)	100
		SC-M01/G, M02/G	DC		
		SC-E02P, E03P, E04P, E05P	AC	(BZ0BPRE22A)	100
		SC-E02P/G, E03P/G, E04P/G, E05P/G	DC		
		SC-E1P	AC	BZ0BPRE32A	160
		SC-E1P/G	DC		
	BM3V	SC-E1, E2, E2S	AC	BZ0BPVE51A	160
		SC-E1/G, E2/G, E2S/G	DC		
		SC-E3	AC	BZ0BPVE65A	195
		SC-E3/G	DC		

• Base plate coupling kit

Description	Applicable base plate	Type	Mass(g)
 <p>The base plate coupling kit is used to couple two base plates that are mounted with combination starters consisting of manual motor starters and SC-E□RM reversing magnetic contactors.</p> <p>(No.KK03-036)</p>	BZ0BPRE22A BZ0BPRE32A BZ0BPVE51A BZ0BPVE65A	BZ0BPCA	4

■ Combination starter configurations

• BM3RSB+SC-M01, M02

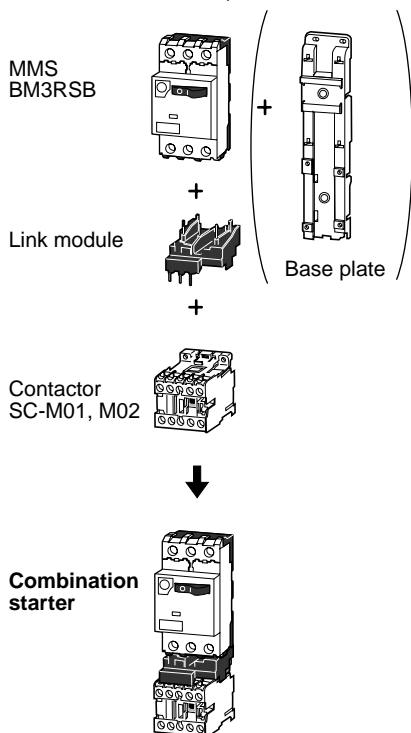

• BM3RSB+SC-E02 to E05

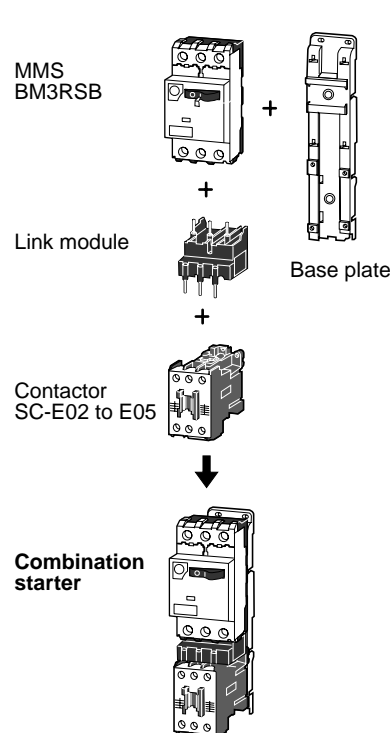

• BM3RHB+SC-E04, E05

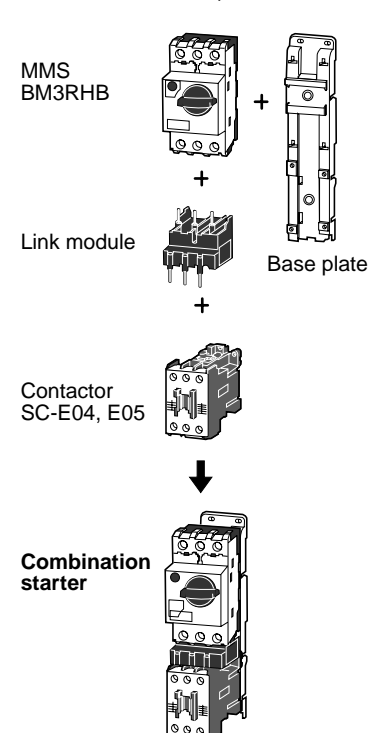

DUO series Combination Starters Configuration

• BM3RHB+SC-E1

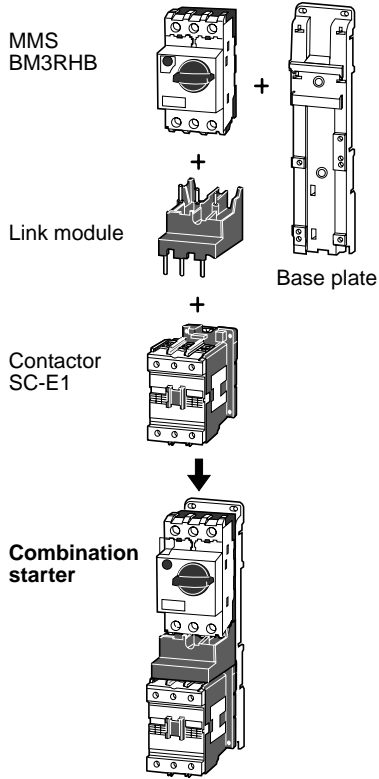

• BM3V□B+SC-E1 to E2S

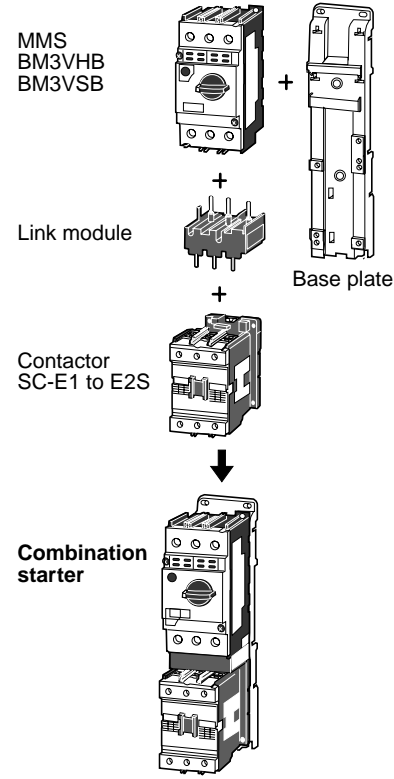

• BM3V□B+SC-E3

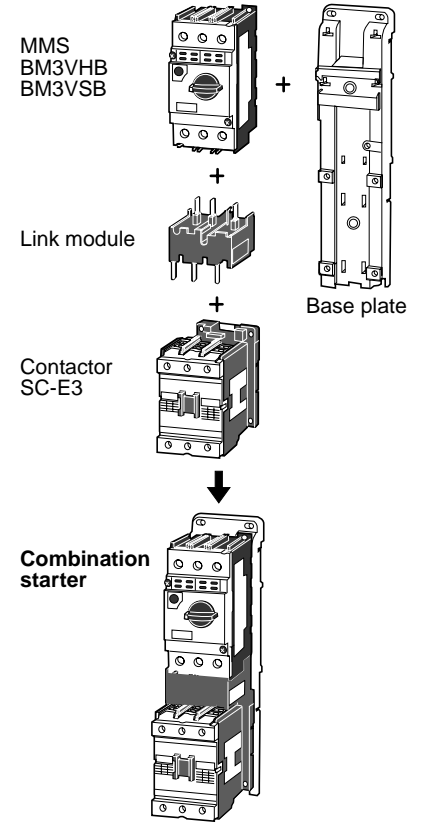

• BM3RH□+SC-M01, M02

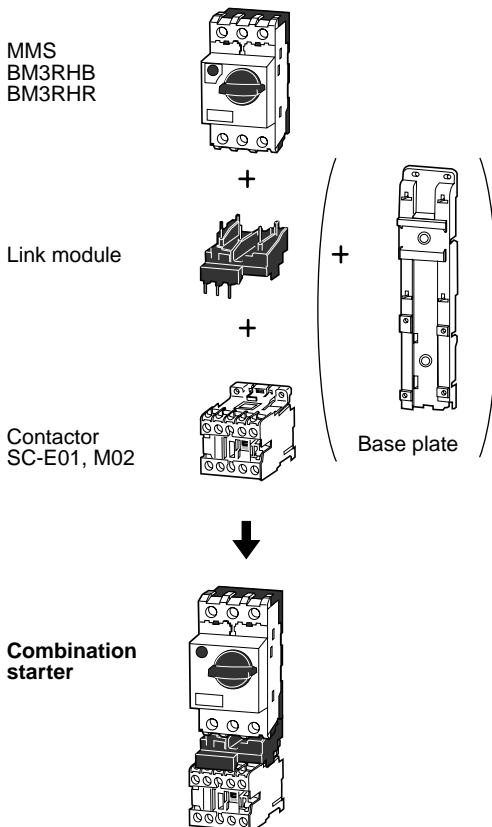

• BM3R□+SC-E0□P

(When two mounting rails are used)

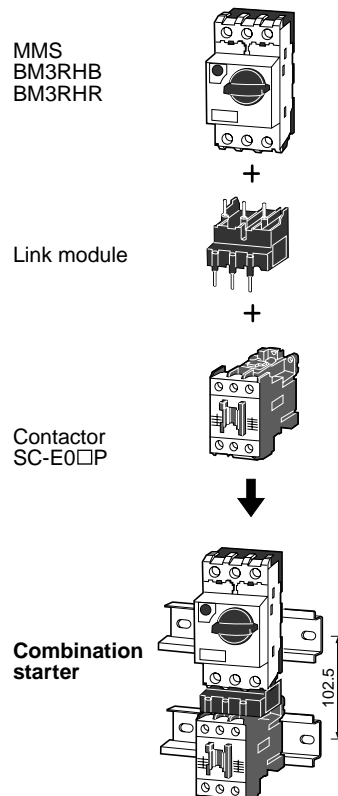

■ **Note to mount an MMS and contactor**

When the manual motor starter and magnetic contactor are configured as a combination starter, the nameplate ends up facing the wrong direction because the coil terminal of the magnetic contactor faces downward. Use the following procedure to turn the nameplate upside down.

For SC-E02 to SC-E05 magnetic contactors

- Insert a flat-blade screwdriver between the center pole of arc-chamber (S phase or V phase) and the terminal screw, and lift the arc-chamber to remove it.
- After removing the arc-chamber, turn it 180 degrees (top to bottom), then re-mount it onto the magnetic contactor.
- Align the arc-chamber with the top and bottom terminals and press it on firmly by hand.

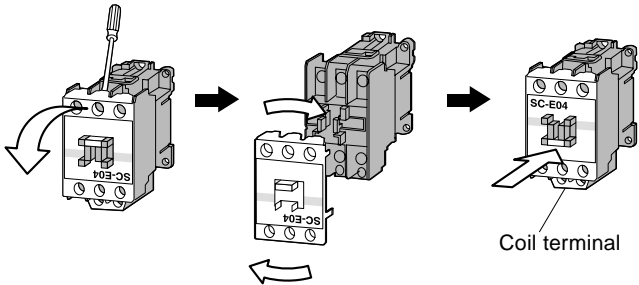

For SC-E1 to SC-E3 magnetic contactors

- Use a Phillips screwdriver to remove the two screws securing the front and back bodies.
- Remove the front body and turn it 180 degrees (top to bottom), then re-mount it with the screws.
- Make sure that no foreign matter enters the interior of the magnetic contactor during this removal/re-mounting procedure.

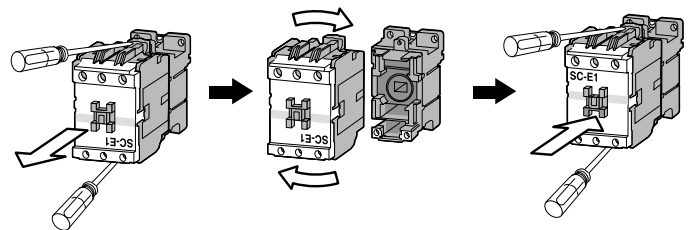

DUO series Combination Starters

Dimensions

■ Dimensions, mm

• Base plates

BZ0BPVE22A

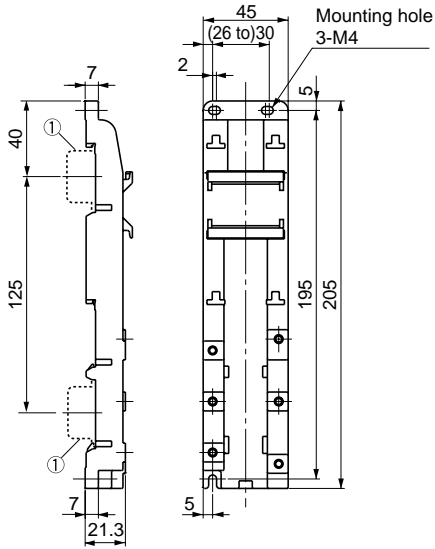

① 35mm wide rail (height 15mm) x 2

Base plate type	Applicable type	
	MMS	Contactor
BZ0BPVE22A	BM3RSB	SC-E02, E03, E04, E05
	BM3RHB	E02/G, E03/G, E04/G, E05/G

BZ0BPVE32A

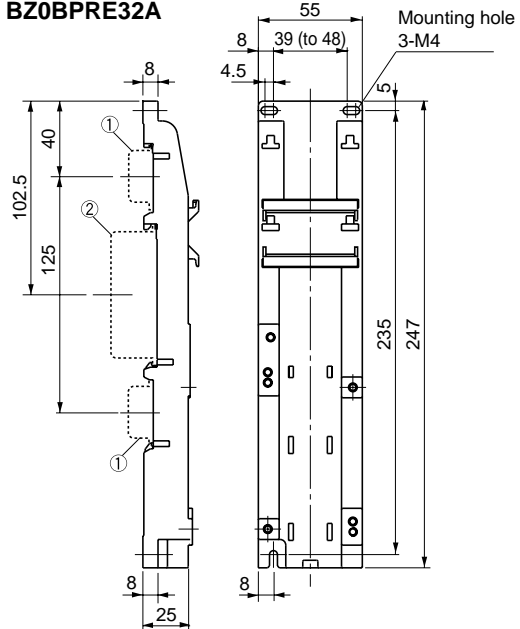

① 35mm wide rail (height 15mm) x 2
② 75mm wide rail (height 25mm) x 1

Base plate type	Applicable type	
	MMS	Contactor
BZ0BPVE32A	BM3RSB	SC-E1, E1/G
	BM3RHB	

BZ0BPVE51A

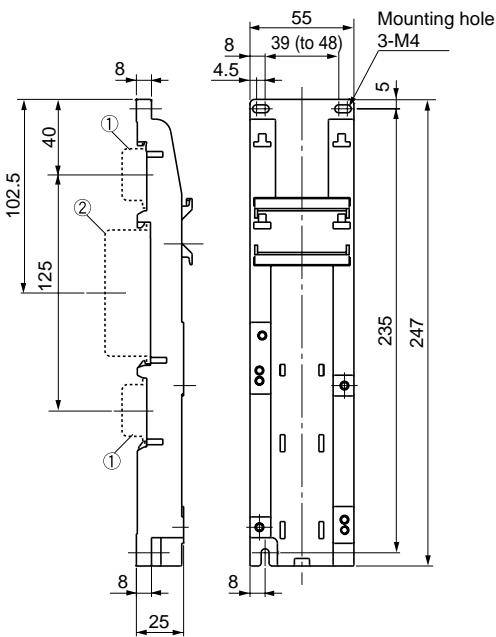

① 35mm wide rail (height 15mm) x 2
② 75mm wide rail (height 25mm) x 1

Base plate type	Applicable type	
	MMS	Contactor
BZ0BPVE51A	BM3VSB	SC-E1, E2, E2S,
	BM3VHB	E1/G, E2/G, E2S/G

BZ0BPVE65A

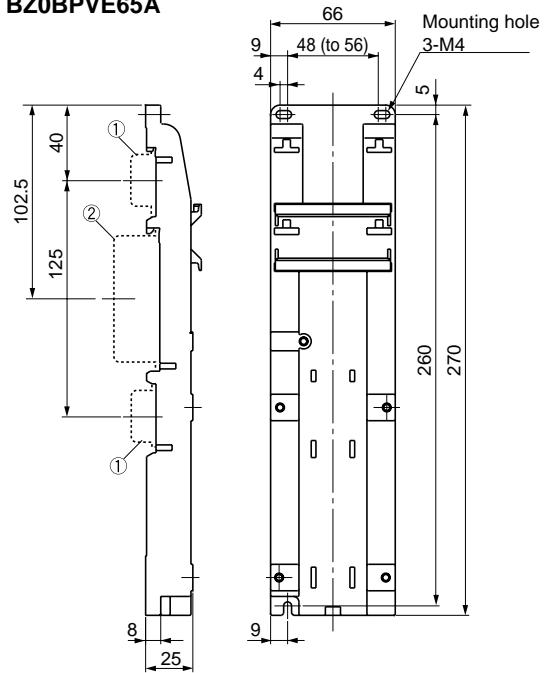

① 35mm wide rail (height 15mm) x 2
② 75mm wide rail (height 25mm) x 1

Base plate type	Applicable type	
	MMS	Contactor
BZ0BPVE65A	BM3VSB	SC-E3, E3/G
	BM3VHB	

■ Dimensions, mm

• Combination

BM3RS□ + SC-M01, M02

+ SC-M01/G, M01/G1, M01/G2

+ SC-M02/G, M02/G1, M02/G2

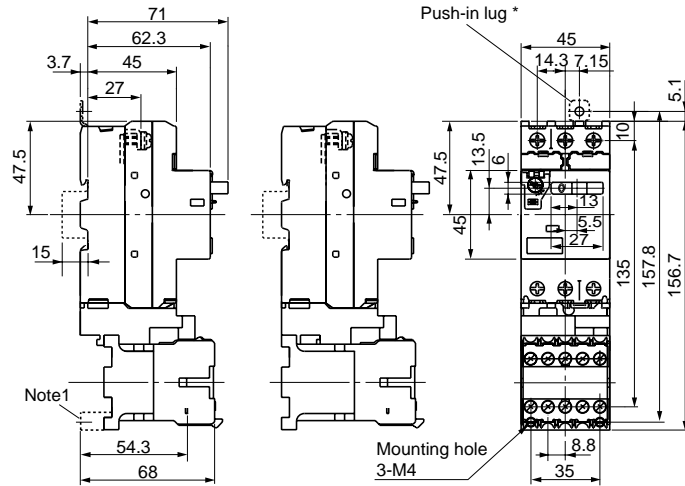

MMS	Contactors	Link module	Mass(g)
BM3RSB	SC-M01, M02	BZ0LRC09AA	540
BM3RSR	SC-M01/G, M01/G1, M01/G2 SC-M02/G, M02/G1, M02/G2	BZ0LRC09AA	600

Note1: * Dimensions for mounting of an optional push-in lug/BZ0SET and 2-spacer supplied with link module/BZ0LRC09AA, when screw-mounting BM3RSB with SC-M01 or SC-M02.

BM3RH□ + SC-M01, M02

+ SC-M01/G, M01/G1, M01/G2

+ SC-M02/G, M02/G1, M02/G2

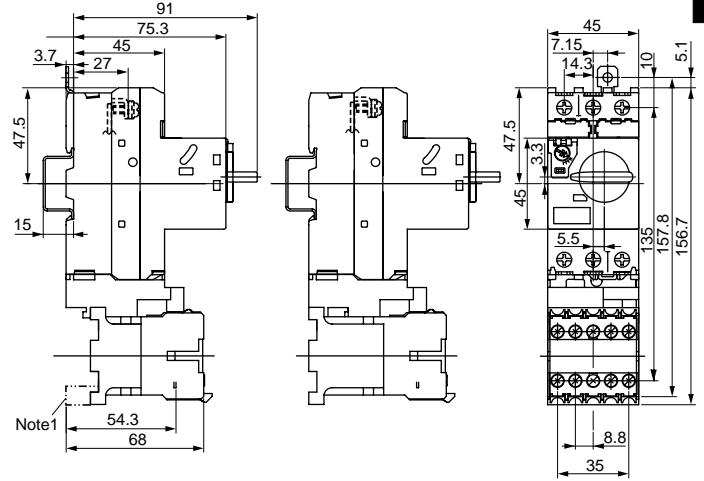

MMS	Contactors	Link module	Mass(g)
BM3RHB	SC-M01, M02	BZ0LRC09AA	560
BM3RHR	SC-M01/G, M01/G1, M01/G2 SC-M02/G, M02/G1, M02/G2	BZ0LRC09AA	620

①35mm wide rail (height 15mm) x 1

BM3RS□ + SC-M01, M02

+ SC-M01/G, M01/G1, M01/G2

+ SC-M02/G, M02/G1, M02/G2

+ (Base plate BZ0BP22A)

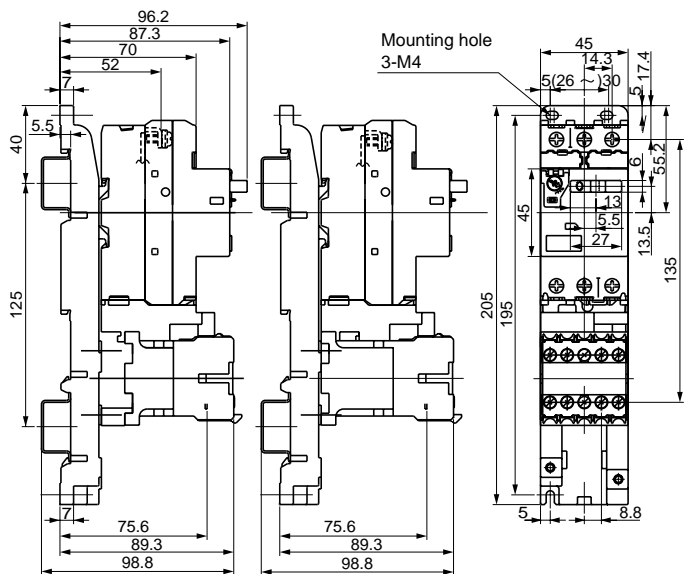

MMS	Contactors	Link module	Base plate	Mass(g)
BM3RSB	SC-M01, M02	BZ0LRC09AA	BZ0BP22A	640
	SC-M01/G, M01/G1, M01/G2 SC-M02/G, M02/G1, M02/G2			700

①35mm wide rail (height 15mm) x 2

BM3RH□ + SC-M01, M02

+ SC-M01/G, M01/G1, M01/G2

+ SC-M02/G, M02/G1, M02/G2

+ (Base plate BZ0BP22A)

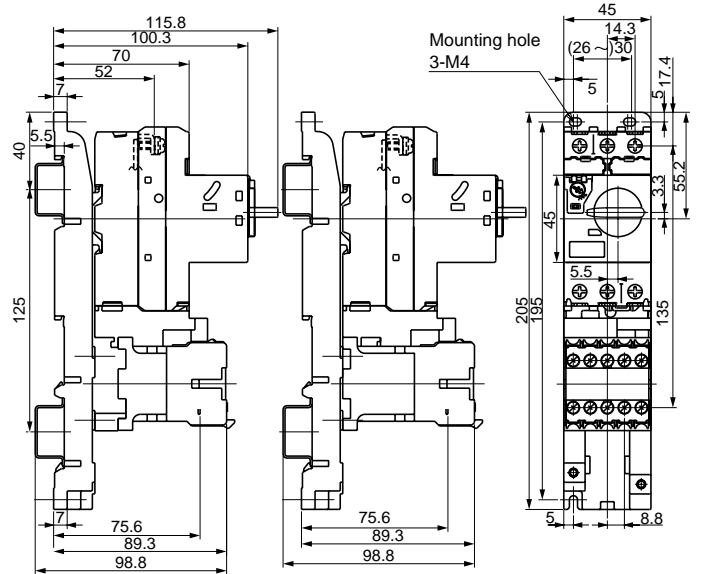

MMS	Contactors	Link module	Base plate	Mass(g)
BM3RHB	SC-M01, M02	BZ0LRC09AA	BZ0BP22A	660
	SC-M01/G, M01/G1, M01/G2 SC-M02/G, M02/G1, M02/G2			720

①35mm wide rail (height 15mm) x 2

DUO series Combination Starters

Dimensions

■ Dimensions, mm

• Combination

BM3RS□ + SC-E02 to E05

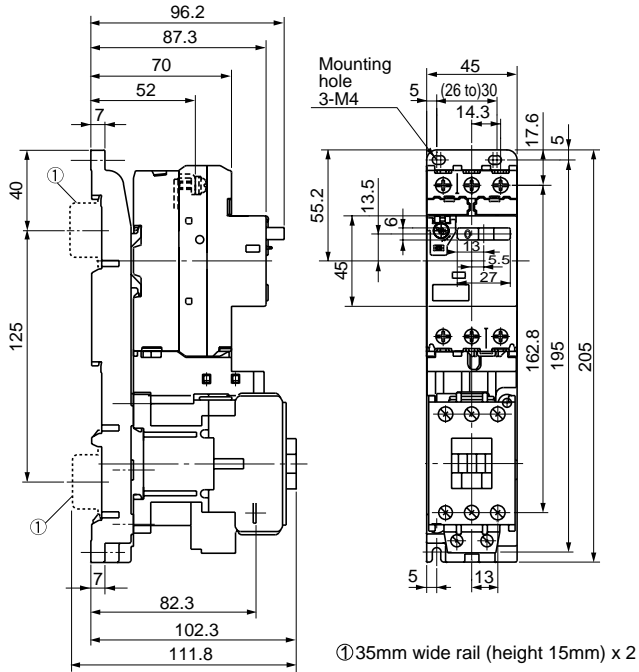

BM3RS□ + SC-E02/G to E05/G

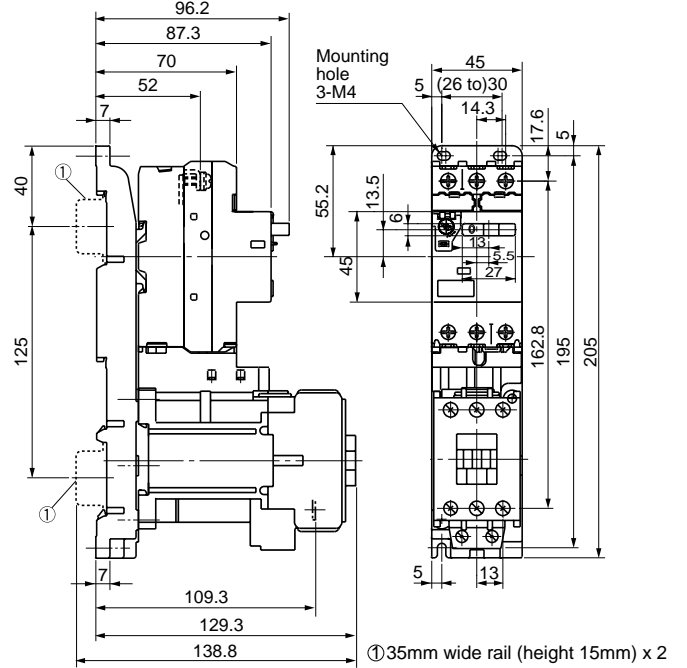

MMS	Contactors	Link module	Base plate	Mass (g)
BM3RSB	SC-E02, E03, E04, E05	BZ0LRE22AA	BZ0BPPE22A	820
BM3RSR				

MMS	Contactors	Link module	Base plate	Mass (g)
BM3RSB	SC-E02/G, E03/G, E04/G, E05/G	BZ0LRE22GA	BZ0BPPE22A	1,065
BM3RSR				

BM3RS□ + SC-E1

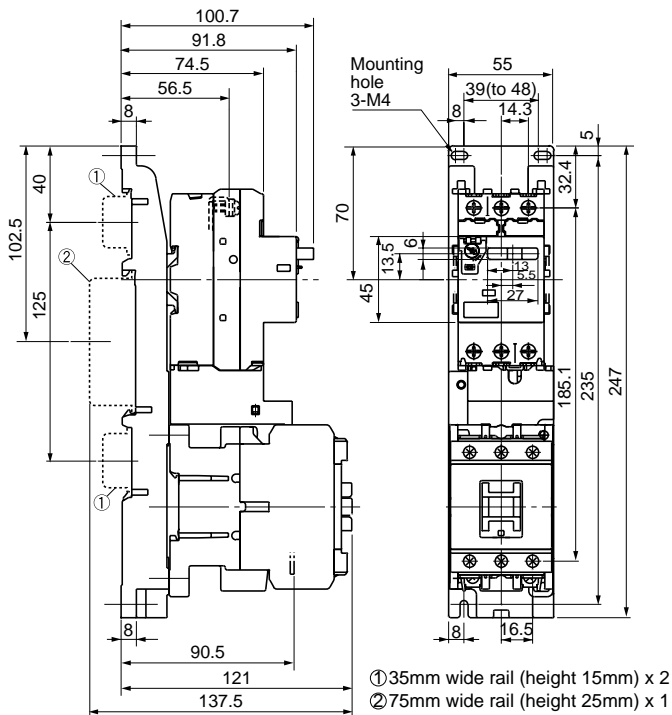

BM3RS□ + SC-E1/G

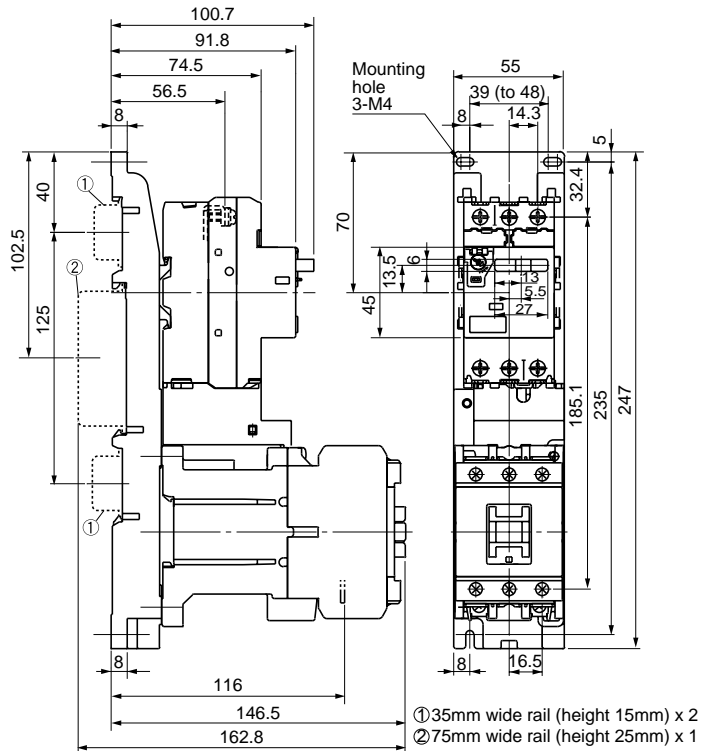

MMS	Contactors	Link module	Base plate	Mass (g)
BM3RSB	SC-E1	BZ0LRE32AA	BZ0BPPE32A	1,135
BM3RSR				

MMS	Contactors	Link module	Base plate	Mass (g)
BM3RSB	SC-E1/G	BZ0LRE32GA	BZ0BPPE32A	1,360
BM3RSR				

■ Dimensions, mm
• Combination
BM3RH□ + SC-E02 to E05

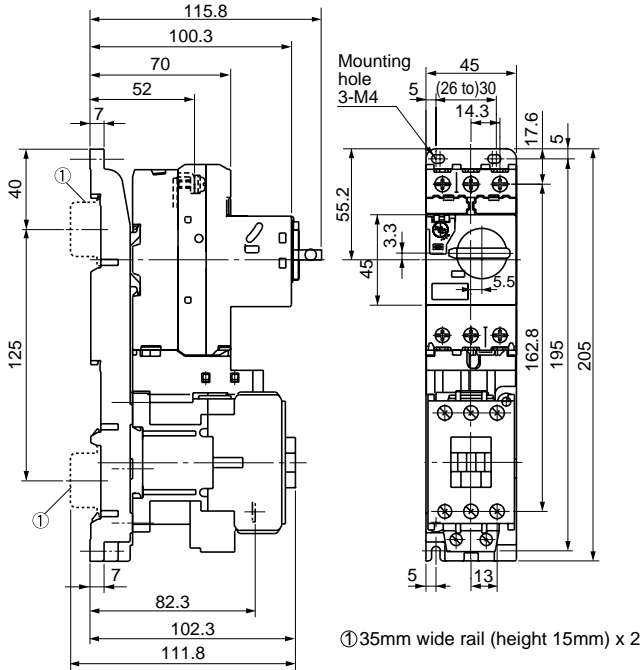

MMS	Contactors	Link module	Base plate	Mass (g)
BM3RHB	SC-E02, E03, E04, E05	BZ0LRE22AA	BZ0BPPE22A	840
BM3RHR				

BM3RH□ + SC-E02/G to E05/G

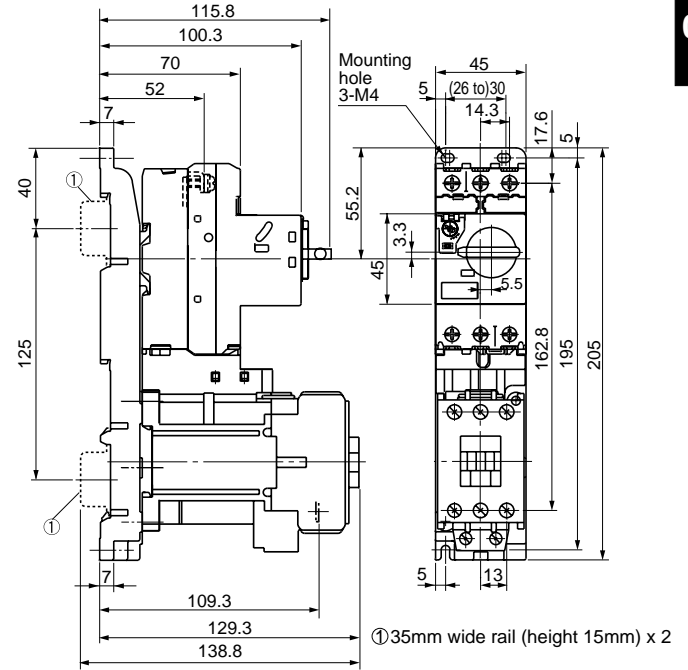

MMS	Contactors	Link module	Base plate	Mass (g)
BM3RHB	SC-E02/G, E03/G, E04/G, E05/G	BZ0LRE22GA	BZ0BPPE22A	1,085
BM3RHR				

BM3RH□ + SC-E1

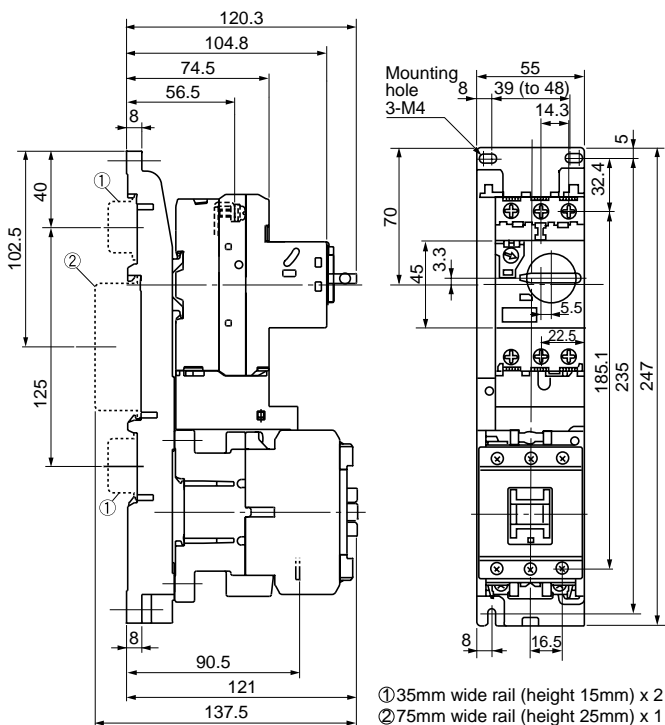

MMS	Contactors	Link module	Base plate	Mass (g)
BM3RHB	SC-E1	BZ0LRE32AA	BZ0BPPE32A	1,155
BM3RHR				

BM3RH□ + SC-E1/G

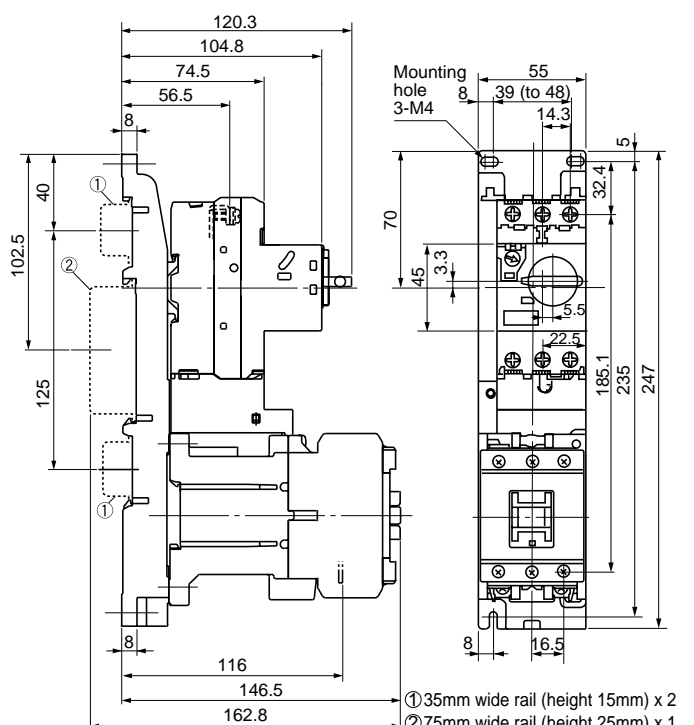

MMS	Contactors	Link module	Base plate	Mass (g)
BM3RHB	SC-E1/G	BZ0LRE32GA	BZ0BPPE32A	1,380
BM3RHR				

DUO series Combination Starters

Dimensions

■ Dimensions, mm

• Combination

BM3V□B + SC-E1, E2, E3

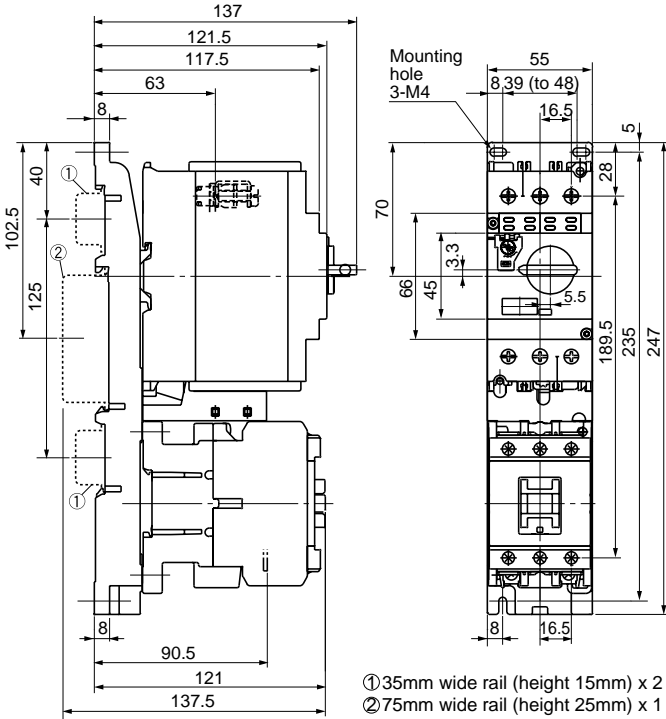

MMS	Contactors	Link module	Base plate	Mass (g)
BM3VSB	SC-E1, E2, E2S	BZ0LVE51AA	BZ0BPVE51A	1,580
BM3VHB				

BM3V□B + SC-E1/G, E2/G, E2S/G

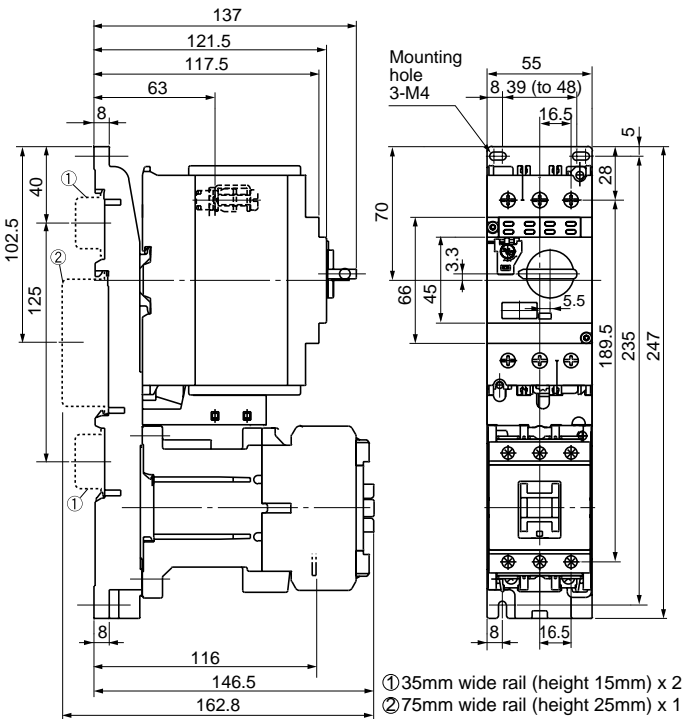

MMS	Contactors	Link module	Base plate	Mass (g)
BM3VSB	SC-E1/G, E2/G, E2S/G	BZ0LVE51GA	BZ0BPVE51A	1,810
BM3VHB				

BM3V□B + SC-E3

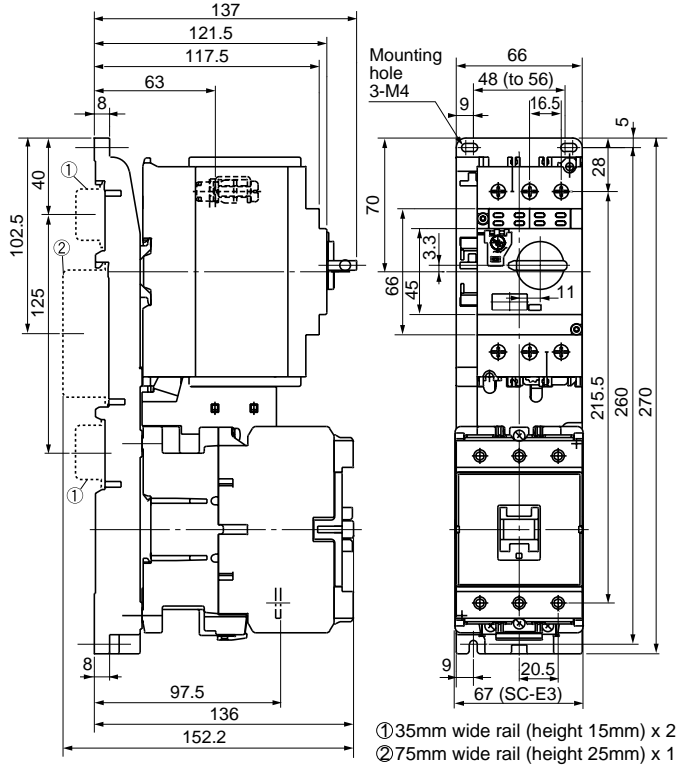

MMS	Contactors	Link module	Base plate	Mass (g)
BM3VSB	SC-E3	BZ0LVE65AA	BZ0BPVE65A	2,080
BM3VHB				

BM3V□B + SC-E3/G

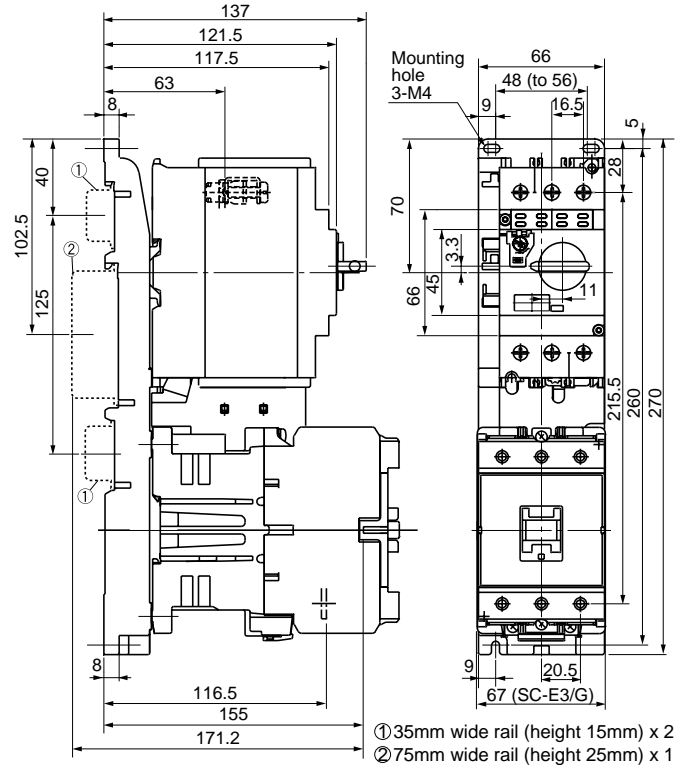

MMS	Contactors	Link module	Base plate	Mass (g)
BM3VSB	SC-E3/G	BZ0LVE65GA	BZ0BPVE65A	2,400
BM3VHB				

■ CCC approved
 • Manual motor starters

Frame	Standard breaking capacity	High breaking capacity		Certificate No.
	Adjustable thermal-magnetic trip type	Adjustable thermal-magnetic trip type	Instantaneous trip type	
32A	BM3RSB	–	–	2003010307076338
	–	BM3RHB	BM3RHBK	2003010307076342
63A	BM3VSB	BM3VHB	BM3VHBK	2003010307076333

Catalog Disclaimer

The information contained in this catalog does not constitute an express or implied warranty of quality, any warranty of merchantability or fitness for a particular purpose is hereby disclaimed.

Since the user's product information, specific use application, and conditions of use are all outside of Fuji Electric FA Components & Systems' control, **it shall be the responsibility of the user to determine the suitability of any of the products mentioned for the user's application.**

One Year Limited Warranty

The products identified in this catalog shall be sold pursuant to the terms and conditions identified in the "Conditions of Sale" issued by Fuji Electric FA with each order confirmation.

Except to the extent otherwise provided for in the Conditions of Sale issued by Fuji Electric FA, Fuji Electric FA warrants that the Fuji Electric FA products identified in this catalog shall be free from significant defects in materials and workmanship provided the product has not been: 1) repaired or altered by others than Fuji Electric FA; 2) subjected to negligence, accident, misuse, or damage by circumstances beyond Fuji Electric FA's control; 3) improperly operated, maintained or stored; or 4) used in other than normal use or service. This warranty shall apply only to defects appearing within one (1) year from the date of shipment by Fuji Electric FA, and in such case, only if such defects are reported to Fuji Electric FA within thirty (30) days of discovery by purchaser. Such notice should be submitted in writing to Fuji Electric FA at 5-7, Nihonbashi Odemma-cho, Chuo-ku, Tokyo, Japan. The sole and exclusive remedy with respect to the above warranty whether such claim is based on warranty, contract, negligence, strict liability or any other theory, is limited to the repair or replacement of such product or, at Fuji Electric FA's option reimbursement by Fuji Electric FA of the purchase price paid to Fuji Electric FA for the particular product. **Fuji Electric FA does not make any other representations or warranties, whether oral or in writing, expressed or implied, including but not limited to any warranty regarding merchantability or fitness for a particular purpose.** Except as provided in the Conditions of Sale, no agent or representative of Fuji Electric FA is authorized to modify the terms of this warranty in writing or orally.

In no event shall Fuji Electric FA be liable for special, indirect or consequential damages, including but not limited to, loss of use of the product, other equipment, plant and power system which is installed with the product, loss of profits or revenues, cost of capital, or claims against the purchaser or user of the product by its customers resulting from the use of information, recommendations and descriptions contained herein. The purchaser agrees to pass on to its customers and users, in writing at the time inquiries and orders are received by buyer, Fuji Electric FA's warranty as set forth above.

Caution "Safety precautions"

- Operate (keep) in the environment specified in the operating instructions and manual. High temperature, high humidity, condensation, dust, corrosive gases, oil, organic solvents, excessive vibration or shock might cause electric shock, fire, erratic operation or failure.
- Follow the regulations of industrial wastes when the product is to be discarded.
- The products covered in this catalog have not been designed or manufactured for use in equipment or systems which, in the event of failure, can lead to loss of human life.
- If you intend to use the products covered in this catalog for special applications, such as for nuclear energy control, aerospace, medical, or transportation, please consult our Fuji Electric FA agent.
- Be sure to provide protective measures when using the product covered in these catalogs in equipment which, in the event of failure, may lead to loss of human life or other grave results.
- Follow the directions of the operating instructions when mounting the product.

D&C CATALOG DIGEST INDEX

Individual catalog No. **LOW VOLTAGE PRODUCTS** Up to 600 Volts

01 Magnetic Contactors and Starters
Thermal Overload Relays, Solid-state Contactors

02 Manual Motor Starters and Contactors
Combination Starters

03 Industrial Relays, Industrial Control Relays
Annunciator Relay Unit, Time Delay Relays

04 Pushbuttons, Selector Switches, Pilot Lights
Rotary Switches, Cam Type Selector Switches
Panel Switches, Terminal Blocks, Testing Terminals

05 Limit Switches, Proximity Switches
Photoelectric Switches

06 Molded Case Circuit Breakers
Air Circuit Breakers

07 Earth Leakage Circuit Breakers
Earth Leakage Protective Relays

08 Circuit Protectors
Low Voltage Current-Limiting Fuses

09 Measuring Instruments, Arresters, Transducers
Power Factor Controllers
Power Monitoring Equipment (F-MPC)

10 AC Power Regulators
Noise Suppression Filters
Control Power Transformers

HIGH VOLTAGE PRODUCTS Up to 36kV

11 Disconnecting Switches, Power Fuses
Air Load Break Switches
Instrument Transformers — VT, CT

12 Vacuum Circuit Breakers, Vacuum Magnetic Contactors
Protective Relays

INDIVIDUAL CATALOG 02

from D&C CATALOG 20th Edition

Fuji Electric FA Components & Systems Co., Ltd.

5-7, Nihonbashi Odemma-cho, Chuo-ku, Tokyo, 103-0011, Japan

URL <http://www.fujielectric.co.jp/fcs/eng>

Information in this catalog is subject to change without notice.