

DISTRIBUTION

Molded Case Circuit Breakers / Earth Leakage Circuit Breakers

G-TWIN λ (Lambda) Series



Evolutionary form of small breaker for machine equipment and control panels!

Molded Case Circuit Breakers / Earth Leakage Circuit Breakers

G-TWIN λ (Lambda) Series

New lines of small and high-performance 32 to 63AF molded case circuit breakers and earth leakage circuit breakers enables downsizing and globalization of machine equipment and control panels!



Along with functional enhancement of machine equipment, the number of electrical circuits in control panels is increasing and downsizing of control panel devices is a common challenge. In addition, globalization of the control panel market is progressing rapidly.

As new products of MCCB/ELCB, Fuji Electric released the λ -TWIN Series in 2001, and the G-TWIN Series which are downsized, modular and multi-standard products conforming to Japanese and overseas standards in 2007, and they have stayed ahead of changes in the market.

Inheriting the philosophy of the G-TWIN Series, we have now released the G-TWIN λ Series as a series of small breakers of 32 to 63 AF that meet the needs of the machine equipment and control panel markets.



JIS

EN



Global



GB

Standard

Molded Case Circuit Breakers / Earth Leakage Circuit Breakers

G-TWIN Λ Series



BW50RBGU



EW32SBG

Ampere frame	32AF	50AF	63AF	100AF to 800AF
<p>For machine equipments and control panels</p> <ul style="list-style-type: none"> ● Compact and high-performance ● Compliant with international standards ● Both AC and DC supported 	<p>NEW</p> <p>G-TWIN Λ series</p> 			
<p>For power receiving and distribution boards</p> <ul style="list-style-type: none"> ● Wide variety of types and product categories ● Various mounting methods supported ● Mounting compatibility (for renewal) 	<p>G-TWIN series</p> 			

Λ Downsizing

Small-width structure of 36 mm for 2-pole and 54 mm for 3-pole (28% smaller than our existing products) and 36 mm for 2-pole ELCB is realized.

Λ High breaking capacity

The arc commutation breaking technology has achieved a cut-above breaking performance to meet the needs of the control panel branch market.

Breaker types	G-TWIN Λ series	
Global products	18kA	
Standard products	Low breaking capacity type	7.5kA
	High breaking capacity type	15kA

* Standard products are compared by breaking capacity at IEC 230 VAC and global products at UL489 240VAC.

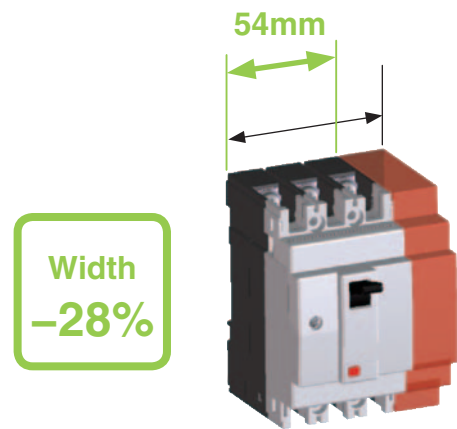

Arc commutation breaking technology realizing high breaking performance

Fuji Electric's proprietary breaking mechanism has been used for high-speed driving of the arc generated during breaking to achieve high breaking performance.

The magnetic driving force by optimization of the magnetic yoke, isolation of the breaking section and arc driving force by resin ablation gas flow control technology allow high-speed commutation of an arc between contacts to the arc runner for immediately driving the arc extinguisher.

The let-through energy (I^2t) during breaking has been reduced to less than half of the conventional products.

Breaking performance improved by **1.5 times**

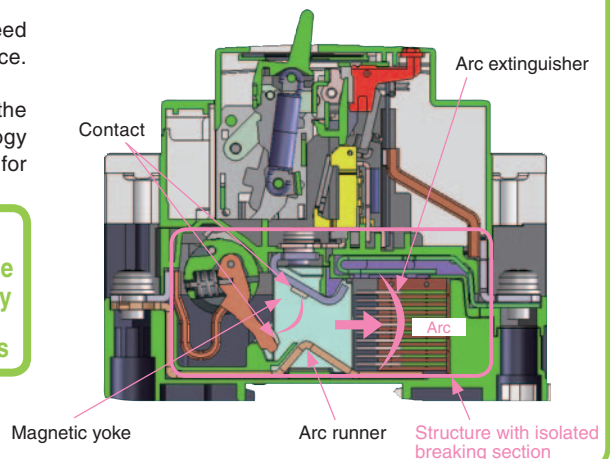

International standard

Compliant with standards of various countries including UL/CSA, IEC/EN (CE marking), GB (CCC) and JIS.

Series of product	Type	Compatibility-obtained standard			Certification-obtained standard			EC Directive	Certification authority
		IEC	EN	JIS	UL	CSA	GB	CE marking	TÜV
		International	Europe	Japan	U.S.A.	Canada	China	Europe	Germany
G-TWIN Series			EN	JIS					
Global series	MCCB	BW50RBGU	●	●	●	●	●	●	●
	ELCB	EW50RBGU	●	●	●	●	●	●	●
Standard series	MCCB	BW□EBG	●	●	●		●	●	●
		BW□SBG	●	●	●		●	●	●
	ELCB	EW□EBG	●	●	●		●	●	●
		EW□SBG	●	●	●		●	●	●

Standardization

- Standard installation on IEC 35 mm rails and screw mounting supported.
Note: Mounting screws are not included.
- The cassette-type internal accessories allow easy mounting and come in a variety of models.
Both MCCB and ELCB allow combined mounting of an auxiliary switch, alarm switch and shunt trip device.
2-pole ELCB allows mounting of an auxiliary switch and alarm switch.
- Both MCCB and ELCB allow dense side-by-side mounting to main units even with accessories included.
- Both AC and DC supported.
Thermal-electromagnetic overcurrent tripping system is adopted to allow support for both AC and DC also with 32 to 63 AF MCCB.
DC circuits are supported with standard products.

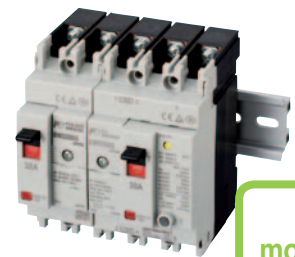

Rail mounting by standard

List of option accessory combination

		MCCB				ELCB			
		Accessory mounting location		Accessory mounting location		Accessory mounting location		Accessory mounting location	
●	Auxiliary switch (W)								
▲	Alarm switch (K)								
■	Shunt trip (F)								
■	Undervoltage trip (R)								
Number of poles		2-pole		3-pole		2-pole		3-pole	
Option accessory connecting method		Lead wire	Terminal block	Lead wire	Terminal block	Lead wire	Terminal block	Lead wire	Terminal block
Auxiliary switch	1 W	●	●	●	●	●	●	●	●
	2 V	—	—	●	●	—	—	●	●
Alarm switch	K	●	●	●	●	●	●	●	●
Auxiliary/alarm switch	WK	●	●	●	●	●	●	●	●
Shunt trip device	F	●	●	●	●	—	—	●	●
Undervoltage trip device	R	—	—	—	●	—	—	—	●
External operating handle	N type	●		●		●		●	
	V type	●		●		●		●	
Terminal cover	Short	●		●		●		●	
	Long	●		●		●		●	

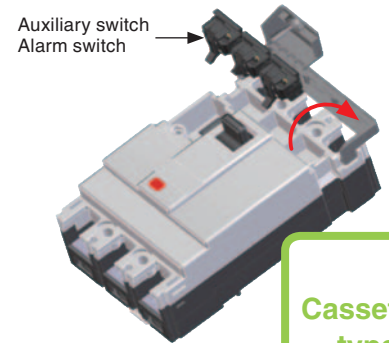

Cassette-type

Safety

- Safety is ensured with IP20 degree of protection from the front face of the terminal section, and different types of terminal covers are available.
- External operating handle can be mounted to meet the control panel needs.
Degree of protection: N type: IP54, V type: IP65
- The earth leakage circuit breaker has an IEC standard-compliant three-phase power supply structure, and earth leakage protection is provided even with one phase open.

Three-phase power supply supported

Terminal cover is easily removed from main units densely mounted side by side

With the step for putting the finger on, the terminal cover can be removed without holding the sides with no need for any tool.
Types with a different lock shape that can be removed with a tool are also available in view of safety.

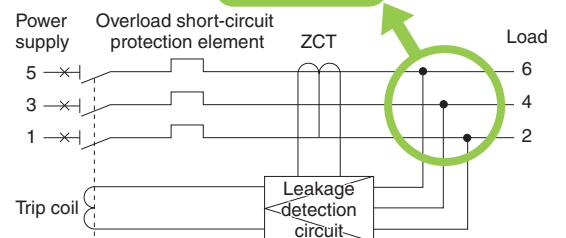
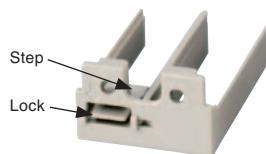

Catalog Disclaimer

The information contained in this catalog does not constitute an express or implied warranty of quality, any warranty of merchantability or fitness for a particular purpose is hereby disclaimed.

Since the user's product information, specific use application, and conditions of use are all outside of Fuji Electric FA Components & Systems' control, **it shall be the responsibility of the user to determine the suitability of any of the products mentioned for the user's application.**

One Year Limited Warranty

The products identified in this catalog shall be sold pursuant to the terms and conditions identified in the "Conditions of Sale" issued by Fuji Electric FA with each order confirmation.

Except to the extent otherwise provided for in the Conditions of Sale issued by Fuji Electric FA, Fuji Electric FA warrants that the Fuji Electric FA products identified in this catalog shall be free from significant defects in materials and workmanship provided the product has not been: 1) repaired or altered by others than Fuji Electric FA; 2) subjected to negligence, accident, misuse, or damage by circumstances beyond Fuji Electric FA's control; 3) improperly operated, maintained or stored; or 4) used in other than normal use or service. This warranty shall apply only to defects appearing within one (1) year from the date of shipment by Fuji Electric FA, and in such case, only if such defects are reported to Fuji Electric FA within thirty (30) days of discovery by purchaser. Such notice should be submitted in writing to Fuji Electric FA at 5-7, Nihonbashi Odemma-cho, Chuo-ku, Tokyo, Japan. The sole and exclusive remedy with respect to the above warranty whether such claim is based on warranty, contract, negligence, strict liability or any other theory, is limited to the repair or replacement of such product or, at Fuji Electric FA's option reimbursement by Fuji Electric FA of the purchase price paid to Fuji Electric FA for the particular product. **Fuji Electric FA does not make any other representations or warranties, whether oral or in writing, expressed or implied, including but not limited to any warranty regarding merchantability or fitness for a particular purpose.** Except as provided in the Conditions of Sale, no agent or representative of Fuji Electric FA is authorized to modify the terms of this warranty in writing or orally.

In no event shall Fuji Electric FA be liable for special, indirect or consequential damages, including but not limited to, loss of use of the product, other equipment, plant and power system which is installed with the product, loss of profits or revenues, cost of capital, or claims against the purchaser or user of the product by its customers resulting from the use of information, recommendations and descriptions contained herein. The purchaser agrees to pass on to its customers and users, in writing at the time inquiries and orders are received by buyer, Fuji Electric FA's warranty as set forth above.

Safety Considerations

- Operate (keep) in the environment specified in the operating instructions and manual. High temperature, high humidity, condensation, dust, corrosive gases, oil, organic solvents, excessive vibration or shock might cause electric shock, fire, erratic operation or failure.
- For safe operation, before using the product read the instruction manual or user manual that comes with the product carefully or consult the Fuji sales representative from which you purchased the product.
- Products introduced in this catalog have not been designed or manufactured for such applications in a system or equipment that will affect human bodies or lives.
- Customers, who want to use the products introduced in this catalog for special systems or devices such as for atomic-energy control, aerospace use, medical use, passenger vehicle, and traffic control, are requested to consult with Fuji Electric FA.
- Customers are requested to prepare safety measures when they apply the products introduced in this catalog to such systems or facilities that will affect human lives or cause severe damage to property if the products become faulty.
- For safe operation, wiring should be conducted only by qualified engineers who have sufficient technical knowledge about electrical work or wiring.
- Follow the regulations of industrial wastes when the product is to be discarded.
- For further questions, please contact your Fuji sales representative or Fuji Electric FA.

Molded Case Circuit Breakers / Earth Leakage Circuit Breakers

	Page
Type number nomenclature	8
Specifications	
MCCB for line protection use	
Standard product: BW32, 50, 63 □ BG	9
Global product: BW50RBGU	10
ELCB for line protection use	
Standard product: EW32, 50, 63 □ BG	11
Global product: EW50RBGU	13
Mounting and connection	
Front mounting type	14
Arc space	15
IEC 35 mm rail mounting	16
Terminal number	16
Internal wiring diagram	16
Accessories	
Internal accessories	
(1) Variation of internal accessories	17
(2) Types and terminal numbers of internal accessories	19
(3) Combinations of internal accessories	19
(4) Operations and ratings of auxiliary and alarm switches	27
(5) Shunt trip device	27
(6) Undervoltage trip device	27
(7) Accessory lead wire pull-out system	27
External accessories	
Variation of external accessories	28
List of separately sold parts	29
Data, Characteristics curves, Dimensions	
MCCB for line protection use	
BW32, 50, 63 □ BG (Standard product)	30
BW50RBGU (Global product)	33
ELCB for line protection use	
EW32, 50, 63 □ BG (Standard product)	36
EW50RBGU (Global product)	39
External operating handle	42

Molded Case Circuit Breakers / Earth Leakage Circuit Breakers

G-TWIN / Series

Type number nomenclature

■ Type Number Nomenclature

● Main unit

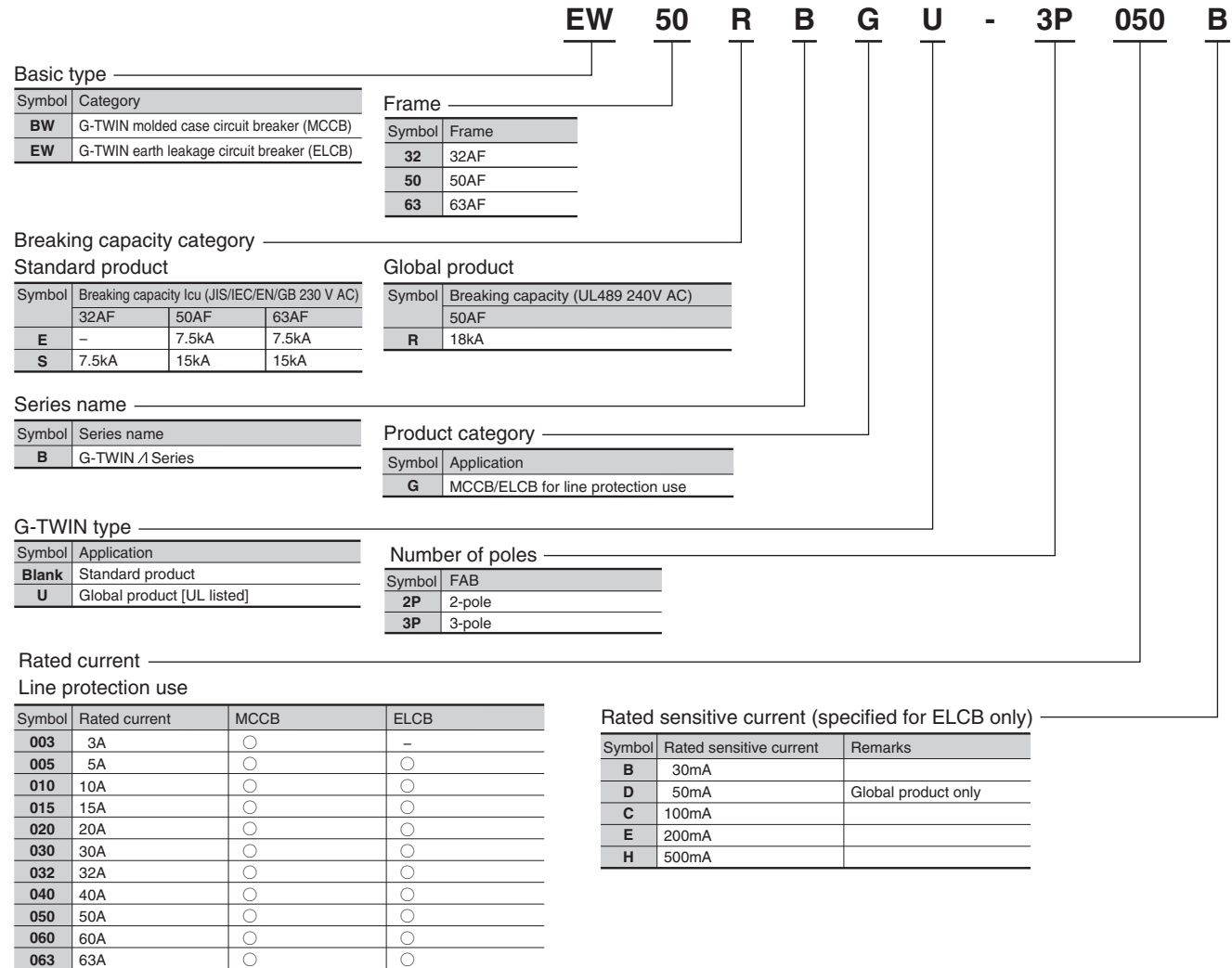



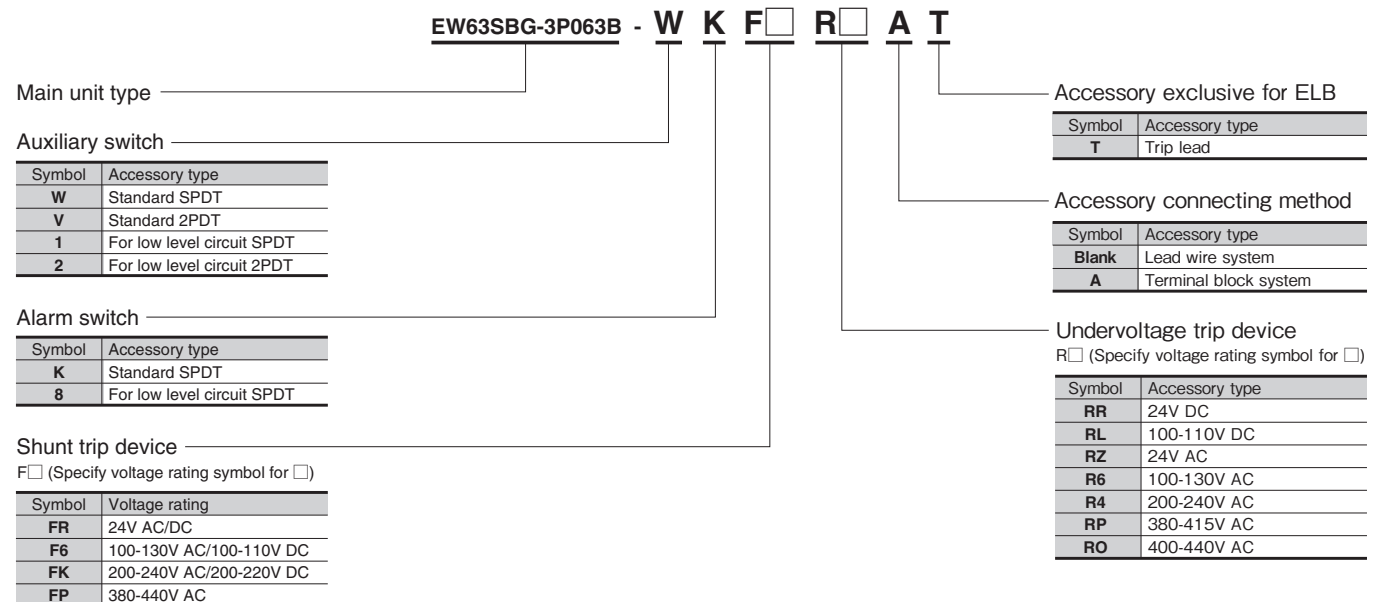



● Accessory

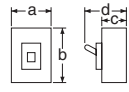

Molded Case Circuit Breakers / Earth Leakage Circuit Breakers G-TWIN / Series Specifications

■ Molded Case Circuit Breakers for Line Protection Use (Standard Products)







Ampere frame		32				50				63						
Type		BW32SBG				BW50EBG				BW50SBG						
Appearance																
Numbers of poles and elements		2P2E		3P3E		2P2E		3P3E		2P2E		3P3E				
Rated insulation voltage Ui[V]		AC		440		440		440		440		440				
		DC		125		—		125		—		125				
Rated impulse withstand voltage Uimp[kV]		6		6		6		6		6		6				
Rated current Reference temperature 40°C In[A]		3,5,10,15,20,30,32				3,5,10,15,20,30,32,40,50				60,63						
Rated frequency [Hz]		50-60				50-60				50-60						
Rated breaking capacity Icu/Ics [kA]	IEC60947-2 EN60947-2 JISC8201-2-1	AC	440V	2.5/2.5		2.5/2.5		7.5/4		2.5/2.5		7.5/4				
			415V	5/5		5/5		10/5		5/5		10/5				
			400V	5/5		5/5		10/5		5/5		10/5				
			380V	5/5		5/5		10/5		5/5		10/5				
			240V	7.5/7.5		7.5/7.5		15/15		7.5/7.5		15/15				
			230V	7.5/7.5		7.5/7.5		15/15		7.5/7.5		15/15				
	GB14048.2	DC	125V	10/10		—/—		10/10		—/—		10/10				
			AC	400V	5/5		5/5		10/5		5/5		10/5			
				230V	7.5/7.5		7.5/7.5		15/15		7.5/7.5		15/15			
				DC	125V	10/10		—/—		10/10		—/—		10/10		
Isolation compliance		Compliant				Compliant				Compliant						
Reverse connection		Possible				Possible				Possible						
Utilization category		A				A				A						
Use environment condition		Pollution degree 3				Pollution degree 3				Pollution degree 3						
Outline dimensions [mm]				a	36	54	36	54	36	54	36	54	36	54		
				b	100				100				100			
				c	68				68				68			
				d	90				90				90			
				Page	0.4	0.5	0.4	0.5	0.4	0.5	0.4	0.5	0.4	0.5	0.4	0.5
Mounting and connection	Front mounting type (screw mounting, IEC 35 mm rail mounting)		14, 16	○		○		○		○		○				
	Accessories			○		○		○		○		○				
Separately sold parts	Auxiliary switch		W 27	○		○		○		○		○				
	Alarm switch		K 27	○		○		○		○		○				
	Shunt trip device		F □ 27	○		○		○		○		○				
	Undervoltage trip device		R □ 27	—		○		—		○		—				
	Lead wire terminal block		A 32	○		○		○		○		○				
	Auxiliary switch		W 20	○		○		○		○		○				
	Alarm switch		K 20	○		○		○		○		○				
	Shunt trip device		F □ 20	○		○		○		○		○				
	External operating handle		Panel mounting	V 29	○		○		○		○		○			
			Main unit mounting	N 29	○		○		○		○		○			
Terminal cover		Short type	TS 29	○		○		○		○		○				
		Long type	TL 29	○		○		○		○		○				
Insulation barrier		Interphase barrier	B 29	○		○		○		○		○				
Handle locking cover		L1 29	○		○		○		○		○					
Handle key lock		Q2 29	○		○		○		○		○					
Conformance to standards	IEC60947-2 (TUV certificate)															
	EN60947-2 (CE marking)															
	GB14048.2 (CCC certificate)															
	JISC8201-2-1		Self-declaration of conformity													
	Electrical Appliances and Materials Safety Act		Specified Electrical Appliances and Materials 													
Tripping device		Thermal-electromagnetic method														
Trip button		Provided														
Characteristics curves and dimensions on pages		31, 32														

Molded Case Circuit Breakers / Earth Leakage Circuit Breakers

G-TWIN / Series

Specifications

■ Molded Case Circuit Breakers for Line Protection Use (Global Products)





Ampere frame		50			
Type		BW50RBGU			
Appearance					
Numbers of poles and elements		2P2E	3P3E		
Rated insulation voltage U_i [V]		AC	440		
		DC	125		
Rated impulse withstand voltage U_{imp} [kV]		6			
Rated current Reference temperature 40°C I_n [A]		3,5,10,15,20,30,40,50			
Rated frequency [Hz]		50-60			
Rated breaking capacity I_{cu}/I_{cs} [kA]	UL489, CAN/CSA22.2 No.5(cUL)	AC	240V	18	
		AC	440V	7.5/4	
			415V	10/5	
			400V	10/5	
			380V	10/5	
			240V	15/15	
	GB14048.2	AC	230V	15/15	
			400V	10/5	
		DC	125V	10/10	
			125V	10/10	
Isolation compliance		Compliant			
Reverse connection		Possible			
Utilization category		A			
Use environment condition		Pollution degree 3			
Outline dimensions [mm]		a	36	54	
		b	120 (including the terminal cover)		
		c	68		
		d	90		
Front mounting type product mass [kg]		Page	0.5	0.6	
Mounting and connection	Front mounting type (screw mounting, IEC 35 mm rail mounting)	14, 16	○		
Accessories	Auxiliary switch	W	27	○	
	Alarm switch	K	27	○	
	Shunt trip device	F □	27	○	
	Undervoltage trip device	R □	27	○	
	Lead wire terminal block	A	35	○	
Separately sold parts	Auxiliary switch	W	20	○	
	Alarm switch	K	20	○	
	Shunt trip device	F □	20	○	
	External operating handle	Panel mounting	V	29	○
		Main unit mounting	N	29	○
	Terminal cover	Short type	TS	29	○ (Included)
		Long type	TL	29	○
	Insulation barrier	Interphase barrier	B	29	○
	Handle locking cover	L1	29	○	
	Handle key lock	Q2	29	○	
Conformance to standards	UL489/CSA22.2No.5(cUL)	 (File No.E90584)			
	IEC60947-2 (TÜV certificate)				
	EN60947-2 (CE marking)				
	GB14048.2 (CCC certificate)				
	JISC8201-2-1 Electrical Appliances and Materials Safety Act	Self-declaration of conformity Specified Electrical Appliances and Materials 			
Tripping device		Thermal-electromagnetic method			
Trip button		Provided			
Characteristics curves and dimensions on pages		34, 35			

Molded Case Circuit Breakers / Earth Leakage Circuit Breakers

G-TWIN / Series

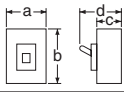
Specifications

■ Earth Leakage Circuit Breakers for Line Protection Use (Standard Products)





Ampere frame		32		50					
Type		EW32SBG		EW50EBG					
Appearance									
Numbers of poles and elements		2P2E		3P3E					
Applied circuit		1ø2W		1ø2W,1ø3W,3ø2W					
Rated operational voltage U _e [V]		100-240V AC		100-440V AC					
Rated impulse withstand voltage U _{imp} [kV]		4		6					
Rated current Reference temperature 40°C I _n [A]		5,10,15,20,30,32		5,10,15,20,30,32,40,50					
Rated frequency [Hz]		50-60		50-60					
Rated sensitive current I _{Δn} [mA]		30		30,100,200,500					
Maximum operating time [sec]		I _{Δn} 0.1 5I _{Δn} 0.04		0.1 0.04					
Rated breaking capacity I _{cu} /I _{cs} [kA]	IEC60947-2 EN60947-2 JISC8201-2-2	AC	440V	-/-	2.5/2.5	-/-	2.5/2.5	-/-	7.5/4
			415V	-/-	5/5	-/-	5/5	-/-	10/5
			400V	-/-	5/5	-/-	5/5	-/-	10/5
			380V	-/-	5/5	-/-	5/5	-/-	10/5
			240V	7.5/7.5	7.5/7.5	7.5/7.5	7.5/7.5	15/15	15/15
			230V	7.5/7.5	7.5/7.5	7.5/7.5	7.5/7.5	15/15	15/15
	GB14048.2	AC	100V	7.5/7.5	7.5/7.5	7.5/7.5	7.5/7.5	15/15	15/15
			400V	-/-	5/5	-/-	5/5	-/-	10/5
			230V	7.5/7.5	7.5/7.5	7.5/7.5	7.5/7.5	15/15	15/15
			230V	7.5/7.5	7.5/7.5	7.5/7.5	7.5/7.5	15/15	15/15
Isolation compliance		Compliant		Compliant					
Reverse connection		Not possible		Not possible					
Utilization category		A		A					
Use environment condition		Pollution degree 3		Pollution degree 3					
Outline dimensions [mm]		Pollution degree 3		Pollution degree 3					
		a	36	54	36	54	36	54	
		b	100		100		100		
		c	68		68		68		
		d	90		90		90		
Front mounting type product mass [kg]		Page	0.4	0.6	0.4	0.6	0.4	0.6	
Mounting and connection	Front mounting type (screw mounting, IEC 35 mm rail mounting)	14, 16	○		○		○		
	Accessories								
	Auxiliary switch	W 27	○		○		○		
	Alarm switch	K 27	○		○		○		
	Shunt trip device	F □ 27	-	○	-	○	-	○	
	Undervoltage trip device	R □ 27	-	○	-	○	-	○	
	Trip lead	T 19	○		○		○		
	Lead wire terminal block	A 38	○		○		○		
Separately sold parts	Auxiliary switch	W 20	○		○		○		
	Alarm switch	K 20	○		○		○		
	Shunt trip device	F □ 20	-	○	-	○	-	○	
	External operating handle	Panel mounting	V 29	○		○		○	
		Main unit mounting	N 29	○		○		○	
	Terminal cover	Short type	TS 29	○		○		○	
		Long type	TL 29	○		○		○	
	Insulation barrier	Interphase barrier	B 29	○		○		○	
	Handle locking cover	L1	29	○		○		○	
	Handle key lock	Q2	29	○		○		○	
Conformance to standards	IEC60947-2 (TUV certificate)								
	EN60947-2 (CE marking)								
	GB14048.2 (CCC certificate)								
	JISC8201-2-1		Self-declaration of conformity						
	Electrical Appliances and Materials Safety Act		Specified Electrical Appliances and Materials						
Tripping device		Thermal-electromagnetic method							
Trip button		Provided							
Earth leakage indication		Mechanical button							
Characteristics curves and dimensions on pages		37, 38							

Rated voltage (V)	Operational voltage range (V)
100-240V AC	80 to 264V AC
100-440V AC	80 to 484V AC

Molded Case Circuit Breakers / Earth Leakage Circuit Breakers

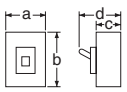
G-TWIN / Series







Specifications

Ampere frame		63					
Type		EW63EBG		EW63SBG			
Appearance							
Numbers of poles and elements		2P2E	3P3E	2P2E	3P3E		
Applied circuit		1ø2W	1ø2W,1ø3W,3ø2W	1ø2W	1ø2W,1ø3W,3ø2W		
Rated operational voltage U _e [V]		100-240V AC	100-440V AC	100-240V AC	100-440V AC		
Rated impulse withstand voltage U _{imp} [kV]		4	6	4	6		
Rated current Reference temperature 40°C I _n [A]		60,63					
Rated frequency [Hz]		50-60					
Rated sensitive current I _{Δn} [mA]		30	30,100,200,500	30	30,100,200,500		
Maximum operating time [sec]		I _{Δn}	0.1		0.1		
		5I _{Δn}	0.04		0.04		
Rated breaking capacity I _{cu} /I _{cs} [kA]	IEC60947-2 EN60947-2 JISC8201-2-2	AC	440V	-/-	2.5/2.5	-/-	7.5/4
			415V	-/-	5/5	-/-	10/5
			400V	-/-	5/5	-/-	10/5
			380V	-/-	5/5	-/-	10/5
			240V	7.5/7.5	7.5/7.5	15/15	15/15
			230V	7.5/7.5	7.5/7.5	15/15	15/15
	GB14048.2	AC	100V	7.5/7.5	7.5/7.5	15/15	15/15
			400V	-/-	5/5	-/-	10/5
			230V	7.5/7.5	7.5/7.5	15/15	15/15
Isolation compliance		Compliant		Compliant			
Reverse connection		Not possible		Not possible			
Utilization category		A		A			
Use environment condition		Pollution degree 3		Pollution degree 3			
Outline dimensions [mm] 		a	36	54	36	54	
		b	100				
		c	68				
		d	90				
		Front mounting type product mass [kg]		Page	0.4	0.6	0.4
Mounting and connection	Front mounting type (screw mounting, IEC 35 mm rail mounting)	14, 16	<input type="radio"/>		<input type="radio"/>		
Accessories	Auxiliary switch	W 27	<input type="radio"/>		<input type="radio"/>		
	Alarm switch	K 27	<input type="radio"/>		<input type="radio"/>		
	Shunt trip device	F <input type="checkbox"/> 27	-	<input type="radio"/>	-	<input type="radio"/>	
	Undervoltage trip device	R <input type="checkbox"/> 27	-	<input type="radio"/>	-	<input type="radio"/>	
	Trip lead	T 19	<input type="radio"/>		<input type="radio"/>		
	Lead wire terminal block	A 38	<input type="radio"/>		<input type="radio"/>		
	Separately sold parts	Auxiliary switch	W 20	<input type="radio"/>		<input type="radio"/>	
Alarm switch		K 20	<input type="radio"/>		<input type="radio"/>		
Shunt trip device		F <input type="checkbox"/> 20	-	<input type="radio"/>	-	<input type="radio"/>	
External operating handle		Panel mounting	V 29	<input type="radio"/>		<input type="radio"/>	
		Main unit mounting	N 29	<input type="radio"/>		<input type="radio"/>	
Terminal cover		Short type	TS 29	<input type="radio"/>		<input type="radio"/>	
		Long type	TL 29	<input type="radio"/>		<input type="radio"/>	
Insulation barrier		Interphase barrier	B 29	<input type="radio"/>		<input type="radio"/>	
Handle locking cover		L1 29	<input type="radio"/>		<input type="radio"/>		
Handle key lock		Q2 29	<input type="radio"/>		<input type="radio"/>		
Conformance to standards	IEC60947-2 (TUV certificate)						
	EN60947-2 (CE marking)						
	GB14048.2 (CCC certificate)						
	JISC8201-2-1		Self-declaration of conformity				
	Electrical Appliances and Materials Safety Act		Specified Electrical Appliances and Materials 				
Tripping device		Thermal-electromagnetic method					
Trip button		Provided					
Earth leakage indication		Mechanical button					
Characteristics curves and dimensions on pages		37, 38					

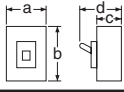
Rated voltage (V)	Operational voltage range (V)
100-240V AC	80 to 264V AC
100-440V AC	80 to 484V AC

Molded Case Circuit Breakers / Earth Leakage Circuit Breakers G-TWIN / Series Specifications

■ Earth Leakage Circuit Breakers for Line Protection Use (Global Products)

Ampere frame		50			
Type		EW50RBGU			
Appearance					
Numbers of poles and elements		2P2E	3P3E		
Applied circuit		1ø2W	1ø2W,3ø3W		
Rated operational voltage U _e [V]		IEC	100-240V AC		
		UL	240V AC		
Rated impulse withstand voltage U _{imp} [kV]		4	6		
Rated current Reference temperature 40°C I _n [A]		5,10,15,20,30,40,50			
Rated frequency [Hz]		50-60			
Rated sensitive current I _{Δn} [mA]		30	30,50,100,200,500		
Maximum operating time [sec]		I _{Δn}	0.1		
		5I _{Δn}	0.04		
Rated breaking capacity I _{cu} /I _{cs} [kA]	UL489, CAN/CSA22.2 No.5(cUL)	AC	240V 18	18	
		AC	440V -/-	7.5/4	
	IEC60947-2	AC	415V -/-	10/5	
		AC	400V -/-	10/5	
	EN60947-2	AC	380V -/-	10/5	
		AC	240V 15/15	15/15	
	JISC8201-2-2	AC	230V 15/15	15/15	
		AC	100V 15/15	15/15	
	GB14048.2	AC	400V -/-	10/5	
		AC	230V 15/15	15/15	
Isolation compliance		Compliant			
Reverse connection		Not possible			
Utilization category		A			
Use environment condition		Pollution degree 3			
Outline dimensions [mm] 		a	36	54	
		b	120 (including the terminal cover)		
		c	68		
		d	90		
Front mounting type product mass [kg]		Page	0.5	0.6	
Mounting and connection	Front mounting type (screw mounting, IEC 35 mm rail mounting)	14, 16	<input type="radio"/>		
	Accessories				
	Auxiliary switch	W 27	<input type="radio"/>		
	Alarm switch	K 27	<input type="radio"/>		
	Shunt trip device	F <input type="checkbox"/> 27	-	<input type="radio"/>	
	Undervoltage trip device	R <input type="checkbox"/> 27	-	<input type="radio"/>	
	Lead wire terminal block	A 41	<input type="radio"/>		
Separately sold parts	Auxiliary switch	W 20	<input type="radio"/>		
	Alarm switch	K 20	<input type="radio"/>		
	Shunt trip device	F <input type="checkbox"/> 20	-	<input type="radio"/>	
	External operating handle	Panel mounting	V 29	<input type="radio"/>	
		Main unit mounting	N 29	<input type="radio"/>	
	Terminal cover	Short type	TS 29	<input type="radio"/>	(Included)
		Long type	TL 29	<input type="radio"/>	
	Handle locking cover	L1 29	<input type="radio"/>		
Handle key lock	Q2 29	<input type="radio"/>			
Conformance to standards	UL489/CSA22.2No.5(cUL)	 (File No.E90584)			
	IEC60947-2 (TUV certificate)				
	EN60947-2 (CE marking)				
	GB14048.2 (CCC certificate)				
	JISC8201-2-1 Electrical Appliances and Materials Safety Act	Self-declaration of conformity Specified Electrical Appliances and Materials 			
Tripping device		Thermal-electromagnetic method			
Trip button		Provided			
Earth leakage indication		Mechanical button			
Characteristics curves and dimensions on pages		40, 41			

Standards	Rated voltage (V)	Operational voltage range (V)
UL	240V AC	80 to 264V AC
IEC	100-240V AC	80 to 264V AC
	100-440V AC	80 to 484V AC

Molded Case Circuit Breakers / Earth Leakage Circuit Breakers

G-TWIN / Series

Mounting and connection

■ Front Mounting Type

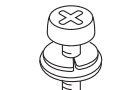
Appearance	Screw		Tightening torque [N•m]	MCCB main unit applicable type (basic designation)	ELCB main unit applicable type (basic designation)
	Shape	Screw size			
For crimp/stick terminals (front connection) 		M5 x 14	2.0 to 3.0	BW32 BW50	EW32 EW50
		M6 x 14	4.0 to 5.0	BW63	EW63

Mount the crimp terminals to ensure that the wires for the respective poles are in parallel as shown in the figure below.

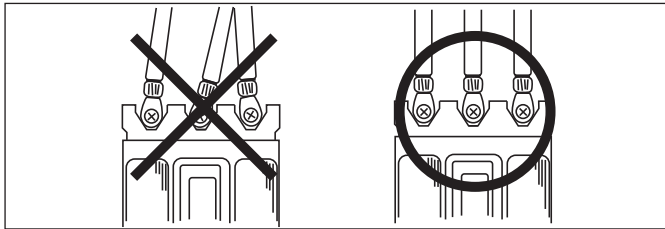

(1) List of applicable crimp terminals

Frame [A]	Cross section area of electric wire used [mm ²]		2	5.5	8	14	22
	Allowable current [A] (600V IV electric wire 30°C Insulator wiring)		27	49	61	88	115
Frame [A]	Range of electric wire used [mm ²]		1.04 to 2.63	2.63 to 6.64	6.64 to 10.52	10.52 to 16.78	16.78 to 26.66
	MCCB main unit applicable type (basic designation)	ELCB main unit applicable type (basic designation)					
32	BW32	EW32	R2-5	R5.5-5	R8-5	R14-5	
50	BW50	EW50					
63	BW63	EW63	R2-6	R5.5-6	R8-6	R14-6	JST 22-S6

(Explanation) R: JIS C2805, JST: provided by JST Mfg. Co., Ltd.

● Crimp terminal size

Model number	Shape	Diameter of screw used	Outline dimensions [mm]						Applicable electric wire [mm ²]
			ød ₂	B	L	F	E	Plate thickness	
R2-5	A	M5	5.3	9.5	16.8	7.3	4.8	0.8	1.04 to 2.63
R2-6		M6	6.4	12.0	21.8	11.0			
R5.5-5		M5	5.3	9.5	19.8	8.3	6.8	1.0	2.63 to 6.64
R5.5-6		M6	6.4	12.0	25.8	13.0			
R8-5		M5	5.3		29.8	9.3	8.5	1.2	6.64 to 10.52
R8-6		M6	6.4						
R14-5		M5	5.3			13.3	10.5	1.5	10.52 to 16.78
R14-6		M6	6.4						
22-S5		M5	5.3		30.0	12.0	12.0	1.8	16.78 to 26.66
L330T459-23		M5	5.3						
22-S6		M6	6.4						

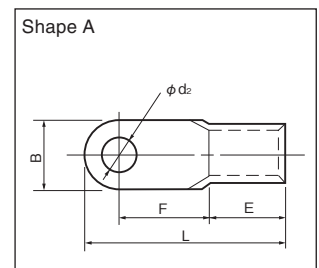

Note: Excerpt from JST's catalog

Molded Case Circuit Breakers / Earth Leakage Circuit Breakers G-TWIN / Series Mounting and connection

● Wire connecting method (global products)

(1) Notes on wire (conductor) connection

- Connect wires to UL breakers according to the National Electrical Code (NEC) or Canadian Electrical Code (CEC) Part 1.
- For connection, use 75°C copper wires. Use of UL- or CSA-approved wires is recommended.
- A large current flow including a short-circuit current flow may generate a very large electromagnetic force between wires. Ensure that wires are securely supported.
- Regularly retighten the tightening screws of the terminals.
- Do not cover the arc gas outlet.

● Connectable wire and tightening torque

Crimp terminal connection

MCCB main unit type	ELCB main unit type	Rated current [A]	Applicable crimp terminal			Connectable wire size 75°C wire	Tightening torque [N•m]	Screw head type and size [mm]
			(Provided by JST Mfg.)	Provided by Nichifu	Provided by Daido Solderless Terminal Mfg.			
BW50RBGU	EW50RBGU	3	2-M5, R2-5	R2-5, R2-5M	R2-5, R2-S5	14AWG	2.0 to 3.0	Cross-recessed pan-head screw with washer
		5						
		10						
		15						
		20	3.5-5, 3.5-R5, 5-S5, 5.5-5NS, R5.5-5	R3.5-5S, R3.5-5L, R5.5-5, R5.5-5N, R5.5-5S	R3.5-5, R5.5-5, R5.5-L5, R5.5-S5	12AWG		
		30	5-S5, 5.5-5NS, R5.5-5	R5.5-5, R5.5-5N, R5.5-5	R5.5-5, R5.5-L5, R5.5-S5	10AWG		
40	8-5NS,8-NK5, 8-5L5NS	R8-5, R8-5S	R8-5, R8-S5	8AWG				
50								

Note 1: AWG/MCM is a system to indicate UL wire sizes.

Note 2: Use 75°C wires for connection. (UL- or CSA-approved wires)

Note 3: For the crimping tool, be sure to use UL- or CSA-approved products from manufacturers.

■ Arc Space

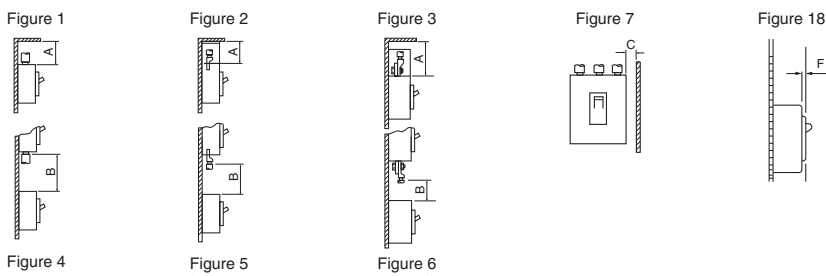

Electric wire direct connection

Crimp terminal connection

Ensure the values in the table below for the insulation space according to the conditions given in the respective drawings. For wiring, take into consideration various situations that may arise in actual use conditions and provide bare conductors with taping or insulation barriers for the ranges of dimensions shown in the table below. Insulation outside the arc space may need reinforcement depending on the use conditions.

[Unit: mm]

Basic designation		Ceiling distance	Vertical distance	Side plate distance	Front plate distance
MCCB	ELCB	A	B	C	F
BW32	EW32	10	20	10	0
BW50	EW50				
BW63	EW63				
		Figure 1, 2, 3	Figure 4, 5, 6	Figure 7	Figure 8

Molded Case Circuit Breakers / Earth Leakage Circuit Breakers

G-TWIN / Series

Mounting and connection

■ IEC 35 mm Rail Mounting

Mounting on IEC 35 mm rails is possible as standard.

Main unit applicable type (basic designation)	
MCCB	ELCB
BW32	EW32
BW50	EW50
BW63	EW63

Note 1: Mounting pitch for rail fixing screws of within 250 mm is recommended.
 Note 2: Applicable rails: TH35-7.5, TH35-7.5AL and TH35-15AL. (Types of Fuji Electric FA Components & Systems products)

* Main unit mounting screws are not included. When necessary, use commercially-available screws (recommended size: M4 x 60).

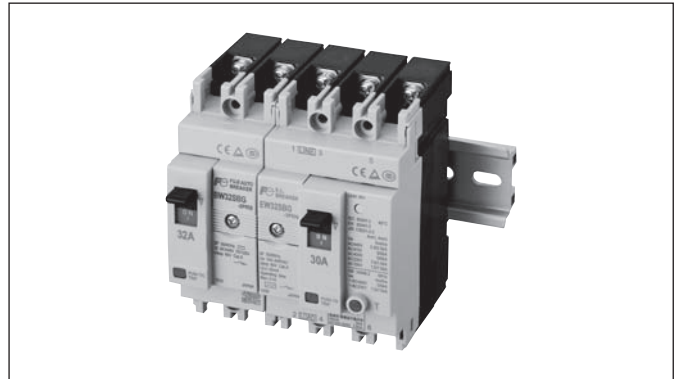

Note: For vertical mounting, use holding brackets (type LT9E-T1 provided by Fuji Electric Technica Co., Ltd.).

■ Terminal Number

● ELCB terminal number

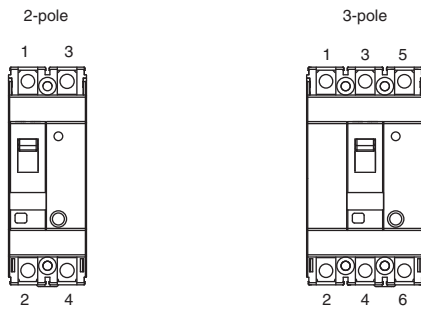

■ Internal Wiring Diagram

● ELCB internal wiring diagram

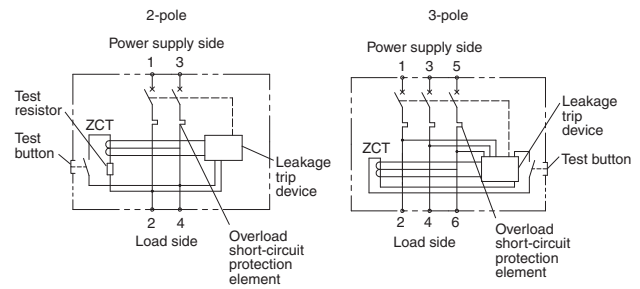

■ Internal Resistance and Power Consumption

● MCCB

AF	Type	Rated current [A]	Internal resistance (mΩ) (for one phase)	Power consumption (W) (for three phases)
32AF 50AF	BW32SBG BW50EBG BW50SBG BW50RBGU	3	116.0	3.1
		5	50.5	3.8
		10	13.8	4.1
		15	6.5	4.4
		20	4.1	5.2
		30	2.8	7.6
50AF	BW50EBG BW50SBG BW50RBGU	40	1.7	8.2
		50	1.5	11.3
		63AF	BW63EBG BW63SBG	60
63	1.1	13.1		

● ELCB

AF	Type	Rated current [A]	Internal resistance (mΩ) (for one phase)	Power consumption (W) (for three phases)
32AF 50AF	EW32SBG EW50EBG EW50SBG EW50RBGU	5	50.5	3.8
		10	13.8	4.1
		15	6.5	4.4
		20	4.1	5.2
		30	2.8	7.6
		32	2.8	8.6
50AF	EW50EBG EW50SBG EW50RBGU	40	1.9	9.1
		50	1.7	12.8
63AF	EW63EBG EW63SBG	60	1.3	14.0
		63	1.3	15.5

■ **Internal Accessories**

(1)-1 Variation of internal accessories (MCCB)

Auxiliary switch

Switch that electrically indicates the ON/OFF state of MCCB/ELCB.



Type symbol : W See page : 27

Shunt trip device

Device that electrically trips MCCB/ELCB from a remote place.

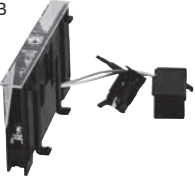

Type symbol : F See page : 27

Alarm switch

Switch that electrically indicates the trip state of MCCB/ELCB.



Type symbol : K See page : 27

Undervoltage trip device

Device that automatically trips MCCB/ELCB when the circuit voltage has decreased below the specified value. (Externally mounted)

Note 1. Not separately sold. (Factory mounting only)

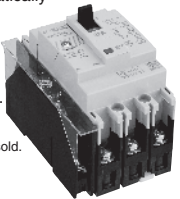

Type symbol : R See page : 27

2-pole product

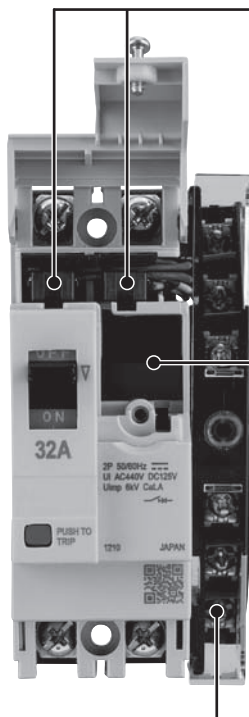

3-pole product

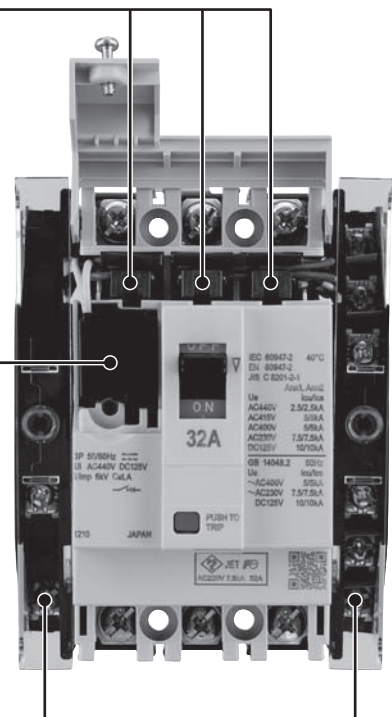

Lead wire terminal block

Provides wiring terminals for connection with internal accessories.



Type symbol : A See page : 32, 35

Molded Case Circuit Breakers / Earth Leakage Circuit Breakers

G-TWIN / Series

Accessories

(1)-2 Variation of internal accessories (ELCB)

Auxiliary switch

Switch that electrically indicates the ON/OFF state of MCCB/ELCB.



Type symbol : W See page : 27

Shunt trip device

Device that electrically trips MCCB/ELCB from a remote place.

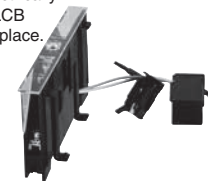

Type symbol : F See page : 27

Alarm switch

Switch that electrically indicates the trip state of MCCB/ELCB.



Type symbol : K See page : 27

Undervoltage trip device

Device that automatically trips MCCB/ELCB when the circuit voltage has decreased below the specified value. (Externally mounted)

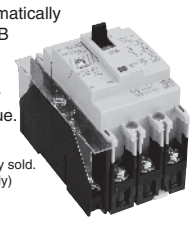

Note 1. Not separately sold. (Factory mounting only)

Type symbol : R See page : 27

2-pole product

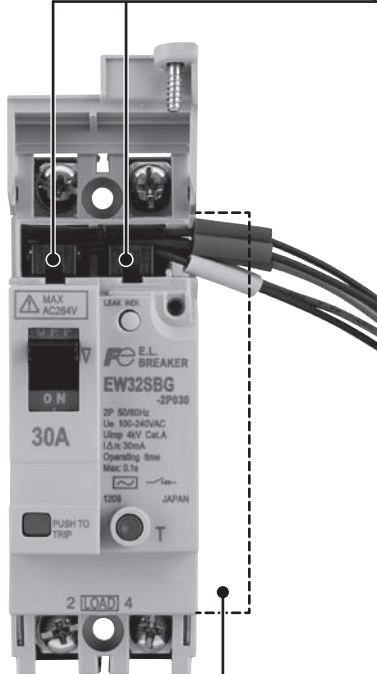

3-pole product

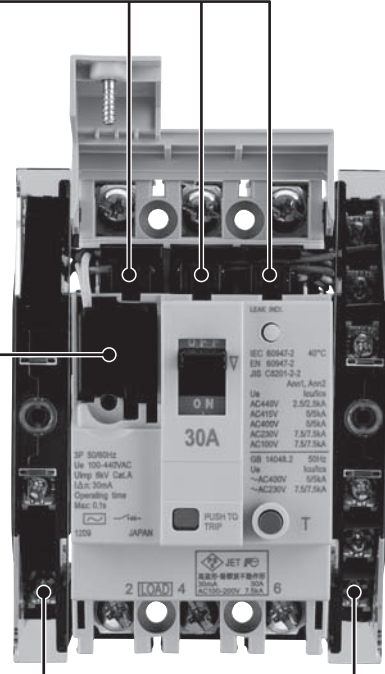

Lead wire terminal block

Provides wiring terminals for connection with internal accessories.



Type symbol : A See page : 38, 41

Trip lead

Device that remotely trips ELCB with a contact signal.

Type symbol : T See page : 19

(2) Types and terminal numbers of internal accessories

The following describes the types and terminal numbers of internal accessories.

Type		Terminal number		Remarks
		Left side mounting	Right side mounting	
Auxiliary switch Standard: W, V Low level circuit: 1, 2	For one switch (W) (1)			For the rated operational voltage and current, see page 27. For details of mounting positions, see the List of internal accessory combinations on pages 21 to 26.
	For two switches (V) (2)			
Alarm switch Standard: K Low level circuit: 8	For one switch (K) (8)			
Shunt trip device: F	With burn-out preventive contact (standard)			For the operating voltage, see page 27.
Undervoltage trip device				For the operating voltage, see page 27.
Trip lead: T (For ELB only) Note: Cannot be specified for global products.				Do not apply voltage on the terminal block because the main circuit voltage is output. Select a switch to be connected that is capable of switching the main circuit voltage of the ELB without any problem and withstands a current of up to 1 A. Do not share the switch of the trip lead with other ELB. It may cause a fire due to a short circuit. When extending the trip lead, ensure that the length is within 3 m. Failure to observe this instruction may lead to unwanted operation.

(3) Combinations of internal accessories

● List of internal accessory combinations

Type			MCCB				ELCB								
			Main unit applicable type				EW32SBG EW50EBG EW50SBG EW63EBG EW63SBG BW50RBGU				EW50RBGU				
Number of poles			2P		3P		2P		3P		2P		3P		
Terminal connection			Lead wire	Terminal block	Lead wire	Terminal block	Lead wire	Terminal block	Lead wire	Terminal block	Lead wire	Terminal block	Lead wire	Terminal block	
Accessory type	Auxiliary switch x1	W (1)	○	○	○	○	○	○	○	○	○	○	○	○	
	Auxiliary switches x2	V (2)	—	—	○	○	—	—	○	○	—	—	○	○	
	Alarm switch x1	K (8)	○	○	○	○	○	○	○	○	○	○	○	○	
	Shunt trip device	F	○ *1	○ *1	○	○	—	—	○	○	—	—	○	○	
	Undervoltage trip device	R	—	—	—	○ *1	—	—	—	○ *1	—	—	—	○ *1	
	Trip lead	T	—	—	—	—	—	○ *1	—	○ *1	—	—	—	—	
	Combination	W+K		○	○	○	○	○	○	○	○	○	○	○	○
		W+F		—	—	○	○	—	—	○	○	—	—	○	○
		W+R		—	—	○ *2	○ *1	—	—	○ *2	○ *1	—	—	○ *2	○ *1
		W+T		—	—	—	—	—	—	○ *2	○ *1	—	—	—	—
		V+K		—	—	○	○	—	—	○	○	—	—	○	○
		K+F		—	—	○	○	—	—	○	○	—	—	○	○
		K+R		—	—	○ *2	○ *1	—	—	○ *2	○ *1	—	—	○ *2	○ *1
K+T			—	—	—	—	—	—	○ *2	○ *1	—	—	—	—	
W+K+F		—	—	○	○	—	—	○	○	—	—	○	○		
W+K+R		—	—	○ *2	○ *1	—	—	○ *2	○ *1	—	—	○ *2	○ *1		
W+K+T		—	—	—	—	—	—	○ *2	○ *1	—	—	—	—		

Note *1: Factory mounting only (to be specified in the order).

Note *2: Factory mounting only; W/K for lead wire connection and R/T for terminal block connection (to be specified in the order).

Molded Case Circuit Breakers / Earth Leakage Circuit Breakers

G-TWIN / Series

Accessories

● One-touch mounting internal accessories (separately sold)

Type	Terminal connection	Lead wire pull-out direction	Type	Voltage rating	Mountability						
					MCCB		ELCB				
					2P	3P	2P	3P			
Auxiliary switch (standard type)	Lead wire type	Left side	BW9W1SB1	/	-	○	-	○			
		Right side	BW9W1SB1-R		○	○	○	○			
		Left side	BW9W1DB1		-	○	-	○			
		Right side	BW9W1DB1-R		○	○	○	○			
		Left side	BW9K1SB1		-	○	-	○			
		Right side	BW9K1SB1-R		○	○	○	○			
		Left side	BW9K1DB1		-	○	-	○			
		Right side	BW9K1DB1-R		○	○	○	○			
		Left side	BW9WKS1B1		-	○	-	○			
		Right side	BW9WKS1B1-R		○	○	○	○			
		Left side	BW9WK1B1		-	○	-	○			
		Right side	BW9WK1B1-R		○	○	○	○			
		Shunt trip device	Lead wire type		Left side	BW9FRB1	AC/DC24V	-	○	-	○
						BW9F6B1	AC100-130V/DC100-110V				
						BW9FKB1	AC200-240V/DC200-220V				
						BW9FPB1	AC380-440V				
Auxiliary switch (standard type)	Terminal block type	Left side	BW9W1SB1-A	/	○	○	○	○			
		Right side	BW9W1SB1-RA		-	○	-	○			
		Left side	BW9W1DB1-A		○	○	○	○			
		Right side	BW9W1DB1-RA		-	○	-	○			
		Left side	BW9K1SB1-A		○	○	○	○			
		Right side	BW9K1SB1-RA		-	○	-	○			
		Left side	BW9K1DB1-A		○	○	○	○			
		Right side	BW9K1DB1-RA		-	○	-	○			
		Left side	BW9WKS1B1-A		○	○	○	○			
		Right side	BW9WKS1B1-RA		-	○	-	○			
		Left side	BW9WK1B1-A		○	○	○	○			
		Right side	BW9WK1B1-RA		-	○	-	○			
		Shunt trip device	Terminal block type		Left side	BW9FRB1-A	AC/DC24V	-	○	-	○
						BW9F6B1-A	AC100-130V/DC100-110V				
						BW9FKB1-A	AC200-240V/DC200-220V				
						BW9FPB1-A	AC380-440V				

Molded Case Circuit Breakers / Earth Leakage Circuit Breakers

G-TWIN / Series

Accessories

● Details of combinations of internal accessories

(a) Lead wire type (MCCB)

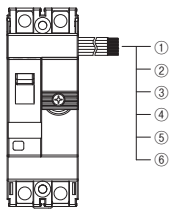
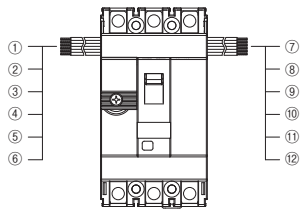
Lead wire type	MCCB (2P)	MCCB (3P)																										
																												
Type	BW32SBG, BW50 <input type="checkbox"/> BG, BW63 <input type="checkbox"/> BG BW50RBGU	BW32SBG, BW50 <input type="checkbox"/> BG, BW63 <input type="checkbox"/> BG BW50RBGU																										
Accessory type	Left side	Right side	Left side	Right side																								
	Position Ring mark	Position Ring mark	Position Ring mark	Position Ring mark																								
Auxiliary switch	Cannot be pulled out to the left side.	<table border="1" style="width: 100%; border-collapse: collapse;"> <tr><td>①</td><td>21/AXc : Yellow</td></tr> <tr><td>②</td><td>24/AXa : Red</td></tr> <tr><td>③</td><td>22/AXb : Blue</td></tr> <tr><td>—</td><td>—</td></tr> <tr><td>—</td><td>—</td></tr> <tr><td>—</td><td>—</td></tr> </table>	①	21/AXc : Yellow	②	24/AXa : Red	③	22/AXb : Blue	—	—	—	—	—	—	<table border="1" style="width: 100%; border-collapse: collapse;"> <tr><td>①</td><td>11/AXc : White</td></tr> <tr><td>②</td><td>14/AXa : Brown</td></tr> <tr><td>③</td><td>12/AXb : Green</td></tr> <tr><td>—</td><td>—</td></tr> <tr><td>—</td><td>—</td></tr> <tr><td>—</td><td>—</td></tr> </table>	①	11/AXc : White	②	14/AXa : Brown	③	12/AXb : Green	—	—	—	—	—	—	Can be mounted on the right side as well by purchasing a separately sold product (for right-side mounting).
①	21/AXc : Yellow																											
②	24/AXa : Red																											
③	22/AXb : Blue																											
—	—																											
—	—																											
—	—																											
①	11/AXc : White																											
②	14/AXa : Brown																											
③	12/AXb : Green																											
—	—																											
—	—																											
—	—																											
<input type="checkbox"/> W(1)*																												
Auxiliary switch x 2	Cannot be mounted.		<table border="1" style="width: 100%; border-collapse: collapse;"> <tr><td>①</td><td>11/AXc : White</td><td>⑦</td><td>21/AXc : Yellow</td></tr> <tr><td>②</td><td>14/AXa : Brown</td><td>⑧</td><td>24/AXa : Red</td></tr> <tr><td>③</td><td>12/AXb : Green</td><td>⑨</td><td>22/AXb : Blue</td></tr> <tr><td>—</td><td>—</td><td>—</td><td>—</td></tr> <tr><td>—</td><td>—</td><td>—</td><td>—</td></tr> <tr><td>—</td><td>—</td><td>—</td><td>—</td></tr> </table>	①	11/AXc : White	⑦	21/AXc : Yellow	②	14/AXa : Brown	⑧	24/AXa : Red	③	12/AXb : Green	⑨	22/AXb : Blue	—	—	—	—	—	—	—	—	—	—	—	—	
①	11/AXc : White	⑦	21/AXc : Yellow																									
②	14/AXa : Brown	⑧	24/AXa : Red																									
③	12/AXb : Green	⑨	22/AXb : Blue																									
—	—	—	—																									
—	—	—	—																									
—	—	—	—																									
<input type="checkbox"/> V(2)*																												
Alarm switch	Cannot be pulled out to the left side.	<table border="1" style="width: 100%; border-collapse: collapse;"> <tr><td>①</td><td>01/ALc : Yellow</td></tr> <tr><td>②</td><td>04/ALa : Red</td></tr> <tr><td>③</td><td>02/ALb : Blue</td></tr> <tr><td>—</td><td>—</td></tr> <tr><td>—</td><td>—</td></tr> <tr><td>—</td><td>—</td></tr> </table>	①	01/ALc : Yellow	②	04/ALa : Red	③	02/ALb : Blue	—	—	—	—	—	—	<table border="1" style="width: 100%; border-collapse: collapse;"> <tr><td>①</td><td>91/ALc : White</td></tr> <tr><td>②</td><td>94/ALa : Brown</td></tr> <tr><td>③</td><td>92/ALb : Green</td></tr> <tr><td>—</td><td>—</td></tr> <tr><td>—</td><td>—</td></tr> <tr><td>—</td><td>—</td></tr> </table>	①	91/ALc : White	②	94/ALa : Brown	③	92/ALb : Green	—	—	—	—	—	—	Can be mounted on the right side as well by purchasing a separately sold product (for right-side mounting).
①	01/ALc : Yellow																											
②	04/ALa : Red																											
③	02/ALb : Blue																											
—	—																											
—	—																											
—	—																											
①	91/ALc : White																											
②	94/ALa : Brown																											
③	92/ALb : Green																											
—	—																											
—	—																											
—	—																											
<input type="checkbox"/> K(8)*																												
Auxiliary switch + alarm switch	Cannot be pulled out to the left side.	<table border="1" style="width: 100%; border-collapse: collapse;"> <tr><td>①</td><td>01/ALc : Yellow</td></tr> <tr><td>②</td><td>04/ALa : Red</td></tr> <tr><td>③</td><td>02/ALb : Blue</td></tr> <tr><td>④</td><td>21/AXc : Yellow</td></tr> <tr><td>⑤</td><td>24/AXa : Red</td></tr> <tr><td>⑥</td><td>22/AXb : Blue</td></tr> </table>	①	01/ALc : Yellow	②	04/ALa : Red	③	02/ALb : Blue	④	21/AXc : Yellow	⑤	24/AXa : Red	⑥	22/AXb : Blue	<table border="1" style="width: 100%; border-collapse: collapse;"> <tr><td>①</td><td>91/ALc : White</td></tr> <tr><td>②</td><td>94/ALa : Brown</td></tr> <tr><td>③</td><td>92/ALb : Green</td></tr> <tr><td>④</td><td>11/AXc : White</td></tr> <tr><td>⑤</td><td>14/AXa : Brown</td></tr> <tr><td>⑥</td><td>12/AXb : Green</td></tr> </table>	①	91/ALc : White	②	94/ALa : Brown	③	92/ALb : Green	④	11/AXc : White	⑤	14/AXa : Brown	⑥	12/AXb : Green	Can be mounted on the right side as well by purchasing a separately sold product (for right-side mounting).
①	01/ALc : Yellow																											
②	04/ALa : Red																											
③	02/ALb : Blue																											
④	21/AXc : Yellow																											
⑤	24/AXa : Red																											
⑥	22/AXb : Blue																											
①	91/ALc : White																											
②	94/ALa : Brown																											
③	92/ALb : Green																											
④	11/AXc : White																											
⑤	14/AXa : Brown																											
⑥	12/AXb : Green																											
<input type="checkbox"/> W(1)* K(8)*																												
Auxiliary switch x 2 + alarm switch	Cannot be mounted.		<table border="1" style="width: 100%; border-collapse: collapse;"> <tr><td>①</td><td>91/ALc : White</td><td>⑦</td><td>21/AXc : Yellow</td></tr> <tr><td>②</td><td>94/ALa : Brown</td><td>⑧</td><td>24/AXa : Red</td></tr> <tr><td>③</td><td>92/ALb : Green</td><td>⑨</td><td>22/AXb : Blue</td></tr> <tr><td>④</td><td>11/AXc : White</td><td>—</td><td>—</td></tr> <tr><td>⑤</td><td>14/AXa : Brown</td><td>—</td><td>—</td></tr> <tr><td>⑥</td><td>12/AXb : Green</td><td>—</td><td>—</td></tr> </table>	①	91/ALc : White	⑦	21/AXc : Yellow	②	94/ALa : Brown	⑧	24/AXa : Red	③	92/ALb : Green	⑨	22/AXb : Blue	④	11/AXc : White	—	—	⑤	14/AXa : Brown	—	—	⑥	12/AXb : Green	—	—	
①	91/ALc : White	⑦	21/AXc : Yellow																									
②	94/ALa : Brown	⑧	24/AXa : Red																									
③	92/ALb : Green	⑨	22/AXb : Blue																									
④	11/AXc : White	—	—																									
⑤	14/AXa : Brown	—	—																									
⑥	12/AXb : Green	—	—																									
<input type="checkbox"/> V(2)* K(8)*																												
Shunt trip device	Cannot be pulled out to the left side.	<table border="1" style="width: 100%; border-collapse: collapse;"> <tr><td>①</td><td>C1/S1 : White</td></tr> <tr><td>②</td><td>C2/S2 : White</td></tr> <tr><td>—</td><td>—</td></tr> <tr><td>—</td><td>—</td></tr> <tr><td>—</td><td>—</td></tr> <tr><td>—</td><td>—</td></tr> </table>	①	C1/S1 : White	②	C2/S2 : White	—	—	—	—	—	—	—	—	<table border="1" style="width: 100%; border-collapse: collapse;"> <tr><td>①</td><td>C1/S1 : White</td></tr> <tr><td>②</td><td>C2/S2 : White</td></tr> <tr><td>—</td><td>—</td></tr> <tr><td>—</td><td>—</td></tr> <tr><td>—</td><td>—</td></tr> <tr><td>—</td><td>—</td></tr> </table>	①	C1/S1 : White	②	C2/S2 : White	—	—	—	—	—	—	—	—	
①	C1/S1 : White																											
②	C2/S2 : White																											
—	—																											
—	—																											
—	—																											
—	—																											
①	C1/S1 : White																											
②	C2/S2 : White																											
—	—																											
—	—																											
—	—																											
—	—																											
<input type="checkbox"/> F <input type="checkbox"/>																												
Auxiliary switch + shunt trip device	Cannot be mounted.		<table border="1" style="width: 100%; border-collapse: collapse;"> <tr><td>①</td><td>C1/S1 : White</td><td>⑦</td><td>21/AXc : Yellow</td></tr> <tr><td>②</td><td>C2/S2 : White</td><td>⑧</td><td>24/AXa : Red</td></tr> <tr><td>—</td><td>—</td><td>⑨</td><td>22/AXb : Blue</td></tr> <tr><td>—</td><td>—</td><td>—</td><td>—</td></tr> <tr><td>—</td><td>—</td><td>—</td><td>—</td></tr> <tr><td>—</td><td>—</td><td>—</td><td>—</td></tr> </table>	①	C1/S1 : White	⑦	21/AXc : Yellow	②	C2/S2 : White	⑧	24/AXa : Red	—	—	⑨	22/AXb : Blue	—	—	—	—	—	—	—	—	—	—	—	—	
①	C1/S1 : White	⑦	21/AXc : Yellow																									
②	C2/S2 : White	⑧	24/AXa : Red																									
—	—	⑨	22/AXb : Blue																									
—	—	—	—																									
—	—	—	—																									
—	—	—	—																									
<input type="checkbox"/> W(1)* F <input type="checkbox"/>																												
Alarm switch + shunt trip device	Cannot be mounted.	<table border="1" style="width: 100%; border-collapse: collapse;"> <tr><td>①</td><td>C1/S1 : White</td></tr> <tr><td>②</td><td>C2/S2 : White</td></tr> <tr><td>—</td><td>—</td></tr> <tr><td>—</td><td>—</td></tr> <tr><td>—</td><td>—</td></tr> <tr><td>—</td><td>—</td></tr> </table>	①	C1/S1 : White	②	C2/S2 : White	—	—	—	—	—	—	—	—	<table border="1" style="width: 100%; border-collapse: collapse;"> <tr><td>⑦</td><td>01/ALc : Yellow</td></tr> <tr><td>⑧</td><td>04/ALa : Red</td></tr> <tr><td>⑨</td><td>02/ALb : Blue</td></tr> <tr><td>—</td><td>—</td></tr> <tr><td>—</td><td>—</td></tr> <tr><td>—</td><td>—</td></tr> </table>	⑦	01/ALc : Yellow	⑧	04/ALa : Red	⑨	02/ALb : Blue	—	—	—	—	—	—	
①	C1/S1 : White																											
②	C2/S2 : White																											
—	—																											
—	—																											
—	—																											
—	—																											
⑦	01/ALc : Yellow																											
⑧	04/ALa : Red																											
⑨	02/ALb : Blue																											
—	—																											
—	—																											
—	—																											
<input type="checkbox"/> K(8)* F <input type="checkbox"/>																												
Auxiliary switch + alarm switch + shunt trip device	Cannot be mounted.		<table border="1" style="width: 100%; border-collapse: collapse;"> <tr><td>①</td><td>C1/S1 : White</td><td>⑦</td><td>01/ALc : Yellow</td></tr> <tr><td>②</td><td>C2/S2 : White</td><td>⑧</td><td>04/ALa : Red</td></tr> <tr><td>—</td><td>—</td><td>⑨</td><td>02/ALb : Blue</td></tr> <tr><td>—</td><td>—</td><td>⑩</td><td>21/AXc : Yellow</td></tr> <tr><td>—</td><td>—</td><td>⑪</td><td>24/AXa : Red</td></tr> <tr><td>—</td><td>—</td><td>⑫</td><td>22/AXb : Blue</td></tr> </table>	①	C1/S1 : White	⑦	01/ALc : Yellow	②	C2/S2 : White	⑧	04/ALa : Red	—	—	⑨	02/ALb : Blue	—	—	⑩	21/AXc : Yellow	—	—	⑪	24/AXa : Red	—	—	⑫	22/AXb : Blue	
①	C1/S1 : White	⑦	01/ALc : Yellow																									
②	C2/S2 : White	⑧	04/ALa : Red																									
—	—	⑨	02/ALb : Blue																									
—	—	⑩	21/AXc : Yellow																									
—	—	⑪	24/AXa : Red																									
—	—	⑫	22/AXb : Blue																									
<input type="checkbox"/> W(1)* K(8)* F <input type="checkbox"/>																												

Note: * () code of Low level circuit

Molded Case Circuit Breakers / Earth Leakage Circuit Breakers

G-TWIN / Series

Accessories

(b) Lead wire type (ELCB)

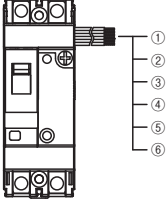
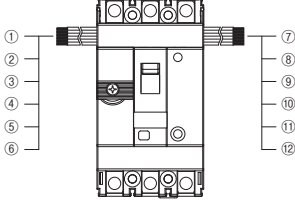
Lead wire type	ELCB (2P)				ELCB (3P)			
								
Type	EW32SBG, EW50 <input type="checkbox"/> BG, EW63 <input type="checkbox"/> BG EW50RBGU				EW32SBG, EW50 <input type="checkbox"/> BG, EW63 <input type="checkbox"/> BG EW50RBGU			
Accessory type	Left side		Right side		Left side		Right side	
	Position	Ring mark	Position	Ring mark	Position	Ring mark	Position	Ring mark
Auxiliary switch	Cannot be pulled out to the left side.		①	21/AXc : Yellow	①	11/AXc : White	Can be mounted on the right side as well by purchasing a separately sold product (for right-side mounting).	
			②	24/AXa : Red	②	14/AXa : Brown		
			③	22/AXb : Blue	③	12/AXb : Green		
			—	—	—	—		
			—	—	—	—		
			—	—	—	—		
W(1)*			—	—	—	—		
Auxiliary switch x 2	Cannot be mounted.				①	11/AXc : White	⑦	21/AXc : Yellow
					②	14/AXa : Brown	⑧	24/AXa : Red
					③	12/AXb : Green	⑨	22/AXb : Blue
					—	—	—	—
					—	—	—	—
					—	—	—	—
V(2)*					—	—	—	—
Alarm switch	Cannot be pulled out to the left side.		①	01/ALc : Yellow	①	91/ALc : White	Can be mounted on the right side as well by purchasing a separately sold product (for right-side mounting).	
			②	04/ALa : Red	②	94/ALa : Brown		
			③	02/ALb : Blue	③	92/ALb : Green		
			—	—	—	—		
			—	—	—	—		
			—	—	—	—		
K(8)*			—	—	—	—		
Auxiliary switch + alarm switch	Cannot be pulled out to the left side.		①	01/ALc : Yellow	①	91/ALc : White	Can be mounted on the right side as well by purchasing a separately sold product (for right-side mounting).	
			②	04/ALa : Red	②	94/ALa : Brown		
			③	02/ALb : Blue	③	92/ALb : Green		
			④	21/AXc : Yellow	④	11/AXc : White		
			⑤	24/AXa : Red	⑤	14/AXa : Brown		
			⑥	22/AXb : Blue	⑥	12/AXb : Green		
W(1)* K(8)*								
Auxiliary switch x 2 + alarm switch	Cannot be mounted.				①	91/ALc : White	⑦	21/AXc : Yellow
					②	94/ALa : Brown	⑧	24/AXa : Red
					③	92/ALb : Green	⑨	22/AXb : Blue
					④	11/AXc : White	—	—
					⑤	14/AXa : Brown	—	—
					⑥	12/AXb : Green	—	—
V(2)* K(8)*					—	—	—	—
Shunt trip device	Cannot be mounted.				①	C1/S1 : White	—	—
					②	C2/S2 : White	—	—
					—	—	—	—
					—	—	—	—
					—	—	—	—
F <input type="checkbox"/>					—	—	—	—
Auxiliary switch + shunt trip device	Cannot be mounted.				①	C1/S1 : White	⑦	21/AXc : Yellow
					②	C2/S2 : White	⑧	24/AXa : Red
					—	—	⑨	22/AXb : Blue
					—	—	—	—
					—	—	—	—
W(1)* F <input type="checkbox"/>					—	—	—	—
Alarm switch + shunt trip device	Cannot be mounted.				①	C1/S1 : White	⑦	01/ALc : Yellow
					②	C2/S2 : White	⑧	04/ALa : Red
					—	—	⑨	02/ALb : Blue
					—	—	—	—
					—	—	—	—
K(8)* F <input type="checkbox"/>					—	—	—	—
Auxiliary switch + alarm switch + shunt trip device	Cannot be mounted.				①	C1/S1 : White	⑦	01/ALc : Yellow
					②	C2/S2 : White	⑧	04/ALa : Red
					—	—	⑨	02/ALb : Blue
					—	—	⑩	21/AXc : Yellow
					—	—	⑪	24/AXa : Red
					—	—	⑫	22/AXb : Blue
W(1)* K(8)* F <input type="checkbox"/>								

Note: * () code of Low level circuit

Molded Case Circuit Breakers / Earth Leakage Circuit Breakers G-TWIN / Series Accessories

(c) Terminal block type (MCCB)

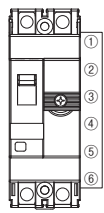
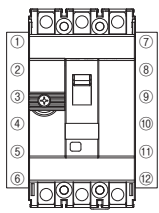
Lead wire type	MCCB (2P)	MCCB (3P)		
				
Type	BW32SBG, BW50 <input type="checkbox"/> BG, BW63 <input type="checkbox"/> BG BW50RBGU	BW32SBG, BW50 <input type="checkbox"/> BG, BW63 <input type="checkbox"/> BG BW50RBGU		
Accessory type	Left side	Right side	Left side	Right side
	Position Ring mark	Position Ring mark	Position Ring mark	Position Ring mark
Auxiliary switch	Cannot be mounted.	① — ② — ③ — ④ 21/AXcR ⑤ 22/AXbR ⑥ 24/AXaR	① — ② — ③ — ④ 11/AXcL ⑤ 12/AXbL ⑥ 14/AXaL	Can be mounted on the right side as well by purchasing a separately sold product (for right-side mounting).
<input type="checkbox"/> W(1)* A				
Auxiliary switch x 2	Cannot be mounted.		① — ② — ③ — ④ 11/AXcL ⑤ 12/AXbL ⑥ 14/AXaL	⑦ — ⑧ — ⑨ — ⑩ 21/AXcR ⑪ 22/AXbR ⑫ 24/AXaR
<input type="checkbox"/> V(2)* A				
Alarm switch	Cannot be mounted.	① 04/ALaR ② 02/ALbR ③ 01/ALcR ④ — ⑤ — ⑥ —	① 94/ALaL ② 92/ALbL ③ 91/ALcL ④ — ⑤ — ⑥ —	Can be mounted on the right side as well by purchasing a separately sold product (for right-side mounting).
<input type="checkbox"/> K(8)* A				
Auxiliary switch + alarm switch	Cannot be mounted.	① 04/ALaR ② 02/ALbR ③ 01/ALcR ④ 21/AXcR ⑤ 22/AXbR ⑥ 24/AXaR	① 94/ALaL ② 92/ALbL ③ 91/ALcL ④ 11/AXcL ⑤ 12/AXbL ⑥ 14/AXaL	Can be mounted on the right side as well by purchasing a separately sold product (for right-side mounting).
<input type="checkbox"/> W(1)* K(8)* A				
Auxiliary switch x 2 + alarm switch	Cannot be mounted.		① 94/ALaL ② 92/ALbL ③ 91/ALcL ④ 11/AXcL ⑤ 12/AXbL ⑥ 14/AXaL	⑦ — ⑧ — ⑨ — ⑩ 21/AXcR ⑪ 22/AXbR ⑫ 24/AXaR
<input type="checkbox"/> V(2)* K(8)* A				
Shunt trip device	Cannot be mounted.	① — ② — ③ — ④ C2/S2 ⑤ — ⑥ C1/S1	① — ② — ③ — ④ C2/S2 ⑤ — ⑥ C1/S1	Cannot be mounted.
<input type="checkbox"/> F <input type="checkbox"/> A				
Auxiliary switch + shunt trip device	Cannot be mounted.		① — ② — ③ — ④ C2/S2 ⑤ — ⑥ C1/S1	⑦ — ⑧ — ⑨ — ⑩ 21/AXcR ⑪ 22/AXbR ⑫ 24/AXaR
<input type="checkbox"/> W(1)* F <input type="checkbox"/> A				
Alarm switch + shunt trip device	Cannot be mounted.		① — ② — ③ — ④ C2/S2 ⑤ — ⑥ C1/S1	⑦ 04/ALaR ⑧ 02/ALbR ⑨ 01/ALcR ⑩ — ⑪ — ⑫ —
<input type="checkbox"/> K(8)* F <input type="checkbox"/> A				

Molded Case Circuit Breakers / Earth Leakage Circuit Breakers

G-TWIN / Series

Accessories

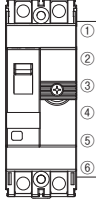
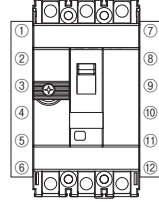
Lead wire type	MCCB (2P)				MCCB (3P)			
								
Type	BW32SBG, BW50 <input type="checkbox"/> BG, BW63 <input type="checkbox"/> BG BW50RBGU				BW32SBG, BW50 <input type="checkbox"/> BG, BW63 <input type="checkbox"/> BG BW50RBGU			
Accessory type	Left side		Right side		Left side		Right side	
	Position	Ring mark	Position	Ring mark	Position	Ring mark	Position	Ring mark
Auxiliary switch + alarm switch + shunt trip device <input type="checkbox"/> W(1)* <input type="checkbox"/> K (8)* <input type="checkbox"/> F <input type="checkbox"/> A	Cannot be mounted.				①	—	⑦	04/ALaR
Undervoltage trip device <input type="checkbox"/> R	Cannot be mounted.				②	—	⑧	02/ALbR
					③	—	⑨	01/ALcR
					④	C2/S2	⑩	21/AXcR
					⑤	—	⑪	22/AXbR
					⑥	C1/S1	⑫	24/AXaR
					①	—	Cannot be mounted.	
Auxiliary switch + Undervoltage trip device <input type="checkbox"/> W(1)* <input type="checkbox"/> R <input type="checkbox"/> A	Cannot be mounted.				②	—	⑦	—
					③	—	⑧	—
					④	D2/P2	⑨	—
					⑤	—	⑩	21/AXcR
					⑥	D1/P1	⑪	22/AXbR
					⑦	—	⑫	24/AXaR
Alarm switch + Undervoltage trip device <input type="checkbox"/> K(8)* <input type="checkbox"/> R <input type="checkbox"/> A	Cannot be mounted.				①	—	⑦	04/ALaR
					②	—	⑧	02/ALbR
					③	—	⑨	01/ALcR
					④	D2/P2	⑩	—
					⑤	—	⑪	—
					⑥	D1/P1	⑫	—
Auxiliary switch + alarm switch + Undervoltage trip device <input type="checkbox"/> W(1)* <input type="checkbox"/> K(8)* <input type="checkbox"/> R <input type="checkbox"/> A	Cannot be mounted.				①	—	⑦	04/ALaR
					②	—	⑧	02/ALbR
					③	—	⑨	01/ALcR
					④	D2/P2	⑩	21/AXcR
					⑤	—	⑪	22/AXbR
					⑥	D1/P1	⑫	24/AXaR

Note: * () code of Low level circuit

Remarks

1) The undervoltage trip device is factory-mounted when the product is shipped. Specify in the order for the main unit.

Molded Case Circuit Breakers / Earth Leakage Circuit Breakers

G-TWIN / Series

Accessories

(d) Terminal block type (ELCB)

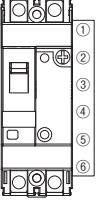
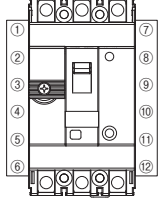
Lead wire type	ELCB (2P)	ELCB (3P)		
				
Type	EW32SBG, EW50 <input type="checkbox"/> BG, EW63 <input type="checkbox"/> BG EW50RBGU	EW32SBG, EW50 <input type="checkbox"/> BG, EW63 <input type="checkbox"/> BG EW50RBGU		
Accessory type	Left side	Right side	Left side	Right side
	Position Ring mark	Position Ring mark	Position Ring mark	Position Ring mark
Auxiliary switch	Cannot be mounted.	① — ② — ③ — ④ 21/AXcR ⑤ 22/AXbR ⑥ 24/AXaR	① — ② — ③ — ④ 11/AXcL ⑤ 12/AXbL ⑥ 14/AXaL	Can be mounted on the right side as well by purchasing a separately sold product (for right-side mounting).
<input type="checkbox"/> W(1)* A				
Auxiliary switch x 2	Cannot be mounted.		① — ② — ③ — ④ 11/AXcL ⑤ 12/AXbL ⑥ 14/AXaL	⑦ — ⑧ — ⑨ — ⑩ 21/AXcR ⑪ 22/AXbR ⑫ 24/AXaR
<input type="checkbox"/> V(2)* A				
Alarm switch	Cannot be mounted.	① 04/ALaR ② 02/ALbR ③ 01/ALcR ④ — ⑤ — ⑥ —	① 94/ALaL ② 92/ALbL ③ 91/ALcL ④ — ⑤ — ⑥ —	Can be mounted on the right side as well by purchasing a separately sold product (for right-side mounting).
<input type="checkbox"/> K(8)* A				
Auxiliary switch + alarm switch	Cannot be mounted.	① 04/ALaR ② 02/ALbR ③ 01/ALcR ④ 21/AXcR ⑤ 22/AXbR ⑥ 24/AXaR	① 94/ALaL ② 92/ALbL ③ 91/ALcL ④ 11/AXcL ⑤ 12/AXbL ⑥ 14/AXaL	Can be mounted on the right side as well by purchasing a separately sold product (for right-side mounting).
<input type="checkbox"/> W(1)* K(8)* A				
Auxiliary switch x 2 + alarm switch	Cannot be mounted.		① 94/ALaL ② 92/ALbL ③ 91/ALcL ④ 11/AXcL ⑤ 12/AXbL ⑥ 14/AXaL	⑦ — ⑧ — ⑨ — ⑩ 21/AXcR ⑪ 22/AXbR ⑫ 24/AXaR
<input type="checkbox"/> V(2)* K(8)* A				
Shunt trip device	Cannot be mounted.		① — ② — ③ — ④ C2/S2 ⑤ — ⑥ C1/S1	Cannot be mounted.
<input type="checkbox"/> F <input type="checkbox"/> A				
Auxiliary switch + shunt trip device	Cannot be mounted.		① — ② — ③ — ④ C2/S2 ⑤ — ⑥ C1/S1	⑦ — ⑧ — ⑨ — ⑩ 21/AXcR ⑪ 22/AXbR ⑫ 24/AXaR
<input type="checkbox"/> W(1)* F <input type="checkbox"/> A				
Auxiliary switch + shunt trip device	Cannot be mounted.		① — ② — ③ — ④ C2/S2 ⑤ — ⑥ C1/S1	⑦ 04/ALaR ⑧ 02/ALbR ⑨ 01/ALcR ⑩ — ⑪ — ⑫ —
<input type="checkbox"/> K(8)* F <input type="checkbox"/> A				
Auxiliary switch + alarm switch + shunt trip device	Cannot be mounted.		① — ② — ③ — ④ C2/S2 ⑤ — ⑥ C1/S1	⑦ 04/ALaR ⑧ 02/ALbR ⑨ 01/ALcR ⑩ 21/AXcR ⑪ 22/AXbR ⑫ 24/AXaR
<input type="checkbox"/> W(1)* K(8)* F <input type="checkbox"/> A				

Molded Case Circuit Breakers / Earth Leakage Circuit Breakers

G-TWIN / Series

Accessories

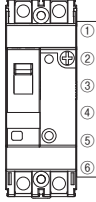
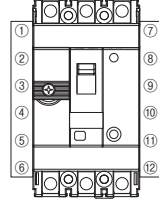
Lead wire type	ELCB (2P)				ELCB (3P)			
								
Type	EW32SBG, EW50 <input type="checkbox"/> BG, EW63 <input type="checkbox"/> BG EW50RBGU				EW32SBG, EW50 <input type="checkbox"/> BG, EW63 <input type="checkbox"/> BG EW50RBGU			
Accessory type	Left side		Right side		Left side		Right side	
	Position	Ring mark	Position	Ring mark	Position	Ring mark	Position	Ring mark
Undervoltage trip device	Cannot be mounted.				①	—	Cannot be mounted.	
<input type="checkbox"/> R					②	—		
Auxiliary switch + Undervoltage trip device	Cannot be mounted.				③	—		
<input type="checkbox"/> W(1)* R <input type="checkbox"/> A					④	D2/P2		
Alarm switch + Undervoltage trip device	Cannot be mounted.				⑤	—		
<input type="checkbox"/> K(8)* R <input type="checkbox"/> A					⑥	D1/P1		
Auxiliary switch + alarm switch + Undervoltage trip device	Cannot be mounted.				①	—	⑦	—
<input type="checkbox"/> W(1)* K(8)* R <input type="checkbox"/> A					②	—	⑧	—
Trip lead	Cannot be mounted.		①	TL1	Cannot be mounted.		⑨	—
<input type="checkbox"/> T			②	—			⑩	—
Auxiliary switch + trip lead	Cannot be mounted.		③	TL2			⑪	—
<input type="checkbox"/> W(1)* T A			④	—			⑫	—
Alarm switch + trip lead	Cannot be mounted.		⑤	—	①	94/ALaL	⑦	TL1
<input type="checkbox"/> K(8)* T A			⑥	—	②	92/ALbL	⑧	—
Auxiliary switch + alarm switch + trip lead	Cannot be mounted.				③	91/ALcL	⑨	TL2
<input type="checkbox"/> W(1)* K(8)* T A					④	—	⑩	—
					⑤	—	⑪	—
					⑥	—	⑫	—
					⑦	11/AXcL	⑩	—
					⑧	12/AXbL	⑪	—
					⑨	14/AXaL	⑫	—
					⑩	—	⑦	TL1
					⑪	—	⑧	—
					⑫	—	⑨	TL2
					①	94/ALaL	⑩	—
					②	92/ALbL	⑪	—
					③	91/ALcL	⑫	—
					④	11/AXcL	①	94/ALaL
					⑤	12/AXbL	②	92/ALbL
					⑥	14/AXaL	③	91/ALcL
					⑦	—	④	11/AXcL
					⑧	—	⑤	12/AXbL
					⑨	—	⑥	14/AXaL
					⑩	—	⑦	—
					⑪	—	⑧	—
					⑫	—	⑨	—

Note: * () code of Low level circuit

Remarks

1) The undervoltage trip device is factory-mounted when the product is shipped. Specify in the order for the main unit.

2) The trip lead cannot be mounted on the global product (EW50RBGU).

3) The trip lead is factory-mounted when the product is shipped. Specify in the order for the main unit.

Molded Case Circuit Breakers / Earth Leakage Circuit Breakers G-TWIN / Series Accessories

(4) Operations and ratings of auxiliary and alarm switches [IEC 60947-5-1, JIS C 8201-5-1]

(a) Operations of auxiliary and alarm switches

Type of switches		State of MCCB/ELCB		
		ON	OFF	Tripped
Auxiliary switch	For left side			
	For right side			
Alarm switch	For left side			
	For right side			

(b) Ratings of auxiliary and alarm switches

	IEC60947-5-1			Reference: NECA C4505		Minimum load
	Voltage [V]	Switching current [A]		Voltage [V]	Switching current [A] Resistive load	
		AC15	DC13			
Standard type	125V AC	5	–	125V AC	5	5V DC 160mA 30V DC 30mA
	250V AC	5	–	250V AC	3	
	–	–	–	30V DC	4	
	125V DC	–	0.6	125V DC	0.4	
	250V DC	–	0.3	250V DC	0.2	
Microload	–	–	–	30V DC	0.1	5V DC 1mA

(5) Shunt trip device

● Ratings of shunt trip device

Main unit applicable type (basic designation)		Mounting position	AC		DC		Voltage rating	Product code	Time rating	Operating time [ms]
			Voltage [V]	Input [VA]	Voltage [V]	Input [W]				
MCCB	ELCB	Built-in	24	40	24	40	24V AC/DC	FR	Continuous (With burn-out preventive contact)	6-13
BW32	EW32		100-130 (50/60Hz)	60	100-110	60	100-130V AC/ 100-110V DC	F6		
BW50	EW50		200-240 (50/60Hz)	70	200-220	70	200-240V AC/ 200-220V DC	FK		
BW63	EW63		380-440 (50/60Hz)	70	–	–	380-440V AC	FP		

Note 1: Specify the voltage rating in the order.

Note 2: The operating range of the trip voltage of the shunt trip device is 70 to 110% of the rated operating voltage.

(6) Undervoltage trip device

● Ratings of undervoltage trip device

Main unit applicable type (basic designation)		Mounting position	AC		DC		Voltage rating	Product code
			Voltage [V]	Input [VA]	Voltage [V]	Input [W]		
MCCB	ELCB	External	–	–	24	1	24V DC	RR
BW32	EW32		24	1	100-110	2	100-110V DC	RL
BW50	EW50		100-130	3	–	–	24V AC	RZ
BW63	EW63		200-240	5	–	–	100-130V AC	R6
			380-415	8	–	–	200-240V AC	R4
			400-440	9	–	–	380-415V AC	RP
					–	–	400-440V AC	RO

Note 1: Specify the voltage rating in the order.

Note 2: The pick-up voltages of the undervoltage trip device are: Trip voltage: 70 to 35% of the rated voltage; voltage allowing closing operation: 85% to 110% of the rated voltage

(7) Accessory lead wire pull-out system

● Specifications of lead wire

Type of lead wire	Size of lead wire	Length of lead wire	Indication on lead wire
32 to 63AF	0.4mm ² (AWG22)	About 500mm	Each lead wire has a ring mark indicating a terminal symbol.

Molded Case Circuit Breakers / Earth Leakage Circuit Breakers

G-TWIN / Series

Accessories

External Accessories

(1) Variation of external accessories

The following shows various external accessories.



External operating handle (N type)
Page 29



External operating handle (V type)
Page 29



Handle locking cover (cap type: L1)
Page 29

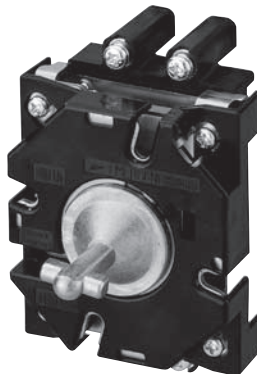

Terminal cover (long type)
Page 29



Terminal cover (short type)
Page 29



Interphase barrier
Page 29

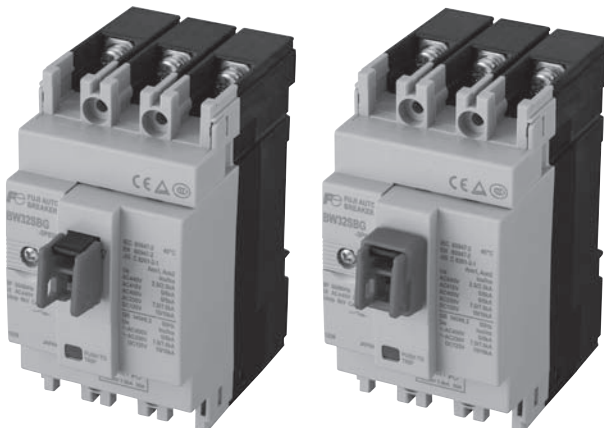





Terminal cover (short type)
Page 29

Molded Case Circuit Breakers / Earth Leakage Circuit Breakers

G-TWIN / Series

Accessories

■ List of Separately Sold Parts

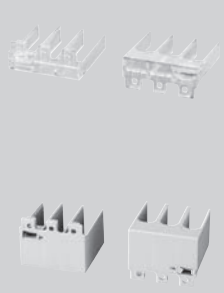
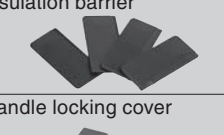
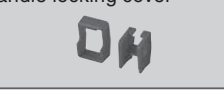
Product name	Specification	Type (i.e., product code)	Quantity/ type	
	Standard	Lead wire type left side pull-out	BW9W1SB1	1
		Lead wire type right side pull-out	BW9W1SB1-R	1
		Terminal block type left side mounting	BW9W1SB1-A	1
		Terminal block type right side mounting	BW9W1SB1-RA	1
	Low level circuit	Lead wire type left side pull-out	BW9W1DB1	1
		Lead wire type right side pull-out	BW9W1DB1-R	1
Terminal block type left side mounting		BW9W1DB1-A	1	
	Standard	Lead wire type left side pull-out	BW9K1SB1	1
		Lead wire type right side pull-out	BW9K1SB1-R	1
		Terminal block type left side mounting	BW9K1SB1-A	1
		Terminal block type right side mounting	BW9K1SB1-RA	1
	Low level circuit	Lead wire type left side pull-out	BW9K1DB1	1
		Lead wire type right side pull-out	BW9K1DB1-R	1
Terminal block type left side mounting		BW9K1DB1-A	1	
	Standard	Lead wire type left side pull-out	BW9WKS1	1
		Lead wire type right side pull-out	BW9WKS1-R	1
		Terminal block type left side mounting	BW9WKS1-A	1
		Terminal block type right side mounting	BW9WKS1-RA	1
	Low level circuit	Lead wire type left side pull-out	BW9WKDB1	1
		Lead wire type right side pull-out	BW9WKDB1-R	1
Terminal block type left side mounting		BW9WKDB1-A	1	
	24V AC/DC 100-130V AC/100-110V DC 200-240V AC/200-220V DC 380-440V AC	Lead wire type left side pull-out	BW9FRB1	1
			BW9F6B1	1
			BW9FKB1	1
			BW9FPB1	1
	24V AC/DC 100-130V AC/100-110V DC 200-240V AC/200-220V DC 380-440V AC	Terminal block type left side mounting	BW9FRB1-A	1
			BW9F6B1-A	1
		BW9FKB1-A	1	
	V type (panel mounting)	RESET-open	BW9V0BA	1
		OFF-open	BW9V0BA-G	1
		RESET-open for emergency stop	BW9V0BA-E	1
		OFF-open for emergency stop	BW9V0BA-EG	1
	N type (main unit mounting)	RESET-open	BW9N0BA	1
		OFF-open	BW9N0BA-G	1
RESET-open for emergency stop		BW9N0BA-E	1	
	Short type	Manually-detachable, 2-pole, transparent	BW9BTBA-S2	2
		Manually-detachable, 2-pole, light gray	BW9BTBA-S2W	2
		Manually-detachable, 3-pole, transparent	BW9BTBA-S3	2
		Manually-detachable, 3-pole, light gray	BW9BTBA-S3W	2
		Tool-detachable, 2-pole, transparent	BW9BTBA-S2H	2
		Tool-detachable, 2-pole, light gray	BW9BTBA-S2WH	2
		Tool-detachable, 3-pole, transparent	BW9BTBA-S3H	2
		Tool-detachable, 3-pole, light gray	BW9BTBA-S3WH	2
	Long type	Manually-detachable, 2-pole, transparent	BW9BTBA-L2	2
		Manually-detachable, 2-pole, light gray	BW9BTBA-L2W	2
		Manually-detachable, 3-pole, transparent	BW9BTBA-L3	2
		Manually-detachable, 3-pole, light gray	BW9BTBA-L3W	2
	Interphase barrier		BW9BPBA	4
	Cap type L1	-	BW9L1BA	1
		Padlock-compatible type	BW9L1BA-P	1
Handle key lock	Plate type Q2		BW9Q2BA	1

Note: See the internal accessory combinations (pages 19 to 26) to check mountability.

Molded Case Circuit Breakers / Earth Leakage Circuit Breakers

G-TWIN / Series

Data, Characteristics curves, Dimensions

■ BW32, 50, 63 □ BG (Standard Product)

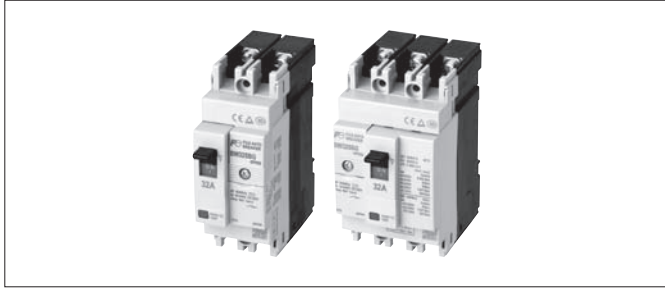

Basic type		BW32SBG		BW50EBG		BW50SBG	
Number of poles		2	3	2	3	2	3
Rated insulation voltage [V]		AC 440		440		440	
		DC 125		125		125	
Standard product	Rated breaking capacity	IEC60947-2 EN60947-2 JISC8201-2-1 Icu/Ics [kA]	AC 440V	2.5/2.5	2.5/2.5	7.5/4	
			415V	5/5	5/5	10/5	
			400V	5/5	5/5	10/5	
			380V	5/5	5/5	10/5	
			240V	7.5/7.5	7.5/7.5	15/15	
			230V	7.5/7.5	7.5/7.5	15/15	
		DC 125V	10/10	-/-	10/10		
	GB14048.2 Icu/Ics [kA]	AC 400V	5/5	5/5	10/5		
		230V	7.5/7.5	7.5/7.5	15/15		
		DC 125V	10/10	-/-	10/10		

Basic type		BW63EBG		BW63SBG	
Number of poles		2	3	2	3
Rated insulation voltage [V]		AC 440		440	
		DC 125		125	
Standard product	Rated breaking capacity	IEC60947-2 EN60947-2 JISC8201-2-1 Icu/Ics [kA]	AC 440V	2.5/2.5	7.5/4
			415V	5/5	10/5
			400V	5/5	10/5
			380V	5/5	10/5
			240V	7.5/7.5	15/15
			230V	7.5/7.5	15/15
		DC 125V	-/-	10/10	
	GB14048.2 Icu/Ics [kA]	AC 400V	5/5	10/5	
		230V	7.5/7.5	15/15	
		DC 125V	-/-	10/10	

● Optional accessories

Product name		Type symbol (i.e., symbol code)	See page:
Internal accessories	Auxiliary switch (lead wire type)	Standard	1 W 27
			2 V 27
		Low level circuit	1 1 27
			2 2 27
	Alarm switch (lead wire type)	Standard	1 K 27
		Low level circuit	1 8 27
	Shunt trip device (lead wire type)	24V AC/DC	FR 27
		100-130V AC/100-110V DC	F6 27
		200-240V AC/200-220V DC	FK 27
		380-440V AC	FP 27
	Lead wire terminal block	1 A	32
		2 A	32
	Undervoltage trip device (terminal block type only)	24V DC	RR 27
		100-110V DC	RL 27
24V AC		RZ 27	
100-130V AC		R6 27	
200-240V AC		R4 27	
380-415V AC		RP 27	
400-440V AC	RO 27		

● List of product ratings

Specification for □ : rated current (code)

Product	Basic type (i.e., product code)	Rated current	
		[A]	Code for □
Line protection use (standard products)	BW32SBG-2P□	3	003
		5	005
		10	010
		15	015
		20	020
		30	030
		32	032
		BW32SBG-3P□	3
	5		005
	10		010
	15		015
	20		020
	30		030
	32		032
	BW50EBG-2P□		3
		5	005
		10	010
		15	015
		20	020
		30	030
		32	032
		40	040
	BW50EBG-3P□	3	003
		5	005
		10	010
		15	015
		20	020
		30	030
		32	032
		40	040
	BW50SBG-2P□	3	003
		5	005
10		010	
15		015	
20		020	
30		030	
32		032	
40		040	
BW50SBG-3P□	3	003	
	5	005	
	10	010	
	15	015	
	20	020	
	30	030	
	32	032	
	40	040	
BW63EBG-2P□	60	060	
	63	063	
BW63EBG-3P□	60	060	
	63	063	
BW63SBG-2P□	60	060	
	63	063	
BW63SBG-3P□	60	060	
	63	063	

● Attached components

- Terminal screw 2P: 4 screws, 3P: 6 screws
- Interphase barrier 2P: 2 barriers, 3P: 4 barriers (provided for BW63EBG and BW63SBG only)
- Instruction Manual
 - Note 1: Mounting screws are not included. When necessary, use commercially-available screws (recommended size: M4 x 60).

Molded Case Circuit Breakers / Earth Leakage Circuit Breakers G-TWIN / Series Data, Characteristics curves, Dimensions

● Characteristic Curves

3A, 5A

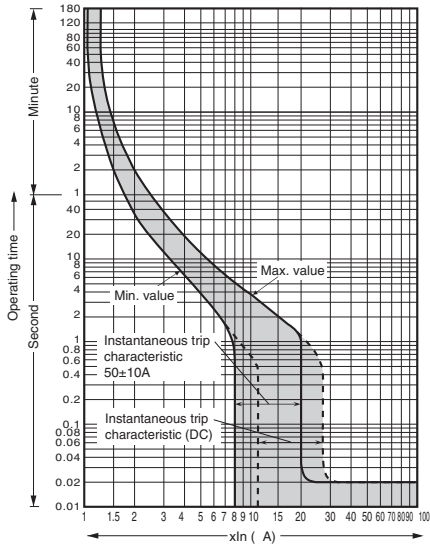

10 to 30A

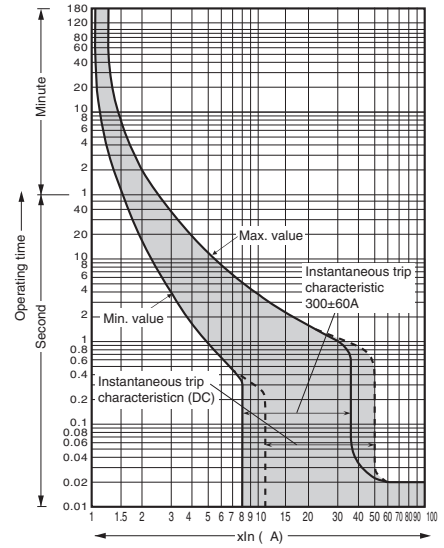

32 to 50A

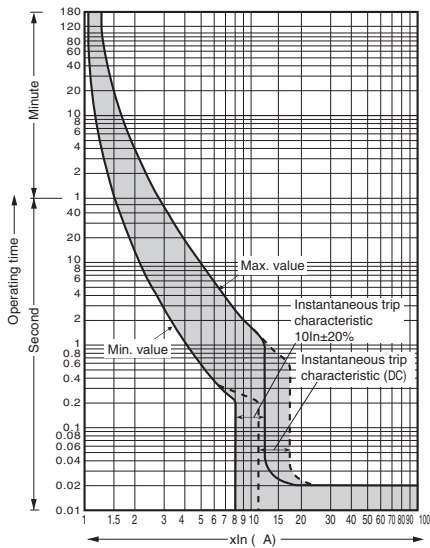

60A, 63A

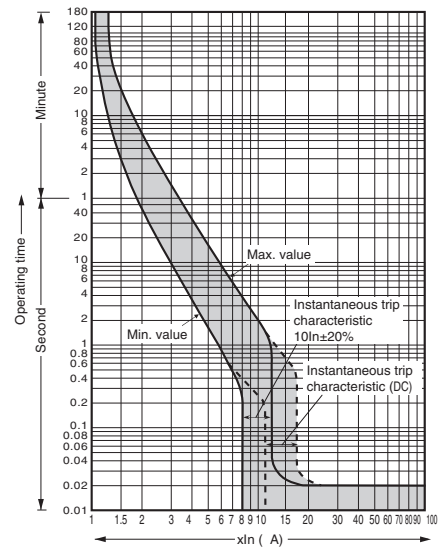

● Temperature correction curve

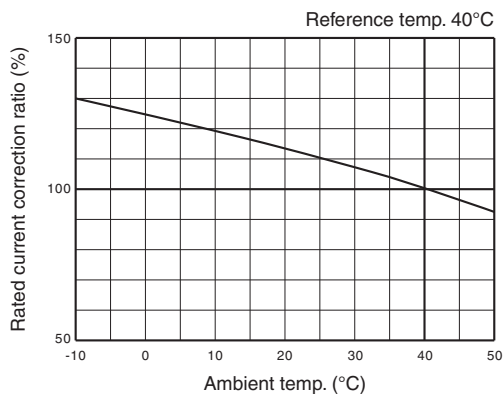

Molded Case Circuit Breakers / Earth Leakage Circuit Breakers

G-TWIN / Series

Data, Characteristics curves, Dimensions

● Dimensions, mm

Front mounting type

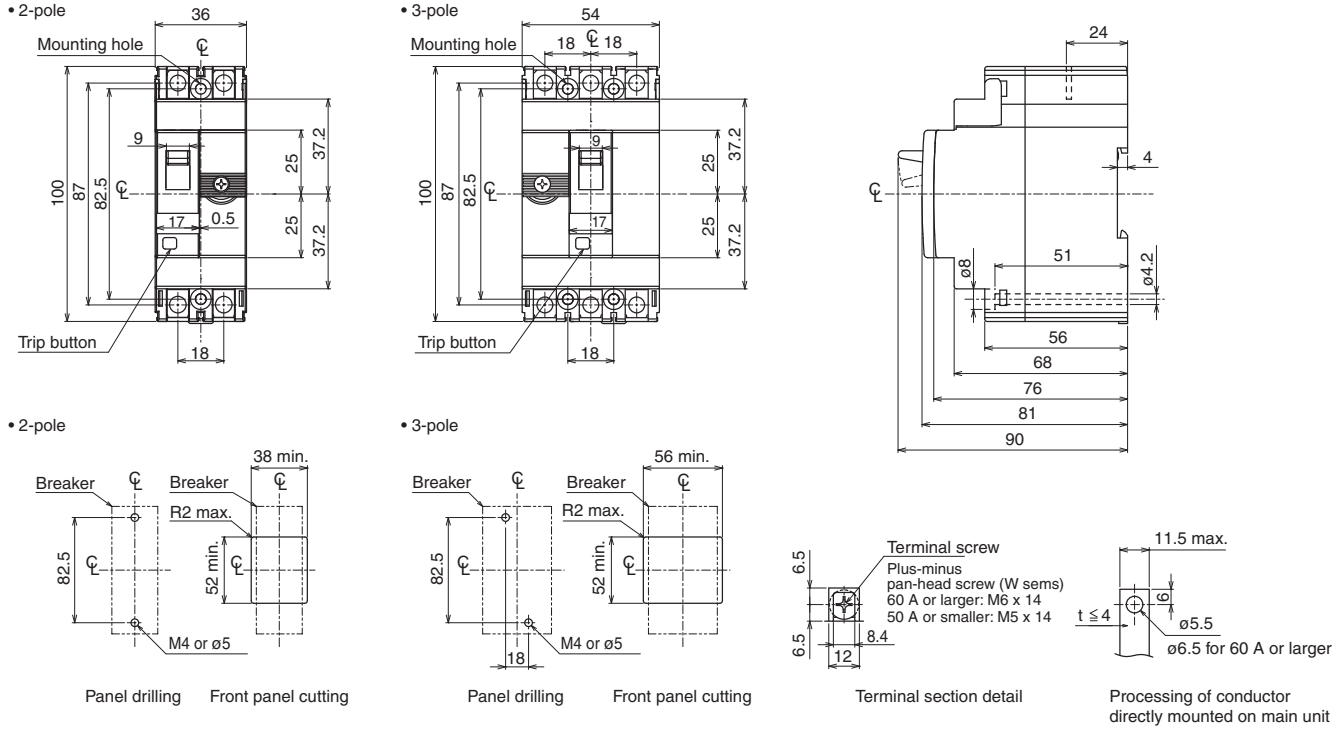

Interphase barrier

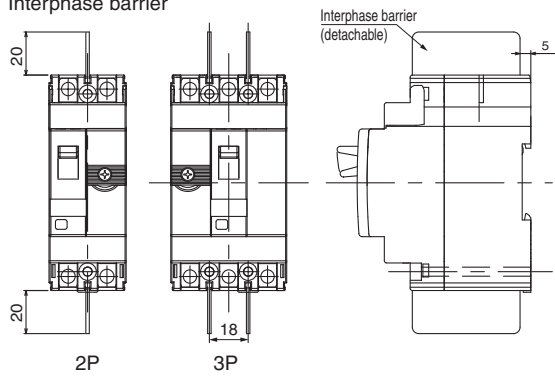

Lead wire terminal block *1*2

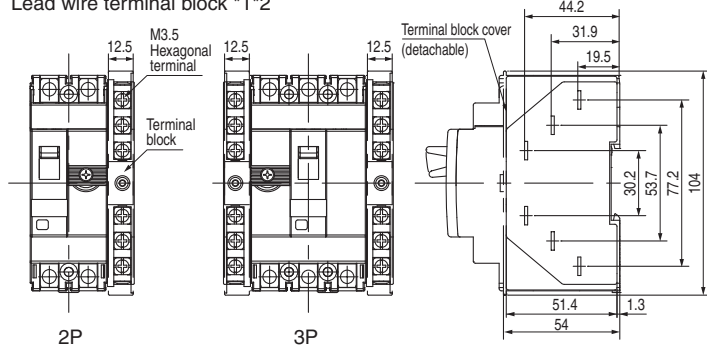

Terminal cover (short)

Terminal cover (long)

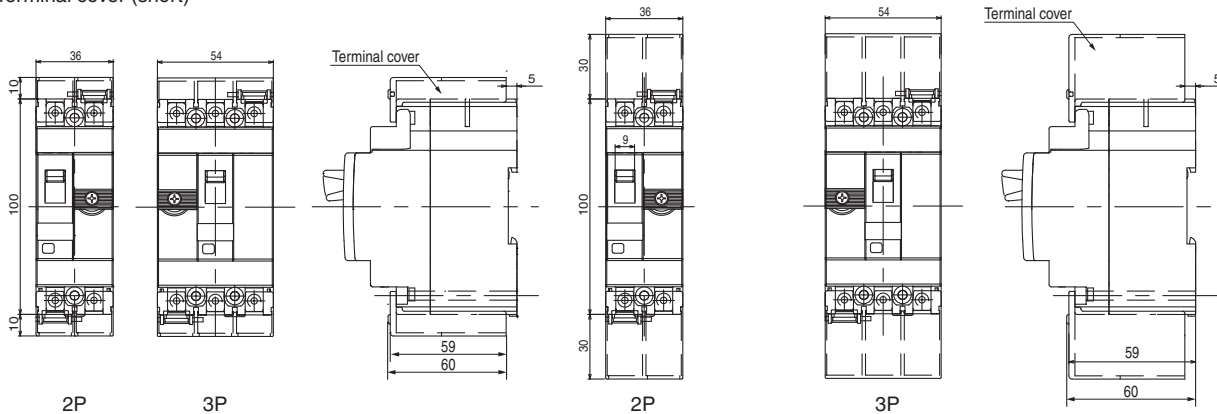

(Note *1) The terminal block is mounted on the accessory mounting side. For the accessory mounting positions, see the List of internal accessory combinations on pages 23 to 26.
 (Note *2) Connectable wire: single wire: 1 to 1.6 ϕ , stranded wire: 0.5 to 2 mm²

Molded Case Circuit Breakers / Earth Leakage Circuit Breakers G-TWIN / Series Data, Characteristics curves, Dimensions

■ BW50RBGU (Global Product)

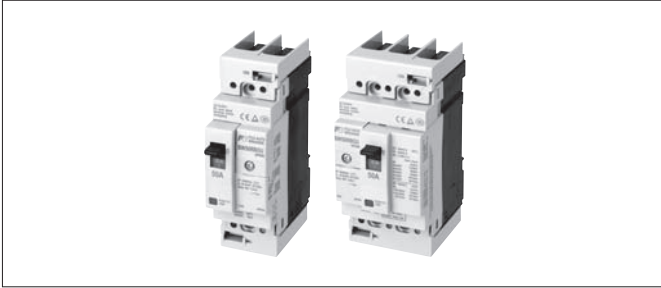

Basic type		BW50RBGU			
Number of poles		2	3		
Rated insulation voltage [V]		AC	440		
		DC	125		
Standard product	Rated breaking capacity	UL489 CAN/CSA C22.2 No.5 (kA)	AC	240V	18
			IEC60947-2 EN60947-2 JISC8201-2-1 Icu/Ics (kA)	AC	440V
				415V	10/5
				400V	10/5
				380V	10/5
				240V	15/15
				230V	15/15
		DC	125V	10/10	
		GB14048.2 Icu/Ics (kA)	AC	400V	10/5
			DC	230V	15/15
	DC	125V	10/10		

● Attached components

- Terminal cover 2
 - Terminal screw 2P: 4 screws, 3P: 6 screws
 - Instruction Manual
- Note 1: Mounting screws are not included. When necessary, use commercially-available screws (recommended size: M4 x 60).

● Optional accessories

Product name			Type symbol (i.e., symbol code)	See page:	
Internal accessories	Auxiliary switch (lead wire type)	Standard	1	W	27
			2	V	27
		Low level circuit	1	1	27
			2	2	27
	Alarm switch (lead wire type)	Standard	1	K	27
			1	8	27
		Low level circuit	1	8	27
			1	8	27
	Shunt trip device (lead wire type)	24V AC/DC		FR	27
		100-130V AC/100-110V DC		F6	27
		200-240V AC/200-220V DC		FK	27
		380-440V AC		FP	27
	Lead wire terminal block	1		A	35
		2		A	35
Undervoltage trip device (terminal block type only)	24V DC		RR	27	
	100-110V DC		RL	27	
	24V AC		RZ	27	
	100-130V AC		R6	27	
	200-240V AC		R4	27	
	380-415V AC		RP	27	
400-440V AC		RO	27		

● List of product ratings

Specification for □ : Rated current (code)

Product	Basic type	Rated current	
		[A]	Code for □
Line protection use (global product)	BW50RBGU-2P□	3	003
		5	005
		10	010
		15	015
		20	020
		30	030
		40	040
	BW50RBGU-3P□	3	003
		5	005
		10	010
		15	015
		20	020
		30	030
		40	040
	50	050	

Molded Case Circuit Breakers / Earth Leakage Circuit Breakers

G-TWIN / Series

Data, Characteristics curves, Dimensions

● Characteristic Curves

3A, 5A

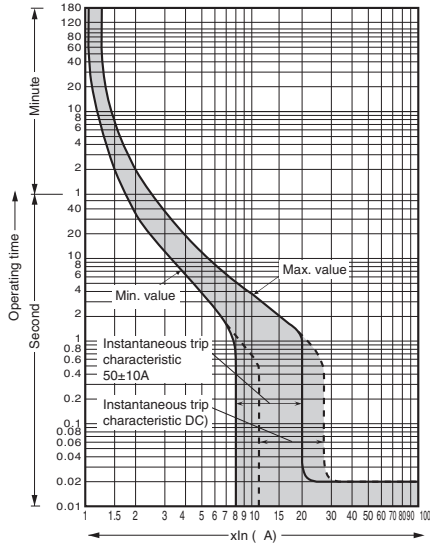

10 to 30A

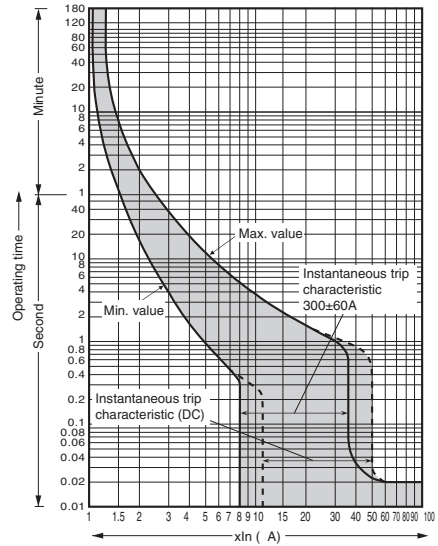

40A, 50A

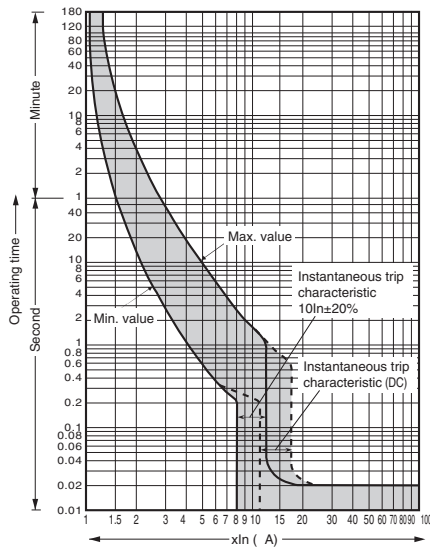

● Temperature correction curve

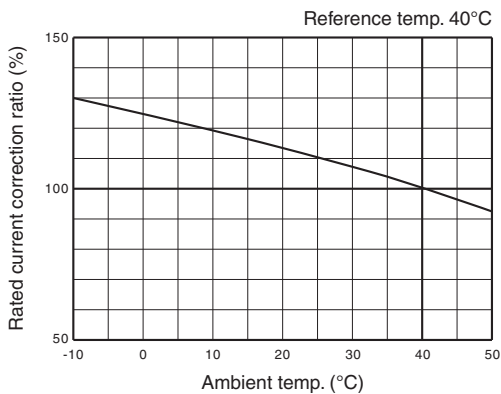

Molded Case Circuit Breakers / Earth Leakage Circuit Breakers G-TWIN / Series Data, Characteristics curves, Dimensions

● Dimensions, mm

Front mounting type

• 2-pole

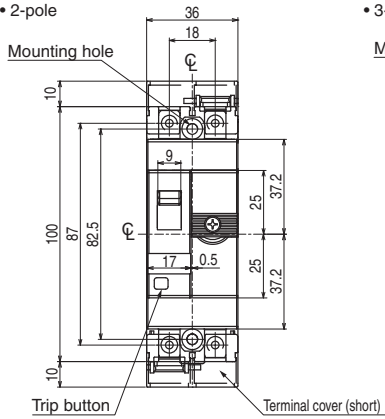

• 3-pole

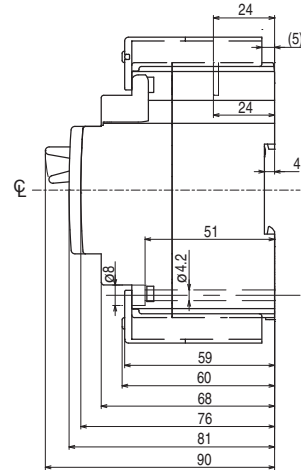
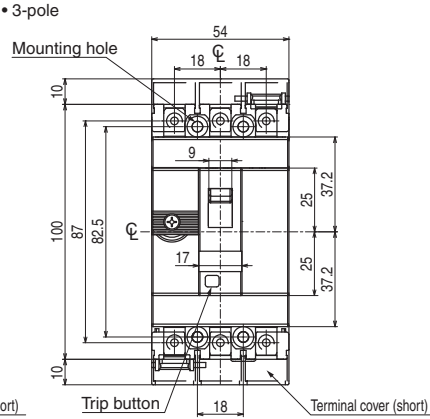

• 2-pole

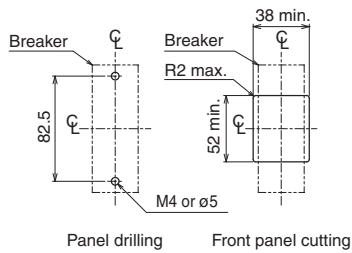

• 3-pole

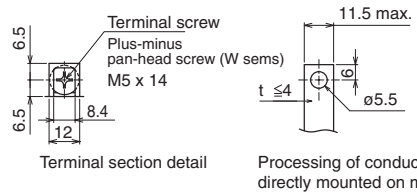
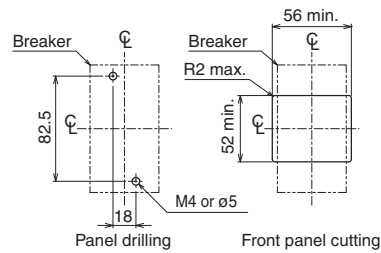

Lead wire terminal block *1*2

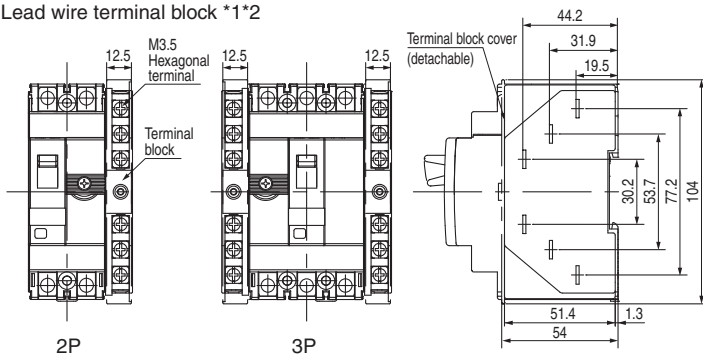

Terminal cover (long)

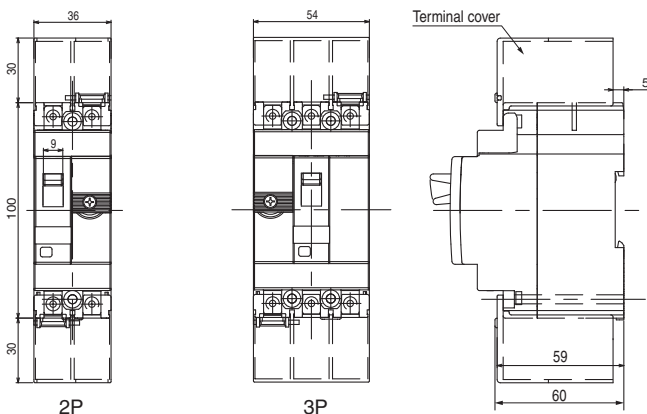

(Note *1) The terminal block is mounted on the accessory mounting side. For the accessory mounting positions, see the List of internal accessory combinations on pages 23 to 26.
(Note *2) Connectable wire: single wire: 1 to 1.6 ø, stranded wire: 0.5 to 2 mm²

Molded Case Circuit Breakers / Earth Leakage Circuit Breakers

G-TWIN / Series

Data, Characteristics curves, Dimensions

■ EW32, 50, 63 □ BG (Standard Product)



Basic type		EW32SBG		EW50EBG		EW50SBG				
Number of poles		2	3	2	3	2	3			
Rated operational voltage AC [V]		100-240	100-440	100-240	100-440	100-240	100-440			
Rated sensitive current [mA]		30	30,100,200,500	30	30,100,200,500	30	30,100,200,500			
Maximum operating time [s]		0.1		0.1		0.1				
Standard product	Rated breaking capacity IEC60947-2 EN60947-2 JISC8201-2-2 Icu/lcs [kA]	AC	440V	-/-	2.5/2.5	-/-	2.5/2.5	-/-	7.5/4	
			415V	-/-	5/5	-/-	5/5	-/-	10/5	
			400V	-/-	5/5	-/-	5/5	-/-	10/5	
			380V	-/-	5/5	-/-	5/5	-/-	10/5	
		240V	7.5/7.5	7.5/7.5	7.5/7.5	7.5/7.5	15/15	15/15		
		230V	7.5/7.5	7.5/7.5	7.5/7.5	7.5/7.5	15/15	15/15		
		100V	7.5/7.5	7.5/7.5	7.5/7.5	7.5/7.5	15/15	15/15		
		GB14048.2	AC	400V	-/-	5/5	-/-	5/5	-/-	10/5
				230V	7.5/7.5	7.5/7.5	7.5/7.5	7.5/7.5	15/15	15/15

Basic type		EW63EBG		EW63SBG				
Number of poles		2	3	2	3			
Rated operational voltage AC [V]		100-240	100-440	100-240	100-440			
Rated sensitive current [mA]		30	30,100,200,500	30	30,100,200,500			
Maximum operating time [s]		0.1		0.1				
Standard product	Rated breaking capacity IEC60947-2 EN60947-2 JISC8201-2-2 Icu/lcs [kA]	AC	440V	-/-	2.5/2.5	-/-	7.5/4	
			415V	-/-	5/5	-/-	10/5	
			400V	-/-	5/5	-/-	10/5	
			380V	-/-	5/5	-/-	10/5	
		240V	7.5/7.5	7.5/7.5	15/15	15/15		
		230V	7.5/7.5	7.5/7.5	15/15	15/15		
		100V	7.5/7.5	7.5/7.5	15/15	15/15		
		GB14048.2	AC	400V	-/-	5/5	-/-	10/5
				230V	7.5/7.5	7.5/7.5	15/15	15/15

● Optional accessories

Product name			Type symbol (i.e., symbol code)	See page:	
Internal accessories	Auxiliary switch (lead wire type)	Standard	1	W	27
			2	V	27
		Low level circuit	1	1	27
			2	2	27
	Alarm switch (lead wire type)	Standard	1	K	27
		Low level circuit	1	8	27
	Shunt trip device (lead wire type)	24V AC/DC		FR	27
		100-130V AC/100-110V DC		F6	27
		200-240V AC/200-220V DC		FK	27
		380-440V AC		FP	27
	Lead wire terminal block		1	A	38
			2	A	38
	Undervoltage trip device (terminal block type only)	24V DC		RR	27
		100-110V DC		RL	27
24V AC			RZ	27	
100-130V AC			R6	27	
200-240V AC			R4	27	
380-415V			RP	27	
	AC400-440V		RO	27	
Trip lead (terminal block type only)			T	27	

● List of product ratings

Specification for □ : Rated current (code)

Specification for ■ : Rated sensitive current (code)

Product	Basic type (i.e., product code)	Rated current		Rated sensitive current	
		[A]	Code for □	[mA]	Code for ■
Line protection use (standard products)	EW32SBG-2P□■	5	005	30	B
		10	010		
		15	015		
		20	020		
		30	030		
		32	032		
	EW32SBG-3P□■	5	005	30	B
		10	010	100	C
		15	015	200	E
		20	020	500	H
		30	030		
		32	032		
EW50EBG-2P□■	5	005	30	B	
	10	010			
	15	015			
	20	020			
	30	030			
	32	032			
	40	040			
	50	050			
	EW50EBG-3P□■	5	005	30	B
		10	010	100	C
15		015	200	E	
20		020	500	H	
30		030			
32		032			
EW50SBG-2P□■	5	005	30	B	
	10	010			
	15	015			
	20	020			
	30	030			
	32	032			
	40	040			
	50	050			
	EW50SBG-3P□■	5	005	30	B
		10	010	100	C
15		015	200	E	
20		020	500	H	
30		030			
32		032			
EW63EBG-2P□■	60	060	30	B	
	63	063			
EW63EBG-3P□■	60	060	30	B	
	63	063	100	C	
			200	E	
EW63SBG-2P□■	60	060	30	B	
	63	063			
			500	H	
EW63SBG-3P□■	60	060	30	B	
	63	063	100	C	
		200	E		
		500	H		

● Attached components

- Terminal screw 2P: 2 screws, 3P: 4 screws
- Interphase barrier 2P: 2 barriers, 3P: 4 barriers
(provided for EW63EBG and EW63SBG only)
- Instruction Manual

Note 1: Mounting screws are not included. When necessary, use commercially-available screws (recommended size: M4 x 60).

Molded Case Circuit Breakers / Earth Leakage Circuit Breakers G-TWIN / Series Data, Characteristics curves, Dimensions

● Characteristic Curves

5A

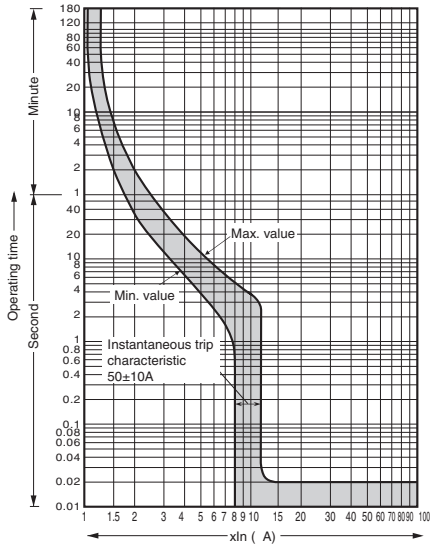

10 to 30A

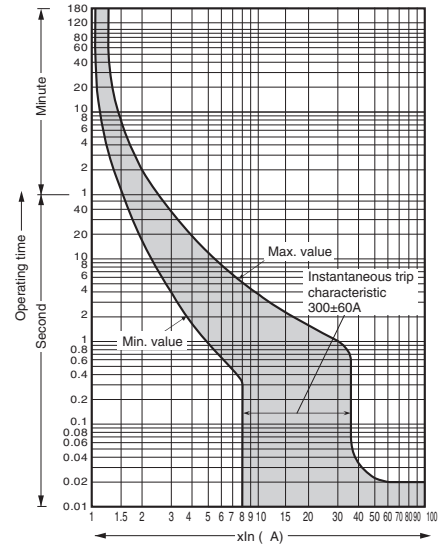

32 to 50A

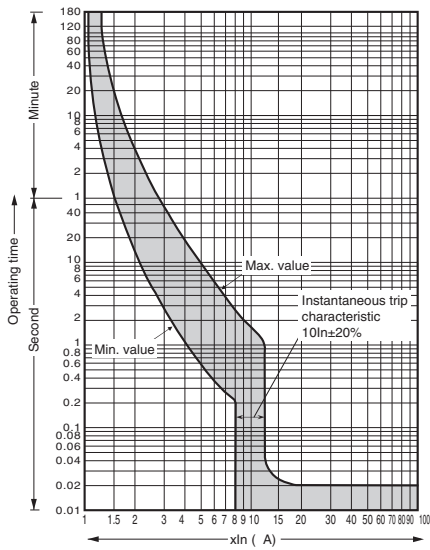

60A, 63A

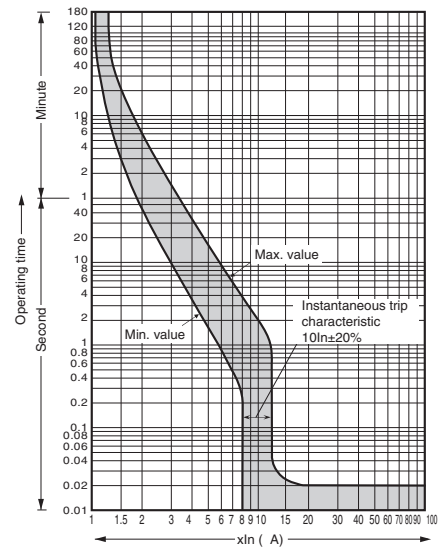

● Temperature correction curve

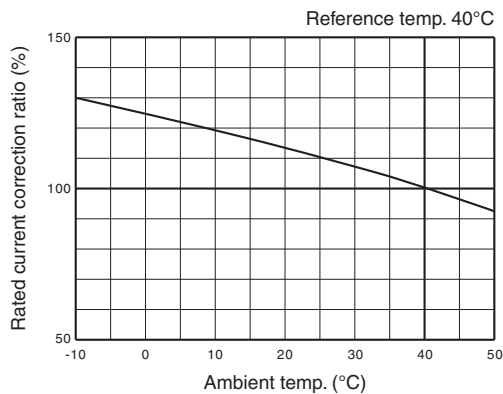

● Earth leakage tripping

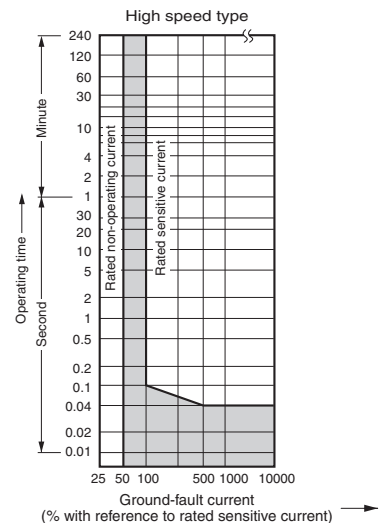

Molded Case Circuit Breakers / Earth Leakage Circuit Breakers

G-TWIN / Series

Data, Characteristics curves, Dimensions

● Dimensions, mm

Front mounting type

• 2-pole

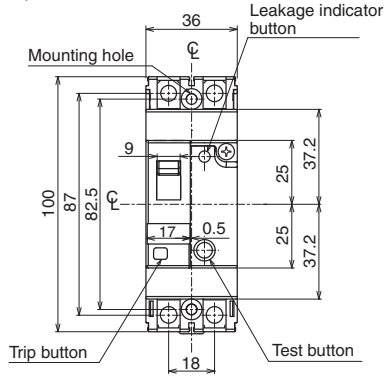

• 3-pole

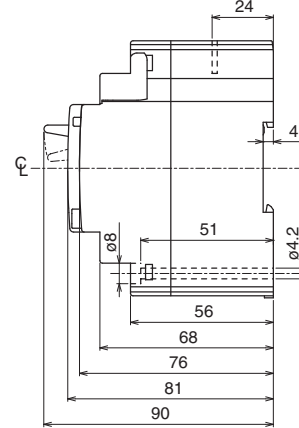
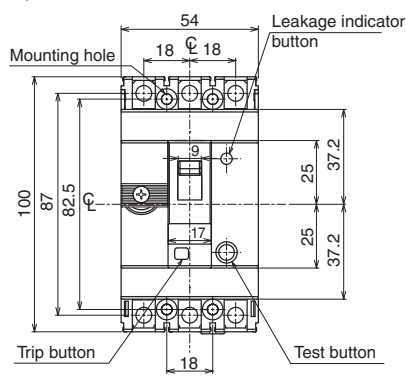

• 2-pole

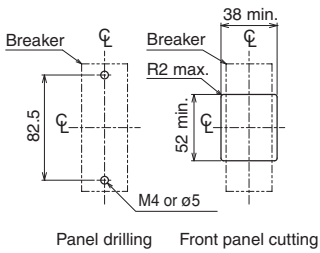

• 3-pole

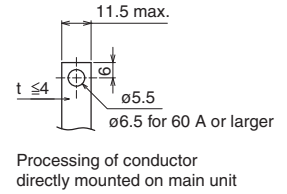
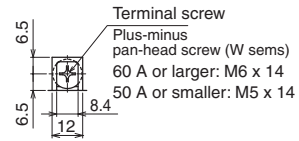
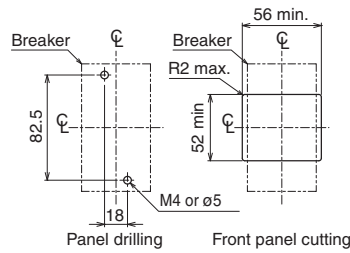

Interphase barrier

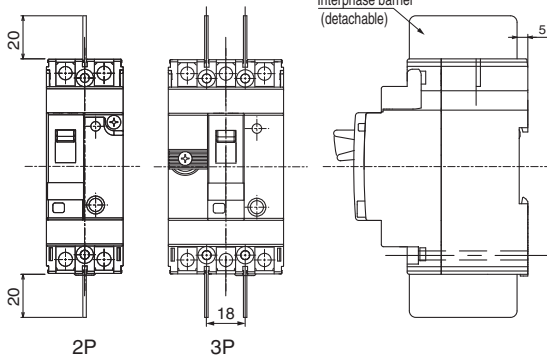

Lead wire terminal block *1*2

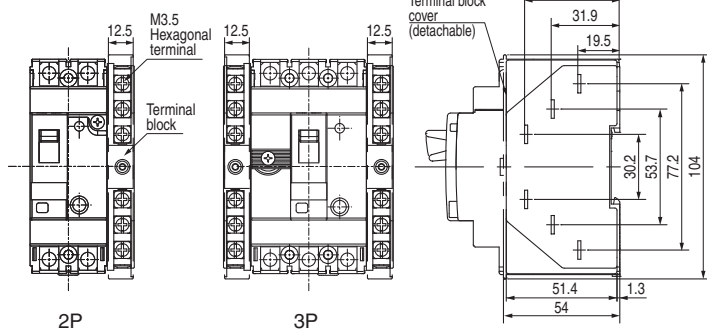

Terminal cover (short)

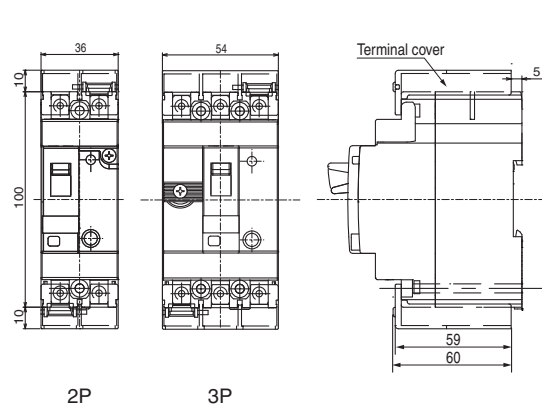

Terminal cover (long)

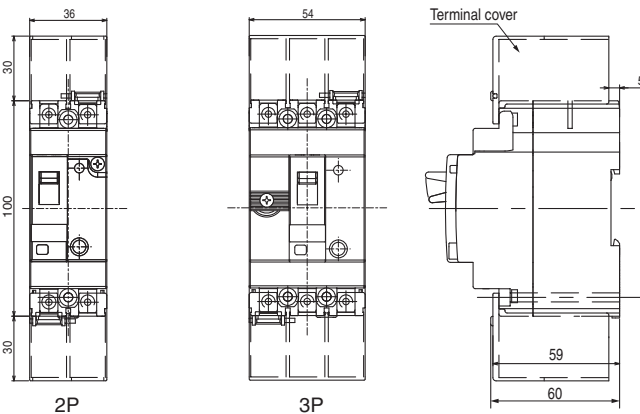

(Note *1) The terminal block is mounted on the accessory mounting side. For the accessory mounting positions, see the List of internal accessory combinations on pages 23 to 26.
 (Note *2) Connectable wire: single wire: 1 to 1.6 ϕ , stranded wire: 0.5 to 2 mm^2

Molded Case Circuit Breakers / Earth Leakage Circuit Breakers

G-TWIN / Series

Data, Characteristics curves, Dimensions

■ EW50RBGU (Global Product)



Basic type		EW50RBGU				
Number of poles		2		3		
Rated operational voltage AC [V]		IEC	100-240	100-440		
		UL	240	240		
Rated sensitive current [mA]		30		30, 50, 100, 200, 500		
Maximum operating time [s]		0.1				
Global product	Rated breaking capacity	UL489 CAN/CSA C22.2 No.5 [kA]	AC	240V	18	18
			IEC60947-2 EN60947-2 JISC8201-2-2 Icu/Ics [kA]	AC	440V	-/-
		415V			-/-	10/5
		400V		-/-	10/5	
				380V	-/-	10/5
		240V		15/15	15/15	
				230V	15/15	15/15
				100V	15/15	15/15
		GB14048.2 Icu/Ics [kA]		AC	400V	-/-
			230V		15/15	15/15

● List of product ratings

Specification for □ : Rated current (code)

Specification for ■ : Rated sensitive current (code)

Product	Basic type	Rated current		Rated sensitive current	
		[A]	Code for □	[mA]	Code for ■
Line protection use (global product)	EW50SBGU-2P □ ■	5	005	30	B
		10	010		
		15	015		
		20	020		
		30	030		
	EW50SBGU-3P □ ■	5	005	30	B
		10	010		
		15	015		
		20	020		
		30	030		
		40	040	500	H
		50	050		
		40	040		
		50	050		
		50	050		

● Attached components

- Terminal cover 2
- Terminal screw 2P: 4 screws, 3P: 6 screws
- Instruction Manual

● Optional accessories

Product name			Type symbol (i.e., symbol code)	See page:	
Internal accessories	Auxiliary switch (lead wire type)	Standard	1	W	27
			2	V	27
		Low level circuit	1	1	27
			2	2	27
	Alarm switch (lead wire type)	Standard	1	K	27
		Low level circuit	1	8	27
	Shunt trip device (lead wire type)	24V AC/DC		FR	27
		100-130V AC/100-110V DC		F6	27
		200-240V AC/200-220V DC		FK	27
		380-440V AC		FP	27
	Lead wire terminal block	1		A	41
		2		A	41
	Undervoltage trip device (terminal block type only)	24V DC		RR	27
		100-110V DC		RL	27
24V AC		RZ	27		
100-130V AC		R6	27		
200-240V AC		R4	27		
380-415V AC		RP	27		
400-440V AC		RO	27		

Molded Case Circuit Breakers / Earth Leakage Circuit Breakers

G-TWIN / Series

Data, Characteristics curves, Dimensions

● Characteristic Curves

5A

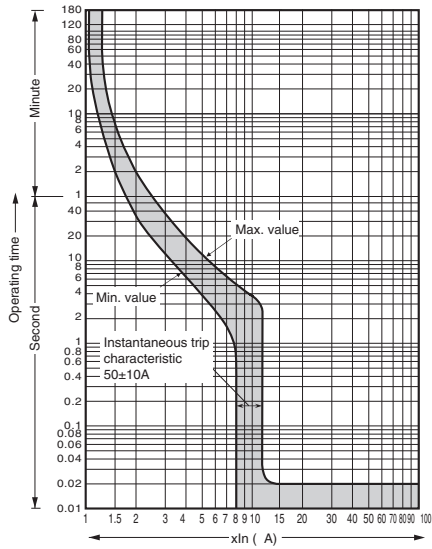

10 to 30A

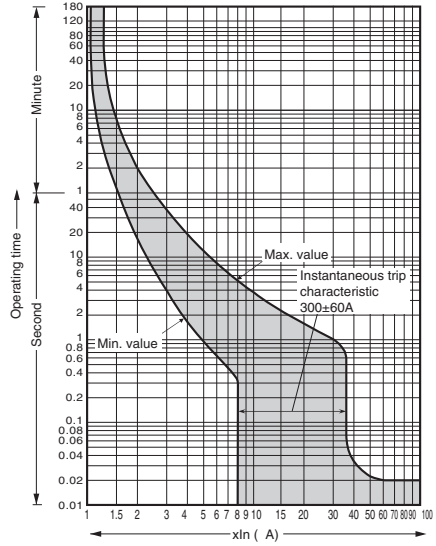

40A, 50A

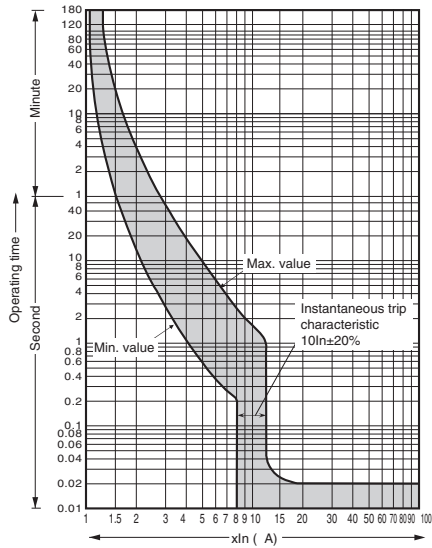

● Temperature correction curve

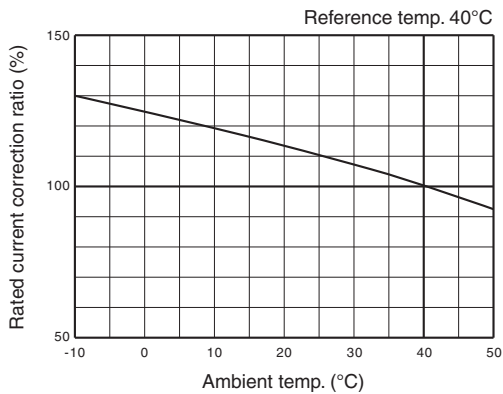

● Earth leakage tripping

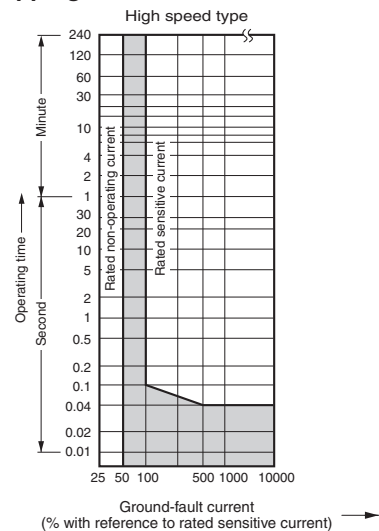

Molded Case Circuit Breakers / Earth Leakage Circuit Breakers G-TWIN / Series Data, Characteristics curves, Dimensions

● Dimensions, mm

Front mounting type

• 2-pole

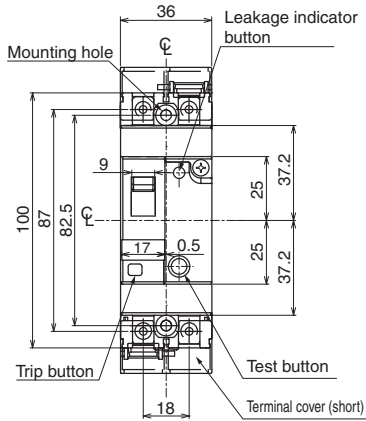

• 3-pole

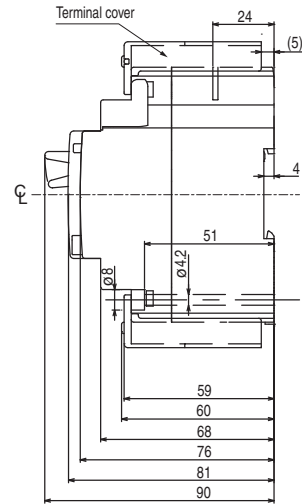
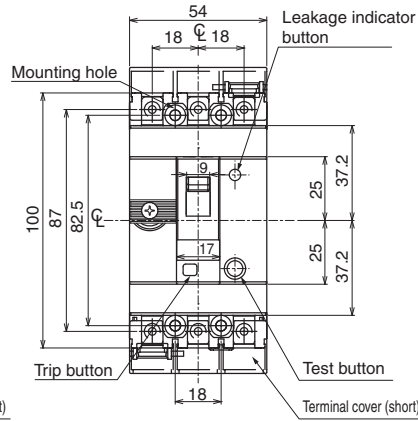

• 2-pole

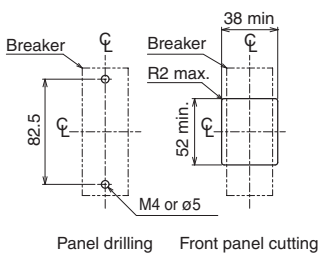

• 3-pole

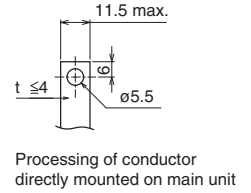
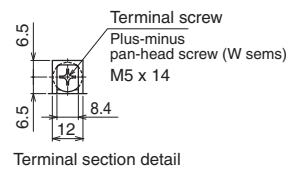
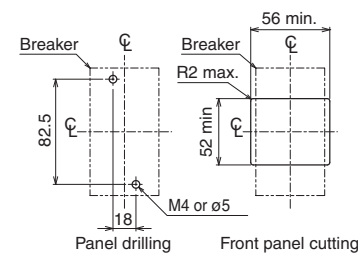

Lead wire terminal block *1*2

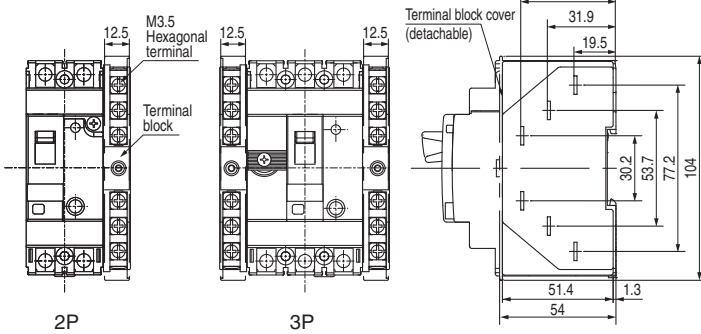

Terminal cover (long)

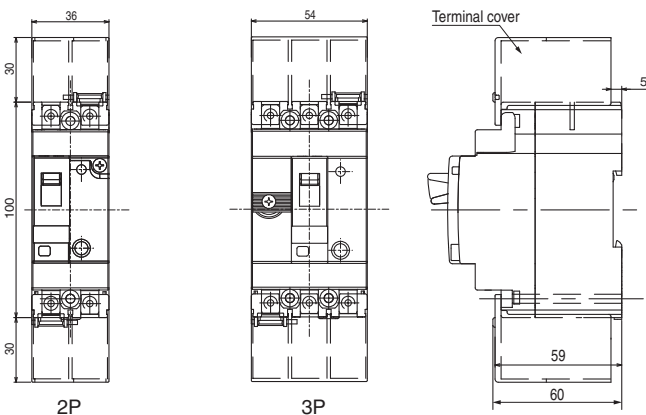

(Note *1) The terminal block is mounted on the accessory mounting side. For the accessory mounting positions, see the List of internal accessory combinations on pages 23 to 26.
(Note *2) Connectable wire: single wire: 1 to 1.6 ø, stranded wire: 0.5 to 2 mm²

Molded Case Circuit Breakers / Earth Leakage Circuit Breakers

G-TWIN / Series

Data, Characteristics curves, Dimensions

■ External operating handle

● Dimensions, mm

N type handle

BW9N0BA

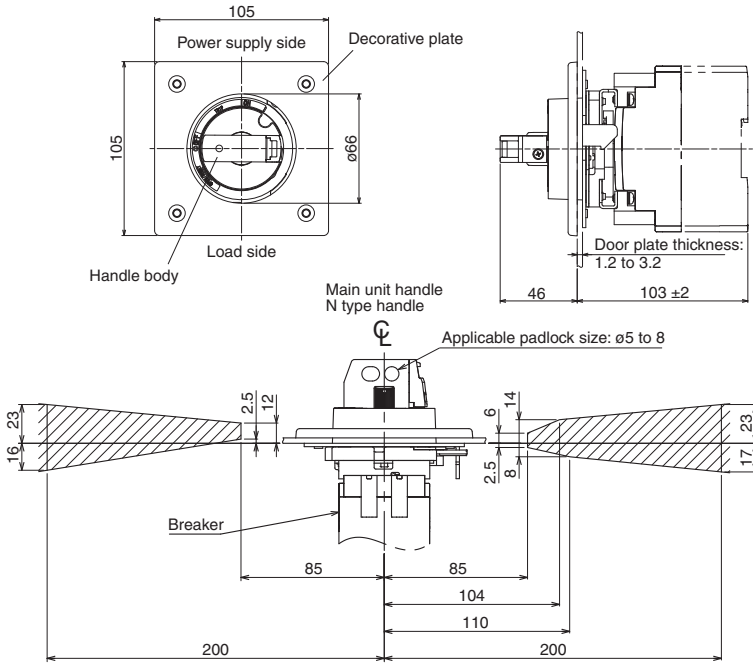

Install the hinge in the shaded area.

Door panel cutout

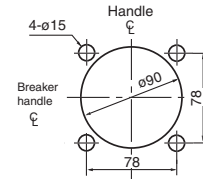

Note: Align the center of the panel cutout with the center of the handle of the breaker main unit.

V type handle

BW9V0BA

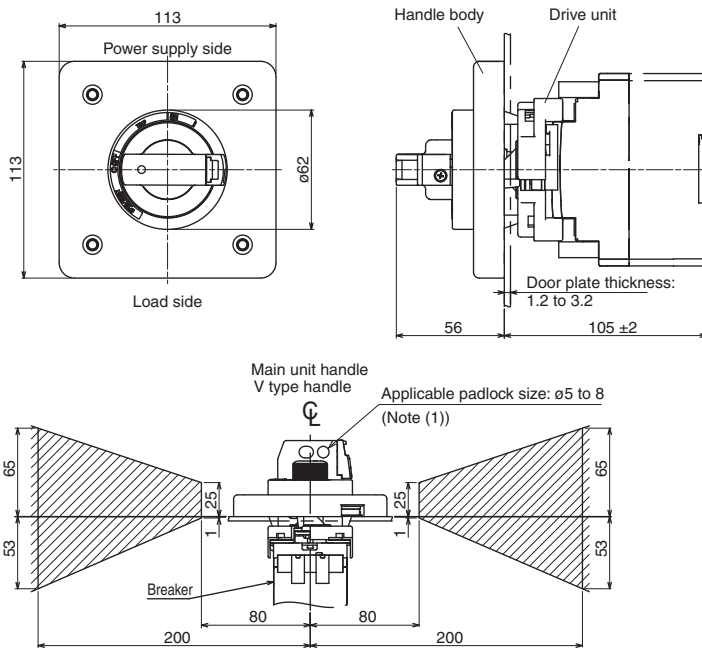

Install the hinge in the shaded area.

Door panel cutout

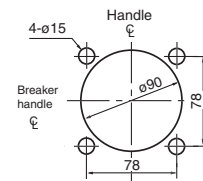

Note: Align the center of the panel cutout with the center of the handle of the breaker main unit.

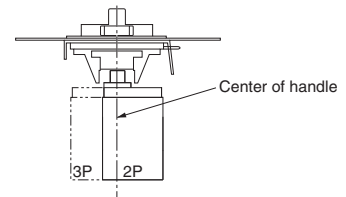

Note (1): Padlockable on the drive unit side when the door is open (applicable padlock size: ø5 to 6)

Safety Considerations

- Operate (keep) in the environment specified in the operating instructions and manual. High temperature, high humidity, condensation, dust, corrosive gases, oil, organic solvents, excessive vibration or shock might cause electric shock, fire, erratic operation or failure.
- For safe operation, before using the product read the instruction manual or user manual that comes with the product carefully or consult the Fuji sales representative from which you purchased the product.
- Products introduced in this catalog have not been designed or manufactured for such applications in a system or equipment that will affect human bodies or lives.
- Customers, who want to use the products introduced in this catalog for special systems or devices such as for atomic-energy control, aerospace use, medical use, passenger vehicle, and traffic control, are requested to consult with Fuji Electric FA.
- Customers are requested to prepare safety measures when they apply the products introduced in this catalog to such systems or facilities that will affect human lives or cause severe damage to property if the products become faulty.
- For safe operation, wiring should be conducted only by qualified engineers who have sufficient technical knowledge about electrical work or wiring.
- Follow the regulations of industrial wastes when the product is to be discarded.
- For further questions, please contact your Fuji sales representative or Fuji Electric FA.

 **Fuji Electric FA Components & Systems Co., Ltd.**

5-7, Nihonbashi Odemma-cho, Chuo-ku, Tokyo, 103-0011, Japan

URL <http://www.fujielectric.co.jp/fcs/eng>