

**gesis**® NRG  
Examples of applications  
for the flexible busbar

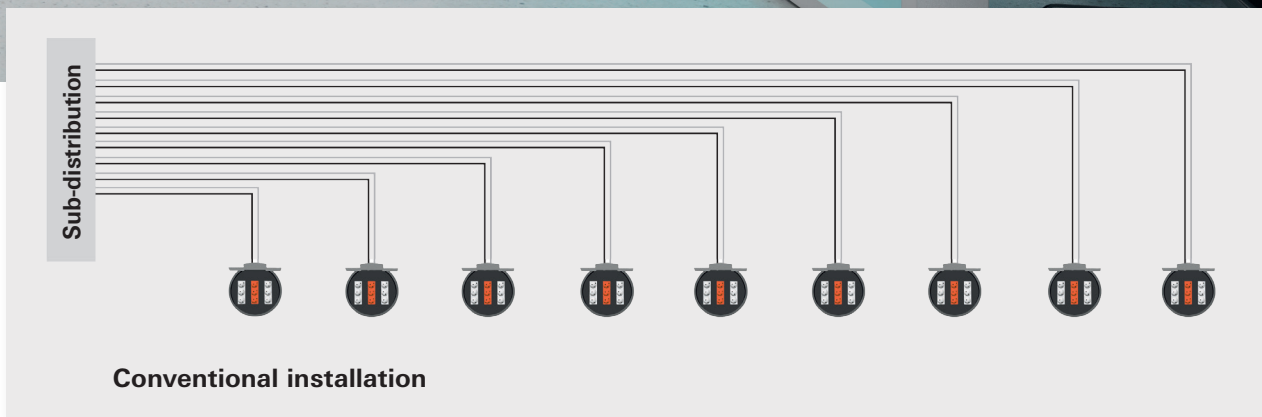

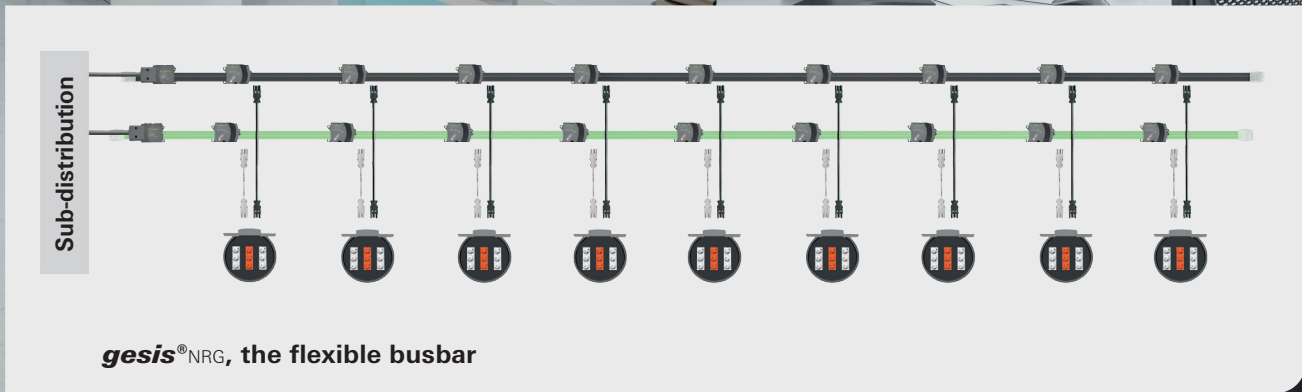

## The flexible busbar

### Forward-looking, space-saving, and safe

In terms of efficiency, safety, and planning for the future, a structured electrical installation with flat cables already sets the standard.

With **gesis**<sup>®</sup>NRG, Wieland Electric offers a TOP solution for structured and fast electrical installation. Floor boxes, lighting systems, luminaire connections, sunblind systems, building bus systems, and so on are installed systematically, transparently, and without any errors in next to no time.

The pluggable electrical installation combines in one system

- Energy and bus system installation
- Quick and safe setup
- Sustainability and flexibility for the future

**Power**  
230/400 V  
3-50 A



**DESIGN PLUS**  
powered by: **light+building**

## Quick, easy, and flexible

### Robust and practical

- Small number of different components
- Adapters and feeds compact and robust
- Mounting holes on all adapters
- Contact to the flat cable by means of IDC
- Pluggable outgoing cables with automatic interlock

### Resource-efficient

- Quick planning and installation
- Reduction in cable material (copper and plastics)
- Short connection cables for end consumers
- Energy savings due to three-phase cabling

### Simple planning

- A ready plan in just a few steps
- Section quantity and length planning
- Feeds = number of sections
- End plates = double the number of sections
- Adapters = quantity of e.g. floor boxes, luminaires, or consolidation points

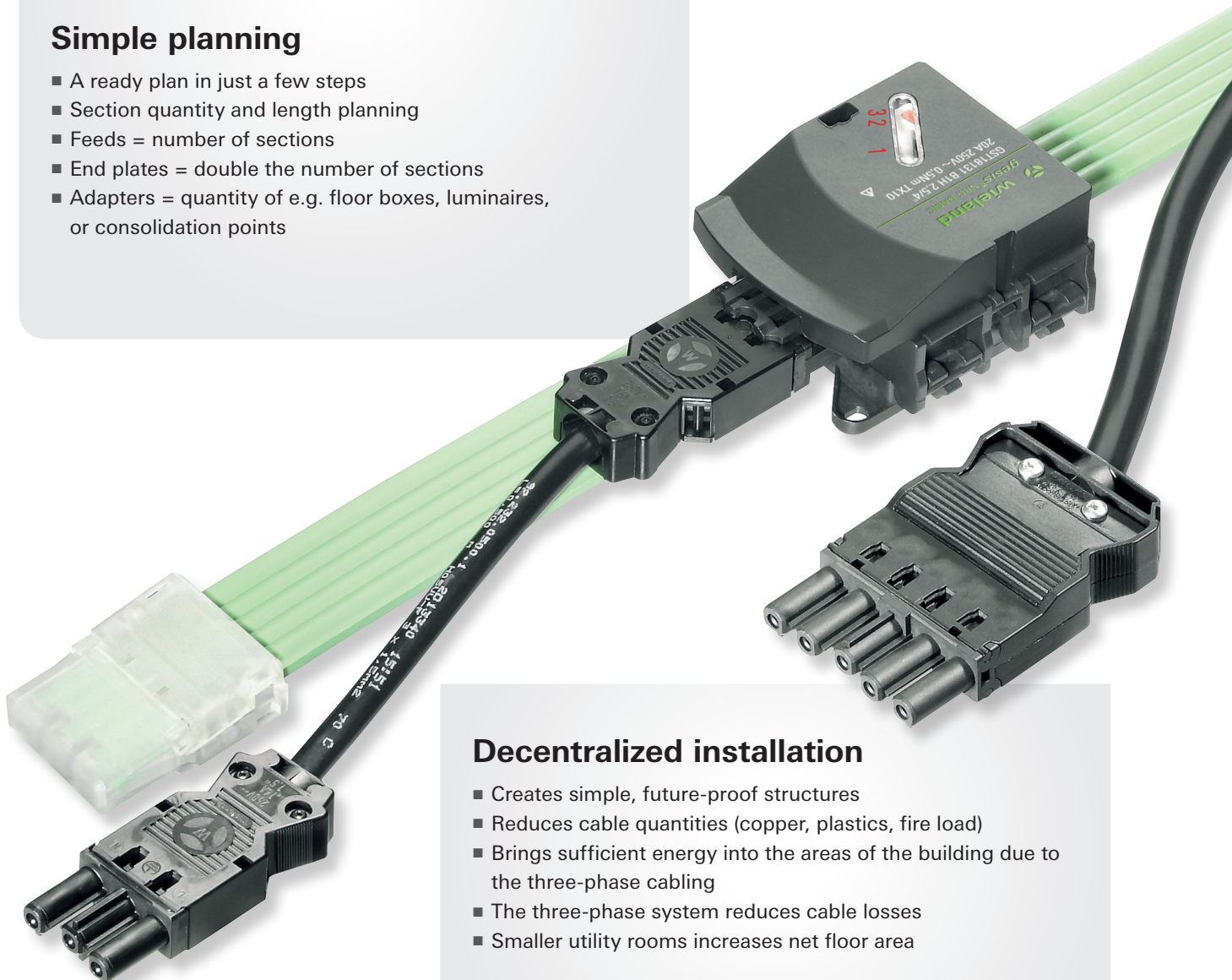

### Decentralized installation

- Creates simple, future-proof structures
- Reduces cable quantities (copper, plastics, fire load)
- Brings sufficient energy into the areas of the building due to the three-phase cabling
- The three-phase system reduces cable losses
- Smaller utility rooms increases net floor area

## Ready for CPR

- The flat cable systems are available in the CPR fire classes C and E
- Detailed information can be found in the **gesis**<sup>®</sup> supplementary catalog (0672.1) as well as in the Wieland eShop

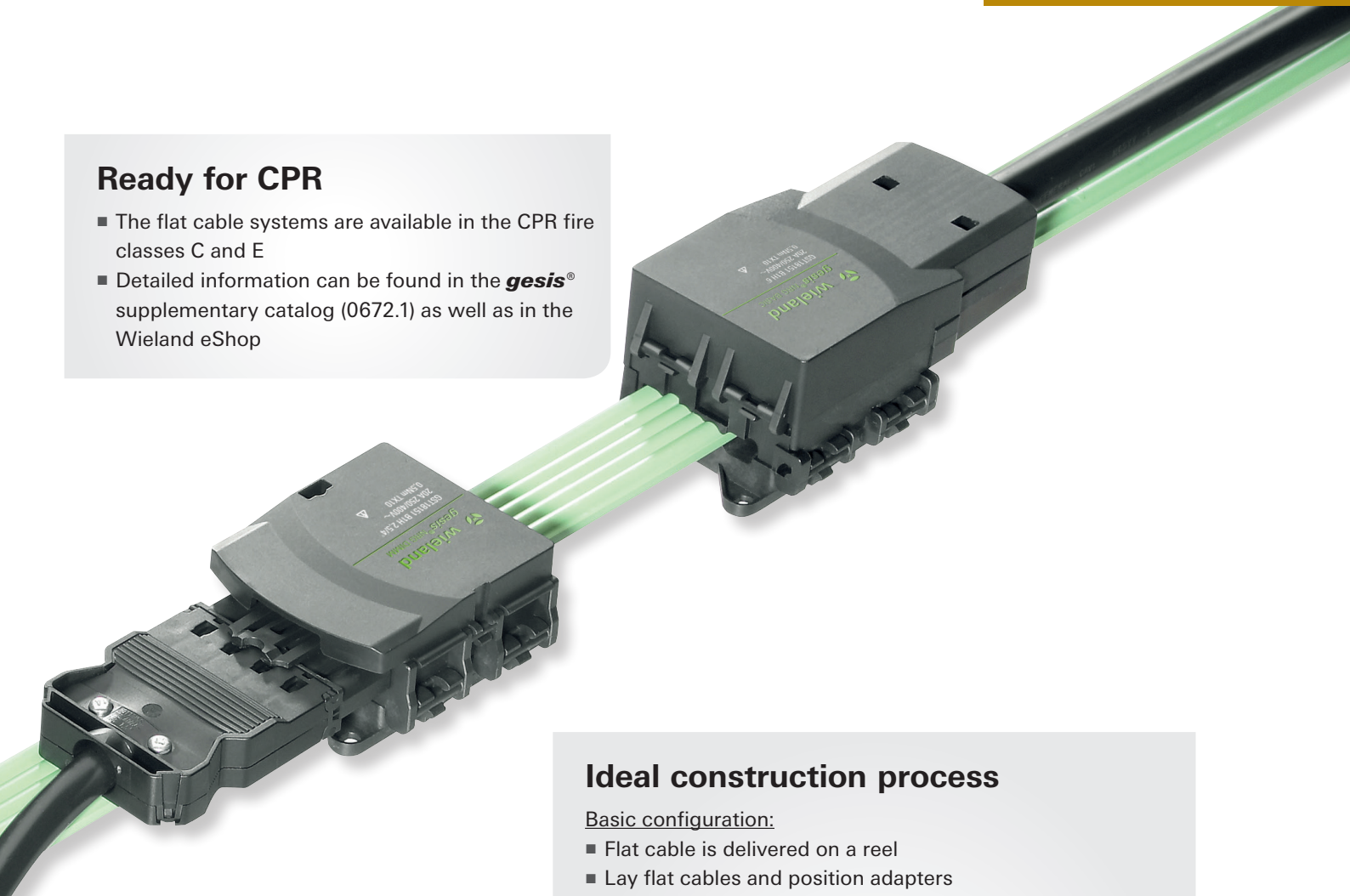

## Ideal construction process

### Basic configuration:

- Flat cable is delivered on a reel
- Lay flat cables and position adapters

### Ultimate configuration:

- Plug in end consumer, e.g. floor box

### Changes:

- Easy to carry out, e.g. position further adapters

## Quick installation

- Lay flat cable like an ordinary cable, position end plates
- Mount feed and taps at any point
- Connect feed
- Position all outgoing cables at the taps

## Future-proof

- Expansions and modifications are quick and easy using further adapters
- Flat cables for future-proof systems, e.g. KNX, DALI, SMI

## Our service

- We can support you with planning and layout
- Systemized deliveries also available

# Planning and design

## Very simple planning

1. Roughly estimate the cable lengths and the number of cables.
2. One feed per harness, with mains and signal separate if applicable.
3. Make sure there are 2 end plates per mains feed.
4. Determine outlet type and quantity, e.g. 15 floor boxes = 15 x 3-pole mains adapter with phase selection.
5. Optional accessories: fastening materials and cable shears.

## Tip

1. Determine cable lengths per harness.
2. Each cable harness always requires
  - 2 end plates
  - 1 feed
  - n outlets

## Check

1. Estimate the number of harnesses = number of feeds
2. Number of end plates = 2 x number of harnesses

## Adapter

- Adaptation is achieved using IDC (Isolation Displacement Contacting).
- The cable cross section is not reduced.
- The IDC screws must be screwed in all the way with the specified torque.
- The adapters can be removed and reused elsewhere. The "injured" cable must be taped with the recommended "plaster".

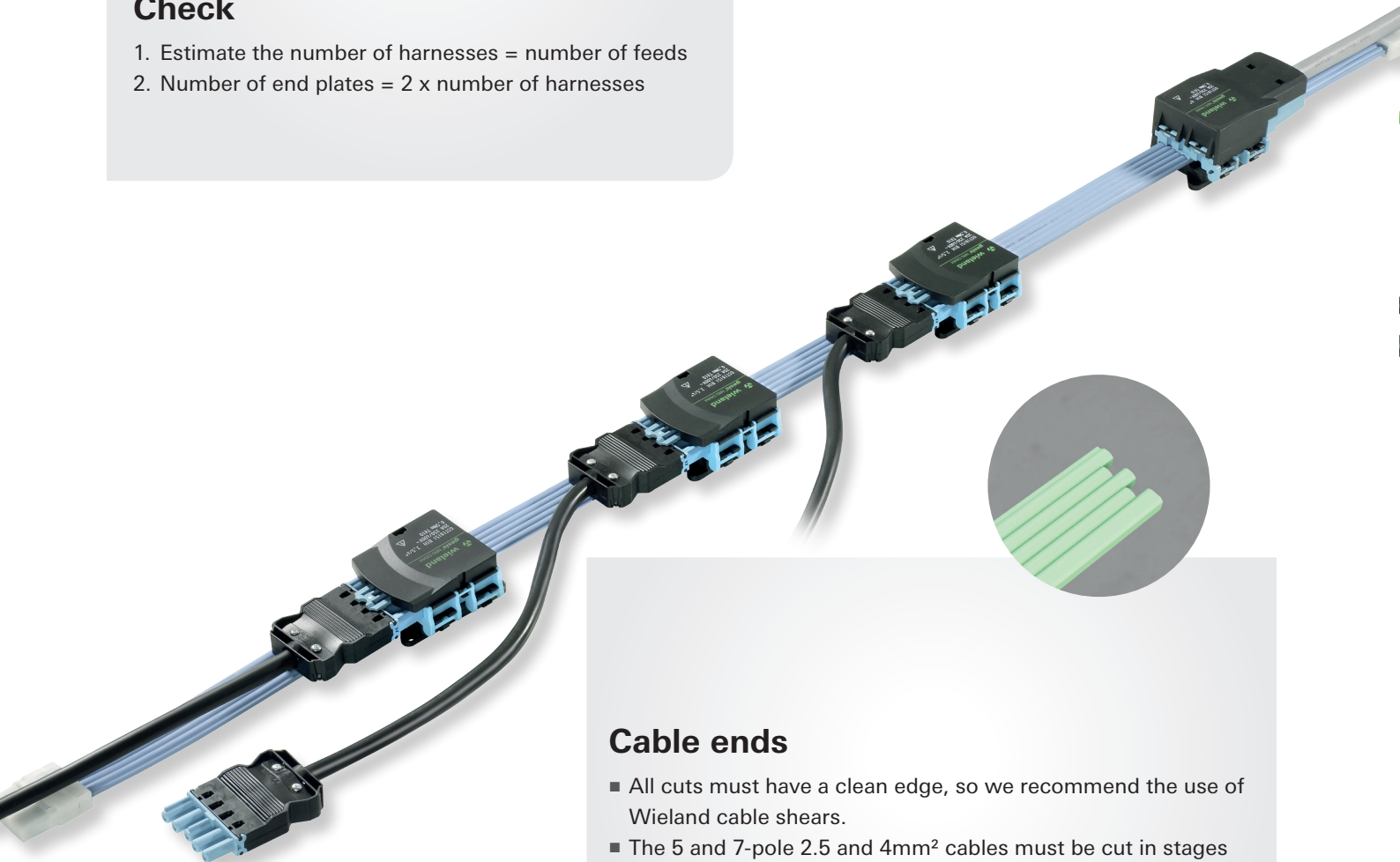

## Cable ends

- All cuts must have a clean edge, so we recommend the use of Wieland cable shears.
- The 5 and 7-pole 2.5 and 4mm<sup>2</sup> cables must be cut in stages using the Wieland cable shears for flat cables.
- Open cable ends must be closed with a cable end cap.

## Nominal cross section 2.5 or 4 mm<sup>2</sup>

We recommend the 2.5 mm<sup>2</sup> variant as standard.

We recommend the 4 mm<sup>2</sup> variant if

- an increased voltage drop can be expected due to long cable lengths.
- increased neutral conductor loads due to harmonic waves can be expected because of electronic loads.

Supplement 3 to DIN VDE 0100-520 names the applicable reduction factors.

The maximum reduction factor to be assumed is 0.65.

This means that you are always on the safe side with  $4\text{ mm}^2 \times 0.65 = 2.6\text{ mm}^2$ .

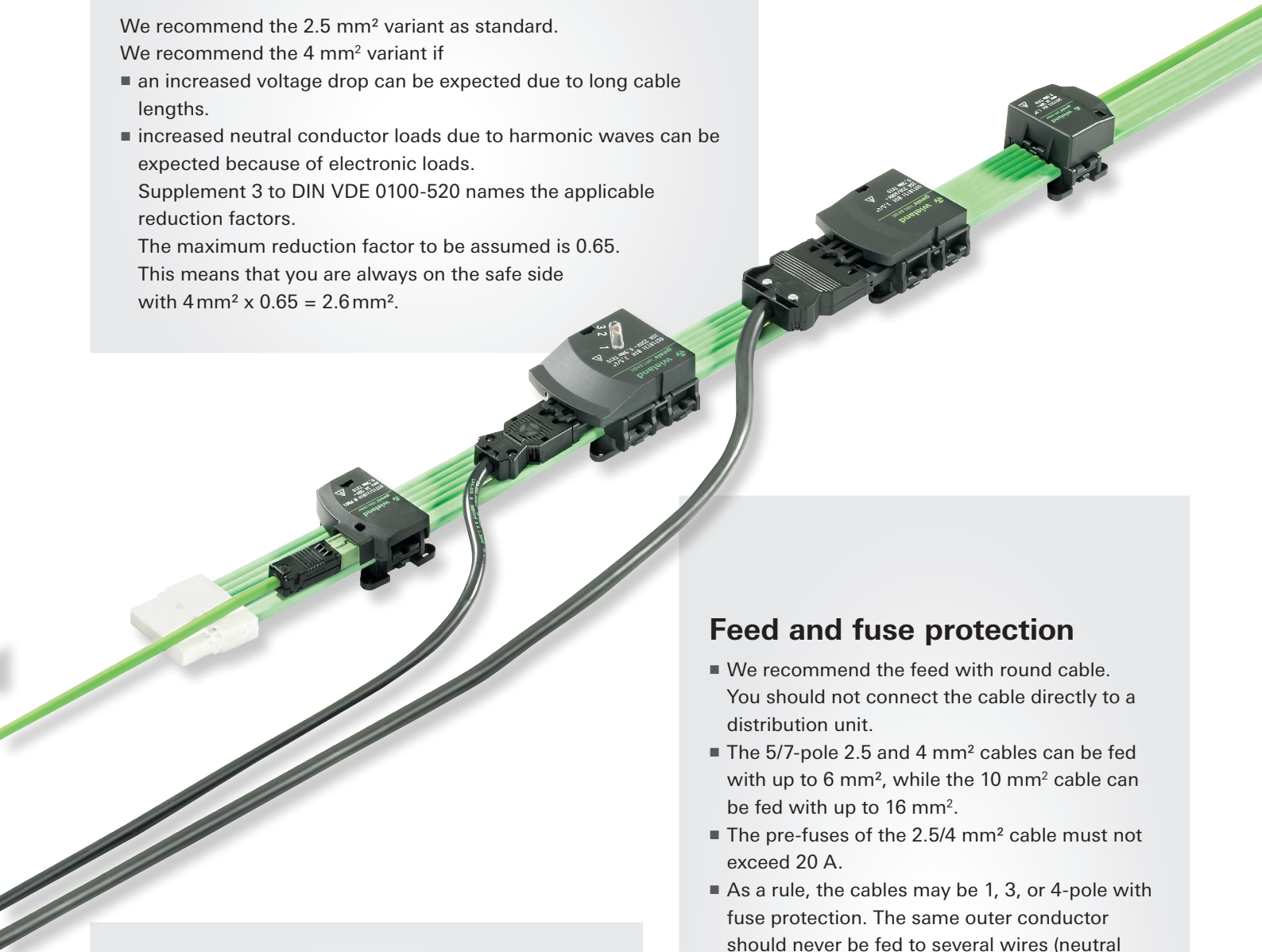

## Mains, SELV, non-SELV, signal cables

- Our cables separate the systems safely and are used for the recommended systems.

	Flachleitungen mit Signalteil			Beispiele
	5-polig Netz+Signal	7-polig Netz+Signal	7-polig Netz+SELV	
SELV			X	KNX
PELV			X	
FELV	X	X		1-10V Dimmung
Sonstige (auch Netz)	D;S	D		DALI (D), SMI (S)*

\* in der SMI Spezifikation kann L (230 V) auf I+ oder I- gelegt werden

- Other voltages, signals, or bus systems can be transmitted, in compliance with the technical data.

## Feed and fuse protection

- We recommend the feed with round cable. You should not connect the cable directly to a distribution unit.
- The 5/7-pole 2.5 and 4 mm<sup>2</sup> cables can be fed with up to 6 mm<sup>2</sup>, while the 10 mm<sup>2</sup> cable can be fed with up to 16 mm<sup>2</sup>.
- The pre-fuses of the 2.5/4 mm<sup>2</sup> cable must not exceed 20 A.
- As a rule, the cables may be 1, 3, or 4-pole with fuse protection. The same outer conductor should never be fed to several wires (neutral conductor overload).
- Pay attention to laying methods and local regulations for fuses. The considerations must be the same as for round cables.

## Fastening and laying method

- All cables can be laid
  - on plaster
  - in cable trays
  - in cable ducts
  - in cavity floors and raised floors.
 In these areas, they can be used like NYM according to VDE 0298 part 3:2006-06.
- Fastening is recommended every 50 cm.
- Fastening with flat cable adapters, with Wieland clamps for flat cables or with standard fastening materials such as OBO cable clamps.

**Power**  
230/400 V  
20 A

# Mains application, 5-pole, 2.5/4 mm<sup>2</sup> Floor box supply

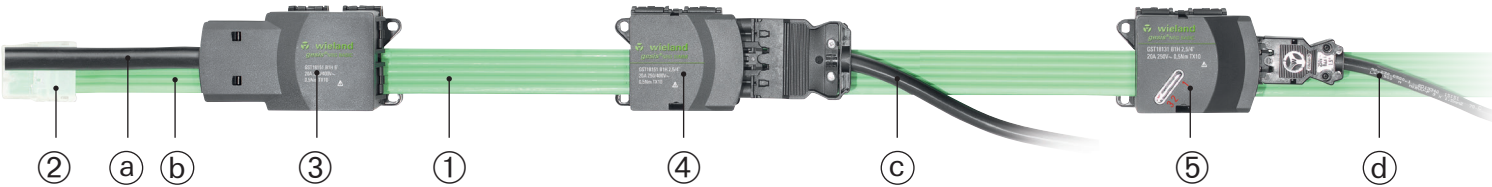

## The system – mains

Flat cable					Flat cable products		Article number		
	Cross section	Material	CPR fire class	Article number		②	③		
				Green	Black				
①	2.5 mm <sup>2</sup>	PVC	Eca	00.712.0303.7	00.712.0303.1	④	Cable end cap	06.562.0653.0	
①	2.5 mm <sup>2</sup>	Halogen-free	Eca	00.710.0303.7	00.710.0303.1	⑤	Feed	92.050.1553.1	
①	2.5 mm <sup>2</sup>	Halogen-free "CPR"	Cca	00.750.0303.7			④	Taps 5-pole	92.051.5453.1
①	4mm <sup>2</sup>	Halogen-free	Eca	00.710.0304.7	00.710.0304.1		⑤	Taps 3-pole phase selection	92.031.5453.1
①	4mm <sup>2</sup>	Halogen-free "CPR"	Cca	00.750.0304.7				Cable clip (pack=100)	05.562.3000.0
				similar to RAL 6018	similar to RAL 9005			Cable shears/step cut	95.300.0600.0

**Key**

a	Supply cable, e.g. NYM 5G4mm <sup>2</sup> , protected with three individual B16 fuses
b	Flat cable to further outlets
c	3-phase outlet, e.g. to a local sub-distributor
d	1-phase outlet, e.g. to a floor box

## Example

### Floor box supply with normal and IT networks

26 floor boxes, each with 500 W projected power with normal and IT networks in 2 segments

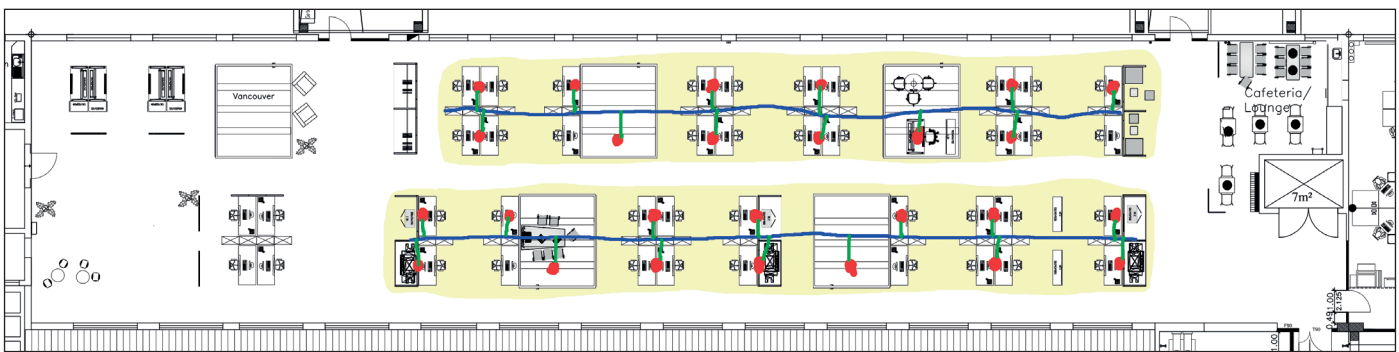

#### Example (building plan)

The floor boxes are supplied via a **gesis®** NRG flat cable system 5G4 mm<sup>2</sup> in the raised floor. As the floor boxes can be accessed with normal and IT networks, 2 different-colored **gesis®** NRG flat cable systems 5G4 mm<sup>2</sup> are laid parallel. The floor boxes are then connected with two different-colored **gesis®** connecting cables. The floor boxes are fused centrally in the sub-distributor with 16 A per phase. The model should be halogen-free.

For the calculations we assumed 500 W each for NN and IT in each floor box. This means that all the planned flat cable harnesses have a sufficient reserve of at least approximately 30% for future extensions. With the **gesis®** connecting cables we have assumed a maximum length of 2 m. The quantity survey is based on the following cable lengths: 75% 1 m, 25% 2 m.

#### System details using the example of 2 floor boxes

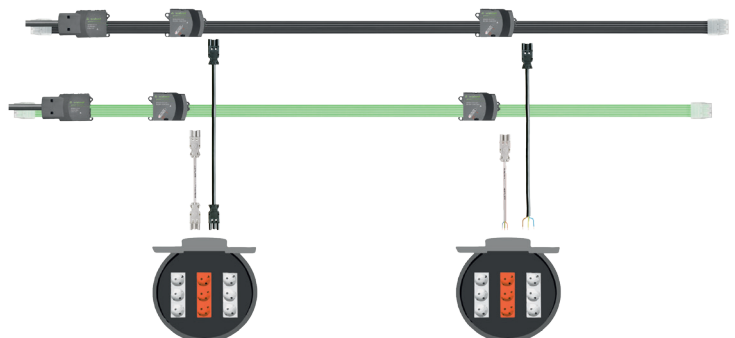



## Materials list

Product	Article number	Length Pieces	Comments
gesis NRG BASIC flat cable 5G4 mm <sup>2</sup> , black, halogen-free	00.710.0304.1	60 m	Two flat cable harnesses for normal network
gesis NRG BASIC flat cable 5G4 mm <sup>2</sup> , green, halogen-free	00.710.0304.7	60 m	Two flat cable harnesses for IT network
gesis NRG cable end cap 5G2.5/4 mm <sup>2</sup>	06.562.0653.0	8	Two cable end caps per flat cable harness
gesis NRG BASIC flat cable feed	92.050.1553.1	4	One feed per flat cable harness
gesis NRG BASIC flat cable adapter GST18i3, 3-pole, code 1, black, with phase selection	92.031.5453.1	52	One flat cable outlet per floor box and per network
gesis CLASSIC connecting cable 3G2.5 mm <sup>2</sup> , 1 m, code 1, black, halogen-free, normal network	92.238.1060.1	20	Short connecting cable between flat cable and floor box, normal network, black
gesis CLASSIC connecting cable 3G2.5 mm <sup>2</sup> , 1 m, code 1, white, halogen-free, IT network	92.238.1060.2	20	Short connecting cable between flat cable and floor box, IT network, white
gesis CLASSIC connecting cable 3G2.5 mm <sup>2</sup> , 2 m, code 1, black, halogen-free, normal network	92.238.2060.1	6	Long connecting cable between flat cable and floor box, normal network, black
gesis CLASSIC connecting cable 3G2.5 mm <sup>2</sup> , 2 m, code 1, white, halogen-free, IT network	92.238.2060.2	6	Long connecting cable between flat cable and floor box, IT network, white
Cable clip	05.562.3000.0	240	For fixing the flat cable in place, optional
Cable shears for step cut	95.300.0600.0	1	Mandatory for working on cable ends

## Planning

### Flat cable

- Load/circuit distribution – 2 segments with 2 flat cables each (normal and IT networks)
- If a high voltage drop can be expected due to long cables, or if high neutral conductor currents due to harmonic waves can be expected because of the use of electronic consumers, we recommend that the 4 mm<sup>2</sup> flat cable be used.

### Fuse protection and supply cable

We recommend fuse protection with three individual 16 A circuit breakers with upstream residual current circuit breaker 4-pole / 40 A / 30 mA. The specifications of VDE 0100-520, as defined for conventional round cables, apply to the layout. The maximum fuse protection is 20 A. Should individual floor boxes be protected decentrally, attention must be paid to selectivity with the cable and residual current protection.

### Outlets to the individual floor boxes

These use **gesis**<sup>®</sup>CLASSIC 2,5mm<sup>2</sup> cables. To distinguish between the two networks, we recommend outlet cables in black and white. Lengths, cross sections, and cable type must be selected in accordance with local conditions and provisions.

### Floor boxes

Floor boxes can be ordered in the **gesis**<sup>®</sup> design from various floor box manufacturers. We will be happy to help you coordinate this.

### Fastening of the flat cable

The flat cable can be fastened with flat cable adapters, with Wieland clamps for flat cables, or with standard fastening materials such as OBO cable clamps.

### Advantage of this installation option:

Using **gesis**<sup>®</sup>NRG flat cable systems for floor box supply results in clear structures that are easy to maintain. The clean separation of different networks (e.g. NN and IT) is simplified by means of different cable colors. Extensions can be achieved quickly by simply positioning further outlet adapters without having to move, cut, bare, strip, and wire cables. The use of three-phase systems up to just before the consumers reduces the voltage drop due to a reduced zero conductor current, thereby ultimately saving energy.

Our system partners (e.g. OBO, PUK) have floor boxes in their product portfolios that are directly pluggable or adaptable to **gesis**<sup>®</sup>NRG flat cables in various designs with and without local fuse protection.



# Mains + signal, 5-pole, 2.5/4 mm<sup>2</sup> Lighting control with DALI

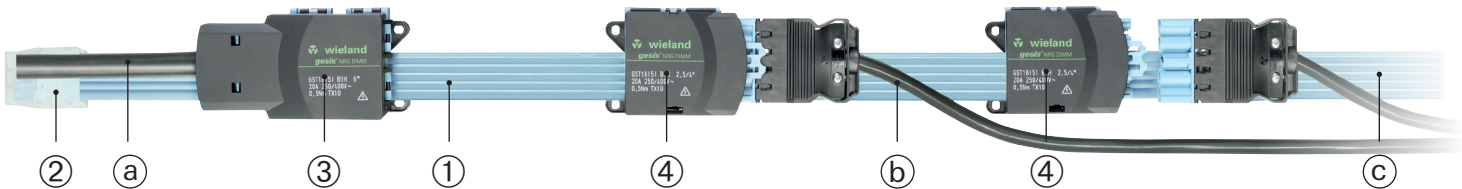

## The system – DALI + 1ph

Flat cable					Flat cable products		Article number
	Cross section	Material	CPR fire class	Article number			
				Pastel blue	②	Cable end cap	06.562.0653.0
①	2.5mm <sup>2</sup>	PVC	Eca	00.712.0303.6	③	Feed	92.050.1553.1
①	2.5mm <sup>2</sup>	Halogen-free	Eca	00.710.0303.6			
①	2.5mm <sup>2</sup>	Halogen-free "CPR"	Cca	00.750.0303.6	④	Taps 5-pole (mains and DALI)	92.051.5553.0
①	4mm <sup>2</sup>	Halogen-free	Eca	00.710.0304.6		Cable clip (pack=100)	05.562.3000.0
①	4mm <sup>2</sup>	Halogen-free "CPR"	Cca	00.750.0304.6		Cable shears/step cut	95.300.0600.0
				similar to RAL 5024			
<b>Key</b>							
a	Supply cable, e.g. NYM 5G2.5 mm <sup>2</sup> , from DALI master + mains with 16A fuse protection						
b	5-pole outlet to DALI luminaire, DALI + mains						
c	Flat cable to further outlets						

## Example

### Flat cable for supplying DALI luminaires

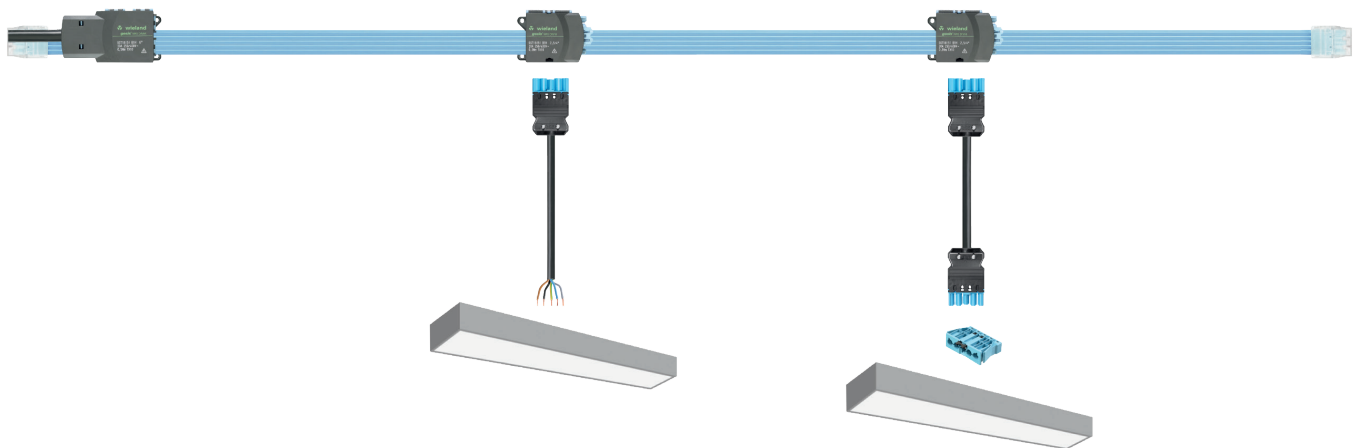

The 5-pole **gesis**® NRG DIMM flat cable 5G2.5 mm<sup>2</sup> supplies energy (1-phase) and the DALI signal to the area. The luminaires can then be supplied with mains power and DALI signal directly via 5-pole flat cable adapters. Depending on the connection technology of the luminaires, 5-pole **gesis**® connection cables (male/free end) or **gesis**® connecting cables (male/female) are used. The luminaires can usually be ordered from the manufacturer as already pluggable models (connection cable or device connector (snap-in)).

## Materials list

Product	Article number	Length Pieces	Comments
gesis NRG DIMM flat cable 5G2.5 mm <sup>2</sup> , pastel blue	00.712.0303.6	4 m	Flat cable with 1-phase mains and DALI signal
gesis NRG cable end cap 5G2.5/4 mm <sup>2</sup>	06.562.0653.0	2	Two cable end caps per flat cable harness
gesis NRG DIMM flat cable feed	92.050.1653.0,	1	One feed per flat cable harness
gesis NRG DIMM flat cable adapter GST18i5, 5-pole, code 2, pastel blue	92.051.5553.0	2*	One flat cable outlet per luminaire
gesis CLASSIC connection cable 5G1.5 mm <sup>2</sup> , 1 m, code 2, pastel blue, mains+DALI	92.257.1004.9	1*	Connection cable between flat cable and luminaire (optional in delivery package from luminaire manufacturer)
gesis CLASSIC connecting cable 5G1.5 mm <sup>2</sup> , 1 m, code 2, pastel blue, mains+DALI	92.257.1000.9	1*	Connecting cable between flat cable and luminaire
gesis CLASSIC device connector, snap-in, 5-pole, code 2, pastel blue	92.052.8658.0	1*	Device connector for pluggable version of luminaires (in delivery package from luminaire manufacturer)
Cable clip	05.562.3000.0	8	For fixing the flat cable in place, optional
Cable shears for step cut	95.300.0600.0	1	Mandatory for working on cable ends

\* the number of pieces must be tailored to the required number of luminaires and their connection method

## Planning

### Flat cable

- 2.5 mm<sup>2</sup> flat cable in pastel blue for mains + signal application
- PVC planning requirement

### Fuse protection and supply cable

- DALI and mains are fed through from the sub-distributor with NYM 5 x 2.5 mm<sup>2</sup>.
- Cable protection, e.g. with 16 A. Make sure that the specifications of VDE 0100-520, as defined for conventional round cables, are applied for the layout.

### Outlets to the individual luminaires

- One outlet is positioned per luminaire
- The luminaire is connected with a 1 m long **gesis**<sup>®</sup>CLASSIC 5G1.5 cable.

### Luminaires

Luminaires can be ordered in the **gesis**<sup>®</sup> design from various luminaire manufacturers.

We will be happy to help you coordinate this.

### Fastening of the flat cable

Country-specific installation specifications must be observed. Fastening every 50 cm is recommended as is fastening of the adapters to the designated mounting holes.

### Advantage of this installation option:

Using the 5-pole **gesis**<sup>®</sup>NRG flat cable system to supply DALI systems results in clear structures that are easy to maintain. Adjustments to changed luminaire layouts as part of spatial restructuring can be achieved very quickly and without moving, cutting, baring, stripping, and wiring cables.

# Mains 5-pole + signal 2-pole for non-SELV systems

## 5G2.5 mm<sup>2</sup> + 2x1.5 mm<sup>2</sup> without screen

### Mains + DALI application

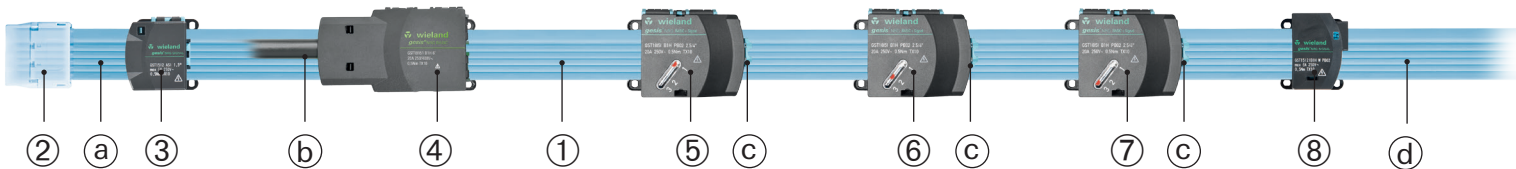

### The system – 5-pole + signal up to 230 V

Flat cable (each with 2x1.5mm <sup>2</sup> bus cable)				Flat cable products	Article number	
			Article number	②	Cable end cap	06.562.9753.0
			<b>Pastel blue</b>	③	Signal feed	91.020.5453.0
①	2.5mm <sup>2</sup>	PVC	Eca	④	Mains 5-pole feed	92.050.1553.1
①	2.5mm <sup>2</sup>	Halogen-free	Eca	⑤	Signal + mains outlets with phase selection L1 or L2 or L3	92.051.5653.0
①	2.5mm <sup>2</sup>	Halogen-free "CPR"	Cca	⑥		
①	2.5mm <sup>2</sup>	Halogen-free "CPR"	Cca	⑦		
①	4mm <sup>2</sup>	Halogen-free	Eca	⑧	Signal tap, 2-pole	91.021.5453.0
①	4mm <sup>2</sup>	Halogen-free "CPR"	Cca		Cable clip	05.562.3000.0
			similar to RAL 5024		Cable shears for step cut	95.300.0600.0
* The model with a black sheath is being phased out, last digit .1						
<b>Key</b>						
a	Supply cable, e.g. NYM 5G4 mm <sup>2</sup> , protected with 16 A fuse					
b	DALI supply cable, e.g. H05 VV-F 2X1.5					
c	5-pole outlet (mains+DALI) to DALI luminaire, pluggable with GST18i5, code 2, pastel blue					
d	Flat cable to further outlets					

### Example

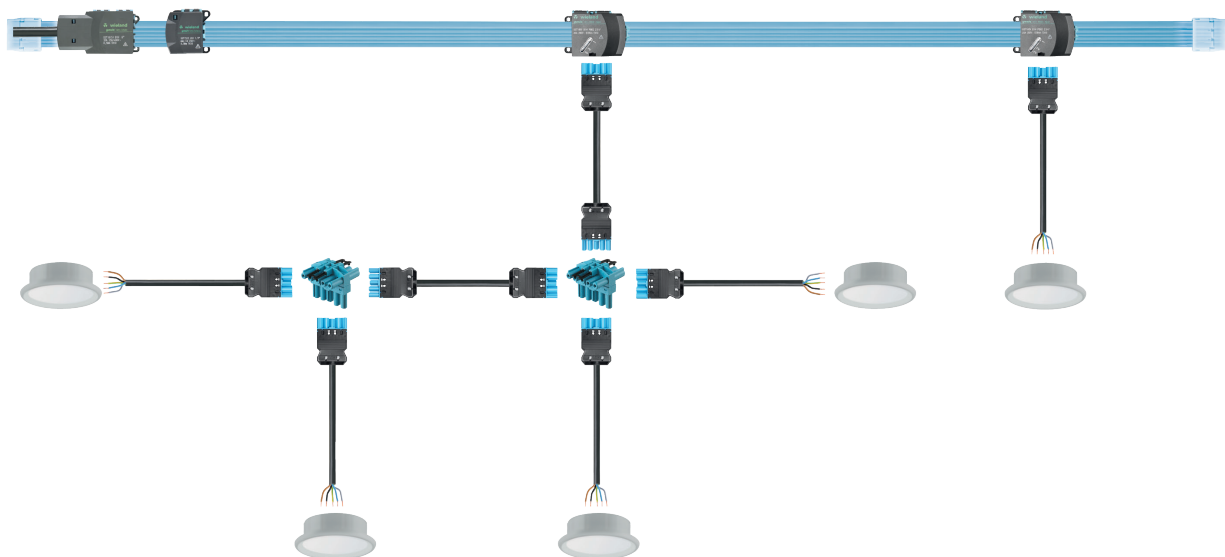

The 7-pole **gesis**® NRG BASIC+ SIGNAL flat cable 5G2.5+2x1.5 mm<sup>2</sup> supplies energy (3-phase) and the DALI signal to the area. The luminaires can then be supplied with mains power and DALI signal directly via 5-pole flat cable adapters with phase selection. Depending on the connection technology of the luminaires, 5-pole **gesis**® connection cables (male/free end) or **gesis**® connecting cables (male/female) are used. The luminaires can usually be ordered from the manufacturer as already pluggable models (connection cable or device connector (snap-in)). For further distribution, various distribution blocks (here in T and H shape) are used.

## Materials list

Product	Article number	Length Pieces	Comments
gesis NRG BASIC+SIGNAL flat cable 5G2.5+2x1.5 mm <sup>2</sup> , pastel blue	00.712.0323.6	6 m	Flat cable with 3-phase mains and DALI signal
gesis NRG cable end cap 5G2.5/4+2x1.5 mm <sup>2</sup>	06.562.9753.0	2	Two cable end caps per flat cable harness
gesis NRG BASIC flat cable feed mains	92.050.1553.1	1	One mains feed per flat cable harness
gesis NRG BASIC+SIGNAL flat cable feed SIGNAL	91.020.5453.0	1	One DALI feed per flat cable harness
gesis NRG DIMM flat cable adapter GST18i5, 5-pole, code 2, pastel blue, with phase selection	92.051.5653.0	2	One flat cable outlet per luminaire harness
gesis CLASSIC connecting cable 5G1.5 mm <sup>2</sup> , x m, code 2, pastel blue, mains+DALI	92.257.x000.9	2	Connecting cable between flat cable/distribution blocks and distribution blocks
gesis CLASSIC connection cable 5G1.5 mm <sup>2</sup> , 1 m, code 2, pastel blue, mains+DALI	92.257.1004.9	5	Connection cable between flat cable/distribution block and luminaire (optional in delivery package from luminaire manufacturer)
gesis CLASSIC distribution block, 1 inlet, 3 outlets, H shape, 5-pole, code 2, pastel blue	92.050.1853.0	1	Distribution block for connecting individual luminaires
gesis CLASSIC distribution block, 1 inlet, 2 outlets, T shape, 5-pole, code 2, pastel blue	92.050.3453.0	1	Distribution block for connecting individual luminaires
gesis CLASSIC interlock for flying leads, black	05.587.3156.1	1	Is required once for each form of distributor in T shape
Cable clip	05.562.3000.0	12	For fixing the flat cable in place, optional
Cable shears for step cut	95.300.0600.0	1	Mandatory for working on cable ends

## Planning

### DALI installation with 3-phase mains feed

- Cable in pastel blue for mains + signal, 5G2.5+2x1.5 mm<sup>2</sup> cross section
- PVC planning requirement

### Fuse protection and supply cable

- The mains feed comes from the sub-distributor with NYM 5 x 2.5 mm<sup>2</sup>
- We recommend fuse protection with three individual 16 A circuit breakers. The specifications of VDE 0100-520, as defined for conventional round cables, apply to the layout. The maximum fuse protection is 20 A.
- The DALI feed comes in parallel from the sub-distributor or, for example, from the **gesis**<sup>®</sup>FLEX DALI outlet

### Outlets to the individual luminaires/luminaire groups

- For each luminaire or luminaire group, one outlet is positioned which connects with DALI and the 230V mains. The outer conductor can be chosen freely
- Distribution to the luminaires can be achieved directly or via various distribution blocks
- The connection cable to the luminaire is a 1 m long **gesis**<sup>®</sup>CLASSIC 5G1.5 cable.

### Luminaires

Luminaires can be ordered in the **gesis**<sup>®</sup> design from various luminaire manufacturers.

We will be happy to help you coordinate this.

### Fastening of the flat cable

Country-specific installation specifications must be observed. Fastening every 50 cm is recommended as is fastening of the adapters to the designated mounting holes.

### Advantage of this installation option:

Using the 7-pole **gesis**<sup>®</sup>NRG flat cable system to supply DALI systems results in clear structures that are easy to maintain. Adjustments to changed luminaire layouts as part of spatial restructuring can be achieved very quickly and without moving, cutting, baring, stripping, and wiring cables. The use of three-phase systems up to just before the consumers reduces cable quantities and therefore provides for a resource-efficient installation in many areas. In addition, the reduced zero conductor current reduces the voltage drop, thereby ultimately saving energy. The 7-pole version is also ideal for covering areas with high light energy demands.

# Mains + signal, 5-pole, 2.5/4 mm<sup>2</sup> Sunblind control with SMI

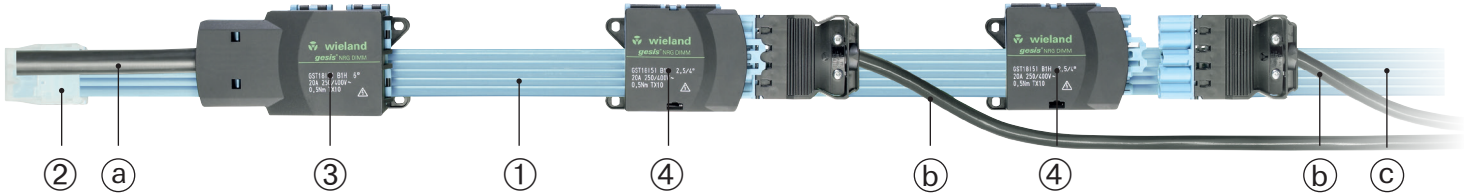

## The system – SMI + 1ph

Flat cable				Flat cable products		Article number	
	Cross section	Material	CPR fire class	Article number			
				Pastel blue			
①	2.5mm <sup>2</sup>	PVC	Eca	00.712.0303.6	②	Cable end cap	06.562.0653.0
①	2.5mm <sup>2</sup>	Halogen-free	Eca	00.710.0303.6	③	Feed	92.050.1653.0
①	2.5mm <sup>2</sup>	Halogen-free "CPR"	Cca	00.750.0303.6	④	Tap 5-pole (mains and SMI)	92.051.5553.0
①	4mm <sup>2</sup>	Halogen-free	Eca	00.710.0304.6		Cable clip	05.562.3000.0
①	4mm <sup>2</sup>	Halogen-free "CPR"	Cca	00.750.0304.6		Cable shears for step cut	95.300.0600.0
				similar to RAL 5024			
<b>Key</b>							
a	Supply cable of <b>gesis</b> ®FLEX KNX – SMI Gateway, e.g. NYM 5G2.5 mm <sup>2</sup>						
b	5-pole outlet to SMI sunblind motor, SMI + mains						
c	Flat cable to further outlets						

## Example



The 5-pole **gesis**®NRG DIMM flat cable 5G2.5 mm<sup>2</sup> supplies energy (1-phase) and the SMI signal to the area. The drives can then be supplied with mains power and SMI signal directly via 5-pole flat cable adapters. As a rule, **gesis**® connectors are then assembled on the connection cable of the drives. The drives can often be ordered from the manufacturer as already pluggable models (pre-assembled plug).

## Materials list

Product	Article number	Length Pieces	Comments
gesis NRG DIMM flat cable 5G2.5 mm <sup>2</sup> , pastel blue	00.712.0303.6	4 m	Flat cable with 1-phase mains and SMI signal
gesis NRG cable end cap 5G2.5/4 mm <sup>2</sup>	06.562.0653.0	2	Two cable end caps per flat cable harness
gesis NRG DIMM flat cable feed	92.050.1653.0,	1	One feed per flat cable harness
gesis NRG DIMM flat cable adapter GST18i5, 5-pole, code 2, pastel blue	92.051.5553.0	2	One flat cable outlet per drive
gesis FLEX KNX-SMI gateway	83.020.0635.0	1	Decentrally mountable, directly pluggable KNX-SMI gateway
gesis CLASSIC connection cable 5G2.5 mm <sup>2</sup> , x m, code 2, pastel blue, mains+DALI	92.258.x004.9	1	Connection cable between gateway and flat cable feed
gesis CLASSIC connector, plug, GST18i5, 5-pole, code 2, pastel blue	92.954.4453.0	2	Connector for assembling the connection cable of the SMI drive (optional in delivery package from luminaire manufacturer)
Cable clip	05.562.3000.0	8	For fixing the flat cable in place, optional
Cable shears for step cut	95.300.0600.0	1	Mandatory for working on cable ends

## Planning

### Flat cable

- 2.5 mm<sup>2</sup> PVC flat cable in pastel blue for mains + signal application

### Fuse protection and supply cable

- SMI and mains are fed together by the **gesis<sup>®</sup>FLEX** KNX – SMI gateway with a **gesis<sup>®</sup>CLASSIC** 5G2.5 mm<sup>2</sup> connection cable, code 2, pastel blue
- We recommend mains fuse protection with 16 A circuit breakers. The specifications of VDE 0100-520, as defined for conventional round cables, apply to the layout. The maximum fuse protection is 20 A

### Outlets to the individual SMI sunblind motors

- The motor connection cables are assembled on the connectors on site
- The motor connection cables, which are guided through the façade without connectors can be made short as they are connected to the flat cable at any point

### Fastening of the flat cable

Country-specific installation specifications must be observed. Fastening every 50 cm is recommended as is fastening of the adapters to the designated mounting holes

### Advantage of this installation option:

The 5-pole **gesis<sup>®</sup>NRG** DIMM flat cable ideally represents the bus structure of the SMI system. Depending on the design/ placement of the SMI drives, the additional connection technology can be realized indoors with **gesis<sup>®</sup>CLASSIC** or outdoors with **RST<sup>®</sup>MINI**.

### SMI / Standard Motor Interface note:

The Standard Motor Interface e.V. manual recommends this installation method as well as other installation suggestions involving connector systems from Wieland.

This manual can be found as a download on the official homepage of Standard Motor Interface e.V. at

[www.standard-motor-interface.com](http://www.standard-motor-interface.com)

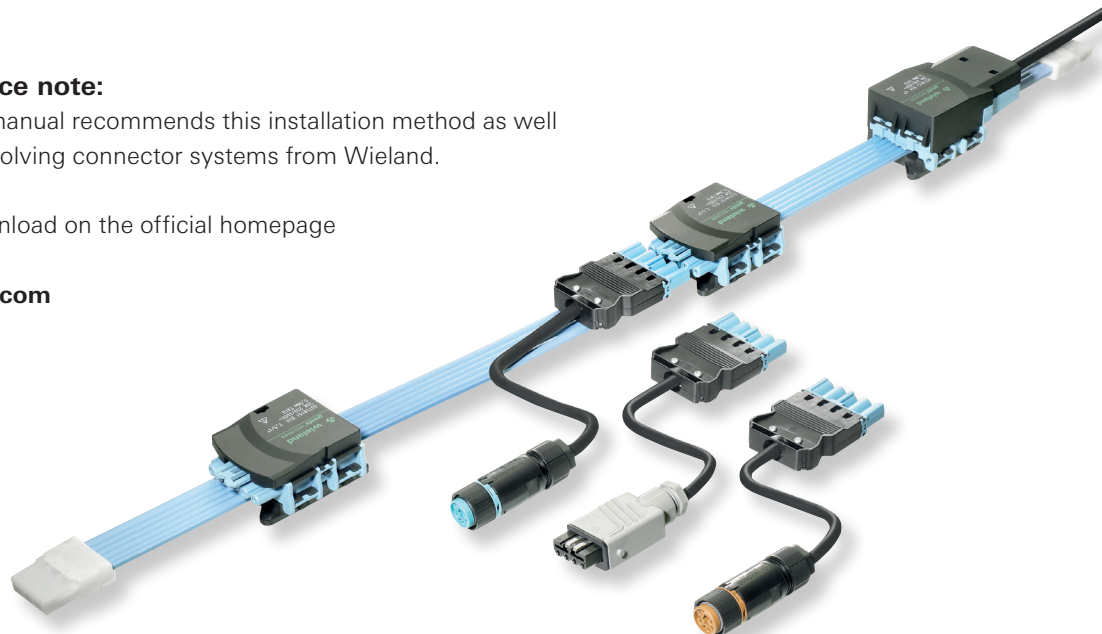

# Mains 5-pole + SELV systems 5G2.5 mm<sup>2</sup> + 2 x 1.5 mm<sup>2</sup> screened

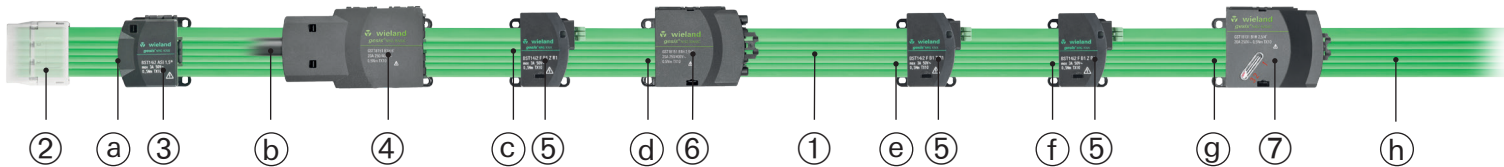

## The system – KNX

Flat cable (each with 2 x 1.5mm <sup>2</sup> screened bus cable)				Flat cable products		Article number
	Cross section	Material	CPR fire class	Article number		
				Green		
				②	Cable end cap	06.562.4353.0
				③	KNX feed	93.420.5453.0
				④	Mains 5-pole feed	92.050.1553.1
				⑤	KNX taps	93.421.5453.0
				⑥	Mains 5-pole tap	92.051.5453.1
				⑦	Mains 3-pole tap, phase selection	92.031.5453.1
					Cable clip	05.562.3000.0
					Cable shears for step cut	95.300.0600.0
<b>Key</b>						
a	KNX supply cable, e.g. Y(ST)Y 2x2x0.8 or a different KNX-certified cable					
b	Mains supply cable, e.g. NYM 5G4 mm <sup>2</sup>					
c	KNX outlet, e.g. to the <b>gesis</b> ®FLEX base module					
d	Mains 5-pole outlet, e.g. to the <b>gesis</b> ®FLEX base module					
e	KNX outlet, e.g. to KNX buttons					
f	KNX outlet, e.g. to KNX presence detectors					
g	Mains 3-pole outlet, e.g. to the <b>gesis</b> ®FLEX fan coil actuator					
h	Flat cable to further room units					

## Example



The 7-pole **gesis**®NRG BASIC+SELV flat cable 5G2.5+2x1.5 mm<sup>2</sup> supplies energy (3-phase) and the KNX to the area. Consumers/field devices/actuators/module units can then be supplied directly with mains power via 3-pole flat cable adapters with phase selection; the KNX is tapped via a further 2-pole adapter. With the use of Wieland KNX systems, the room automation components are then connected via a **gesis**® connecting cable.



## Materials list

Product	Article number	Length Pieces	Comments
gesis NRG BASIC+SELV flat cable 5G2.5+2x1.5 mm <sup>2</sup> , green	00.712.0323.7	6 m	Flat cable with 3-phase mains and KNX
gesis NRG cable end cap 5G2.5/4+2x1.5 mm <sup>2</sup>	06.562.4353.0	2	Two cable end caps per flat cable harness
gesis NRG BASIC flat cable feed mains	92.050.1553.1	1	One mains feed per flat cable harness
gesis NRG BASIC+SIGNAL flat cable feed SELV	93.420.5453.0	1	One KNX feed per flat cable harness
gesis NRG BASIC flat cable adapter GST18i3, 3-pole, code 1, black, with phase selection	92.031.5453.1	2	One mains flat cable outlet per consumer/field device/actuator/module unit
gesis NRG BASIC+SELV flat cable adapter BST14i3, 2-pole, green	93.421.5453.0	2	One KNX flat cable outlet per field device/actuator/module unit
gesis CLASSIC connecting cable 3G1.5 mm <sup>2</sup> , x m, code 1, black	92.232.x000.1	2	Connecting cable between flat cable and consumer/field device/actuator/module unit
gesis NV connecting cable 2x0.5 mm <sup>2</sup> , x m, code green (KNX)	94.425.x000.7	2	Connecting cable between flat cable and field device/actuator/module unit
gesis KNX FLEX base module	83.020.0601.0	1	Base module for managing up to 6 extension modules
gesis FLEX binary input 8-fold	83.020.0622.0	1	8-fold binary input to incorporate conventional local buttons
gesis FLEX DALI output 4-fold	83.020.0630.0	1	Extension module as 4-fold DALI actuator for managing 4x 16 electronic ballasts (broadcast)
gesis FLEX sunblind outlet 2-fold 230 V	83.020.0624.0	1	Extension module as 2-fold sunblind actuator for AC 230 V drives
gesis EIB V sunblind outlet 2-fold 230 V	83.020.0221.4	1	2-fold sunblind actuator for AC 230 V drives
Cable clip	05.562.3000.0	12	For fixing the flat cable in place, optional
Cable shears for step cut	95.300.0600.0	1	Mandatory for working on cable ends

## Planning

### Flat cable

- PVC cable in green for mains + SELV, 5G2.5+2x1.5 mm<sup>2</sup> cross section

### Supply cable

- KNX from the sub-distributor
- 5-pole mains from the sub-distributor, preferably as 4 mm<sup>2</sup> model to minimize voltage drops and associated losses
- We recommend fuse protection with three individual 16 A circuit breakers with upstream residual current circuit breaker 4-pole / 40 A / 30 mA. The specifications of VDE 0100-520, as defined for conventional round cables, apply to the layout. The maximum fuse protection is 20 A.

### Outlets to the individual actuators / sensors

- One mains and KNX adapter each for KNX actuators
- One KNX adapter each for KNX sensors
- Note: The KNX cables are from the BST14i2 product range. The connector interface is stipulated in the KNX manual – KNX Connector Type 7.1 can be found in Volume 9 Chapter 3.9

### Fastening of the flat cable

Country-specific installation specifications must be observed. Fastening every 50 cm is recommended as is fastening of the adapters to the designated mounting holes.

### Advantage of this installation option:

The 7-pole **gesis**<sup>®</sup>NRG flat cable for mains + SELV bus systems ideally represents the bus structure of the KNX system; this results in clear structures that are easy to maintain. The use of three-phase systems up to just before the consumers reduces cable quantities and therefore provides for a resource-efficient installation in many areas. In addition, the reduced zero conductor current reduces the voltage drop, thereby ultimately saving energy.

**Power**  
230/400 V  
50 A

# Mains 5-pole 10 mm<sup>2</sup>

## Application of energy supply in the area

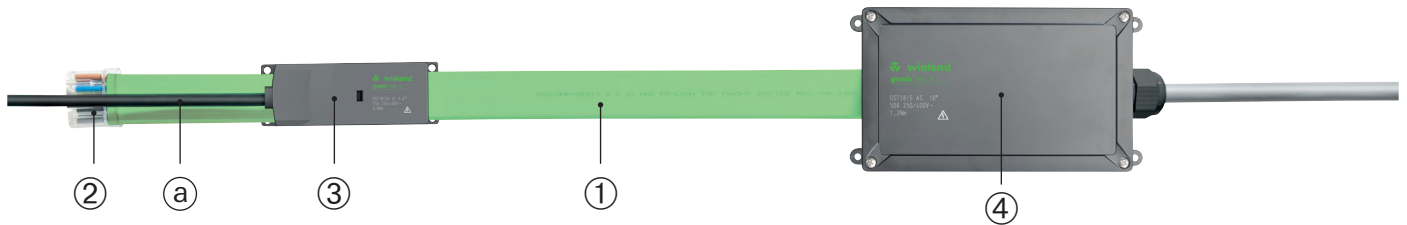

### The system – 10 mm<sup>2</sup> cable

Flat cable (each with 2x1.5mm <sup>2</sup> bus cable)				Flat cable products	Article number	
	<b>Cross section</b>	<b>Material</b>	<b>CPR fire class</b>	②	Cable end cap	05.563.9553.0
				③	Outlet adapter	92.050.9153.0
①	10mm <sup>2</sup>	PVC	Eca	④	Feed	92.050.9053.0
①	10mm <sup>2</sup>	Halogen-free	Eca			
①	10mm <sup>2</sup>	Halogen-free "CPR"	Cca			
			similar to RAL 6018			
<b>Key</b>						
a	Outlet cable					

### Example

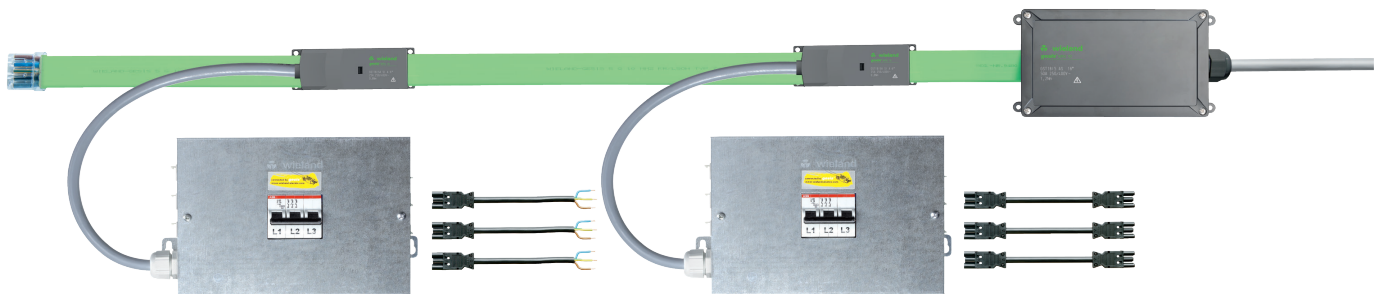

The 5-pole **gesis**® NRG flat cable 5G10 mm<sup>2</sup> supplies energy (3-phase, up to 50 A) to the area. Here, **gesis**® RAN system distribution units are then connected to pre-assembled connection cables and flat cable adapters. The system distribution units are built to the customer's wishes and contain the necessary protective devices as well as the pluggable outlets needed for the application.

## Materials list

Product	Article number	Length Pieces	Comments
gesis NRG flat cable 5G10 mm <sup>2</sup> , green	00.702.0306.7	4 m	Flat cable harness for supplying energy to the area
gesis NRG cable end cap 5G10 mm <sup>2</sup>	05.563.9553.0	1	One cable end cap per flat cable harness when using the end feed
gesis NRG flat cable feed	92.050.9053.0	1	One feed per flat cable harness
gesis RAN system distribution unit with pre-assembled connection cable (max. 3 m) and flat cable adapter	G0.000.xxxx.x	2	System distribution unit with protective devices and pluggable outlets according to customer's wishes
Cable clip	05.563.9753.0	8	For fixing the flat cable in place, optional
Cable shears for step cut	95.300.0300.0	1	For working on cable ends, optional

## Planning

### Flat cable

- The 5G10 mm<sup>2</sup> PVC flat cable is laid in the cable support system. The cable support system is arranged so that the flat cables form a comprehensive energy supply system for electrical retailers, for example.

### Fuse protection and supply cable

- The supply cable is 5G16 mm<sup>2</sup>. The high cross section is used to minimize voltage drops and associated power losses as well as loop resistances.
- Cable protection can be achieved with 50 A. The specifications of VDE 0100-520, as defined for conventional round cables, apply to the layout.

### Outlets

The individual outlets have a maximum current carrying capacity of 32 A and are connected with the decentralized fuse in a system distribution unit directly with a 6 mm<sup>2</sup> cable that is shorter than 3 m. The fuses must be laid out such that the cable is protected between the flat cable and the system distribution unit. This cross section reduction complies with DIN VDE 0100-430 (VDE 0100-430):2010-10, Section 433.2.2. The system distribution units have pluggable outlets from the **gesis**<sup>®</sup> product range, thereby enabling problem-free and quick electrification of the display space in the event of a modification.

### Fastening of the flat cable

Country-specific installation specifications must be observed. Fastening every 50 cm is recommended as is fastening of the adapters to the designated mounting holes.

### Advantage of this installation option:

Using the **gesis**<sup>®</sup>NRG flat cable system 5G10 mm<sup>2</sup> as the infrastructure for the energy supply results in clear structures that are easy to maintain. Adjustments to a changed use of the areas supplied can be achieved very quickly and without moving, cutting, baring, stripping, and wiring cables. The use of three-phase systems up to just before the consumers reduces cable quantities and therefore provides for a resource-efficient installation in many areas. In addition, the reduced zero conductor current reduces the voltage drop, thereby ultimately saving energy.

# Installation instructions

## Flat cable system 5 and 7-pole

Flat cable system, 5-pole, open-ended

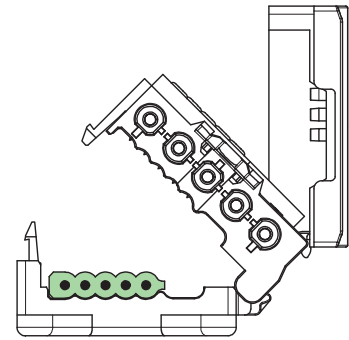

### Installing outputs

using the example of the GST18i3 tap

1. Install the flat cable in a suitable cable-routing system. Note the laying direction for the output direction of the connectors. Insert the flat cable into the coded baseplate (92.051.5453.1 for green/black cable, 92.051.5553.0 for blue cable, 93.421.5453.0 for green cable, 91.021.5453.0 for black cable) so that it lies flush.
2. If necessary, fasten the baseplate to the desired subsurface using the mounting holes.
3. Close the connection module and engage it with a clearly audible click.
4. GST18i3 only: bring phase selection slider to the desired position until it engages with a clearly audible click.
5. Tighten contact screws (0.5 Nm).
6. **Phase change:** (GST18i3 only) Loosen the screw on the phase selection slider until the red ring is flush with the white contact slider. Select the phase again and tighten the screw (0.5 Nm).
7. Close the cover and engage it with a clearly audible click.  
**Caution:** The screws are not all correctly tightened if the cover does not completely close!
8. Attach GST18i3, GST18i5, GST15i2, BST14 plug connector depending on the adapter and engage it with a clearly audible click.

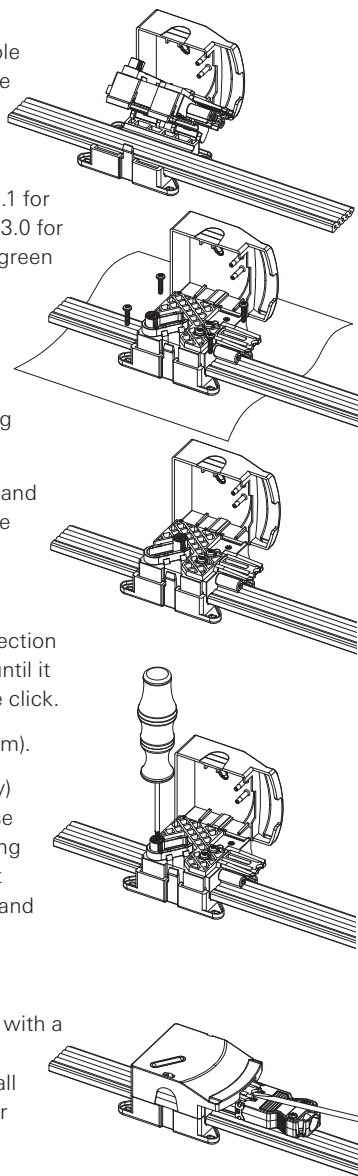

### Installing feed

using the example of a 5-pole feed

1. Insert the sheath stripped (PE: 100 mm, L1/D1: 82 mm, N: 72 mm, L2/D2: 62 mm, L3: 56 mm, stripping tool in the lid) and insulation stripped (8 mm) conductors into the marked termination points one after the other and fasten the contact screw (0.5 Nm).
2. Insert the feed cable into the strain relief and use both screws to tighten the strain relief bracket (0.6 Nm).
3. Insert the flat cable into the coded baseplate (92.050.1553.1 for green/black cable, 92.050.1653.0 for blue cable, 93.420.5453.0 for green cable, 91.020.5453.0 for black cable) so that it lies flush. Note the laying direction for the output direction of the connectors.
4. If necessary, fasten the baseplate to the desired subsurface using the mounting holes.
5. Tighten contact screws (0.5 Nm).
6. Close the cover and engage it with a clearly audible click.  
**Caution:** The screws are not all correctly tightened if the cover does not completely close!

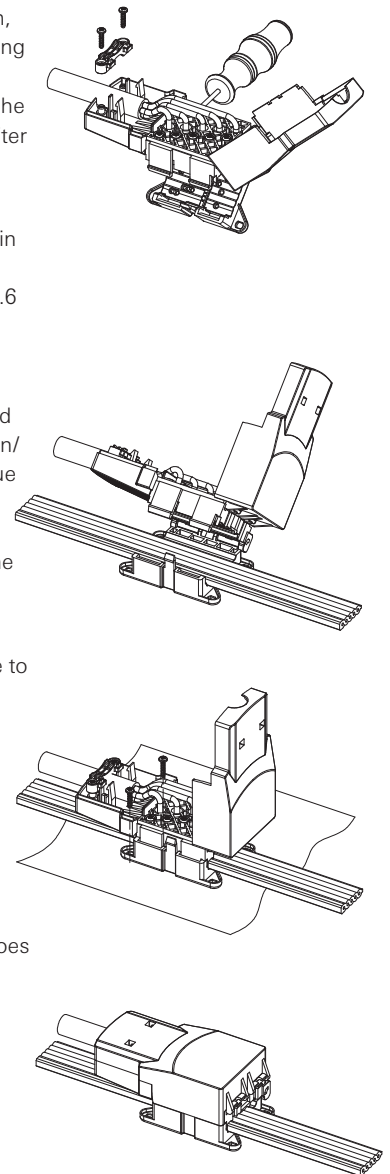

Sheath strip length 2-pole feed: 25 mm  
Insulation strip length 2-pole feed: 8 mm  
For fine-stranded conductors use ferrules

## Removing outputs

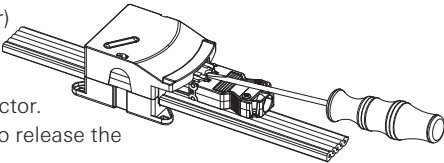
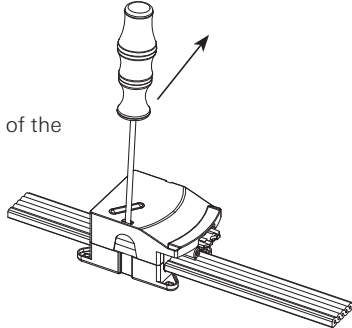
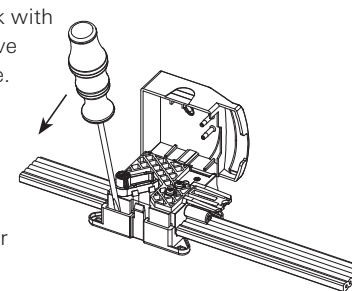
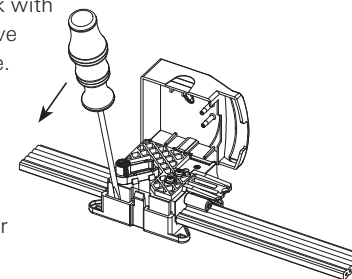
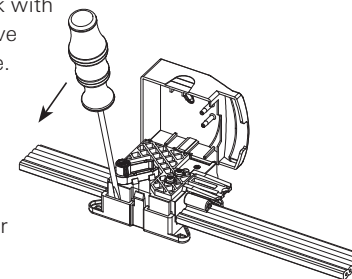
1. Use a tool (screwdriver) to release the connector interlock and remove the connector. No tools are required to release the BST14 connector.
 
2. Push interlock in the direction of the arrow and open the cover.
 
3. Loosen the contact screws.
 
4. Unlock the baseplate interlock with a tool (screwdriver) and remove the module from the flat cable.
 
5. Close the contact openings in the cable with a cable repair patch.
 

## Removing feed

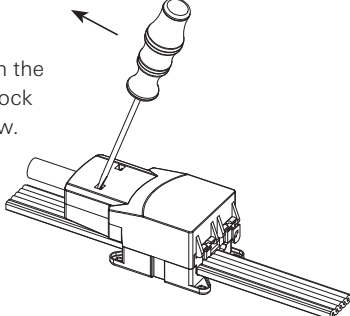
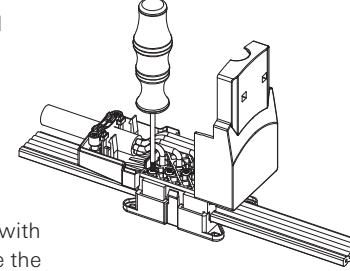
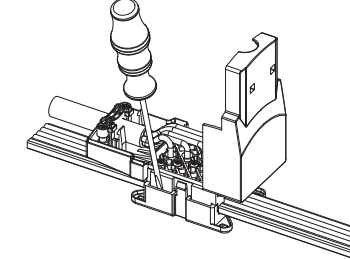
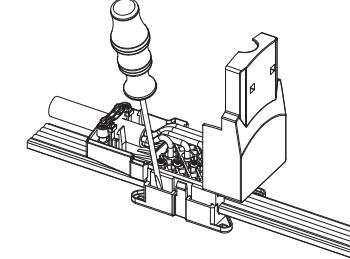
1. Use a tool (screwdriver) to open the cover interlock. Press the interlock lugs in the direction of the arrow.
 
2. Loosen the contact screws and connection screws.
 
3. Unlock the baseplate interlock with a tool (screwdriver) and remove the module from the flat cable.
 
4. Close the contact openings in the cable with a cable repair patch.
 

### Additional information:

- To remove the cover, insert a screwdriver into the slot provided and raise gently.
- **The ends of the flat cable must be cut off with the special cable shears and terminated with the cable end cap.** This guarantees the necessary insulation between the conductors.
- After removing the adapters, the sections of cable that have been terminated with the piercing screws must be sealed with insulating tape.
- Functional capability can only be guaranteed if the original flat cable is used.
- If a screw breaks when positioning an adapter, the adapter should be left in place and labeled as defective. Reliable function cannot be guaranteed!



































### Laying flat cables around curves:

This is best done with an elevation in the inner radius. Please ask our e-Shop about the minimum bending radii.



### General information:

- Cross section reduction (with 10 mm<sup>2</sup>)
- Cross section reduction at the outlet: In accordance with DIN VDE 0100-430 (VDE 0100-430):2010-10, Section 433.2.2, cable protection can be provided along the whole route of the cable if the cable length does not exceed 3 m and the entire cable route has been executed without a plug-in device.
- To ensure adequate selectivity of the protective devices, at least one protection level higher must always be selected between the individual protective devices.

	5G2.5/4 BASIC	5G2.5/4 DIMM	5G2.5/4+2X1.5 no shield	5G2.5/4+2X1.5 shielded	5G10
					
	x=7    x=1		x=6    x=1		
<b>Flat cables</b>					
PVC 2.5 <sup>2</sup> Eca	00.712.0303.x	00.712.0303.6	00.712.1323.x	00.712.0323.7	-
Halogen free 2.5 <sup>2</sup> Eca	00.710.0303.x	00.710.0303.6	00.710.1323.x	00.710.0323.7	-
Halogen free 2.5 <sup>2</sup> Cca	00.750.0303.7	00.750.0303.6	00.750.1323.6	00.750.0323.7	-
Halogen free 4 <sup>2</sup> Eca	00.710.0304.x	00.710.0304.6	00.710.1324.x	00.710.0324.7	-
Halogen free 4 <sup>2</sup> Cca	00.750.0304.7	00.750.0304.6	00.750.1324.6	00.750.0324.7	-
PVC 10 <sup>2</sup> Eca	-	-	-	-	00.702.0306.7
Halogen free 10 <sup>2</sup> Eca	-	-	-	-	00.709.0306.7
Halogen free 10 <sup>2</sup> Cca	-	-	-	-	00.750.0306.7
<b>mains 5-pole feed-in</b>	 92.050.1553.1	-	 92.050.1553.1	 92.050.1553.1	 92.050.9053.0 92.050.8853.0
<b>mains 5-pole tapping L1, L2, L3, N, PE</b> 3~	 92.051.5453.1	-	 92.051.5453.1	 92.051.5453.1	 92.050.9153.0
<b>mains 3-pole tapping L, N, PE</b> 1~	 92.031.5453.1	-	 92.031.5453.1	 92.031.5453.1	-
<b>3-pole mains + signal feed-in</b>	-	 92.050.1653.0	-	-	-
<b>3-pole mains + 250 V signal e.g. DALI tapping L, N, PE, D1, D2</b> 1~ 	-	 92.051.5553.0	 92.051.5653.0	-	-
<b>3-pole mains + 250 V signal e.g. TouchDIM tapping L, N, PE, D1, D2</b> 1~ 	-	 92.051.5553.0	-	-	-
<b>3-pole mains + 250 V signal e.g. SMI tapping L, N, PE, D1, D2</b> 1~ 	-	 92.051.5553.0	-	-	-
<b>only 250 V / 6 A signal e.g. DALI feed-in</b>	-	-	 91.020.5453.0	-	-
<b>only 250 V / 6 A signal e.g. DALI tapping D1, D2</b> 	-	-	 91.021.5453.0	-	-
<b>only SELV 3 A e.g. KNX feed-in</b>	-	-	-	 93.420.5453.0	-
<b>only SELV 3 A e.g. KNX tapping 1+, 2-</b> 	-	-	-	 93.421.5453.0	-
<b>end cap <sup>1)</sup></b>	 06.562.0653.0	 06.562.0653.0	 06.562.9753.0	 06.562.4353.0	 05.563.9553.0
<b>suitable connector (only a selection)</b>	GST18i3 black 92.932.3053.1 GST18i5 black 92.954.4053.1	GST18i5 pastel blue 92.954.4453.0	GST18i3 black 92.932.3053.1 GST18i5 black 92.954.4053.1 GST15i2 pastel blue 91.922.2453.0	GST18i3 black 92.932.3053.1 GST18i5 black 92.954.4053.1 BST14i2 green 93.422.0553.1	-



# Technical consultation

and general information

Use the Wieland hotline – a phone call is all it takes

## Industrial automation, electromechanical

Hotline **+49 951 9324-991**  
E-mail **AT.TS@wieland-electric.com**

## Building and installation technology

Hotline **+49 951 9324-996**  
E-mail **BIT.TS@wieland-electric.com**

## Industrial automation, electronics

Hotline **+49 951 9324-995**  
E-mail **AT.TS@wieland-electric.com**

## Safety technology

Hotline **+49 951 9324-999**  
E-mail **safety@wieland-electric.com**

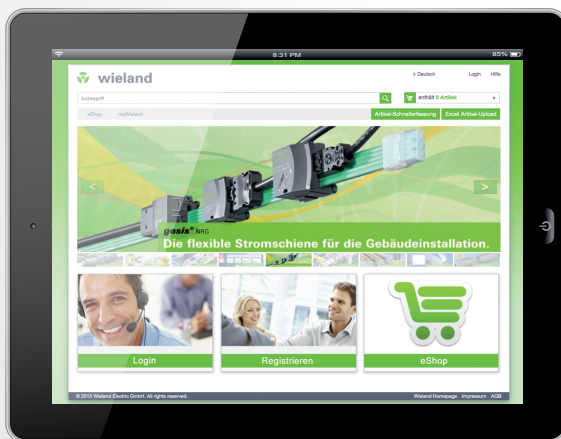

## eShop

Our products can also be found in our online shop at:

[eshop.wieland-electric.com](http://eshop.wieland-electric.com)



## Info & News

Contact your local partner in over 70 countries:

[www.wieland-electric.com](http://www.wieland-electric.com)



**USA & CANADA**  
**Wieland Electric Inc.**  
**North American Headquarters**  
2889 Brighton Road  
Oakville, Ontario L6H 6C9  
Phone +1 905 829-8414  
Fax +1 905 829-8413  
sales@wielandinc.com  
www.wielandinc.com  
www.wieland-electric.ca



**GREAT BRITAIN**  
**Wieland Electric Ltd.**  
Riverside Business Centre,  
Walnut Tree Close  
GB Guildford/Surrey GU1 4UG  
Phone +44 1483 531213  
Fax +44 1483 505029  
sales.uk@wieland-electric.com  
www.wieland.co.uk



**ITALY**  
**Wieland Electric S.r.l.**  
Via Edison, 209  
I-20019 Settimo Milanese  
Phone +39 02 48 916357  
Fax +39 02 48 920685  
info.italy@wieland-electric.com  
www.wieland-electric.it



**FRANCE**  
**Wieland Electric SARL.**  
Le Cérame, Hall 6  
47, avenue des Genottes  
CS 48313,  
95803 Cergy-Pontoise Cedex  
Phone +33 1 30320707  
Fax +33 1 30320717  
info.france@wieland-electric.com  
www.wieland-electric.fr



**SPAIN**  
**Wieland Electric S.L.**  
C/ Maria Auxiliadora 2, bajos  
E-08017 Barcelona  
Phone +34 93 2523820  
Fax +34 93 2523825  
ventas@wieland-electric.com  
www.wieland-electric.es



**SWITZERLAND**  
**Wieland Electric AG**  
Harzachstrasse 2b  
CH-8404 Winterthur  
Phone +41 52 2352100  
Fax +41 52 2352119  
info.swiss@wieland-electric.com  
www.wieland-electric.ch



**BELGIUM & GD LUXEMBOURG**  
**ATEM-Wieland Electric NV**  
Bedrijvenpark De Veert 4  
B-2830 Willebroek  
Phone +32 3 8661800  
Fax +32 3 8661828  
info.belgium@wieland-electric.com  
www.wieland-electric.be



**DENMARK**  
**Wieland Electric A/S**  
Vallørækken 26  
DK-4600 Køge  
Phone +45 70 266635  
Fax +45 70 266637  
sales.denmark@wieland-electric.com  
www.wieland-electric.dk



**SWEDEN**  
**Wieland Electric AB**  
Krossverksgatan 9B  
216 16 Limhamn  
Phone +46 40 652 90 00  
sales.sweden@wieland-electric.com  
www.wieland-electric.se



**POLAND**  
**Wieland Electric Sp. z o.o.**  
Św. Antoniego 8  
62-080 Swadzim  
Phone +48 61 2225400  
office@wieland-electric.pl  
www.wieland-electric.pl



**CHINA**  
**Wieland Electric Trading**  
Unit 2703 International Soho City  
885 Renmin Road,  
Huangpu District  
PRC- Shanghai 200010  
Phone +86 21 63555772  
Fax +86 21 63550090  
info-shanghai@wieland-electric.com  
www.wieland-electric.cn



**JAPAN**  
**Wieland Electric Co, Ltd.**  
Nisso No. 16 Bldg. 7F  
3-8-8 Shin-Yokohama,  
Kohoku-ku  
Yokohama 222-0033  
Phone +81 45 473 5085  
Fax +81 45 470 5408  
info-japan@wieland-electric.com



**GERMANY**  
**Headquarters**  
**Wieland Electric GmbH**  
Brennerstraße 10 – 14  
96052 Bamberg, Germany  
Phone +49 951 9324-0  
Fax +49 951 9324-198  
info@wieland-electric.com  
www.wieland-electric.de

**Sales Partner:**  
**You can reach us worldwide in more than 70 countries.**  
**Find the contact adress at: [www.wieland-electric.com](http://www.wieland-electric.com)**

Subject to technical modifications!  
**gesis<sup>®</sup>, RST<sup>®</sup>, GST<sup>®</sup>, GST18<sup>®</sup>, podis<sup>®</sup>, samos<sup>®</sup>, saris<sup>®</sup>** and  
**wiecon<sup>®</sup>** are registered trademarks of Wieland Electric GmbH