



1000 SERIES

THUMBWHEEL SWITCHES

If a front panel, pushwheel switch in the smallest possible package is part of your design requirements, EECO's 1000 Series is the ideal solution

The **1000 Series** is the smallest rear-mount pushwheel digital switch available today. Actuation methods include thumbwheel, push-set and pen-set models. The pen-set version eliminates the possibility of accidental setting changes, and is ideal for critical "set and forget" applications. The **1000 Series** is offered in either binary or decimal code versions, and optional features include stop pins, and provision for diode installation. The **1000 Series** is backed by EECO's one-year warranty.

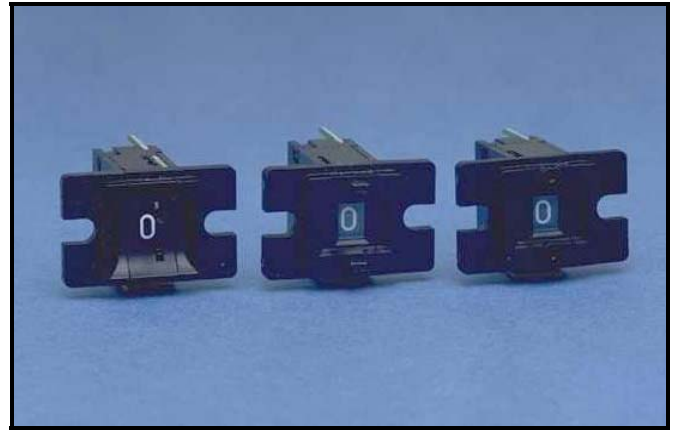

SPECIFICATIONS

MECHANICAL

No. of Switching Positions	10
Life	Minimum 300,000 Detents
Actuation Force	10.5 Oz.
Weight	0.11 Oz.

ELECTRICAL

Maximum Rated Load, Non-Switching	500 mA Per Common Terminal
Maximum Rated Load, Switching	100 mA At 50 VAC or 28 VDC
Contact Resistance (Initial)	200 mΩ Maximum
Insulation Resistance	10 MΩ Minimum
Dielectric Withstanding Voltage	500 VAC For 1 Minute

ENVIRONMENTAL

Operating Temperature	-20°C To +60°C
Storage Temperature	-40°C To +80°C
Vibration	50 m/Sec ² (5-55Hz)
Shock	100 m/Sec ² (10G)
Seal	Dust Resistant

MATERIALS

Plastic	Polyacetal Resin
Circuit Board	
Base Material	Glass Epoxy
Plating	Gold Over Nickel Plating
Termination	Plated Through Holes
Contacts	Copper Alloy, Gold Over Nickel Plating

RoHS COMPLIANCE

EECO Switch is fully committed to complying with the European Lead-Free and RoHS directives. The 1000 Series is Lead Free and RoHS compliant.

OUTLINE DIMENSIONS

R E A R M O U N T

1000 THUMBWHEEL

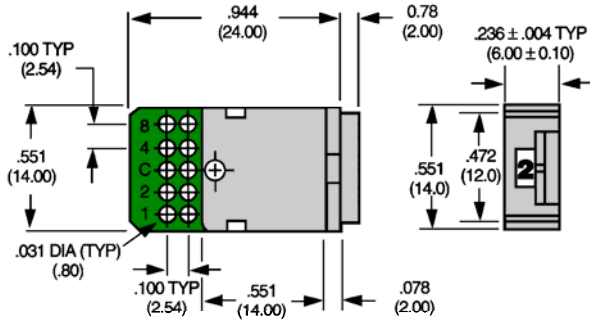

- NOTES;
1. Character Height is .126 (3.2)
 2. () dimensions in mm.
 3. Tolerance on all dimensions .010 unless otherwise specified

1001 PUSH-SET

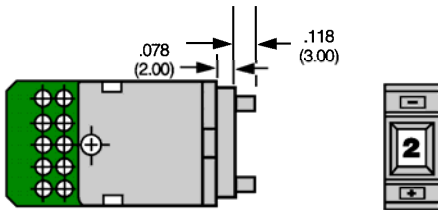

DECIMAL CODE MODELS

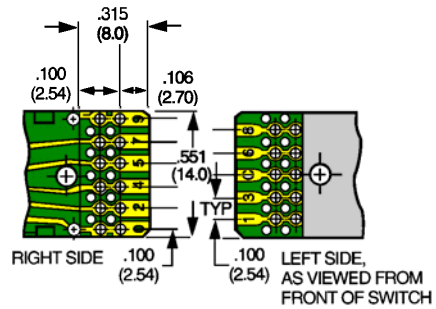

1002 PEN-SET

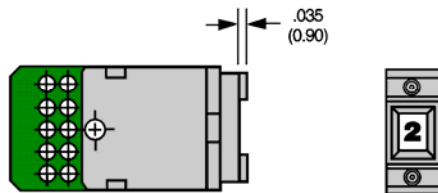

PCB WITH DIODE PROVISION

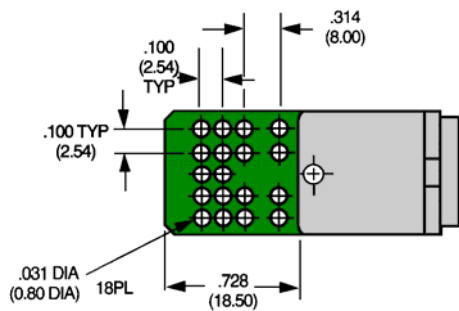

"F" OPTION PIN SPACING

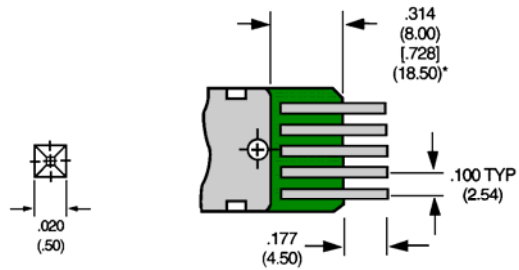

"F" Option Not Available On Decimal Code Models.

MOUNTING DIMENSIONS

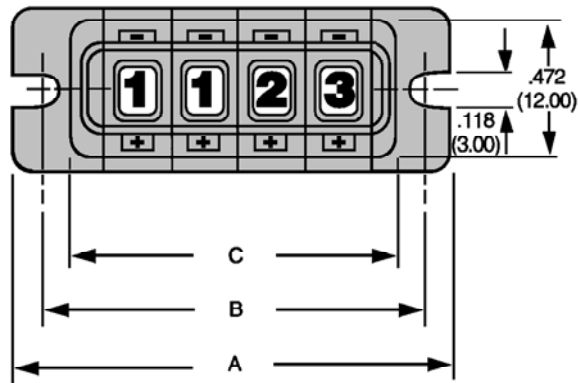

PANEL CUT-OUT

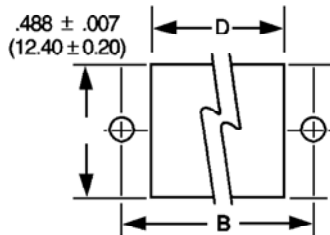

No. Of Switches	A	B	C	D
1	0.866 (22.0)	0.669 (17.0)	0.472 (12.0)	0.480 (12.2)
2	1.102 (28.0)	0.906 (23.0)	0.709 (18.0)	0.717 (18.2)
3	1.339 (34.0)	1.142 (29.0)	0.945 (24.0)	0.953 (24.2)
4	1.575 (40.0)	1.378 (35.0)	1.181 (30.0)	1.189 (30.2)
5	1.811 (46.0)	1.614 (41.0)	1.417 (36.0)	1.425 (36.2)
6	2.047 (52.0)	1.850 (47.0)	1.654 (42.0)	1.661 (42.2)
7	2.283 (58.0)	2.087 (53.0)	1.890 (48.0)	1.898 (48.2)
8	2.520 (64.0)	2.323 (59.0)	2.126 (54.0)	2.134 (54.2)
9	2.756 (70.0)	2.559 (65.0)	2.362 (60.0)	2.370 (60.2)
10	2.992 (76.0)	2.795 (71.0)	2.598 (66.0)	2.606 (66.2)

Metric dimensions in ()
 "D" Dimensions ±.007 (0.2)

OUTLINE DIMENSIONS- Spacers And Endpieces

END PIECES
E10SJ (1000 THUMBWHEEL)

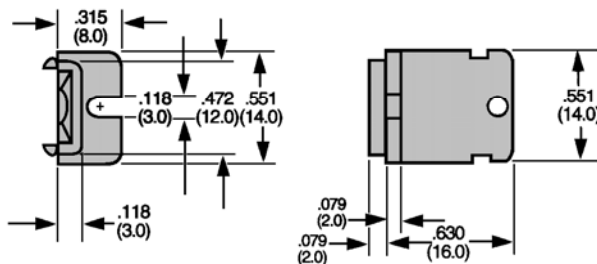

SPACERS
S10SJ (1000 THUMBWHEEL)

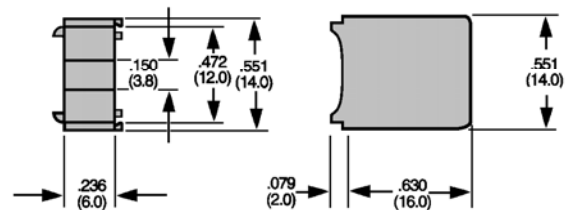

E30SJ (1001, 1002 PUSHWHEEL)

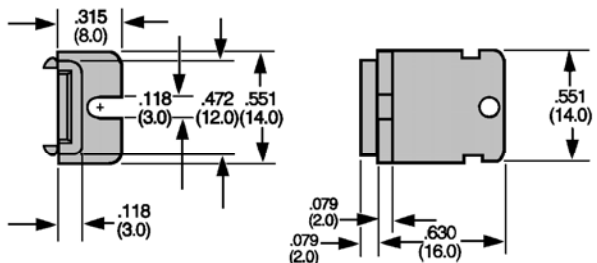

S30SJ (1001, 1002 PUSHWHEEL)

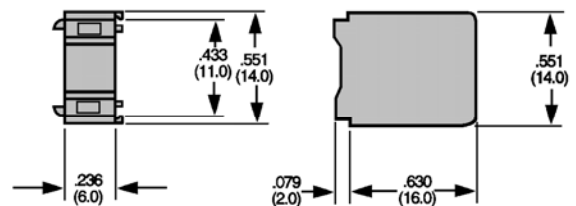

NOTE: Endpieces sold as pairs

1000 Series

1000 SERIES STANDARD SWITCHES

THUMBWHEEL	PUSH-SET	PEN-SET	CODE DESCRIPTION	NO. OF POSITIONS	TRUTH TABLE
100001J	100101J	100201J	1 Pole Decimal	10	A02
100002J	100102J	100202J	1 Pole BCD	10	B02
100052J	100152J	100252J	1 Pole BCD w/Diode Provision	10	B02

A02

DECIMAL 1 Pole 10 Position

D I A L	Common (C) Connected To ●									
	0	1	2	3	4	5	6	7	8	9
0	●									
1		●								
2			●							
3				●						
4					●					
5						●				
6							●			
7								●		
8									●	
9										●

B02

BCD 1 Pole 10 Position

D I A L	Common (C) Connected To ●			
	1	2	4	8
0				
1	●			
2		●		
3	●	●		
4			●	
5	●		●	
6		●	●	
7	●	●	●	
8				●
9	●			●

AVAILABLE OPTIONS

D Decimal Point
C Stop Pins (Factory Installed Only)

HARDWARE KITS AND ACCESSORIES

10SJ-X Hardware Kit: Nuts, Rods (Thumbwheel)
30SJ-X Hardware Kit: Nuts, Rods (Push Button)
E10SJ Endpieces (Thumbwheel, Pairs)
E30SJ Endpieces (Push Button, Pairs)
S10SJ Spacer (Thumbwheel)
S21SJ Spacer (Push Button)

Note: Replace "X" With Number of Stations Required When Ordering Hardware Kits

ORDERING EXAMPLE

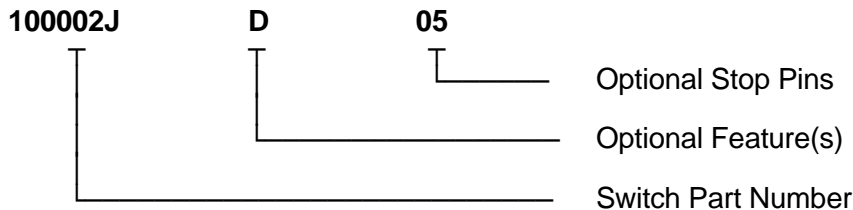

NOTE: 1000 Series Switches And Endpieces Sold Unassembled