

Dialight

.....



Vigilant[®] LED Based Obstruction Lights



On when it matters most.

Products and solutions that protect your business

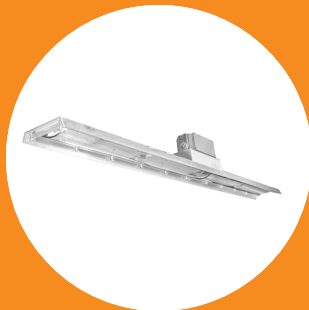
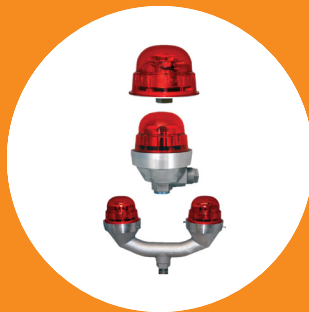

Dialight's LED Technology Innovations Over the Years

First ever FAA certified LED obstruction light

Vigilant LED Based High Intensity Strobe

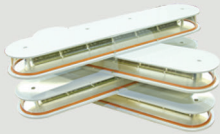

2011 - (White)

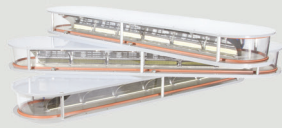

2013 - (White / Red)

Vigilant LED Based L-810 Red LED Obstruction Light



1999



2007

Vigilant LED Based L-864 Red Beacon



2001



2004

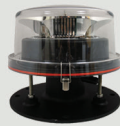

2006



2013

Vigilant LED Based L-865 / L-864 Flashing Dual (White / Red) Strobe



2007



2008

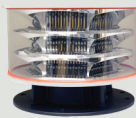

2009

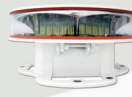

2012



2013

Features & Benefits

- 5 year warranty
- Resistant to shock and vibration
- High impact polycarbonate lens with UV, scratch and chemical resistant coating
- Reduction in tower climbs for lower maintenance costs/unplanned site visits
- Smallest flash head in the industry
- Community friendly lighting system utilizing patented optics

Dialight Timeline

- 1999** - First ever FAA certified LED L810
- 2001** - First ever FAA certified LED L864
- 2007** - First ever FAA certified LED L865/L864
- 2011** - First ever FAA certified LED L856
- 2012** - First ever FAA certified LED L856/L864

Dialight (LSE: DIA.L) is leading the energy efficient LED lighting revolution around the world for industrial and hazardous areas as well as transportation and infrastructure applications. For 40 years it has been committed to the development of LED lighting solutions that enable organizations to vastly reduce energy use and maintenance needs, improve safety, ease disposal and reduce CO2 emissions.

Vigilant LED Based L-856 / L-864

High Intensity (White / Red) Strobe

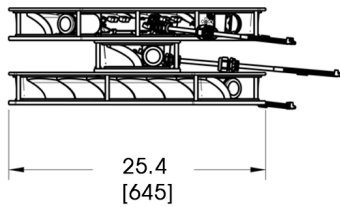
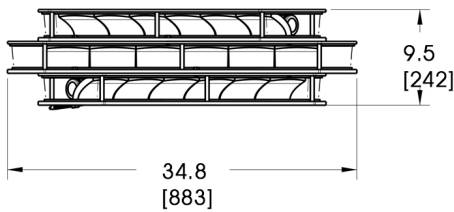
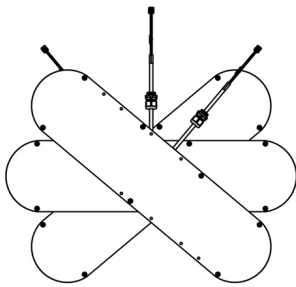

Dimensions in inches [mm]

Certifications & Compliance

- FAA AC 150 / 5345 - 43G
- FAA EB No. 67D
- IP66
- Transport Canada CAR 621.19
- ICAO Annex 14
- DGAC Mexico

Features & Benefits

- ETL verified to FAA standards
- Superior surge and lightning protection
- Patented optics for minimal down light / ground scatter
- Ideal for broadcast towers, stacks and other tall structures
- 360 degree coverage using three (3) flash heads
- Maximum of 18 synchronized flash heads for each controller
- Shock and vibration resistant
- Lighting and hardware kits available for standard towers

Mechanical Information:

- Flash head weight:** 63 lbs (30 kg)
- Operating voltage:** 208 - 277V AC 50/60Hz
- Effective intensity:**
 - White Day - 270,000 cd
 - White Twilight - 20,000 cd
 - White Night - 2,000 cd
 - Red - 2,000 cd
- Wattage:**
 - White Day - 160W
 - White Twilight - 30W
 - White Night - 23W
 - Red Night - 30W
- Power factor:** > 0.9
- Ambient temperature:** -40°F to +131°F (-40°F to +55°F)
- Synchronization:** Multiple unit sync from single controller

All values typical unless otherwise stated (tolerance +/- 10%)

US Patent #7,281,821 (other patents pending)

Part Number	Description	Voltage	Certification / Compliance
D266-A57-270	Flash head and power supply	208 - 277V AC	FAA (TC) L-864/L-856
D266-A57-CTRAC	Base controller with display (for use with AC side markers)	208 - 277V AC	FAA (TC) L-864/L-856
D256-6000-PEC	Twilight / Night photocell with enclosure and 3/4 inch conduit entry		FAA (TC) L-864/L-856
D1RW-C13-009CVT	Aviation obstruction light (AOL) flash head and power supply - 4 Conductors	120 - 277V AC	FAA (TC) L-864/L-865

Vigilant LED Based L-865 / L-864 (+IR) (+GPS)

Medium Intensity (White / Red) Strobe - Infrared (IR) or GPS models available

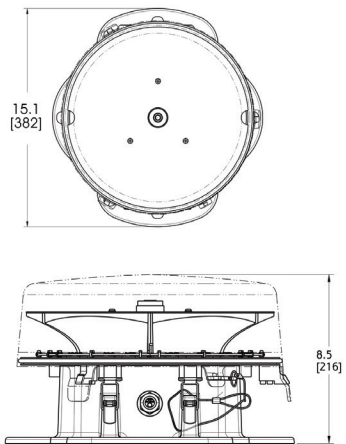

Dimensions in inches [mm]

Flip top design for simple installation

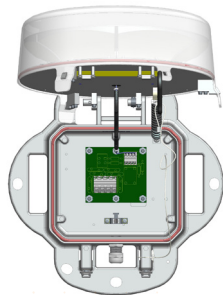
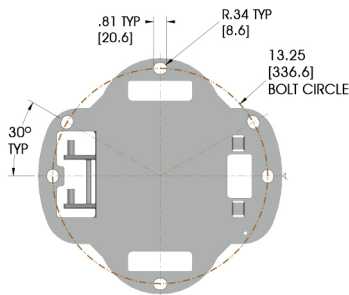

Certifications & Compliance

- FAA AC 150 / 5345 - 43G
- FAA EB No. 67D
- IP66
- Transport Canada CAR 621.19
- ICAO Annex 14
- DGAC Mexico

Features & Benefits

- ETL verified to FAA standards
- Superior surge and lightning protection
- Patented optics for minimal down light / ground scatter
- Remote monitoring options available
- Compact, low power design
- Ideal for towers, stacks, wind turbines, buildings, etc.
- 360 degree coverage for each flash head
- Shock and vibration resistant
- Lighting and hardware kits available for standard towers
- GPS synchronized controller available

Mechanical Information:

Flash head weight:	21 lbs (9.5 kg)
Operating voltage:	120 - 277V AC 50/60Hz or 48V DC power factor corrected supply (see below for options)
Supply voltage ranges:	Nominal +/- 10%
Effective intensity:	White Day - 20,000 cd White Night - 2,000 cd Red Night - 2,000 cd
Flash head power:	White Day - 36W (system = 75w) White Night - 4W (system = 10w) Red Night - 12W (system = 25w)
Power factor:	> 0.9
Operating temperature:	-40°F to +131°F (-40°C to +55°C)
Synchronization:	Multiple unit sync from single controller

All values typical unless otherwise stated (tolerance +/- 10%)

US Patents #7,208,881 #7,568,821 #7,604,380 #7,777,424



Class I, Div 2 models available

Part Number	Description	Voltage	Certification / Compliance
Standard Models			
D1RW-C13-409SYS	Medium intensity dual (white / red) AC system	120 - 277V AC	FAA (TC) L-865 / L-864
D1RW-C14-409SYS	Medium intensity dual (white / red) DC system	+/- 48V DC	FAA (TC) L-865 / L-864
Infrared (IR) Models			
D1CW-C13-409SYS	Medium intensity dual (white / red) +IR AC system	120 - 277V AC	FAA (TC) L-865 / L-864 +IR
D1CW-C14-409SYS	Medium intensity dual (white / red) +IR DC system	+/- 48V DC	FAA (TC) L-865 / L-864 +IR

¹GPS synchronized controller available

Vigilant LED Based L-864 (+IR)

Medium Intensity (Red) Beacon - Infrared (IR) models available



Certifications & Compliance

- FAA AC 150 / 5345 - 43G
- FAA EB No. 67D
- IP66
- Transport Canada CAR 621.19
- ICAO Annex 14
- DGAC Mexico

Features & Benefits

- ETL verified to FAA standards
- Superior surge and lightning protection
- Patented optics for minimal down light / ground scatter
- Controllers available for all applications
- Compact, low power design
- Ideal for towers, stacks, wind turbines, buildings, etc.
- 360 degree coverage for each flash head
- Shock and vibration resistant
- Lighting and hardware kits available for standard towers

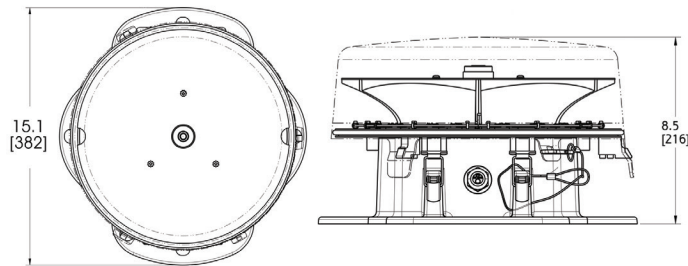

Dimensions in inches [mm]

Flip top design for simple installation

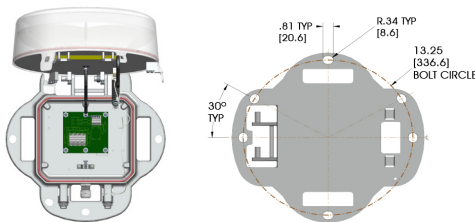

SafeSite Class I, Div 2 - models available

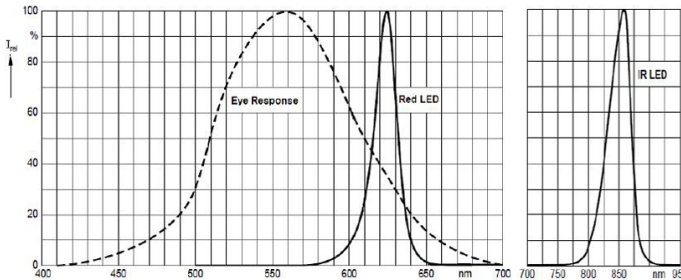

Mechanical Information:

- Unit weight:** 18 lbs (8.2 kg)
- Operating voltage:** AC: 120 - 240V AC 50/60Hz power factor corrected supply
DC: 24 - 48V DC +/- 10%
- Supply voltage ranges:** Nominal +/- 10%
- Effective intensity:** 2,000 cd
- Wattage:** 3.3W (16.7% duty cycle) - standard
7.0W (16.7% duty cycle) - IR models
20W flashes per minute with 0.5 sec. on time
- Operating temperature:** -40°F to +131°F (-40°C to +55°C)
- Power factor:** > 0.9

All values typical unless otherwise stated (tolerance +/- 10%)

US Patents # 7,281,821#7,568,821 (other patents pending)

Class I, Div 2 models available



Part Number	Description	Voltage	Certification / Compliance
Standard Models			
D564-A13-001	Flash head	120 - 240V AC	FAA (TC) L-864
D464-A54-001	Flash head	24 - 48V AC	FAA (TC) L-864
Infrared (IR) Models			
D464-R13-001	Flash head - Red + Infrared (IR)	120 - 240V AC	FAA (TC) L-864

*Night Vision Goggles (NVG) and Aviator Night Vision Imaging Systems (ANVIS) sense infrared (IR) light at various wavelength ranges. Accordingly, Dialight makes no claim or representation that the IR light emitted by the Vigilant light is visible to any make or models of any NVG or ANVIS. In no event shall Dialight or any of its representatives be liable for any damages, including, without limitation, direct, consequential, indirect, punitive, incidental or special damages, in connection with the IR light emitted by the Vigilant light and/or whether any NVG or ANVIS can sense such IR light or whether the IR light emitted by the Vigilant light is visible to any NVG or ANVIS, regardless of the form of action.

Vigilant LED Based L-864

Medium Intensity (Red) GPS Beacon

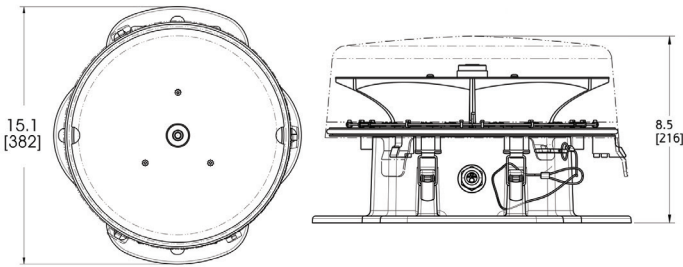

Dimensions in inches [mm]

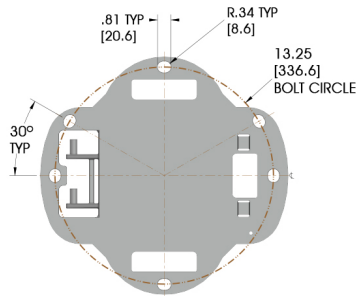

Patented Optics

Minimum ground scatter for a "community-friendly" lighting system

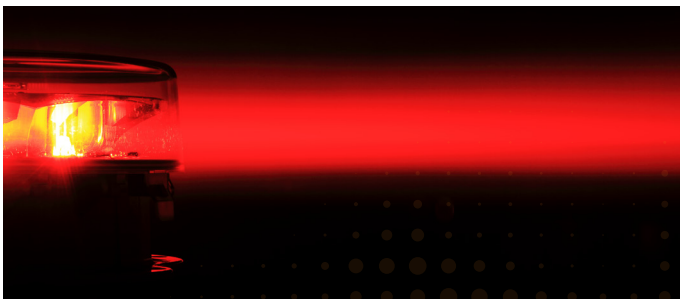

Certifications & Compliance

- FAA AC 150 / 5345 - 43G
- FAA EB No. 67D
- IP66
- Transport Canada CAR 621.19
- ICAO Annex 14
- DGAC Mexico

Features & Benefits

- ETL verified to FAA standards
- Superior surge and lightning protection
- Self-contained unit (no exterior controller)
- Patented optics for minimal down light / ground scatter
- Integrated photocell and GPS synchronized flasher
- Ideal for MET towers, wind turbines, bridges, buildings, etc.
- 360 degree coverage for each flash head
- Shock and vibration resistant
- Lighting kits available for standard towers
- 6kV of surge protection

Mechanical Information:

- Unit weight:** 20 lbs (9 kg)
- Operating voltage:** 120 - 240V AC, 50/60Hz; Switch selectable
- Flash rate:** 20, 30, or 40 (+/- 1%) flashes per minute (switch selectable); (1/2 ON and 1/2 OFF)
- Effective intensity:** 2,000 cd
- Wattage:** 3.3W (16.7% duty cycle); 20 flashes per minute with 0.5 on time
- Power factor:** > 0.9
- Operating temperature:** -40°F to +131°F (-40°C to +55°C)

All values typical unless otherwise stated (tolerance +/- 10%)

US Patents #7,281,821 #7,568,821 (other patents pending)

Part Number	Description	Voltage	Certification / Compliance
D564-A13-001-GPS	Flash head - integrated GPS, Photocell, Monitoring	120 - 240V AC	FAA (TC) L-864

Vigilant LED Based L-810

Low Intensity (Red) RTO Side Light - Infrared (IR) models available

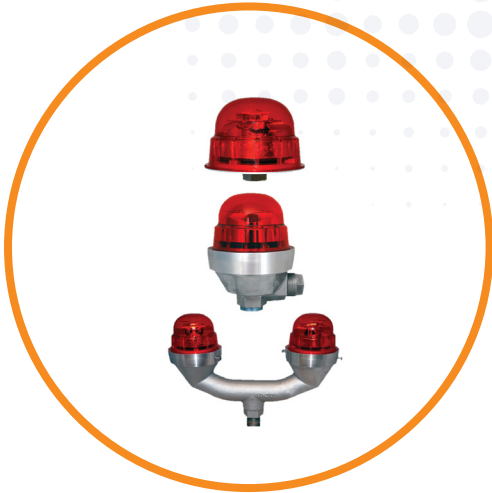

Certifications & Compliance

- FAA AC 150 / 5345 - 43G
- FAA EB No. 67D
- IP66
- German Air Traffic Control Notices for Pilots Part I 6, January 2005
- Transport Canada CAR 621.19
- ICAO Annex 14
- DGAC Mexico
- Nachrichten für Luftfahrer Teil I Langen, 6. Januar 2005

Features & Benefits

- ETL verified to FAA standards
- Superior surge and lightning protection
- Controllers available for all applications
- Compact, low power design
- Ideal for towers, stacks, wind turbines, buildings, etc.
- 360 degree coverage for each flash head
- Shock and vibration resistant
- Lighting kits available for standard towers

Mechanical Information:

Unit weight:	1.25 lbs (0.56 kg) (Retro unit) 2.00 lbs (0.91 kg) (Single unit) 4.60 lbs (2.09 kg) (Dual unit)
Supply voltage ranges:	Nominal +/- 10%
Power factor:	> 0.9 (All AC units)
Operating temperature:	-40°F to +131°F (-40°F to +55°F)
Input AC frequency:	50/60Hz

All values typical unless otherwise stated (tolerance +/- 10%)

US Patent #7,604,384

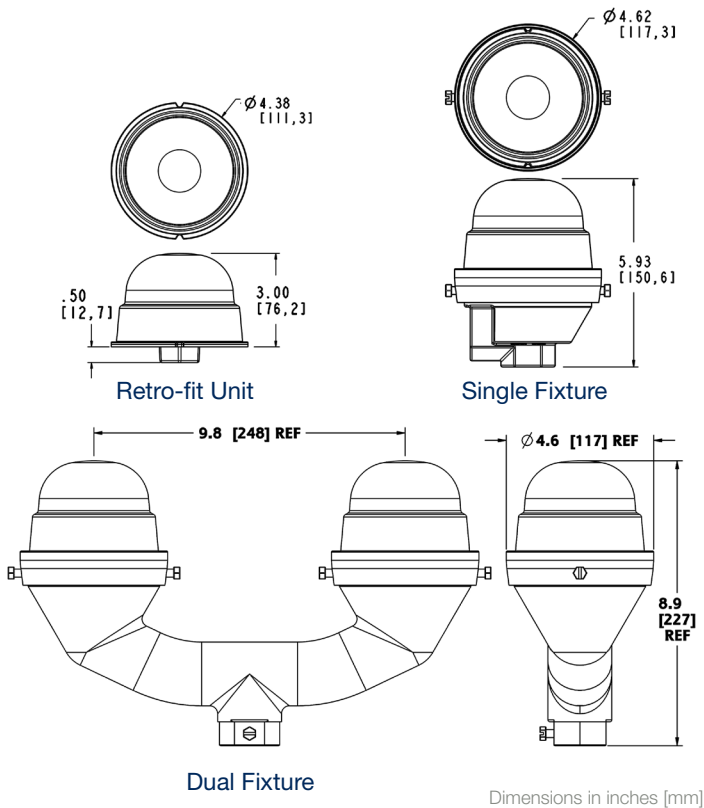

Vigilant LED Based L-810

Low Intensity (Red) RTO Side Light Ordering Information

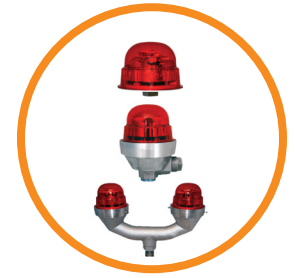

Part Number	Description	Voltage	Certification / Compliance	Wattage
RTO-1R06-001	Single Light	277V AC	FAA (TC) L-810	8.0
RTO-1R07-001	Single Light	120-240V AC	FAA (TC) L-810	6.5
RTO-1R08-001	Single Light	12-48V DC	FAA (TC) L-810	3.5
RTO-1R18-001	Single Light - Low Power	12-48V DC	FAA (TC) L-810	1.5
RTO-1R06-002	Dual Light	277V AC	FAA (TC) L-810	8.0
RTO-1R07-002	Dual Light	120-240V AC	FAA (TC) L-810	6.5
RTO-1R08-002	Dual Light	12-48V DC	FAA (TC) L-810	3.5
RTO-1R18-002	Dual Light - Low Power	12-48V DC	FAA (TC) L-810	1.5
RTO-1R06-004	Single Retro-fit Light	277V AC	FAA (TC) L-810	8.0
RTO-1R07-004	Single Retro-fit Light	120-240V AC	FAA (TC) L-810	6.5
RTO-1R08-004	Single Retro-fit Light	12-48V DC	FAA (TC) L-810	3.5
RTO-1R18-004	Single Retro-fit Light - Low Power	12-48V DC	FAA (TC) L-810	1.5
RTO-CR07-001	Single Light Red / Infrared (IR)	120-240V AC	FAA (TC) L-810	5.5
RTO-CR08-001	Single Light Red / Infrared (IR)	12-48V DC	FAA (TC) L-810	5.0
RTO-CR07-002	Dual Light Red / Infrared (IR)	120-240V AC	FAA (TC) L-810	5.5
RTO-CR08-002	Dual Light Red / Infrared (IR)	12-48V DC	FAA (TC) L-810	5.0
RTO-CR07-004	Single Retro-fit Light Red / Infrared (IR)	120-240 V AC	FAA (TC) L-810	5.5
RTO-CR08-004	Single Retro-fit Light Red / Infrared (IR)	12-48V DC	FAA (TC) L-810	5.0
RTO-1R07-001-EU	Single Light	120-240V AC	ICAO only, 32cd	6.5
RTO-1R07-002-EU	Dual Light	120-240V AC	ICAO only, 32cd	6.5
RTO-1R07-004-EU	Single Retro-fit Light	120-240V AC	ICAO only, 32cd	6.5
RTO-6CR7-001	Single Light Red / Infrared (IR)	120-240V AC	TC only L-810	9.0
RTO-6CR7-002	Dual Light Red / Infrared (IR)	120-240V AC	TC only L-810	9.0
RTO-6CR7-004	Single Retro-fit Light Red / Infrared (IR)	120-240V AC	TC only L-810	9.0

Vigilant LED Based L-810

Low Intensity (Red) Light

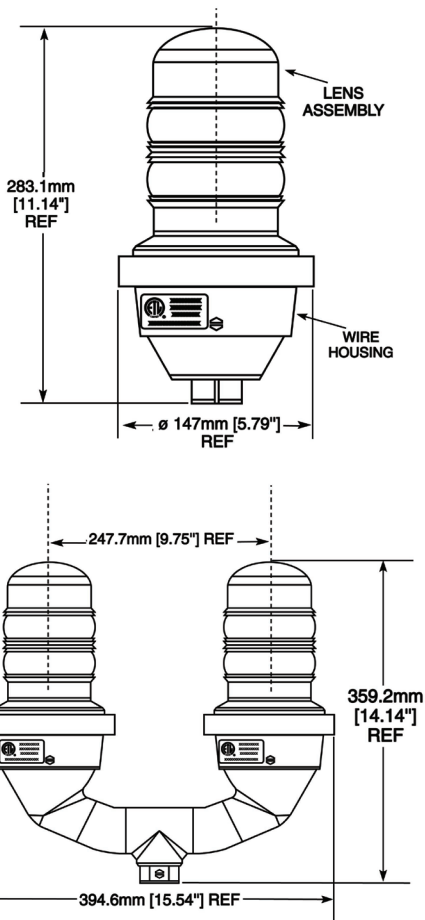

Dimensions in inches [mm]

Certifications & Compliance

- FAA AC 150 / 5345 - 43G
- FAA EB No. 67D
- IP66
- German Air Traffic Control Notices for Pilots Part I 6, January 2005
- Transport Canada CAR 621.19
- ICAO Annex 14
- DGAC Mexico
- CASA
- Nachrichten für Luftfahrer Teil I Langen, 6. Januar 2005

Features & Benefits

- ETL verified to FAA standards
- Superior surge and lightning protection
- Controllers available for all applications
- Ideal for towers, stacks, wind turbines, buildings, etc.
- 360 degree coverage for each flash head
- Shock and vibration resistant
- Lighting kits available for standard towers
- 6kV of surge protection

Mechanical Information:

Unit weight:	7.14 lbs (3.23 kg) (Single unit) 16.06 lbs (7.28 kg) (Dual unit)
Wattages:	15W / 120mA (120V AC) +/-10% 16W / 120mA (230V AC-60Hz) +/-15% 16W / (230V AC - 50 Hz) 24W / 2.0A (12V DC - Standard) 20W / 920mA (24V DC) 13W / 275mA (48V DC)
Voltage amp:	44 VA (120V AC) +/-10% 67 VA (230V AC) +/-15%
Operating temperature:	-67°F to +131°F (-55°F to +55°F)

All values typical unless otherwise stated (tolerance +/- 10%)

US Patent #6,425,678 (other patents pending)

Vigilant LED Based L-810

Low Intensity (Red) Light Ordering Information



Part Number	Description	Voltage	Certification / Compliance
860-1R01-001	Single Light	120V AC	FAA (TC) L-810
860-1R02-001	Single Light	230V AC	FAA (TC) L-810
860-1R03-001	Single Light	12V DC	FAA (TC) L-810
860-1R04-001	Single Light	48V DC	FAA (TC) L-810
860-1R05-001	Single Light	24V DC	FAA (TC) L-810
860-1R01-002	Dual Light	120V AC	FAA (TC) L-810
860-1R02-002	Dual Light	230V AC	FAA (TC) L-810
860-1R03-002	Dual Light	12V DC	FAA (TC) L-810
860-1R04-002	Dual Light	48V DC	FAA (TC) L-810
860-1R05-002	Dual Light	24V DC	FAA (TC) L-810
860-5R02-001	Single Light	230V AC	ICAO only, 10cd
860-5R02-002	Dual Light	230V AC	ICAO only, 10cd
860-4R02-001-EU	Single Light	230V AC	ICAO only, 50cd
860-4R02-002-EU	Dual Light	230V AC	ICAO only, 50cd
860-1R02-001-EU	Single Light	230V AC	ICAO only, 32cd
860-1R02-002-EU	Dual Light	230V AC	ICAO only, 32cd
860-6R01-001	Single Light	120V AC	TC only L-810
860-6R01-002	Dual Light	120V AC	TC only L-810
860-7R02-002	Dual Light	230V AC	CASA only, 100cd

¹All candela's are minimums. See www.dialight.com for more information

Dialight also offers these LED Obstruction lights for use in Hazardous Locations (Class I, Div 2)



SafeSite L-810 Red LED Side Light



SafeSite L-810 LED Steady Burn Visual Signals



SafeSite FLS Flashing Visual Signals

