

DEUTSCH

Engineered Connecting Devices

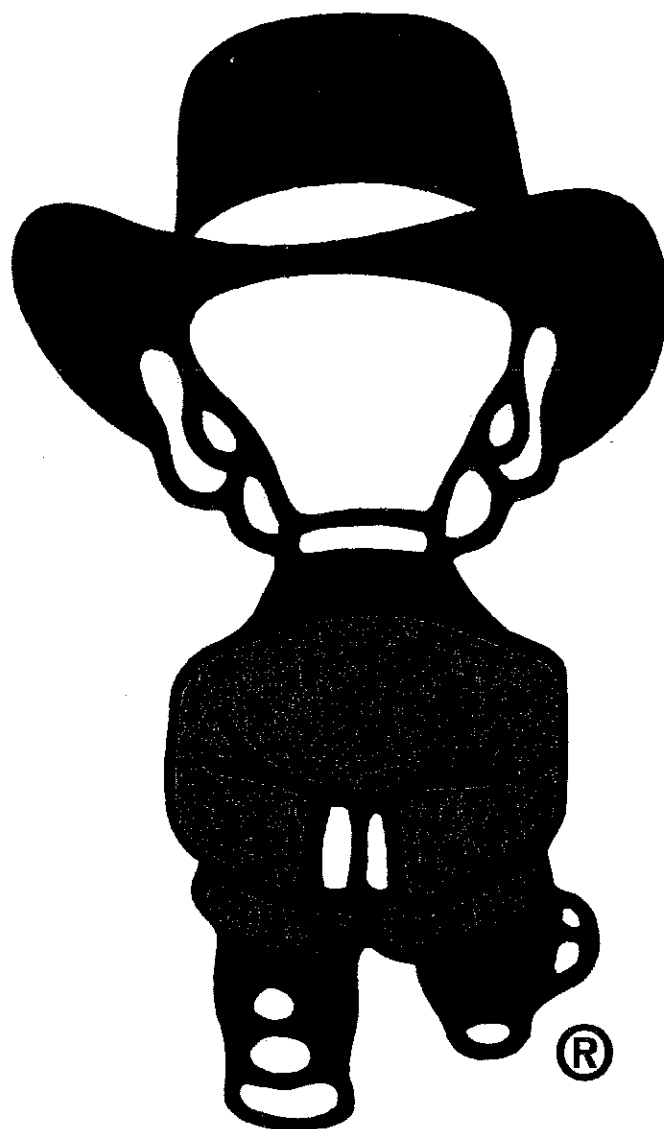

Table of Contents

SECTION I: MIL-SPEC CONNECTORS & ACCESSORIES

MIL-C-38999 Series I	Page 5
MIL-C-38999 Series III	Page 11
MIL-C-38999 Series III Composite	Page 15
MIL-C-38999 Series III Protective Covers	Page 20
MIL-C-38999 Series III Lightweight Strain Relief	Page 21
MIL-C-38999 Series IV	Page 23
MIL-C-26482 Series 2	Page 31
MIL-C-26482/AFD Protective Covers	Page 35
MIL-C-83723 Series 1 & 3	Page 37
MIL-T-81714 Series II	Page 49
AFLC 8810310	Page 65
MIL-C-81511	Page 69
MIL-C-29600 Series A	Page 73
MIL-C-29600 Series B	Page 77

SECTION II: COMMERCIAL CONNECTORS

BVD	Page 83
CPP	Page 91
MMP	Page 97
ABC Inline	Page 101
Special Series	Page 105

SECTION III: OTHER DEUTSCH PRODUCT LINES

Other product lines	Page 109
-------------------------------	----------

SECTION IV: ASSEMBLY INSTRUCTIONS

Contact Insertion	Page 117
Contact Crimping	Page 118
Contact Removal/ Sealing Plugs	Page 119

SECTION V: CONTACT CROSS REFERENCE

Contact cross reference	Page 122
-----------------------------------	----------

SECTION VI: TOOL & CONTACT CHART

Tool and contact selection guide	Page 126
--	----------

Deutsch ECD Defense / Aerospace Operations

Tel: (909) 765-2200 • Fax: (909) 922-1544

E-mail: customerservice@deutschconnectors.net

Section I

Mil-Spec Connectors & Accessories

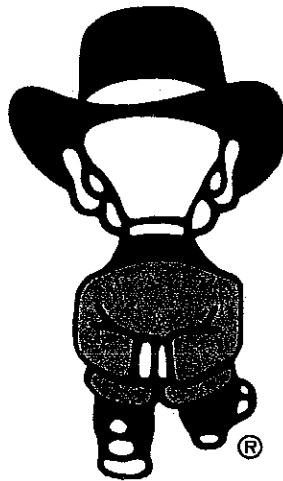

DEUTSCH ECD

Defense / Aerospace Operations . . .

is the world's premier manufacturer of electrical interconnection devices for use in defense, aerospace, and commercial applications. Whether you need an interconnection device for a commercial or military aircraft, missile, tank, truck transmission or a host of other applications, Deutsch has the solution you're looking for.

MIL-C-38999 Series I

Cylindrical, High Density Bayonet Coupling Connector Qualified to MIL-C-38999 Series I

The Deutsch Series I version is a long shell, scoop-proof, bayonet coupling connector available in both environment resisting resilient and hermetic types. These Series I connectors are intermateable and interchangeable with all other MIL-C-38999 Series I connectors.

Dielectric withstanding voltage:

(Meets MIL-C-38999, paragraph 3.14)
At sea level: 1800 volts AC (RMS)
At 100,000 ft.: 200 volts AC (RMS)

Insulation resistance:

(Meets MIL-C-38999, paragraph 3.13)
5000 megohms min. at 25°

Thermal shock:

(Meets MIL-C-38999, paragraph 3.8)
After cycling the connector between -65° C and +175° C, it will meet all applicable electrical and mechanical requirements.

Current rating:

(Meets MIL-C-39029, paragraph 1.3.1)

Contact Size	Max. Amps
22D	5
20	7.5
16	13
12	23

Temperature:

(Meets MIL-C-38999, paragraph 3.11)
Operative at temperatures from -65° C to +175° C.

Durability:

(Meets MIL-C-38999, paragraph 3.11)
No electrical or mechanical defects after 500 cycles of engagement and disengagement.

Physical shock:

(Meets MIL-C-38999, paragraph 3.27)
No loosening of parts, cracking or other deleterious results hindering further part operation after 300 G's in each of 3 mutually perpendicular planes.

Contact millivolt drop:

22D — 73 millivolts at 5.0 amps
20 — 55 millivolts at 7.5 amps
16 — 49 millivolts at 135.0 amps
12 — 42 millivolts at 23.0 amps

Corrosion:

(Meets MIL-C-38999, paragraph 3.16)
Meets appropriate electrical and mechanical requirements and shows no exposure of base metal after 500 hours of salt spray.

Vibration:

(Meets MIL-C-38999, paragraph 3.26)

Contact resistance at 25° C:

(Meets MIL-C-39029, paragraph 3.5.4)

Contact & Wire Size	Test Current (Amps)	Millivolt Drop (*)
22D	5	73
20	7.5	55
16	13	49
12	23	42

Usable wire size:

(Meets MIL-C-39029, paragraph 3.4.3.1)

Contact Size	Accepts (AWG)
22D	22-28
20	20-24
16	16-20
12	12&14

Materials:

Shell — aluminum alloy.
Pin contacts — copper alloy.
Inserts — plastic; silicone.

Finish:

Shell — O.D. cad over nickel.
Contacts — gold over nickel.

Grommet sealing range:

(Meets MIL-C-39029, paragraph 3.4.3.1)

Contact Size	Max. Wire O.D.	Min. Wire O.D.
22D	.054	.030
20	.083	.040
16	.109	.065
12	.142	.097

Fluid compatibility:

(Meets MIL-C-38999, paragraph 3.33)
Designed to function in all fluids encountered in any modern military or aerospace environment.

EMI shielding:

(Meets MIL-C-38999, paragraph 3.31)
Effective over a range of 100 MHz to 10 GHz with a minimum 50 dB effectiveness at 10 GHz.

Frequency MHz	Leakage attenuation minimum (dB)
100	90
200	88
300	87
400	85
800	85
1,000	85
1,500	69
2,000	65
3,000	61
4,000	58
6,000	55
10,000	50

Fluid immersion:

Fluid resistant to many fuels, coolants and solvents per MIL-C-38999.



MIL-C-38999 Series I

SHELL SIZE	H DIA. REF.
09	.568
11	.696
13	.846
15	.971
17	1.096
19	1.203
21	1.328
23	1.453
25	1.578

SHELL SIZE	KEY POSITION α				
	N	A	B	C	D
09	95°	77°	---	---	113°
11	95°	81°	67°	123°	109°
13	95°	75°	63°	127°	115°
15	95°	74°	61°	129°	116°
17	95°	77°	65°	125°	113°
19	95°	77°	65°	125°	113°
21	95°	77°	65°	125°	113°
23	95°	80°	69°	121°	110°
25	95°	80°	69°	121°	110°

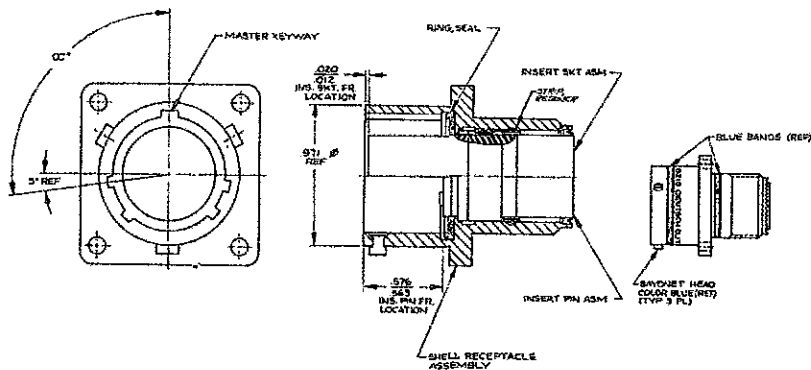
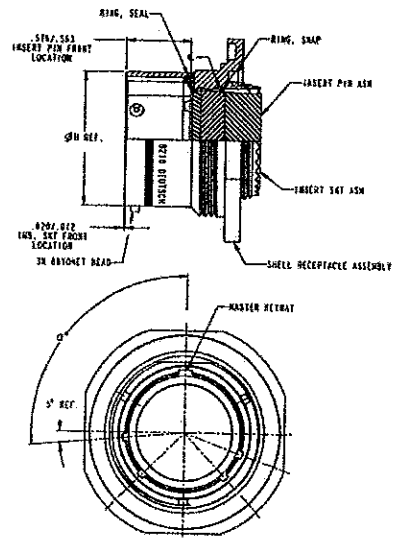

- DJT 1 E MM - MM P M - XXXX
- MODIFICATIONS
 - KEYING POSITIONS
N, A, B, C, D (POSITION N = NORMAL)
 - CONTACT
P = PIN
S = SOCKET
 - CONTACT ARRANGEMENT
 - SHELL SIZE
9, 11, 13, 15, 17, 19, 21, 23 AND 25
 - FINISH
E = OLIVE DRAB CADMIUM (STANDARD)
F = NICKEL (RESERVED)
 - SHELL STYLE
0 = RECEPTACLE SQUARE FLANGE
4 = RECEPTACLE JAM NUT
5 = PLUG STRAIGHT (REVERSE CAVITY IDENTIFICATION)
6 = PLUG STRAIGHT
 - COUPLING SYSTEM
BAYONET
 - BASIC IDENTIFIER
DEUTSCH MIL-C-38999 SERIES I (SCOOP PROOF)



MIL-C-38999 Series I

Receptacle Outline Dimensions

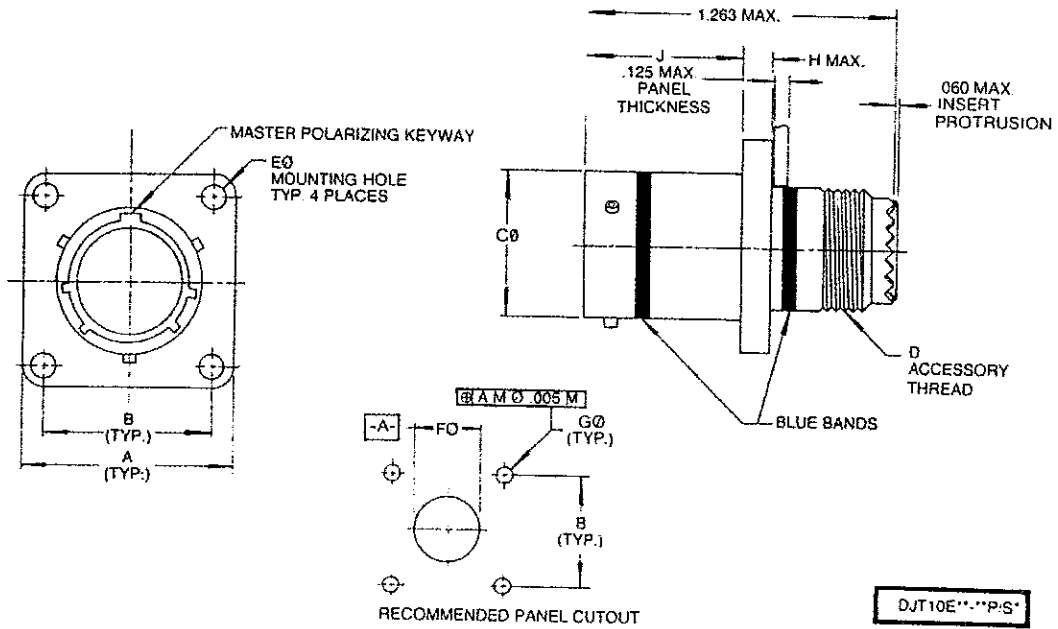

Plug Outline Dimensions

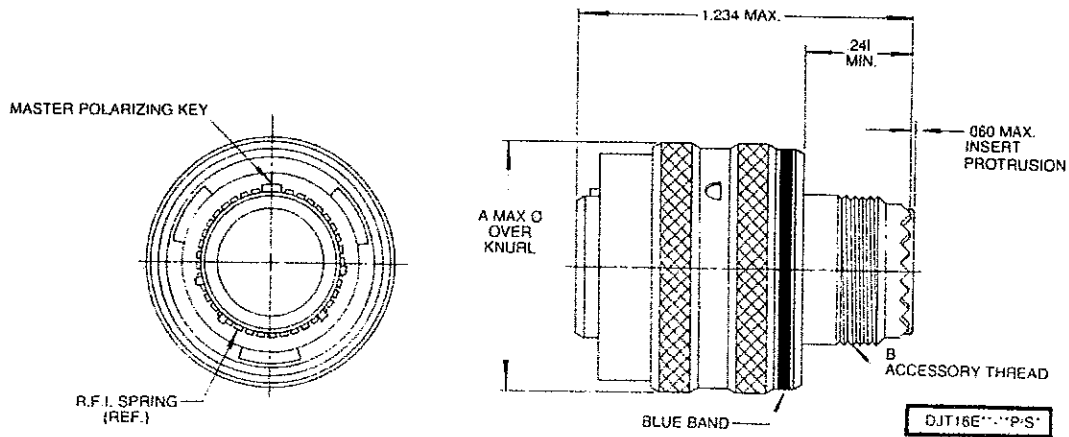

SHELL SIZE	A ±.020	B ±.005	C0 ±.003	D THREAD UNEF-2A	E0 +.010 - .005	F0 MIN.	G0 ±.005	H MAX.	J ±.000 - .005	A0 MAX	B THREAD UNEF-2A
9	.938	.719	.570	.4375-28	.128	.516	.128	.100	.632	.859	.4375-28
11	1.031	.812	.698	.5625-24	.128	.664	.128	.100	.632	.984	.5625-24
13	1.125	.906	.848	.6875-24	.128	.750	.128	.100	.632	1.156	.6875-24
15	1.219	.969	.973	.8125-20	.128	.906	.128	.100	.632	1.281	.8125-20
17	1.312	1.062	1.098	.9375-20	.128	1.016	.128	.100	.632	1.406	.9375-20
19	1.438	1.156	1.205	1.0625-18	.128	1.141	.128	.100	.632	1.516	1.0625-18
21	1.562	1.250	1.330	1.1875-18	.128	1.266	.128	.130	.602	1.641	1.1875-18
23	1.688	1.375	1.455	1.3125-18	.147	1.377	.154	.130	.602	1.766	1.3125-18
25	1.812	1.500	1.580	1.4375-18	.147	1.484	.154	.130	.602	1.891	1.4375-18



DJT Series Insert Arrangements

Contact Arrangements

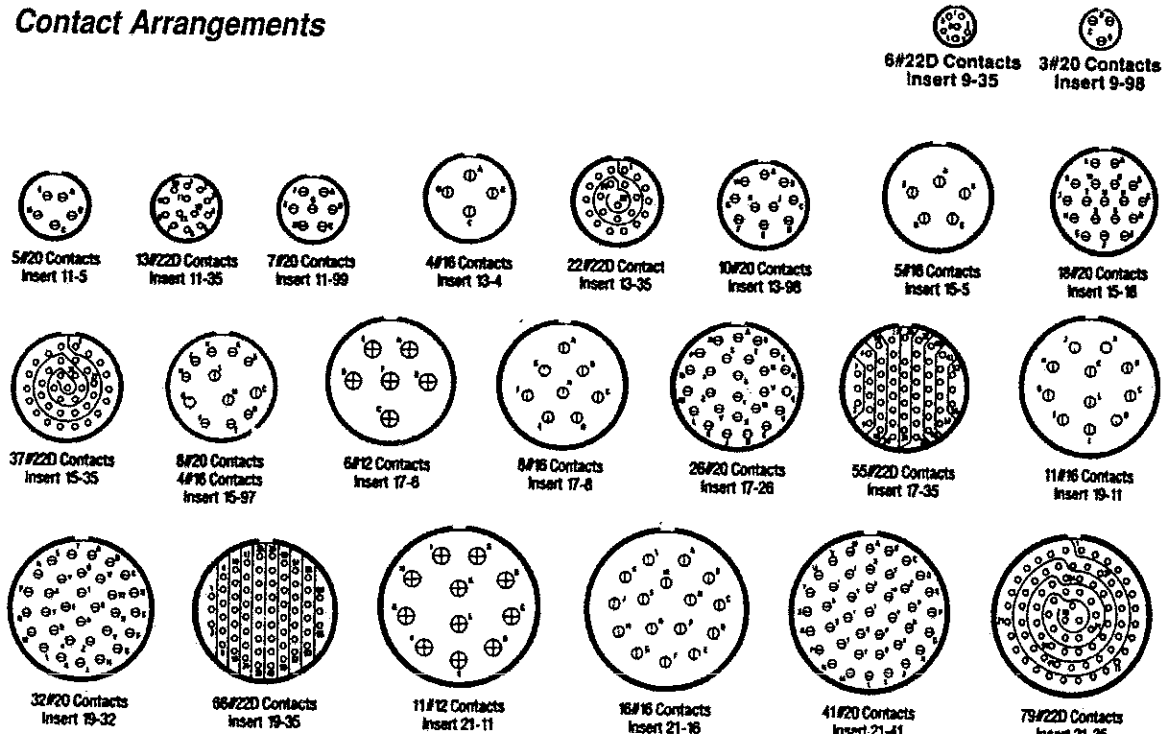

Deutsch Shell Sizes

DJT	Service Rating	Total Contacts	Contact Size			
			22D	20	16	12
9-35	M	6	6			
9-98	I	3		3		
11-5	I	5		5		
11-35	M	13	13			
11-99	I	7		7		
13-4	I	4			4	
13-35	M	22	22			
13-98	I	10		10		
15-5	II	5			5	
15-18	I	18		18		
15-35	M	37	37			
15-97	I	12		8	4	
17-6	I	6				6
17-8	II	8			8	
17-26	I	26		26		
17-35	M	55	55			
19-11	II	11			11	
19-32	I	32		32		
19-35	M	66	66			
21-11	I	11				11
21-16	II	16			16	
21-41	I	41		41		
21-35	M	79	79			
23-21	II	21			21	
23-53	I	53		53		
23-55	I	55		55		
25-4	I	56		46	8	
25-19	I	19				19
25-24	I	24			12	12
25-29	I	29			29	
25-30	M	128	128			
25-61	I	61		61		

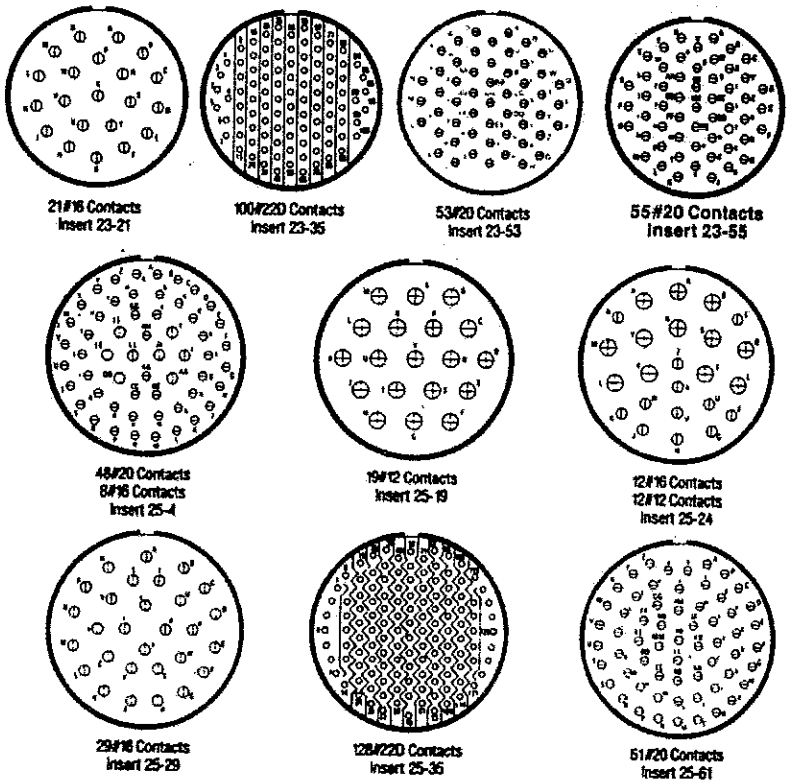



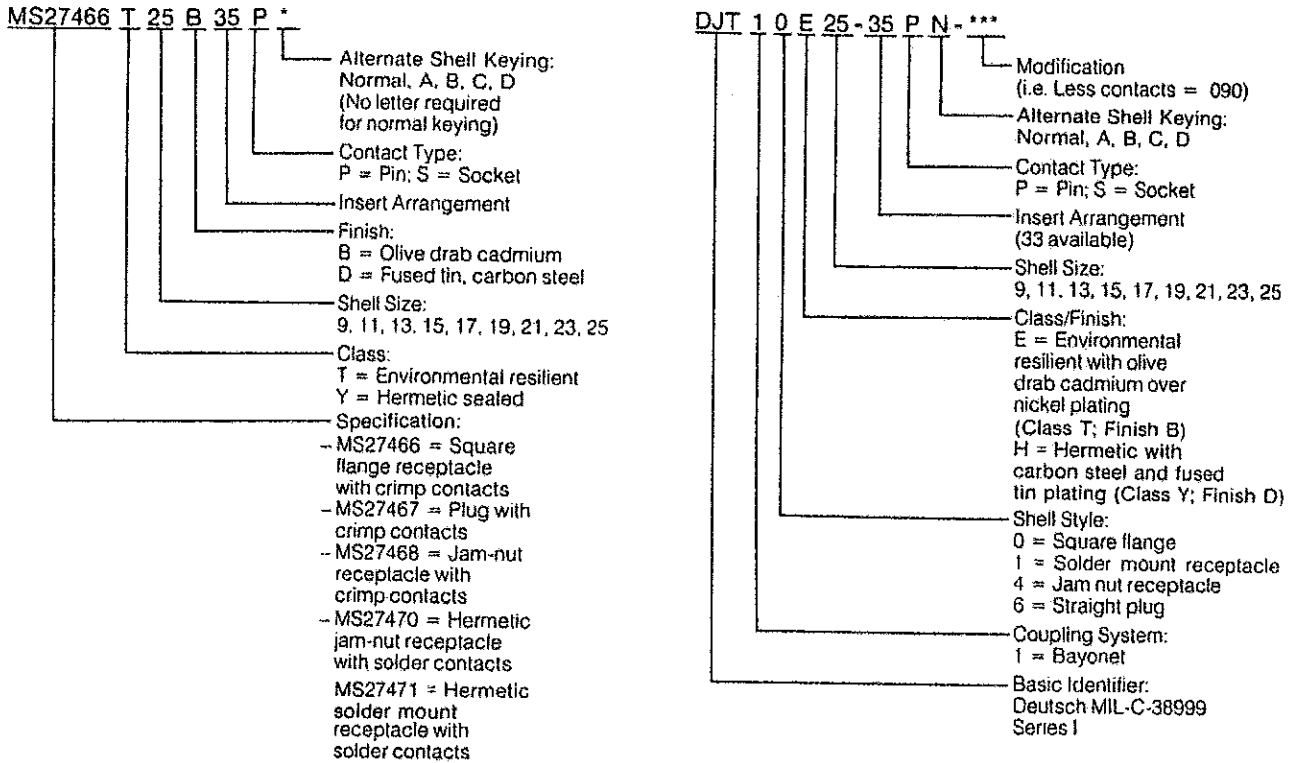

Part Number Cross Reference



Assembly Tools

Wire/contact assembly tools are standard military type insertion/removal tools found in most assembly areas.

- Yellow  Size 22D
- Red  Size 20
- Blue  Size 16
- Yellow  Size 12



Contact Size	Insertion/removal tool	Crimp tool	Crimp tool positioner	Sealing plug (Military P/N)
22D	M81969 14-01 MS3160-23	M22520/7-01	M22520/7-07 M22520-7/05	MS27488-22
20	M81969 14-02	M22520/1-01	M22520/1-04	MS27488-20
16	M81969 14-03	M22520/1-01	M22520/1-04	MS27488-15
12	M81969 14-04	M22520/1-01	M22520/1-04	MS27488-12



MIL-C-38999 Series III

Deutsch's MIL-C-38999 Series III qualified with triple start, self locking, threaded coupling and crimp-type terminations.

The Deutsch DTS Series is qualified to MIL-C-38999 Series III. This rugged design offers the maximum in vibration, shock and EMI resistance. A general duty threaded connector, the DTS Series, offers thicker wall sections and greater coupling surface with 100% metal to metal bottoming, a superior anti-coupling system, and Deutsch's proven dielectric contact retention. The positive metal to metal coupling design, superior interfacial seals, and cadmium over nickel

plating provide excellent EMI, moisture and corrosion resistance. In a 360° turn of the coupling nut, the DTS quickly mates and self locks. Blunting of the thread on both the coupling nut and receptacle makes cross threading virtually impossible. Elongated mounting holes permit the DTS Connector to intermount with existing standard MS/38999 box or wall mount receptacles, giving it a design replacement advantage.

SPECIFICATIONS:

Vibration: (Class W)

Sine — Up to 60 G's for 36 hours duration per MIL-C-38999.

Random — Up to 41.7 G's rms for 16 hours duration at 175°C; Up to 50 G's rms for 16 hours duration at ambient temperature.

Temperature: (Class W)

-65°C to +175°C (-85°F to +347°)

Shock:

High impact per MIL-S-901.

Thermal Shock:

Meets requirements of MIL-C-38999.

EMI Shielding: (Class W)

Effective over a range of 100 MHz to 10GHz with a minimum 50 dB effectiveness at 10 GHz.

Insulation resistance:

5000 megaohms min. at +25°C (+77°F).

Corrosion: (Class W)

500 hours salt spray per MIL-C-38999.

Contact rating: (Crimp Contacts)

22D — 5.0 amps.

20 — 7.5 amps.

16 — 13.0 amps.

12 — 23.0 amps.

Dielectric withstanding voltage:

Test voltage at sea level — 1300 VAC (rms).

Wired, assembled, unmated connectors withstand:

550 VAC (rms) at 50,000 ft.

350 VAC (rms) at 70,000 ft.

200 VAC (rms) at 100,000 ft.

Contact Millivolt drop:

22D — 73 millivolts at 5.0 amps.

20 — 55 millivolts at 7.5 amps.

16 — 49 millivolts at 13.0 amps.

12 — 42 millivolts at 23.0 amps.

Usable wire size:

22D accepts 22 thru 28 AWG.

20 accepts 20 thru 24 AWG.

16 accepts 16 thru 20 AWG.

12 accepts 12 thru 14 AWG.

Materials:

Shell — aluminum alloy.

Pin Contacts — copper alloy.

Inserts — plastic; silicone.

Finish:

Shell — O.D. cad over nickel (class W).

— nickel plated (class F).

Contacts — gold over nickel.

Fluid Immersion:

Fluid resistant to many fuels, coolants and solvents per MIL-C-38999.



MIL-C-38999 Series III

Deutsch's MIL-C-38999 Series III qualified with triple start, self locking, threaded coupling and crimp-type terminations.

SQUARE FLANGE RECEPTACLE

DTS20WXX-XXXX-XXXX
D38999/20WXXXXX

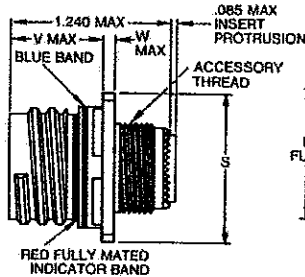

JAM NUT RECEPTACLE

DTS24WXX-XXXX-XXXX
D38999/24WXXXXX

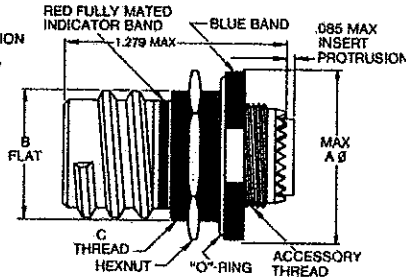

RFI PLUG

DTS26WXX-XXXX-XXXX
D38999/26WXXXXX

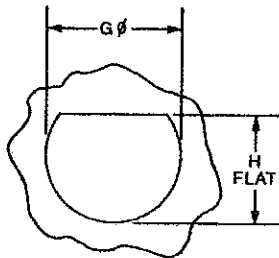
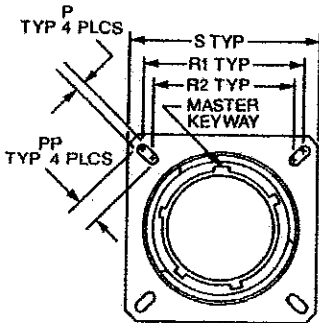
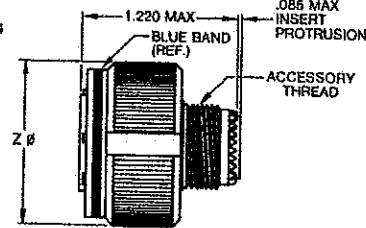

SHELL SIZE	A Ø MAX	+0.004 -0.006 B FLAT	C THREAD	H FLAT +0.000 -0.010	G Ø +0.010 -0.000	S ±0.001	V MAX	W MAX	R1 TYP	R2 TYP	P +0.004 -0.002	PP +0.004 -0.002	2 Ø MAX	ACCESSORY THREAD
9	1.200	.651	M17X1-6g 0.100R	.669	.697	.837	.822	.098	.719	.594	.128	.216	.658	M12X1/0-6g 0.100R
11	1.385	.751	M20X1-6g 0.100R	.769	.822	1.031	.822	.098	.812	.719	.128	.194	.654	M15X1/0-6g 0.100R
13	1.511	.938	M25X1-6g 0.100R	.955	1.007	1.126	.822	.098	.906	.812	.128	.194	1.157	M18X1/0-6g 0.100R
15	1.637	1.082	M28X1-6g 0.100R	1.084	1.134	1.220	.822	.098	.969	.906	.128	.173	1.279	M22X1/0-6g 0.100R
17	1.763	1.187	M32X1-6g 0.100R	1.208	1.259	1.311	.822	.098	1.082	.969	.128	.194	1.405	M25X1/0-6g 0.100R
19	1.948	1.312	M35X1-6g 0.100R	1.333	1.384	1.437	.822	.098	1.158	1.062	.128	.194	1.515	M28X1/0-6g 0.100R
21	2.074	1.437	M38X1-6g 0.100R	1.459	1.507	1.563	.791	.126	1.250	1.156	.128	.194	1.841	M31X1/0-6g 0.100R
23	2.200	1.582	M41X1-6g 0.100R	1.584	1.634	1.689	.791	.126	1.375	1.250	.154	.242	1.768	M34X1/0-6g 0.100R
25	2.322	1.687	M44X1-6g 0.100R	1.709	1.759	1.811	.791	.126	1.500	1.375	.154	.242	1.869	M37X1/0-6g 0.100R

Contact size	Insertion/removal tool	Crimp tool	Crimp tool positioner	Sealing plug (Military P/N)
22	M81969/14-01 MS3160-23	M22520/7-01	M22520/7-07 M22520/7-05	MS27488-22
20	M81969/14-10	M22520/1-01	M22520/1-04	MS27488-20
16	M81969/14-03	M22520/1-01	M22520/1-04	MS27488-16
12	M81969/14-04	M22520/1-01	M22520/1-04	MS27488-12

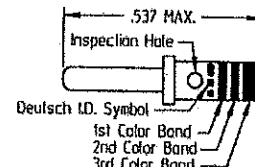
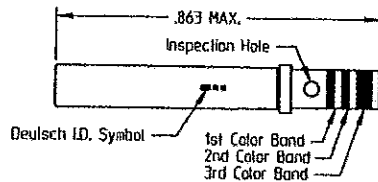

Sockets, Gold Finish

Deutsch Part No.	MIL-C-39029 Equivalent No.	Size	Color Band 1st	Color Band 2nd	Color Band 3rd
38943-22	MIL-C-39029/58-348	22D	ORANGE	YELLOW	GRAY
38943-20	MIL-C-39029/58-351	20	ORANGE	GREEN	BROWN
38943-16	MIL-C-39029/58-352	16	ORANGE	GREEN	RED
38943-12	MIL-C-39029/58-353	12	ORANGE	GREEN	ORANGE

Sockets, Deutsch Extended Life Finish

Deutsch Part No.	Military Part No.	Size	Color Band 1st	Color Band 2nd	Color Band 3rd
12333-22	MIL-C-39029/106-614	22D	BLUE	BROWN	YELLOW
12333-20	MIL-C-39029/106-615	20	BLUE	BROWN	GREEN
12333-16	MIL-C-39029/106-616	16	BLUE	BROWN	BLUE
12333-12	MIL-C-39029/106-617	12	BLUE	BROWN	VIOLET

Pins, Gold Finish

Deutsch Part No.	MIL-C-39029 Equivalent No.	Size	Color Band 1st	Color Band 2nd	Color Band 3rd
38941-22	MIL-C-39029/58-360	22D	ORANGE	BLUE	BLACK
38941-20	MIL-C-39029/58-363	20	ORANGE	BLUE	ORANGE
38941-16	MIL-C-39029/58-364	16	ORANGE	BLUE	YELLOW
38941-12	MIL-C-39029/58-365	12	ORANGE	BLUE	GREEN

Pins, Deutsch Extended Life Finish

Deutsch Part No.	Military Part No.	Size	Color Band 1st	Color Band 2nd	Color Band 3rd
12331-22	MIL-C-39029/107-620	22D	BLUE	RED	BLACK
12331-20	MIL-C-39029/107-621	20	BLUE	RED	BROWN
12331-16	MIL-C-39029/107-622	16	BLUE	RED	RED
12331-12	MIL-C-39029/107-623	12	BLUE	RED	ORANGE



Insert Arrangements

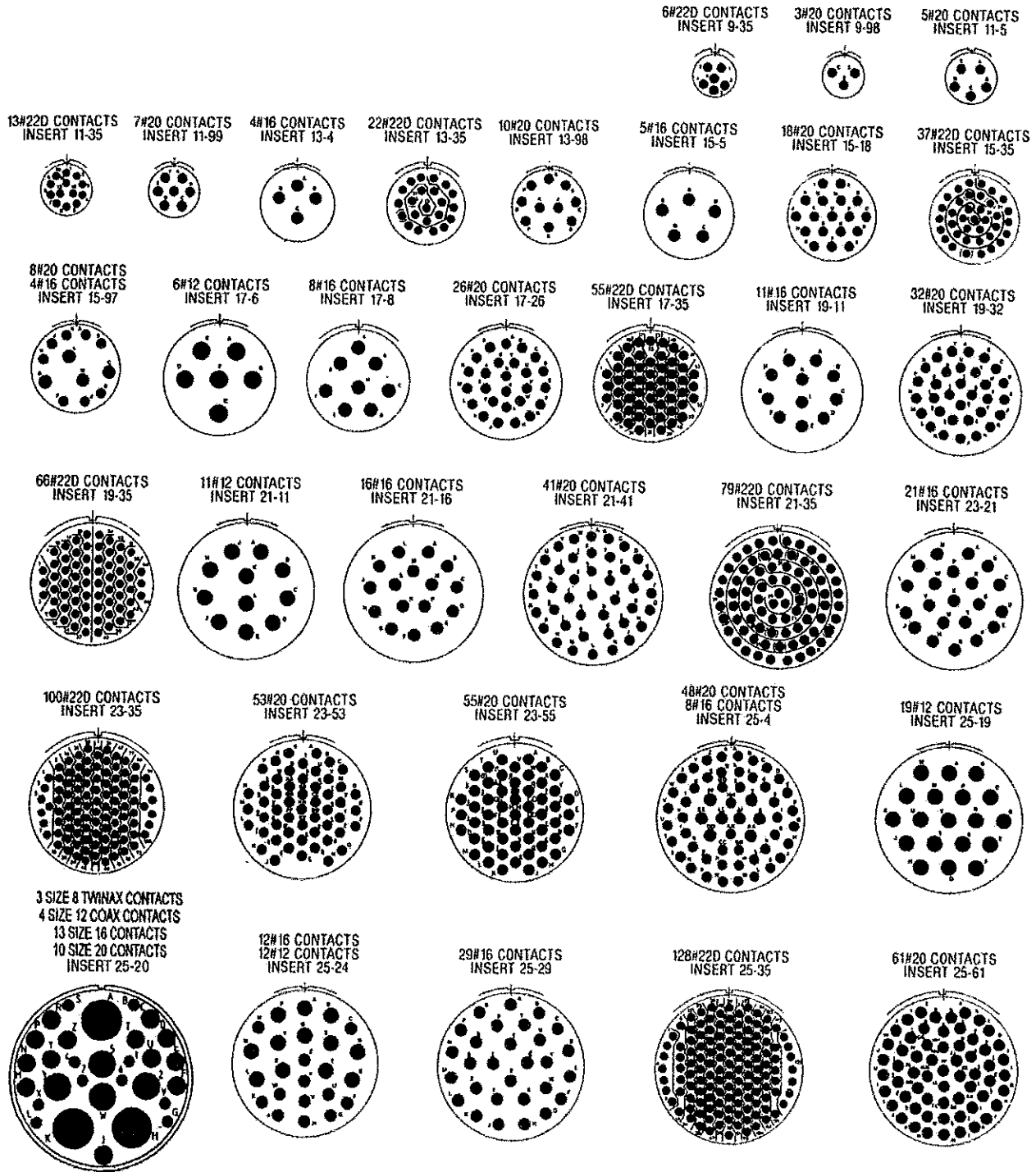

Note: For additional insert arrangements consult factory.



Ordering Information

Basic Deutsch Number

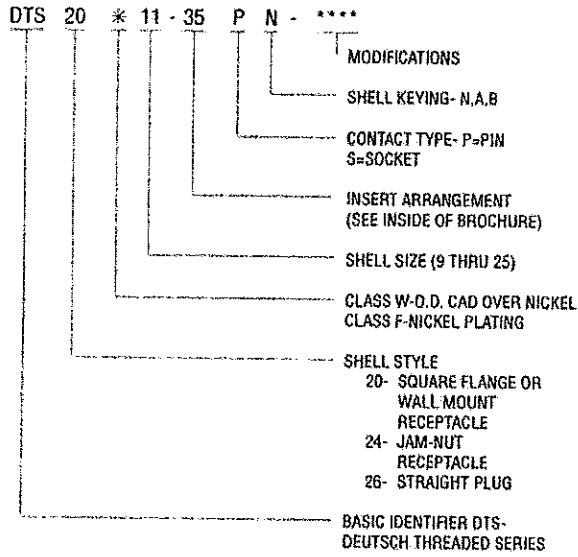

Basic Military Number

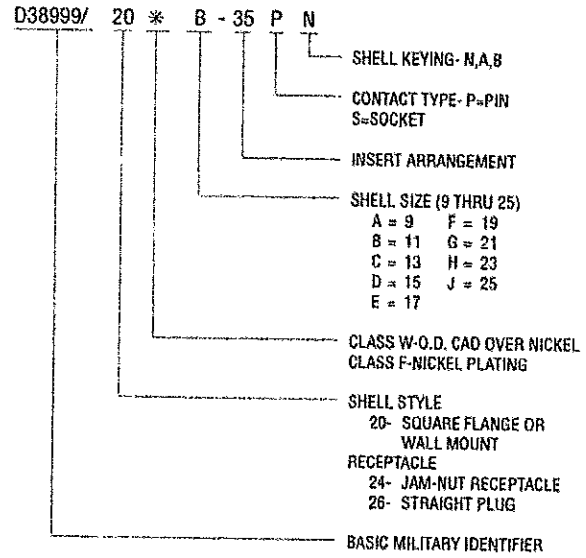

- * Refer to page 15 for Class M & J.
- * Consult factory for alternate keyings.
- * Refer to page 20 for Protective Covers.
- * Refer to page 21 for Lightweight Tie Type Strain Relief.



MIL-C-38999 Series III (Composite)

ACT Highlights

The Deutsch ACT is a high performance composite connector qualified to MIL-C-38999. What Deutsch Defense/Aerospace does better than anyone else is make wire termination devices for demanding applications. Deutsch utilized its unprecedented achievements in the area of defense/aerospace composite technology, enabling us to design and produce the latest version of MIL-C-38999 connectors.

The superior design of the ACT deliberately took into consideration the connector, its contacts, and the respective strain reliefs to favorably influence intra-system life-cycle performance and costs.

Performance

The total performance of the ACT connector is matched by individual components within the system. For example, the use of composite materials has increased the durability of the connector housing and coupling mechanism to 1500 cycles. Deutsch developed an extended life MIL-C-39029 contact to meet the increased performance requirements of today's systems.

Superior corrosion resistance

The ACT eliminates the largest contributing factor in advanced systems malfunction... corrosion, which is the main cause of mechanical, electrical, and electromagnetic connector degradation. Electromotive force differentials between many dissimilar metals found in connectors and accessories produce galvanic action. The ACT eliminates these dissimilar metals, resulting in an interconnection system that withstands over 2000 hours of salt spray.

EMI shielding effectiveness

Meets and exceeds the requirements of MIL-C-38999, paragraph 3.3.1.

Fluid immersion

Meets all the requirements of MIL-C-38999, paragraph 3.33.

Temperature

The metal surface will not delaminate from the composite material even after extreme temperature excursions. The ACT meets all requirements of MIL-C-38999, paragraph 3.8.

Magnetic permeability

The magnetic permeability of the fully assembled ACT connector is less than 2.0μ , meeting all the requirements of MIL-C-38999, paragraph 3.3.4.

Materials

All the materials used in the shell and inserts in the ACT are in accordance with MIL-C-38999, paragraph 3.3. The contacts are in accordance with MIL-C-39029, paragraph 3.3.

Finish

Meets all the requirements of MIL-C-38999, paragraph 3.4.8.

Insulation resistance

Meets all the requirements of MIL-C-38999, paragraph 3.13.

Dielectric withstanding voltage

Meets all the requirements of MIL-C-38999, paragraph 3.14.



The Best of MIL-C-38999

Square flange receptacle*

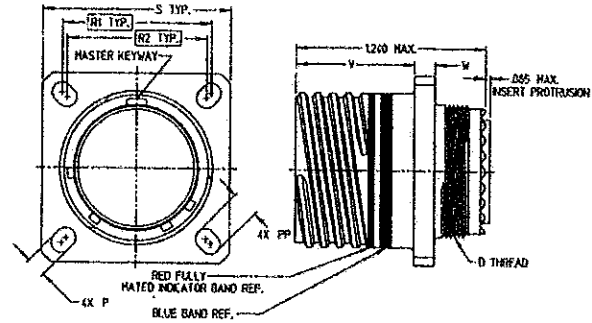

MILITARY PART NUMBERS	DEUTSCH PART NO.	SHELL SIZE	D THREAD	P+.004 -.002	PP+.004 -.002	R1	R2	S.010	Y MIN	W MAX.
D38999/20•A****	ACT 90•A****	A (9)	M12X1.0-8g 0.100R	.128	.218	.719	.594	.937	.768	.144
D38999/20•B****	ACT 90•B****	B (11)	M15X1.0-8g 0.100R	.128	.194	.812	.719	1.031	.768	.144
D38999/20•C****	ACT 90•C****	C (13)	M18X1.0-8g 0.100R	.128	.194	.908	.812	1.126	.768	.144
D38999/20•D****	ACT 90•D****	D (15)	M22X1.0-8g 0.100R	.128	.173	.989	.908	1.220	.768	.144
D38999/20•E****	ACT 90•E****	E (17)	M25X1.0-8g 0.100R	.128	.194	1.082	.869	1.311	.768	.144
D38999/20•F****	ACT 90•F****	F (19)	M28X1.0-8g 0.100R	.128	.194	1.158	1.082	1.437	.768	.144
D38999/20•G****	ACT 90•G****	G (21)	M31X1.0-8g 0.100R	.128	.194	1.250	1.158	1.563	.738	.171
D38999/20•H****	ACT 90•H****	H (23)	M34X1.0-8g 0.100R	.154	.242	1.375	1.250	1.889	.738	.171
D38999/20•J****	ACT 90•J****	J (25)	M37X1.0-8g 0.100R	.154	.242	1.500	1.375	1.811	.738	.171

Mounting cutouts

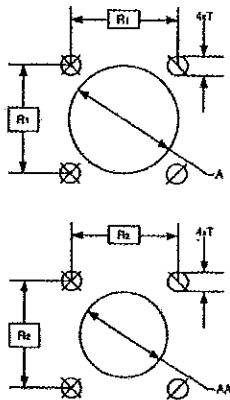

Back Panel Mounting

Max (R1) distance between mounting screws

Front Paneling Mounting

Max (R2) distance between mounting screws

SHELL SIZE	A DIS. MIN.	AA DIS. MIN.	R1	R2	T DIA. ±.13
A (9)	18.88 (.750)	13.11 (.518)	18.26 (.719)	15.09 (.594)	3.25 (.128)
B (11)	20.22 (.795)	15.88 (.625)	20.62 (.812)	18.28 (.719)	3.25 (.128)
C (13)	23.42 (.922)	19.05 (.750)	23.01 (.908)	20.62 (.812)	3.25 (.128)
D (15)	26.59 (1.047)	23.01 (.908)	24.81 (.989)	23.01 (.908)	3.25 (.128)
E (17)	30.98 (1.219)	25.81 (1.018)	28.97 (1.092)	24.61 (.969)	3.25 (.128)
F (19)	32.94 (1.297)	28.95 (1.141)	29.38 (1.158)	28.97 (1.092)	3.25 (.128)
G (21)	38.12 (1.442)	32.18 (1.268)	31.75 (1.250)	29.38 (1.158)	3.25 (.128)
H (23)	39.29 (1.547)	34.93 (1.375)	34.93 (1.375)	31.75 (1.250)	3.91 (.154)
J (25)	42.47 (1.672)	37.89 (1.488)	38.10 (1.500)	34.93 (1.375)	3.91 (.154)

Notes:

- Dimensions are in millimeters. Inch equivalents are in parentheses (given for general information only).
- R2 dimension may be substituted for mounting screw locations (R1) or front mount cutouts.
- * QPL listing will be provided on request.



MIL-C-38999 Series III (Composite)

A-35
6 SIZE 22D CONTACTS



A-98
3 SIZE 20 CONTACTS



B-05
5 SIZE 20 CONTACTS



B-35
13 SIZE 22D CONTACTS



B-98
6 SIZE 20 CONTACTS



B-99
7 SIZE 20 CONTACTS



C-04
4 SIZE 16 CONTACTS



C-08
8 SIZE 20 CONTACTS



C-35
22 SIZE 22D CONTACTS



C-98
10 SIZE 20 CONTACTS



D-05
5 SIZE 16 CONTACTS

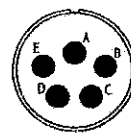

D-18
18 SIZE 20 CONTACTS

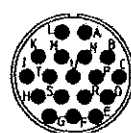

D-19
19 SIZE 20 CONTACTS

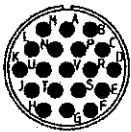

D-23
3 SIZE 16 CONTACTS
2 SIZE 20 CONTACTS
18 SIZE 22 CONTACTS

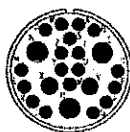

D-35
37 SIZE 22D CONTACTS

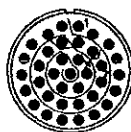

D-97
4 SIZE 16 CONTACTS
8 SIZE 20 CONTACTS



E-06
6 SIZE 12 CONTACTS

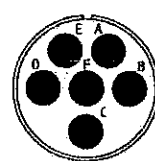

E-08
8 SIZE 16 CONTACTS

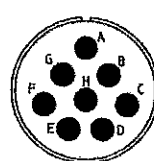

E-19
4 SIZE 16 CONTACTS
11 SIZE 20 CONTACTS
4 SIZE 22 CONTACTS

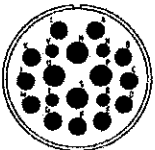

E-26
26 SIZE 20 CONTACTS

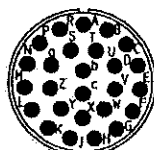

E-35
55 SIZE 22D CONTACTS

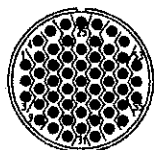

E-99
21 SIZE 20 CONTACTS
2 SIZE 16 CONTACTS

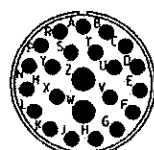

F-11
11 SIZE 16 CONTACTS

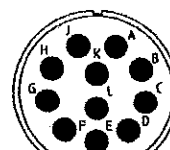

F-32
32 SIZE 20 CONTACTS

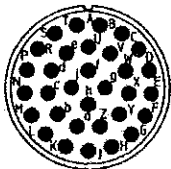

F-35
66 SIZE 22D CONTACTS

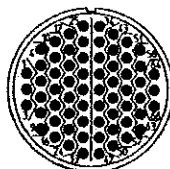

G-11
11 SIZE 12 CONTACTS

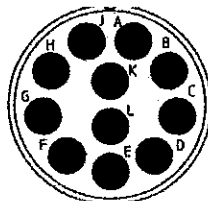

Please consult factory for additional insert arrangements.



MIL-C-38999 Series III (Composite)

G-16
16 SIZE 16 CONTACTS

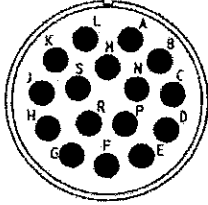

G-35
79 SIZE 22D CONTACTS

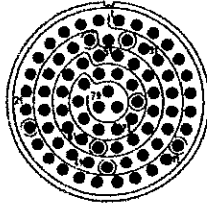

G-39
37 SIZE 20 CONTACTS
2 SIZE 16 CONTACTS

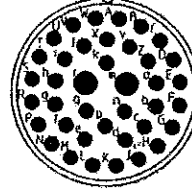

G-41
41 SIZE 20 CONTACTS

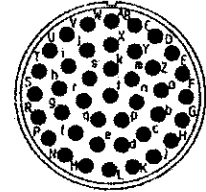

H-21
21 SIZE 16 CONTACTS

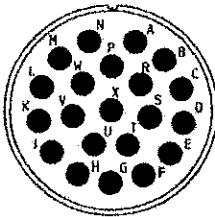

H-35
100 SIZE 22D CONTACTS

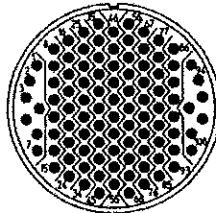

H-53
53 SIZE 20 CONTACTS

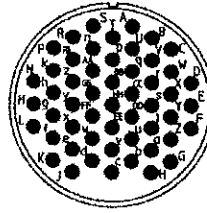

H-55
55 SIZE 20 CONTACTS

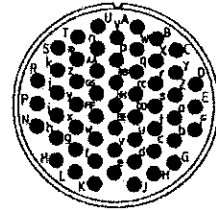

J-04
8 SIZE 16 CONTACTS
48 SIZE 20 CONTACTS

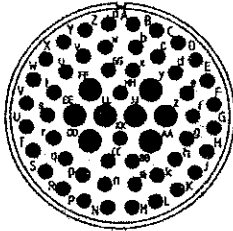

J-19
19 SIZE 12 CONTACTS

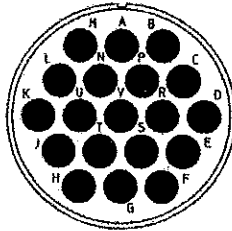

J-20
3 SIZE 8 TWINAX CONTACTS
4 SIZE 12 COAX CONTACTS
13 SIZE 16 CONTACTS
10 SIZE 20 CONTACTS

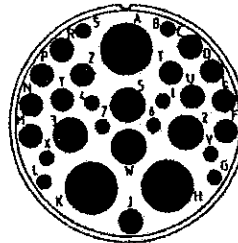

J-24
12 SIZE 12 CONTACTS
12 SIZE 16 CONTACTS

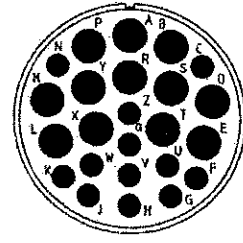

J-29
29 SIZE 16 CONTACTS

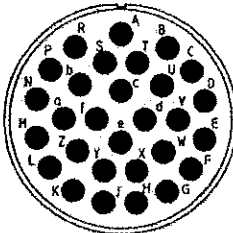

J-35
128 SIZE 22D CONTACTS

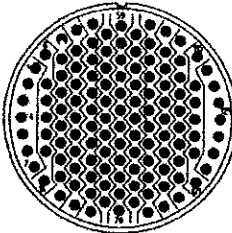

J-43
20 SIZE 16 CONTACTS
23 SIZE 20 CONTACTS

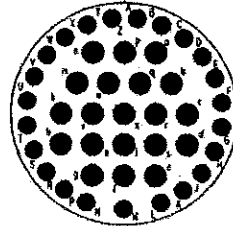

J-61
61 SIZE 20 CONTACTS

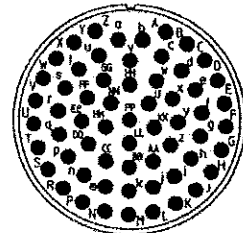

Protective Covers for 38999 III Composite and Metal

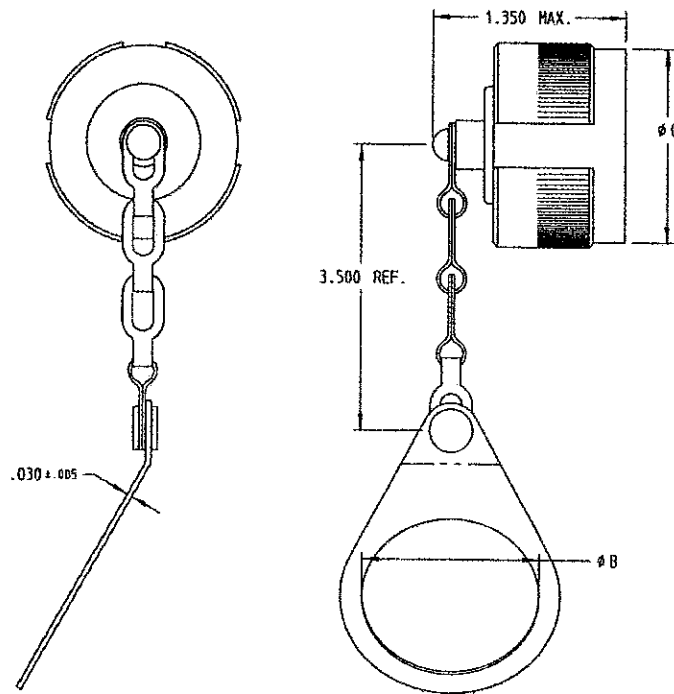

Available in both environmental and environmental RFI/EMI (Shielding).

Part Numbers

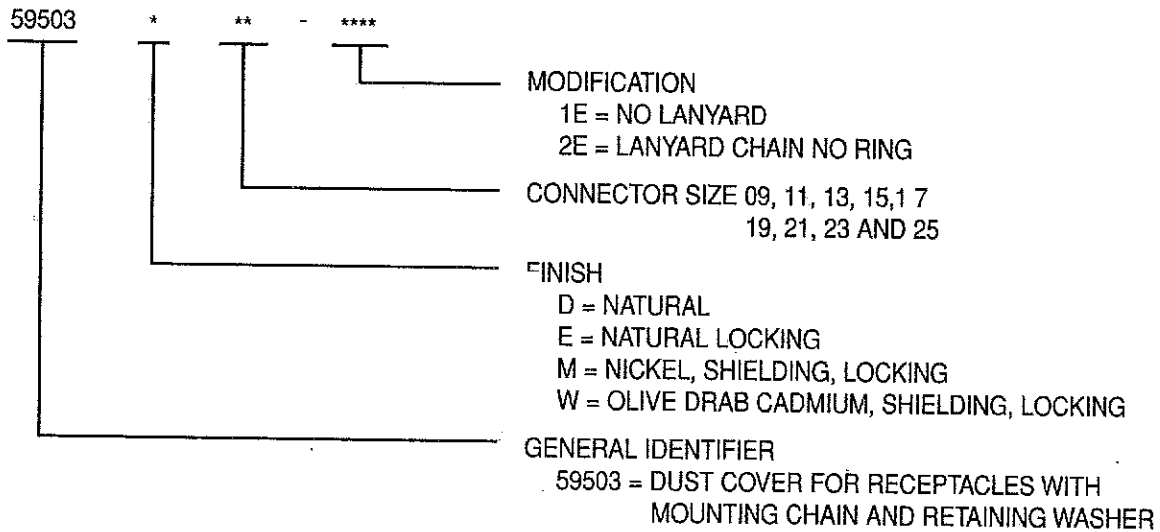

Lightweight Strain Relief, Tie-Type

The ACT provides additional environmental protection by offering a systems approach to rear accessories. The ACT Strain Relief, Tie-Type is made from durable, lightweight, corrosion proof composite materials, and is supplied with a secondary grommet. The secondary grommet provides true strain relief and vibration dampening while providing dynamic moisture intrusion seals.

90 Degree

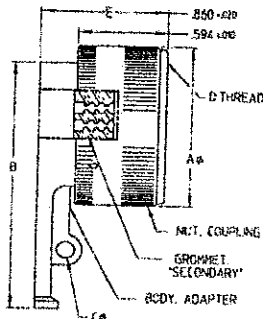

Straight

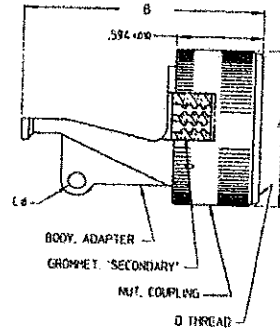

SHELL SIZE	±.015 Aφ	±.080 B	±.010 Cφ	D METRIC THREAD	±.015 E
A	.650	1.948	.140	M12X1.0-6H0.100R	.832
B	.775	2.010	.140	M15X1.0-6H0.100R	.832
C	.905	2.075	.140	M18X1.0-6H0.100R	.832
D	1.030	2.135	.140	M22X1.0-6H0.100R	.832
E	1.160	2.198	.140	M25X1.0-6H0.100R	.832
F	1.270	2.258	.140	M28X1.0-6H0.100R	.832
G	1.400	2.320	.140	M31X1.0-6H0.100R	.832
H	1.525	2.383	.140	M34X1.0-6H0.100R	.832
J	1.655	2.445	.140	M37X1.0-6H0.100R	.832

SHELL SIZE	±.015 Aφ	±.080 B	±.010 Cφ	D METRIC THREAD
A	.650	1.642	.120	M12X1.0-6H0.100R
B	.775	1.642	.120	M18X1.0-6H0.100R
C	.905	1.642	.120	M15X1.0-6H0.100R
D	1.030	1.642	.120	M22X1.0-6H0.100R
E	1.160	1.642	.140	M25X1.0-6H0.100R
F	1.270	1.642	.140	M28X1.0-6H0.100R
G	1.400	1.642	.140	M31X1.0-6H0.100R
H	1.525	1.642	.140	M34X1.0-6H0.100R
J	1.655	1.642	.140	M37X1.0-6H0.100R

Strain Relief Ordering Information

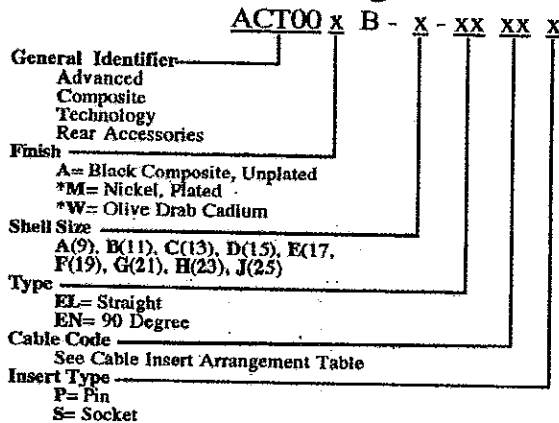

*Consult factory for availability.

Cable Insert Arrangements

CABLE CODE	INSERT ARR.	CABLE CODE	INSERT ARR.	CABLE CODE	INSERT ARR.
38	A-35	53	E-35	68	J-24
39	A-09	54	F-11	69	J-29
40	B-05	55	F-32	70	J-35
41	B-35	56	F-35	71	J-61
42	B-99	57	G-11	72	B-98
43	C-04	58	G-18	73	D-19
44	C-35	59	G-35	74	C-08
45	C-08	60	G-41	75	E-99
46	D-05	61	H-21	76	G-39
47	D-18	62	H-35	77	J-43
48	D-35	63	H-53	78	D-23
49	D-97	64	H-55	79	E-19
50	E-08	65	J-04	100	D-26
51	E-08	66	J-19		
52	E-26	67	J-20		



Ordering information

Deutsch Connector Part Numbers

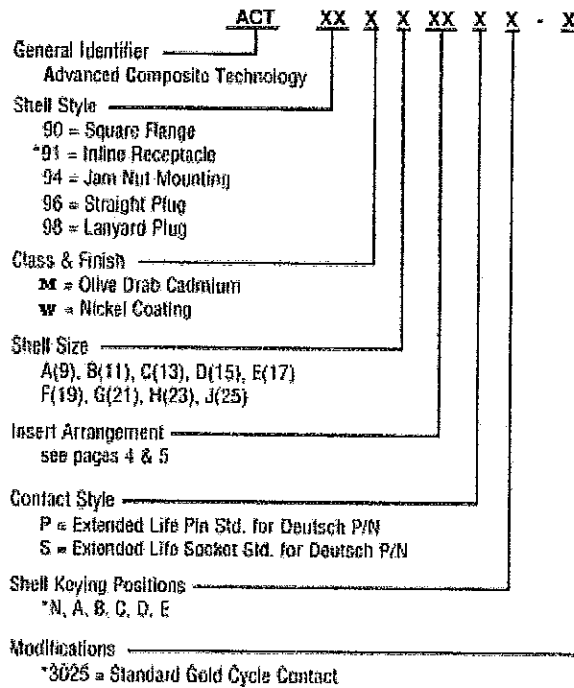

Military Composite Connector Part Numbers

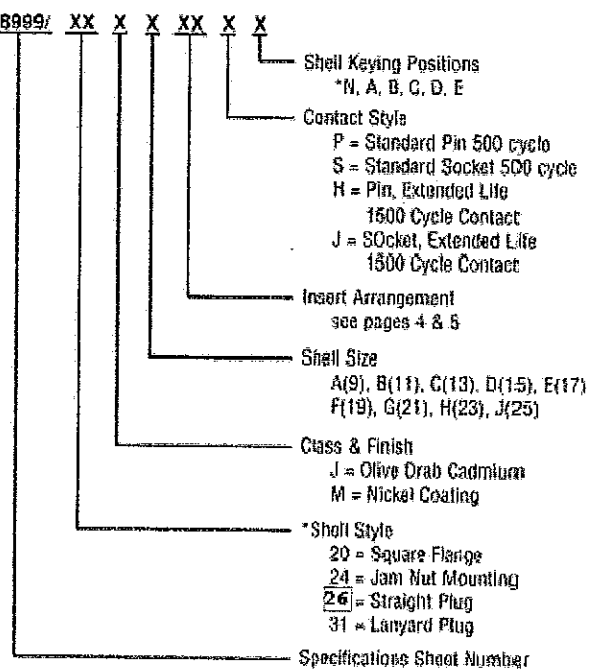

*Consult Factory for availability

Contact & Tooling Information

Size	Contact Deutsch Part Number	Style	Wire Gauge	Crimp Tool (Positioner)	Military Insertion Extraction Tool	Strip Length	Sealing Plugs Deutsch Part Number	Color Code
22D	12331-22 38941-22	PIN	22 THRU 28	M22520/7-01 (M22520/7-07)	M81969/14-01	160-180	MS27488-22	GREEN
22D	12333-22 38943-22	SOCKET	22 THRU 28	M22520/7-01 (M22520/7-05)	M81969/14-01	160-190	MS27488-22	GREEN
20	12331-20 38941-20	PIN	20 THRU 24	M22520/1-01 (M22520/1-04) RED	M81969/14-10	230-260	4113-4-2001	RED
20	12333-20 38943-20	SOCKET	20 THRU 24	M22520/1-01 (M22520/1-04) RED	M81969/14-10	230-260	4113-4-2001	RED
16	12331-16 38941-16	PIN	20 THRU 16	M22520/1-01 (M22520/1-04) BLUE	M81969/14-03	230-260	0813-1-1601	BLUE
16	12333-16 38943-16	SOCKET	20 THRU 16	M22520/1-01 (M22520/1-04) BLUE	M81969/14-03	230-260	0813-1-1601	BLUE
12	12331-12 38941-12	PIN	12 THRU 14	M22520/1-01 (M22520/1-04) YELLOW	M81969/14-04	230-260	0813-1-1201	YELLOW
12	12333-12 38943-12	SOCKET	12 THRU 14	M22520/1-01 (M22520/1-04) YELLOW	M81969/14-04	230-260	0813-1-1201	YELLOW



MIL-C-38999 Series IV

General Description

The Deutsch DIV™ connector is a MIL-C-38999 design that evolved, through logic and necessity, from the specifications of the previous 38999 series. It has become the industry's premier environmental connector in areas where vibration, shock and EMI/EMP require the most any connector can be expected to do, or circumstances when there is no second chance, where reliability is essential.

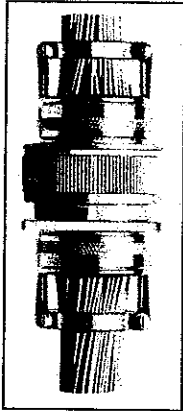

EMI/EMP: The DIV™ was built to strengthen its resistance to, and/or suppression of interfering signals. Special "grounding fingers" form a 360° circle just

inside the shell, acting as a shield. The connector is actually grounded when the shells meet, even before the contacts engage.

Specially designed dielectric retention

fingers hold the contacts. The result is enhanced reliability and dielectric separation far superior to connectors using separate metal clips.

Shock and Vibration: The DIV™ uses a breech-coupling mechanism. It holds up better against severe shock and vibration. Single-unit construction and large metal lands provide a strong locking surface to ensure coupling integrity.

Hermetics: An early Deutsch innovation uses a full glass bead for hermetic sealing. Incorporated into the hermetic version of our DIV™, this design delivers continuous dielectric separation, with a leak rate of less than 1.04×10^{-7} cm³/sec., or 0.01 micron cu. ft/hr.

Installation: Ease was a prime consideration. A blue Ready-to-Mate Indicator line runs from the plug backshell across the coupling thread to the receptacle. When it's lined up, it indicates the DIV™ is ready for engagement. A push, quarter-twist-to-click and the connector is mated securely. Even for blind mating. It's that simple.

Specifications

High Impact Shock

Mated connectors, wired with MIL-C-915/60 or /63 cable and equipped with straight environmentally sealed back shells, withstand high impact shock per MIL-S-901.

Vibration With Rear Accessory Loads

Mated connectors, with weights attached to simulate heavy rear accessories, withstand the following vibration levels:

- Sine vibration per MIL-STD-202, Method 204, Condition G.
- Random vibration per MIL-STD-202, Method 214, Condition II, Letter J.

Shielding Effectiveness, (DIV™46E)

- EMI leakage attenuation greater than 90 dB at 100 MHz and greater than 65 dB through 10 GHz.
- Dynamic EMP protection greater than 90 dB from 1 to 100 MHz while subjected to 3G²/Hz random vibration.
- Shell-to-shell conductivity – 1.0 millivolts maximum. (Class F and N).

Grounding Before Contact Engagement (DIV™46E)

Grounding fingers engage .050 in. minimum prior to engagement of contacts, providing full radiation hazard and HERO protection.

Temperature Range

Class C, F, Y and N: -65°C (-85°F) to +200°C (+392°F). Class W: -65°C (-85°F) to +175°C (+347°F).

Corrosion Resistance

Class C, Y and W withstand 500 hour salt spray. Class F and N withstand 48 hour salt spray.

Fluid Resistance

Connectors withstand specified immersions in MIL-L-7808, MIL-L-23699, MIL-H-5606, Chevron M2-V, Coolanol 25, Gasoline, Ethylene Glycol, Freon TMC, and other solvents and cleaning agents.

Rear Accessory Threads

Metric rear accessory threads provide increased strength and accept standard rear hardware. An uninterrupted cylindrical surface is provided for environmentally sealed accessories.

Scoop-Proof Design

Pin contacts are recessed to prevent damage due to scooping by the mating connector shell.

Pin-to-Pin Mating Protection

Plug and receptacle cannot mate when both contain the same contact type. This prevents the failures possible with many other connectors, which permit pin to mate with pins, resulting in either lack of continuity or short circuits and severe mechanical damage.

Coupling Durability

Exceeds specifications requirements of 500 mate/unmate cycles.



Straight Plug

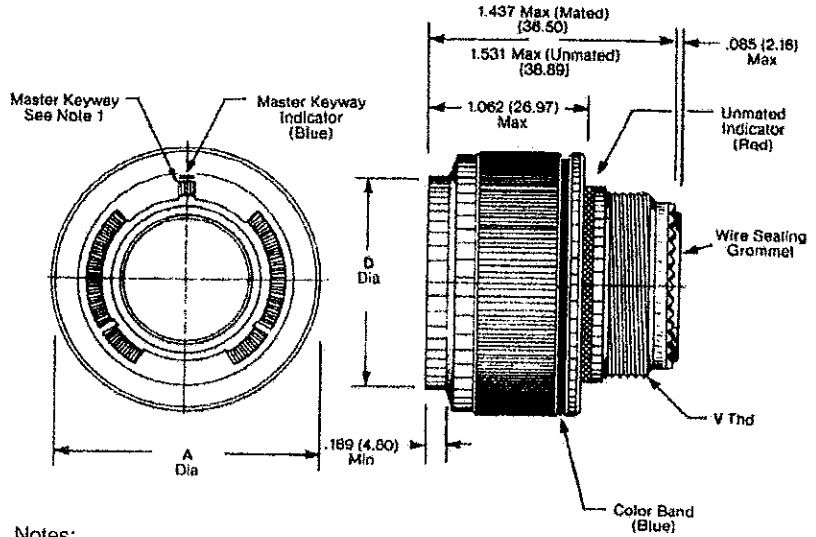
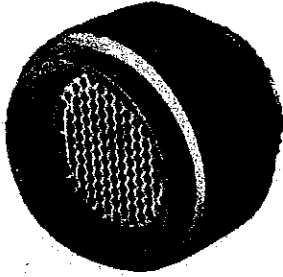

Notes:

1. Key/Keyway position N shown.
For alternate polarization, consult factory.
2. For complete part number, consult factory.

Shell Size	A Dia. Max.		D Dia. Max.		V Thd. Metric
	In.	mm	In.	mm	
11	1.047	28.6	.775	19.7	M15x1.0-6g-0.1R
13	1.220	31.0	.901	22.9	M18x1.0-6g-0.1R
15	1.346	34.2	1.039	26.4	M22x1.0-6g-0.1R
17	1.472	37.4	1.149	29.2	M25x1.0-6g-0.1R
19	1.583	40.2	1.275	32.4	M28x1.0-6g-0.1R
21	1.704	43.3	1.401	35.6	M31x1.0-6g-0.1R
23	1.831	46.5	1.527	38.8	M34x1.0-6g-0.1R
25	1.957	49.7	1.649	41.9	M37x1.0-6g-0.1R



Square Flange Receptacle

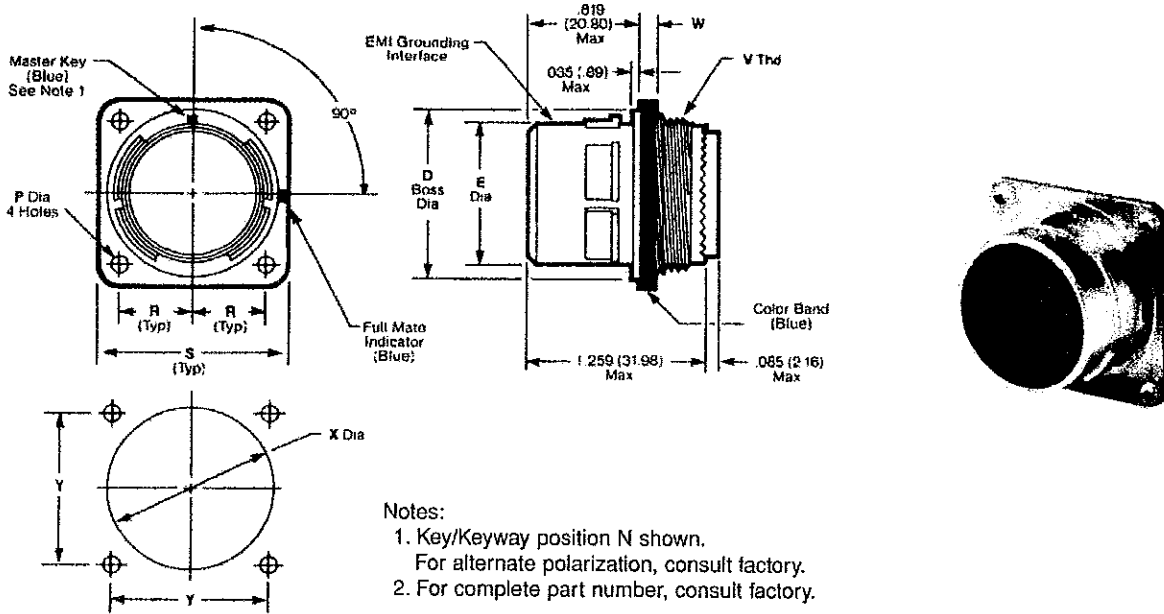

Shell Size	D Boss Dia. Max.		E Dia. Max.		P Dia. Min.		R Bsc.		S Max.	
	In.	mm	In.	mm	In.	mm	In.	mm	In.	mm
11	.793	20.14	.509	12.93	.122	3.10	.406	10.31	1.051	26.70
13	.919	23.34	.634	16.10			.453	11.51	1.145	29.08
15	1.044	26.52	.759	19.28			.4845	12.31	1.240	31.50
17	1.170	29.72	.885	22.48			.531	13.49	1.334	33.88
19	1.294	32.87	1.009	25.63			.578	14.68	1.460	37.08
21	1.419	36.04	1.134	28.80			.625	15.88	1.582	40.18
23	1.544	39.22	1.259	31.98	.142	3.81	.6875	17.46	1.708	43.38
25	1.669	42.39	1.384	35.15			.750	19.05	1.834	46.58

Shell Size	V Thd. Metric	W Max.		X Dia. Basic		Y Bsc.	
		In.	mm	In.	mm	In.	mm
11	M15x1.0-6g-0.1R	.102	2.6	.806	20.47	.812	20.62
13	M18x1.0-6g-0.1R			.932	23.67	.906	23.01
15	M22x1.0-6g-0.1R			1.057	26.85	.989	24.81
17	M25x1.0-6g-0.1R			1.219	30.96	1.082	26.97
19	M28x1.0-6g-0.1R			1.307	33.20	1.158	29.38
21	M31x1.0-6g-0.1R			.133	3.4	1.432	36.37
23	M34x1.0-6g-0.1R	1.557	39.55			1.375	34.93
25	M37x1.0-6g-0.1R	1.682	42.72			1.500	38.10



Box Mounting Receptacle

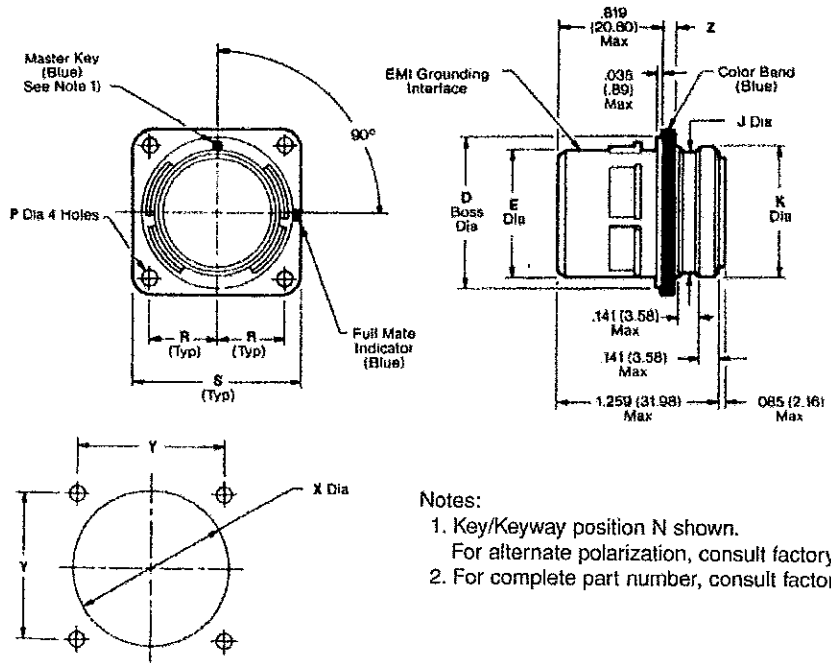
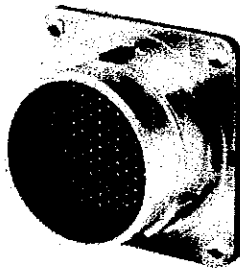

- Notes:
1. Key/Keyway position N shown. For alternate polarization, consult factory.
 2. For complete part number, consult factory.

Shell Size	Q Boss Dia. Max.		E Dia. Max.		J Dia. Max.		K Dia. Max.		P Dia. Min.		R Bsc.	
	In.	mm	In.	mm	In.	mm	In.	mm	In.	mm	In.	mm
11	.793	20.14	.509	12.93	.535	13.6	.578	14.7	1.22	3.10	.406	10.31
13	.919	23.34	.634	16.10	.649	16.5	.692	17.6			.453	11.51
15	1.044	26.52	.759	19.28	.771	19.6	.818	20.8			.4845	12.31
17	1.170	29.72	.885	22.48	.897	22.8	.944	24.0			.531	13.49
19	1.294	32.87	1.009	25.63	1.003	25.5	1.051	26.7			.578	14.66
21	1.419	36.04	1.134	28.80	1.130	28.7	1.173	29.8			.626	15.88
23	1.544	39.22	1.259	31.98	1.255	31.9	1.299	33.0	.142	3.61	.6875	17.46
25	1.669	42.39	1.384	35.15	1.378	35.0	1.425	36.2			.750	19.05

Shell Size	S Max.		X Dia. Bsc.		Y Bsc.		Z Max. Ref.	
	In.	mm	In.	mm	In.	mm	In.	mm
11	1.051	26.70	.606	20.47	.812	20.62	.102	2.6
13	1.145	29.08	.932	23.67	.906	23.01		
15	1.240	31.50	1.057	26.95	.989	24.81		
17	1.334	33.88	1.219	30.96	1.082	26.97		
19	1.460	37.08	1.307	33.20	1.158	29.36		
21	1.582	40.18	1.432	36.37	1.250	31.75	.133	3.4
23	1.708	43.38	1.557	39.55	1.375	34.93		
25	1.834	46.58	1.682	42.72	1.500	38.10		



Jam Nut Receptacle

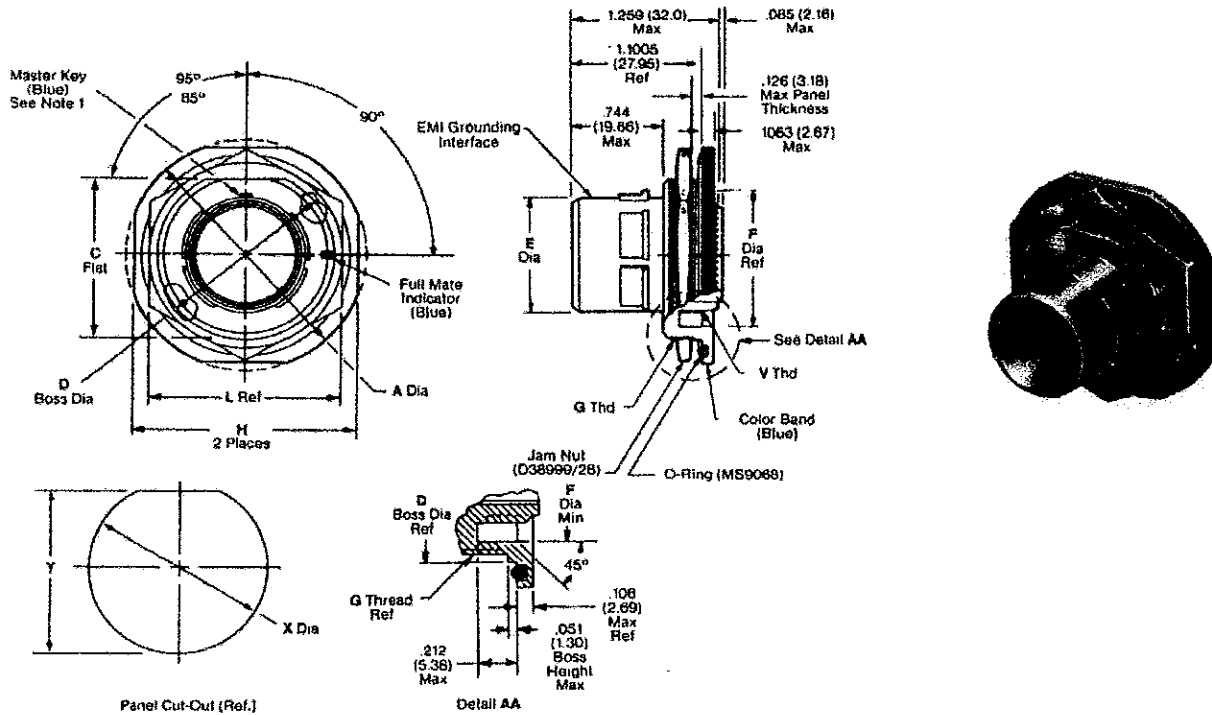

Shell Size	A Dia. Max.		C Flat Max.		D Dia. Max.		E Dia. Max.		F Dia. Min.		G Thd. Metric	H Flnt Max.	
	In.	mm	In.	mm	In.	mm	In.	mm	In.	mm		In.	mm
11	1.520	38.61	.942	23.93	1.000	25.40	.509	12.93	.784	20.17	M25x1.0-6g-0.1R	1.394	35.41
13	1.642	41.71	1.066	27.08	1.125	28.58	.634	16.10	.918	23.32	M28x1.0-6g-0.1R	1.520	38.61
15	1.788	44.91	1.191	30.25	1.250	31.75	.759	19.28	1.038	26.31	M31x1.0-6g-0.1R	1.642	41.71
17	1.957	49.71	1.321	33.55	1.375	34.93	.885	22.48	1.172	29.77	M34x1.0-6g-0.1R	1.799	45.69
19	2.035	51.69	1.441	36.80	1.500	38.10	1.009	25.68	1.266	32.66	M38x1.0-6g-0.1R	1.909	48.49
21	2.157	54.79	1.566	39.78	1.625	41.28	1.134	28.80	1.412	35.86	M41x1.0-6g-0.1R	2.035	51.69
23	2.283	57.89	1.691	42.95	1.750	44.45	1.258	31.90	1.536	39.01	M44x1.0-6g-0.1R	2.157	54.8
25	2.409	61.19	1.816	46.13	1.875	47.63	1.384	35.15	1.662	42.21	M47x1.0-6g-0.1R	2.283	58.0

Shell Size	L Ref.		V Thd. Metric	X Dia. Bsc.		Y Bsc.		Recommended Packing (O Ring)
	In.	mm		In.	mm	In.	mm	
11	1.260	32.0	M15x1.0-6g-0.1R	1.017	25.83	.995	24.25	MS9068-24
13	1.417	36.0	M18x1.0-6g-0.1R	1.144	29.08	1.084	27.53	MS9068-26
15	1.614	41.0	M22x1.0-6g-0.1R	1.289	32.23	1.208	30.68	MS9068-28
17	1.614	41.0	M25x1.0-6g-0.1R	1.394	35.41	1.333	33.86	MS9068-29
19	1.811	46.0	M28x1.0-6g-0.1R	1.517	38.53	1.459	37.06	MS9068-30
21	1.968	50.0	M31x1.0-6g-0.1R	1.644	41.76	1.576	40.03	MS9068-31
23	1.968	50.0	M34x1.0-6g-0.1R	1.769	44.93	1.701	43.21	MS9068-32
25	2.165	55.0	M37x1.0-6g-0.1R	1.884	48.10	1.826	46.39	MS9068-33



Insert Arrangements

(Front Face of Pin Insert Shown) Legend ○ 22D ⊙ 20 ⊖ 16 ⊕ 12

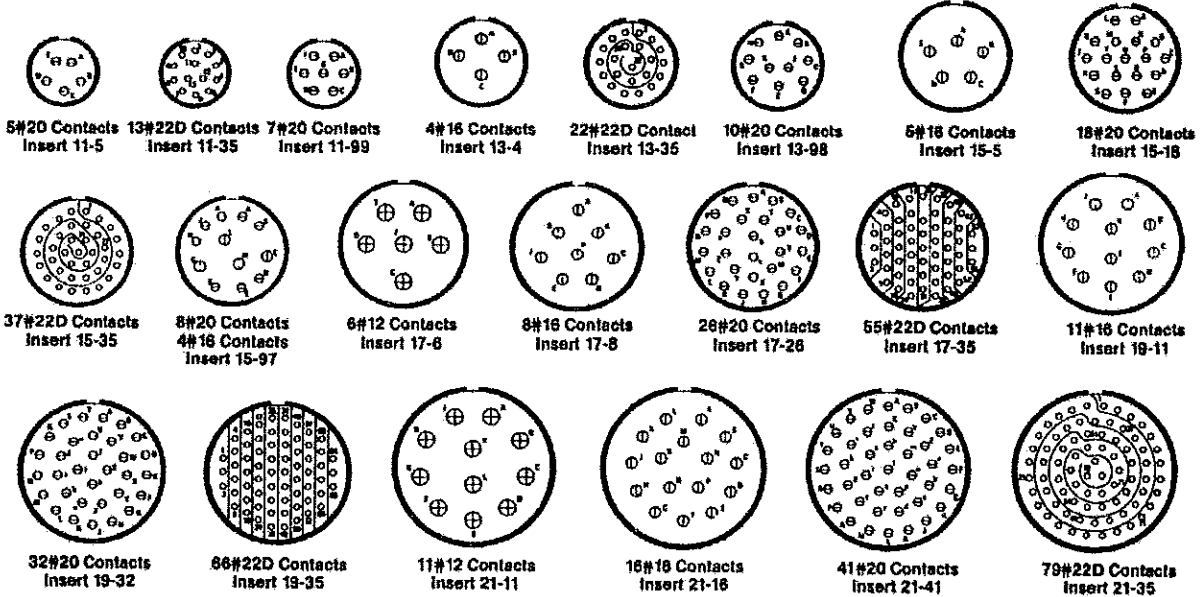

Deutsch Shell Sizes

DIX	Service Rating	Total Contacts	Contact Size			
			22D	20	16	12
11-5	I	5		5		
11-35	M	13	13			
11-99	I	7		7		
13-4	I	4			4	
13-35	M	22	22			
13-98	I	10		10		
15-5	II	5			5	
15-18	I	18		18		
15-35	M	37	37			
15-97	I	12		8	4	
17-6	I	8				8
17-8	II	8				8
17-26	I	26		26		
17-35	M	55	55			
19-11	II	11				11
19-32	I	32		32		
19-35	M	66	66			
21-11	I	11				11
21-16	II	16			16	
21-41	I	41		41		
21-35	M	79	79			
23-21	II	21				21
23-35	M	100	100			
23-53	I	53		53		
23-55	I	55		55		
25-4	I	56		46	8	
25-19	I	19				19
25-24	I	24			12	12
25-29	I	29			29	
25-35	M	128	128			
25-81	I	81		81		

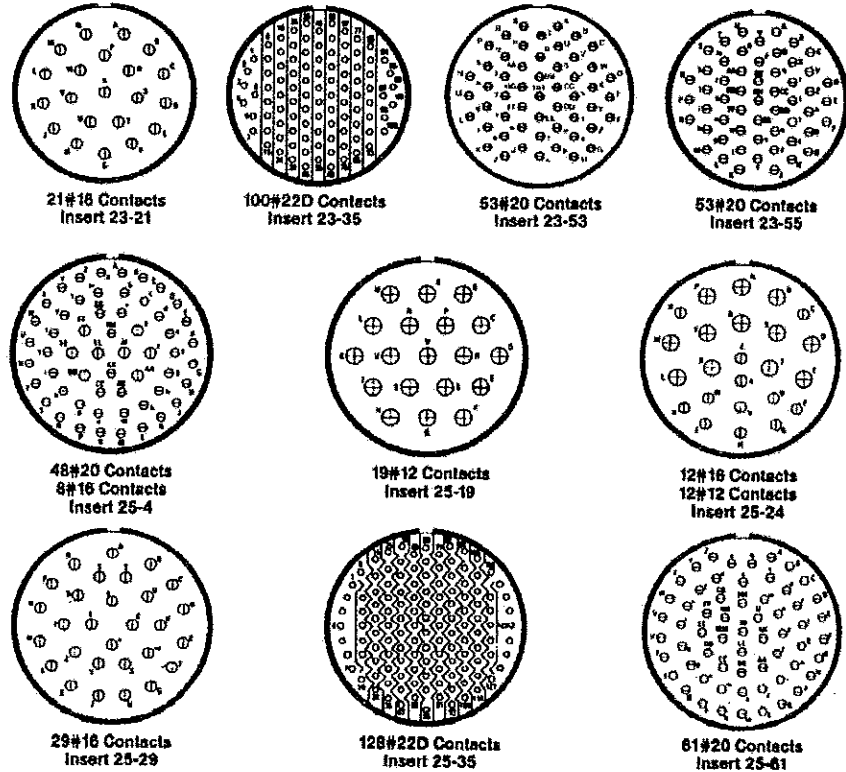

Part Numbering, Contacts

Deutsch Part Numbering

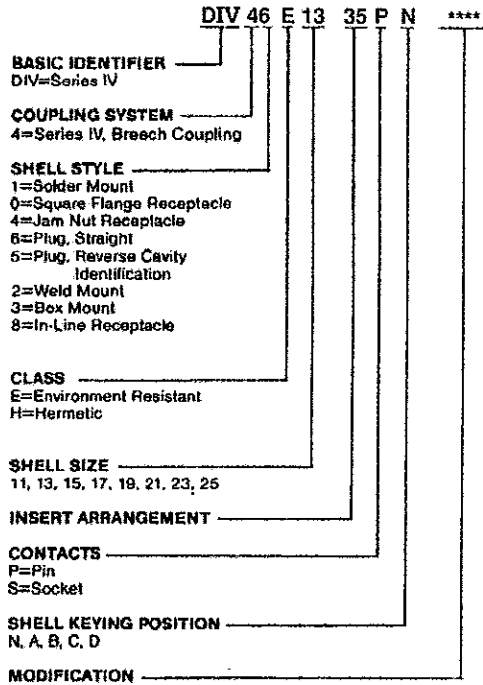

MIL-C-38999/Series IV

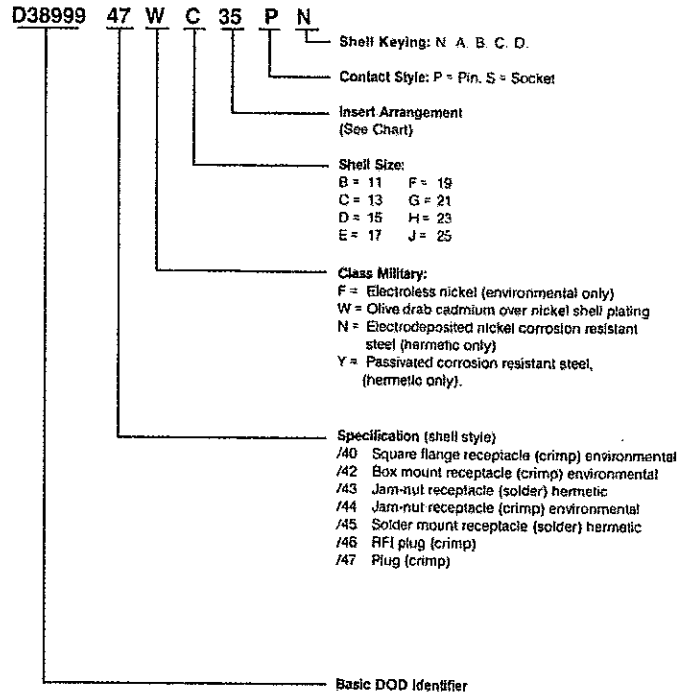

Contacts, Sealing Plugs and Assembly Tools

Contact Size	Deutsch Contacts Part Number	Installing and Removal Tool
Pin		
220	38941-22	MIL-I-81969/14-220
20	38941-20	MIL-I-81969/14-20
16	38941-16	MIL-I-81969/14-16
12	38941-12	MIL-I-81969/14-12
Socket		
220	38943-22	MIL-I-81969/14-220
20	38943-20	MIL-I-81969/14-20
16	38943-16	MIL-I-81969/14-16
12	38943-12	MIL-I-81969/14-12

Contact Size	Insulation Strip Length (inches)	Crimping Tools	Sealing Plugs
220	.160-.180	MS22520/2 cr/7	MS14197-S22
20	.230-.260	MS22520/1, /2 cr/7	MS14197-S20
16	.230-.260	MS22520/1 cr/7	MS14197-S16
12	.230-.260	MS22520/1	MS14197-S12



MIL-C-26482 Series 2

Introduction

Representing the most advanced design in use which both reflects and sets the pace for future developments, Deutsch presents its AFD series connectors qualified to the new Navy Specification MIL-C-0026482. Specifically designed to eliminate failure modes characteristic of many previous devices, MIL-C-0026482 represents a significant improvement over earlier connector types.

Designated as Series 2 of MIL-C-0026482, Deutsch AFD series connectors utilize only the latest "state of the art" concepts and are intermateable and interchangeable with earlier Series 1 devices. Because of this intermateability and interchangeability feature, existing electrical systems can be upgraded easily and inexpensively.

The Navy's release of this new specification represents a major step forward in achieving a true commonality program. The Deutsch AFD series connectors offer several advantages over previous devices, such as:

- Higher Performance Characteristics
- Completely sealed against rigorous environments
- Lower Assembly and Rework Costs

Deutsch MIL-C-0026482 connectors utilize crimp-type contacts... that are inserted, released and removed from the rear of the connector. All that is needed is one, simple, fail-safe insertion/removal tool to install or remove wired contacts. Because the entire assembly process is performed at the connector rear, the possibility of damaging the critical interface of the connector is greatly reduced. This rear release feature also permits the removal or installation of any number of contacts without uncoupling the connectors.

Deutsch uses only high-grade materials and finishes in the fabrication of these connectors. Aluminum components are nickel plated; elastomer components are made of high-temperature, fluid resistant silicone which resists a permanent set and will not revert upon exposure to temperature extremes. The plastic

components of the connector are made of high-strength, electrical grade material. All material and components are processed, manufactured, and quality-controlled in-house to assure exacting performance and high reliability

Here are only a few of the reasons why Deutsch connectors should be considered for retrofit or new design:

INDIVIDUAL CONTACT SEALING

Pin contacts are surrounded by conical-shaped risers on the silicone blanket of the insert which fit into chamfered lead-ins of the socket insert upon connector mating. This "cork-in-bottle" sealing effect assures individual contact sealing at the connector interface.

PROTECTION AGAINST BENT CONTACTS IS BUILT INTO THE DESIGN

Contacts are of one basic configuration with improved geometry for greater bend resistance. The closely-toleranced contact cavity of the plastic insert will not accept a contact that is bent beyond pre-established limits. The closed-down design also prevents unacceptable splaying of contacts when side-loads are applied to the wire bundle. In addition, if a pin contact should become slightly bent, the lead-in chamfer of the hard plastic socket insert acts as a funnel, straightening the pin and guiding it into the socket for proper engagement.

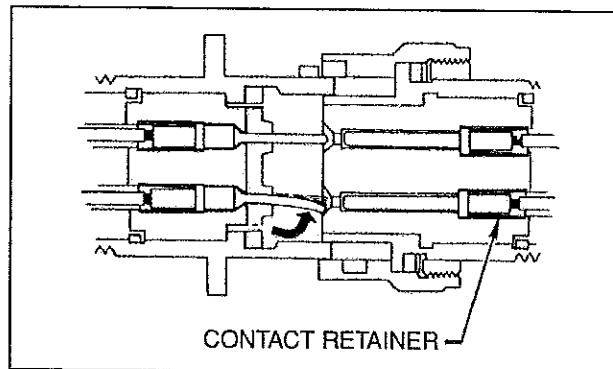

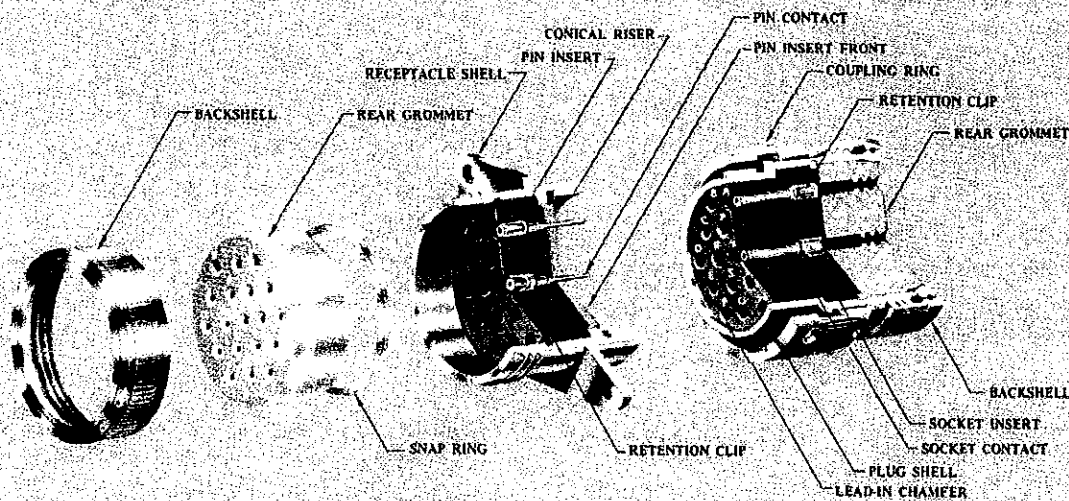

- **REDUCED ASSEMBLY AND REWORK COSTS.**
- **SIMPLIFIED ASSEMBLY PROCEDURES.**
- **HARD PLASTIC SOCKET INTERFACE PREVENTS PENETRATION OF BENT PINS.**
- **CHAMFERED LEAD-INS ON SOCKET INTERFACE PROPERLY ALIGN BENT PINS.**
- **COMPLETELY SEALED AGAINST ENVIRONMENTAL EXTREMES.**

Multiple Seals provide Protection Against Contamination

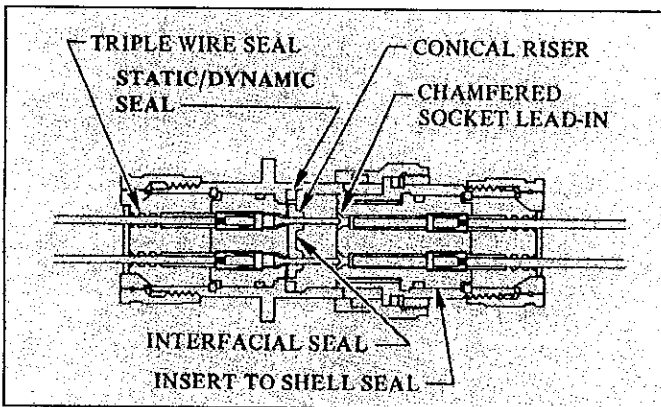

In addition to individual contact sealing, these connectors incorporate additional protective seals to assure sealing against environmental extremes: interfacial compression seal, peripheral static/dynamic

shell-to-shell seal, insert-to-shell seal, and redundant rear wire seals.

Positive Locking Contacts

When the contact has been fully inserted into the insert cavity, the contact retention tines within the insert snap behind the shoulder of the contact. Once seated, contacts remain locked in place, resistant to shock and vibration. Retained between the dielectric insert and contact retention tines, contacts are safeguarded against failures due to contact pushout or pullout.

Positive Contact Engagement

The shell design, the relation of the inserts within the shell, the location of the contact retention device within the inserts, and the contacts themselves, are carefully controlled to assure proper pin and socket engagement under worst case conditions.



MIL-C-26482 Series 2 Bayonet Coupling Connectors

Shell Styles

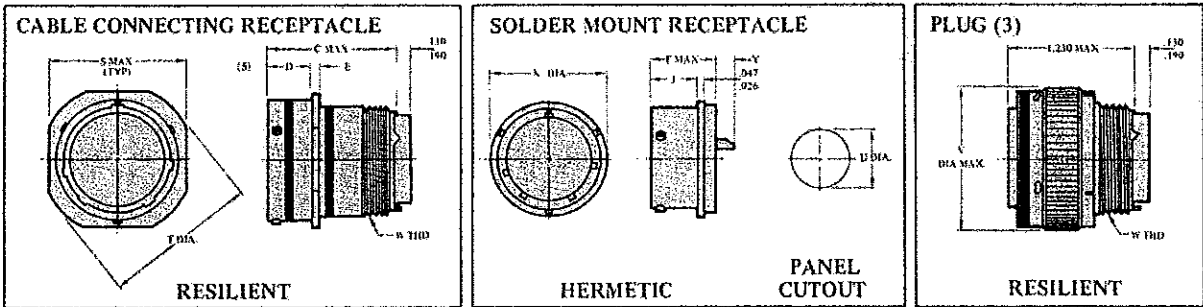
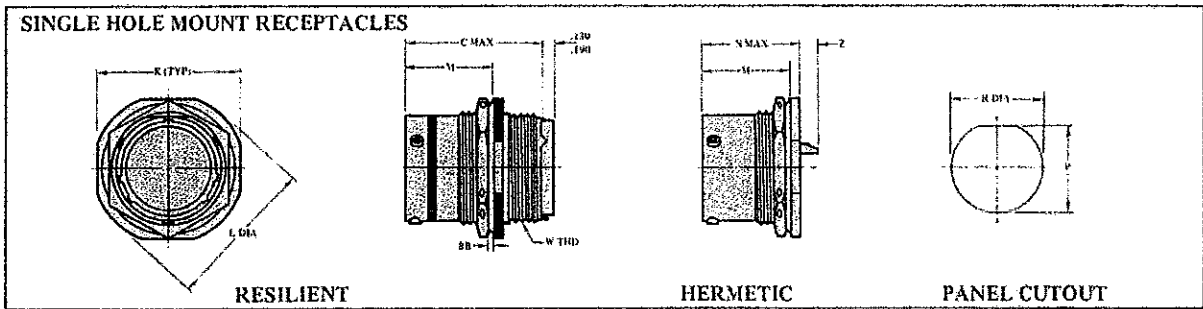
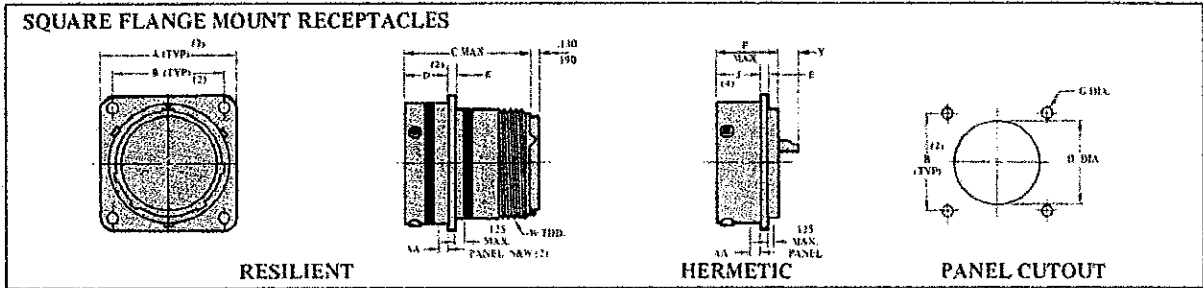

SIZE	AA MAX PANEL		BB MAX PANEL	A MAX (2)		B ± .005 (2)		C MAX	(2) D ± .005		E	F MAX	G ± .005	H	(4) J
	N	W		N	W	N	W		N	W					
8	.087	.118	.187	.828	1.065	.594	.734	1.215	.462 .431	.493 .462	.078 .046	.801	.120	.573 .563	.598 .578
10	.087	.118	.187	.954	1.141	.719	.812	1.215	.462 .431	.493 .462	.078 .046	.801	.120	.690 .680	.598 .578
12	.087	.118	.187	1.047	1.266	.812	.938	1.215	.462 .431	.493 .462	.078 .046	.801	.120	.860 .849	.598 .578
14	.087	.118	.187	1.141	1.360	.906	1.031	1.215	.462 .431	.493 .462	.078 .046	.801	.120	.994 .984	.598 .578
16	.087	.118	.187	1.234	1.453	.960	1.125	1.215	.462 .431	.493 .462	.078 .046	.801	.120	1.118 1.108	.598 .578
18	.087	.118	.187	1.328	1.532	1.062	1.203	1.215	.462 .431	.493 .462	.078 .046	.801	.120	1.243 1.233	.598 .578
20	.212	.212	.250	1.453	1.688	1.156	1.297	1.275	.587 .556	.587 .556	.110 .078	.895	.120	1.368 1.358	.640 .640
22	.212	.212	.250	1.578	1.766	1.250	1.375	1.275	.587 .556	.587 .556	.110 .078	.895	.120	1.493 1.483	.640 .640
24	.212	.212	.219	1.703	1.891	1.375	1.500	1.275	.620 .589	.620 .589	.110 .078	.895	.147	1.620 1.610	.640 .640

NOTES: 1. All Dimensions in inches.
 2. N = Narrow Flange W = Wide Flange.
 3. Plugs with RFI Fingers Have Same Dimensional Control as Shown.
 4. "J" Dimension Same for Both Narrow and Wide Square Flange Connector.
 5. Use narrow flange dimensions. (See Note 2)



Insert Arrangements

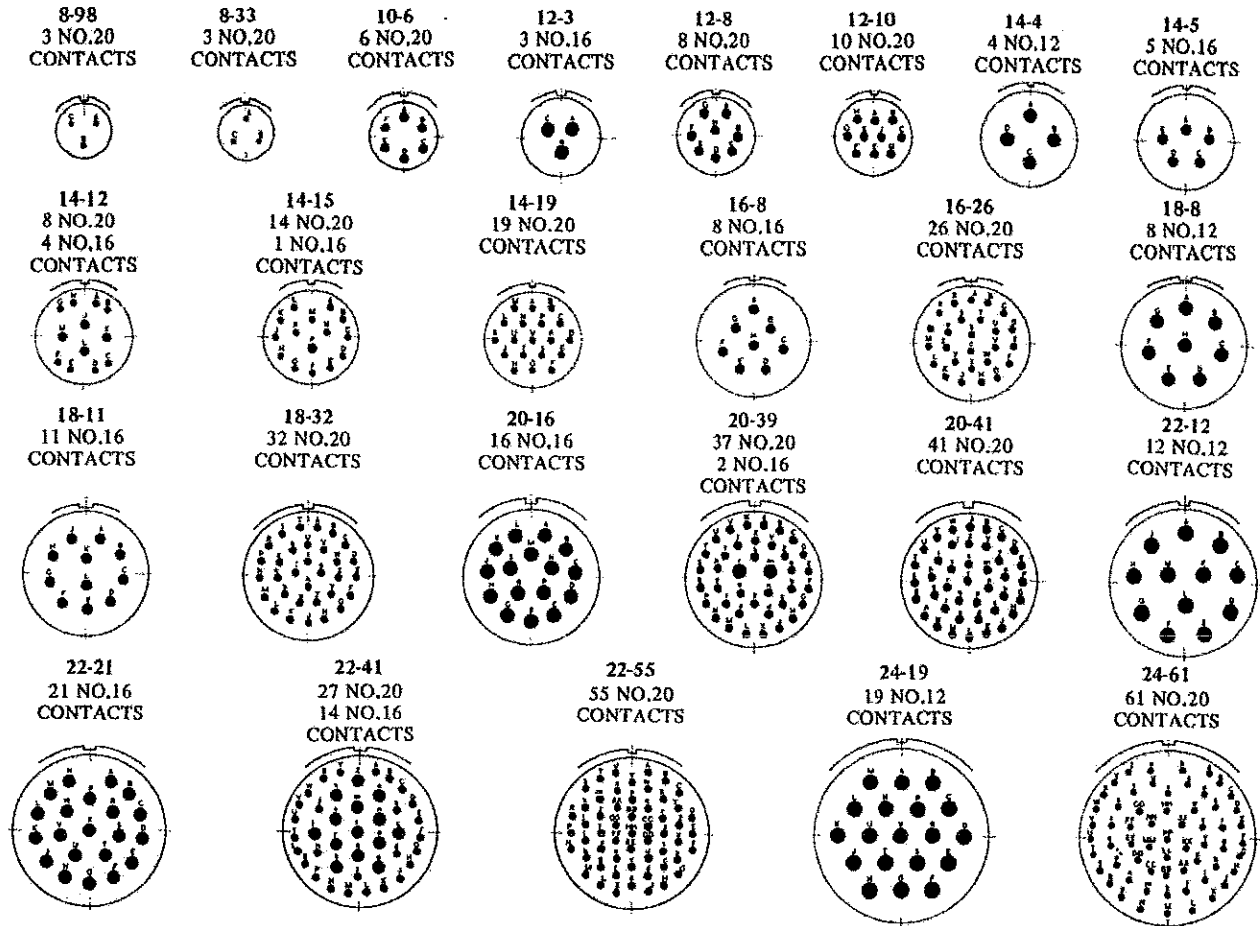

- NOTES:
1. For Other Insert Arrangements Consult Factory.
 2. Cavity Identification Shown Here is for Pin Insert Face (Socket Opposite) and is for Reference Only. Actual Insert Marking Shall be in Accordance With MIL-C-0026482

K	L	M	N MAX	P±.005	R±.005	S MAX	T	U±.005	V MAX	W THREAD-2A	X	Y		Z	
												CONTACT SIZE		CONTACT SIZE	
												20	16 & 12	20	16 & 12
.954 .923	1.078 1.047	.707 .691	.820	.536 .572	.828	.958 .918	.958 .918	.570	.782	1/2-20 UNP	.635 .615	.178 .118	.248 .188	.134 .074	.204 .144
1.078 1.047	1.203 1.172	.707 .691	.820	.661 .697	.954	1.082 1.042	1.082 1.042	.680	.926	5/8-24 UNEF	.760 .740	.178 .118	.248 .188	.134 .074	.204 .144
1.266 1.235	1.391 1.360	.707 .691	.820	.824 .895	1.047	1.176 1.136	1.176 1.136	.789	1.043	3/4-20 UNEF	.854 .834	.178 .118	.248 .188	.134 .074	.204 .144
1.391 1.360	1.516 1.485	.707 .691	.820	.948 1.010	1.141	1.270 1.230	1.270 1.230	.914	1.183	7/8-20 UNEF	.979 .959	.178 .118	.248 .188	.134 .074	.204 .144
1.516 1.485	1.641 1.610	.707 .691	.820	1.072 1.135	1.234	1.364 1.324	1.364 1.324	1.039	1.305	1-20 UNEF	1.104 1.084	.178 .118	.248 .188	.134 .074	.204 .144
1.641 1.610	1.766 1.735	.707 .691	.820	1.197 1.260	1.328	1.458 1.418	1.458 1.418	1.164	1.391	1 1/16-18 UNEF	1.328 1.208	.178 .118	.248 .188	.134 .074	.204 .144
1.828 1.797	1.954 1.923	.772 .754	.920	1.322 1.385	1.453	1.582 1.542	1.582 1.542	1.258	1.531	1 3/16-18 UNEF	1.322 1.302	.178 .118	.248 .188	.099 .039	.169 .109
1.954 1.923	2.078 2.047	.772 .754	.920	1.447 1.510	1.578	1.708 1.668	1.708 1.668	1.383	1.656	1 5/16-18 UNEF	1.448 1.428	.146 .086	.216 .156	.099 .039	.169 .109
2.078 2.047	2.203 2.172	.772 .754	.951	1.572 1.635	1.703	1.832 1.792	1.832 1.792	1.508	1.777	1 7/16-18 UNEF	1.574 1.554	.146 .086	.216 .156	.099 .039	.169 .109



Protective Covers for 26482 (AFD)

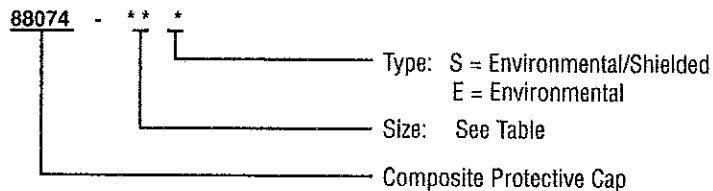
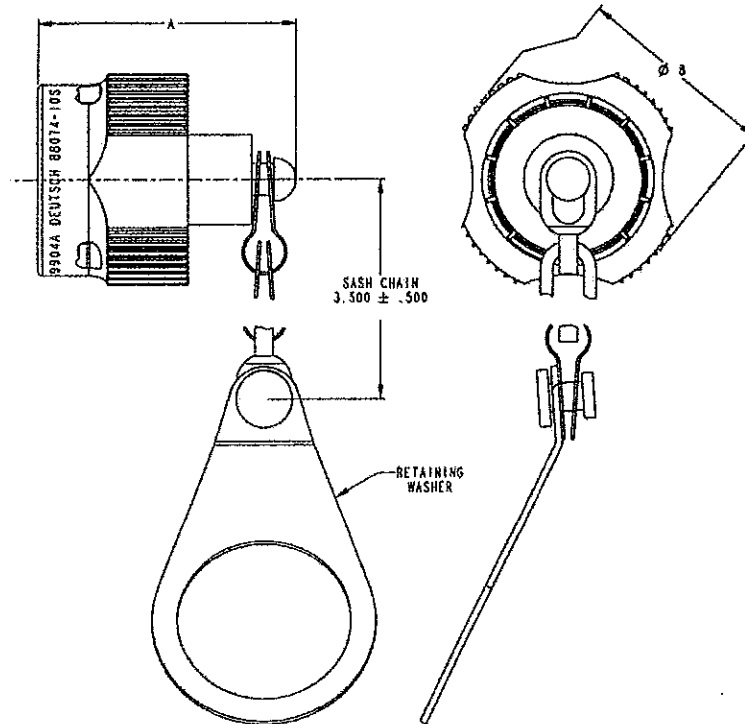

1. Dimensions are in inches unless otherwise specified.
2. Materials:
 - Cap Black Composite
 - Chain Stainless Steel
 - Fasteners Stainless Steel
 - Gasket Silicone
 - Washer Stainless Steel
3. Caps are intermateable with MIL-C-26482 type receptacles.
4. The 88074-**Shielded cap contains a U.L. 94V-0 rated conductive silicone elastomer.
5. Shielded caps exceed MIL-C-25482 requirements for RFI shielding (65dB @ 100 MHz, and 45dB @ 1,000 MHz).
6. Consult factory for availability.

SIZE	A MAX	B REF	SCALLOP COUNT
08	1.200	0.916	4
10	1.200	1.040	4
12	1.200	1.220	6
14	1.200	1.230	6
16	1.200	1.480	6
18	1.200	1.615	8
20	1.200	1.750	8
22	1.200	1.895	8
24	1.250	2.050	8



Contact & Tooling Information



CONTACTS (1)										SEALING PLUG		INSERTION/REMOVAL TOOL		WIRE STRIP LENGTH	
DEUTSCH PART NO.	MILITARY PART NO.	STYLE	COLOR CODE	SIZE	MAX. A	MAX. B	MAX. C	MIN. D	MAX. E	DEUTSCH PART NO.	MILITARY PART NO.	DEUTSCH PART NO.	MILITARY PART NO.		
0641-1-2031	M39029/4-110	PIN	RED	(4)	.20	.720	.103	.078	.048	.041	4113-4-2001	MS27488-20-2	M15570-20	M81969/14-11	5/32" to 7/32"
100503	M39029/5-115	SOC	RED		.20	.656	.103	.078	.048	.078					
0641-2-1631	M39029/4-111	PIN	BLUE		.16	.821	.133	.103	.066	.0635	0613-1-1601	MS27488-16-2	M15570-16	M81969/14-03	1/4" to 5/16"
100504	M39029/5-116	SOC	BLUE		.16	.759	.133	.103	.066	.113					
0641-3-1231	M39029/4-113	PIN	YELLOW		.12	.821	.190	.151	.098	.095	0613-1-1201	MS27488-12-2	M15570-12	M81969/14-04	1/4" to 5/16"
100505	M39029/5-118	SOC	YELLOW		.12	.759	.190	.151	.098	.161					

NOTES: (1) Use Crimp Tool M22520/1-01 Positioner Part No. M22520/1-02.
 2 Size 8 Power Contacts, Coax Contacts, and Size 12 Shielded Contacts are Available (Consult Factory).
 3 Tool For Removal of Unwired Contacts is Also Available Under Part No. M15571.
 4 Crimp Barrel is Color Coded per Tabulation.

Ordering Information

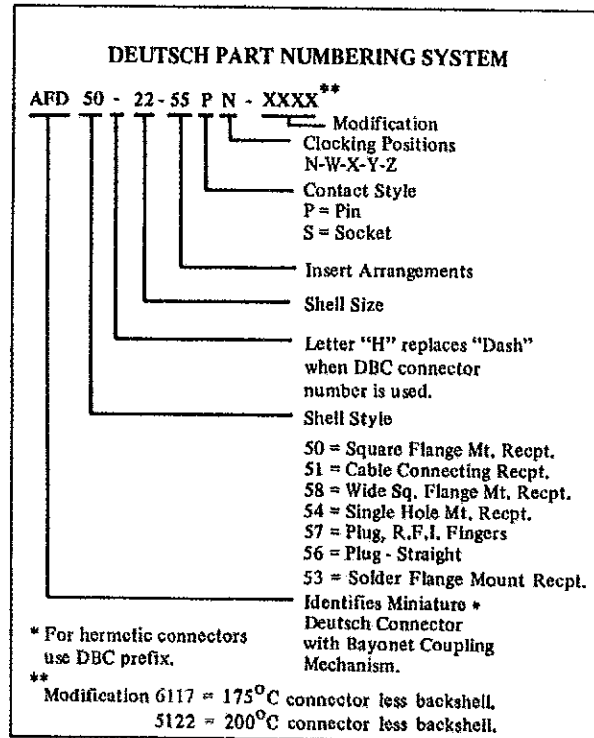
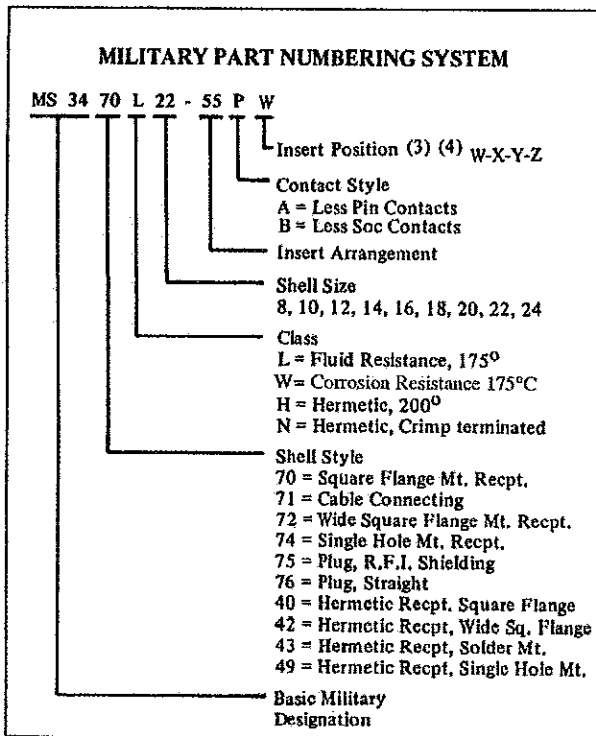

NOTES: 1. All Electrical and Mechanical Specifications per MIL-C-0026482.
 2. Consult Factory for Detailed Description of General Operating Specifications.
 3. The Letter "N" is Not Used in the MS Part Number to Identify "Normal" Insert Clocking.
 4. Consult Factory for Available Alternate Insert Clocking Position data.
 5. Connectors are furnished less backshell, however backshells should be used to insure that sealing requirements are met.



MIL-C-83723 Series 1 & 3

Introduction

Reflecting developments in connector technology, MIL-C-83723 is a comprehensive Air Force specification covering circular, electrical connectors. Intermateable and intermountable with earlier connector types, these devices make it feasible to upgrade many existing electrical connecting systems.

Deutsch produces three basic lines of connectors which are qualified to MIL-C-83723. They feature a high degree of standardization in that contacts, tools, accessories, materials, finishes, assembly procedures, and basic design and performance characteristics are common for all three Deutsch lines. Contributing to a lower total installed cost and increased operational efficiency, this "systems" approach provides the connector user with such benefits as:

- Faster and simpler assembly and rework
- Greater standardization of tooling and procedures
- Reduced training and maintenance

First to qualify to MIL-C-83723, Deutsch connectors have been developed to withstand the extreme environmental conditions encountered by today's high-performance aircraft. They are particularly suited for applications such as: military and commercial aircraft, missiles and space vehicles and related ground support equipment.

Compatible with the military's Integrated Wire Termination System (IWTS) and Common Termination System (CTS), these Deutsch connectors enable the user to implement a commonality program on an evolutionary basis.

Specifically designed to eliminate failure modes characteristic of many previous designs, almost any connecting system can be upgraded. MIL-C-83723 series 1 and series 3 connectors will mate with many of the connector types that are presently in field use.

The series 1 connectors are intermateable and intermountable with existing MIL-C-26482 connector types.

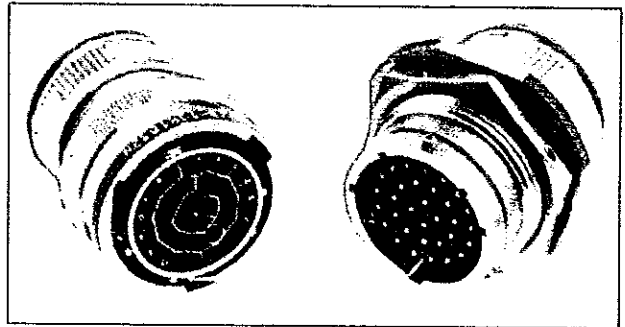

Series 1: Miniature connector with bayonet coupling mechanism. Intermateable and intermountable with MIL-C-26482 type connectors.

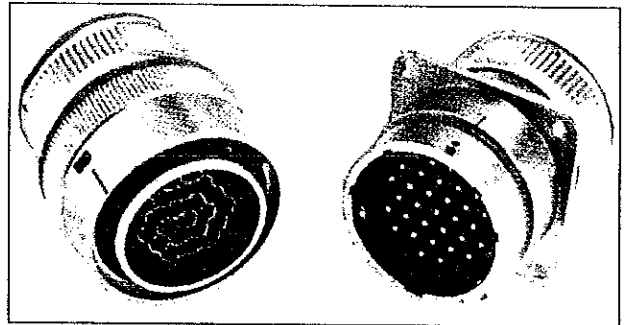

Series 3: Miniature connector with bayonet coupling mechanism. Intermateable and intermountable with MIL-C-26500 and MIL-C-38300 bayonet coupling type connectors.

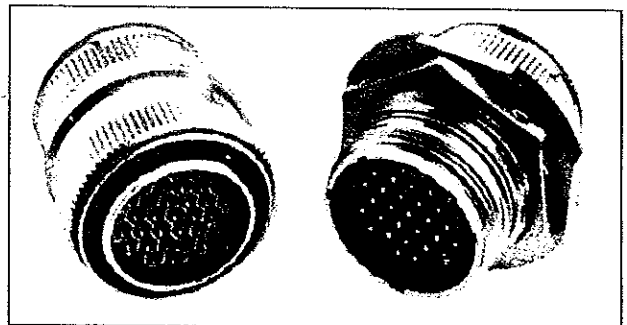

Series 3: Miniature connector with thread coupling mechanism. Intermateable and intermountable with MIL-C-26500 and MIL-C-38300 thread coupling type connectors.



MIL-C-83723 Series 1 & 3

The bayonet coupling version of series 3 will intermate and intermount with MIL-C-26500 and MIL-C-38300 bayonet type connectors.

Thread coupling connectors of series 3 are intermateable and intermountable with thread coupling versions of MIL-C-26500 and MIL-C-38300.

Change over with a minimum of cost and difficulty is assured by this intermateable and intermountable feature.

Deutsch uses only high-grade materials and finishes in the fabrication of these connectors.

Aluminum components are available in either nickel or black anodize plating. Resilient components are made of fluid resistant silicone which resists a permanent set and will not revert upon exposure to temperature extremes. The plastic components of the connector are made of high-strength, electrical grade material. All components are processed, manufactured, and quality-controlled in-house from raw material to finished product to assure exacting performance and high reliability.

Deutsch MIL-C-83723 connectors utilize crimp-type contacts that are inserted, released and removed from the rear of the connector. All that is needed is one, simple, fail-safe insertion/removal tool to install or remove wired contacts. Because the entire assembly process is performed at the connector rear, the possibility of damaging the critical interface of the connector is greatly reduced. This rear release feature also permits the removal or installation of any number of contacts without uncoupling the connector.

POSITIVE LOCKING CONTACTS

When the contact has been fully inserted into the insert cavity, the contact retention tines within the insert snap behind the shoulder of the contact. Once seated, contacts remain locked in place, resistant to shock and vibration. Retained between the dielectric insert and contact retention tines, contacts are safeguarded against failures due to contact pushout or pullout.

POSITIVE CONTACT ENGAGEMENT

The shell design, the relation of the inserts within the shell, the location of the contact retention device within the inserts, and the contacts themselves, are all made to precise, controlled tolerances to assure proper pin and socket engagement under worst case conditions.

MULTIPLE SEALS PROVIDE PROTECTION AGAINST CONTAMINATION

At the pin interface, contacts are surrounded by conical-shaped risers on the silicone blanket of the insert which fit into chamfered lead-ins of the socket insert upon connector mating. This "cork-in-bottle" sealing effect assures individual contact sealing at the connector interface.

In addition to individual contact sealing, these connectors incorporate additional protective seals to assure sealing against environmental extremes: interfacial compression seal, peripheral static/dynamic shell-to-shell seal, insert to shell seal, and redundant rear wire seals.

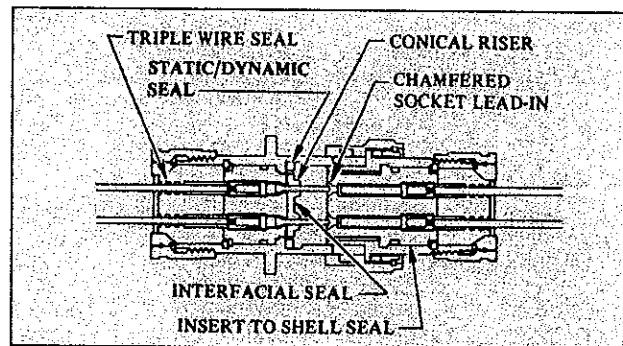

PROTECTION AGAINST BENT CONTACTS IS BUILT INTO THE DESIGN

Contacts are of one basic configuration with improved geometry for greater bend resistance. The closely-toleranced contact cavity of the plastic insert will not accept a contact that is bent beyond pre-established limits. The closed-down design also prevents unacceptable splaying of contacts when side-loads are applied to the wire bundle. In addition, if a pin contact should become slightly bent, the lead-in chamfer of the hard plastic socket insert acts as a funnel, straightening the pin and guiding it into the socket for proper engagement.

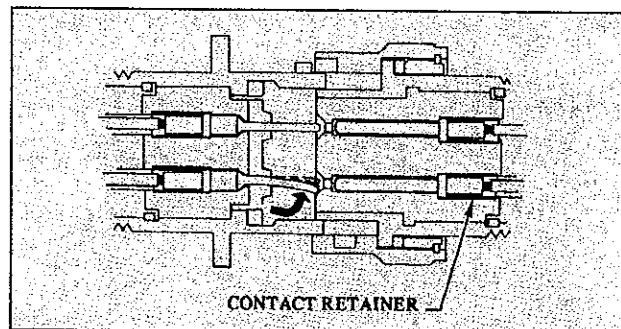

General Specifications

MIL-C-83723 Series 1 & 3

Dielectric withstanding voltage (test voltage):
At sea level: 1500 volts AC (RMS)

Contact spacing (min. nominal):
20 130 center to center
16 168 center to center
12 230 center to center

Current rating:
20 7.5 amps
16 13 amps
12 23 amps

Silicone insert:
Front and rear silicone insert are devoid of all organic matter.

Corrosion:
Meets MIL-STD 202E, Method 101, Condition "B"

Contact millivolt drop:
20 15 millivolts at 7.5 amps
16 21 millivolts at 20 amps
12 22 millivolts at 35 amps

Vibration:
Maintains continuity and exhibits no mechanical or physical damage after a total of 12 hours vibration (4 hours in each of three mutually perpendicular axes) when subjected to .06" D.A. or 20 G's from 10 to 2000 to 12 Hz. 50% of vibration time at ambient temperature, 25% of vibration time at -55°C and 25% of vibration time at +200°C.

Physical shock:
No unlocking, unmating or other unsatisfactory result after 100 G's in each of three mutually perpendicular planes.

Dielectric strength:
500 volts per mil, minimum on a .030" thick test specimen.

Crimp retention:
Meets requirements of MIL-C-83723.

Moisture resistance:
Insulation resistance in excess of 100 megohms after procedure in MIL-STD-202E, method 106.

Temperature:
Operative at temperatures from -55°C to +200°C.

Contact retention:
Contacts withstand a minimum load of:
20 lbs. for size 20
25 lbs. for size 16
30 lbs. for size 12
In either direction, contact displacement less than .012"

Usable wire size:
20 contacts — receive conductor AWG 20 through 24S.
Rear insert will seal on smooth insulation form .040" to .083" O.D.
16 contacts — receive conductor AWG 16 through 20.
Rear insert will seal on smooth insulation form .053" to .103" O.D.
12 contacts — receive conductor AWG 12 through 14.
Rear insert will seal on smooth insulation form .097" to .158" O.D.

Insulation resistance:
5000 megohms minimum at 25°C.

Dielectric withstanding voltage (test voltage) altitude:
Wired, assembled, unmated connectors will withstand:
500 VAC (RMS) at 50,000 ft.
375 VAC (RMS) at 70,000 ft.
200 VAC (RMS) at 110,000 ft.

Durability:
No electrical or mechanical defects after 500 cycles of engagement and disengagement per MIL-C-83723.

Altitude immersion:
Meets requirements of MIL-C-83723.

Air leakage:
Less than 0.01 micron cu/ft/hr at 14.7 psi diff. per MIL-C-83723



Series 1 Insert Alternate Clocking Position

SIZE AND ARRANGEMENT	ALTERNATE POSITIONS				
	N	W	X	Y	Z
8-3	0°	60°	210°		
8-4	0°	45°			
8-33	0°	90°			
8-98	0°	90°			
10-6	0°	90°			
12-3	0°			180°	
12-8	0°	90°	112°	203°	292°
12-10	0°	60°	155°	270°	295°
14-4	0°	45°			
14-5	0°	40°	92°	184°	273°
14-12	0°	43°	90°		
14-15	0°	17°	110°	155°	234°
14-18	0°	15°	90°	180°	270°
14-19	0°	30°	165°	315°	
16-8	0°	54°	152°	180°	331°
16-23	0°	158°	270°		
16-26	0°	60°		275°	338°
18-8	0°	180°			
18-11	0°	62°	119°	241°	340°
18-30	0°	180°	193°	285°	350°
18-32	0°	85°	138°	222°	265°
20-16	0°	238°	318°	333°	347°
20-39	0°	63°	144°	252°	333°
20-41	0°	45°	126°	225°	
22-12	0°				
22-21	0°	16°	135°	175°	349°
22-32	0°	72°	145°	215°	288°
22-41	0°	39°	135°	264°	
22-55	0°	30°	142°	226°	314°
24-19	0°	30°	165°	315°	
24-31	0°	90°	225°	255°	
24-61	0°	90°	180°	270°	324°

▼ Indicates \mathcal{C} of Shell

The symbol α° indicates insert rotation in degrees.

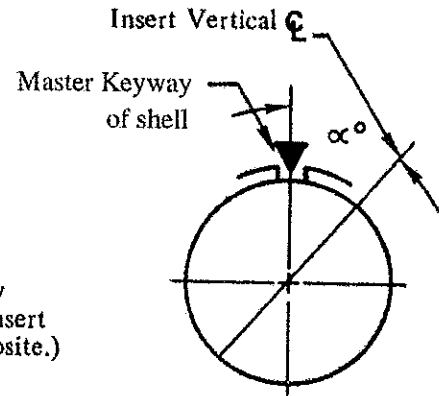

Pin Insert Face View (Socket Insert Face opposite.)

NOTES:

1. For alternate polarizing positions, the connector insert is rotated in respect to the shell.
2. In "Normal Position" (position "N") the insert vertical centerline coincides with the centerline of the master keyway of the shell.
3. In "Alternate Positions" (positions "W", "X", "Y", and "Z") the pin insert is rotated α degrees clockwise relative to \mathcal{C} of the master Keyway of shell.
4. In "Alternate Positions" (positions "W", "X", "Y", and "Z") the socket insert is rotated α degrees counterclockwise relative to the \mathcal{C} of the master keyway of shell.



Series 3 Shell Alternate Keying Position

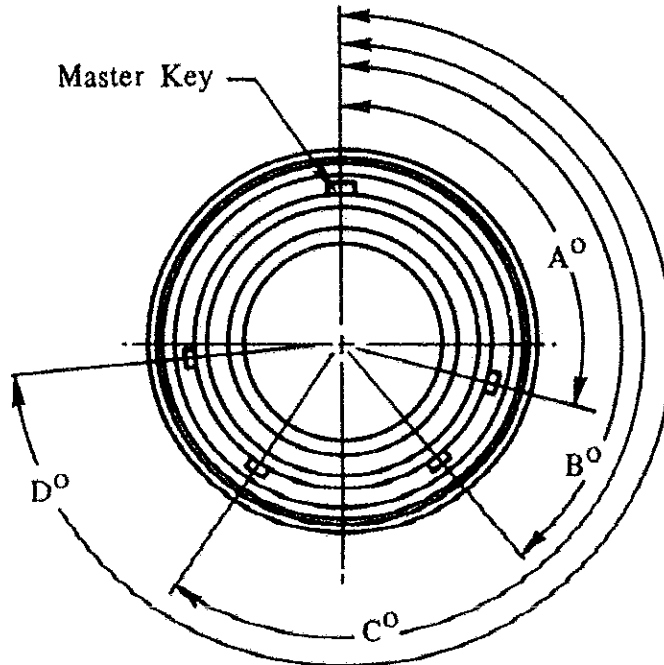

Plug Face shown
(Keyways in Receptacle
Shell are opposite.)

NOTES:

1. In the "Alternate Keying Position" (positions 6, 7, 8, 9, & 10), the keys are positioned as indicated in the chart below with reference to master key.
2. When the alternate shell keying positions are used, the applicable insert is always in the normal position.

KEY/KEYWAY LOCATIONS

KEYING POSITION	SIZE 8				SIZE 10				SIZE 12 THRU 24			
	A ^o	B ^o	C ^o	D ^o	A ^o	B ^o	C ^o	D ^o	A ^o	B ^o	C ^o	D ^o
NORMAL	105	140	215	265	105	140	215	265	105	140	215	265
6	102	132	248	320	102	132	248	320	18	149	192	259
7	80	118	230	312	80	118	230	312	92	152	222	342
8	35	140	205	275	35	140	205	275	84	152	204	334
9	64	155	234	304	64	155	234	304	24	135	199	240
10					25	115	220	270	98	152	268	338



MIL-C-83723 Series 1 Bayonet Coupling Connectors

SHELL STYLES

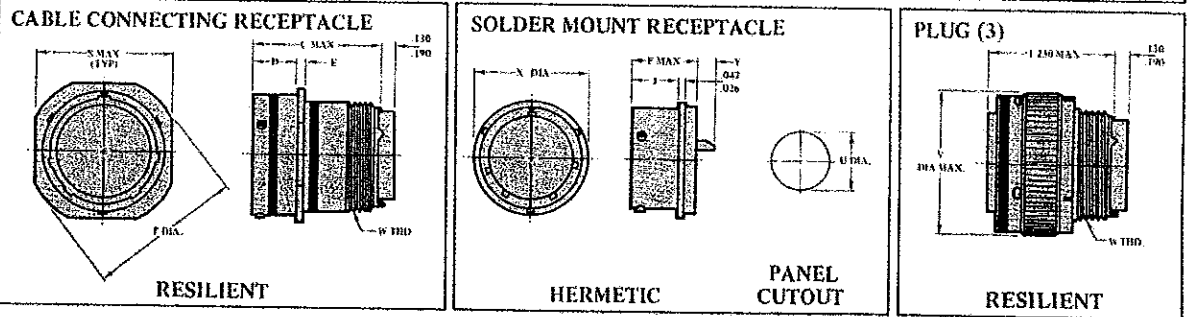
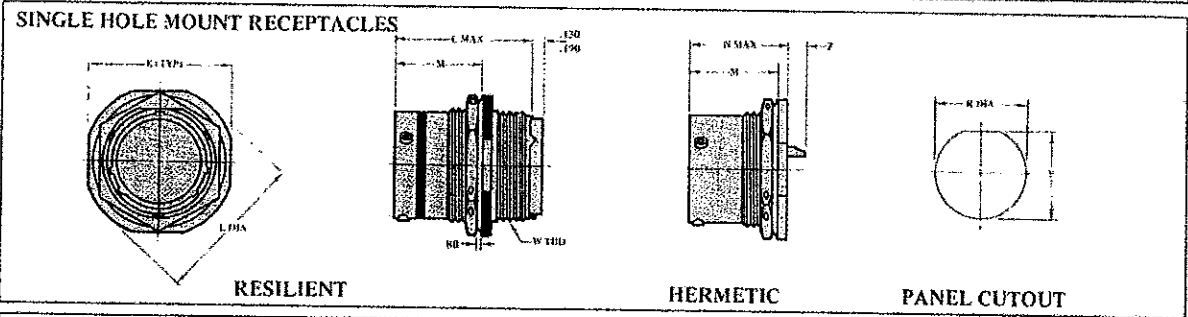
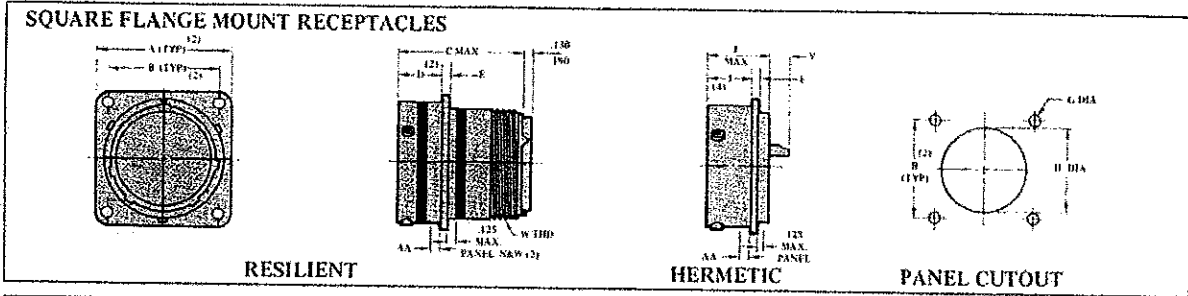

SIZE	AA MAX PANEL		BB MAX PANEL	(2) A MAX		(2) B ±.005		C MAX	(2) D		E	F MAX	G ±.005	(6) H	(4) J
	N	W		N	W	N	W		N	W					
8	.087	.118	.187	.928	1.065	.794	.734	1.215	.462 .431	.493 .462	.078 .046	.801	.120	.473 .562	.598 .578
10	.087	.118	.187	.954	1.141	.719	.812	1.215	.462 .431	.493 .462	.078 .046	.801	.120	.690 .680	.598 .578
12	.087	.118	.187	1.047	1.266	.912	.918	1.215	.462 .431	.493 .462	.078 .046	.801	.120	.848 .859	.598 .578
14	.087	.118	.187	1.141	1.360	.906	1.031	1.215	.462 .431	.493 .462	.078 .046	.801	.120	.994 .984	.598 .578
16	.087	.118	.187	1.234	1.45	.909	1.015	1.215	.462 .431	.493 .462	.078 .046	.801	.120	1.138 1.108	.598 .578
18	.087	.118	.187	1.328	1.532	1.062	1.203	1.215	.462 .431	.493 .462	.078 .046	.801	.120	1.243 1.333	.598 .578
20	.112	.142	.207	1.421	1.614	1.156	1.272	1.275	.587 .556	.587 .556	.110 .078	.895	.120	1.388 1.459	.640 .640
22	.212	.212	.250	1.578	1.766	1.250	1.375	1.275	.587 .556	.587 .556	.110 .078	.895	.120	1.493 1.483	.640 .640
24	.312	.312	.312	1.713	1.891	1.375	1.500	1.275	.610 .589	.610 .589	.108 .078	.895	.120	1.620 1.610	.640 .640

- NOTES: 1. All Dimensions in inches
 2. N = Narrow Flange W = Wide Flange
 3. Plugs with RFI Fingers Have Same Dimensional Control as Shown
 4. "J" Dimension Same for Both Narrow and Wide Square Flange Connector
 5. See Page 12 for Backshell Requirements.
 6. For Front or Rear Mounting.



MIL-C-83723 Series 3 Bayonet Coupling Connectors

SHELL STYLES

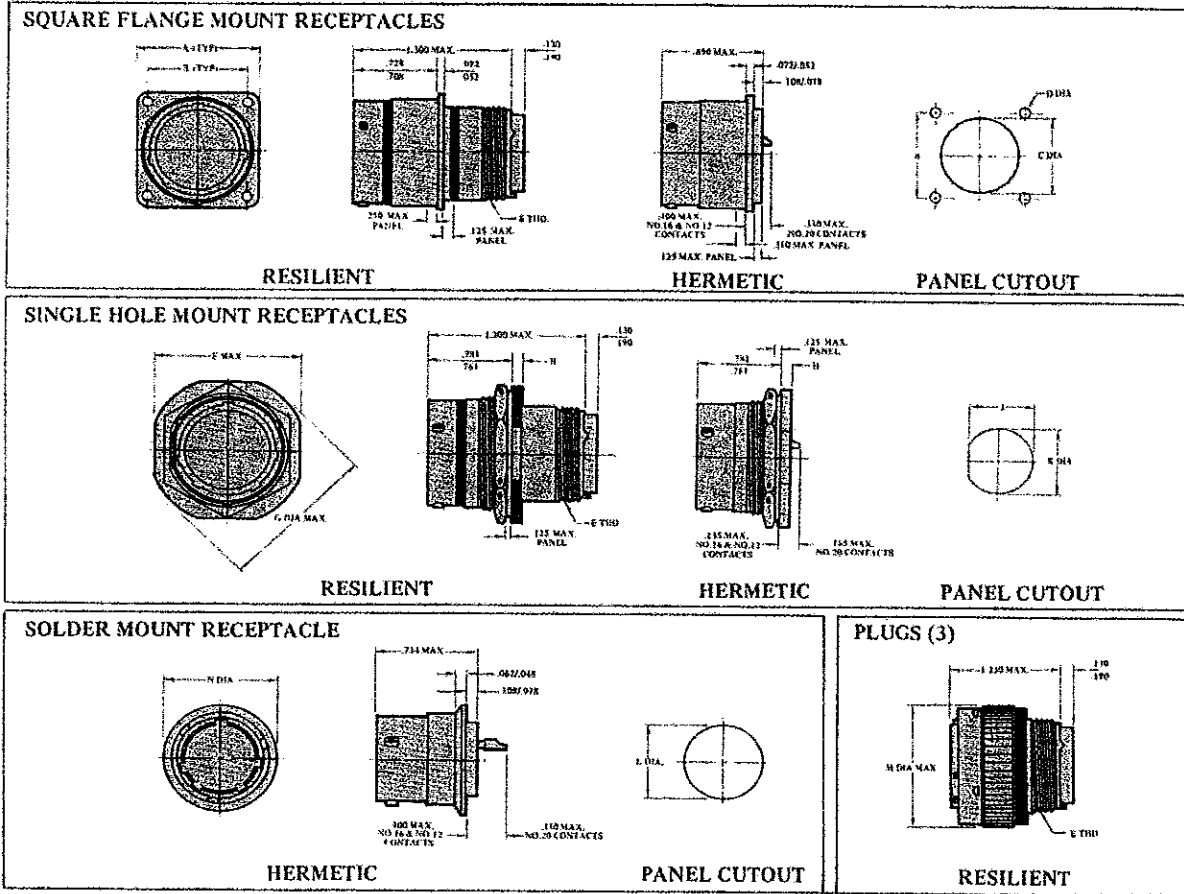

SIZE	A ± .005	B ± .005	C ^{+0.010} _{-0.000}		D ± .010	E THREAD-2A	F MAX	G MAX	H	J ± .005	K ± .005	L ± .005	M MAX	N
			BACK MT. MIN.	FRONT MT. MIN.										
8	.812	.594	.620	.503	.120	1/2-20UNF	.979	1.068	.137 -.097	.605	.635	.510	.766	.760 .920
10	.937	.719	.748	.572	.120	5/8-24UNF	1.104	1.192	.137 -.097	.730	.760	.572	.906	.860 .820
12	1.031	.812	.815	.760	.120	3/4-20UNF	1.231	1.380	.137 -.097	.910	.947	.760	1.078	1.065 1.025
14	1.125	.906	.980	.822	.120	7/8-20UNF	1.391	1.505	.137 -.097	.980	1.010	.822	1.141	1.110 1.070
16	1.250	.969	1.107	.948	.120	1-20UNF	1.516	1.630	.137 -.097	1.105	1.135	.947	1.266	1.230 1.190
18	1.343	1.062	1.209	1.072	.120	1 1/16-18UNF	1.641	1.756	.137 -.097	1.225	1.260	1.072	1.375	1.360 1.320
20	1.437	1.156	1.337	1.192	.120	1 3/16-18UNF	1.766	1.860	.137 -.097	1.350	1.385	1.197	1.510	1.480 1.440
22	1.562	1.250	1.452	1.322	.120	1 5/16-18UNF	1.954	2.068	.168 -.128	1.475	1.510	1.322	1.625	1.610 1.570
24	1.703	1.375	1.577	1.442	.149	1 7/16-18UNF	2.075	2.160	.168 -.128	1.600	1.635	1.447	1.760	1.730 1.690

NOTES: 1. All dimensions in inches
 2. Plugs with RFI Fingers Have Same Dimensional Control as Shown
 3. See Page 12 For Backshell Requirements.



Insert Arrangements

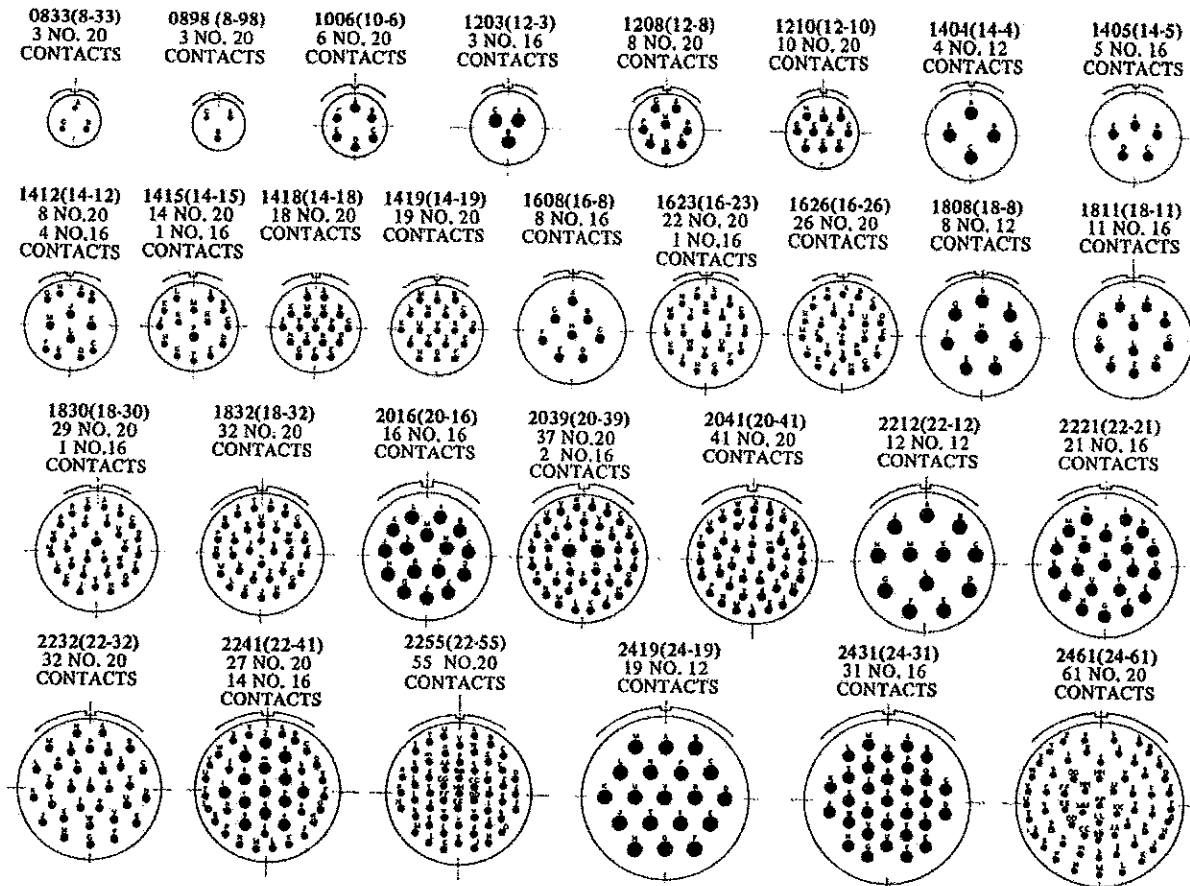

- NOTES: 1. For Other Insert Arrangements Consult Factory.
 2. Military Identification of Insert Arrangement Utilizes 4 Digits as Shown. Deutch Identification of Insert Arrangement is Shown in Parenthesis.
 3. The 8-3 and 8-4 Arrangements are Available only as Pre-wired Connectors (Consult Factory).
 4. Cavity Identification Shown here for Pin Insert Face (Socket Opposite) and is for Reference Only. Actual Insert Marking Shall be in Accordance With Mil C-83723.

K	L	M	N _{MAX}	P _{±.005}	R _{±.005}	S _{MAX}	T	U _{±.005}	V _{MAX}	W _{THREAD-2A}	X	Y		Z	
												CONTACT SIZE	CONTACT SIZE	CONTACT SIZE	CONTACT SIZE
												20	16 & 12	20	16 & 12
.954 .923	1.078 1.047	.707 .691	.820	.536	.372	.828	.958 .918	.570	.782	1/2-20 UNF	.635 .615	.178 .118	.248 .188	.134 .074	.204 .144
1.078 1.047	1.203 1.172	.707 .691	.820	.661	.697	.954	1.082 1.042	.680	.926	5/8-24 UNF	.760 .740	.178 .188	.248 .188	.134 .074	.204 .144
1.266 1.235	1.391 1.360	.707 .691	.820	.824	.893	1.047	1.176 1.136	.789	1.043	3/4-20 UNF	.854 .834	.178 .118	.248 .188	.134 .074	.204 .144
1.391 1.360	1.516 1.485	.707 .691	.820	.948	1.010	1.141	1.270 1.230	.914	1.183	7/8-20 UNF	.979 .959	.178 .118	.248 .188	.134 .074	.204 .144
1.516 1.485	1.641 1.610	.707 .691	.820	1.073	1.135	1.284	1.364 1.324	1.039	1.305	1-20 UNF	1.104 1.084	.178 .118	.248 .188	.134 .074	.204 .144
1.641 1.610	1.766 1.735	.707 .691	.820	1.197	1.260	1.328	1.458 1.418	1.164	1.391	1 1/16-18 UNF	1.228 1.208	.178 .118	.248 .188	.134 .074	.204 .144
1.828 1.797	1.954 1.923	.707 .691	.820	1.322	1.385	1.453	1.582 1.542	1.236	1.531	1 1/8-16 UNF	1.322 1.302	.178 .118	.248 .188	.099 .039	.169 .109
1.954 1.923	2.078 2.047	.707 .691	.820	1.447	1.510	1.578	1.708 1.668	1.383	1.656	1 5/16-18 UNF	1.448 1.428	.140 .086	.210 .156	.099 .039	.169 .109
2.078 2.047	2.203 2.172	.707 .691	.820	1.572	1.635	1.703	1.832 1.792	1.508	1.777	1 7/16-18 UNF	1.574 1.554	.140 .086	.210 .156	.099 .039	.169 .109



Contact & Tooling Information



CONTACTS (1)										SEALING PLUG		INSERTION/REMOVAL TOOL (3)		WIRE STRIP LENGTH
DEUTSCH PART NO.	MILITARY PART NO.	STYLE	COLOR CODE (4)	SIZE	MAX. A	MAX. B	MAX. C	MIN. D	MAX. E	DEUTSCH PART NO.	MILITARY PART NO.	DEUTSCH PART NO.	MILITARY PART NO.	
0641-1-2031	M39029/4-110	PIN	RED	20	.720	.103	.078	.048	.041	M527488-20-2	M527488-20-2	M15570-20	M83723-31-20	5/32" to 7/32"
100503	M39029/5-115	SOC	RED	20	.656	.103	.078	.048	.078	M527488-16-2	M527488-16-2	M15570-16	M83723-31-16	1/4" to 5/16"
0641-2-1631	M39029/4-111	PIN	BLUE	16	.821	.133	.103	.066	.0635	M527488-12-2	M527488-12-2	M15570-12	M83723-31-12	1/4" to 5/16"
100504	M39029/5-116	SOC	BLUE	16	.759	.133	.103	.066	.113					
0641-3-1231	M39029/4-113	PIN	YELLOW	12	.821	.190	.151	.098	.095					
100505	M39029/5-118	SOC	YELLOW	12	.759	.190	.151	.098	.161					

NOTES: (1) Use Crimp Tool M22520/1-01 Positioner Part No. M22520/1-02.
 (2) Size 8 Power Contacts, Coax Contacts, and Size 12 Shielded Contacts are Available (Consult Factory).
 (3) A Tool for Removal of Unwired Contacts is Available Under Part No. M15571.
 (4) Crimp Barrel is Color Coded per Tabulation, Consult Factory for Correct Code since two color bands are used. One denoting Contact Size, the second denoting crimp barrel size.

Rear Accessories (4)

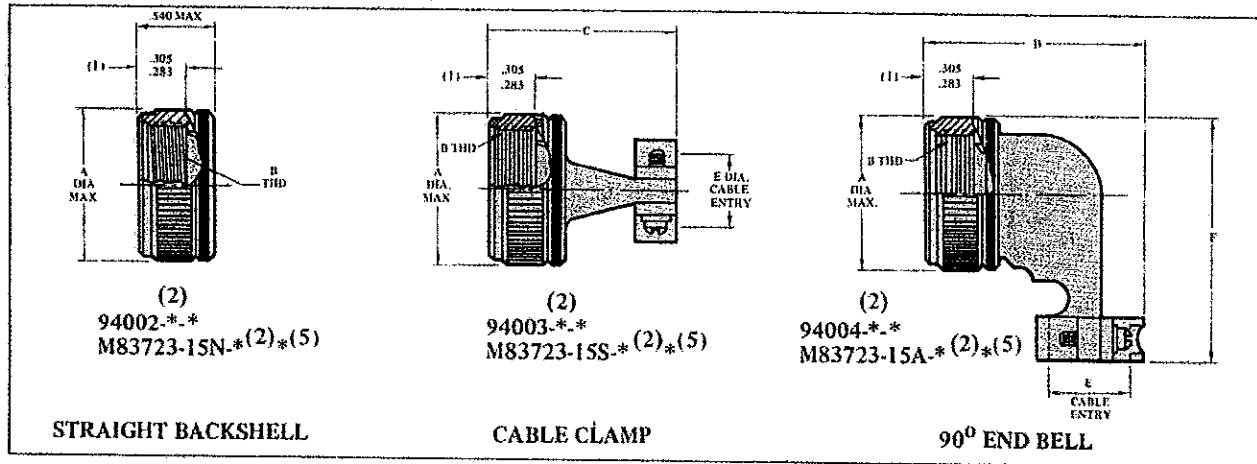

SIZE	DEUTSCH PART NUMBER FOR CLASS A (3)	DEUTSCH PART NUMBER FOR CLASS R (3)	MILITARY PART NO. (3)(5)	A MAX	B THREAD-2B	C ±.031	D MAX	E ±.016	F MAX
8	9400*8	9400*8-3014	M83723-15*8*	.617	1/2-20 UNEF	.859	1.069	.188	1.139
10	9400*10A	9400*10A-3014	M83723-15*10*	.734	5/8-24 UNEF	.859	1.163	.270	1.347
12	9400*12	9400*12-3014	M83723-15*12*	.858	3/4-20 UNEF	.859	1.298	.400	1.379
14	9400*14	9400*14-3014	M83723-15*14*	.984	7/8-20 UNEF	1.093	1.388	.460	1.502
16	9400*16	9400*16-3014	M83723-15*16*	1.113	1-20 UNEF	1.093	1.523	.610	1.626
18	9400*18	9400*18-3014	M83723-15*18*	1.218	1 1/16-18 UNEF	1.093	1.622	.690	1.739
20	9400*20	9400*20-3014	M83723-15*20*	1.345	1 3/16-18 UNEF	1.093	1.755	.815	1.863
22	9400*22	9400*22-3014	M83723-15*22*	1.468	1 5/16-18 UNEF	1.093	1.878	.940	1.994
24	9400*24	9400*24-3014	M83723-15*24*	1.593	1 7/16-18 UNEF	1.093	2.000	1.065	2.117

(1) Dimension From Front of Coupling Nut to Front of Teeth. (2)* Denotes Shell Size. (3)* Denotes Backshell Style. (4). Resilient Connectors Must Have Backshells In Order to Meet Moisture Sealing Requirements. (5)* Denotes Class.



Series 1 Bayonet Coupling

SERIES 1 BAYONET COUPLING

Description	Contact Style	Military Part Number Class (A) Finish	DEUTSCH Part Number Class (A) Finish	Military Part Number Class (R) Finish
Square Flange Receptacle	Socket	M83723-01A**N	AFD50-*. *SN-6116	M83723-01R**N
	Pin	M83723-02A**N	AFD50-*. *PN-6116	M83723-02R**N
Wide Sq. Flange Receptacle	Socket	M83723-03A**N	AFD58-*. *SN-6116	M83723-03R**N
	Pin	M83723-04A**N	AFD58-*. *PN-6116	M83723-04R**N
Single Hole Receptacle	Socket	M83723-05A**N	AFD54-*. *SN-6116	M83723-05R**N
	Pin	M83723-06A**N	AFD54-*. *PN-6116	M83723-06R**N
Cable Connecting Receptacle	Socket	M83723-07A**N	AFD51-*. *SN-6116	M83723-07R**N
	Pin	M83723-08A**N	AFD51-*. *PN-6116	M83723-08R**N
Square Flange, Hermetic	Pin	N/A	N/A	M83723-09H**N
Wide Square Flange, Hermetic	Pin	N/A	N/A	M83723-10H**N
Solder Flange, Hermetic	Pin	N/A	N/A	M83723-11H**N
Single Hole, Hermetic	Pin	N/A	N/A	M83723-12H**N
Plug	Socket	M83723-13A**N	AFD56-*. *SN-6116	M83723-13H**N
	Pin	M83723-14A**N	AFD56-*. *PN-6116	M83723-14H**N
Pre-Wired Plug	Socket	M83723-37A**N	88009-8- *S-6116	M83723-37R**N
	Pin	M83723-36A**N	88009-8- *P-6116	M83723-36R**N
Pre-Wired Narrow Square Flange Receptacle	Socket	M83723-39A**N	88008-8- *S-6116	M83723-39R**N
	Pin	M83723-38A**N	88008-8- *P-6116	M83723-38R**N
Pre-Wired Wide Square Flange Receptacle	Socket	M83723-41A**N	88019-8- *S-6116	M83723-41R**N
	Pin	M83723-40A**N	88019-8- *P-6116	M83723-40R**N

SERIES 3 BAYONET COUPLING

Description	Contact Style	Military Part Number Class (A) Finish	DEUTSCH Part Number Class (A) Finish	Military Part Number Class (R) Finish
Square Flange Receptacle	Socket	M83723-71A**N	DL60R*- *SN-6116	M83723-71R**N
	Pin	M83723-72A**N	DL60R*- *PN-6116	M83723-72R**N
Single Hole Receptacle	Socket	M83723-73A**N	DL64R*- *SN-6116	M83723-73R**N
	Pin	M83723-74A**N	DL64R*- *PN-6116	M83723-74R**N
Plug	Socket	M83723-75A**N	DL66R*- *SN-6116	M83723-75R**N
	Pin	M83723-76A**N	DL66R*- *PN-6116	M83723-76R**N
Plug, R.F.I. Grounding	Socket	N/A	N/A	M83723-77R**N
	Pin	N/A	N/A	M83723-78R**N
Square Flange, Hermetic	Pin	N/A	N/A	M83723-79R**N
Solder Flange, Hermetic	Pin	N/A	N/A	M83723-80R**N
Single Hole, Hermetic	Pin	N/A	N/A	M83723-81R**N
Solder Mount Receptacle with Extended Pins, Hermetic	Pin	N/A	N/A	M83723-93R**N
Single Hole Mount Receptacle with Extended Pins, Hermetic	Pin	N/A	N/A	M83723-94R**N

SERIES 3 THREAD COUPLING

Description	Contact Style	Military Part Number Class (A) Finish	DEUTSCH Part Number Class (A) Finish	Military Part Number Class (R) Finish
Square Flange Receptacle	Socket	M83723-82A**N	DBA30*- *SN-6116	M83723-82R**N
	Pin	M83723-83A**N	DBA30*- *PN-6116	M83723-83R**N
Single Hole Receptacle	Socket	M83723-84A**N	DBA34*- *SN-6116	M83723-84R**N
	Pin	M83723-85A**N	DBA34*- *PN-6116	M83723-85R**N
Plug	Socket	M83723-86A**N	DBA36*- *SN-6116	M83723-86R**N
	Pin	M83723-87A**N	DBA36*- *PN-6116	M83723-87R**N
Square Flange, Hermetic	Pin	N/A	N/A	M83723-88H**N
Single Hole, Hermetic	Pin	N/A	N/A	M83723-89H**N
Solder Flange, Hermetic	Pin	N/A	N/A	M83723-90H**N

NOTE: "N" IN PART NUMBER DENOTES NORMAL POLARIZATION



Ordering information

DEUTSCH Part Number Class (A) Finish	Military Part Number Class (W) Finish	DEUTSCH Part Number Class (W) Finish
	M83723-01W**N	AFD50-*. *SN-6117
AFD50-*. *PN-1A	M83723-02W**N	AFD50-*. *PN-6117
AFD58-*. *SN-1A	M83723-03W**N	AFD58-*. *SN-6117
AFD58-*. *PN-1A	M83723-04W**N	AFD58-*. *PN-6117
AFD54-*. *SN-1A	M83723-05W**N	AFD54-*. *SN-6117
AFD54-*. *PN-1A	M83723-06W**N	AFD54-*. *PN-6117
AFD51-*. *SN-1A	M83723-07W**N	AFD51-*. *SN-6117
AFD51-*. *PN-1A	M83723-08W**N	AFD51-*. *PN-6117
DBC50H-*. *PN	N/A	N/A
DBC58H-*. *PN	N/A	N/A
DBC53H-*. *PN	N/A	N/A
DBC54H-*. *PN	N/A	N/A
AFD56-*. *SN-1A	M83723-13W**N	AFD56-*. *SN-6117
AFD56-*. *PN-1A	M83723-14W**N	AFD56-*. *PN-6117
88009-8- *S-1A	M83723-37W**N	88009-8- *S-6117
88009-8- *P-1A	M83723-36W**N	88009-8- *P-6117
88008-8- *S-1A	M83723-39W**N	88008-8- *S-6117
88008-8- *P-1A	M83723-38W**N	88008-8- *P-6117
88019-8- *S-1A	M83723-41W**N	88019-8- *S-6117
88019-8- *P-1A	M83723-40W**N	88019-8- *P-6117

DEUTSCH Part Number Class (R) Finish	Military Part Number Class (W) Finish	DEUTSCH Part Number Class (W) Finish
DL60R-*. *SN-6106	M83723-71W**N	DL60R-*. *SN-6117
DL60R-*. *PN-6106	M83723-72W**N	DL60R-*. *PN-6117
DL64R-*. *SN-6106	M83723-73W**N	DL64R-*. *SN-6117
DL64R-*. *PN-6106	M83723-74W**N	DL64R-*. *PN-6117
DL66R-*. *SN-6106	M83723-75W**N	DL66R-*. *SN-6117
DL66R-*. *PN-6106	M83723-76W**N	DL66R-*. *PN-6117
DL68G-*. *SN-6106	M83723-77W**N	DL68G-*. *SN-6117
DL68R-*. *PN-6106	M83723-78W**N	DL68G-*. *PN-6117
DL60H-*. *PN	N/A	N/A
DL61H-*. *PN	N/A	N/A
DL64H-*. *PN	N/A	N/A
DL61H-*. *PN-830	N/A	N/A
DL64H-*. *PN-829	N/A	N/A

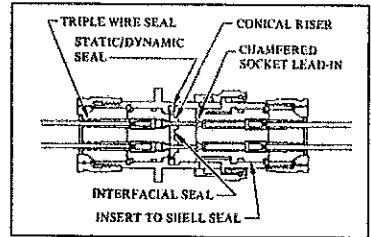

	Military Part Number Class (W) Finish	DEUTSCH Part Number Class (W) Finish
DBA30-*. *SN-6106	M83723-82W**N	DBA30-*. *SN-6117
DBA30-*. *PN-6106	M83723-83W**N	DBA30-*. *PN-6117
DBA34-*. *SN-6106	M83723-84W**N	DBA34-*. *SN-6117
DBA34-*. *PN-6106	M83723-85W**N	DBA34-*. *PN-6117
DBA36-*. *SN-6106	M83723-86W**N	DBA36-*. *SN-6117
DBA36-*. *PN-6106	M83723-87W**N	DBA36-*. *PN-6117
DBC30H-*. *PN	N/A	N/A
DBC34H-*. *PN	N/A	N/A
DBC33H-*. *PN	N/A	N/A

Military Part Numbering System

