

Crydom

88826044

See full Datasheet below...

onlinecomponents.com

THE ONLINE DISTRIBUTOR OF ELECTRONIC COMPONENTS

BUY NOW



MASTERTM
ELECTRONICS

BUY NOW

masterelectronics.com & onlinecomponents.com
are **authorized** e-commerce distributors
of electronic components.



17.5 mm DIN rail mounting MUS2 Part number 88826004



- Relay or solid state output
- Multi-function or mono-function
- Multi-range
- Multi-voltage
- Screw or spring terminals
- LED status indicator (relay version)
- Option of connecting an external power supply to the control input
- 3-wire sensor control option

Type	Functions	Timing	Output	Nominal rating	Connections	Supply voltage
88 826 105 MUR1	A - At - B - C - H - Ht - Di - D - Ac - Bw	0,1s→100h	1 changeover relay	8 A	Screw terminals	24 V DC / 24 →240 V AC
88 826 115 MAR1	A - At	0,1s→100h	1 changeover relay	8 A	Screw terminals	24 V DC / 24 →240 V AC
88 826 125 MBR1	B	0,1s→100h	1 changeover relay	8 A	Screw terminals	24 V DC / 24 →240 V AC
88 826 135 MCR1	C	0,1s→100h	1 changeover relay	8 A	Screw terminals	24 V DC / 24 →240 V AC
88 826 145 MHR1	H - Ht	0,1s→100h	1 changeover relay	8 A	Screw terminals	24 V DC / 24 →240 V AC
88 826 155 MLR1	Li-L	0,1s→100h	1 changeover relay	8 A	Screw terminals	24 V DC / 24 →240 V AC
88 826 100 MUR4	A - At - B - C - H - Ht - Di - D - Ac - Bw	0,1s→100h	1 changeover relay	8 A	Screw terminals	12 V AC / DC
88 826 103 MUR3	A - At - B - C - H - Ht-Di - D - Ac - Bw	0,1s→100h	1 changeover relay	8 A	Screw terminals	12→240 V AC/DC
88 826 503 MURc3	A - At - B - C - H - Ht - Di - D - Ac - Bw	0,1s→100h	1 changeover relay	8 A	Spring terminals	12 →240 V AC / DC
88 826 185 MXR1	Ad - Ah - N - O - P - Pt - Tl - Tt - W	0,1s→100h	1 changeover relay	8 A	Screw terminals	24 V DC / 24 →240 V AC
88 826 004 MUS2	A - At - B - C - H - Ht - Di - D - Ac - Bw	0,1s→100h	Solid state	0,7 A	Screw terminals	24 →240 V AC
88 826 014 MAS5	A	0,1s→100h	Solid state	0,7 A	Screw terminals	24 →240 V AC / DC
88 826 044 MHS2	H	0,1s→100h	Solid state	0,7 A	Screw terminals	24 →240 V AC
88 826 054 MLS2	Li - L	0,1s→100h	Solid state	0,7 A	Screw terminals	24 →240 V AC

Timing

Timing ranges (7 ranges)	1 s - 10 s - 1 min - 10 min - 1 h - 10 h - 100 h TK2R1 : 0.6s - 2.5s - 20s - 160 s
Repetition accuracy with constant parameters	± 0.5 % (IEC/EN 1812-1)
Drift Temperature	± 0,05 % / °C
Drift Voltage	± 0.2 % / V
Display accuracy according to IEC/EN 1812-1	± 10 % / 25 °C
Minimum pulse duration typically (relay version)	30 ms
Minimum pulse duration typically (solid state version)	50 ms
Minimum pulse duration typically (relay version under load)	100 ms
Maximum reset time by de-energisation typically (relay version)	100 ms
Maximum reset time by de-energisation typically (solid state version)	350 ms
Immunity from micro power cuts : typical	> 10 ms

Supply

Multi-voltage power supply	Depending on version
Frequency (Hz)	50 / 60
Operating range	85 to 110 % Un (85 to 120 % Un for 12V AC/DC)
Operator factor	100 %
Max. absorbed power	0,6 W 24 V AC/DC 1,5 W 230 V AC 32 VA 230 V AC

Output specification

1 or 2 changeover relays, AgNi (cadmium-free)	2000 VA/80 W
Rated power	2000 VA/80 W
Maximum breaking current	8 A AC 8A DC
Minimum breaking current	10 mA / 5 V DC
Voltage breaking capacity	250 V AC/ DC
Electrical life (operations)	10 ⁵ operations 8 A 250 V resistive
Mechanical life (operations)	5x10 ⁶
Breakdown voltage acc. to IEC/EN 61812-1	2.5 kV / 1 min / 1 mA / 50 Hz
Impulse voltage acc. to IEC/EN 60664-1, IEC/EN 61812-1	5 kV, wave 1.2 / 50 μs

Solid state output

Rated power	0,7 A AC/DC 20 °C (0,5 A UL)
Derating	5 mA / °C
Maximum admissible current	20 A ≤ 10 ms
Minimum breaking current	10 mA
Leakage current	< 5 mA

Voltage breaking capacity	250 V AC/ DC
Maximum voltage drop at terminals	3 wire 4V - 2 wire 8V
Electrical life (operations)	10 ⁸
Mechanical life (operations)	10 ⁸
Breakdown voltage acc. to IEC/EN 60664-1, IEC 60255-5	2.5 kV to 1 mA / 1 min
Input type	Volt-free contact 3-wire PNP output control option residual voltage : 0.4V whatever the timer power supply

General characteristics

Conformity to standards	IEC/EN 61812-1 IEC/EN 61000-6-1 IEC/EN 61000-6-2 IEC/EN 61000-6-3 IEC/EN 61000-6-4
Certifications	CE, UL, cUL, CSA, GL
Temperature limits use (°C)	-20 →+60
Temperature limits stored (°C)	-30 →+60
Installation category (acc. to IEC/EN 60664-1)	Voltage surge category
Creepage distance and clearance acc. to IEC/EN 60664-1	4 kV / 3
Protection (IEC/EN 60529)	IP 20 IP 40
Degree of protection acc. to IEC/EN 60529 Front face (except Tk2R1)	IP 50
Vibration resistance acc. to IEC/EN 60068-2-6	f = 10 ■ 55 Hz A = 0,35 mm
Relative humidity no condensation acc. to IEC/EN 60068-2-30	93 % sans condensation
Electromagnetic compatibility - Immunity to electrostatic discharges acc to IEC/EN 61000-4-2	Level III (Air 8 KV / Contact 6 KV)
Immunity to electrostatic fields acc. ENV 50140/204 CEI/EN 61000-4-3	Level III 10V/m (80 M Hz to 1 G Hz)
Immunity to rapid transient bursts acc. to IEC/EN 61000-4-4	Level III (direct 2kV / Capacitive coupling clamp 1 KV)
Immunity to shock waves on power supply acc. to IEC/EN 61000-4-5	Level III (2 KV / common mode 2 KV/residual current mode 1KV)
Immunity to radio frequency in common mode acc. to IEC/EN 61000-4-6	Level III (10V rms : 0.15 M Hz to 80 M Hz)
Immunity to voltage dips and breaks acc. to IEC/EN 61000-4-11	30 %/10 ms 60 %/100 ms > 95 %/5 s
Mains-borne and radiated emissions acc. to EN 55022 (CISPR22), EN55011 (CISPR11)	Class B
Fixing : Symmetrical DIN rail	35 mm
Connection capacity - without ferrule	2 x 2,5 mm ²
Connection capacity - with ferrule	2 x 1,5 mm ²
Spring terminals, 2 terminals per connection point - flexible wire	1,5 mm ²
Spring terminals, 2 terminals per connection point - rigid wire	2,5 mm ²
Housing material	Self-extinguishing
Weight : casing 17,5 mm	60 g
Weight : casing 22,5 mm	90 g
Weight : plug-in casing	80 g

Display

Visualisation des états par 1 LED
- Verte clignotante sous tension
Indication du fonctionnement LED verte
Flashes brefs :
- minuterie sous tension, pas de temporisation en cours (sauf Di-D et Li-L) *
Clignotement :
- temporisation en cours
Allumage permanent :
- relais enclenché, pas de temporisation en cours

Dimension Diagram :

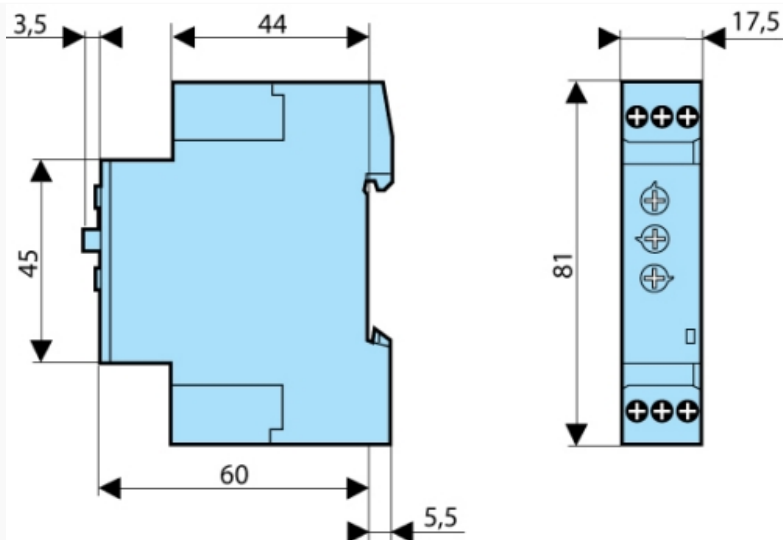

Curves : Function A

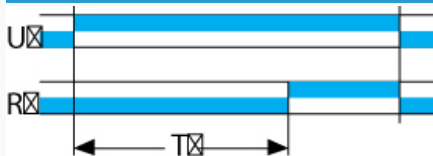

Function A

Delay on energisation

Curves : Function Ac

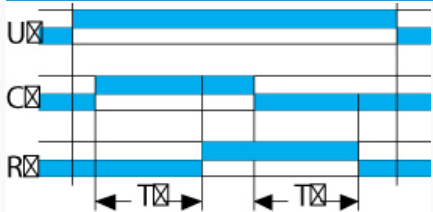

Function Ac

Timing after closing and opening of control contact 1 relay

Curves : Function At

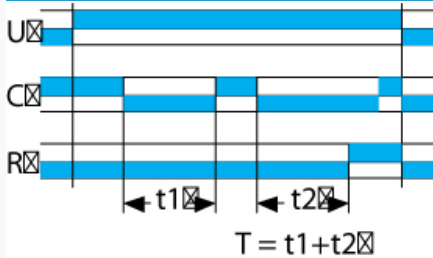

Function At

Timing on energisation with memory 1 relay

Curves : Function B

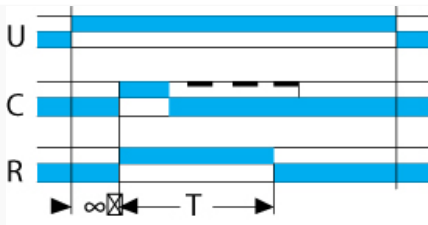

Function B

Timing on impulse one shot 1 relay

Curves : Function Bw

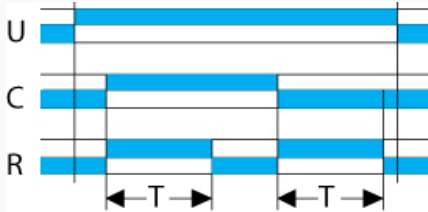

Function Bw

Pulse output (adjustable) 1 relay

Curves : Function C

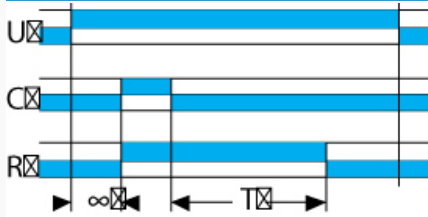

Function C

Timing after impulse 1 timer

Curves : Function D

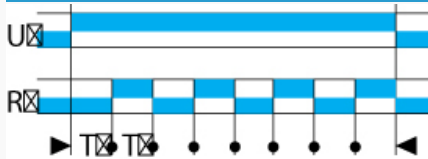

Function D

Flip-flop 1 relay Pause start

Curves : Function Di

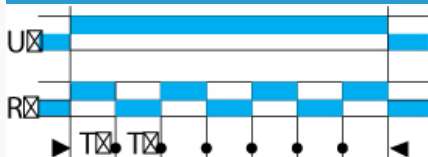

Function Di

Flip-flop 1 relay Pulse start

Curves : Function H

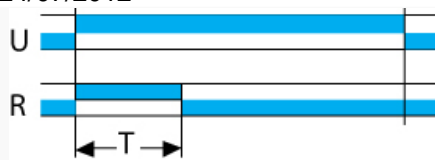

Function H

Timing on energisation 1 relay

Curves : Function Ht

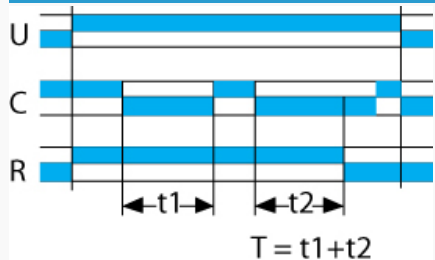

Function Ht

Delay on energisation with memory 1 relay

: Solid state output

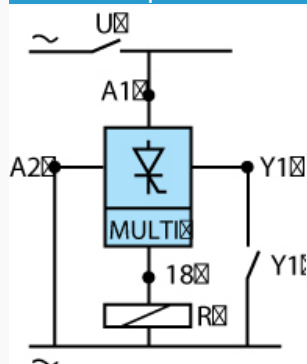

Functions

A-At / H-Ht / B / C / Di-D / Ac / BW
 Ad - Ah - N - O - P - Pt - Tl - Tt - W