

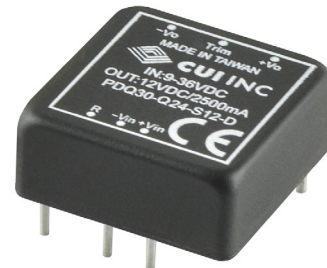

SERIES: PDQ30-D | **DESCRIPTION:** DC-DC CONVERTER

FEATURES

- up to 30 W isolated output
- industry standard 1" x 1" package
- 4:1 input range
- single/dual regulated output
- over voltage, input under voltage lockout, and short circuit protections
- 1,500 Vdc isolation voltage
- five-sided shielded case
- remote on/off control
- output trim
- -40 to 105°C temperature range
- efficiency up to 90%



| MODEL | input voltage | | output voltage | output current | | output power | ripple & noise ¹ | efficiency |
|-----------------|---------------|-------------|----------------|----------------|---------|--------------|-----------------------------|------------|
| | typ (Vdc) | range (Vdc) | (Vdc) | min (A) | max (A) | max (W) | max (mVp-p) | typ (%) |
| PDQ30-Q24-S3-D | 24 | 9~36 | 3.3 | 0 | 7.5 | 24.75 | 75 | 88 |
| PDQ30-Q24-S5-D | 24 | 9~36 | 5 | 0 | 6.0 | 30 | 75 | 90 |
| PDQ30-Q24-S12-D | 24 | 9~36 | 12 | 0 | 2.5 | 30 | 100 | 89 |
| PDQ30-Q24-S15-D | 24 | 9~36 | 15 | 0 | 2.0 | 30 | 100 | 89 |
| PDQ30-Q24-D12-D | 24 | 9~36 | ±12 | 0 | ±1.25 | 30 | 100 | 88 |
| PDQ30-Q24-D15-D | 24 | 9~36 | ±15 | 0 | ±1.0 | 30 | 100 | 88 |
| PDQ30-Q48-S3-D | 48 | 18~75 | 3.3 | 0 | 7.5 | 24.75 | 75 | 88 |
| PDQ30-Q48-S5-D | 48 | 18~75 | 5 | 0 | 6.0 | 30 | 75 | 90 |
| PDQ30-Q48-S12-D | 48 | 18~75 | 12 | 0 | 2.5 | 30 | 100 | 89 |
| PDQ30-Q48-S15-D | 48 | 18~75 | 15 | 0 | 2.0 | 30 | 100 | 89 |
| PDQ30-Q48-D12-D | 24 | 18~75 | ±12 | 0 | ±1.25 | 30 | 100 | 88 |
| PDQ30-Q48-D15-D | 48 | 18~75 | ±15 | 0 | ±1.0 | 30 | 100 | 89 |

Notes: 1. At full load, nominal input, 20 MHz bandwidth oscilloscope, with 10 µF tantalum and 1 µF ceramic capacitors on the output.
2. All specifications are measured at Ta=25°C, nominal input voltage, and rated output load unless otherwise specified.

PART NUMBER KEY

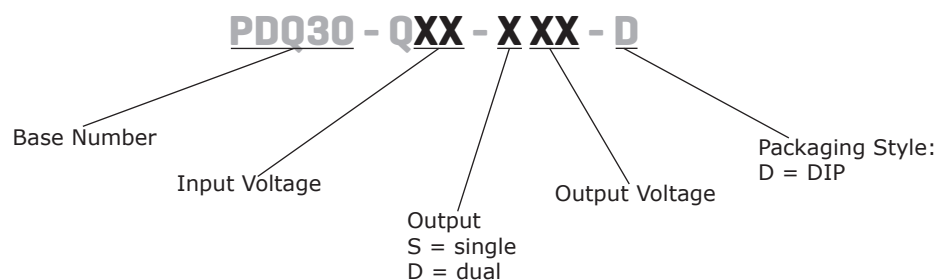

INPUT

| parameter | conditions/description | min | typ | max | units |
|-----------------------------------|--|-----|-----|------|-------|
| operating input voltage | 24 Vdc input models | 9 | 24 | 36 | Vdc |
| | 48 Vdc input models | 18 | 48 | 75 | Vdc |
| surge voltage | for maximum of 100 ms | | | | |
| | 24 Vdc input models | | | 50 | Vdc |
| | 48 Vdc input models | | | 100 | Vdc |
| current | 24 Vdc input models | | | 3.9 | A |
| | 48 Vdc input models | | | 1.95 | A |
| under voltage shutdown | 24 Vdc input models, power up | | 8.5 | | Vdc |
| | 24 Vdc input models, power down | | 8.0 | | Vdc |
| | 48 Vdc input models, power up | | 17 | | Vdc |
| | 48 Vdc input models, power down | | 16 | | Vdc |
| remote on/off ¹ | turn on (3.5~75 Vdc or open circuit) turn off (<1.2 Vdc) | | | | |
| filter | pi filter | | | | |
| input reverse polarity protection | no | | | | |
| input fuse | 6 A time delay fuse for 24 Vdc input models (recommended) 3 A time delay fuse for 48 Vdc input models (recommended) | | | | |

Notes: 1. CMOS or open collector TTL, reference to -Vin.

OUTPUT

| parameter | conditions/description | min | typ | max | units |
|---|--|-----|-------|-------|-------|
| maximum capacitive load | 3.3 Vdc output models | | | 7,500 | μF |
| | 5 Vdc output models | | | 6,000 | μF |
| | 12 Vdc output models | | | 2,500 | μF |
| | 15 Vdc output models | | | 2,000 | μF |
| | ±12 Vdc output models | | | 1,250 | μF |
| | ±15 Vdc output models | | | 1,000 | μF |
| voltage accuracy | | | | ±1.5 | % |
| line regulation | from high line to low line | | | | |
| | single output models | | | ±0.2 | % |
| | dual output models | | | ±0.5 | % |
| load regulation | from full load to minimum load | | | | |
| | single output models | | | ±0.2 | % |
| | dual output models | | | ±1.0 | % |
| voltage balance | dual output models | | | ±1.5 | % |
| cross regulation | load cross variation 10%/100% (dual output models) | | | ±5 | % |
| turn-on delay time, from input | from Vin, min to 10% Vo | | 10 | | ms |
| turn-on delay time, from on/off control | from Von/off to 10% Vo | | 10 | | ms |
| rise time | from 10% Vo to 90% Vo | | 10 | | ms |
| adjustability ² | see application notes | | ±10 | | % |
| switching frequency | 3.3, 5 Vdc output models | | 270 | | kHz |
| | all other models | | 330 | | kHz |
| dynamic load response | 75%-100% step load change | | | | |
| | error band (Vout) | | 5 | | % |
| | recovery time | | 250 | | μs |
| temperature coefficient | | | ±0.03 | | %/°C |

Note: 2. For single output models only.

PROTECTIONS

| parameter | conditions/description | min | typ | max | units |
|-----------------------------|--|-----|-----|-----|-------|
| over voltage protection | zener or TVS clamp | | | | |
| | 3.3 Vdc output models | | 3.9 | | Vdc |
| | 5 Vdc output models | | 6.2 | | Vdc |
| | 12 Vdc output models (single and dual) | | 15 | | Vdc |
| | 15 Vdc output models (single and dual) | | 18 | | Vdc |
| over current protection | hiccup mode | 110 | 140 | 170 | % |
| short circuit protection | continuous, automatic recovery | | | | |
| over temperature protection | output shutdown, automatic recovery | | 110 | | °C |

SAFETY AND COMPLIANCE

| parameter | conditions/description | min | typ | max | units |
|-----------------------|--|-------|-------|-----|-------|
| isolation voltage | input to output for 1 minute | 1,500 | | | Vdc |
| isolation resistance | input to output | 1,000 | | | MΩ |
| isolation capacitance | input to output | | 1,500 | | pF |
| conducted emissions | EN 55022 Class A (external circuit required, see Figure 3) | | | | |
| RoHS | 2011/65/EU | | | | |

ENVIRONMENTAL

| parameter | conditions/description | min | typ | max | units |
|-----------------------|------------------------|-----|-----|-----|-------|
| operating temperature | see derating curves | -40 | | 105 | °C |
| storage temperature | | -55 | | 125 | °C |
| operating humidity | non-condensing | | | 95 | % |

SOLDERABILITY

| parameter | conditions/description | min | typ | max | units |
|----------------|----------------------------|-----|-----|-----|-------|
| wave soldering | see wave soldering profile | | | 260 | °C |

- Notes:
1. Soldering materials: Sn/Cu/Ni
 2. Ramp up rate during preheat: 1.4°C/s (from 50°C to 100°C)
 3. Soaking temperature: 0.5°C/s (from 100°C to 130°C), 60±20 seconds
 4. Peak temperature: 260°C, above 250°C for 3~6 seconds
 5. Ramp down rate during cooling: -10°C/s (from 260°C to 150°C)

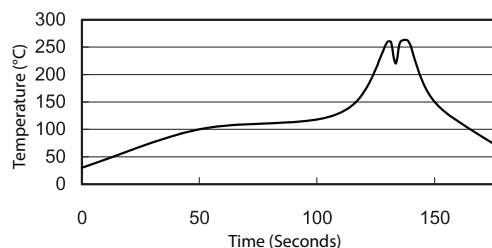

MECHANICAL

| parameter | conditions/description | min | typ | max | units |
|---------------|--|-----|-----|-----|--------|
| dimensions | 1.00 x 1.00 x 0.4 [25.4 x 25.4 x 10.2 mm] | | | | inches |
| case material | black coated copper with non-conductive base | | | | |
| weight | | | 18 | | g |

MECHANICAL DRAWING

units: inches [mm]
 tolerance: X.XX ±0.02 [±0.5]
 X.XXX ±0.010 [±0.25]
 pin diameter tolerance: ±0.004[±0.1]

| PIN CONNECTIONS | | |
|-----------------|----------|--------|
| PIN | Function | |
| | Single | Dual |
| 1 | +Vin | +Vin |
| 2 | -Vin | -Vin |
| 3 | +Vout | +Vout |
| 4 | Trim | Common |
| 5 | -Vout | -Vout |
| 6 | Remote | Remote |

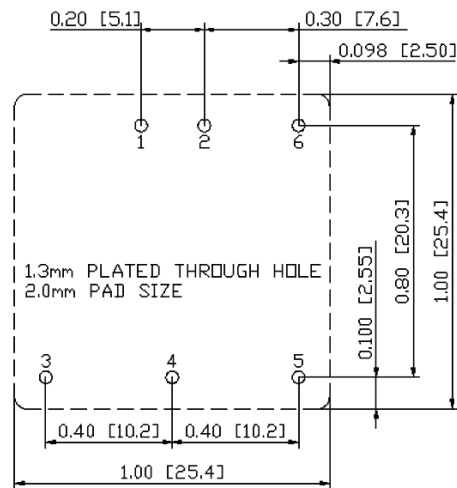
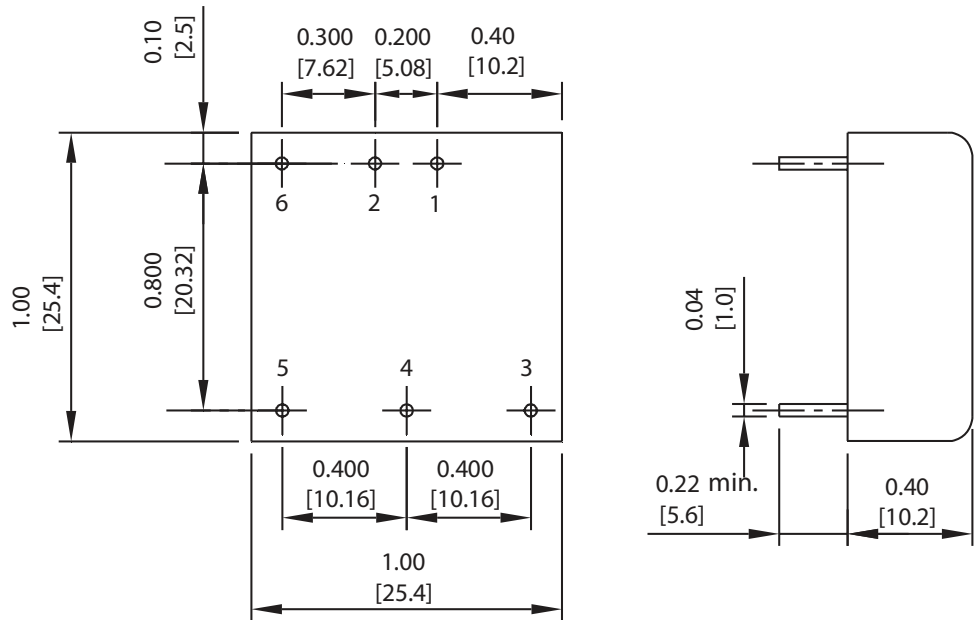

Recommended PCB Layout
Top View

DERATING CURVE

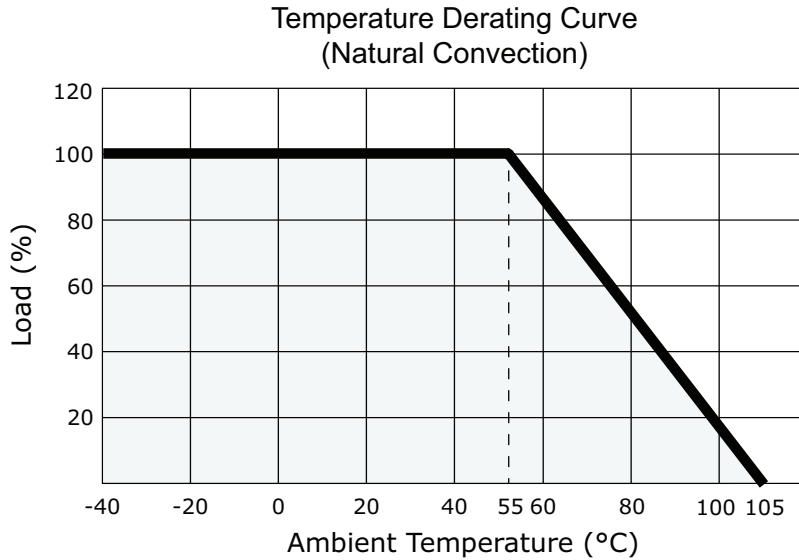

EFFICIENCY CURVES

PDQ30-Q24-S3-D Efficiency Curve
(Efficiency vs. Line Voltage and Load Current)

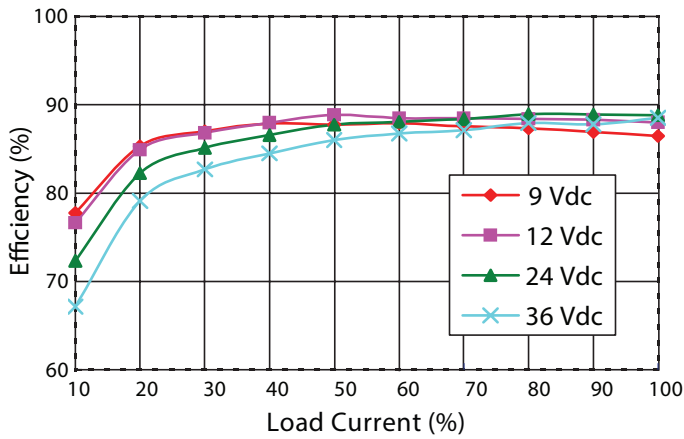

PDQ30-Q24-S5-D Efficiency Curve
(Efficiency vs. Line Voltage and Load Current)

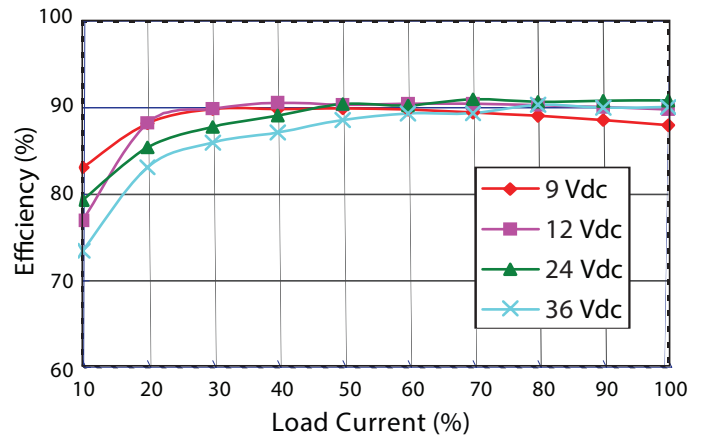

PDQ30-Q24-S12-D Efficiency Curve
(Efficiency vs. Line Voltage and Load Current)

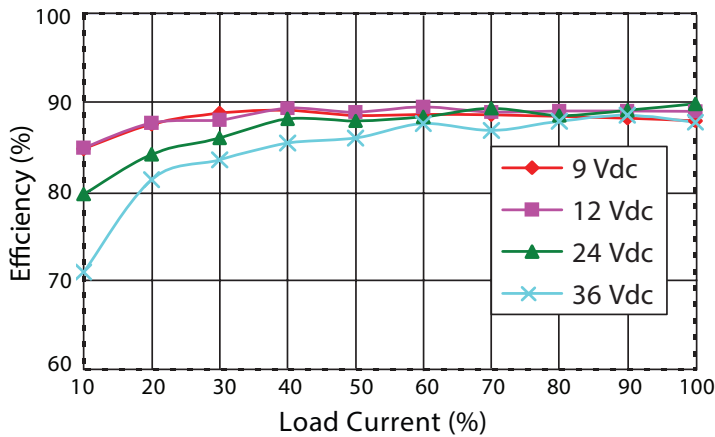

PDQ30-Q24-S15-D Efficiency Curve
(Efficiency vs. Line Voltage and Load Current)

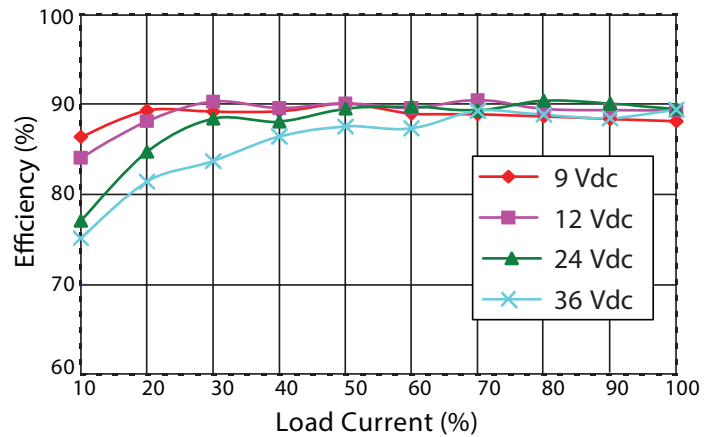

EFFICIENCY CURVES (CONTINUED)

PDQ30-Q24-D12-D Efficiency Curve
(Efficiency vs. Line Voltage and Load Current)

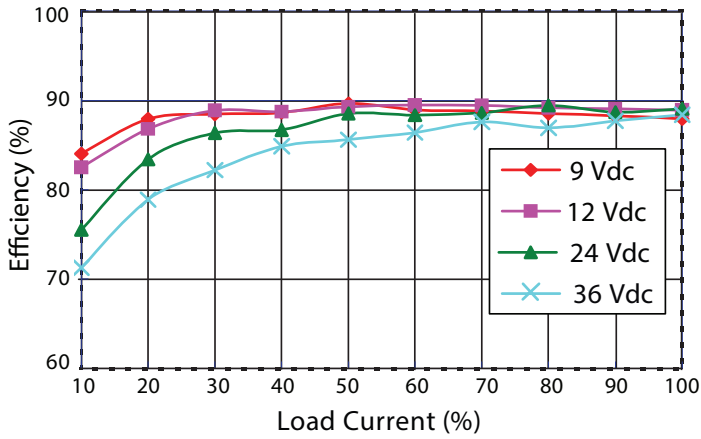

PDQ30-Q24-D15-D Efficiency Curve
(Efficiency vs. Line Voltage and Load Current)

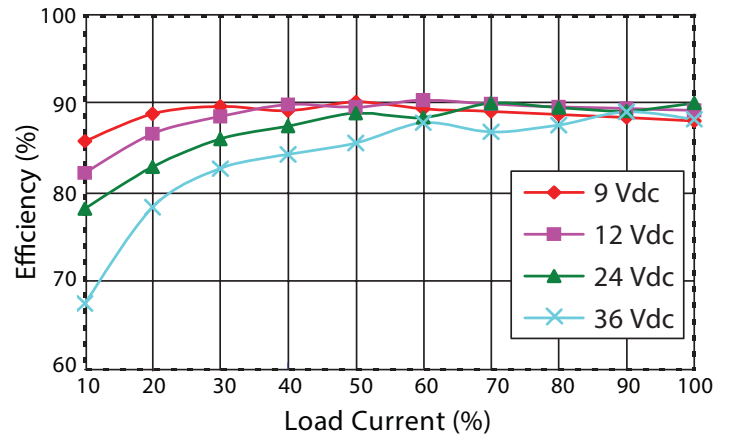

PDQ30-Q48-S3-D Efficiency Curve
(Efficiency vs. Line Voltage and Load Current)

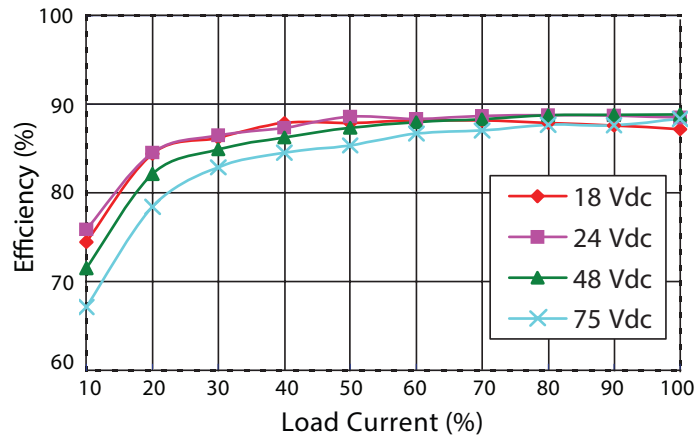

PDQ30-Q48-S5-D Efficiency Curve
(Efficiency vs. Line Voltage and Load Current)

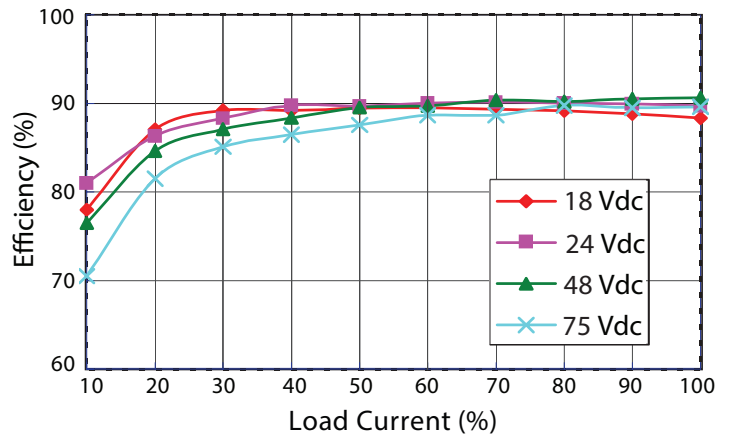

PDQ30-Q48-S12-D Efficiency Curve
(Efficiency vs. Line Voltage and Load Current)

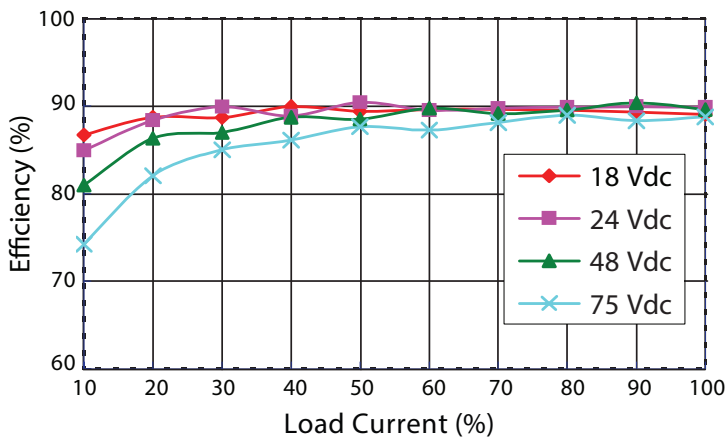

PDQ30-Q48-S15-D Efficiency Curve
(Efficiency vs. Line Voltage and Load Current)

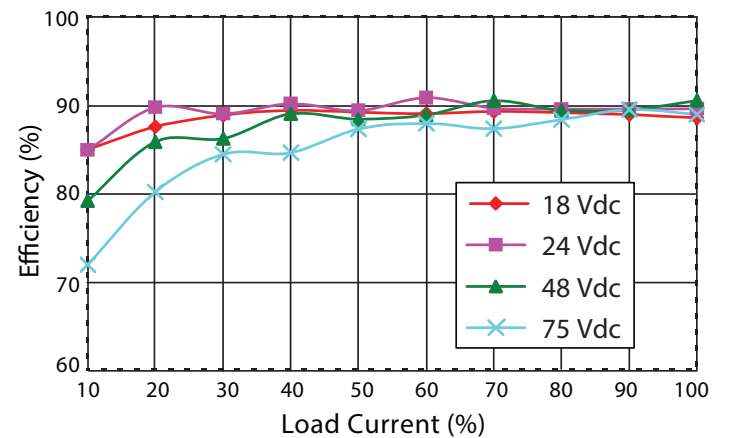

EFFICIENCY CURVES (CONTINUED)

PDQ30-Q48-D12-D Efficiency Curve
(Efficiency vs. Line Voltage and Load Current)

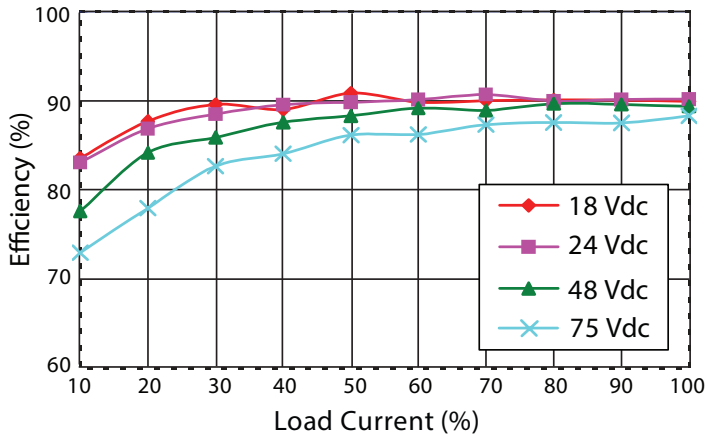

PDQ30-Q48-D15-D Efficiency Curve
(Efficiency vs. Line Voltage and Load Current)

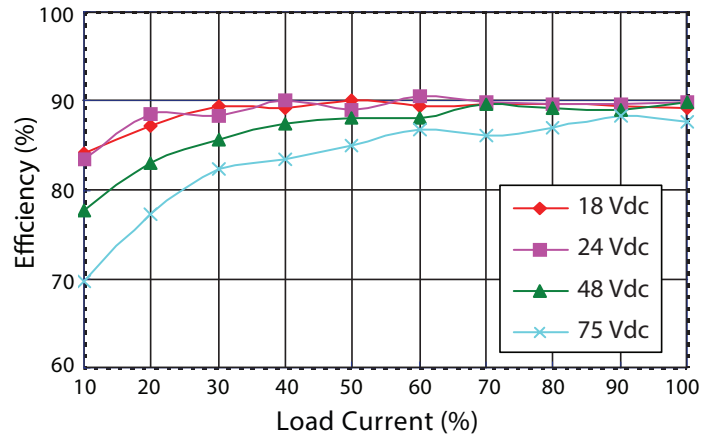

TEST CONFIGURATIONS

Input Ripple Current & Output Noise

Figure 1 Measuring Input Ripple Current

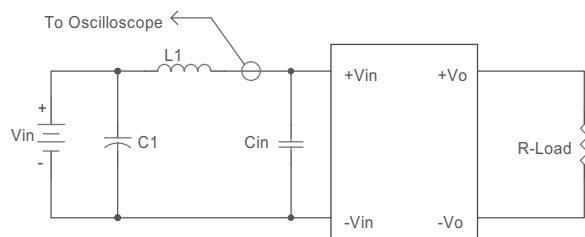

Table 1

| | |
|-----|---|
| L1 | 12 μ H |
| C1 | 220 μ F ESR < 0.1 Ω at 100 kHz |
| Cin | 33 μ F ESR < 0.7 Ω at 100 kHz |

Figure 2 Measuring Output Ripple And Noise

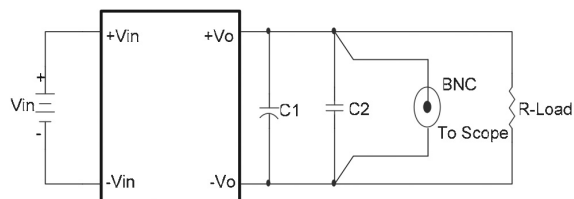

Table 2

| | |
|----|-------------------------------|
| C1 | 10 μ F tantalum capacitor |
| C2 | 1 μ F ceramic capacitor |

EMC RECOMMENDED CIRCUIT

Test Condition

Input Voltage: Nominal

Output Load: Full Load

Figure 3 Conducted Emissions Test Circuit

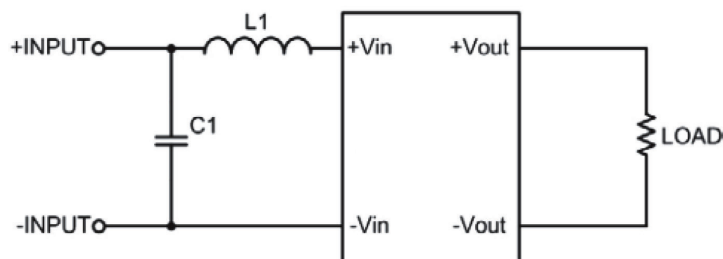

Table 3

| EN55022 Class A Recommended External Circuit Components | | |
|---|---------------------|--------------|
| Input Voltage (Vdc) | C1 | L1 |
| 24 | 100 μ F / 50 V | 0.47 μ H |
| 48 | 4.7 μ F / 100 V | 2.2 μ H |

APPLICATION NOTES

Output Voltage Trimming

The output voltage can be adjusted (single outputs only) by using the trim pin and the use of either an external trim pot or the use of a single fixed resistor (see Figures below). If the trim function is not needed, leave the trim pin open.

Figure 4 Trim Adjustments Using A Trimpot

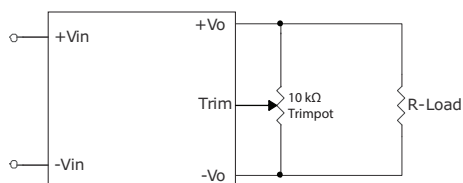

Figure 5 Trim Adjustments To Increase Output Voltage Using A Fixed Resistor

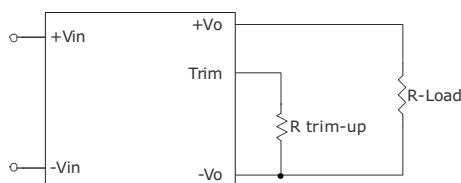
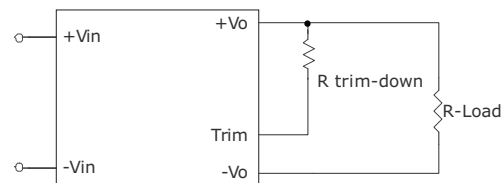

Figure 6 Trim Adjustments To Decrease Output Voltage Using A Fixed Resistor



Formula for Trim Resistor

$$R_{trim-up} = \left(\frac{V_r \times R1 \times (R2 + R3)}{(V_o - V_{o,nom}) \times R2} \right) - R_t \quad (\text{k}\Omega)$$

$$R_{trim-down} = R1 \times \left(\frac{V_r \times R1}{(V_{o,nom} - V_o) \times R2} - 1 \right) - R_t \quad (\text{k}\Omega)$$

Note: $R_{trim-up}$ is the external resistor in $\text{k}\Omega$
 $R_{trim-down}$ is the external resistor in $\text{k}\Omega$
 $V_{o,nom}$ is the nominal output voltage
 V_o is the desired output voltage
 $R1, R2, R3, R_t,$ and V_r are internal (see Table 4)

| Output Voltage (Vdc) | R1 (kΩ) | R2 (kΩ) | R3 (kΩ) | Rt (kΩ) | Vr (V) |
|----------------------|---------|---------|---------|---------|--------|
| 3.3 | 2.74 | 1.8 | 0.27 | 9.1 | 1.24 |
| 5 | 2.32 | 2.32 | 0 | 8.2 | 2.5 |
| 12 | 6.8 | 2.4 | 2.32 | 22 | 2.5 |
| 15 | 8.06 | 2.4 | 3.9 | 27 | 2.5 |

Table 4

REVISION HISTORY

| rev. | description | date |
|------|--------------------------------------|------------|
| 1.0 | initial release | 07/12/2016 |
| 1.01 | added 5 Vdc output efficiency curves | 09/04/2018 |

The revision history provided is for informational purposes only and is believed to be accurate.



Headquarters
20050 SW 112th Ave.
Tualatin, OR 97062
800.275.4899

Fax 503.612.2383
cui.com
techsupport@cui.com

CUI offers a two (2) year limited warranty. Complete warranty information is listed on our website.

CUI reserves the right to make changes to the product at any time without notice. Information provided by CUI is believed to be accurate and reliable. However, no responsibility is assumed by CUI for its use, nor for any infringements of patents or other rights of third parties which may result from its use.

CUI products are not authorized or warranted for use as critical components in equipment that requires an extremely high level of reliability. A critical component is any component of a life support device or system whose failure to perform can be reasonably expected to cause the failure of the life support device or system, or to affect its safety or effectiveness.