

GORDOS

SOLID STATE RELAYS

G SERIES POWER RELAYS

- Back-to-back (dual) SCR output for severe inductive loads.
- Superior False turn-on immunity and positive turn-off at high dv/dt.

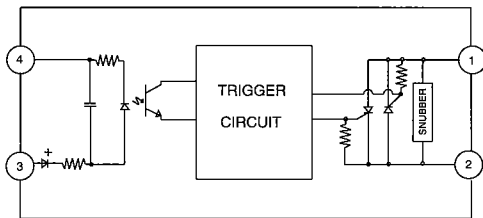
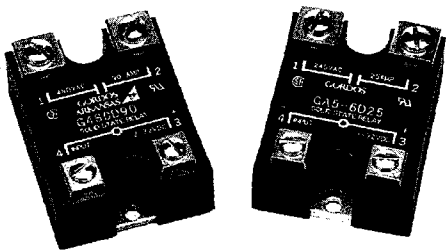

G SERIES AC INPUT
EQUIVALENT CIRCUIT

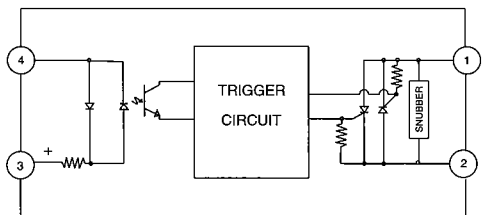

G SERIES DC INPUT
EQUIVALENT CIRCUIT

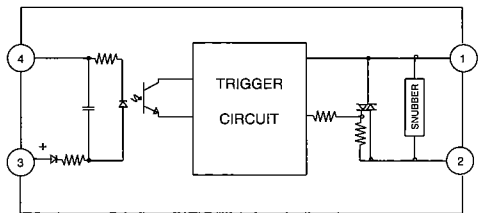

GA5 SERIES AC INPUT
EQUIVALENT CIRCUIT

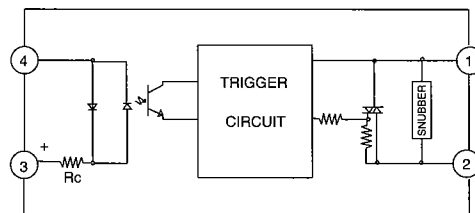

GA5 SERIES DC INPUT
EQUIVALENT CIRCUIT

GA5 SERIES POWER RELAYS

- Economical triac output for general purpose applications

FEATURES

- Current ratings to 90A
- Output voltage rating to 660 VAC with 24 VAC minimum
- AC or DC inputs
- 4KV optical isolation
- Zero AC or random turn-on models
- RC snubber network for inductive loads
- UL recognized (E46203, E79183), CSA certified (38595)
- VDE approval on many models (37421)

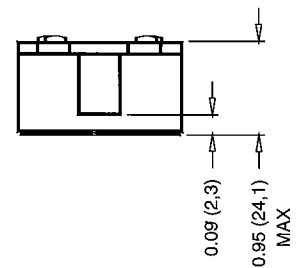
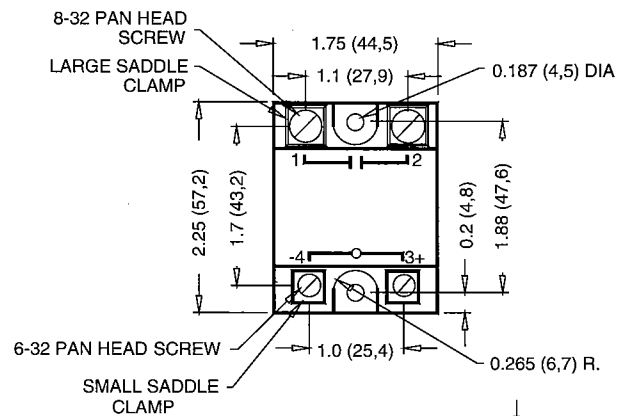

DIMENSIONS: INCHES (MILLIMETERS)
TOLERANCE: ± 0.020 ($\pm 0,50$)

Products and specifications subject to change without notice.
Consult factory for application assistance.

GORDOS

SOLID STATE RELAYS

SOLID STATE RELAYS

G, GA5 SERIES POWER RELAYS

G SERIES (1)

OUTPUT SPECIFICATIONS	MODEL NUMBER					Output Rating	Control Voltage	
	G120A10 G120A25 G120A45	G240A10 G240A25 G240A45	G280A10 G280A25 G280A45 G280A75 G280A90	G480A10 G480A25 G480A50 G480A75 G480A90	G575A10 G575A25 G575A50 G575A75 G575A90			
	G120D10* G120D25* G120D45*	G240D10* G240D25* G240D45*	G280D10*	G480D10	G575D10	10A	3-32 VDC	
			G280D25*	G480D25	G575D25	25A	3-32 VDC	
			G280D45*	G480D50	G575D50	45A	3-32 VDC	
	G120E10 G120E25 G120E45	G240E10 G240E25 G240E45	G280E10	G480E10	G575E10	10A	18-36 VAC	
			G280E25	G480E25	G575E25	25A	18-36 VAC	
			G280E45	G480E50	G575E50	45A	18-36 VAC	
			G280E75	G480E75	G575E75	50A	18-36 VAC	
			G280E90	G480E90	G575E90	75A	18-36 VAC	
						90A	18-36 VAC	
	Maximum Line Voltage (VRMS)	140	250	280	480	660		
	Minimum line voltage (Vrms)	24	24	24	36	48		
	Max. off-state voltage (Vpeak) ²	±250	±500	±600	±1200	±1200		
	Max. off-state leakage (mArms) ³	7.5	15.0	15.0	15.0	20.0		
	Static (off-state) dv/dt (V/μs) ⁴	200	200	200	200	200		

(5)

Specify suffix "R" for random turn-on models.

GA5 SERIES (1)

OUTPUT SPECIFICATIONS	MODEL NUMBER			Output Rating	Control Voltage	
	GA5-2A10 GA5-2A25	GA5-4A10 GA5-4A25	GA5-6A10 GA5-6A25			
	GA5-2D10* GA5-2D25*	GA5-4D10* GA5-4D25*	GA5-6D10* GA5-6D25*	10A	90-280 VAC	
				25A	90-280 VAC	
	GA5-2E10 GA5-2E25	GA5-4E10 GA5-4E25	GA5-6E10 GA5-6E25	10A	18-36 VAC	
				25A	18-36 VAC	
	Maximum Line Voltage (VRMS)	140	250	280		
	Minimum line voltage (Vrms)	24	24	24		
Max. off-state voltage (Vpeak) ⁽²⁾	±250	±400	±600			
Max. off-state leakage (mArms) ⁽³⁾	7.5	15.0	15.0			
Static (off-state) dv/dt (V/μs) ⁽⁴⁾	200	200	200			

Specify suffix "R" for random turn-on models.

*Specify suffix "V" for VDE approved models. (120, 250, 280 "D" input versions only)

Notes:
 (1) Specifications apply to TA from -30 to +80° C unless otherwise noted.
 (2) One minute maximum duration if applied as a DC voltage.
 (3) At TA of 25° C and maximum line voltage.
 (4) Minimum dv/dt per EIA/NARM RS443, method RS397, 25° C.
 (5) G480D and G575D series DC input range is 4.0 to 32.0 VDC.

Products and specifications subject to change without notice.
 Consult factory for application assistance.

GORDOS

SOLID STATE RELAYS

G, GA5 SERIES POWER RELAYS

INPUT SPECIFICATIONS (1)

Parameter	A	D	E
Control Voltage	90-280 VAC	3-32 VDC ⁽¹⁰⁾	18-36 VAC
Drop Out Voltage	10 Vrms	1.0 DC	2.0 Vrms
Maximum Input Current (2)	10 mArms	34 mADC	7 mArms
Nominal Input Resistance (3)	40K Ω	1K Ω	8K Ω
Turn-On Time (4)	20 mS	0.5 Cycle Max ⁽⁴⁾	20 mS
Turn-Off Time	30 mS	0.5 Cycle Max	30 mS

OUTPUT SPECIFICATIONS

Parameter	G Series						GA5 Series		Units
	10	25	45	50	75	90	10	25	
Maximum On-State Current (5)	100	100	100	100	100	100	50	50	Arms
Minimum On-State Current	100	250	500	750	750	1000	100	250	mArms
Maximum 1-Cycle Surge (6)	30	75	135	145	200	280	30	75	Apeak
Maximum 1-Second Surge (7)	1.6	1.6	1.6	1.6	1.6	1.6	1.6	1.6	Vpeak
On-State Voltage Drop (8)	200	260	1040	2345	2345	4165	40	260	A ² sec
I ² t (60 Hz, Half Cycle)	1.8	1.8	0.65	-	0.25	0.25	3.0	2.0	°C/W
R _{jb} (140, 250, 280V Models)	0.8	0.8	-	0.60	0.25	0.25	-	-	°C/W
R _{jb} (480, 660V Models)									

GENERAL SPECIFICATIONS (1)

Parameter	All Devices	Units
Operating Temperature Range	-20 to +80	°C
Storage Temperature Range	-40 to +100	°C
Input to Output Isolation Voltage (9)	4000	Vrms
Input/Output to Ground Isolation Voltage	2500	Vrms
Capacitance Input to Output (Typical)	8	pF
Line Frequency Range	47 to 80	Hz

Notes:

- (1) Specifications apply to Ta -30 to +80° unless otherwise noted.
- (2) At maximum input voltage.
- (3) Does not include IRED impedance (drop).
- (4) At 60 Hz 100 μ s for random turn-on (suffix "R") models.
- (5) With relay properly mounted on an adequate heatsink. See thermal derating charts.
- (6) At Ta of 25° C, non-repetitive.
- (7) At Ta of 25° C.
- (8) At Ta of 25° C and maximum on-state current.
- (9) At TA of 25° C for one second, maximum leakage 1 MA.
- (10) Control voltage range for G480D and G575D series is 4.0 to 32.0 VDC.

Products and specifications subject to change without notice.
Consult factory for application assistance.