

# PTS 525 Series Microminiature Tact Switch for SMT

## Features/Benefits

- 0.8 & 1.5 mm actuator height
- Ruggedized package in a compact size
- High number of cycles

## Typical Applications

- Consumer products
- Instrumentation
- Remote controls



B

Tactile Switches

## Specification

FUNCTION: Momentary action  
CONTACT ARRANGEMENT: 1 make contact = SPST, N.O.

## Electrical

MAXIMUM VOLTAGE: 15 VDC  
MAXIMUM CURRENT DC: 20 mA  
DIELECTRIC STRENGTH: 250 VA C (1mn)  
CONTACT RESISTANCE: ≤ 100 mΩ  
INSULATION RESISTANCE: ≥ 100 MΩ  
BOUNCE TIME: ≤ 10 ms

## Environmental

OPERATING TEMPERATURE: -20°C to 70°C

## Process

SOLDERING: This component is suited to the following methods:  
Infrared Reflow Soldering in accordance with IEC61760-1

## Packaging

Switches in reels of:  
5,000 pieces in 0.8 mm height  
4,000 pieces in 1.5 mm height  
Dimensions of reels according to EIA 481B  
External diameter 330 mm

**NOTE:** Specifications listed above are for switches with standard options.  
For information on specific and custom switches, consult Customer Service Center.

## How To Order

Please see chart below for full part numbers.

Part Number	Height (mm)	Leads Shape	Ground Pin	Force	Travel (mm)	Operating Life
PTS525 SM08 SMTR 2 LFS	0.8	G	No	160 gf ± 50 gf	0.25 ± 0.2	1,000,000
PTS525 SK08 SMTR 2 LFS	0.8	G	No	260 gf ± 50 gf	0.25 ± 0.2	200,000
PTS525 SM15 SMTR 2 LFS	1.5	G	No	160 gf ± 50 gf	0.25 ± 0.2	1,000,000
PTS525 SK15 SMTR 2 LFS	1.5	G	No	260 gf ± 50 gf	0.25 ± 0.2	500,000
PTS525 SMG15 SMTR 2 LFS	1.5	G	Yes	160 gf ± 50 gf	0.25 ± 0.2	1,000,000
PTS525 SKG15 SMTR 2 LFS	1.5	G	Yes	260 gf ± 50 gf	0.25 ± 0.2	500,000
PTS525 SMG15J SMTR 2 LFS	1.5	J	Yes	160 gf ± 50 gf	0.25 ± 0.2	1,000,000
PTS525 SKG15J SMTR 2 LFS	1.5	J	Yes	260 gf ± 50 gf	0.25 ± 0.2	500,000



Dimensions are shown: mm  
Specifications and dimensions subject to change

# PTS 525 Series Microminiature Tact Switch for SMT

**PTS525 SM08 SMTR2 LFS**  
**PTS525 SK08 SMTR2 LFS**

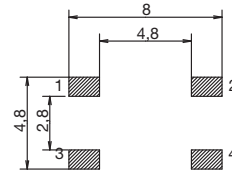
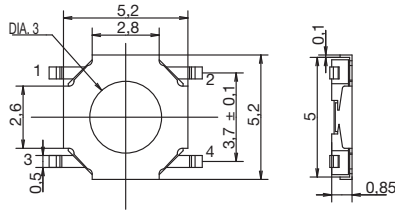
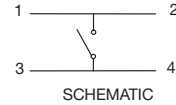
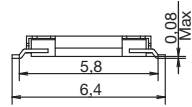

RECOMMENDED PCB LAYOUT

**PTS525 SM15 SMTR2 LFS**  
**PTS525 SK15 SMTR2 LFS**

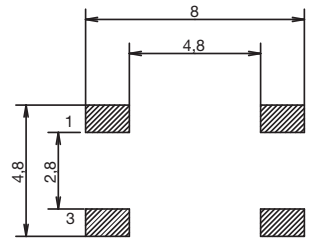
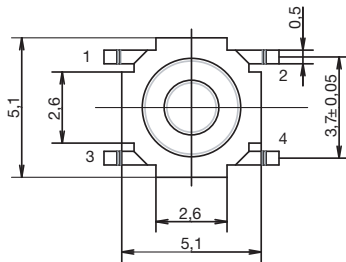
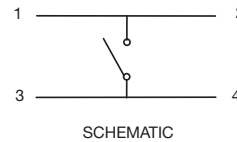
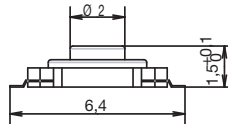

RECOMMENDED PCB LAYOUT

**PTS525 SMG15 SMTR2 LFS**  
**PTS525 SKG15 SMTR2 LFS**

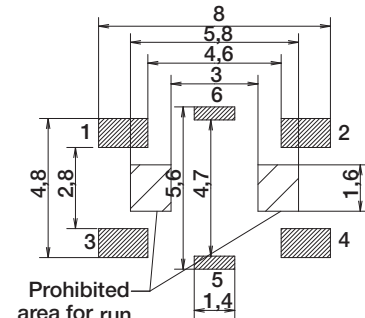
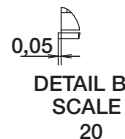
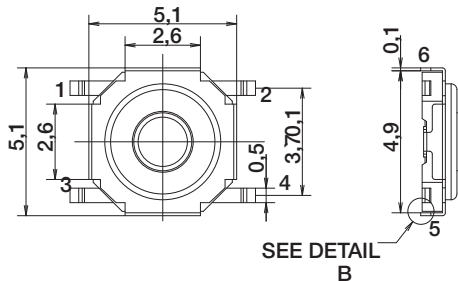
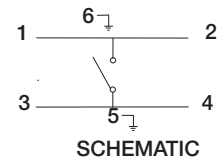
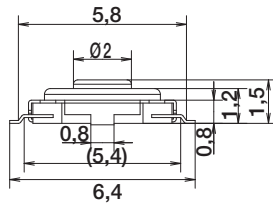

RECOMMENDED PCB LAYOUT

*Dimensions are shown: mm  
Specifications and dimensions subject to change*



B



# PTS 525 Series Microminiature Tact Switch for SMT

## TAPE & REEL

**1.5 mm height**

4,000 pieces per reel



**B**

Tactile Switches

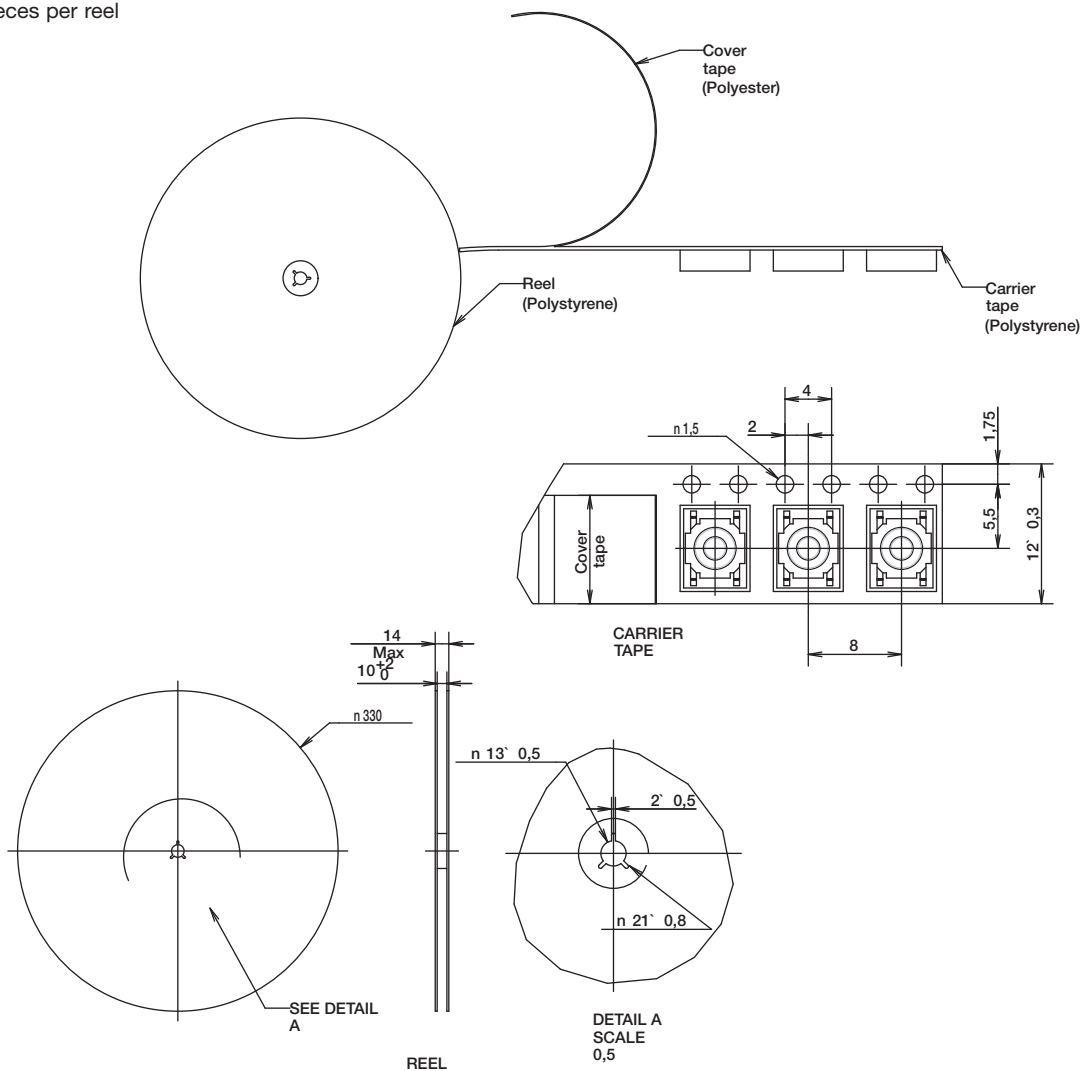

First Angle  
Projection

Dimensions are shown: mm  
Specifications and dimensions subject to change

