



ITT

Electronic Components

# Cannon Trident Connectors



*Engineered for life*

# Interconnect Technologies & Solutions for the Transportation Industry

For over 90 years, ITT has been developing innovative solutions for harsh environment applications. We have a proven track record of demonstrating our expertise and commitment to the transportation industry, offering the broadest portfolio of interconnect products.

## Off-Road / Heavy Vehicle

Our interconnect range include sealed circulars, plastic and metal shell bayonet coupling circulars, miniature metal shell circulars, PC board header connectors and sensor and direct device connectors. ITT is also a systems supplier, providing value-added module and harness assemblies.

**In addition to our Trident series,  
we also offer these connectivity solutions:**



### VEAM VBN

Completely intermateable with VEAM VG95234/CIR reverse bayonet connectors.



### Cannon APD

In-line and bulkhead connectors resistant to harsh environmental conditions (contaminants, vibration and shock).



### Cannon SLC/SLE

Environmentally sealed connector created for printed circuit board, black box, cable-to-cable or bulkhead applications.



### Cannon MLC

The MLC is a modular landed contact system featuring a plug only assembly. The plug housing interfaces directly with the PCB, achieving cost savings of over 30%.

The ITT "Engineered Blocks" symbol and the composite ITT logo are registered trademarks of ITT Industries. © 2005



Cannon’s Trident Connector System is a versatile range of electrical connectors based on a standard contact design. These contacts are fully interchangeable throughout the Trident Connector System. The connector options include low cost rectangulars, rack and panel, industrial grade circulars, harsh environment circulars and shielded circulars

**Description**

*Trident Connector System*

**Connector Selection Guide** ..... 4-5

- **Snap Together - Rectangular**
  - Introduction ..... 6
  - Contact Cavity Arrangements ..... 7
  - Connectors ..... 8-11
- **Snap Together - Slimline**
  - Introduction ..... 12
  - Connectors ..... 13-15
- **Multway Rack & Panel Connectors**
  - Introduction ..... 16
  - Contact Cavity Arrangements ..... 17
  - How to Order ..... 18
  - Style Selector - Hardware Selection Guide ..... 19
- **Ringlock Circular Connectors**
  - Introduction ..... 20
  - Contact Cavity Arrangements ..... 21
  - Connectors ..... 22-25
  - Accessories ..... 26-27
- **Neptune Circular Connectors**
  - Introduction ..... 28
  - Contact Cavity Arrangements ..... 29
  - Connectors ..... 30-33
  - Accessories ..... 34-37
- **TNM Circular Connectors**
  - Introduction ..... 38
  - Contact Cavity Arrangements ..... 39
  - Connectors ..... 40-41
  - Accessories ..... 42-45

**Contact Selection Guide** ..... 46

- Performance Data ..... 47
- Contacts ..... 48-52

**Application Tools** ..... 53-54

**Assembly Instructions** ..... 55-62

**Reader’s Resource**

- IP Rating Chart ..... 64-65
- Glossary of Terms ..... 66-67
- Part Number Index ..... 68-69
- Product Safety Information ..... 70
- Warranty ..... 70

Connector Selection Guide

Snap Together Rectangular

Snap Together Slimline

Multway Rack & Panel

Ringlock Circular

Neptune Circular

TNM Circular

Contacts

Tools

Assembly

Reader’s Resource



# Cannon Trident Connector System

Connector Selection Guide

## Snap Together - Rectangular



### Snap Together - Rectangular

These are low installed cost connectors rated for up to 13 A and 250 Vrms. They are typically used for circuit board and internal wiring applications. Snap Together connectors facilitate easy assembly and removal of equipment such as motors, fans, and transformers.

### Contents

<a href="#">Introduction</a>	6
<a href="#">Contact Cavity Arrangements</a>	7
<a href="#">Free Plug Connectors</a>	8
<a href="#">Panel Mounted Receptacles</a>	9
<a href="#">PCB Receptacles</a>	10

## Snap Together - Slimline



### Snap Together - Slimline

The Slimline Range offers a low profile connector system that is well suited for circuit board applications. The precision machined contacts are ideal for power and sensitive signals.

### Contents

<i>Rectangular Range</i>	
<a href="#">Introduction</a>	12
<a href="#">Plug Connector</a>	13
<a href="#">Pin Header - Straight</a>	14
<a href="#">Pin Header - 90°</a>	15

## Multiway - Rack & Panel



### Multiway

The Multiway range is an extremely reliable and robust series of rack and panel connectors. The design is based on the requirements of MIL-C-28748 and will accept any of the Trident signal or coax contacts. It is available in 6 arrangements ranging from 14 to 75 ways, together with a wide range of accessories and mounting hardware.

### Contents

<a href="#">Introduction</a>	16
<a href="#">Contact Cavity Arrangements</a>	17
<a href="#">How to Order</a>	18
<a href="#">Hardware Selection Guide</a>	19

## Ringlock - Circular



### Ringlock

Ringlock is a range of robust circular connectors for industrial applications. It uses a metal bayonet coupling system for quick and reliable connections and thermoplastic bodies for low installed cost. The connectors are available in several sizes ranging from 4 to 48 circuits for signals up to 13 A or coax. With the addition of a sealed cable clamp, the connectors can be water sealed to meet IP67.

### Contents

<a href="#">Introduction</a>	20
<a href="#">Contact Cavity Arrangements</a>	21
<a href="#">Standard Connectors</a>	22
<a href="#">Reversed Connectors</a>	25
<a href="#">Accessories</a>	26

# Cannon Trident Connector System

## Neptune - Circular



### Neptune

Neptune is a range of circular connectors specifically designed for harsh environment applications. They are water sealed to IP67 and do not require blanking plugs for unused cavities. Contact arrangements include combinations of signal (13 A) and power (30 A) contacts. The mating uses a highly reliable bayonet coupling system with either high strength metal or corrosion resistant plastic coupling rings.

### Contents

<a href="#">Introduction</a>	28
<a href="#">Contact Cavity Arrangements</a>	29
<a href="#">Standard Connectors</a>	30
<a href="#">Reversed Connectors</a>	32
<a href="#">Accessories</a>	34

## TNM - Circular



### TNM

TNM is a new series of metal shell connectors that, when used with the new shielded end bell, provides RF shielding from cable to equipment or cable to cable. Connectors and end bells are moisture sealed to IP67. They are ideal for applications that require the additional strength of metal shells.

### Contents

<a href="#">Introduction</a>	38
<a href="#">Contact Cavity Arrangements</a>	39
<a href="#">Standard Connectors</a>	40
<a href="#">Reversed Connectors</a>	41
<a href="#">Jam Nut Receptacles</a>	42
<a href="#">Special Products</a>	42
<a href="#">Accessories</a>	43

## Trident Contacts



### Trident Contacts

The Trident series of contacts are based on a standard cavity design. This enables the stamped, machined, PCB, solder, and coax contacts to fit into any of the connectors in the Trident connector system. In addition, the mating interface is standardized so that the various signal contacts (ranging from 14-26 AWG) will all mate together. The retention system of the contacts enables quick and cost effective assembly without special insertion tools.

### Contents

<a href="#">Introduction</a>	46
<a href="#">Contact Selection Guide</a>	47
<a href="#">Formed (Stamped) Contacts</a>	48
<a href="#">Machined Contacts</a>	49
<a href="#">Solder Contacts</a>	50
<a href="#">30 A Power Contacts</a>	50
<a href="#">Coaxial Contacts</a>	51
<a href="#">Discriminating (Keying) Pins</a>	52

## Application Tools and Assembly Instructions



### Tools and Assembly

Cannon offers a wide range of wire preparation and crimping tools ranging from hand tools to fully automated systems. There is also a range of assembly aids and extraction tools.

### Contents

<a href="#">Hand Crimping Tools</a>	53
<a href="#">Automatic Tools</a>	54
<a href="#">Insertion/Extraction Tools</a>	54
<a href="#">Contact Assembly Instructions</a>	55
<a href="#">Connector Assembly Instructions</a>	56



# Cannon Trident Connector System

Snap Together-Rectangular

Snap Together  
Rectangular

These are low installed cost connectors rated for up to 13 A and 250 V ac. They are typically used for circuit board and internal wiring applications. Snap Together connectors facilitate easy assembly and removal of equipment such as motors, fans, transformers, etc.

## Applications:

- Circuit board connections.
- Internal connections.

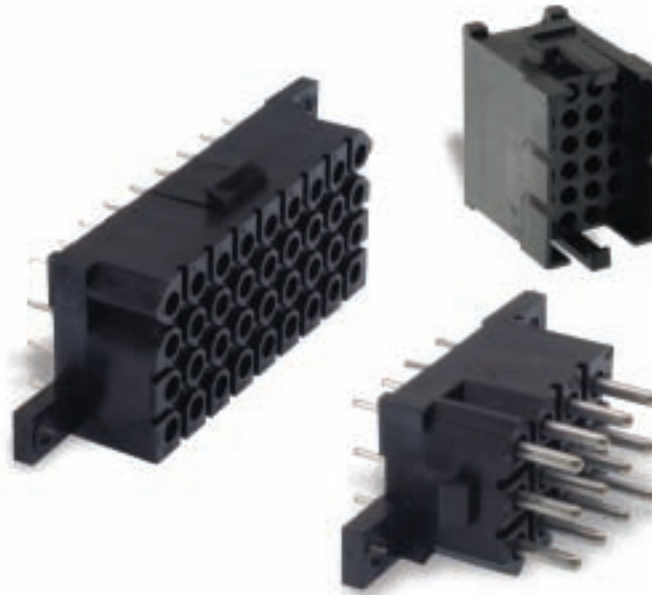

## Product Features

- Easy cost effective installation.
- Integrally molded latches and connector polarization.
- Recognized under the component program of UL Inc. and CSA.
- Inter-connector discrimination facilities available.
- Accepts formed (stamped) or machined contacts, see page 47.

## Performance Specifications

<b>Operating Voltage</b>	250 V ac rms
<b>Contact Current Rating</b>	Up to 13 A (For derating curve, see page 44)
<b>Temperature Range</b>	-55°C to 105°C (-67°F to 221°F) for Free Plug and Panel Receptacles -40°C to 105°C (-40°F to 221°F) for PCB Mounted Receptacles
<b>Insulation Resistance</b>	5000 MΩ at 500 V dc
<b>Connector Latching Force</b>	150 N min. with latches engaged
<b>Test Voltage</b>	2000 V ac for 60 secs
<b>Panel Retention Force</b>	500 N min.

## Materials and Finishes

Description	Material	Finish
Insulator	Black Nylon, UL 94V-0	None



Dimensions shown in mm (inch)  
Specifications and dimensions subject to change

[www.ittcannon.com](http://www.ittcannon.com)

## Contact Cavity Arrangements—Mating Face View

2 Way

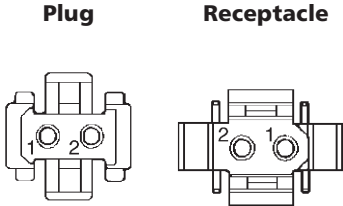

3 Way

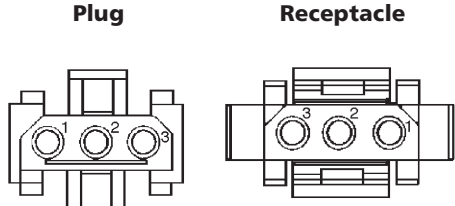

4 Way

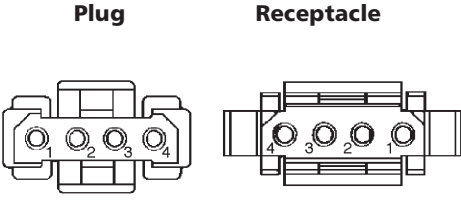

6 Way

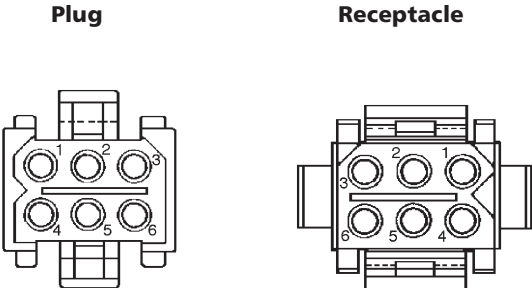

12 Way

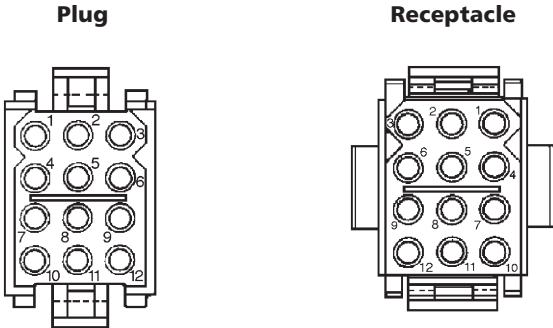

24 Way

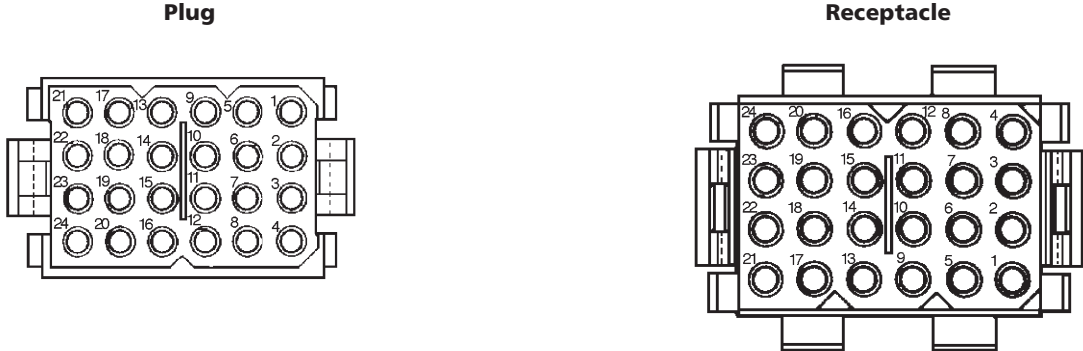

36 Way

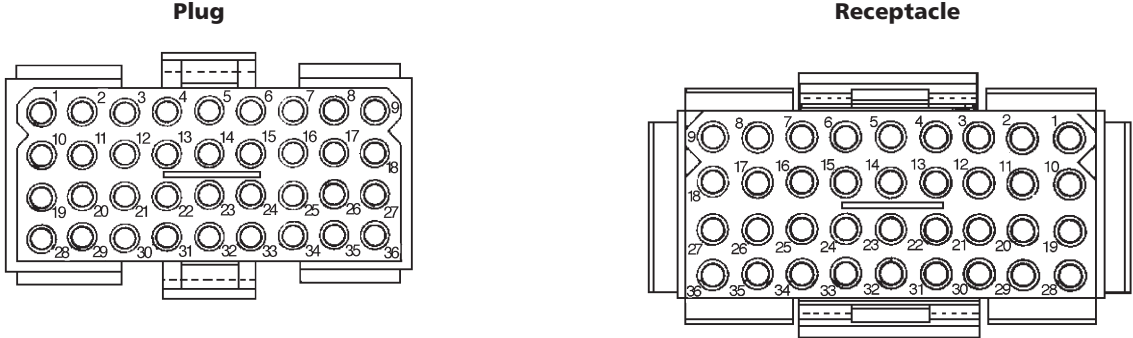

Dimensions shown in mm (inch)  
Specifications and dimensions subject to change  
[www.ittcannon.com](http://www.ittcannon.com)



Snap Together  
Rectangular

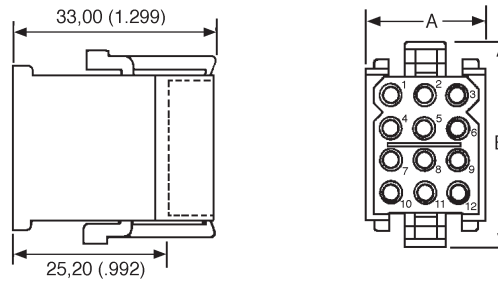

## Free Plug

- Accepts Pin or Socket contacts.
- Contacts to be ordered separately, see page 47.
- Mates with panel mounted receptacles, see page 9.
- Mates with PCB mounted receptacles, see pages 10-12.

Number of Contacts	Part Number (Pack of 100)	Nomenclature	Dimensions (max.)	
			A	B
2	192990-0350	TST 02 PA 00	15,50 (.610)	17,00 (.669)
3	192923-5920	TST 03 PA 00	19,00 (.748)	17,00 (.669)
4	192990-0370	TST 04 PA 00	24,00 (.944)	17,00 (.669)
6	192923-5930	TST 06 PA 00	19,00 (.748)	22,00 (.866)
12	192923-5940	TST 12 PA 00	19,00 (.748)	32,00 (1.259)
24	192923-5950	TST 24 PA 00	24,00 (.944)	42,00 (1.653)
36	192923-5960	TST 36 PA 00	49,50 (1.948)	32,00 (1.259)



## Plug Strain Relief Hood

- Provides strain relief and wire protection.
- Secure with a tie-wrap (customer supplies tie-wrap).
- Connector Discriminating (Keying) Pins available, see page 52.

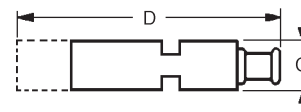
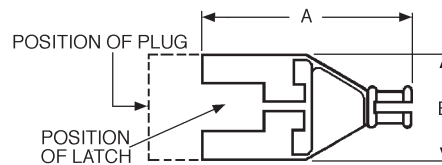

Number of Contacts	Part Number (Pack of 100)	Nomenclature	Wire Bundle Dia.	Dimensions (max.)			
				A	B	C	D
2	192990-0460	TST 02 AH 00	2,30-8,30 (.090-.326)	46,20 (1.818)	16,10 (.633)	11,00 (.433)	56,50 (2.224)
3	192990-0470	TST 03 AH 00	2,30-8,30 (.090-.326)	46,20 (1.818)	18,60 (.732)	11,00 (.433)	56,50 (2.224)
4	192990-0480	TST 04 AH 00	3,00-10,00 (.118-.393)	46,20 (1.818)	23,70 (.933)	11,00 (.433)	56,50 (2.224)
6	192923-5970	TST 06 AH 00	2,30-8,30 (.090-.326)	46,20 (1.818)	19,00 (.748)	16,40 (.645)	56,50 (2.224)
12	192923-5980	TST 12 AH 00	3,00-10,00 (.118-.393)	45,50 (1.791)	19,00 (.748)	26,40 (1.039)	55,80 (2.196)
24	192923-5990	TST 24 AH 00	4,60-12,70 (.181-.500)	51,00 (2.007)	24,10 (.948)	36,80 (1.448)	60,30 (2.374)
36	192923-6000	TST 36 AH 00	7,00-15,90 (.275-.625)	57,50 (2.263)	49,50 (1.948)	26,40 (1.039)	68,00 (2.677)



Dimensions shown in mm (inch)  
Specifications and dimensions subject to change

www.ittcannon.com



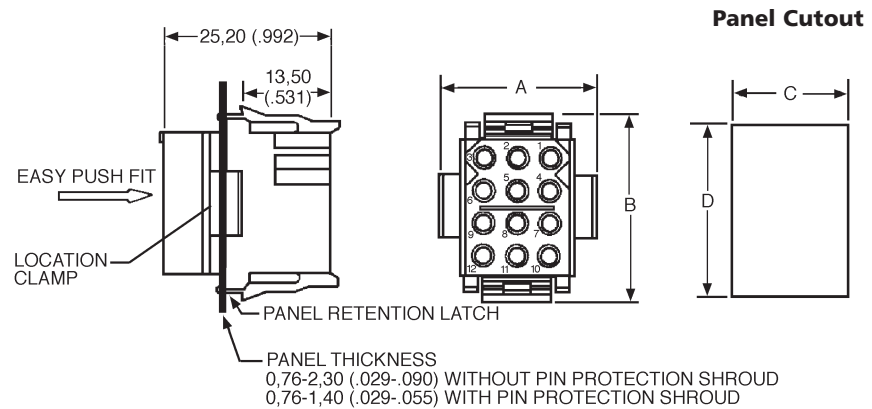

Snap Together Rectangular

## Receptacle — Panel Mounted

- Accepts Pin or Socket contacts.
- Contacts to be ordered separately, see page 47.
- Mates with Free Plugs, see page 8.

Number of Contacts	Part Number (Pack of 100)	Nomenclature	Dimensions			
			A	B	C ±0,13 (.005)	D ±0,13 (.005)
2	192990-0360	TST 02 RA 00	19,00 (.748)	14,00 (.551)	11,50 (.452)	11,60 (.456)
3	192923-6010	TST 03 RA 00	24,00 (.944)	14,00 (.551)	16,50 (.649)	11,60 (.456)
4	192990-0380	TST 04 RA 00	29,00 (1.141)	13,50 (.531)	21,70 (.854)	11,60 (.456)
6	192923-6020	TST 06 RA 00	24,00 (.944)	19,00 (.748)	16,50 (.649)	16,70 (.657)
12	192923-6030	TST 12 RA 00	24,00 (.944)	29,00 (1.141)	16,70 (.657)	26,70 (1.051)
24	192923-6040	TST 24 RA 00	29,00 (1.141)	39,00 (1.535)	21,80 (.858)	36,90 (1.452)
36	192923-6050	TST 36 RA 00	54,20 (2.133)	29,00 (1.141)	46,70 (1.838)	26,40 (1.039)

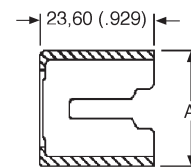
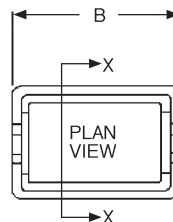

## Protection Shrouds for Receptacles with Pin Contacts

- Provides protection for panel mounted receptacles with pin contacts.
- Shrouds can be fitted onto panels up to 1,40 (.055) thick.
- Connector Discriminating (Keying) Pins available, see page 52.

Number of Contacts	Part Number (Pack of 100)	Nomenclature	Dimensions	
			A	B
3	192990-0400	TST 03 AS 00	23,50 (.925)	19,05 (.748)
4	192991-0668	TST 04 AS 00	28,60 (1.126)	19,05 (.748)
6	192990-0420	TST 06 AS 00	23,50 (.925)	24,13 (.948)
12	192990-0430	TST 12 AS 00	23,60 (.929)	34,20 (1.346)
24	192990-0440	TST 24 AS 00	29,70 (1.169)	44,40 (1.748)
36	192990-0450	TST 36 AS 00	54,40 (2.141)	34,00 (1.338)

Dimensions shown in mm (inch)  
 Specifications and dimensions subject to change

# Cannon Trident Connector System

Snap Together-Rectangular

Snap Together  
Rectangular

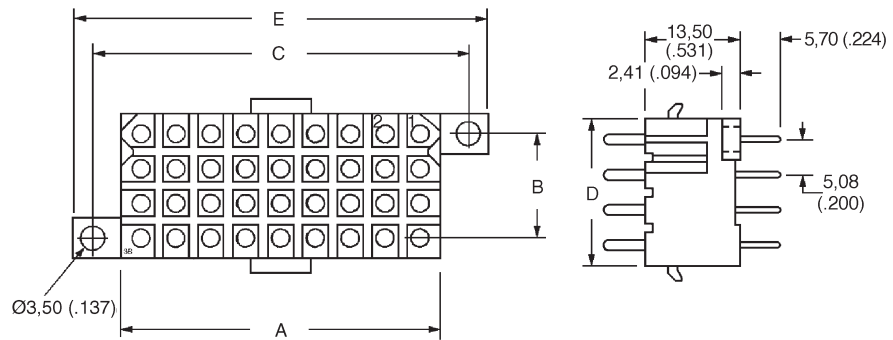
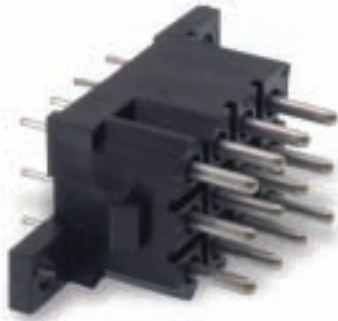

## PCB Mounted Connectors — Pin Contacts

- Mates with Free Plug, see page 8.
- Integrally molded flanges.
- Contacts are on a 5,08 (.200) grid, symmetrical on center lines.
- Recommended PCB hole Ø1,15 (.045).
- Connector Discriminating Caps available, see page 52.

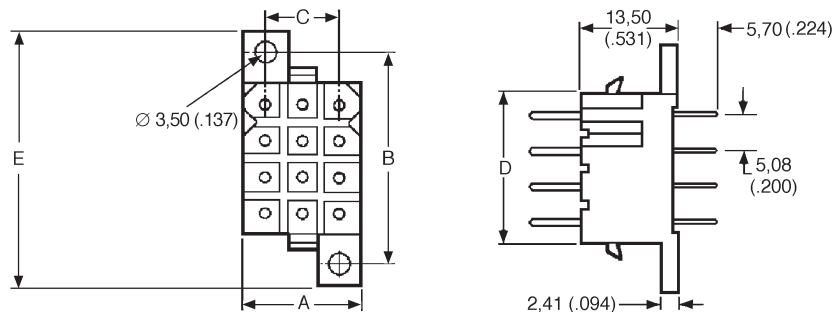

Number of Contacts	Plating	Formed (Stamped)		Machined		Figure	Dimensions				
		Part Number (Pack of 100)	Nomenclature	Part Number (Pack of 100)	Nomenclature		A	B ±0,08 (.003)	C ±0,08 (.003)	D	E
2	Gold*	192900-0411	TST 02 RB 05Y	192991-0270	TST 02 RB 01Z	1	11,13 (.438)	N/A	19,13 (.753)	6,00 (.236)	25,00 (.984)
2	Tin	192990-3230	TST 02 RB 05T	192991-0271	TST 02 RB 01T	1	11,13 (.438)	N/A	19,13 (.753)	6,00 (.236)	25,00 (.984)
3	Gold*	192900-0412	TST 03 RB 05Y	192991-0278	TST 03 RB 01Z	2	16,21 (.638)	14,05 (.553)	10,24 (.403)	6,00 (.236)	20,10 (.791)
3	Tin	192990-3240	TST 03 RB 05T	192991-0279	TST 03 RB 01T	2	16,21 (.638)	14,05 (.553)	10,24 (.403)	6,00 (.236)	20,10 (.791)
4	Gold*	192900-0413	TST 04 RB 05Y	192991-0286	TST 04 RB 01Z	2	21,30 (.838)	14,05 (.553)	15,32 (.603)	6,00 (.236)	20,10 (.791)
4	Tin	192990-3250	TST 04 RB 05T	192991-0287	TST 04 RB 01T	2	21,30 (.838)	14,05 (.553)	15,32 (.603)	6,00 (.236)	20,10 (.791)
6	Gold*	192900-0414	TST 06 RB 05Y	192991-0294	TST 06 RB 01Z	2	16,20 (.637)	19,12 (.752)	10,23 (.402)	11,00 (.433)	26,00 (1.023)
6	Tin	192990-3260	TST 06 RB 05T	192991-0295	TST 06 RB 01T	2	16,20 (.637)	19,12 (.752)	10,23 (.402)	11,00 (.433)	26,00 (1.023)
12	Gold*	192900-0415	TST 12 RB 05Y	192991-0302	TST 12 RB 01Z	2	16,20 (.637)	29,30 (1.153)	10,26 (.404)	21,20 (.834)	35,20 (1.385)
12	Tin	192990-3270	TST 12 RB 05T	192991-0303	TST 12 RB 01T	2	16,20 (.637)	29,30 (1.153)	10,26 (.404)	21,20 (.834)	35,20 (1.385)
24	Gold*	192900-0416	TST 24 RB 05Y	192991-0310	TST 24 RB 01Z	2	21,30 (.838)	39,37 (1.550)	15,32 (.603)	31,30 (1.232)	45,60 (1.795)
24	Tin	192990-3280	TST 24 RB 05T	192991-0311	TST 24 RB 01T	2	21,30 (.838)	39,37 (1.550)	15,32 (.603)	31,30 (1.232)	45,60 (1.795)
36	Gold*	192900-0417	TST 36 RB 05Y	192991-0402	TST 36 RB 01Z	1	46,60 (1.834)	15,24 (.600)	54,64 (2.151)	21,20 (.834)	60,50 (2.382)
36	Tin	192990-3290	TST 36 RB 05T	192991-0403	TST 36 RB 01T	1	46,60 (1.834)	15,24 (.600)	54,64 (2.151)	21,20 (.834)	60,50 (2.382)

\* Gold plating for Formed (Stamped) Contacts is 0,75 µm (30 µ in.) min gold. Gold plating for Machined Contacts is gold flash.



Dimensions shown in mm (inch)  
Specifications and dimensions subject to change

www.ittcannon.com

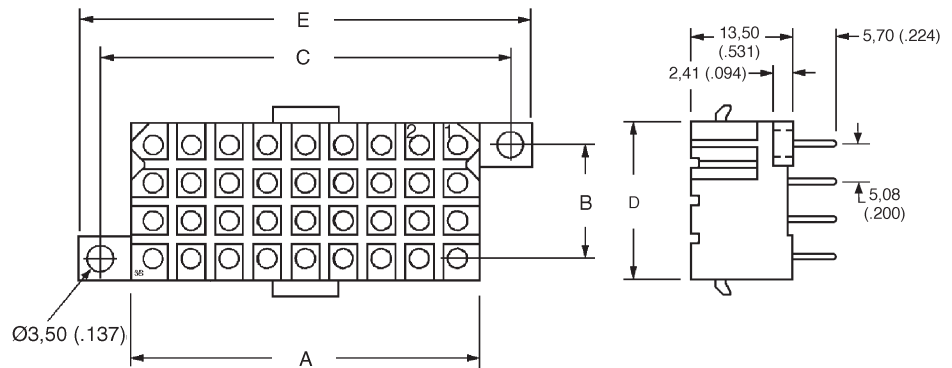

Snap Together Rectangular

## PCB Mounted Connectors — Socket Contacts

- Mates with Free Plug, see page 8.
- Integrally molded flanges.
- Contacts are on a 5,08 (.200) grid, symmetrical on center lines.
- Recommended PCB hole  $\varnothing$  1,15 (.045).
- Connector Discriminating Pins available, see page 52.

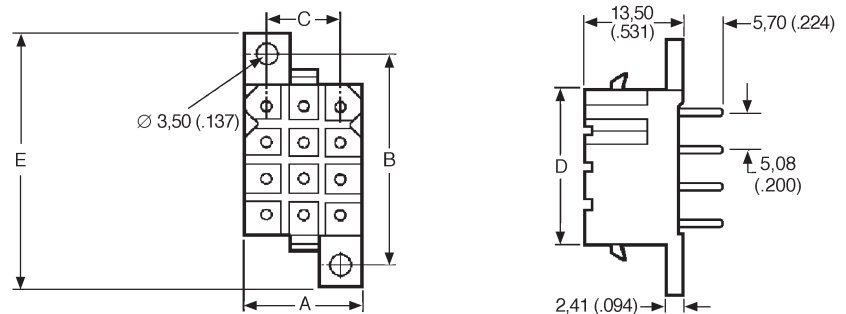

Number of Contacts	Plating	Formed (Stamped)		Machined		Figure	Dimensions						
		Part Number (Pack of 100)	Nomenclature	Part Number (Pack of 100)	Nomenclature		A	$\pm 0,08$ (.003)	$\pm 0,08$ (.003)	B	C	D	E
2	Gold*	192900-0418	TST 02 RB 06Y	192991-0213	TST 02 RB 02Z	1	11,13 (.438)	N/A	19,13 (.753)	6,00 (.236)	25,00 (.984)		
2	Tin	192990-3300	TST 02 RB 06T	192991-0214	TST 02 RB 02T	1	11,13 (.438)	N/A	19,13 (.753)	6,00 (.236)	25,00 (.984)		
3	Gold*	192900-0419	TST 03 RB 06Y	192991-0221	TST 03 RB 02Z	2	16,21 (.638)	14,05 (.553)	10,24 (.403)	6,00 (.236)	20,10 (.791)		
3	Tin	192990-3310	TST 03 RB 06T	192991-0222	TST 03 RB 02T	2	16,21 (.638)	14,05 (.553)	10,24 (.403)	6,00 (.236)	20,10 (.791)		
4	Gold*	192900-0420	TST 04 RB 06Y	192991-0229	TST 04 RB 02Z	2	21,30 (.838)	14,05 (.553)	15,32 (.603)	6,00 (.236)	20,10 (.791)		
4	Tin	192990-3320	TST 04 RB 06T	192991-0230	TST 04 RB 02T	2	21,30 (.838)	14,05 (.553)	15,32 (.603)	6,00 (.236)	20,10 (.791)		
6	Gold*	192900-0421	TST 06 RB 06Y	192991-0237	TST 06 RB 02Z	2	16,20 (.637)	19,12 (.752)	10,23 (.402)	11,00 (.433)	26,00 (1.023)		
6	Tin	192990-3330	TST 06 RB 06T	192991-0238	TST 06 RB 02T	2	16,20 (.637)	19,12 (.752)	10,23 (.402)	11,00 (.433)	26,00 (1.023)		
12	Gold*	192900-0422	TST 12 RB 06Y	192991-0245	TST 12 RB 02Z	2	16,20 (.637)	29,30 (1.153)	10,26 (.404)	21,20 (.834)	35,20 (1.385)		
12	Tin	192990-3340	TST 12 RB 06T	192991-0246	TST 12 RB 02T	2	16,20 (.637)	29,30 (1.153)	10,26 (.404)	21,20 (.834)	35,20 (1.385)		
24	Gold*	192900-0423	TST 24 RB 06Y	192991-0253	TST 24 RB 02Z	2	21,30 (.838)	39,37 (1.550)	15,32 (.603)	31,30 (1.232)	45,60 (1.795)		
24	Tin	192990-3350	TST 24 RB 06T	192991-0254	TST 24 RB 02T	2	21,30 (.838)	39,37 (1.550)	15,32 (.603)	31,30 (1.232)	45,60 (1.795)		
36	Gold*	192900-0424	TST 36 RB 06Y	192991-0261	TST 36 RB 02Z	1	46,60 (1.834)	15,24 (.600)	54,64 (2.151)	21,20 (.834)	60,50 (2.382)		
36	Tin	192990-3360	TST 36 RB 06T	192991-0262	TST 36 RB 02T	1	46,60 (1.834)	15,24 (.600)	54,64 (2.151)	21,20 (.834)	60,50 (2.382)		

\* Gold plating for Formed (Stamped) Contacts is 0,75  $\mu$ m (30  $\mu$  in.) min gold. Gold plating for Machined Contacts is gold flash.

The Slimline Range offers a low profile connector system that is well suited for circuit board applications. The precision machined contacts are ideal for power and sensitive signals.

## Applications:

- Communications equipment.
- Test equipment.
- Heavy duty equipment.

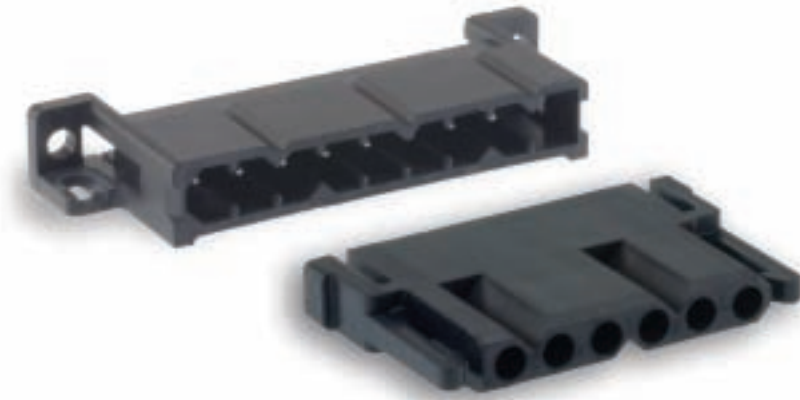

Snap Together  
Slimline

## Product Features

- Less than 10,00 (.393) width on PC board.
- Pin headers pre-loaded with straight or 90° machined solder tail pins.
- Mating plug accepts all Trident signal crimp socket contacts, see page 00.
- Plugs have integrally molded quick connect/disconnect latches.
- Five single row contact arrangements available.
- Recognized under the component program of UL Inc. and CSA.
- Gold plated version available with earth pin capability.
- 10 A per circuit.

## Performance Specifications

<b>Operating Voltage</b>	250 V ac rms
<b>Contact Current Rating</b>	Up to 10 A (For derating curve, see page 44)
<b>Temperature Range</b>	-40°C to 105°C (-40°F to 221°F)
<b>Insulation Resistance</b>	5000 MΩ at 500 V dc

## Materials and Finishes

Description	Material	Finish
Insulator	Black Nylon, UL 94V-0	None



Dimensions shown in mm (inch)  
Specifications and dimensions subject to change

[www.ittcannon.com](http://www.ittcannon.com)

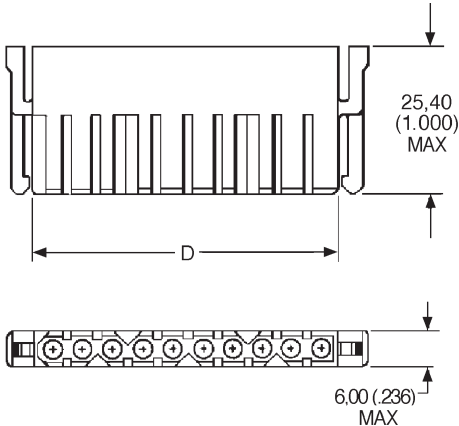

Snap Together Slimline

### Plug Connector

- Socket contacts must be ordered separately for the plug connectors, see page 47.

### Part Numbers — Plug Connector

Number of Contacts	Part Number (Pack of 100)	Nomenclature	D max.
3	192990-0960	TST 03 PF 00	16,10 (.633)
4	192990-0970	TST 04 PF 00	21,20 (.834)
6	192990-0980	TST 06 PF 00	31,40 (1.236)
9	192990-0990	TST 09 PF 00	46,60 (1.834)
10	192990-1000	TST 10 PF 00	51,60 (2.031)



Snap Together Slimline

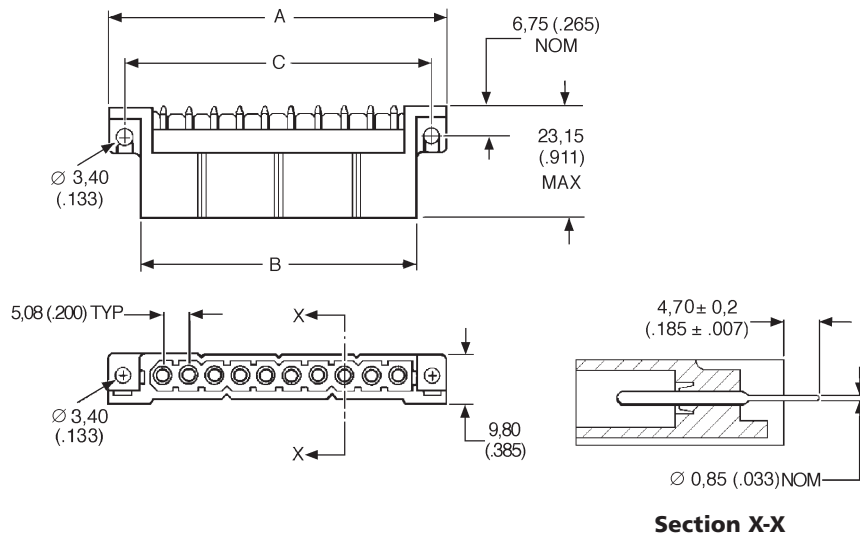

## Pin Header — Straight

- For gold plated versions extended earth pins are available in any one or two positions. Contact your local Cannon Sales Office for further details.

## Part Numbers — Straight Pin Header

Gold Plated Version 0,4 μm (16 μin.) min. Gold			Tin Plated Version		Dimensions (max.)		
Number of Contacts	Part Number (Pack of 100)	Nomenclature	Part Number (Pack of 100)	Nomenclature	A	B	C
3	192991-0337	TP 03 R4E 00Y	192991-0316	TST 03 RD 01T	31,40 (1.236)	19,40 (.763)	25,50 (1.003)
4	192991-0347	TP 04 R4E 00Y	192991-0318	TST 04 RD 01T	36,50 (1.437)	14,50 (.964)	30,60 (1.204)
6	192991-0342	TP 06 R4E 00Y	192991-0320	TST 06 RD 01T	46,70 (1.838)	34,70 (1.366)	40,70 (1.602)
9	192991-0536	TP 09 R4E 00Y	192991-0322	TST 09 RD 01T	61,90 (2.437)	49,90 (1.964)	56,00 (2.204)
10	192991-0354	TP 10 R4E 00Y	192991-0324	TST 10 RD 01T	67,00 (2.637)	55,00 (2.165)	61,10 (2.405)

## PCB Layout

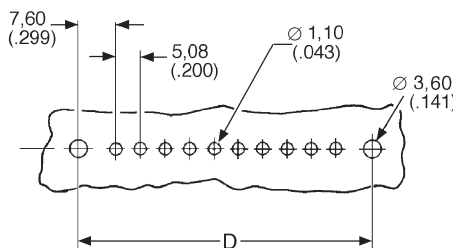

Number of Contacts	D max.
3	25,50 (1.003)
4	30,60 (1.204)
6	40,70 (1.602)
9	56,00 (2.204)
10	61,10 (2.405)



Dimensions shown in mm (inch)  
Specifications and dimensions subject to change

www.ittcannon.com



## Pin Header — 90°

- For gold plated versions extended earth pins are available in any one or two positions. Contact your local Cannon Sales Office for further details.

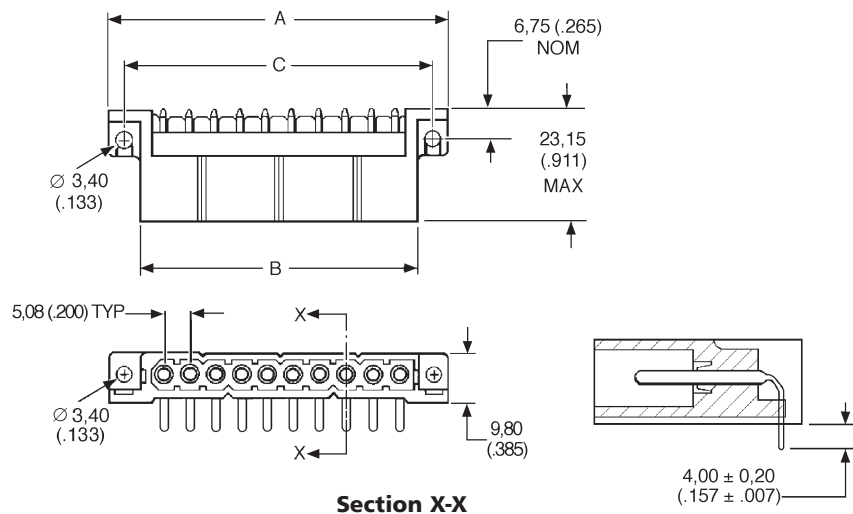

Snap Together Slimline

## Part Numbers — 90° Pin Header

Number of Contacts	Gold Plated Version 0,4µm (16µin.) min. Gold		Tin Plated Version		Dimensions (max.)		
	Part Number (Pack of 100)	Nomenclature	Part Number (Pack of 100)	Nomenclature	A	B	C
3	192991-0532	TP 03 R3E 00Y	192991-0317	TST 03 RE 01T	31,40 (1.236)	19,40 (.763)	25,50 (1.003)
4	192991-0533	TP 04 R3E 00Y	192991-0319	TST 04 RE 01T	36,50 (1.437)	14,50 (.964)	30,60 (1.204)
6	192991-0534	TP 06 R3E 00Y	192991-0321	TST 06 RE 01T	46,70 (1.838)	34,70 (1.366)	40,70 (1.602)
9	192991-0535	TP 09 R3E 00Y	192991-0323	TST 09 RE 01T	61,90 (2.437)	49,90 (1.964)	56,00 (2.204)
10	192991-0538	TP 10 R3E 00Y	192991-0325	TST 10 RE 01T	67,00 (2.637)	55,00 (2.165)	61,10 (2.405)

## PCB Layout

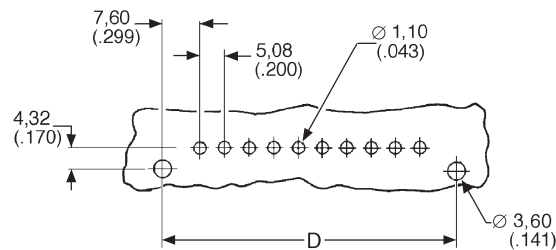

Number of Contacts	D max.
3	25,50 (1.003)
4	30,60 (1.204)
6	40,70 (1.602)
9	56,00 (2.204)
10	61,10 (2.405)

Dimensions shown in mm (inch)  
Specifications and dimensions subject to change

# Cannon Trident Connector System

Multi Rack & Panel Connectors

The Multiway Range has six plan forms available and offers an extremely reliable, robust and versatile connector system, in which any of the Trident signal or coaxial contacts can be used.

## Applications:

- Inflight entertainment systems.
- Rail equipment.
- Test equipment.



Multiway  
Rack & Panel

## Product Features

- Fully tested to MIL-STD-202 and now IEC 512.
- Wide range of accessories, jacking and mounting hardware.
- Polarizing between connectors available, by contact position, use of shrouds or additional guide pin and socket sets.
- Recognized under the component program of UL Inc. and CSA.
- Complete range of contact options available, see page 47.

## Performance Specifications

<b>Temperature Range</b>	-55°C to 125°C (-67°F to 257°F), Plastic Hood assemblies limited to 105°C (221°F)
<b>Test Voltage</b>	200 V ac rms for 60 seconds
<b>Insulation Resistance</b>	5000 MV min. at 500 V dc
<b>Flammability</b>	UL 94V-0 (Insulators), UL 94V-1 (Plastic Hoods)
<b>Rated Current</b>	Dependent on choice of contact and application (usually limited by cable bundle factor)

## Materials and Finishes

Description	Material	Finish/Treatment
Insulator	Glass-Filled Phenolic	—
Intermating Hardware	Brass and Stainless Steel	—
Jackscrew Knobs	Thermoplastic	—
Cable Clamps	Stainless Steel	—
Pin Protection Shrouds, 14-34 Way	Aluminum	Anodized
Pin Protection Shrouds, 50 & 75 Way	Stainless Steel	—
Formed Hoods	Aluminum	Anodized
Plastic Hoods	Unfilled Thermoplastic - PPO	—
Die Cast Hoods	Zinc Alloy	Grey Paint

## Test Data

Test Description	IEC Test	Military Standard	Test Method
Test Voltage	512-2 Test 4a	MIL-STD-202	301
Insulation Resistance	512-2 Test 3a	MIL-STD-202	302
Vibration	512-4 Test 6d	MIL-STD-202	204, Condition A
Shock	512-4 Test 6c	MIL-STD-202	213
Humidity	512-6 Test 11c	MIL-STD-202	103, Condition C
Corrosion (Salt Spray)	512-6 Test 11f	MIL-STD-202	101, Condition B
Dry Heat	512-6 Test 11i	MIL-STD-202	108A, Condition D



Dimensions shown in mm (inch)  
Specifications and dimensions subject to change

[www.ittcannon.com](http://www.ittcannon.com)

## Contact Cavity Arrangements — Mating Face View

14 Way

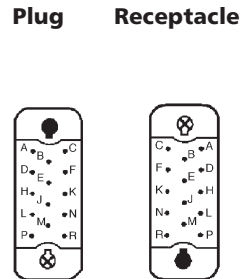

20 Way

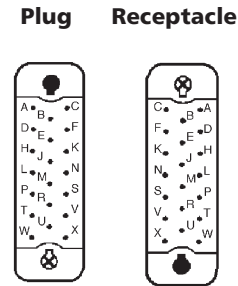

26 Way

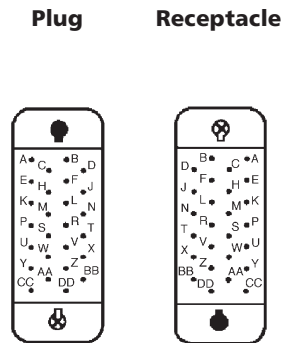

34 Way

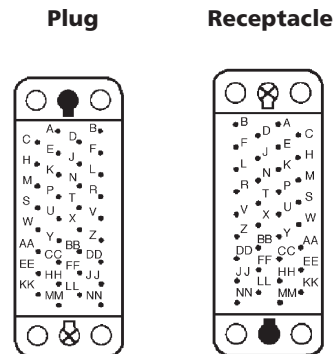

50 Way

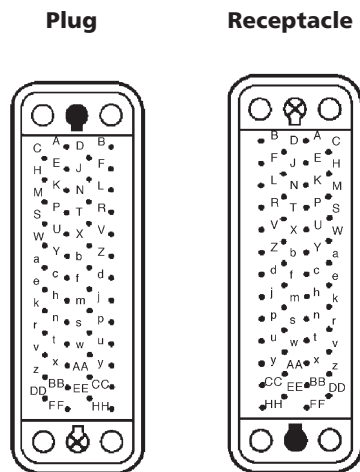

75 Way

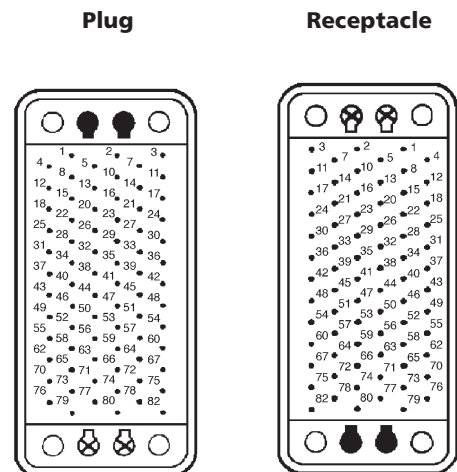

**KEY**

- ⊗ = Guide pin or male jack screw
- = Guide socket or female jack screw
- = Fixing holes can be fitted with additional guide pins and sockets for discrimination

Dimensions shown in mm (inch)  
 Specifications and dimensions subject to change

[www.ittcannon.com](http://www.ittcannon.com)



Multiway Rack & Panel

## How to Order

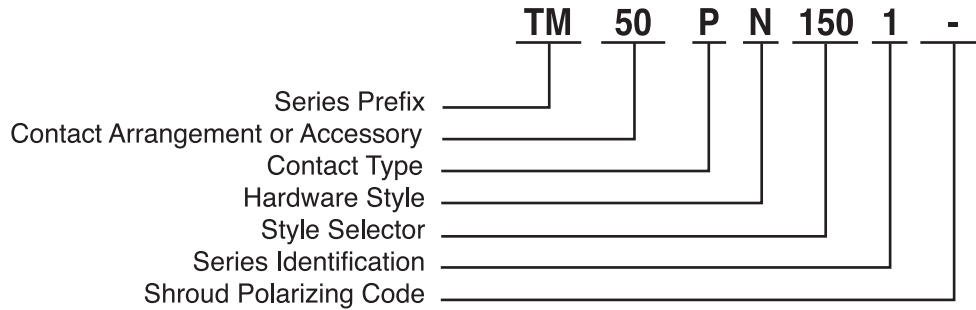

Multiway  
Rack & Panel

### Series Prefix

TM – Trident Multiway

### Contact Arrangement or Accessory

16, 22, 28, 36, 52, 77  
A – Accessory

### Contact Type

P – Plug  
R – Receptacle

### Hardware Style

N – Normal Hardware  
R – Reversed Hardware

### Style Selector

See Hardware Selection Guide,  
page 19.

### Series Identification

1 – For all items in this  
publication

### Shroud Polarizing Code

leave blank, if not required.  
Contact Cannon for other options.

*For more information, please  
contact your local Cannon sales  
office.*



## Style Selector — Hardware Selection Guide

### Plain, No Accessories



Note: Shown without Pin Protection Shroud.

- Specify receptacle first.

#### Plug or Receptacles

	Jackscrews	Guide Pins & Sockets
No Shrouds	007	001
Shrouds	207	201

**Note:**

1. Connectors with Jackscrews will not mate with connectors with Guide Pins or Sockets.
2. Normal Hardware: Plugs have rotating jackscrews.
3. Reversed Hardware: Receptacles have rotating hardware.

### Formed Hood



Note: Shown without Pin Protection Shroud.

#### Plugs

	Jackscrews	Guide Pins & Sockets
No Shrouds	150	120
Shrouds	250	220

**Note:**

1. Connectors with Jackscrews will not mate with connectors with Guide Pins or Sockets.
2. Normal Hardware: Plugs have rotating jackscrews.
3. Reversed Hardware: Receptacles have rotating hardware.

### Plastic Hood



- Jackscrews available on 34 Way only.

#### Plugs

	Jackscrews	Guide Pins & Sockets
No Shrouds	155 (34 Way Only)	159 (14, 20, 26, & 34 Way Only)
Shrouds	255 (34 Way Only)	259 (14, 20, 26, & 34 Way Only)

**Note:**

1. Connectors with Jackscrews will not mate with connectors with Guide Pins or Sockets.
2. Normal Hardware: Plugs have rotating jackscrews.
3. Reversed Hardware: Receptacles have rotating hardware.

### Die-Cast Hood



#### Plugs

	Jackscrews	Guide Pins & Sockets
No Shrouds	157 (50 & 75 Way Only)	N/A
Shrouds	257 (50 & 75 Way Only)	N/A

**Note:**

1. Connectors with Jackscrews will not mate with connectors with Guide Pins or Sockets.
2. Normal Hardware: Plugs have rotating jackscrews.
3. Reversed Hardware: Receptacles have rotating hardware.

### Straight Cable Clamp



#### Plugs

	Jackscrews	Guide Pins & Sockets
No Shrouds	118	180
Shrouds	218	280

**Note:**

1. Connectors with Jackscrews will not mate with connectors with Guide Pins or Sockets.
2. Normal Hardware: Plugs have rotating jackscrews.
3. Reversed Hardware: Receptacles have rotating hardware.

### 90° Cable Clamp



#### Plugs

	Standard Cable Exit to Left Guide Pins		Reversed Cable Exit to Right Guide Pins	
	Jackscrews & Sockets	Jackscrews & Sockets	Jackscrews & Sockets	Jackscrews & Sockets
No Shrouds	138	136	137	135
Shrouds	238	236	237	235

**Note:**

1. Connectors with Jackscrews will not mate with connectors with Guide Pins or Sockets.
2. Normal Hardware: Plugs have rotating jackscrews.
3. Reversed Hardware: Receptacles have rotating hardware.

Multiway Rack & Panel

Ringlock is a range of robust circular connectors for industrial applications. It uses a metal bayonet coupling system for quick and reliable connections and thermoplastic bodies for low installed cost. The connectors are available in several sizes ranging from 4 to 48 circuits for signals of up to 13 A or coax. With the addition of a cable clamp, the connectors can be water sealed to meet IP65.



## Applications:

- Industrial Electronics.
- Robotic Systems.
- Manufacturing Equipment.
- Printing Equipment.

Ringlock  
Circular

## Product Features

- Rugged metal coupling.
- Available in unsealed and sealed versions.
- Positive bayonet locking.
- Shell to shell keying.
- Integrally molded combined plastic body and insulator.
- Wide range of accessories.
- Accepts all Trident signal and coaxial contacts.
- PCB versions are available.
- Recognized under the component program of UL Inc. and CSA.

## Performance Specifications

<b>Operating Voltage</b>	250 V ac rms
<b>Contact Current Rating</b>	Up to 13 A (For derating curve, see page 44)
<b>Temperature Range</b>	-55°C to 105°C (-67°F to 221°F)
<b>Insulation Resistance</b>	5000 MΩ at 500 V dc

## Materials and Finishes

Description	Material	Finish
Insulator	Black Nylon, UL 94V-0	None
Coupling Ring	High Strength Copper Alloy	Nickel
Bayonet Pins	Stainless Steel	—
Bayonet Pins Support Band	High Strength Copper Alloy	Nickel



Dimensions shown in mm (inch)  
Specifications and dimensions subject to change

[www.ittcannon.com](http://www.ittcannon.com)

## Contact Cavity Arrangements

Mating Face View, Standard Plug  
(Mating Face View, Reversed Plug is mirror image)

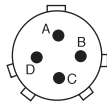

**4 Way**  
**Shell Size 10**

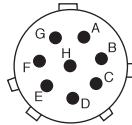

**8 Way**  
**Shell Size 12**

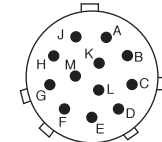

**12 Way**  
**Shell Size 14**

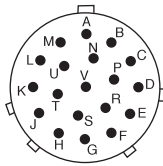

**19 Way**  
**Shell Size 16**

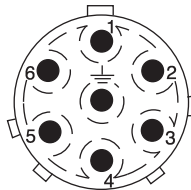

**7 Way\***  
**Shell Size 18**

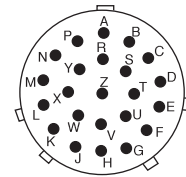

**23 Way**  
**Shell Size 18**

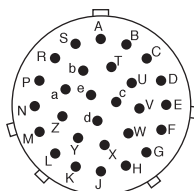

**28 Way**  
**Shell Size 20**

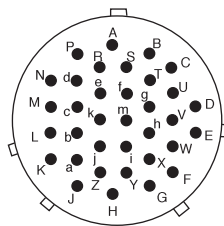

**35 Way**  
**Shell Size 22**

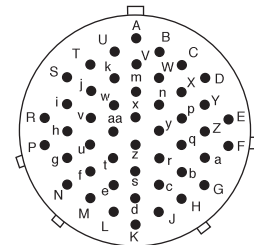

**48 Way**  
**Shell Size 24**

\* Meets creepage and clearance requirements for VDE 0110.

**Note:** The shell size indicates the diameter of the interface in sixteenths of an inch.  
Example: Shell Size 16 is 1.00 inch in diameter, 25,4 mm.

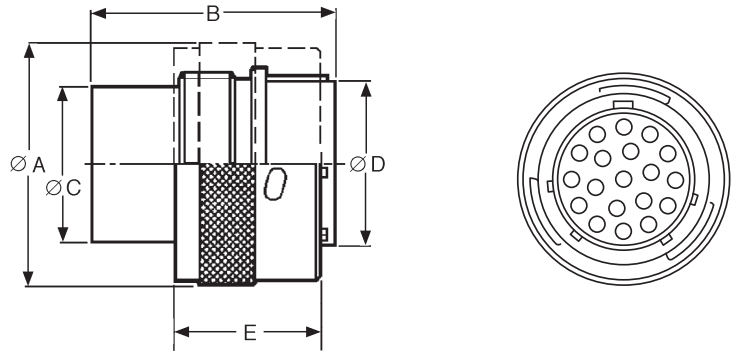

## Standard Plug — Pin Contacts

- Mates with Standard Receptacles, see page 23.
- Accepts pin contacts, see page 47.
- Discriminating (Keying) Pins available, see page 52.
- Can be water sealed to IP65.

Ringlock  
Circular

Number of Contacts	Shell Size	Part Number (Each)	Nomenclature	Dimensions				E	Accessory Thread
				$\varnothing A \pm 0,20 (.008)$	B max.	$\varnothing C \pm 0,15 (.005)$	$\varnothing D \pm 0,15 (.005)$		
4	10	192922-1250	TR 1004 PMS 1NB	21,60 (.850)	31,80 (1.252)	10,90 (.429)	12,20 (.480)	19,10 $\pm 0,20 (.751 \pm .007)$	9/16 - 24 UNEF
7	18	192990-1330	TR 1807 PMS 1NBE	34,30 (1.350)	33,00 (1.299)	22,50 (.885)	24,00 (.944)	19,10 $\pm 0,20 (.751 \pm .007)$	11/16 - 18 UNEF
8	12	192922-1260	TR 1208 PMS 1NB	24,80 (.976)	31,80 (1.252)	13,80 (.543)	15,10 (.594)	19,10 $\pm 0,20 (.751 \pm .007)$	11/16 - 24 UNEF
12	14	192922-1270	TR 1412 PMS 1NB	28,00 (1.102)	31,80 (1.252)	17,00 (.669)	18,30 (.720)	19,10 $\pm 0,20 (.751 \pm .007)$	13/16 - 20 UNEF
19	16	192922-1280	TR 1619 PMS 1NB	31,20 (1.228)	31,80 (1.252)	19,90 (.783)	21,40 (.842)	19,10 $\pm 0,20 (.751 \pm .007)$	15/16 - 18 UNEF
23	18	192990-1320	TR 1823 PMS 1NB	34,30 (1.350)	31,80 (1.252)	22,40 (.881)	24,00 (.944)	19,10 $\pm 0,20 (.751 \pm .007)$	11/16 - 18 UNEF
28	20	192922-1290	TR 2028 PMS 1NB	37,50 (1.476)	31,80 (1.252)	25,60 (1.007)	27,10 (1.066)	19,10 $\pm 0,20 (.751 \pm .007)$	13/16 - 20 UNEF
35	22	192922-1300	TR 2235 PMS 1NB	40,70 (1.602)	31,80 (1.252)	28,50 (1.122)	30,40 (1.196)	19,10 $\pm 0,20 (.751 \pm .007)$	15/16 - 18 UNEF
48	24	192990-1340	TR 2448 PMS 1NB	43,90 (1.728)	31,80 (1.252)	31,70 (1.248)	33,50 (1.318)	14,72 $\pm 0,15 (.580 \pm .006)$	17/16 - 18 UNEF

**IMPORTANT NOTE: Standard and Reversed Format**

Equipment design dictates whether the fixed connector is “live” or “dead” when disconnected. Connector housings are available that provide socket contacts on the live side of the equipment.

Standard Format: Receptacle with socket contacts.

Reversed Format: Receptacle with pin contacts.

Standard and Reversed connectors are not intermateable.



Dimensions shown in mm (inch)  
Specifications and dimensions subject to change

www.ittcannon.com

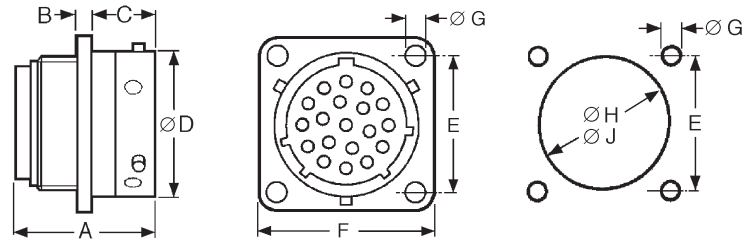

ØJ=Flange in Front of Panel  
ØH= Flange at Rear of Panel

### Standard Receptacle — Socket Contacts

- Mates with Standard Plugs, see page 22.
- Accepts socket contacts, see page 47.
- Printed circuit and coaxial contacts are available, see page 49.

### Dimensions

Number of Contacts	Shell Size	A max.	B ± 0,15 (.005)	C ± 0,20 (.007)	ØD ± 0,15 (.005)	E ± 0,15 (.005)	F ± 0,25 (.009)	ØG ± 0,10 (.003)	ØH ± 0,10 (.003)	ØJ ± 0,10 (.003)	Accessory Thread
4	10	25,80 (1.016)	2,30 (.091)	11,15 (.439)	15,00 (.591)	18,00 (.709)	23,50 (.925)	3,25 (.128)	17,30 (.681)	15,10 (.594)	9/16 - 24 UNEF
7	18	32,50 (1.280)	2,50 (.098)	18,20 (.716)	28,50 (1.122)	27,00 (1.063)	33,30 (1.311)	3,25 (.128)	31,30 (1.232)	27,80 (1.094)	11/16 - 18 UNEF
8	12	25,80 (1.016)	2,30 (.091)	11,35 (.447)	19,00 (.748)	20,50 (.807)	26,20 (1.031)	3,25 (.128)	21,80 (.858)	18,20 (.716)	11/16 - 24 UNEF
12	14	25,80 (1.016)	2,30 (.091)	11,35 (.447)	22,20 (.874)	22,60 (.890)	28,15 (1.108)	3,25 (.128)	25,00 (.984)	21,40 (.842)	13/16 - 20 UNEF
19	16	25,80 (1.016)	2,30 (.091)	11,35 (.447)	25,40 (1.000)	24,20 (.953)	30,50 (1.200)	3,25 (.128)	28,10 (1.106)	24,60 (.968)	15/16 - 20 UNEF
23	18	25,80 (1.016)	2,50 (.098)	11,35 (.447)	28,50 (1.122)	26,90 (1.059)	33,30 (1.311)	3,25 (.128)	31,30 (1.232)	27,80 (1.094)	11/16 - 18 UNEF
28	20	33,30 (1.311)	2,50 (.098)	14,50 (.571)	31,70 (1.248)	29,20 (1.150)	36,50 (1.437)	3,25 (.128)	34,50 (1.358)	30,90 (1.216)	13/16 - 18 UNEF
35	22	33,30 (1.311)	3,50 (.138)	14,50 (.571)	34,90 (1.374)	31,60 (1.244)	39,70 (1.563)	3,25 (.128)	37,70 (1.484)	34,10 (1.342)	15/16 - 18 UNEF
48	24	33,30 (1.311)	3,50 (.138)	15,30 (.602)	38,05 (1.498)	34,45 (1.356)	42,90 (1.689)	3,90 (.154)	40,90 (1.610)	37,30 (1.468)	17/16 - 18 UNEF

### Part Numbers

Number of Contacts	Shell Size	Unsealed		Sealed (see important note below)	
		Part Number (Each)	Nomenclature	Part Number (Each)	Nomenclature
4	10	192922-1190	TR 1004 RFS 1NB	192990-1660	TR 1004 RFH 1NB
7	18	192990-1300	TR 1807 RFS 1NBE	192990-1700	TR 1807 RFH 1NBE
8	12	192922-1200	TR 1208 RFS 1NB	192990-1670	TR 1208 RFH 1NB
12	14	192922-1210	TR 1412 RFS 1NB	192990-1680	TR 1412 RFH 1NB
19	16	192922-1220	TR 1619 RFS 1NB	192990-1690	TR 1619 RFH 1NB
23	18	192990-1290	TR 1823 RFS 1NB	192990-1710	TR 1823 RFH 1NB
28	20	192922-1230	TR 2028 RFS 1NB	192990-1720	TR 2028 RFH 1NB
35	22	192922-1240	TR 2235 RFS 1NB	192990-1730	TR 2235 RFH 1NB
48	24	192990-1310	TR 2448 RFS 1NB	192990-1740	TR 2448 RFH 1NB

#### IMPORTANT NOTE: Sealed Connectors

A sealed receptacle has an O-Ring seal that blocks moisture when the plug and receptacle are mated. However, the receptacle is not sealed in an unmated condition. For protection, dust caps are recommended for unmated receptacles, see page 24.

Plug connectors using a sealed cable clamp (see page 25) with jacketed cable will meet IP65 when mated to a sealed receptacle

Dimensions shown in mm (inch)

Specifications and dimensions subject to change

www.ittcannon.com



Ringlock Circular



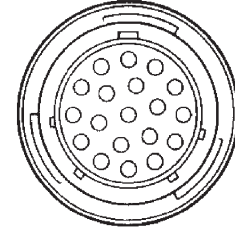
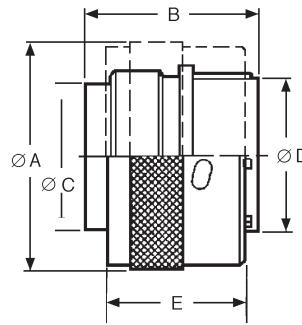

## Reversed Plug — Socket Contacts

- Mates with Reversed Receptacles, see page 25.
- Accepts socket contacts, see page 47.
- Discriminating (Keying) Pins available, see page 52.
- Can be water sealed to IP65.

Ringlock  
Circular

Number of Contacts	Shell Size	Part Number (Each)	Nomenclature	Dimensions					Accessory Thread
				ØA ± 0,20 (.008)	B max.	ØC ± 0,15 (.005)	ØD ± 0,15 (.005)	E	
4	10	192926-0500	TR 1004 PFS 1NB	21,60 (.850)	26,10 (1.027)	11,00 (.433)	12,20 (.480)	19,10 ±0,20 (.751 ±.007)	9/16 - 24 UNEF
7	18	192990-1390	TR 1807 PFS 1NBE	34,30 (1.350)	31,50 (1.240)	22,50 (.885)	24,00 (.944)	19,10 ±0,20 (.751 ±.007)	1-1/16 - 18 UNEF
8	12	192926-0510	TR 1208 PFS 1NB	24,80 (.976)	25,60 (1.008)	13,90 (.547)	15,10 (.594)	19,10 ±0,20 (.751 ±.007)	11/16 - 24 UNEF
12	14	192926-0520	TR 1412 PFS 1NB	28,00 (1.102)	26,80 (1.055)	17,10 (.673)	18,30 (.720)	19,10 ±0,20 (.751 ±.007)	13/16 - 20 UNEF
19	16	192926-0530	TR 1619 PFS 1NB	31,20 (1.228)	27,60 (1.087)	20,00 (.787)	21,40 (.842)	19,10 ±0,20 (.751 ±.007)	15/16 - 18 UNEF
23	18	192990-1380	TR 1823 PFS 1NB	34,30 (1.350)	25,60 (1.088)	22,50 (.885)	24,00 (.944)	19,10 ±0,20 (.751 ±.007)	1-1/16 - 18 UNEF
28	20	192926-0540	TR 2028 PFS 1NB	37,50 (1.476)	31,30 (1.232)	25,70 (1.011)	27,10 (1.066)	19,10 ±0,20 (.751 ±.007)	1-3/16 - 20 UNEF
35	22	192926-0550	TR 2235 PFS 1NB	40,70 (1.602)	31,30 (1.232)	28,60 (1.126)	30,40 (1.196)	19,10 ±0,20 (.751 ±.007)	1-5/16 - 18 UNEF
48	24	192990-1400	TR 2448 PFS 1NB	43,90 (1.728)	31,30 (1.232)	31,80 (1.225)	33,50 (1.318)	14,72 ±0,15 (.580 ±.006)	1-7/16 - 18 UNEF

**IMPORTANT NOTE: Standard and Reversed Format**

Equipment design dictates whether the fixed connector is "live" or "dead" when disconnected. Connector housings are available that provide socket contacts on the live side of the equipment.

Standard Format: Receptacle with socket contacts.

Reversed Format: Receptacle with pin contacts.

**Standard and Reversed connectors are not intermateable.**



Dimensions shown in mm (inch)  
Specifications and dimensions subject to change

www.ittcannon.com

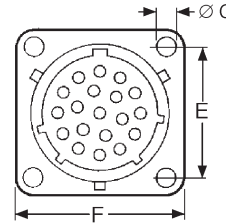
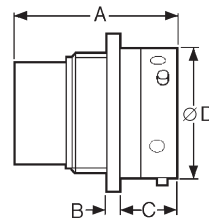

### Panel Cutout

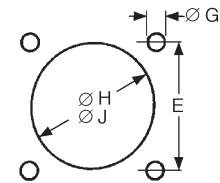

**ØJ = Flange in Front of Panel**  
**ØH = Flange at Rear of Panel**

## Reversed Receptacle — Pin Contacts

- Mates with Reversed Plugs, see page 24.
- Accepts pin contacts, see page 47.
- Printed Circuit and coaxial contacts are available, see page 47.

### Dimensions

Number of Contacts	Shell Size	A max.	B ±0,15 (.005)	C ±0,20 (.007)	ØD ±0,15 (.005)	E ±0,15 (.005)	F ±0,25 (.009)	ØG ±0,10 (.003)	ØH ±0,10 (.003)	ØJ ±0,10 (.003)	Accessory Thread
4	10	31,50 (1.240)	2,30 (.091)	11,35 (.447)	15,00 (.591)	18,00 (.709)	23,50 (.925)	3,25 (.128)	17,30 (.681)	15,10 (.594)	9/16 - 24 UNEF
7	18	34,20 (1.346)	2,30 (.091)	17,80 (.700)	28,50 (1.122)	27,00 (1.063)	33,30 (1.311)	3,25 (.128)	31,30 (1.232)	27,80 (1.094)	1-1/16 - 18 UNEF
8	12	31,50 (1.240)	2,30 (.091)	11,35 (.447)	19,00 (.748)	20,50 (.807)	26,20 (1.031)	3,25 (.128)	21,80 (.858)	18,20 (.716)	11/16 - 24 UNEF
12	14	31,50 (1.240)	2,30 (.091)	11,35 (.447)	22,20 (.874)	22,60 (.890)	28,15 (1.108)	3,25 (.128)	25,00 (.984)	21,40 (.842)	13/16 - 20 UNEF
19	16	31,50 (1.240)	2,30 (.091)	11,35 (.447)	25,40 (1.000)	24,20 (.953)	30,50 (1.200)	3,25 (.128)	28,10 (1.106)	24,60 (.968)	15/16 - 20 UNEF
23	18	31,50 (1.240)	2,50 (.098)	11,35 (.447)	28,50 (1.122)	26,90 (1.059)	33,30 (1.311)	3,25 (.128)	31,30 (1.232)	27,80 (1.094)	1-1/16 - 18 UNEF
28	20	33,00 (1.299)	2,50 (.098)	14,55 (.573)	31,70 (1.248)	29,20 (1.150)	36,50 (1.437)	3,25 (.128)	34,50 (1.358)	30,90 (1.216)	1-3/16 - 18 UNEF
35	22	33,00 (1.299)	3,50 (.138)	14,55 (.573)	34,90 (1.374)	31,60 (1.244)	39,70 (1.563)	3,25 (.128)	37,70 (1.484)	34,10 (1.342)	1-5/16 - 18 UNEF
48	24	34,80 (1.370)	3,50 (.138)	15,35 (.604)	38,05 (1.498)	34,45 (1.356)	42,90 (1.689)	3,90 (.154)	40,90 (1.610)	37,30 (1.468)	1-7/16 - 18 UNEF

### Part Numbers

Number of Contacts	Shell Size	Unsealed		Sealed (see important note below)	
		Part Number (Each)	Nomenclature	Part Number (Each)	Nomenclature
4	10	192926-0440	TR 1004 RMS 1NB	192990-1760	TR 1004 RMH 1NB
7	18	192990-1360	TR 1807 RMS 1NBE	192990-1800	TR 1807 RMH 1NBE
8	12	192926-0450	TR 1208 RMS 1NB	192990-1770	TR 1208 RMH 1NB
12	14	192926-0460	TR 1412 RMS 1NB	192990-1780	TR 1412 RMH 1NB
19	16	192926-0470	TR 1619 RMS 1NB	192990-1790	TR 1619 RMH 1NB
23	18	192990-1350	TR 1823 RMS 1NB	192990-1810	TR 1823 RMH 1NB
28	20	192926-0480	TR 2028 RMS 1NB	192990-1820	TR 2028 RMH 1NB
35	22	192926-0490	TR 2235 RMS 1NB	192990-1830	TR 2235 RMH 1NB
48	24	192990-1370	TR 2448 RMS 1NB	192990-1840	TR 2448 RMH 1NB

#### IMPORTANT NOTE: Sealed Connectors

A sealed receptacle has an O-Ring seal that blocks moisture when the plug and receptacle are mated. However, the receptacle is not sealed in an unmated condition. For protection, dust caps are recommended for unmated receptacles, see page 24.

Plug connectors using a sealed cable clamp (see page 25) with jacketed cable will meet IP65 when mated to a sealed receptacle.

Dimensions shown in mm (inch)

Specifications and dimensions subject to change

www.ittcannon.com



Ringlock Circular

# Cannon Trident Connector System

Ringlock Circular Connectors

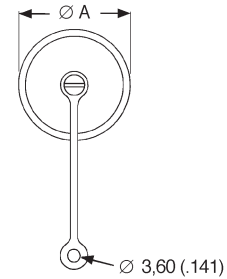
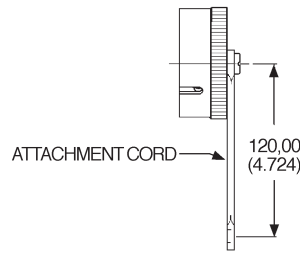

## Plastic Dust Caps for Receptacles

- Protects unmated receptacles.
- Durable construction for long-term use.
- For use with Ringlock receptacles.

Shell Size	Part Number (Each)	Part Number (Pack of 100)	Dimension Ø A max.
10	192900-0666	192900-0676	21,80 (.858)
12	192900-0667	192900-0677	25,40 (1.000)
14	192900-0668	192900-0678	28,60 (1.126)
16	192900-0669	192900-0679	31,70 (1.248)
18	192900-0670	192900-0680	34,90 (1.374)
20	192900-0671	192900-0681	38,10 (1.500)
22	192900-0672	192900-0682	41,20 (1.622)
24	192900-0673	192900-0683	44,40 (1.748)

Ringlock  
Circular

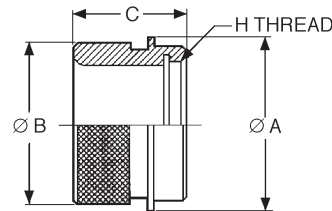

## Adapters for Heat Shrink Boots or Sleeving

Shell Size	Part Number (Each)	Nomenclature	ØA max.	ØB max.	C max.	H Thread
10	192990-1430	TR 10 AAD	21,00 (.827)	18,10 (.712)	19,20 (.755)	9/16 - 24 UNEF-2B
12	192990-1440	TR 12 AAD	24,00 (.944)	23,40 (.921)	19,20 (.755)	11/16 - 24 UNEF-2B
14	192990-1450	TR 14 AAD	27,00 (1.063)	24,20 (.952)	19,20 (.755)	13/16 - 20 UNEF-2B
16	192990-1460	TR 16 AAD	30,20 (1.189)	29,60 (1.165)	21,50 (.846)	15/16 - 20 UNEF-2B
18	192990-1470	TR 18 AAD	33,30 (1.311)	31,70 (1.248)	21,50 (.846)	11/16 - 18 UNEF-2B
20	192990-1480	TR 20 AAD	36,50 (1.437)	35,80 (1.409)	22,80 (.897)	13/16 - 18 UNEF-2B
22	192990-1490	TR 22 AAD	39,70 (1.563)	38,20 (1.503)	22,80 (.897)	15/16 - 18 UNEF-2B
24	192990-1500	TR 24 AAD	42,90 (1.689)	41,30 (1.626)	21,90 (.862)	17/16 - 18 UNEF-2B



## Panel Gaskets For Ringlock Receptacle Connectors

- All panel gaskets are 1,50 (.059) thick.

Shell Size	Part Number (Pack of 100)
10	075-8543-011
12	075-8543-012
14	192900-0565
16	192900-0566
18	075-8543-015
20	192991-0566
22	075-8543-017
24	192900-0567



Dimensions shown in mm (inch)  
Specifications and dimensions subject to change

www.ittcannon.com



### Sealed Cable Clamps for Use With Ringlock Circular Connectors

- For use with jacketed cables.
- Provides strain relief and wire protection.
- Can be water sealed to IP65. See notes on pages 22 and 24.
- For assembly instructions, see page 56.

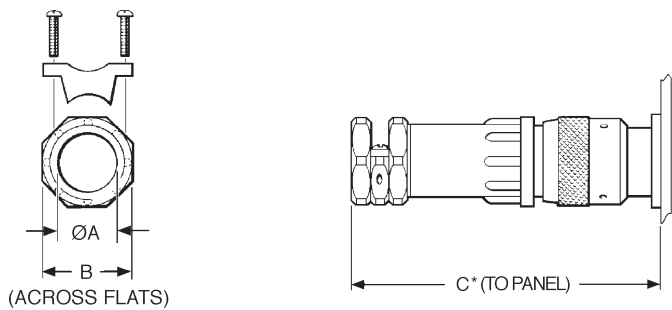

\* For disassembly, add 9,00 (.354) for Shell Sizes 10-16 & add 10,60 (.417) for Shell Sizes 18-24.

Shell Size	Part Number (Each)	Nomenclature	Ø A max.	B ± 0,20 (.007)	C* max.
10	192990-1530	TR 10 AHC 1N	11,10 (.437)	18,80 (.740)	76,50 (3.011)
12	192990-1540	TR 12 AHC 1N	13,60 (.535)	20,80 (.818)	77,80 (3.063)
14	192990-1550	TR 14 AHC 1N	14,60 (.574)	22,80 (.897)	85,50 (3.366)
16	192990-1560	TR 16 AHC 1N	16,60 (.653)	24,70 (.972)	89,80 (3.535)
18	192990-1570	TR 18 AHC 1N	16,60 (.653)	24,70 (.972)	93,00 (3.661)
20	192990-1580	TR 20 AHC 1N	22,10 (.870)	31,80 (1.252)	107,50 (4.232)
22	192990-1590	TR 22 AHC 1N	22,10 (.870)	31,80 (1.252)	114,50 (4.507)
24	192990-1600	TR 24 AHC 1N	29,60 (1.165)	41,80 (1.645)	128,50 (5.059)

\* Assumes a uniformly cylindrical cable. Variations in the diameter could effect sealing.



### Unsealed Cable Clamps For Use With Ringlock Circular Connectors

- Provides strain relief and wire protection.
- For assembly instructions, see page 59.

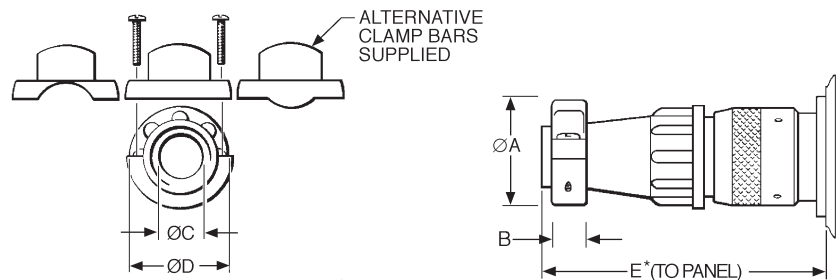

\* For disassembly, add 9,00 (.354) for Shell Sizes 10-16 & add 10,60 (.417) for Shell Sizes 18-24.

Shell Size	Part Number (Each)	Nomenclature	Ø A max.	B ± 0,15 (.005)	Ø C max.	Ø D ± 0,15 (.005)	E* max.
10	192922-1310	TR 10 ASR 1N	21,50 (.846)	6,40 (.251)	8,70 (.342)	21,00 (.826)	61,30 (2.413)
12	192922-1320	TR 12 ASR 1N	24,90 (.980)	6,40 (.251)	12,80 (.503)	24,00 (.944)	61,30 (2.413)
14	192922-1330	TR 14 ASR 1N	27,00 (1.063)	6,40 (.251)	13,80 (.543)	27,00 (1.063)	67,10 (2.641)
16	192922-1340	TR 16 ASR 1N	30,10 (1.185)	6,40 (.251)	17,00 (.669)	30,20 (1.189)	67,10 (2.641)
18	192990-1510	TR 18 ASR 1N	32,00 (1.259)	7,00 (.275)	19,90 (.783)	33,20 (1.307)	70,80 (2.787)
20	192922-1350	TR 20 ASR 1N	34,30 (1.350)	7,00 (.275)	21,00 (.827)	36,40 (1.433)	79,30 (3.122)
22	192922-1360	TR 22 ASR 1N	37,10 (1.460)	8,20 (.322)	23,00 (.905)	39,60 (1.559)	85,30 (3.358)
24	192990-1520	TR 24 ASR 1N	41,80 (1.645)	8,20 (.322)	27,00 (1.063)	42,80 (1.685)	90,80 (3.574)

Dimensions shown in mm (inch)  
Specifications and dimensions subject to change

www.ittcannon.com



Ringlock Circular

Neptune is a range of circular connectors specifically designed for harsh environment applications. They come with membrane wire seals that meet the requirements for IP67 and do not require blanking plugs for unused cavities. They will accept various combinations of signal (13 A) and power (30 A) contacts. The receptacle connectors feature stainless steel bayonet pins integrally molded into the bodies. The plug connectors are available with either high strength metal or corrosion resistant plastic coupling rings.

## Applications

- Off Road Vehicles.
- Truck and Bus.
- Agricultural Equipment.
- Construction Equipment.
- Outdoor Electronics



## Product Features

- Mixes signal and 30 A power contacts in one housing.
- Printed circuit and coaxial contacts available.
- Full interface and cable sealing up to IP67.
- Large range support accessories.
- Robust, cost effective connector for harsh environments.

## Performance Specifications

<b>Temperature Range</b>	-55°C to 105°C (-67°F to 221°F)
<b>Test Voltage</b>	2000 V ac rms
<b>Working Voltage</b>	25 V (Can be higher, if the equipment safety will allow)
<b>Insulation Resistance</b>	5000 MΩ at 500 V dc
<b>Environmental Sealing</b>	Up to IP67
<b>Flammability</b>	UL 94V-0

## Materials and Finishes

Description	Material	Finish
Insulator	Black Nylon, UL 94V-0	None
Bayonet Pin	Stainless Steel	None
Bayonet Pin Support Band	High Strength Copper Alloy	Nickel
Coupling Ring	High Strength Copper Alloy	Nickel

## Contact Cavity Arrangements

Neptune Circular Connectors offer combinations of signal and power contacts.

The Signal cavities will accept any of the standard Trident contacts, including signal contacts up to 13 A and coax. The power cavities will accept power contacts rated at 30 A. PCB contacts are also available, for more information see page 47.

### Mating Face Views of Reversed and Standard Receptacles.

\* The 0-12 view is of reversed receptacle only  
(0-12 standard receptacle is mirror image)

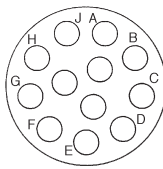

**0-12\***  
**Shell Size 14**  
**12 Signal**  
**0 Power**

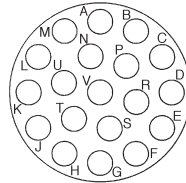

**0-19**  
**Shell Size 16**  
**19 Signal**  
**0 Power**

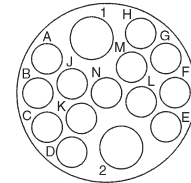

**2-13**  
**Shell Size 16**  
**13 Signal**  
**2 Power**

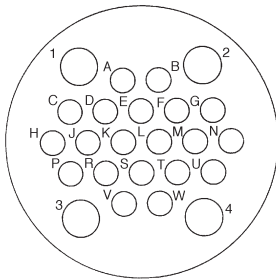

**4-20**  
**Shell Size 24**  
**20 Signal**  
**4 Power**

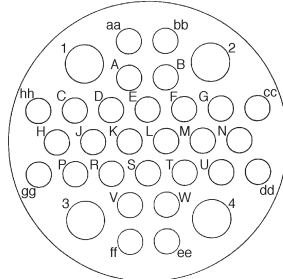

**4-28**  
**Shell Size 24**  
**28 Signal**  
**4 Power**

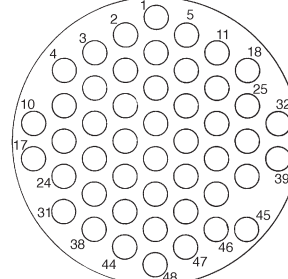

**0-48**  
**Shell Size 24**  
**48 Signal**  
**0 Power**

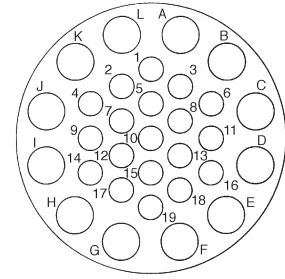

**12-19**  
**Shell Size 24**  
**19 Signal**  
**12 Power**

Note: The shell size indicates the diameter of the interface in sixteenths of an inch.  
Example: Shell Size 16 is 1.00 inch in diameter, 25,4 mm.

## Wire Sealing Range

Contact Arrangement	Signal (Overall Diameter)	Power (Overall Diameter)
0-12	1,70-2,70 (.066-.106)	N/A
0-19	1,70-2,70 (.066-.106)	N/A
2-13	1,70-2,70 (.066-.106)	2,70-4,00 (.106-.157)
4-20	1,70-2,70 (.066-.106)	2,70-4,00 (.106-.157)
4-28	1,70-2,70 (.066-.106)	2,70-4,00 (.106-.157)
0-48	1,70-2,20 (.066-.086)	N/A
0-48 (L)	2,30-3,20 (.090-.126)	N/A
12-19	1,70-2,70 (.066-.106)	2,70-4,00 (.106-.157)

(L) Larger overall sealing diameter for thick insulation wires.



# Cannon Trident Connector System

Neptune Circular Connectors

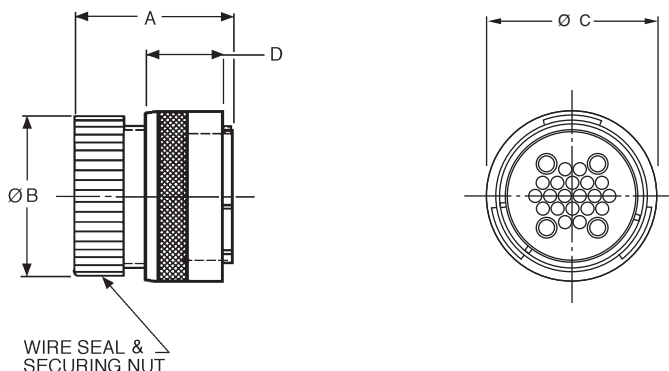

## Standard Plugs — Pin Contacts Metal Locking Ring

- For Wire Sealing Ranges, see page 29.
- Accepts pin contacts, see page 47.
- Water sealed to IP67.
- Bulk packaging options available. Contact Cannon for details.

### Contact

Layout	Shell Size	Part Number	Nomenclature	A	ØB	ØC	D
4-20	24	192900-0014	TN 6S 2404-20 P1L	39,80 (1.566)	40,50 (1.594)	44,00 (1.732)	14,72 ±0,15 (.580 ±.006)
4-28	24	192900-0015	TN 6S 2404-28 P1L	39,80 (1.566)	40,50 (1.594)	44,00 (1.732)	14,72 ±0,15 (.580 ±.006)
12-19	24	192900-0016	TN 6S 2412-19 P1L	39,80 (1.566)	40,50 (1.594)	44,00 (1.732)	14,72 ±0,15 (.580 ±.006)
0-48	24	192900-0469	TN 6S 2400-48 P1L	39,80 (1.566)	40,50 (1.594)	44,00 (1.732)	14,72 ±0,15 (.580 ±.006)
0-48 (L)	24	192991-0628	TN 6L 2400-48 P1L	50,70 (2.000)	40,50 (1.594)	44,00 (1.732)	14,72 ±0,15 (.580 ±.006)
0-19	16	192900-0017	TN 6S 1600-19 P1L	39,80 (1.566)	27,00 (1.063)	30,20 (1.189)	19,10 ±0,20 (.751 ±.007)
2-13	16	192900-0507	TN 6S 1602-13 P1L	39,80 (1.566)	27,00 (1.063)	30,20 (1.189)	19,10 ±0,20 (.751 ±.007)
0-12	14	192900-0303	TN 6S 1400-12 P1L	38,80 (1.527)	24,30 (.957)	28,00 (1.102)	19,10 ±0,20 (.751 ±.007)

(L) Larger overall sealing diameter for thick insulation wires.

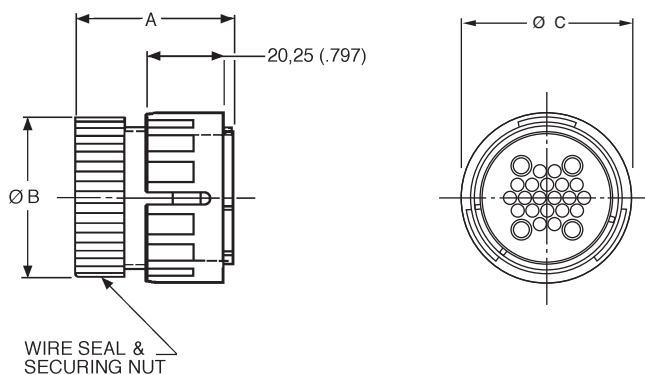

## Plastic Locking Ring

- For Wire Sealing Ranges, see page 29.
- Accepts pin contacts, see page 47.
- Water sealed to IP67.
- Bulk packaging options available. Contact Cannon for details.

### Contact

Layout	Shell Size	Part Number	Nomenclature	A	ØB	ØC
4-20	24	192900-0537	TN 6S2404-20 P2L	39,80 (1.566)	40,50 (1.594)	45,75 (1.800)
4-28	24	192900-0549	TN 6S2404-28 P2L	39,80 (1.566)	40,50 (1.594)	45,75 (1.800)
12-19	24	192900-0538	TN 6S2412-19 P2L	39,80 (1.566)	40,50 (1.594)	45,75 (1.800)
0-48	24	192900-0539	TN 6S2400-48 P2L	39,80 (1.566)	40,50 (1.594)	45,75 (1.800)
0-48 (L)	24	192991-0660	TN 6L2400-48 P2L	50,70 (2.000)	40,50 (1.594)	45,75 (1.800)
0-19	16	192900-0557	TN 6S1600-19 P2L	39,80 (1.566)	27,00 (1.063)	32,80 (1.291)
2-13	16	192900-0561	TN 6S1602-13 P2L	39,80 (1.566)	27,00 (1.063)	32,80 (1.291)

(L) Larger overall sealing diameter for thick insulation wires.

Dimensions are shown in mm (inch)  
Dimensions subject to change



Dimensions shown in mm (inch)  
Specifications and dimensions subject to change

www.ittcannon.com



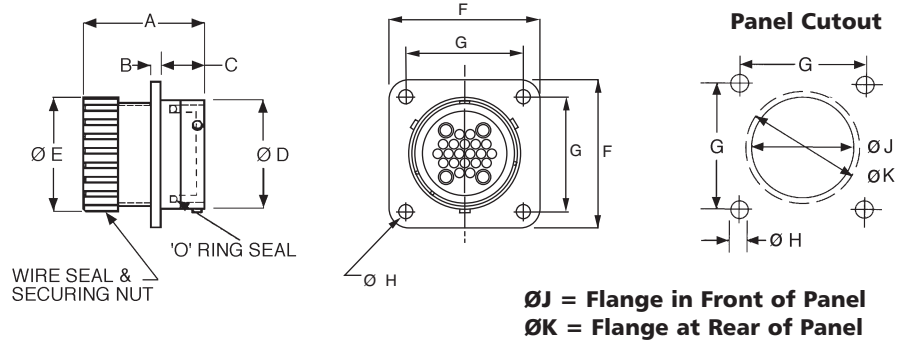

### Standard Receptacles — Socket Contacts Flange Mounting

- For Wire Sealing Ranges, see page 29.
- For Panel Gaskets, see page 37.
- Receptacle may be ordered without securing nut and wire seal. Contact Cannon for details.
- Bulk packaging options available. Contact Cannon for details.

#### Contact Shell

Layout	Size	Part Number	Nomenclature	A	B	C	ØD	ØE	F	G	ØH	ØJ	ØK
4-20	24	192900-0030	TN OS 2404-20 S1L	41,80 (1.645)	3,50 (.137)	15,40 (.606)	38,10 (1.500)	40,10 (1.578)	50,80 (2.000)	39,70 (1.563)	4,20 (.165)	41,00 (1.614)	41,00 (1.614)
4-28	24	192900-0033	TN OS 2404-28 S1L	41,80 (1.645)	3,50 (.137)	15,40 (.606)	38,10 (1.500)	40,10 (1.578)	50,80 (2.000)	39,70 (1.563)	4,20 (.165)	41,00 (1.614)	41,00 (1.614)
12-19	24	192900-0036	TN OS 2412-19 S1L	41,80 (1.645)	3,50 (.137)	15,40 (.606)	38,10 (1.500)	40,10 (1.578)	50,80 (2.000)	39,70 (1.563)	4,20 (.165)	41,00 (1.614)	41,00 (1.614)
0-48	24	192900-0475	TN OS 2400-48 S1L	41,80 (1.645)	3,50 (.137)	15,40 (.606)	38,10 (1.500)	40,10 (1.578)	50,80 (2.000)	39,70 (1.563)	4,20 (.165)	41,00 (1.614)	41,00 (1.614)
0-48 (L)	24	192991-0640	TN OL 2400-48 S1L	52,70 (2.075)	3,50 (.137)	15,40 (.606)	38,10 (1.500)	40,10 (1.578)	50,80 (2.000)	39,70 (1.563)	4,20 (.165)	41,00 (1.614)	41,00 (1.614)
0-19	16	192900-0039	TN OS 1600-19 S1L	39,80 (1.566)	2,30 (.090)	11,40 (.448)	25,40 (1.000)	27,00 (1.063)	31,00 (1.220)	24,50 (.964)	3,20 (.125)	28,10 (1.106)	28,10 (1.106)
2-13	16	192900-0509	TN OS 1602-13 S1L	39,80 (1.566)	2,30 (.090)	11,40 (.448)	25,40 (1.000)	27,00 (1.063)	31,00 (1.220)	24,50 (.964)	3,20 (.125)	28,10 (1.106)	28,10 (1.106)
0-12	14	192900-0308	TN OS 1400-12 S1L	39,70 (1.563)	2,30 (.090)	11,40 (.448)	22,20 (.874)	24,30 (.956)	28,60 (1.122)	22,90 (.901)	3,20 (.125)	24,60 (.968)	24,60 (.968)

(L) Larger overall sealing diameter for thick insulation wires.

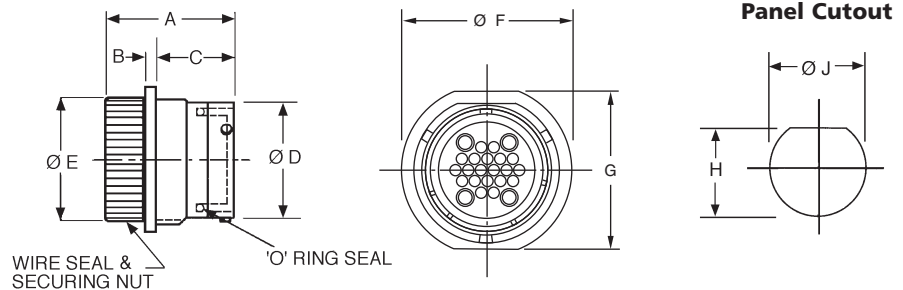

### Jam Nut Mounting

- Jam Nut included.
- For Wire Sealing Ranges, see page 29.
- For Panel Gaskets, see page 35.
- Receptacle may be ordered without securing nut and wire seal. Contact Cannon for details.
- Bulk packaging options available. Contact Cannon for details.

#### Contact Shell

Layout	Size	Part Number	Nomenclature	A	B	C	ØD	ØE	ØF	G	H	ØJ
4-20	24	192900-0032	TN 7S 240420 S1L	41,80 (1.645)	3,50 (.137)	23,40 (.921)	38,10 (1.500)	40,10 (1.578)	51,00 (2.007)	47,50 (1.870)	41,50 (1.633)	43,20 (1.700)
4-28	24	192900-0035	TN 7S 240428 S1L	41,80 (1.645)	3,50 (.137)	23,40 (.921)	38,10 (1.500)	40,10 (1.578)	51,00 (2.007)	47,50 (1.870)	41,50 (1.633)	43,20 (1.700)
12-19	24	192900-0038	TN 7S 241219 S1L	41,80 (1.645)	3,50 (.137)	23,40 (.921)	38,10 (1.500)	40,10 (1.578)	51,00 (2.007)	47,50 (1.870)	41,50 (1.633)	43,20 (1.700)
0-48	24	192900-0481	TN 7S 240048 S1L	41,80 (1.645)	3,50 (.137)	23,40 (.921)	38,10 (1.500)	40,10 (1.578)	51,00 (2.007)	47,50 (1.870)	41,50 (1.633)	43,20 (1.700)
0-48 (L)	24	192991-0644	TN 7L 240048 S1L	52,70 (2.075)	3,50 (.137)	23,40 (.921)	38,10 (1.500)	40,10 (1.578)	51,00 (2.007)	47,50 (1.870)	41,50 (1.633)	43,20 (1.700)
0-19	16	192900-0490	TN 7S 160019 S1L	39,80 (1.566)	2,30 (.090)	23,00 (.905)	25,40 (1.000)	27,00 (1.063)	39,80 (1.566)	38,40 (1.511)	28,00 (1.102)	30,50 (1.200)
2-13	16	192900-0508	TN 7S 160213 S1L	39,80 (1.566)	2,30 (.090)	23,00 (.905)	25,40 (1.000)	27,00 (1.063)	39,80 (1.566)	38,40 (1.511)	28,00 (1.102)	30,50 (1.200)
0-12	14	192900-0313	TN 7S 140012 S1L	39,70 (1.563)	3,50 (.137)	22,10 (.870)	22,20 (.874)	24,30 (.956)	35,80 (1.409)	32,20 (1.267)	25,10 (.988)	27,30 (1.075)

(L) Larger overall sealing diameter for thick insulation wires.

# Cannon Trident Connector System

Neptune Circular Connectors

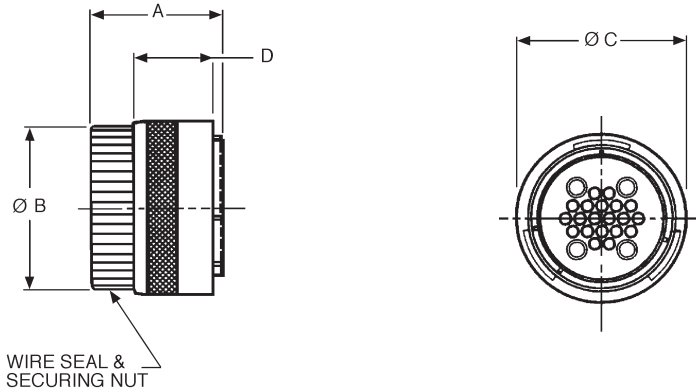

## Reversed Plugs — Socket Contacts Metal Locking Ring

- For Wire Sealing Ranges, see page 29.
- Accepts socket contacts, see page 47.
- Water sealed to IP67.
- Bulk packaging options available. Contact Cannon for details.

Contact Layout	Shell Size	Part Number	Nomenclature	A	Ø B	Ø C	D
4-20	24	192900-0054	TN 6S 240420 S1L	32,40 (1.275)	40,50 (1.594)	44,00 (1.732)	14,72 ±0,15 (.580 ±.006)
4-28	24	192900-0055	TN 6S 240428 S1L	32,40 (1.275)	40,50 (1.594)	44,00 (1.732)	14,72 ±0,15 (.580 ±.006)
12-19	24	192900-0056	TN 6S 241219 S1L	32,40 (1.275)	40,50 (1.594)	44,00 (1.732)	14,72 ±0,15 (.580 ±.006)
0-48	24	192900-0425	TN 6S 240048 S1L	32,40 (1.275)	40,50 (1.594)	44,00 (1.732)	14,72 ±0,15 (.580 ±.006)
0-48 (L)	24	192991-0648	TN 6SL 240048 S1L	43,00 (1.693)	40,50 (1.594)	44,00 (1.732)	14,72 ±0,15 (.580 ±.006)
0-19	16	192900-0057	TN 6S 160019 S1L	31,70 (1.248)	27,00 (1.063)	30,20 (1.189)	19,10 ±0,20 (.751 ±.007)
2-13	16	192900-0581	TN 6S 160213 S1L	31,70 (1.248)	27,00 (1.063)	30,20 (1.189)	19,10 ±0,20 (.751 ±.007)
0-12	14	192900-0236	TN 6S 140012 S1L	31,60 (1.244)	24,30 (.957)	28,00 (1.102)	19,10 ±0,20 (.751 ±.007)

(L) Larger overall sealing diameter for thick insulation wires.

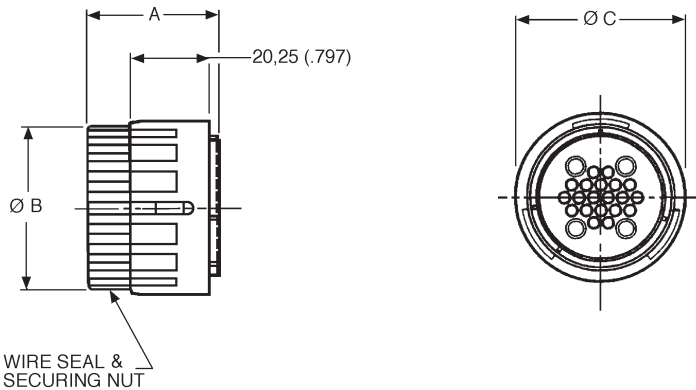

## Plastic Locking Ring

- For Wire Sealing Ranges, see page 29.
- Accepts socket contacts, see page 47.
- Water sealed to IP67.
- Bulk packaging options available. Contact Cannon for details.

Contact Layout	Shell Size	Part Number	Nomenclature	A	Ø B	Ø C
4-20	24	192900-0540	TN 6S 2404-20S 2L	32,40 (1.275)	40,50 (1.594)	44,00 (1.732)
4-28	24	192900-0550	TN 6S 2404-28S 2L	32,40 (1.275)	40,50 (1.594)	44,00 (1.732)
12-19	24	192900-0541	TN 6S 2412-19S 2L	32,40 (1.275)	40,50 (1.594)	44,00 (1.732)
0-48	24	192900-0542	TN 6S 2400-48S 2L	32,40 (1.275)	40,50 (1.594)	44,00 (1.732)
0-48 (L)	24	192991-0664	TN 6L 2400-48S 2L	43,00 (1.693)	40,50 (1.594)	44,00 (1.732)
0-19	16	192900-0558	TN 6S 1600-19S 2L	31,70 (1.248)	27,00 (1.063)	32,80 (1.291)
2-13	16	192900-0562	TN 6S 1602-13S 2L	31,70 (1.248)	27,00 (1.063)	32,80 (1.291)

(L) Larger overall sealing diameter for thick insulation wires.



Dimensions shown in mm (inch)  
Specifications and dimensions subject to change

www.ittcannon.com



### Reversed Receptacles — Pin Contacts Flange Mounting

- For Wire Sealing Ranges, see page 29.
- For Panel Gaskets, see page 37.
- Receptacle may be ordered without securing nut and wire seal. Contact Cannon for details.
- Bulk packaging options available. Contact Cannon for details.

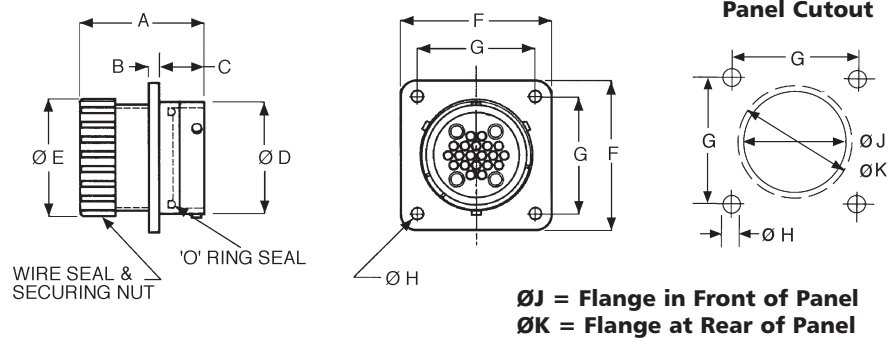

#### Contact Shell

Layout	Size	Part Number	Nomenclature	A	B	C	Ø D	Ø E	F	G	Ø H	Ø J	Ø K
4-20	24	192900-0069	TN OS 2404-20 P1L	41,80 (1.645)	3,50 (.137)	15,40 (.606)	38,10 (1.500)	40,10 (1.578)	50,80 (2.000)	39,70 (1.563)	4,20 (.165)	41,00 (1.614)	41,00 (1.614)
4-28	24	192900-0072	TN OS 2404-28 P1L	41,80 (1.645)	3,50 (.137)	15,40 (.606)	38,10 (1.500)	40,10 (1.578)	50,80 (2.000)	39,70 (1.563)	4,20 (.165)	41,00 (1.614)	41,00 (1.614)
12-19	24	192900-0075	TN SO 2412-19 P1L	41,80 (1.645)	3,50 (.137)	15,40 (.606)	38,10 (1.500)	40,10 (1.578)	50,80 (2.000)	39,70 (1.563)	4,20 (.165)	41,00 (1.614)	41,00 (1.614)
0-48	24	192900-0431	TN OS 2400-48 P1L	41,80 (1.645)	3,50 (.137)	15,40 (.606)	38,10 (1.500)	40,10 (1.578)	50,80 (2.000)	39,70 (1.563)	4,20 (.165)	41,00 (1.614)	41,00 (1.614)
0-48 (L)	24	192991-0652	TN OL 2400-48 P1L	52,70 (2.075)	3,50 (.137)	15,40 (.606)	38,10 (1.500)	40,10 (1.578)	50,80 (2.000)	39,70 (1.563)	4,20 (.165)	41,00 (1.614)	41,00 (1.614)
0-19	16	192900-0078	TN OS 1600-19 P1L	39,80 (1.566)	2,30 (.090)	11,40 (.448)	25,40 (1.000)	27,00 (1.063)	31,00 (1.220)	24,50 (.964)	3,20 (.125)	28,10 (1.106)	28,10 (1.106)
2-13	16	192900-0582	TN OS 1602-13 P1L	39,80 (1.566)	2,30 (.090)	11,40 (.448)	25,40 (1.000)	27,00 (1.063)	31,00 (1.220)	24,50 (.964)	3,20 (.125)	28,10 (1.106)	28,10 (1.106)
0-12	14	192900-0256	TN OS 1400-12 P1L	39,70 (1.563)	2,30 (.090)	11,40 (.448)	22,20 (.874)	24,30 (.956)	28,60 (1.122)	22,90 (.901)	3,20 (.125)	24,60 (.968)	24,60 (.968)

(L) Larger overall sealing diameter for thick insulation wires.



### Jam Nut Mounting

- Jam Nut included.
- For Wire Sealing Ranges, see page 29.
- For Panel Gaskets, see page 37.
- Receptacle may be ordered without securing nut and wire seal. Contact Cannon for details.
- Bulk packaging options available. Contact Cannon for details.

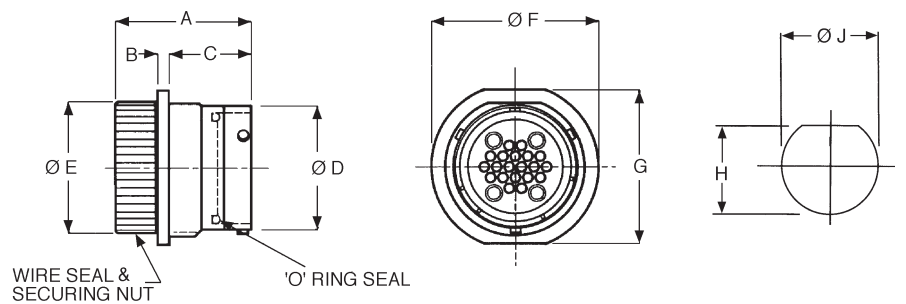

#### Contact Shell

Layout	Size	Part Number	Nomenclature	A	B	C	Ø D	Ø E	Ø F	G	H	Ø J
4-20	24	192900-0071	TN 7S 240420 P1L	41,80 (1.645)	3,50 (.137)	23,40 (.921)	38,10 (1.500)	40,10 (1.578)	51,00 (2.007)	47,50 (1.870)	41,50 (1.633)	43,20 (1.700)
4-28	24	192900-0074	TN 7S 240428 P1L	41,80 (1.645)	3,50 (.137)	23,40 (.921)	38,10 (1.500)	40,10 (1.578)	51,00 (2.007)	47,50 (1.870)	41,50 (1.633)	43,20 (1.700)
12-19	24	192900-0077	TN 7S 241219 P1L	41,80 (1.645)	3,50 (.137)	23,40 (.921)	38,10 (1.500)	40,10 (1.578)	51,00 (2.007)	47,50 (1.870)	41,50 (1.633)	43,20 (1.700)
0-48	24	192900-0437	TN 7S 240048 P1L	41,80 (1.645)	3,50 (.137)	23,40 (.921)	38,10 (1.500)	40,10 (1.578)	51,00 (2.007)	47,50 (1.870)	41,50 (1.633)	43,20 (1.700)
0-48 (L)	24	192991-0656	TN 7L 240048 P1L	52,70 (2.075)	3,50 (.137)	23,40 (.921)	38,10 (1.500)	40,10 (1.578)	51,00 (2.007)	47,50 (1.870)	41,50 (1.633)	43,20 (1.700)
0-19	16	192900-0353	TN 7S 160019 P1L	39,80 (1.566)	2,30 (.090)	23,00 (.905)	25,40 (1.000)	27,00 (1.063)	30,80 (1.212)	38,20 (1.503)	28,00 (1.102)	30,50 (1.200)
2-13	16	192900-0583	TN 7S 160213 P1L	39,80 (1.566)	2,30 (.090)	23,00 (.905)	25,40 (1.000)	27,00 (1.063)	30,80 (1.212)	38,20 (1.503)	28,00 (1.102)	30,50 (1.200)
0-12	14	192900-0266	TN 7S 140012 P1L	39,70 (1.563)	2,30 (.137)	22,10 (.870)	22,20 (.874)	24,30 (.956)	35,80 (1.409)	32,20 (1.267)	25,10 (.988)	27,30 (1.075)

(L) Larger overall sealing diameter for thick insulation wires.

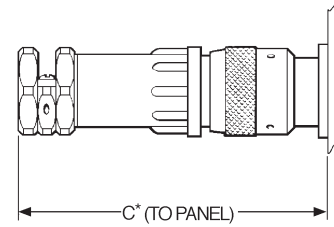
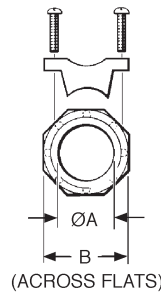

\* For disassembly, add 9,00 (.354) for shell sizes 14 and 16 and add 10,60 (.417) for shell size 24.

### Sealed Cable Clamps For Use With Neptune Circular Connectors

- For use with jacketed cables.
- Provides Strain relief and wire protection.
- Provides sealing to IP67.
- For assembly instructions, see page 57.

Shell Size	Part Number	Nomenclature	ØA max.	B	C max.	Wire Sealing Diameter	
						Minimum	Maximum
14	192900-0496	TNA 14 CCHC-00L	14,60 (.574)	22,80 (.897)	85,50 (3.366)	6,50 (.256)	12,40 (.488)
16	192900-0497	TNA 16 CCHC-00L	16,60 (.653)	24,70 (.972)	89,80 (3.535)	6,50 (.256)	12,40 (.488)
24	192900-0498	TNA 24 CCHC-00L	29,60 (1.165)	41,80 (1.645)	128,50 (5.059)	17,00 (.670)	26,50 (1.040)

\* Assumes a uniformly cylindrical cable. Variations in the diameter could effect sealing.

Neptune Circular

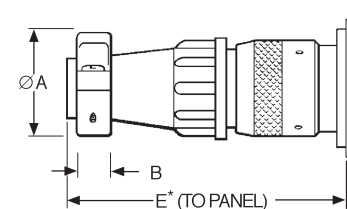
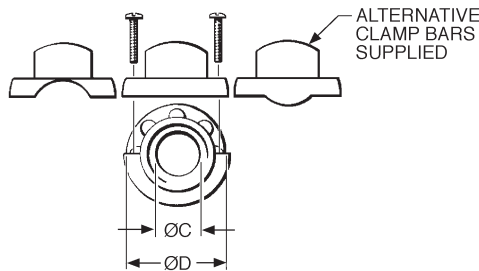

\* For disassembly, add 9,00 (.354) for shell sizes 14 and 16 and add 10,60 (.417) for shell size 24.

### Unsealed Cable Clamps For Use With Neptune Circular Connectors

- Provides strain relief and wire protection.
- For use with discrete wires or jacketed cables.
- For assembly instructions, see page 59.

Shell Size	Part Number	Nomenclature	ØA max.	B	ØC max.	ØD	E max.
14	192900-0286	TNA 14 CCSR-00L	27,00 (1.063)	6,40 (.251)	13,80 (.543)	27,00 (1.063)	67,10 (2.641)
16	192900-0343	TNA 16 CCSR-00L	30,10 (1.185)	6,40 (.251)	17,00 (.669)	30,20 (1.189)	67,10 (2.641)
24	192900-0344	TNA 24 CCSR-00L	41,80 (1.645)	8,20 (.322)	28,00 (1.102)	42,50 (1.673)	90,80 (3.574)



Dimensions shown in mm (inch)  
Specifications and dimensions subject to change

www.ittcannon.com

# Cannon Trident Connector System

Neptune Circular Connectors



## Adapters

### Type 1

Adapters facilitate the fitting of various accessories to the Neptune housings.

- External threads for use with conduit.

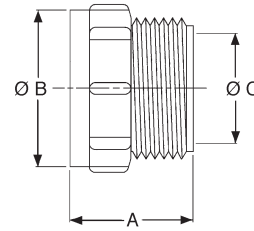

Shell Size	Part Number	Nomenclature	A	ØB	ØC
24	192900-0184	TNA 24 CA01-20L	52,80 (2.078)	40,50 (1.594)	31,80 (1.252)
24	192900-0185	TNA 24 CA01-25L	39,00 (1.535)	40,50 (1.594)	41,00 (1.614)
16	192900-0187	TNA 16 CA01-20L	35,00 (1.378)	28,00 (1.102)	31,80 (1.252)



### Type 2

Adapters facilitate the fitting of various accessories to the Neptune housings.

- External grooves for heat shrink tubing or conduit "push-fit" onto the adapter.
- Standard type is recommended for sealed connections to the adapter.
- Drain hole type is recommended for non sealed connections. E.g. split conduit.

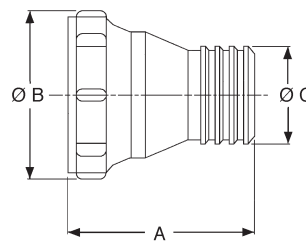

Standard Type

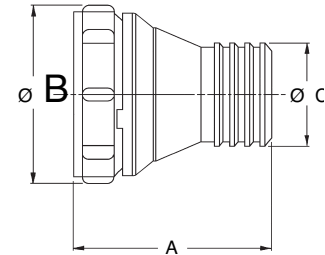

Drain Hole Type

Shell Size	Figure	Part Number	Nomenclature	A	ØB	ØC
24	1	192991-0013	TNA 24 CA02-26L	48,20 (1.897)	43,40 (1.708)	24,00 (.945)
24	2	192900-0654	TNA 24 CA22-26L	48,20 (1.897)	43,40 (1.708)	24,00 (.945)
16	1	192991-0015	TNA 16 CA02-18L	37,80 (1.488)	27,50 (1.082)	17,40 (.685)
16	2	192900-0674	TNA 16 CA22-18L	37,80 (1.488)	29,0 (1.14)	17,40 (.685)



### Type 3

Adapters facilitate the fitting of various accessories to the Neptune housings.

- For use with a 90° elbow.
- External threads for use with conduit.

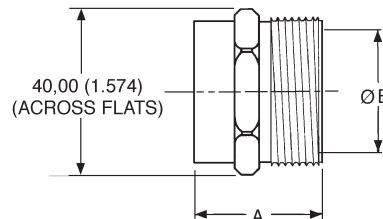

Shell Size	Part Number	Nomenclature	A	ØB
24	192900-0226	TNA 24 CA03-34L	36,50 (1.437)	34,70 (1.366)

Dimensions shown in mm (inch)  
Specifications and dimensions subject to change

www.ittcannon.com





## Blanking Plugs

- Blanking plugs are used to repair damaged seals. If the membrane seal is pierced in a position that is not normally used, then the blanking plug will restore the seal.

Note: Replacement membrane seals are also available. Contact ITT for details.

### Blanking Plugs for Signal Cavities

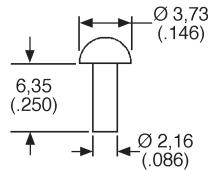

**Part Number  
(Pack of 1000)**  
192991-0018

### Blanking Plugs for Power Cavities

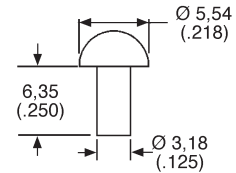

**Part Number  
(Pack of 1000)**  
192991-0019



## Discriminating (Keying) Pins

- Discriminating (keying) pins are used to prevent cross-mating of similar connectors. These pins are used in place of a pin contact. The corresponding socket cavity must be left open. If a socket contact is present the discriminating pin will prevent mating.
- The discriminating pin is installed from the mating side of the connector.

### Discriminating Pin Insertion

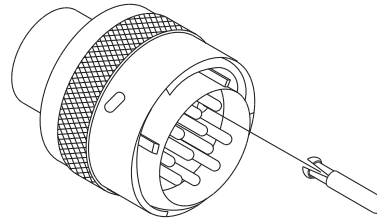

### Prevents Cross - Mating

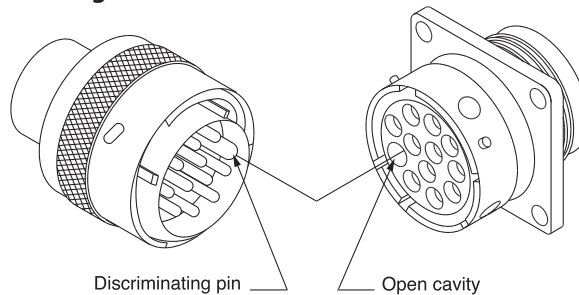

Pin Type	Part Number (Pack of 25)
Signal	192990-0000
Power	192900-0189



## Spare Jam Nuts

- Jam nut receptacles are packaged with the jam nut included.

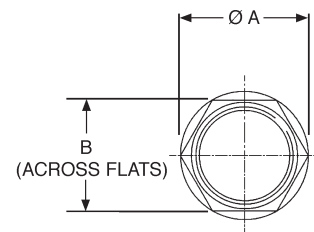
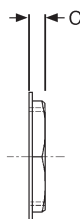

Shell Size	Part Number (Pack of 100)	ØA max.	B Nom	C
14	192900-0489	36,00 (1.417)	31,00 (1.220)	6,00 (.236)
16	192900-0488	40,60 (1.598)	35,00 (1.378)	6,00 (.236)
24	192900-0487	56,80 (2.236)	49,00 (1.929)	7,00 (.275)



Dimensions shown in mm (inch)  
Specifications and dimensions subject to change

www.ittcannon.com





**Plug Dust Cap**

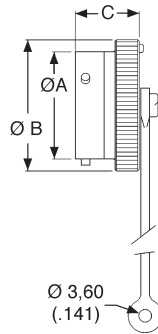

**Receptacle Dust Cap**

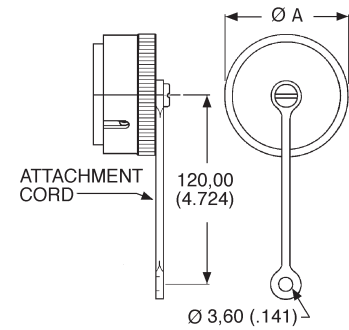

## Dust Caps

Plastic Dust Caps are available for both plugs and receptacles. It is immaterial whether these are standard or reversed types, only the shell size matters in determining the correct item.

Shell Size	Part Number (Pack of 100)	ØA	ØB	C
16	192900-0388	25,40 (1.000)	31,70 (1.248)	14,30 (.562)
24	192900-0392	38,10 (1.500)	44,40 (1.748)	16,70 (.657)

Shell Size	Part Number (Pack of 100)	ØA
14	192900-0678	28,60 (1.126)
16	192900-0679	31,70 (1.248)
24	192900-0683	44,40 (1.748)

**Flange Type**

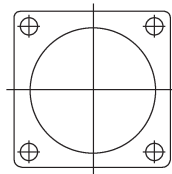

**Jam Nut type**

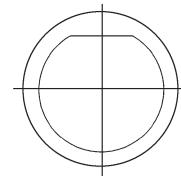

## Panel Gaskets

- All panel gaskets are 1,50 (.059) thick.
- Bulk packaged. Sold in packs of 100.

Shell Size	Part Number (Pack of 100)
14	192900-0565
16	192900-0566
24	192900-0687

Shell Size	Part Number (Pack of 100)
14	192900-0457
16	192900-0402
24	192900-0458



TNM (Trident/Neptune Metal) is specifically designed to meet the needs of systems that require shielding, sealing, and the extra durability of a metal shell. The combination of Trident contacts, membrane seals, and the Universal Shielded Endbell\* make TNM both cost effective and easy to assemble.

## Applications

- Communication equipment.
- Industrial electronics.
- Heavy duty equipment.



\*Patent pending

## Product Features

- Accepts Trident signal, printed circuit, and coaxial contacts.
- Mixed signal and 30 A power contact version.
- Can be sealed to IP67.
- 360° shielding.
- Easy to assemble.

## Performance Specifications

<b>Temperature Range</b>	-55°C to 105°C (-67°F to 221°F)
<b>Operating Voltage</b>	250 V ac
<b>Test Voltage</b>	2000 V ac rms
<b>Insulation Resistance</b>	5000 MΩ min. at 500 V dc
<b>Current Rating (Single Contact)</b>	13 A or 6 A signal contacts (crimp), 30 A power contacts
<b>Sealing (Sealed Version)</b>	Up to IP67

## Materials and Finishes

Description	Material	Finish
Shell	High Specification Zinc Alloy	Nickel
Insulator	Nylon, UL 94V-0	None
Coupling Ring	Brass	Nickel
Seal	Rubber	None

## TNM Connectors

TNM features nickel plated zinc alloy shells and UL 94V-0 rated thermoplastic insulators. All TNM receptacles are supplied with an interface seal to provide sealing between connectors to IP67. In addition a membrane seal is available for those applications requiring the sealing of discrete wires at the rear of the connector.

In order to seal multicore jacketed cables to connectors an endbell is available. This has 'O' ring sealing to the connector and a second seal to the cable jacket.

- Available unsealed or sealed to IP67.
- Highly reliable Bayonet Coupling System.
- See pages 40-41 for part numbers and additional information.



## Universal Endbell

The Universal Endbell provides sealing, shielding and strain relief in an easy to assemble system.

- 360° shielding.
- Sealed to IP67.
- Provides strain relief.
- Easy to assemble.
- See page 44 for part numbers and additional information.



TNM  
Circular

## Contact Cavity Arrangements

### Mating Face View

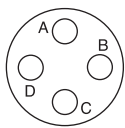

**0-04**  
Shell Size 10  
4 Signal  
0 Power

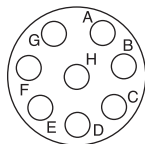

**0-08**  
Shell Size 12  
8 Signal  
0 Power

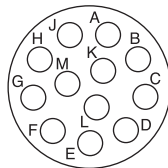

**0-12**  
Shell Size 14  
12 Signal  
0 Power

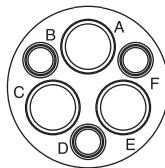

**3-3**  
Shell Size 14  
3 Signal  
3 Power

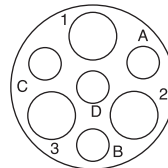

**3-04**  
Shell Size 14  
4 Signal  
3 Power

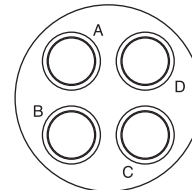

**4-0**  
Shell Size 16  
0 Signal  
4 Power

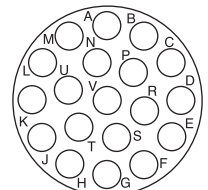

**0-19**  
Shell Size 16  
19 Signal  
0 Power

Wire sealing range 1,70 to 2,70 (.066 to .106)

Dimensions shown in mm (inch)  
Specifications and dimensions subject to change

[www.ittcannon.com](http://www.ittcannon.com)



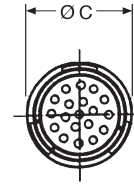
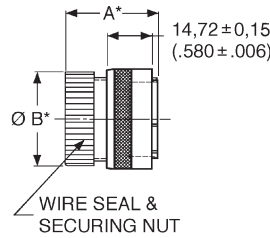

## Standard Plugs — Pin Contacts

### Standard Plug

#### Part Numbers — with wire seal

Number of Contacts	Shell Size	Part Number	Nomenclature	A	ØB	ØC
4	10	192993-0011	TNM 6S 1000-04 P1L	42,50 (1.673)	17,50 (.689)	21,60 (.850)
8	12	192993-0012	TNM 6S 1200-08 P1L	42,50 (1.673)	20,60 (.811)	24,80 (.976)
3-4	14	192993-0695	TNM 6S 1403-04 P1L	42,50 (1.673)	24,30 (.957)	28,00 (1.102)
12	14	192993-0013	TNM 6S 1400-12 P1L	42,50 (1.673)	24,30 (.957)	28,00 (1.102)
19	16	192993-0014	TNM 6S 1600-19 P1L	42,50 (1.673)	27,00 (1.063)	31,20 (1.229)

#### Part Numbers — without wire seal and securing nut ♦

Number of Contacts	Shell Size	Part Number	Nomenclature	A*	ØB*	ØC
4	10	192993-0001	TNM 6U 1000-04 P1L	38,10 (1.500)	13,80 (.543)	21,60 (.850)
8	12	192993-0002	TNM 6U 1200-08 P1L	38,10 (1.500)	16,90 (.665)	24,80 (.976)
12	14	192993-0003	TNM 6U 1400-12 P1L	38,10 (1.500)	20,10 (.791)	28,00 (1.102)
19	16	192993-0004	TNM 6U 1600-19 P1L	38,10 (1.500)	23,30 (.917)	31,20 (1.229)

\* Dimensions A and B apply to connectors without wire seals and securing nuts.

♦ Can be sealed to IP67 with a sealed endbell, see page 42.

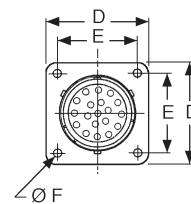
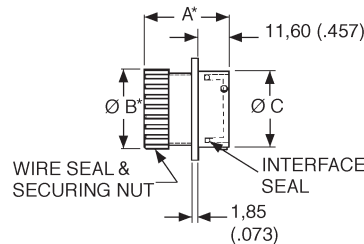

### Panel Cutout

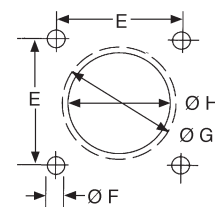

ØH = Flange in Front of Panel  
ØG = Flange at Rear of Panel

## Standard Receptacles — Socket Contacts

### Standard Receptacle

#### Part Numbers — with wire seal

No. of Contacts	Shell Size	Part Number	Nomenclature	A	ØB	ØC	D	E	ØF	ØG	ØH
4	10	192993-0031	TNM OS 1000-04 S1L	34,70 (1.366)	17,50 (.689)	14,92 (.563)	23,79 (.937)	18,26 (.719)	3,20 (.126)	17,30 (.681)	15,10 (.594)
8	12	192993-0032	TNM OS 1200-08 S1L	34,70 (1.366)	20,60 (.811)	18,98 (.747)	26,15 (1.030)	20,62 (.812)	3,20 (.126)	21,80 (.858)	18,20 (.717)
3-4	14	192993-0698	TNM OS 1403-04 S1L	34,70 (1.366)	24,30 (.957)	22,16 (.872)	28,54 (1.124)	22,80 (.898)	3,50 (.138)	25,00 (.984)	21,40 (.843)
12	14	192993-0033	TNM OS 1400-12 S1L	34,70 (1.366)	24,30 (.957)	22,16 (.872)	28,54 (1.124)	22,80 (.898)	3,50 (.138)	25,00 (.984)	21,40 (.843)
19	16	192993-0034	TNM OS 1600-19 S1L	34,70 (1.366)	27,00 (1.063)	25,33 (.997)	30,89 (1.216)	24,61 (.969)	3,50 (.138)	28,10 (1.106)	24,60 (.969)

#### Part Numbers — without wire seal and securing nut ♦

No. of Contacts	Shell Size	Part Number	Nomenclature	A*	ØB*	ØC	D	E	ØF	ØG	ØH
4	10	192993-0021	TNM OU 1000-04 S1L	30,30 (1.193)	14,30 (.563)	14,92 (.563)	23,79 (.937)	18,26 (.719)	3,20 (.126)	17,30 (.681)	15,10 (.594)
8	12	192993-0022	TNM OU 1200-08 S1L	30,30 (1.193)	17,40 (.685)	18,98 (.747)	26,15 (1.030)	20,62 (.812)	3,20 (.126)	21,80 (.858)	18,20 (.717)
12	14	192993-0023	TNM OU 1400-12 S1L	30,30 (1.193)	20,60 (.811)	22,16 (.872)	28,54 (1.124)	22,80 (.898)	3,50 (.138)	25,00 (.984)	21,40 (.843)
19	16	192993-0024	TNM OU 1600-19 S1L	30,30 (1.193)	23,80 (.937)	25,33 (.997)	30,89 (1.216)	24,61 (.969)	3,50 (.138)	28,10 (1.106)	24,60 (.969)

\* Dimensions A and B apply to connectors without wire seals and securing nuts.

♦ Can be sealed to IP67 with a sealed endbell, see page 42.



Dimensions shown in mm (inch)  
Specifications and dimensions subject to change

www.ittcannon.com

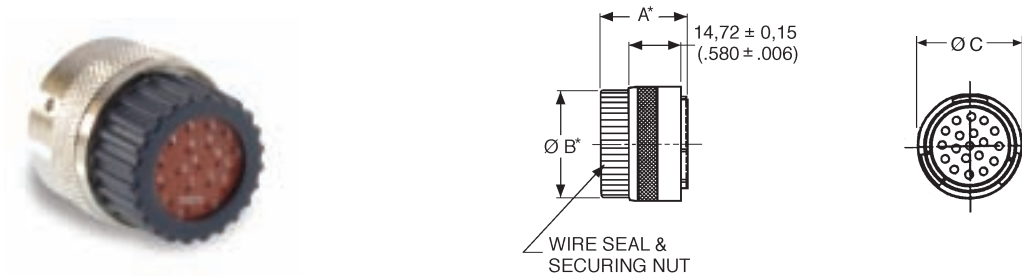

## Reversed Plugs — Socket Contacts

### Reversed Plug

#### Part Numbers — with wire seal

Number of Contacts	Shell Size	Part Number	Nomenclature	A	ØB	ØC
4	10	192993-0051	TNM 6S 1000-04 S1L	34,20 (1.346)	17,50 (.689)	21,60 (.850)
8	12	192993-0052	TNM 6S 1200-08 S1L	34,20 (1.346)	20,60 (.811)	24,80 (.976)
3-4	14	192993-0696	TNM 6S 1403-04 S1L	34,20 (1.346)	24,30 (.957)	28,00 (1.102)
12	14	192993-0053	TNM 6S 1400-12 S1L	34,20 (1.346)	24,30 (.957)	28,00 (1.102)
19	16	192993-0054	TNM 6S 1600-19 S1L	34,20 (1.346)	27,00 (1.063)	31,20 (1.229)

#### Part Numbers — without wire seal and securing nut

Number of Contacts	Shell Size	Part Number	Nomenclature	A*	ØB*	ØC
4	10	192993-0041	TNM 6U 1000-04 S1L	29,80 (1.173)	13,80 (.543)	21,60 (.850)
8	12	192993-0042	TNM 6U 1200-08 S1L	29,80 (1.173)	16,90 (.665)	24,80 (.976)
12	14	192993-0043	TNM 6U 1400-12 S1L	29,80 (1.173)	20,10 (.791)	28,00 (1.102)
19	16	192993-0044	TNM 6U 1600-19 S1L	29,80 (1.173)	23,30 (.917)	31,20 (1.229)

\* Dimensions A and B apply to connectors without wire seals and securing nuts.

◆ Can be sealed to IP67 with a sealed endbell, see page 42.

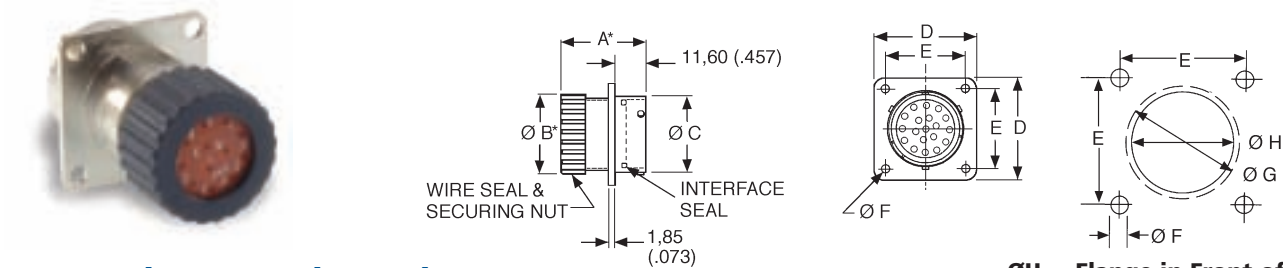

### Panel Cutout

ØH = Flange in Front of Panel  
ØG = Flange at Rear of Panel

## Reversed Receptacles— Pin Contacts

### Reversed Receptacle

#### Part Numbers — with wire seal

No. of Contacts	Shell Size	Part Number	Nomenclature	A	ØB	ØC	D	E	ØF	ØG	ØH
4	10	192993-0071	TNM 0S 1000-04 P1L	43,00 (1.693)	17,50 (.689)	14,92 (.563)	23,79 (.937)	18,26 (.719)	3,20 (.126)	17,30 (.681)	15,10 (.594)
8	12	192993-0072	TNM 0S 1200-08 P1L	43,00 (1.693)	20,60 (.811)	18,98 (.747)	26,15 (1.030)	20,62 (.812)	3,20 (.126)	21,80 (.858)	18,20 (.717)
7	14	192993-0697	TNM 0S 1403-04 P1L	43,00 (1.693)	24,30 (.957)	22,16 (.872)	28,54 (1.124)	22,80 (.898)	3,50 (.138)	25,00 (.984)	21,40 (.843)
12	14	192993-0073	TNM 0S 1400-12 P1L	43,00 (1.693)	24,30 (.957)	22,16 (.872)	28,54 (1.124)	22,80 (.898)	3,50 (.138)	25,00 (.984)	21,40 (.843)
19	16	192993-0074	TNM 0S 1600-19 P1L	43,00 (1.693)	27,00 (1.063)	25,33 (.997)	30,89 (1.216)	24,61 (.969)	3,50 (.138)	28,10 (1.106)	24,60 (.969)

#### Part Numbers — without wire seal and securing nut

No. of Contacts	Shell Size	Part Number	Nomenclature	A*	ØB*	ØC	D	E	ØF	ØG	ØH
4	10	192993-0061	TNM 0U 1000-04 P1L	38,60 (1.520)	14,30 (.563)	14,92 (.563)	23,79 (.937)	18,26 (.719)	3,20 (.126)	17,30 (.681)	15,10 (.594)
8	12	192993-0062	TNM 0U 1200-08 P1L	38,60 (1.520)	17,40 (.685)	18,98 (.747)	26,15 (1.030)	20,62 (.812)	3,20 (.126)	21,80 (.858)	18,20 (.717)
12	14	192993-0063	TNM 0U 1400-12 P1L	38,60 (1.520)	20,60 (.811)	22,16 (.872)	28,54 (1.124)	22,80 (.898)	3,50 (.138)	25,00 (.984)	21,40 (.843)
19	16	192993-0064	TNM 0U 1600-19 P1L	38,60 (1.520)	23,80 (.937)	25,33 (.997)	30,89 (1.216)	24,61 (.969)	3,50 (.138)	28,10 (1.106)	24,60 (.969)

\* Dimensions A and B apply to connectors without wire seals and securing nuts.

◆ Can be sealed to IP67 with a sealed endbell, see page 42.

Dimensions shown in mm (inch)

Specifications and dimensions subject to change

www.ittcannon.com



TNM  
Circular

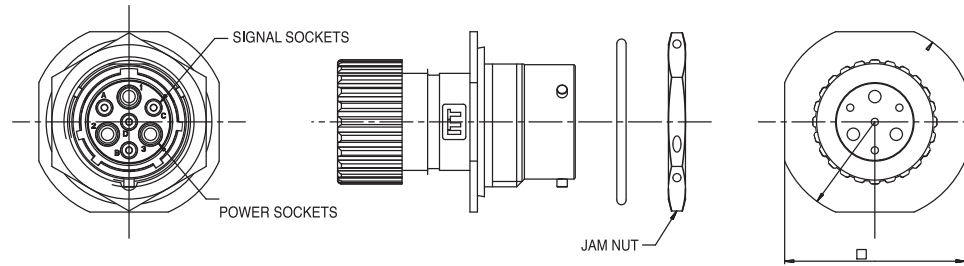

Panel Cutout

## Jam Nut Receptacles

- Mates with Standard and Reversed Plugs, see pages 40-41

Type	Number of Contacts	Shell Size	Part Number	Nomenclature	A	B	C	ØD	ØE	ØF	ØG
Standard	3-04	14	192993-0700	TNM 75 1403045S1L	50,00 (1.968)	2,80 (.110)	17,60 (.692)	22,20 (.874)	24,30 (.956)	38,09 (1,500)	34,90(1.374)
Reversed	3-04	14	192993-0699	TNM 75 1403045P1L	50,00 (1.968)	2,80 (.110)	17,60 (.692)	22,20 (.874)	24,30 (.956)	38,09 (1,500)	34,90(1.374)

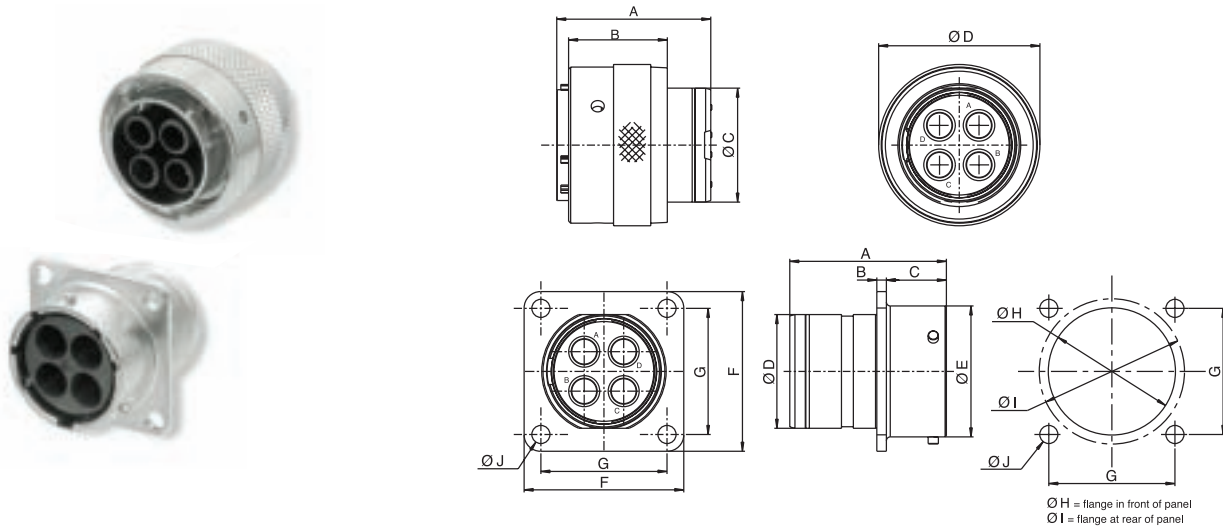

## Four Way Power Connector

This connector was developed for use on servomotors where high currents and high voltages are used

- Uses Cannon D Subminiature power contacts.
- Voltage rating 40A.
- Current rating 40A.
- Earth contact version available.
- Short receptacle to save space.

Type	No. of Contacts	Shell Size	Part Number	Nomenclature	A	B	C	D	E	F	G	H	I	J
Reversed Receptacle	4	16	192993-0106	TNM192993-106	30.3	1.85	11.6	23.7	25.33	30.9	24.4	24.6	28.1	3.5
Reversed Plug	4	16	192993-0105	TNM192993-105	29.8	19.1	23.2	31.2						



Dimensions shown in mm (inch)  
Specifications and dimensions subject to change

www.ittcannon.com

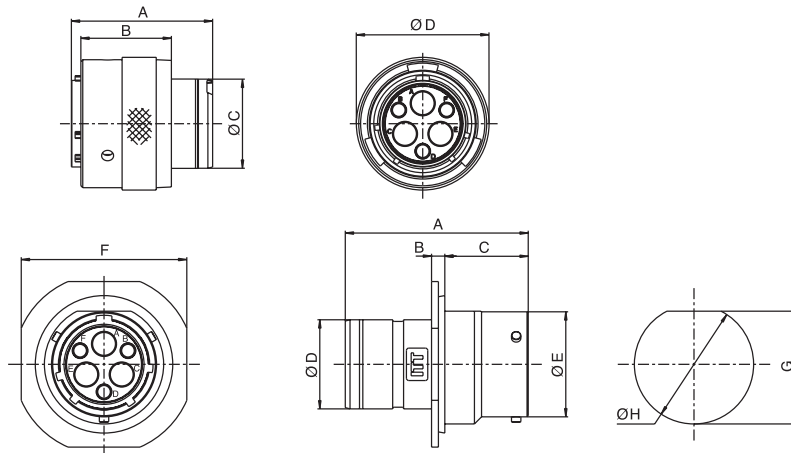

## 3-3 Connector

Designed for use as an antenna connector, this design incorporates D Subminiature power contacts and standard Trident signal contacts.

- Can terminate wire sizes up to 8 AWG (10mm<sup>2</sup>)
- Large cables with outside diameters up to 16,00 (.630) diameter can be accommodated.

For more information, please contact your local Cannon sales office.

Type	Number of Contacts	Shell Size	Part Number	A	B	C	D	E	F	G	H
Standard Receptacle Pin	6	14	192993-2013	38.6	2.8	17.6	18.8	22.16	34.9	24.2	25.8
Standard Plug Socket	6	14	192993-0261	29.8	19.1	18.85	28				

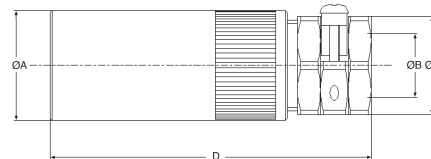

## Shielded Endbell for Larger Cable Sizes

- Metal body with plastic cable clamp.
- For assembly instructions, see page 61.
- For use with jacketed cables.

Shell Size	Part Number	Nomenclature	Cable Accommodation		ØAmax.	ØB min.	ØB max.	ØC	ØD max.
			Outer Sheath Diameter						
			Minimum	Maximum					
10	192993-0091	TNA 10CC-SE01L	5,00 (.196)	10,00 (.393)	18,10 (.712)	5,00 (.196)	10,00 (.393)	19,00 (.748)	70,00 (2.755)
12	192993-0092	TNA 12CC-SE01L	6,00 (.236)	12,00 (.472)	21,20 (.834)	6,00 (.236)	12,00 (.472)	21,00 (.826)	72,00 (2.834)
14	192993-0093	TNA 14CC-SE01L	7,00 (.275)	14,00 (.551)	24,20 (.952)	7,00 (.275)	14,00 (.551)	23,00 (.905)	78,00 (3.070)
16	192993-0094	TNA 16CC-SE01L	8,00 (.314)	16,00 (.692)	27,60 (1.086)	8,00 (.314)	16,00 (.629)	25,00 (.984)	82,50 (3.248)

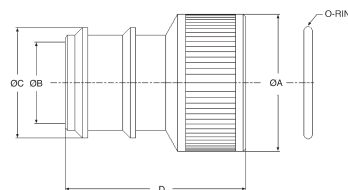

## Heat Shrink Adapter for use with TNM Circular Connectors

Shell Size	Part Number	Nomenclature	Ø Amax.	ØB min.	ØC	ØDmax
10	192993-0631	TNA 10HSAD 00L	18,10 (.712)	10,20 (.401)	16,00 (.629)	35,50 (1.397)
12	192993-0632	TNA 12HSAD 00L	21,20 (.834)	12,20 (.480)	18,00 (.708)	36,00 (1.417)
14	192993-0633	TNA 14HSAD 00L	24,20 (.952)	14,20 (.559)	20,00 (.787)	36,00 (1.417)
16	192993-0634	TNA 16HSAD 00L	27,60 (1.086)	16,30 (.641)	22,00 (.866)	36,50 (1.437)

Dimensions shown in mm (inch)  
Specifications and dimensions subject to change

www.ittcannon.com







## Universal Shielded Endbell\*

In order to meet EMC requirements it will be necessary to fit a shielded endbell to the TNM connectors. The TNM Shielded Endbell provides sealing to the connector shell, a cable braid grip and sealing to the outer sheath of the cable. Sealing rating is IP67.

Shielded endbells are used with unsealed plugs and receptacles.

## Materials and Finishes

Description	Material/Finish
Housing	Aluminum/Nickel
Grounding Ring	Aluminum/Nickel
Clamp Nut	Aluminum/Nickel
Cable Grip	Nylon, UL 94V-0
Support Sleeve	Nylon, UL 94V-0
O-Ring	Rubber
Cable Seal	Rubber

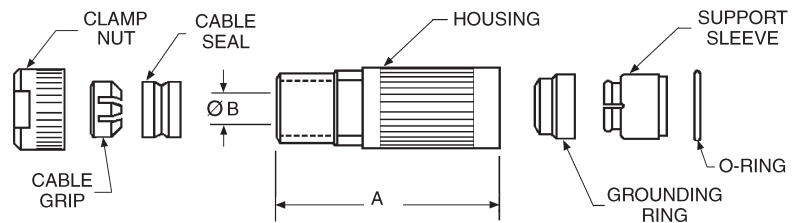
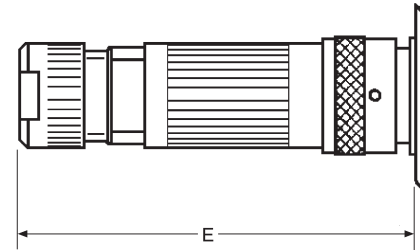
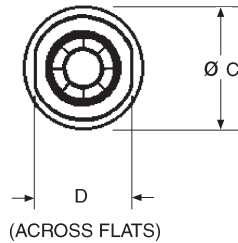

For assembly instruction, see page 58.

### Dimensions

Shell Size	Part Number	Nomenclature	A	ØB	ØC	D	E max.	
							Standard Format	Reversed Format
10	192993-0081	TNA 10 CCSE00L	56,60 (2.228)	8,00 (.315)	17,90 (.705)	13,00 (.512)	88,50 (3.484)	80,00 (3.150)
12	192993-0082	TNA 12 CCSE00L	56,70 (2.320)	10,00 (.394)	21,00 (.827)	16,00 (.630)	88,50 (3.484)	80,00 (3.150)
14	192993-0083	TNA 14 CCSE00L	57,00 (2.441)	11,30 (.449)	24,00 (.945)	19,00 (.748)	88,50 (3.484)	80,00 (3.150)
16	192993-0084	TNA 16 CCSE00L	57,40 (2.260)	13,60 (.535)	27,40 (1.079)	22,00 (.886)	88,50 (3.484)	80,00 (3.150)

\*Patent Pending

## Cables

The TNM Shielded Endbell covers a wide range of multicore cable used in industrial applications. The following table indicates the sizes that can be accommodated provided the outside sheath diameter is within the accommodation range shown.

For detail of contacts, see page 47.

Shielded cable to Endbell Assembly Instructions are supplied with the Endbell piece parts kit.

Endbell Shell Size	Number of Contacts	Cable Accommodation Outer Sheath Size	
		Minimum	Maximum
10	4	4,40 (.173)	7,30 (.287)
12	8	6,40 (.252)	9,50 (.374)
14	12	6,90 (.272)	10,20 (.402)
16	19	7,90 (.311)	12,60 (.496)



Dimensions shown in mm (inch)  
Specifications and dimensions subject to change

www.ittcannon.com





## Sealed Cable Clamps for use with TNM Circular Connectors

- For use with jacketed cables.
- Provides strain relief and wire protection.
- Provides sealing to IP67.
- For assembly instructions, see page 59.

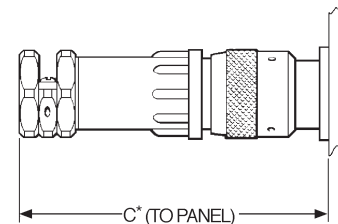
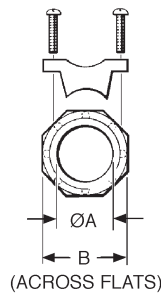

\* For disassembly, add 9,000 (.0354) for shell sizes 10-16.

### Dimensions

Shell Size	Part Number	Nomenclature	ØA max.	B	C max.	
					Standard Format	Reversed Format
10	192900-0636	TNA 10 CCHC00L	11,10 (.437)	8,70 (.740)	89,00 (3.504)	80,70 (3.177)
12	192900-0637	TNA 12 CCHC00L	13,60 (.535)	20,80 (.818)	92,00 (3.622)	83,70 (3.295)
14	192900-0496	TNA 14 CCHC00L	14,60 (.574)	22,80 (.897)	99,00 (3.898)	90,70 (3.571)
16	192900-0497	TNA 16 CCHC00L	16,60 (.653)	24,70 (.972)	103,00 (4.055)	94,70 (3.728)

\* Assumes a uniformly cylindrical cable. Variations in the diameter could effect sealing.

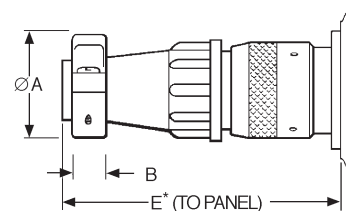
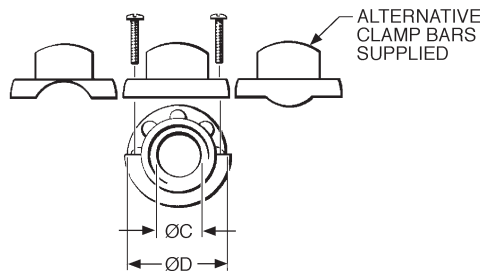

\* For disassembly, add 9,000 (.0354) for shell sizes 10-16.

## Unsealed Cable Clamps for use with TNM Circular Connectors

- Provides strain relief and wire protection.
- For use with discrete wires or jacketed cables.
- For assembly instructions, see page 59.

### Dimensions

Shell Size	Part Number	Nomenclature	ØA max.	B	ØC max.	ØD	E max.	
							Standard Format	Reversed Format
10	192900-0639	TNA 10 CCSR00L	21,50 (.846)	6,40 (.251)	8,70 (.342)	21,00 (.826)	74,50 (2.933)	66,20 (2.606)
12	192900-0640	TNA 12 CCSR00L	24,90 (.980)	6,40 (.251)	12,80 (.503)	24,00 (.944)	74,50 (2.933)	66,20 (2.606)
14	192900-0286	TNA 14 CCSR00L	27,00 (1.063)	6,40 (.251)	13,80 (.543)	27,00 (1.063)	80,50 (3.169)	71,80 (2.826)
16	192900-0343	TNA 16 CCSR00L	30,10 (1.185)	6,40 (.251)	17,00 (.669)	30,20 (1.189)	80,50 (3.169)	71,80 (2.826)

Dimensions shown in mm (inch)  
Specifications and dimensions subject to change

www.ittcannon.com



General recommendations for the selection of Trident contacts are listed below.

**Platings:** Tin is recommended for most applications. It is cost effective and matches well to most wires. Gold is preferred for special situations. Gold resists oxidation, has high surface conductivity, and has a low coefficient of friction. These features make gold the preferred plating for low level signals (a rule of thumb is <100 mA), corrosive environments (for unsealed connectors), and for increased mating cycles. The electrical performance of the contact is determined at the surface of the contact. For this reason, flash gold platings are suitable for applications with 50 or fewer mating cycles. Thicker gold platings are recommended for more than 50 mating cycles.

**Stamped versus Machined:** The two part stamped contacts are manufactured to precise tolerances and are field proven. They can be supplied on reels which lowers assembly costs for volume



production. Machined contacts offer improved precision and durability. They are recommended for applications with more than 200 mating cycles.

**Crimp versus Solder:** Crimp contacts offer improved electrical performance, strain relief and quality control compared to solder cup contacts. Solder cups contacts are recommended for low

volume and prototype applications where the added cost of crimp tools is not justified.

**High Conductivity:** These contacts use a different base material than the standard contacts. They are recommended for high current applications. These contacts will also reduce the derating of connectors with several high current lines.

## Contact Performance Data

Characteristics	Formed (Stamped)		Machined	Solder Cup	Flow Solder (PCB)	30 A Power	Coaxial
	Standard	High Conductivity					
Body Material	Brass	Copper Alloy	Brass	Brass	Brass	Copper Alloy	Brass
Retention	Brass	Brass	Beryllium	Beryllium	Beryllium	Stainless Steel	Beryllium
Spring Material			Copper	Copper	Copper		Copper
Contact Retention (minimum)	67 N	67 N	67 N	67 N	67 N	100 N	67 N
Current Rating	13 A	16 A	13 A	13 A	13 A	30 A	N/A
Contact Resistance (initial)	5 mΩ	5 mΩ	5 mΩ	5 mΩ	5 mΩ	2.5 mΩ	2.5 m
Mechanical Endurance (minimum)	200 Insertions	200 Insertions	500 Insertions	500 Insertions	500 Insertions	200 Insertions	200 Insertions

For Tooling and Assembly instructions, see pages 51-58.

## Temperature/Current Rating

### 30°C Temperature Rise

- Derived in accordance with IEC 512-3, Test 5b.
- Figures are for maximum wire sizes. Smaller wires will reduce rating.
- All contacts equally loaded.
- PCB mounted connectors will be limited by PCB performance.
- Bunched cables will further reduce values.
- Cable insulation type will affect temperature and loading.
- Figures are for maximum connector sizes in each range. Smaller connectors will increase rating.

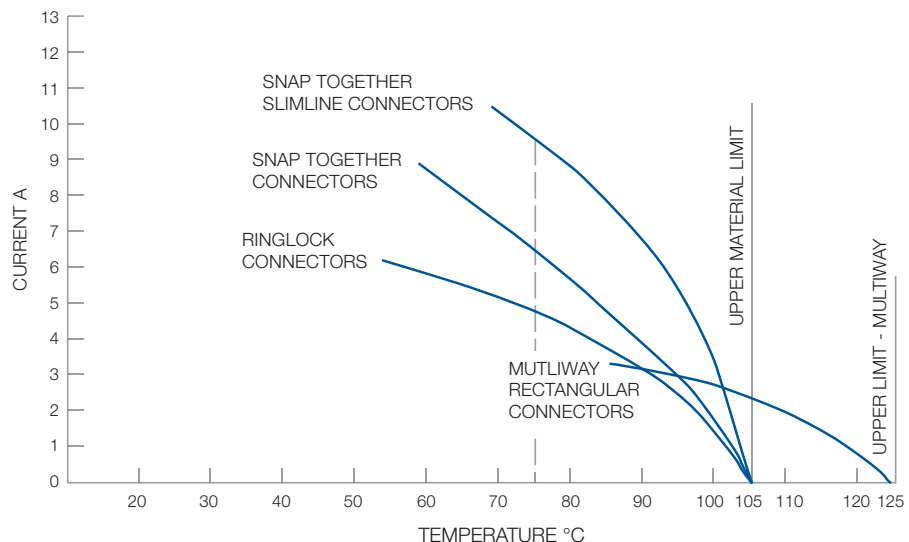

Dimensions shown in mm (inch)  
Specifications and dimensions subject to change

www.ittcannon.com



## Contact Selection Guide

### Formed (Stamped) Crimp Contacts



- Tin and gold plating available.
- Up to 200 mating cycles.
- Up to 13 A - Standard Contacts.  
16 A - High Conductivity Contacts.
- Supports 14 AWG to 26 AWG wires.
- Brass and high conductivity material available.
- Full support tooling available.

For Part Numbers and Details, see page 46.

### Machined Crimp Contacts



- Tin and gold plating available.
- Up to 500 mating cycles.
- Up to 13 A.
- Supports 16 AWG to 26 AWG wires.
- Full support tooling available.
- Earthing (First Mate/Last Break) versions available.

For Part Numbers and Details, see page 47.

### Solder Cup Contacts

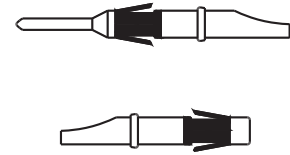

- Tin plating.
- Supports 14 AWG to 26 AWG wires.
- Ideal for prototypes and low volume production.
- Up to 13 A.

For Part Numbers and Details, see page 48.

### Flow Solder (PCB) Contacts



- Tin and gold plating available.
- Signal and Power versions available (13 A or 30 A).
- For use with the Multiway, Ringlock, and Neptune ranges.

For Part Numbers and Details, see page 48.

### 30 A Power Contacts

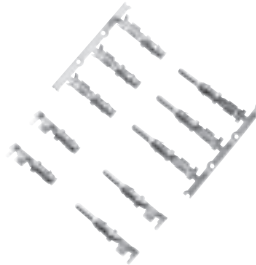

- Tin plating.
- For use with the Neptune Circular Connectors.
- Full support tooling available.
- High conductivity material.

For Part Numbers and Details, see page 48.

### Coaxial Contacts

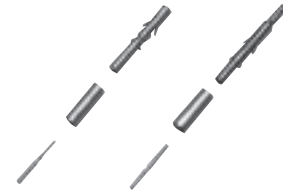

- Fits into standard Trident contact cavities.
- Up to 200 mating cycles.
- Full support tooling available.
- Supports a wide range of twisted pair and coaxial cables.

For Part Numbers and Details, see pages 49-50.

## Connector/Contact Compatibility

Connector Series	Contacts					
	Formed (Stamped) Crimp	Machined Crimp	Solder Cup	Flow Solder (PCB)	30 A Power	Coaxial
Snap Together & Slimline	•	•	•	•*	—	•
Multiway	•	•	•	•	—	•
Ringlock	•	•	•	•	—	•
Neptune	•	•	•	•	•	•
TNM	•	•	•	—	—	•

• = Compatible  
 \* = Printed circuit contacts are pre-installed in Snap Together & Slimline connectors.  
 For wire wrap contacts, contact Cannon.  
 For discriminating (keying) pins, see page 50.

Dimensions shown in mm (inch)  
 Specifications and dimensions subject to change

www.ittcannon.com



### Formed (Stamped) Crimp Contacts — Standard Brass Material

- 13 A current rating.
- Three plating styles available.
- Separate retention spring.
- Up to 200 mating cycles.
- Wide range of wire sizes.
- Full support tooling available, see page 53.
- Two part design.



**Size 14 to 16 AWG,  
No Insulation Grip**

**Size 16 to 26 AWG,  
Insulation Grip**

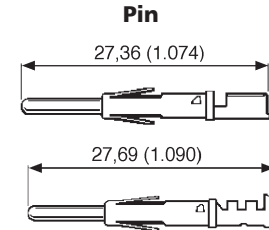
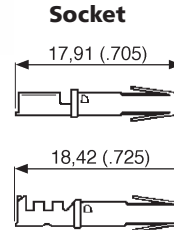

Contact	Part Number Pack (100)			Part Number Reeled (3000)			Wire Range mm2	Wire Size	Insulation Diameter	Strip Length
	Tin Plating	Gold Flash	Gold Plating	Tin Plating	Gold Flash	Gold Plating				
Pin	192990-0020	192990-0080	192900-0448	192990-2510	192990-2650	192900-0406	0,08 - 0,25	26-24 AWG	0,89 (.035) - 1,58 (.062)	3,95 (.155)±0,25(.009)
Socket	192990-0030	192990-0090	192900-0452	192990-2550	192990-2690	192900-0410	0,08 - 0,25	26-24 AWG	0,89 (.035) - 1,58 (.062)	3,95 (.155)±0,25(.009)
Pin	192990-0040	192922-1460	192900-0447	192990-2500	192990-2640	192900-0405	0,30 - 0,50	22-20 AWG	1,17 (.046) - 2,08 (.081)	3,95 (.155)±0,25(.009)
Socket	192990-0050	192922-1470	192900-0451	192990-2540	192990-2680	192900-0409	0,30 - 0,50	22-20 AWG	1,17 (.046) - 2,08 (.081)	3,95 (.155)±0,25(.009)
Pin	192990-0060	192990-0100	192900-0446	192990-2490	192990-2630	192900-0404	0,75 - 1,50	18-16 AWG	2,00 (.078) - 3,00 (.118)	3,95 (.155)±0,25(.009)
Socket	192990-0070	192990-0110	192900-0450	192990-2530	192990-2670	192900-0408	0,75 - 1,50	18-16 AWG	2,00 (.078) - 3,00 (.118)	3,95 (.155)±0,25(.009)
Pin	192990-1240	192990-1220	192900-0445	192990-2480	192990-2620	192900-0403	1,50 - 2,50	16-14 AWG	Without insulation support	5,60 (.220)±0,25(.009)
Socket	192990-1250	192990-1230	192900-0449	192990-2520	192990-2660	192900-0407	1,50 - 2,50	16-14 AWG	Without insulation support	5,60 (.220)±0,25(.009)

### Formed (Stamped) Crimp Contacts — High Conductivity Material

- 16 A current rating.
- Recommended for elevated temperatures.
- High conductivity copper alloy with tin plating.
- For use with standard crimp tooling, see page 53.
- Two part design.



**Size 14 to 16 AWG,  
No Insulation Grip**

**Size 16 to 26 AWG,  
Insulation Grip**

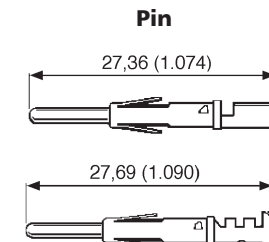
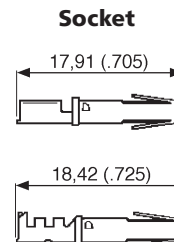

Contact	Part Number		Wire Range mm2	Wire Size	Insulation Diameter	Strip Length
	Pack (100)	Reeled (3000)				
Pin	192900-0122	192900-0120	0,08 - 0,25	26-24 AWG	0,89 (.035) - 1,58 (.062)	3,95 (.155)±0,25 (.009)
Socket	192900-0123	192900-0121	0,08 - 0,25	26-24 AWG	0,89 (.035) - 1,58 (.062)	3,95 (.155)±0,25 (.009)
Pin	192900-0126	192900-0124	0,25 - 0,50	22-20 AWG	1,17 (.046) - 2,08 (.081)	3,95 (.155)±0,25 (.009)
Socket	192900-0127	192900-0125	0,25 - 0,50	22-20 AWG	1,17 (.046) - 2,08 (.081)	3,95 (.155)±0,25 (.009)
Pin	192900-0002	192900-0000	0,75 - 1,50	18-16 AWG	2,00 (.078) - 3,00 (.118)	3,95 (.155)±0,25 (.009)
Socket	192900-0003	192900-0001	0,75 - 1,50	18-16 AWG	2,00 (.078) - 3,00 (.118)	3,95 (.155)±0,25 (.009)
Pin	192900-0005	192900-0004	1,50 - 2,50	16-14 AWG	Without insulation support	5,60 (.220)±0,25 (.009)
Socket	192900-0007	192900-0006	1,50 - 2,50	16-14 AWG	Without insulation support	5,60 (.220)±0,25 (.009)



## Machined Crimp Contacts

- 13 A current rating.
- Separate contact and retention spring.
- Up to 500 mating cycles.
- Variety of plating options.
- Full support tooling available, see page 53.



**Size 16 AWG,  
No Insulation Grip**

**Size 20 to 26 AWG,  
Insulation Grip**

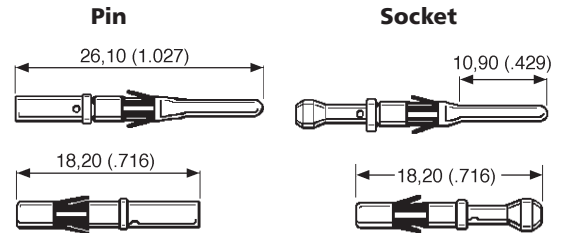

Contact	Part Number			Wire Range mm2	Wire Size	Insulation Diameter	Strip Length	Color Band
	Pack (100) Gold Plating†	Pack (100) Gold Plating*	Pack (100) Tin Plating					
Pin	192991-0101	192991-0100	192991-0102	0,08 - 0,23	26 AWG	0,90 (.035) - 1,40 (.055)	5,08 (.200)±0,25 (.009)	Black
Socket	192991-0054	192991-0042	192991-0048	0,08 - 0,23	26 AWG	0,90 (.035) - 1,40 (.055)	5,08 (.200)±0,25 (.009)	Black
Pin	192991-0093	192991-0092	192991-0094	0,20 - 0,24	24 AWG	1,05 (.041) - 1,60 (.062)	5,08 (.200)±0,25 (.009)	Blue
Socket	192991-0055	192991-0043	192991-0049	0,20 - 0,24	24 AWG	1,05 (.041) - 1,60 (.062)	5,08 (.200)±0,25 (.009)	Blue
Pin	192991-0097	192991-0096	192991-0098	0,25 - 0,50	22 AWG	1,60 (.062) - 2,15 (.084)	5,08 (.200)±0,25 (.009)	Red
Socket	192991-0056	192991-0044	192991-0050	0,25 - 0,50	22 AWG	1,60 (.062) - 2,15 (.084)	5,08 (.200)±0,25 (.009)	Red
Pin	192991-0089	192991-0088	192991-0090	0,44 - 0,64	20 AWG	1,60 (.062) - 2,10 (.082)	5,08 (.200)±0,25 (.009)	Green
Socket	192991-0058	192991-0046	192991-0052	0,44 - 0,64	20 AWG	1,60 (.062) - 2,10 (.082)	5,08 (.200)±0,25 (.009)	Green
Pin	192991-0085	192991-0084	192991-0086	0,60 - 1,51	16 AWG	Without insulation support	7,11 (.279)±0,25 (.009)	Black
Socket	192991-0059	192991-0047	192991-0053	0,60 - 1,51	16 AWG	Without insulation support	7,11 (.279)±0,25 (.009)	Black

\* Gold plating Pin: 0,4 μ m (16 μ in.). Gold plating Socket: 0,75 μ m (30 μ in.).

† Gold plating Pin & Socket: 0,30 μ m (120 μ in.).

## Machined Earth (First Mate/Last Break) Contacts

- 13 A current rating.
- Separate contact and retention spring.
- Up to 500 mating cycles.
- Variety of plating options.
- Full support tooling available, see page 53.



**Size 16 AWG,  
No Insulation Grip**

**Size 20 to 26 AWG,  
Insulation Grip**

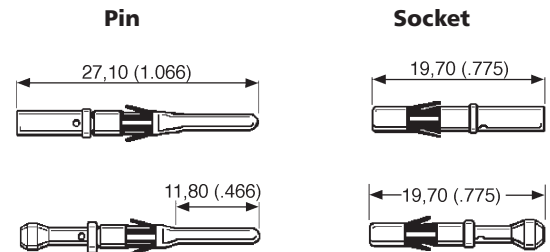

Contact	Part Number		Wire Range mm2	Wire Size	Insulation Diameter	Strip Length	Color Band
	Pack (100) Gold Plating*	Pack (100) Tin Plating					
Pin	192991-0164	192991-0160	0,44 - 0,64	20 AWG	1,60 (.062) - 2,10 (.082)	5,08 (.200)±0,25 (.009)	Green
Socket	192991-0207	192991-0208	0,44 - 0,64	20 AWG	1,60 (.062) - 2,10 (.082)	5,08 (.200)±0,25 (.009)	Green
Pin	192991-0160	192991-0160	0,60 - 1,51	16 AWG	Without insulation support	7,11 (.279)±0,25 (.009)	Black
Socket	192991-0208	192991-0208	0,60 - 1,51	16 AWG	Without insulation support	7,11 (.279)±0,25 (.009)	Black

\* Gold plating Pin: 0,4 μ m (16 μ in.). Gold plating Socket: 0,75 μ m (30 μ in.).

## Solder Cup Contacts

- 13 A current rating.
- Ideal for prototypes and small volume applications.
- Fits into all Trident connectors.
- Simple solder, then insert design. Socket/Pin.



Description	Part Number	
	Tin Plating	Gold Plating*
Socket	192900-0634	192900-0635
Pin	192900-0632	192900-0633

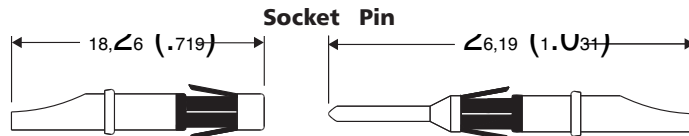

\*Gold plating 0,4 μm (16 μin.)

## Flow Solder (PCB) Contacts

- 13 A current rating.
- Available in different lengths depending on connector.
- Socket versions available.
- High Volume packaging available.
- 30 A power version available.

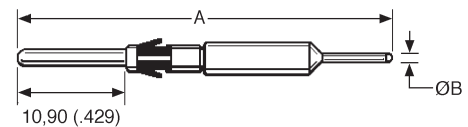

Connector Series	Part Number Pack of 100			
	Tin Plating	Gold Flash Plating	A ±1,07 (.003)	ØB
Ringlock Multiway	192991-0122	192991-0119	34,70 (1.366)	0,76 (.030)
Neptune	192900-0465	192900-0356	40,75 (1.604)	0,71 (.028)
Neptune Power**	192991-0617	192991-0618	40,60 (1.598)	1,50 (.059)

\*\* Note appearance differs slightly from the picture.

## Power Contacts

- 30 A current rating.
- For use with Neptune connectors.



Contact	Part Number		Wire Range mm2	Wire Size	Insulation Diameter	Strip Length
	Loose (100) Tin Plated	Reeled (3000) Tin Plated				
Pin	031-8717-020	121668-0000	0,50 - 1,00	20-18 AWG	1,40 (.055) - 2,00 (.078)	5,00 (.196)±0,25 (.009)
Socket	031-8717-120	121668-0100	0,50 - 1,00	20-18 AWG	1,40 (.055) - 2,00 (.078)	5,00 (.196)±0,25 (.009)
Pin	031-8717-021	121668-0001	1,50 - 2,50	16-14 AWG	2,00 (.078) - 2,90 (.114)	5,00 (.196)±0,25 (.009)
Socket	031-8717-121	121668-0101	1,50 - 2,50	16-14 AWG	2,00 (.078) - 2,90 (.114)	5,00 (.196)±0,25 (.009)
Pin	031-8717-022	121668-0002	2,50 - 4,00	14-12 AWG	2,90 (.114) - 3,60 (.141)	5,00 (.196)±0,25 (.009)
Socket	031-8717-122	121668-0102	2,50 - 4,00	14-12 AWG	2,90 (.114) - 3,60 (.141)	5,00 (.196)±0,25 (.009)



Dimensions shown in mm (inch)  
Specifications and dimensions subject to change

www.ittcannon.com

## Coaxial Contacts

- Up to 200 mating cycles.
- Fits all Trident contact cavities.
- Full range of tooling available.
- For twisted pair and coaxial cable use.
- All contact assemblies sold in packs of 100.



### Performance Specifications

Temperature Range	-55°C to 125°C
Operating Voltage	230 V dc

### Materials and Finishes

Description	Material	Finish
Inner Contact	Brass	0,75 $\mu\text{m}$ (30 $\mu$ in.) Gold
Outer Contact	Brass	0,40 $\mu\text{m}$ (16 $\mu$ in.) Gold

## Outer Female Contact Assembly

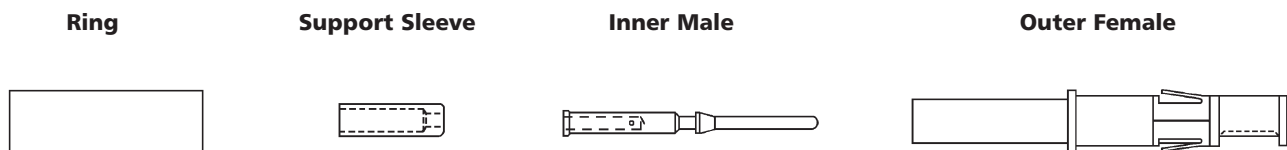

## Outer Male Contact Assembly

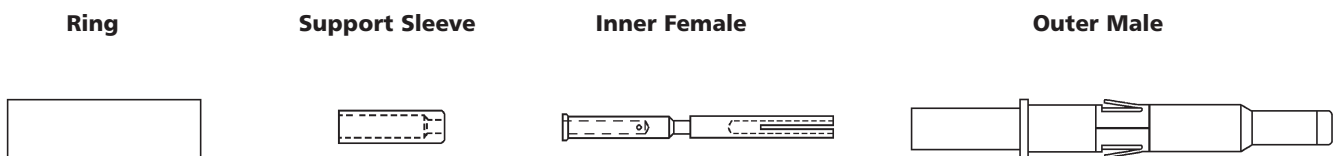

Description	Part Number (Pack of 100)	Nomenclature	Cable Type*
Outer Female Contact Assembly	192945-4380	TC1FCLY	A**
Outer Male Contact Assembly	192945-4390	TC1MCLY	A**
Outer Female Contact Assembly	192945-4930	TC2FCLY	B and Twisted Pair
Outer Male Contact Assembly	192945-4530	TC2MCLY	B and Twisted Pair

Note: Sold as complete sets. Please contact Cannon for other packaging options.  
 \*For Cable Type, see page 50.  
 \*\*Support sleeve not used.



## Coaxial Contacts — Cable Type and Cable Strip Length

### Cable Type — A

T3203	T3306	RG174
T3204	T3385	RG179
T3264	T3388	RG187
T3289	T3390	RG188
		7528A/31

### Cable Type — B

T3201	T3293	RG178
T3202	T3294	RG196
T3261	T3386	7530A/1114
T3263	UR94	5088A/1317
		LN00029
		7530D/1114
		C06C030
		LGRZ/4016

### Cable Type — Twisted Pair Insulation

Diameter	Dimension	
	X	Y
0,56 (.022) - 1,12 (.044)	4,80 (.189)	6,30 (.248)
Less than 0,56 (.022)	5,10 (.200)	13,00 (.512)

Outer Male Contact Assembly

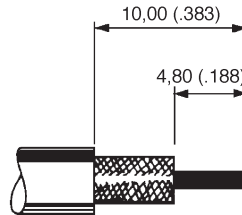

Part Number: 192945-4580

Outer Male Contact Assembly

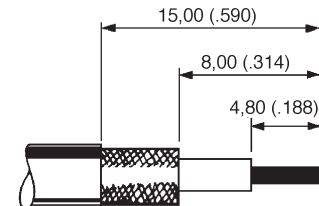

Part Number: 192945-4590

Outer Male Contact Assembly

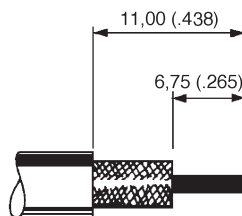

Part Number: 192945-4530

Outer Male Contact Assembly

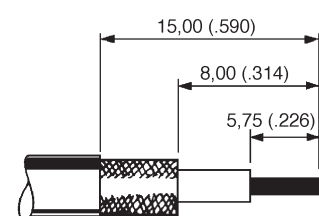

Part Number: 192945-4530

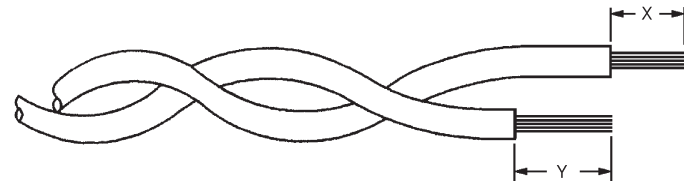

Part Number: 192945-4930 & 192945-4530



## Discriminating (Keying) Pins and Caps

Discriminating (Keying) Pins are used to prevent cross-mating of similar connectors. These pins are used in place of a pin contact. The corresponding socket cavity must be left open. If a socket contact is present, the discriminating pin will prevent mating. There are two types of discriminating pins. Board Mount PCB connectors have caps and pegs. All other connectors have signal or power pins.

Description	Part Number	Pack Size
Discriminating (Keying) Pin, Signal Contacts	192990-0000	Bulk Pack (25)
Discriminating (Keying) Pin, Power Contacts	192900-0189	Bulk Pack (25)
Discriminating (Keying) Pin, Pin Contacts	192990-0010	Bulk Pack (100)
Discriminating (Keying) Cap, Socket Contacts	192990-7650	Bulk Pack (100)



## Hand Tools For Formed (Stamped) Contacts

### Low Cost Tool

This tool is recommended for prototype and low volume applications. It supports the full range of stamped contacts

Stamped Signal Contacts	Part Number
14-26 AWG	192922-1440



### Ratcheted Hand Tool

A range of single action, factory calibrated tools are available to support the stamped contacts and 30 A power contacts.

Signal Contact	Power Contact	Part Number
14-16 AWG	N/A	112108-0013
16-18, 20-22, 24-26 AWG	N/A	112108-0014
16-18 AWG	12-14 AWG	112108-0011
N/A	14-16, 18-20 AWG	112108-0012



## Hand Tools For Machined and Coaxial Contacts

This is a ratcheted, four indent crimp tool that is fully adjustable. They crimp all sizes of machined and coaxial contacts.

- MIL-C-22520 1/01\*

Description	Hand Tool Part Number	Locator
Machined Crimp*	192990-2050	192990-7600 (Calibrated)
Machined Crimp*	192990-2050	192933-8470 (Low Cost)
Coaxial Outer	274-7613-000	326-7512-000
Coaxial Inner	995-0001-584	326-7511-000

## Automatic Tools

### Mini Applicators



Mini Applicators are interchangeable modules that will fit into many standard crimping machines. They are available for all sizes of stamped signal and power contacts.

Contact Description	Part Number
14-16 Trident Signal	193800-0029
16-18 Trident Signal	193877-5630
20-22 Trident Signal	193877-5640
24-26 Trident Signal	193877-5640
12-14 Trident 30 A Power	193800-0023
14-16 Trident 30 A Power	193800-0024
18-20 Trident 30 A Power	193800-0031

## Crimper/Stripper Systems

ITT offers a wide range of automatic crimping and stripping systems. These systems will support all of the stamped and machined contacts. Contact ITT for details.

### Crimper/Stripper for Formed (Stamped) Contacts



### Vibra-Bowl Crimper for Machined Contacts



## Installation Tools

No installation tooling is required for Neptune. The force needed to insert contacts into the housings is very low and a light push on the wire is sufficient to snap the contact into position. Stitching tools are optional assembly aids for Neptune and TNM connectors. These tools puncture the membrane seal and guide contacts into place. They are not required for assembly, but many customers find that they reduce assembly time.

Description	Part Number
Signal Sockets	192900-0606
Signal Pins	192900-0605
Power Sockets	192900-0608
Power Pins	192900-0607



## Extraction Tools

Contacts can readily be removed from the housings using an extraction tool. The tool is placed over the contact and the sleeve rotated slightly as it is pushed home to release the spring. Light pressure on the knob then ejects the contact from the rear of the housing.

Description	Part Number
Signal	192922-1450
Power	192900-0176



Dimensions shown in mm (inch)  
Specifications and dimensions subject to change

[www.ittcannon.com](http://www.ittcannon.com)

## Crimping Instructions — Formed (Stamped) Crimp Contacts

### Assembly Instructions:

- Strip wires to length. For wire strip lengths, see page 48.
- Open the hand tool and place the contact in the chosen die, ensuring that the locating plate is positioned between the collar and crimp saddle. Then squeeze tool gently to hold the contact in place.
- Insert the wire.
- Cycle the tool.
- Remove the wire and inspect the crimp. The strands should be visible at both ends of the crimp. There should be no loose strands (see Figures 1-3). The contact should be co-linear with the wire (see Figure 4). Bent contacts are unacceptable (see Figure 5).

Figure 1 - Correct

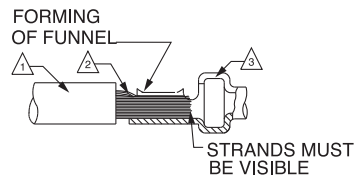

Figure 2 - Unacceptable

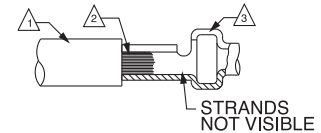

Figure 3 - Unacceptable

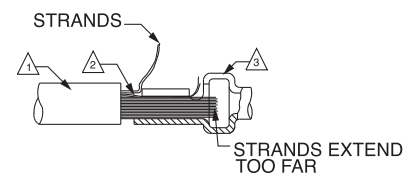

Figure 4 - Correct

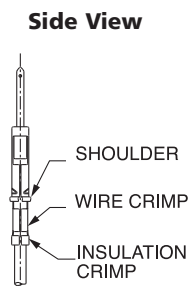

Figure 4 - Correct, Front View

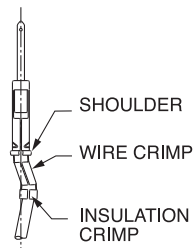

Figure 5 - Unacceptable

Figure 5 - Unacceptable, Side View

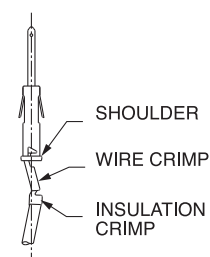
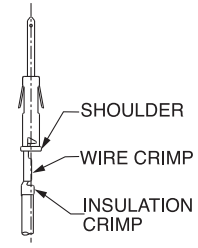

Figure 5 - Unacceptable, Front View



## Crimping Instructions — Machined Crimp Contacts

### Assembly Instructions:

- Strip wires to length. For wire strip lengths, see page 47.
- Attach the correct locator (turret) to the hand tool.

Contact Type	Locator Color
Pin	Blue
Socket	Green
Earthing	Black

- Adjust the dial for the wire gauge.
- Place the contact into the locator and insert the wire into the contact as indicated on the locator (turret) label.

Figure 6 - Correct

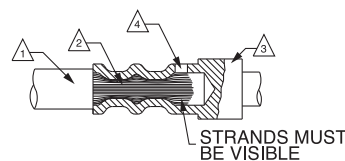
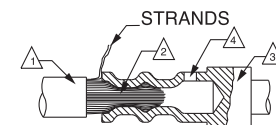

Figure 7 - Unacceptable



### Notes:

- △ Wire Insulation.
- △ Wire Strands.
- △ Contact.
- △ Inspection Window. Strands must be visible.

## Contact Insertion

No insertion tool is required. Trident contacts are inserted from the rear of the connector and held in place by retention tines (cantilever springs). These tines compress during insertion. They expand once contact is in place and prevent the contact from backing out.

### Proper Insertion of Trident Contact

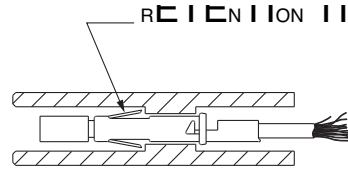

## Contact Retention Forces

- Minimum retention force of the contact to the insulator.

Contact	Newton(s)
Signal Contacts	67
(Formed Crimp, Machined Crimp, Solder Cup, Flow Solder)	
Coaxial Contacts	67
30 A Power Contacts	100

Note: Newton is a metric unit of force. One pound = 4.45 Newtons

## Trident Assembly Instructions (For Neptune and TNM Assembly, see page 55)

### Assembly instructions:

1. Grasp the crimped or soldered contact just behind where the wire enters the contact.
2. Push the contact into the connector cavity until it locks into place.
3. Pull on the wire slightly to verify that the contact is secure.
4. Inspect the mating face of the connector. The contacts should extend the same distance into the connector

### Contact Insertion - Slimline

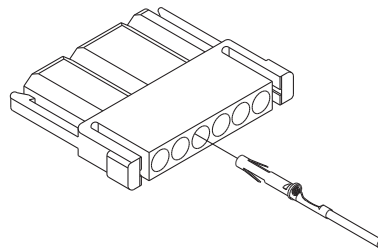

### Contact Insertion - Ringlock

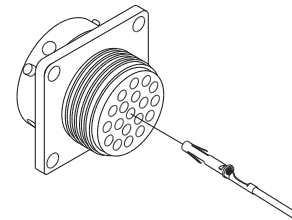

## Neptune and TNM Assembly Instructions (For Trident Assembly, see page 54)

Neptune and TNM connectors feature membrane seals. These seals have a thin membrane that seals unused contact cavities. No sealing plugs are required for unused cavities. Neptune connectors do not require insertion tools. Cannon offers stitching tools as an optional assembly aid for high volume usage. Many customers find that stitching tools reduce the assembly time.

### Assembly Instructions:

1. On Neptune and TNM connectors do not remove the Securing Nut holding the Wire Seal in place, unless an accessory such as Metal Endbell, Conduit Adapter, HC or SR Clamp assembly is to be used in its place. Then remove the Securing Nut (to be replaced by the accessory), make sure the tab on the Seal is positioned in the receiving slot in the connector, fit the accessory over the cables/wires and proceed as follows.
2. Grasp the crimped or soldered contact just behind where the wire enters the contact. If using a stitching tool, insert the contact into the rear of the tool.
3. Push the contact through the membrane seal into the insulator. Continue to push until the contact locks into place. If using a stitching tool, first insert the tool into the required contact position in the seal and examine the mating face to confirm that the correct contact cavity has been entered, if not, this can be corrected by partially removing the tool and engaging the correct position. Then fit the contact to the stitching tool and push the CONTACT through until it locks into place; remove the stitching tool.

### Contact Insertion For Neptune and TNM Connectors

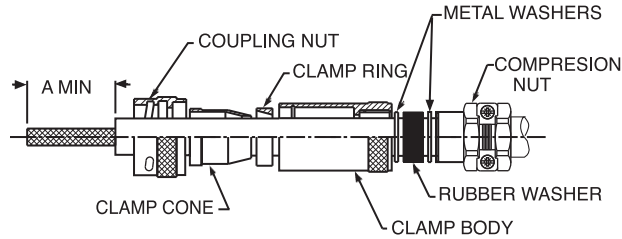

- IMPORTANT NOTE:** The stitching tool is not designed to pull the contact through; it is intended to ease the insertion process with high density connectors. On the high density connectors, such as 0-48, it is beneficial to start loading contacts on a center row first and filling adjacent rows fully each side, so progressively filling the connector from the center in a controlled manner.
4. Pull on the wire slightly to verify that the contact is secure.
  5. Inspect the mating face of the connector. The contacts should extend the same distance into the connector.
  6. Secure the nut, or other accessory, to hold the membrane seal in place.



## Contact Extraction

Contacts may be removed with an extraction tool. The tool has an outer tube and an internal spring loaded plunger. The outer tube depresses the retention tines on the contact. The plunger then pushes the contact back out of the connector.

### Extraction Instructions:

1. Grasp the extraction tool on the knurled portion of the outer tube. Do not push on the plunger knob yet.
2. Insert the tube into the contact cavity from the mating surface. Push the tube fully into the cavity.
- IMPORTANT:** Verify that the depth indicating line on the tool is even with the mating face of the connector before depressing the plunger.
3. Depress the plunger. This should only require light pressure to eject the contact. The contact can now be removed from the back of the connector.
4. Inspect the contact. Verify the tines are not damaged.

### Contact Extraction

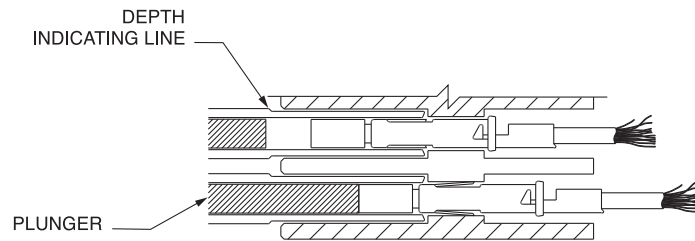

### Extraction Tool

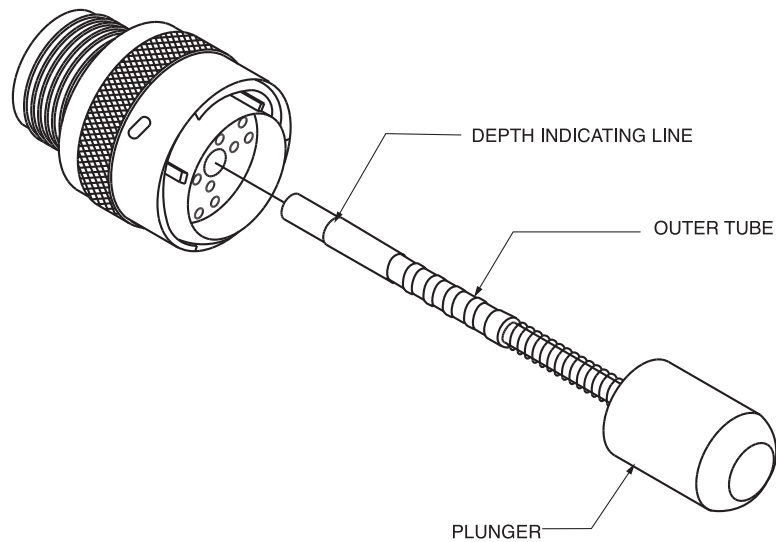

### Endbell — Unsealed

#### Assembly Instructions:

1. Separate the body of the clamp, the two screws, and the clamping bar.
2. Slide the body over the wires or cable and screw onto the threads on the back of the connector. The backshell should be hand-tight. For Neptune and TNM connectors, the cable clamp will fit over the membrane seal and will hold it in place.
3. There are three clamp bars supplied. Select the appropriate one for the wire bundle and attach to the clamp body with the screws.

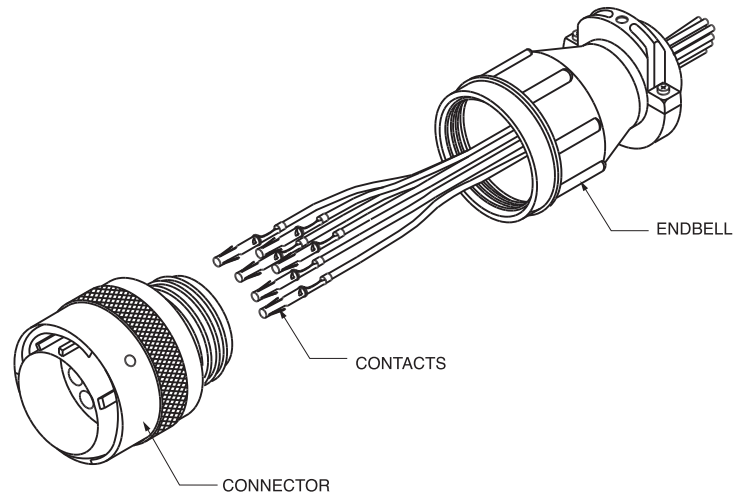

### Endbell — Sealed

#### Assembly Instructions:

1. Separate the body of the clamp body, the two pressure rings, the sealing grommet, the clamp, and O-ring.
2. Slide the backshell components over the cable prior to crimping the contacts and assembling the connector. The farthest part from the connector is the clamp, followed by a pressure ring, then the grommet, then the other pressure ring, then the clamp body and then the O-ring.

Assembly Note: The grommet is a layered design. For large cables one or more of the interior sections can be removed. If the grommet resists sliding over the cable, lubricate with isopropyl alcohol.

3. Crimp and insert the contacts.
4. Slide the O-ring up and over the back of the connector.
5. Screw the clamp body onto the back of the connector. It should be hand-tight. For Neptune and TNM connectors, the cable clamp will fit over the membrane seal and will hold it in place.
6. Slide the pressure rings and grommet forward into the body.
7. Screw the cable clamp into the clamp body. The cable clamp will apply pressure to the grommet causing it to seal the backshell to the cable.
8. Screw down the clamp bar to secure the cable. Note that the bar is reversible, depending on the size of the cable.

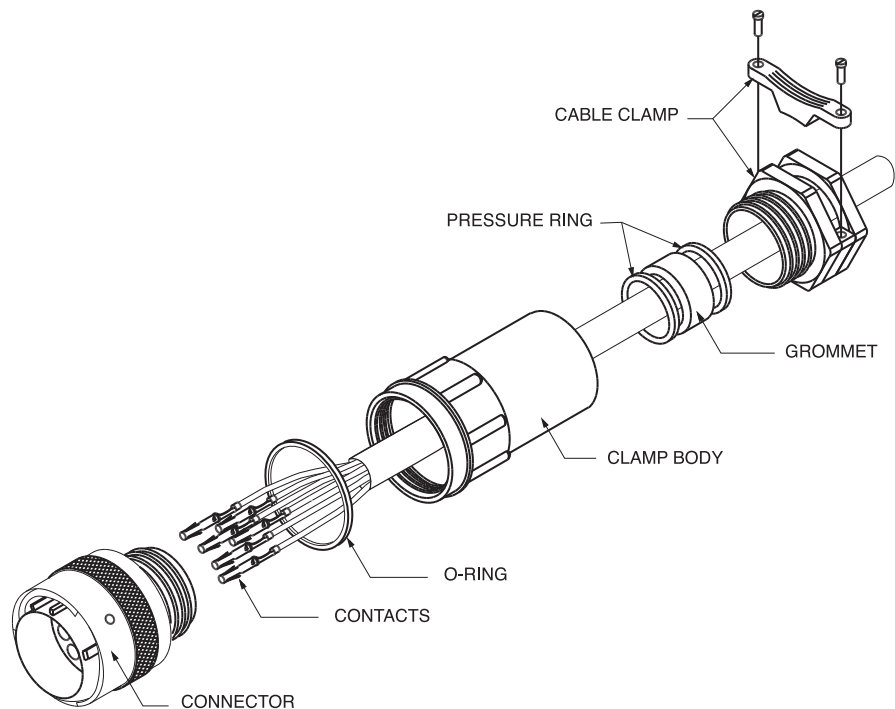

## Universal Endball

### Universal Endbell Assembly

The Universal Endbell is suitable to accept shielded and unshielded cable. This cable is sealed with a highly flexible seal and an additional sealing ring with a flexible plastic cable clamp serving as a strain relief. The Universal Endbell can be screwed onto plug and receptacle connectors. The O-ring and the cable sealing meet IP67.

#### Assembly Instructions:

1. Slide O-ring over the back of the connector body.
2. Slide the endbell components onto the cable in the following order:

- Clamp Nut
- Cable Grip1
- Cable Seal2
- Housing
- Grounding Ring
- Support Sleeve
- O-Ring

Note: 1. The compression fingers of the Cable Grip face toward the connector.

Note: 2. Isopropyl alcohol will lubricate the Cable Seal making it easier to slide over the cable.

3. Cut back the Outside Jacket to expose 25,40 (1.000) of Braid followed by 12,70 (.500) of Insulated Wires.
4. Terminate the wires and insert contacts per assembly instructions, see page 45.
5. Slide the Support Sleeve down until it reaches the back of the connector.
6. Pull the Braid over the Grounding Ring.
7. Slide the Grounding Ring down until it snaps onto the Support Sleeve. The Braid should be secured between the Support Sleeve and the Grounding Ring. Fold any excess shielding over the Grounding Ring.
8. Slide the Housing over the Grounding Ring and the Support Sleeve and screw it into the connector body. The recommended torque is  $10 \pm 1$  Nm (88.50 in lbs).
9. Slide the Cable Seal and Cable Grip onto the Housing.
10. Tighten the Clamp Nut into the Housing. The recommended torque is  $10 \pm 1$  Nm (88.50 in lbs).

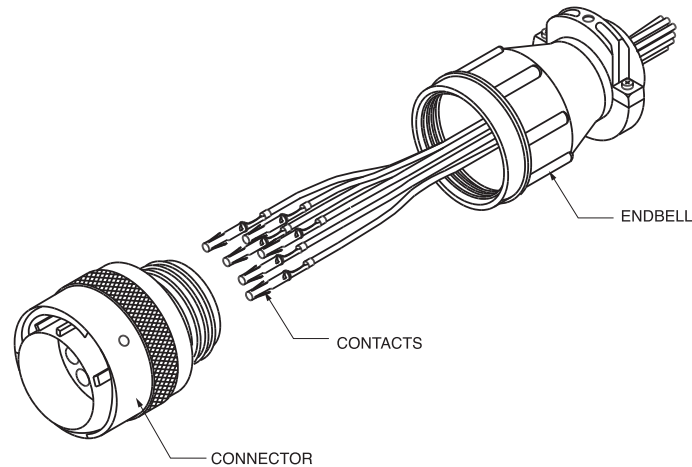

### Wire Strip Length

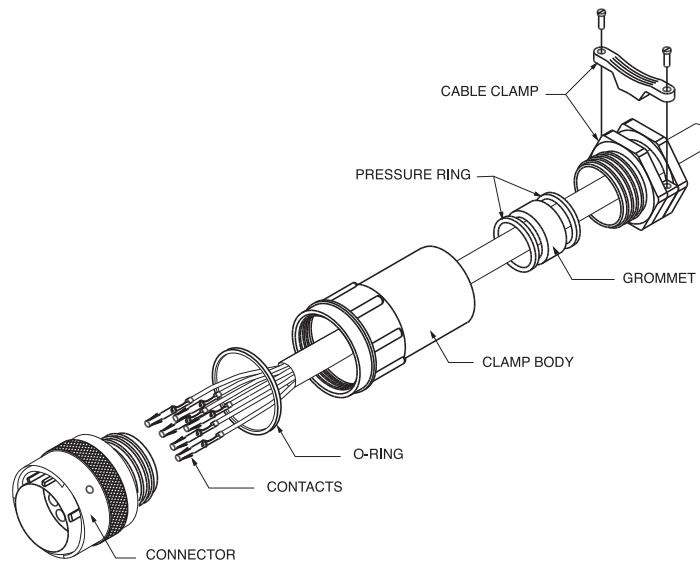

Shell Size	Wire Strip Length		
	A	B	C
10	38,00 (1.500)	22,00 (.870)	*
12	38,00 (1.500)	22,00 (.870)	*
14	40,00 (1.600)	24,00 (.950)	*
16	40,00 (1.600)	24,00 (.950)	*

\* Strip length will vary based on the contact selected, see page 45.

## Shielded Endbell for Larger Cable Sizes

This Endbell is an alternative to the Universal Endbell for use with larger diameter cables. The outer body is sealed to the connector with an O-ring and the rear cable clamp also incorporates sealing rings for a complete sealed termination. The cable braid is terminated between metal cones. A rear cable clamp provides mechanical strain relief in addition to the clamping and holding of the rear cable seal.

### Assembly Instructions:

1. Assemble all parts onto the cable as shown (Figure 1). Strip sheath of cable to dimensions shown in table below.

Shell Size	Dimension A min.
10	22,30 (.877)
12	22,30 (.877)
14	26,20 (1.031)
16	28,10 (1.106)

2. Fold braid back over cable. Strip and terminate wires with selected contacts (Figure 2).

3. Assemble O-ring in groove of the shell after positioning coupling nut (Figure 3).

Figure 1

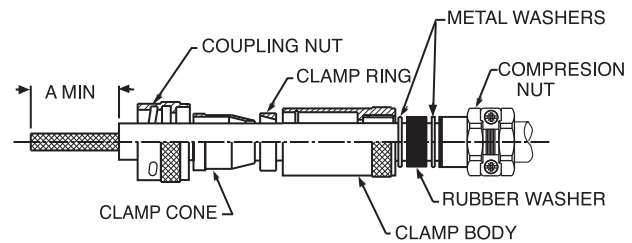
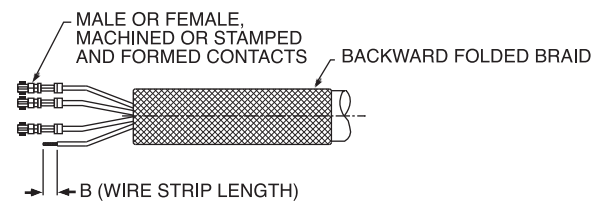

Figure 2



## Wire Stripping Lengths

Contact Type	Wire Size	Wire Range mm <sup>2</sup>	Dimension B
Formed contact	24-16 AWG	0,08 - 1,50	3,95 ± 0,25 (.155 ± .009)
	14 AWG	1,50 - 2,50	5,60 ± 0,25 (.220 ± .009)
Machined contact	26-20 AWG	0,08 - 0,64	5,08 ± 0,25 (.200 ± .009)
	16 AWG	0,60 - 1,51	7,11 ± 0,25 (.279 ± .009)

Figure 3

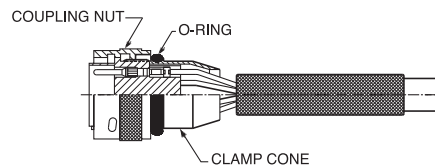

## Cable Sizes

Shell Size	Endbell Part Number	Cable Outer Sheath Diameter	
		Maximum	Minimum
10	192993-0091	10,00 (.393)	5,00 (.196)
12	192993-0092	12,00 (.472)	6,00 (.236)
14	192993-0093	14,00 (.551)	7,00 (.279)
16	192993-0094	16,00 (.629)	8,00 (.314)

## Shielded Endbell for Larger Cable Sizes (continued from page 59)

4. Fold braid forward as shown and trim to length (Figure 4).
5. Slide on clamp ring in position shown (Figure 5).
6. Screw clamp body onto the connector using a strap wrench (Figure 6). Tighten to the recommended torque values in table below.

Shell Size	Clamp body Torque max.
10	4 Nm
12	6 Nm
14	10 Nm
16	10 Nm

7. Push metal washers and rubber washer into rear of clamp body. Then screw compression nut to compress rubber washer. Avoid overtightening as this may twist the cable. Finally tighten screws to provide the mechanical strain relief (Figure 7).

8. Assembled connector (Figure 8).

Figure 4

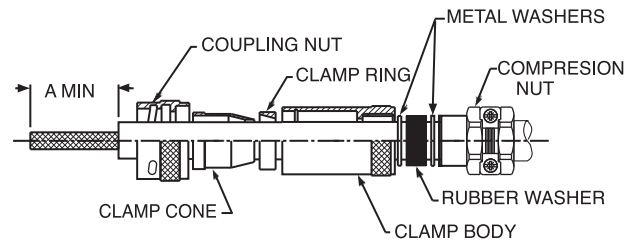

Figure 5

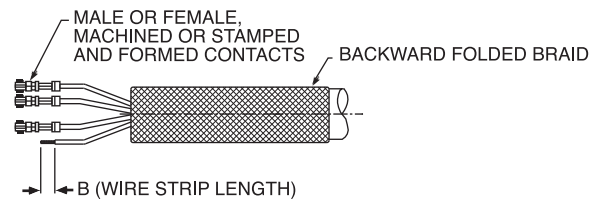

Figure 6

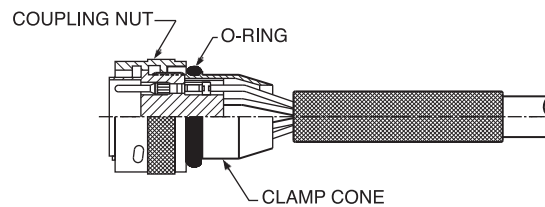
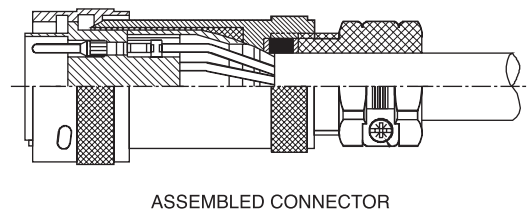

Figure 7



# Notes

---

Dimensions shown in mm (inch)  
Specifications and dimensions subject to change

[www.ittcannon.com](http://www.ittcannon.com)





Chart 1 International Protection (IP) ratings for IEC 529

First digit of IP Number – Ingress of foreign objects		Second digit of IP Number – Ingress of water									
		IP 0	IP 1	IP 2	IP 3	IP 4	IP 5	IP 6	IP 7	IP 8	
	Meaning for the protection of equipment against ingress of solid foreign objects	Meaning for the protection of persons against access to hazardous parts with	non-protected	Protected against vertically falling water drops	Protected against vertically falling water drops when device is tilted up to 15°	Water sprayed an angle up to 60° on either side of the vertical shall have no harmful effects	Water splashed from any direction shall have no harmful effects	Water projected in jets from any direction shall have no harmful effects	Water projected in powerful jets from any direction shall have no harmful effects	Protected against temporary immersion	Protected against continuous immersion
<b>IP 0</b>	non-protected	non-protected	<b>IP 00</b>								
<b>IP 1</b>	Protected against solid foreign objects larger in diameter than 50mm (1.97 in)	Protected against access to hazardous parts with the back of the hand	<b>IP 10</b>	<b>IP 11</b>	<b>IP 12</b>						
<b>IP 2</b>	Protected against solid foreign objects larger in diameter than 12.5mm (.49 in)	Protected against access to hazardous parts with a finger	<b>IP 20</b>	<b>IP 21</b>	<b>IP 22</b>	<b>IP 23</b>					
<b>IP 3</b>	Protected against solid foreign objects larger in diameter than 2.5mm (.10 in.)	Protected against access to hazardous parts with a tool larger in diameter than 2.5mm (.10 in.)	<b>IP 30</b>	<b>IP 31</b>	<b>IP 32</b>	<b>IP 33</b>	<b>IP 34</b>				
<b>IP 4</b>	Protected against solid foreign objects larger in diameter than 1.0mm (.04 in.)	Protected against access to hazardous parts with a wire larger in diameter than 1.0mm (.04 in.)	<b>IP 40</b>	<b>IP 41</b>	<b>IP 42</b>	<b>IP 43</b>	<b>IP 44</b>				
<b>IP 5</b>	Ingress of dust is not totally prevented, but dust shall not penetrate in a quantity to interfere with satisfactory operation of the apparatus or to impair safety	Protected against access to hazardous parts with a wire larger in diameter than 1.0mm (.04 in.)					<b>IP 54</b>	<b>IP 55</b>			
<b>IP 6</b>	No ingress of dust	Protected against access to hazardous parts with a wire larger in diameter than 1.0mm (.04 in.)							<b>IP 66</b>	<b>IP 67</b>	<b>IP 68</b>

Chart 2 NEMA / IP Cross Reference

IEC 529 Protection Ratings	NEMA Ratings									
	1	2	3	3R	4	4X	5	6	12	13
IP 00										
IP 10	↓									
IP 11		↓								
IP 20										
IP 21										
IP 22										
IP 23										
IP 30										
IP 31				↓						
IP 32										
IP 33										
IP 40										
IP 41										
IP 42										
IP 43										
IP 50										
IP 51							↓			
IP 52										
IP 53										
IP 54									↓	↓
IP 55										
IP 56										
IP 60										
IP 61										
IP 62										
IP 63			↓							
IP 64										
IP 65										
IP 66										
IP 67					↓	↓				
IP 68								↓		

The chart above provides a cross-reference from NEMA to International Protection (IP) Ratings. This cross-reference is an approximation based on the most current information available. It is not sanctioned by NEMA, IEC, or any other regulatory body. This chart should be used only as a guideline.

## GLOSSARY OF TERMS

In every job speciality there are certain words and phrases used by “insiders” which after a time become almost a language unique to that speciality. Trident technology is a typical example of that condition.

This page provides some explanations, in an attempt to clarify some of the terms that are commonly used by engineers and sales staff at Cannon.

The list is not comprehensive, but highlights many of the expressions commonly used. Should you have any comments or additions please contact us. Feedback will be appreciated.

**ADAPTER** – A device used to modify the accessory threading on the rear of the connector. Typical adapters are used to attach conduit, heat shrink, overmolds, or tubing to the connectors. They are generally used in place of a cable clamp.

**AWG** – American Wire Gauge. A method of specifying wire diameter. The higher the number, the smaller the diameter (a size 16 AWG wire has a larger diameter than a size 22 AWG).

**BAYONET COUPLING** – A quick coupling mechanism for mechanically mating and unmating connector halves. The plug half has a coupling nut with internal ramps and the receptacle has three “bayonet” pins. The two halves are mated and unmated by rotating the coupling nut. The two halves are mated and unmated by rotating the coupling nut.

**BACKSHELL** – See ENDBELL.

**BODY** - The main portion of the connector made of the shell, insulator, and contacts.

**CABLE CLAMP** – A rear connector clamping accessory which tightens over a cable or wire bundle to provide strain relief to the cable. The cable clamp may be part of a more elaborate endbell or it may be used alone. Some cable clamps also provide cable jacket sealing using a resilient gland, others provide only strain relief.

**CABLE SEAL** – An endbell or cable clamp that is used to seal a round jacketed cable as it enters the rear of the connector.

**CONTACT** – The conductive element in a connector which makes the actual connection between the wire and the mating connector for the purpose of transferring electrical energy. Ideally the contact should add nothing to the circuit. In the real world, however, contacts typically have a small CONTACT RESISTANCE and associated potential drop. Contacts come in many styles such as solder, crimp, printed circuit (PC), to name just those found in this catalog. Also see SOLDER CONTACT, CRIMP CONTACT, STAMPED AND FORMED CONTACT, PIN CONTACT, and SOCKET CONTACT.

**CONTACT ALIGNMENT** – The overall play that a contact has in the insulator cavity to allow the mating contacts to self align. Also called contact float.

**CONTACT ARRANGEMENT** – See LAYOUT.

**CONTACT CAVITY** – A defined hole in the connector insulator into which the contacts fit. The cavities are generally marked with a unique designation or number for ease of identification.

**CONTACT RESISTANCE** – The maximum amount of resistance which a contact introduces into the connection when carrying a specified current (usually stated in milliohms). When not stated, values are typically given for “Initial” or new contacts. Most specifications also limit the maximum resistance during or after each of a series of extreme tests, such as “Contact Resistance After Corrosion Test”. These figures are typically slightly higher than “Initial”.

**CONTACT RETENTION** – The maximum allowable axial load which can be applied to a contact from either direction without it being dislodged from the insulator. Usually stated in Newtons or pounds of force (4.45 = 1 lbf).

**CONTACT SEPARATION FORCE** – The force required to separate a pair of mated contacts. Usually stated in grams or ounces.

**CONTACT SIZE** – The size of the engaging pin and socket contacts in AWG size or metric diameter of the pin.

**CONTACT SPACING** – The distance between two centers of adjacent contacts.

**COUPLING NUT (Also known as LOCKING RING)** - The rotating ring on plug style connectors which mechanically locks the two connector halves together.

**CRIMP CONTACT** – A contact which is terminated to a wire by means of mechanical deformation of the receiving area by means of an appropriate tool.

**CSA** – Abbreviation for Canadian Standards Association.

**CURRENT RATING** – The maximum current that a particular wire, contact, or connector can accommodate. NOTE: When several wires are used in a single connector or elevated temperature or altitude is involved, derating curves must be applied to these ratings.

**DERATING CURVE** – A graph of the change in power handling capability of a connector as a function of ambient temperature or altitude. Typically the graphed function is curved, hence the name.

**DISCRIMINATION** – A method of ensuring that two similar size connectors cannot be mated. This may be achieved by inclusion of discriminating pins, which enter an empty contact cavity, or by other mechanical means.

**DISCRIMINATING PINS** – See KEYING.  
**ENDBELL (also known as BACKSHELL)** – The outer rear end of the connector, which is attached by means of internal threads or screws. It adapts the connector to its wire connections in a variety of ways. Typical endbells might have cable clamps to secure a wire bundle, ridges for heat shrink tubing, pipe threads, or shield termination mechanisms.

**EXTRACTION TOOL** – A device used to remove a contact from a connector insulator. The extraction tool is inserted into the mating face of the insulator and the contact comes out the rear, or wire side, of the connector.

**FIRST-MAKE LAST-BREAK CONTACT** – A contact which is longer than a standard contact or which sits in the insulator in such a way that it mates with the opposing connector half before any of the other contacts. Used to ensure that a ground connection between the connector halves mates before any of the other contacts.

**FLANGED RECEPTACLE** – The shell of this connector has a square flange with mounting holes at each corner. Mounting holes are usually clearance holes, but may be threaded. Receptacle flanges may be mounted in front or at the rear of the panel.

**FLASH PLATING.** – As commonly used in connector terminology, flash refers to extremely thin platings of metal. A flash plating is the minimum thickness required to ensure complete surface coverage. It is typically used on contacts that will have only occasional mating and unmating.

**IEC** – Abbreviation for the International Electrotechnical Commission. An international organization, which develops standards exclusively for electrical engineering. CENELEC is the equivalent organization at the European level.

**INSULATOR** – The insulating element into which the contacts are mounted in a connector.

**IP67** - One classification from a rating system used in Europe covering the environmental sealing capability of an enclosure. The system uses two digits, the first digit relates to the degrees of protection the connector has from dirt and dust under the conditions defined in the specification. The second digit relates to the degrees of protection it has against moisture. The degree of protection against dirt ranges from 1 (no protection), to 6 (dust tight). Moisture sealing in the specification ranges from 1 (no protection), to 8 (protected against continuous submersion). The classification IP67 states that the connector is "dust-tight" (6), allowing no ingress of dust what-so-ever, and "protected against the effects of immersion" (7), the ingress of water in harmful quantity shall not be possible when the connector is immersed in water under defined conditions of pressure and time.

**JAM NUT RECEPTACLE** – A receptacle connector that is mounted from the rear side of the panel and is held in place by a large hex nut (jam nut).

**KEYING** – A method of differentiating a connector if more than one connector with the same sex and layout is to be used in a system. The key is a pin which can be located in a contact cavity or slot. The key will prevent a connector without a matching orifice from mating.

**LAYOUT** – The number, size, and geometric arrangement of the contacts in a connector. When a connector is said to have a certain "layout" it refers to a specific contact configuration. For example, the Snap Together Connector series has a page of drawings showing the arrangement of the contacts in the insulator. Each of these arrangements can be referred to as a layout.

**LOCKING RING** – See COUPLING NUT.

**PIN CONTACT** – The contact that has a long shaft at the engagement end which enters the socket contact.

**PLUG** – The male portion of the connector pair usually employing a coupling nut to secure it to the receptacle half. A Plug may have either pin or socket contacts.

**POLARIZATION** – Polarization ensures that connector halves engage in such a way that the identified contact cavities always engage each other, A to A etc. The connector is polarized.

**POLARIZING PIN** – See KEYING.

**REAR MOUNTING** – A receptacle that mounts through the panel from the rear, with its mounting flange inside the equipment. Typically, rear mount receptacles are slightly longer than front mount types to allow for the thickness of the panel. Flange mount receptacles usually come in front and rear mount versions. All Jam nut receptacles are rear mount.

**RECEPTACLE** – The connector which mates with the plug. The receptacle has threads, pins or ramps that engage the coupling nut on the plug, locking the two halves together. A receptacle may have either pin or socket contacts.

**SHELL** – The outside case of a connector into which the insulator and contacts are situated.

**SHELL SIZE** – A standard system developed for military circular connectors for indicating the diameter of the shell. The system is based upon 1/16" increments, that is, a size 16 shell is one inch in diameter.

**SOCKET CONTACT** – The contact that has an opening at the engagement end to accept the pin contact.

**SOLDER CONTACT** – A contact that is terminated to the wire or printed circuit with solder. The alternative is crimp contacts to which a wire is attached by crimping.

**SOLDER CUP** – The end of a SOLDER CONTACT designed to accept a wire, which will then be soldered to the contact.

**STAMPED AND FORMED CONTACT** – Contacts made by stamping and forming a sheet of metal rather than by machining metal stock.

**UL** – Abbreviation for Underwriter's Laboratories, a corporation supported by a group of underwriters for the purpose of establishing safety standards covering certain types of equipment and components in the United States. Product Safety Information

# Cannon Trident Connector System

## Part Number Index

Part Number	Page	Part Number	Page	Part Number	Page	Part Number	Page	Part Number	Page
031-8717-020	50	192900-0406	48	192900-0672	26	192990-0440	9	192990-3270	10
031-8717-021	50	192900-0407	48	192900-0673	26	192990-0450	9	192990-3280	10
031-8717-022	50	192900-0408	48	192900-0674	35	192990-0460	8	192990-3290	10
031-8717-120	50	192900-0409	48	192900-0676	26	192990-0470	8	192990-3300	11
031-8717-121	50	192900-0410	48	192900-0677	26	192990-0480	8	192990-3310	11
031-8717-122	50	192900-0411	10	192900-0678	26, 37	192990-0960	13	192990-3320	11
075-8543-011	26	192900-0412	10	192900-0679	26, 37	192990-0970	13	192990-3330	11
075-8543-012	26	192900-0413	10	192900-0680	26	192990-0980	13	192990-3340	11
075-8543-015	26	192900-0414	10	192900-0681	26	192990-0990	13	192990-3350	11
075-8543-017	26	192900-0415	10	192900-0682	26	192990-1000	13	192990-3360	11
112108-0011	53	192900-0416	10	192900-0683	26, 37	192990-1220	48	192990-7650	52
112108-0012	53	192900-0417	10	192900-0687	37	192990-1230	48	192991-0013	35
112108-0013	53	192900-0418	11	192922-1190	23	192990-1240	48	192991-0015	35
112108-0014	53	192900-0419	11	192922-1200	23	192990-1250	48	192991-0018	36
121668-0000	50	192900-0420	11	192922-1210	23	192990-1290	23	192991-0019	36
121668-0001	50	192900-0421	11	192922-1220	23	192990-1300	23	192991-0042	49
121668-0002	50	192900-0422	11	192922-1230	23	192990-1310	23	192991-0043	49
121668-0100	50	192900-0423	11	192922-1240	23	192990-1320	22	192991-0044	49
121668-0101	50	192900-0424	1	192922-1250	22	192990-1330	22	192991-0046	49
121668-0102	48	192900-0425	32	192922-1260	22	192990-1340	22	192991-0047	49
192900-0000	48	192900-0431	33	192922-1270	22	192990-1350	25	192991-0048	49
192900-0001	48	192900-0437	33	192922-1280	22	192990-1360	25	192991-0049	49
192900-0002	48	192900-0445	48	192922-1290	22	192990-1370	25	192991-0050	49
192900-0003	48	192900-0446	48	192922-1300	22	192990-1380	24	192991-0052	49
192900-0004	48	192900-0447	48	192922-1310	27	192990-1390	24	192991-0053	49
192900-0005	48	192900-0448	48	192922-1320	27	192990-1400	24	192991-0054	49
192900-0006	48	192900-0449	48	192922-1330	27	192990-1430	26	192991-0055	49
192900-0007	48	192900-0450	48	192922-1340	27	192990-1440	26	192991-0056	49
192900-0014	30	192900-0451	48	192922-1350	27	192990-1450	26	192991-0058	49
192900-0015	30	192900-0452	48	192922-1360	27	192990-1460	26	192991-0059	49
192900-0016	30	192900-0457	37	192922-1440	53	192990-1470	26	192991-0084	49
192900-0017	30	192900-0458	37	192922-1450	54	192990-1480	26	192991-0085	49
192900-0030	31	192900-0465	50	192922-1460	48	192990-1490	26	192991-0086	49
192900-0032	31	192900-0469	30	192922-1470	48	192990-1500	26	192991-0088	49
192900-0033	31	192900-0475	31	192923-5920	8	192990-1510	27	192991-0089	49
192900-0035	31	192900-0481	31	192923-5930	8	192990-1520	27	192991-0090	49
192900-0036	31	192900-0487	36	192923-5940	8	192990-1530	27	192991-0092	49
192900-0038	31	192900-0488	36	192923-5950	8	192990-1540	27	192991-0093	49
192900-0039	31	192900-0489	36	192923-5960	8	192990-1550	27	192991-0094	49
192900-0054	32	192900-0490	31	192923-5970	8	192990-1560	27	192991-0096	49
192900-0055	32	192900-0496	34, 45	192923-5980	8	192990-1570	27	192991-0097	49
192900-0056	32	192900-0497	34, 45	192923-5990	8	192990-1580	27	192991-0098	49
192900-0057	32	192900-0498	34	192923-6000	8	192990-1590	27	192991-0100	49
192900-0069	33	192900-0507	30	192923-6010	9	192990-1600	27	192991-0101	49
192900-0071	33	192900-0508	31	192923-6020	9	192990-1660	23	192991-0102	49
192900-0072	33	192900-0509	31	192923-6030	9	192990-1670	23	192991-0119	50
192900-0074	33	192900-0537	30	192923-6040	9	192990-1680	23	192991-0122	50
192900-0075	33	192900-0538	30	192923-6050	9	192990-1690	23	192991-0160	49
192900-0077	33	192900-0539	30	192926-0440	25	192990-1700	23	192991-0164	49
192900-0078	33	192900-0540	32	192926-0450	25	192990-1710	23	192991-0207	49
192900-0120	48	192900-0541	32	192926-0460	25	192990-1720	23	192991-0208	49
192900-0121	48	192900-0542	32	192926-0470	25	192990-1730	23	192991-0213	11
192900-0122	48	192900-0549	30	192926-0480	25	192990-1740	23	192991-0214	11
192900-0123	48	192900-0550	32	192926-0490	25	192990-1760	25	192991-0221	11
192900-0124	48	192900-0557	30	192926-0500	23	192990-1770	25	192991-0222	11
192900-0125	48	192900-0558	32	192926-0510	23	192990-1780	25	192991-0229	11
192900-0126	48	192900-0561	30	192926-0520	23	192990-1790	25	192991-0230	11
192900-0127	48	192900-0562	32	192926-0530	23	192990-1800	25	192991-0237	11
192900-0176	54	192900-0565	26, 37	192926-0540	23	192990-1810	25	192991-0238	11
192900-0184	35	192900-0566	26, 37	192926-0550	23	192990-1820	25	192991-0245	11
192900-0185	35	192900-0567	26	192945-4380	51	192990-1830	25	192991-0246	11
192900-0187	35	192900-0581	32	192945-4390	51	192990-1840	25	192991-0253	11
192900-0189	36	192900-0582	33	192945-4530	51	192990-2050	53	192991-0254	11
192900-0189	52	192900-0583	33	192945-4930	51	192990-2480	48	192991-0261	11
192900-0226	35	192900-0605	54	192990-0000	36, 52	192990-2490	48	192991-0262	11
192900-0236	32	192900-0606	54	192990-0010	52	192990-2500	48	192991-0270	10
192900-0256	33	192900-0607	54	192990-0020	47	192990-2510	48	192991-0271	10
192900-0266	33	192900-0608	54	192990-0030	47	192990-2520	48	192991-0278	10
192900-0286	34, 45	192900-0632	50	192990-0040	47	192990-2530	48	192991-0279	10
192900-0303	30	192900-0633	50	192990-0050	47	192990-2540	48	192991-0286	10
192900-0308	31	192900-0634	50	192990-0060	47	192990-2550	48	192991-0287	10
192900-0313	31	192900-0635	50	192990-0070	47	192990-2620	48	192991-0294	10
192900-0343	34, 45	192900-0636	45	192990-0080	47	192990-2630	48	192991-0295	10
192900-0344	34	192900-0637	45	192990-0090	47	192990-2640	48	192991-0302	10
192900-0353	33	192900-0639	45	192990-0100	47	192990-2650	48	192991-0303	10
192900-0356	50	192900-0640	45	192990-0110	47	192990-2660	48	192991-0310	10
192900-0388	37	192900-0654	35	192990-0350	7	192990-2670	48	192991-0311	10
192900-0392	37	192900-0666	26	192990-0360	9	192990-2680	48	192991-0316	14
192900-0402	37	192900-0667	26	192990-0370	8	192990-2690	48	192991-0317	15
192900-0403	48	192900-0668	26	192990-0380	9	192990-3230	10	192991-0318	14
192900-0404	48	192900-0669	26	192990-0400	9	192990-3240	10	192991-0319	15
192900-0405	48	192900-0670	26	192990-0420	9	192990-3250	10	192991-0320	14
		192900-0671	26	192990-0430	9	192990-3260	10	192991-0321	15



# Cannon Trident Connector System

## Part Number Index

Part Number	Page	Part Number	Page	Part Number	Page	Part Number	Page	Part Number	Page
192991-0322	14	193800-0024	54	TNA 14 CCHC-00L	34	TR 1208 PFS 1NB	24	TST 03 RB 01Z	10
192991-0323	15	193800-0029	54	TNA 14 CCHC00L	45	TR 1208 PMS 1NB	22	TST 03 RB 02T	11
192991-0324	14	193800-0031	54	TNA 14 CCSE 00L	44	TR 1208 RFH 1NB	23	TST 03 RB 02Z	11
192991-0325	15	193877-5630	54	TNA 14 CCSR-00L	34	TR 1208 RFS 1NB	23	TST 03 RB 05T	10
192991-0337	14	193877-5640	54	TNA 14 CCSR-00L	45	TR 1208 RMH 1NB	25	TST 03 RB 05Y	10
192991-0342	14	274-7613-000	53	TNA 14 HSAD 00L	43	TR 1208 RMS 1NB	25	TST 03 RB 06T	11
192991-0347	14	995-0001-584	53	TNA 14CC-SE 01L	43	TR 14 AAD	26	TST 03 RB 06Y	11
192991-0354	14	TC1FCLY	51	TNA 16 CA01-20L	35	TR 14 AHC 1N	27	TST 03 RD 01T	14
192991-0402	10	TC1MCLY	51	TNA 16 CA02-18L	35	TR 14 ASR 1N	27	TST 03 RE 01T	15
192991-0403	10	TC2FCLY	51	TNA 16 CA22-18L	35	TR 1412 PFS 1NB	24	TST 04 AH 00	8
192991-0532	15	TC2MCLY	51	TNA 16 CCHC-00L	34	TR 1412 PMS 1NB	22	TST 04 AS 00	9
192991-0533	15	TN 0L 2400-48 P1L	33	TNA 16 CCHC00L	45	TR 1412 RFH 1NB	23	TST 04 PA 00	8
192991-0534	15	TN 0L 2400-48 S1L	31	TNA 16 CCSE 00L	44	TR 1412 RFS 1NB	23	TST 04 PF 00	13
192991-0535	15	TN 0S 1400-12 P1L	33	TNA 16 CCSR-00L	34, 45	TR 1412 RMH 1NB	25	TST 04 RA 00	9
192991-0536	14	TN 0S 1400-12 S1L	31	TNA 16 HSAD 00L	43	TR 1412 RMS 1NB	25	TST 04 RB 01T	10
192991-0538	15	TN 0S 1600-19 P1L	33	TNA 16CC-SE 01L	43	TR 16 AAD	26	TST 04 RB 01Z	10
192991-0566	26	TN 0S 1600-19 S1L	31	TNA 24 CA01-20L	35	TR 16 AHC 1N	27	TST 04 RB 02T	11
192991-0617	50	TN 0S 1602-13 P1L	33	TNA 24 CA01-25L	35	TR 16 ASR 1N	27	TST 04 RB 02Z	11
192991-0618	50	TN 0S 1602-13 S1L	31	TNA 24 CA02-26L	35	TR 1619 PFS 1NB	24	TST 04 RB 05T	10
192991-0628	32	TN 0S 2400-48 P1L	33	TNA 24 CA03-34L	35	TR 1619 PMS 1NB	22	TST 04 RB 05Y	10
192991-0640	31	TN 0S 2400-48 S1L	31	TNA 24 CA22-26L	35	TR 1619 RFH 1NB	23	TST 04 RB 06T	11
192991-0644	31	TN 0S 2404-20 P1L	33	TNA 24 CCHC-00L	34	TR 1619 RFS 1NB	23	TST 04 RB 06Y	11
192991-0648	32	TN 0S 2404-20 S1L	31	TNA 24 CCSR-00L	34	TR 1619 RMH 1NB	25	TST 04 RD 01T	14
192991-0652	33	TN 0S 2404-28 P1L	33	TNM 0S 1000-04 P1L	41	TR 1619 RMS 1NB	25	TST 04 RE 01T	15
192991-0656	33	TN 0S 2404-28 S1L	31	TNM 0S 1000-04 S1L	40	TR 18 AAD	26	TST 06 AH 00	8
192991-0660	30	TN 0S 2412-19 S1L	31	TNM 0S 1200-08 P1L	41	TR 18 AHC 1N	27	TST 06 AS 00	9
192991-0664	32	TN 6L 2400-48 P1L	31	TNM 0S 1200-08 S1L	40	TR 18 ASR 1N	27	TST 06 PA 00	8
192991-0668	9	TN 6L 2400-48S 2L	32	TNM 0S 1400-12 P1L	40	TR 1807 PFS 1NBE	24	TST 06 PF 00	13
192993-0001	40	TN 6L2400-48 P2L	30	TNM 0S 1400-12 S1L	40	TR 1807 PMS 1NBE	22	TST 06 RA 00	9
192993-0002	40	TN 6S 1400-12 P1L	30	TNM 0S 1403-04 S1L	40	TR 1807 RFH 1NBE	23	TST 06 RB 01T	10
192993-0003	40	TN 6S 140012 S1L	32	TNM 0S 140304 P1L	41	TR 1807 RFS 1NBE	23	TST 06 RB 01Z	10
192993-0004	40	TN 6S 1600-19 P1L	30	TNM 0S 1600-19 P1L	41	TR 1807 RMH 1NBE	25	TST 06 RB 02T	11
192993-0011	40	TN 6S 1600-19S 2L	32	TNM 0S 1600-19 S1L	40	TR 1807 RMS 1NBE	25	TST 06 RB 02Z	11
192993-0012	40	TN 6S 160019 S1L	32	TNM 0U 1000-04 P1L	41	TR 1823 PFS 1NB	24	TST 06 RB 05T	10
192993-0013	40	TN 6S 1602-13 P1L	30	TNM 0U 1000-04 S1L	40	TR 1823 PMS 1NB	22	TST 06 RB 05Y	10
192993-0014	40	TN 6S 1602-13S 2L	32	TNM 0U 1200-08 P1L	41	TR 1823 RFH 1NB	23	TST 06 RB 06T	11
192993-0021	40	TN 6S 160213 S1L	32	TNM 0U 1200-08 S1L	40	TR 1823 RFS 1NB	23	TST 06 RB 06Y	11
192993-0022	40	TN 6S 2400-48 P1L	30	TNM 0U 1600-19 P1L	41	TR 1823 RMH 1NB	25	TST 06 RD 01T	14
192993-0023	40	TN 6S 2400-48S 2L	32	TNM 0U 1400-12 S1L	40	TR 1823 RMS 1NB	25	TST 06 RE 01T	15
192993-0024	40	TN 6S 240048 S1L	32	TNM 0U 1600-19 P1L	41	TR 20 AAD	26	TST 09 PF 00	13
192993-0031	40	TN 6S 2404-20 P1L	30	TNM 0U 1600-19 S1L	40	TR 20 AHC 1N	27	TST 09 RD 01T	14
192993-0032	40	TN 6S 2404-20S 2L	32	TNM 6S 1000-04 P1L	40	TR 20 ASR 1N	27	TST 09 RE 01T	15
192993-0033	40	TN 6S 2404-28 P1L	30	TNM 6S 1000-04 S1L	41	TR 2028 PFS 1NB	24	TST 10 PF 00	13
192993-0034	40	TN 6S 2404-28S 2L	32	TNM 6S 1200-08 P1L	40	TR 2028 PMS 1NB	22	TST 10 RD 01T	14
192993-0041	41	TN 6S 240420 S1L	32	TNM 6S 1200-08 S1L	41	TR 2028 RFH 1NB	23	TST 10 RE 01T	15
192993-0042	41	TN 6S 240428 S1L	32	TNM 6S 1400-12 P1L	40	TR 2028 RFS 1NB	23	TST 12 AH 00	8
192993-0043	41	TN 6S 2412-19 P1L	30	TNM 6S 1400-12 S1L	41	TR 2028 RMH 1NB	25	TST 12 AS 00	9
192993-0044	41	TN 6S 2412-19S 2L	32	TNM 6S 1403-04 P1L	40	TR 2028 RMS 1NB	25	TST 12 PA 00	8
192993-0051	41	TN 6S 241219 S1L	32	TNM 6S 1403-04 S1L	41	TR 22 AAD	26	TST 12 RA 00	9
192993-0052	41	TN 6S1600-19 P2L	30	TNM 6S 1600-19 P1L	40	TR 22 AHC 1N	27	TST 12 RB 01T	10
192993-0053	41	TN 6S1602-13 P2L	30	TNM 6S 1600-19 S1L	41	TR 22 ASR 1N	27	TST 12 RB 01Z	10
192993-0054	41	TN 6S2400-48 P2L	30	TNM 6U 1000-04 P1L	40	TR 2235 PFS 1NB	24	TST 12 RB 02T	11
192993-0061	41	TN 6S2404-20 P2L	30	TNM 6U 1000-04 S1L	41	TR 2235 PMS 1NB	22	TST 12 RB 02Z	11
192993-0062	41	TN 6S2404-28 P2L	30	TNM 6U 1200-08 P1L	40	TR 2235 RFH 1NB	23	TST 12 RB 05T	10
192993-0063	41	TN 6S2412-19 P2L	30	TNM 6U 1200-08 S1L	41	TR 2235 RFS 1NB	23	TST 12 RB 05Y	10
192993-0064	41	TN 6SL 240048 S1L	32	TNM 6U 1400-12 P1L	40	TR 2235 RMH 1NB	25	TST 12 RB 06T	11
192993-0071	41	TN 7L 240048 P1L	33	TNM 6U 1400-12 S1L	41	TR 2235 RMS 1NB	25	TST 12 RB 06Y	11
192993-0072	41	TN 7L 240048 S1L	30	TNM 6U 1600-19 P1L	40	TR 24 AAD	26	TST 24 AH 00	8
192993-0073	41	TN 7S 140012 P1L	33	TNM 6U 1600-19 S1L	41	TR 24 AHC 1N	27	TST 24 AS 00	9
192993-0074	41	TN 7S 140012 S1L	30	TNM 7S 140304 P1L	41	TR 24 ASR 1N	27	TST 24 PA 00	8
192993-0081	44	TN 7S 160019 P1L	33	TNM 7S 140304 S1L	41	TR 2448 PFS 1NB	24	TST 24 RA 00	9
192993-0082	44	TN 7S 160019 S1L	31	TP 03 R3E 00Y	15	TR 2448 PMS 1NB	22	TST 24 RB 01T	10
192993-0083	44	TN 7S 160213 P1L	33	TP 03 R4E 00Y	13	TR 2448 RFH 1NB	23	TST 24 RB 01Z	10
192993-0084	44	TN 7S 160213 S1L	31	TP 04 R3E 00Y	15	TR 2448 RFS 1NB	23	TST 24 RB 02T	11
192993-0091	43, 61	TN 7S 240048 P1L	33	TP 04 R4E 00Y	15	TR 2448 RMH 1NB	25	TST 24 RB 02Z	11
192993-0092	43, 61	TN 7S 240048 S1L	30	TP 06 R3E 00Y	15	TR 2448 RMS 1NB	25	TST 24 RB 05T	10
192993-0093	43, 61	TN 7S 240420 P1L	32	TP 06 R4E 00Y	13	TST 02 AH 00	8	TST 24 RB 05Y	10
192993-0094	43, 61	TN 7S 240420 S1L	31	TP 09 R3E 00Y	15	TST 02 PA 00	8	TST 24 RB 06T	11
192993-0631	43	TN 7S 240428 P1L	33	TP 09 R4E 00Y	14	TST 02 RA 00	9	TST 24 RB 06Y	11
192993-0105	42	TN 7S 240428 S1L	31	TP 10 R3E 00Y	15	TST 02 RB 01T	10	TST 36 AH 00	5
192993-0106	42	TN 7S 241219 P1L	33	TP 10 R4E 00Y	14	TST 02 RB 01Z	10	TST 36 AS 00	9
192993-0261	43	TN 7S 241219 S1L	31	TR 10 AAD	26	TST 02 RB 02T	11	TST 36 PA 00	8
192993-0632	43	TN S0 2412-19 P1L	33	TR 10 AHC 1N	27	TST 02 RB 02Z	11	TST 36 RA 00	9
192993-0633	43	TNA 10 CCHC00L	45	TR 10 ASR 1N	27	TST 02 RB 05T	10	TST 36 RB 01T	10
192993-0634	43	TNA 10 CCSE 00L	44	TR 1004 PFS 1NB	24	TST 02 RB 05Y	10	TST 36 RB 01Z	10
192993-0695	40	TNA 10 CCSR00L	45	TR 1004 PMS 1NB	22	TST 02 RB 06T	11	TST 36 RB 02T	11
192993-0696	41	TNA 10 HSAD 00L	43	TR 1004 RFH 1NB	23	TST 02 RB 06Y	11	TST 36 RB 02Z	11
192993-0697	41	TNA 10CC-SE 01L	43	TR 1004 RFS 1NB	23	TST 03 AH 00	8	TST 36 RB 05T	10
192993-0698	38	TNA 12 CCHC00L	45	TR 1004 RFS 1NB	25	TST 03 AS 00	9	TST 36 RB 05Y	10
192993-0699	42	TNA 12 CCSE 00L	44	TR 1004 RMS 1NB	25	TST 03 PA 00	8	TST 36 RB 06T	11
192993-0700	42	TNA 12 CCSR00L	45	TR 12 AAD	26	TST 03 PF 00	13	TST 36 RB 06Y	11
192993-2013	43	TNA 12 HSAD 00L	43	TR 12 AHC 1N	27	TST 03 RA 00	9		
193800-0023	54	TNA 12CC-SE 01L	43	TR 12 ASR 1N	27	TST 03 RB 01T	10		





THIS NOTE MUST BE READ IN CONNECTION WITH THE PRODUCT DATA SHEET/CA T A LOG. FAILURE TO OBSERVE THE ADVICE IN THIS INFORMATION SHEET AND THE OPERATING CONDITIONS SPECIFIED IN THE PRODUCT DATA SHEET/ CA T A LOG COULD RESULT IN HAZARDOUS SITUATIONS.

## 1. MATERIAL CONTENT AND PHYSICAL FORM

Electrical connectors do not usually contain hazardous materials. They contain conducting and non-conducting materials and can be divided into two groups.

- a) Printed circuit types and low cost audio types which employ all plastic insulators and casings.
- b) Rugged, fire Barrier and High Reliability types with metal casings and either natural rubber, synthetic rubber, plastic or glass insulating materials. Contact materials vary with type of connector and also application and are usually manufactured from either: copper, copper alloys, nickel, alumel, chromel or steel. In special applications, other alloys may be specified.

## 2. FIRE CHARACTERISTICS AND ELECTRIC SHOCK HAZARD

There is no fire hazard when the Connector is correctly wired and used within the specified parameters. In correct wiring or assembly of the Connector or careless use of metal tools or conductive fluids, or transit damage to any of the component parts may cause electric shock or burns. Live circuit must not be broken by separating mated Connector as this may cause arcing, ionization and burning. Heat dissipation is greater at maximum resistance in a circuit. Hot spots may occur when resistance is raised locally by damage, e.g. cracked or deformed contacts, broken strands of wire. Local overheating may also result from the use of the incorrect application tools or from poor quality soldering or slack screw terminals. Overheating may occur if the ratings in the product Data Sheet/catalog are exceeded and can cause breakdown of insulation and hence electric shock. If heating is allowed to continue it intensifies by further increasing the local resistance through loss of temper of spring contacts, formation of oxide film on contacts and wires and leakage currents through carbonization of insulation and tracking paths. Fire can then result in the presence of combustible materials and this may release noxious fumes. Overheating may not be visually apparent. Burns may result from touching overheated components.

## 3. HANDLING

Care must be taken to avoid damage to any component parts of electrical connectors during installation and use. Although there are normally no sharp edges, care must be taken when handling certain components to avoid injury to fingers. Electrical connectors may be damaged in transit to the customers, and damage may result in creation of hazards. Products should therefore be examined prior to installation/use and rejected if found to be damaged.

## 4. DISPOSAL

Incineration of certain materials may release noxious or even toxic fumes.

## 5. APPLICATION

Connectors with exposed contacts should not be selected for use on the current supply side of an electrical circuit, because an electric shock could result from touching exposed contacts on an unmated connector. Voltages in excess of 30 V ac or 42.5 V dc are potentially hazardous and care should be taken to ensure that such voltages cannot be transmitted in any way to exposed metal parts of the connector body. The connector and wiring should be checked, before making live, to have no damage to metal parts or insulators, no solder blobs, loose strands, conducting lubricants, swarf, or any other undesired conducting particles. Circuit resistance and continuity check should be made to make certain that there are no high resistance joints or spurious conducting paths. Always use the correct application tools as specified in the Data Sheet/catalog. Do not permit untrained personnel to wire, assemble or tamper with connectors. For operation voltage please see appropriate national regulations.

## IMPORTANT GENERAL INFORMATION

(i) Air and Creepage Paths/Operating Voltage. The admissible operating voltages depend on the individual applications and the valid national and other applicable safety regulations. For this reason the air and creepage path data are only reference values. Observe reduction of air and creepage paths due to PCB board and/or harnessing.

## (ii) Temperature

All information given are temperature limits. The operation temperature depends on the individual application.

## (iii) Other Important Information

Cannon continuously endeavors to improve their products. Therefore, Cannon products may deviate from the description, technical data and shape as shown in this catalog and data sheets.

“Engineered for life” is a registered trademark of ITT Industries. ©2005. All other trademarks or registered trademarks are property of their respective owners. All data subject to change without notice.

## Product Warranty

ITT Cannon, a Division of ITT Industries, Inc. manufactures the highest quality products available in the marketplace; however these products are intended to be used in accordance with the specifications in this publication. Any use or application that deviates from the stated operating specifications is not recommended and may be unsafe. No information and data contained in this publication shall be construed to create any liability on the part of Cannon. Any new issue of this publication shall automatically invalidate and supersede any and all previous issues. A limited warranty applies to Cannon products. Except for obligations assumed by Cannon under this warranty, Cannon shall not be liable for any loss, damage, cost of repairs, incidental or consequential damages of any kind, whether or not based on express or implied warranty, contract negligence or strict liability arising in connection with the design, manufacture, sale, use or repair of the products. Product availability, prices and delivery dates are exclusively subject to our respective order confirmation form; the same applies to orders based on development samples delivered. This publication is not to be construed as an offer. It is intended merely as an invitation to make an offer. By this publication, Cannon does not assume responsibility or any liability for any patent infringements or other rights of third parties which may result from its use. Reprinting this publication is generally permitted, indicating the source. However, Cannon's prior consent must be obtained in all cases.



# ITT... providing a comprehensive offering of connectivity solutions.

In addition to connector products, we provide a complete line of electronic components and value-added solutions.

## CONNECTOR PRODUCTS

circular  
compact flash  
D-Subminiature  
fiber optics  
filter  
Microminiature

Mobile  
Rack & Panel  
RF  
USB  
Zero insertion force  
Smart cards



## SWITCH PRODUCTS



Top/side actuated tact  
Low profile SMT  
Navigation / scrolling switches  
Toggle, rocker, pushbutton, DIP, slide, snap, switchlock,  
rotary, thumbwheel

## KEYPADS / PRECISION POLYMERS

Rubber and In Mold Decoration (IMD) products  
Wide range of cosmetic options  
Integration of decorated and metalized plastic keytops  
Multiple PILL and contact options  
Precision molded polymeric solutions



## DOME ARRAYS / EL LAMPS



Modular assembly options include: ESD shielding,  
keypads, EL backlighting, rigid or flexible circuits  
Complete design, engineering and test capabilities  
Low, mid and high volume production capabilities

## INTERFACE CONTROLS

From multi-function grips to sophisticated control systems,  
Hall effect products and front panel assemblies  
Electronics and software engineering development  
Worldwide design and manufacturing  
High-mix production capabilities  
Global sourcing and supply chain management





## Connector Product Locations

### GERMANY

Cannonstrasse 1  
Weinstadt, 71384  
phone: 49.7151.699.0  
fax: 49.7151.699.217

### HONG KONG

Unit 901 & 912, West Tower  
Shun Tak Center  
168-200 Connaught Road  
Central  
phone: 852.2732.2720  
fax: 852.2732.2919

### ITALY

Via Pietro Panzeri 10  
Milano, 20123  
phone: 39.2.58180.1  
fax: 39.2.8372036

### UK

Jays Close, Viabes Estate  
Basingstoke, RG22 4BA  
phone: 44.1256.311200  
fax: 44.1256.323356

### USA

666 East Dyer Road  
Santa Ana, CA 92705  
toll free: 1.800.854.3028  
phone: 1.714.557.4700  
fax: 1.714.628.2142