



PART NAME

HINGED WALL MOUNT BRACKET

PART No.

HWB-1790

REVISION DATE

7-3-13

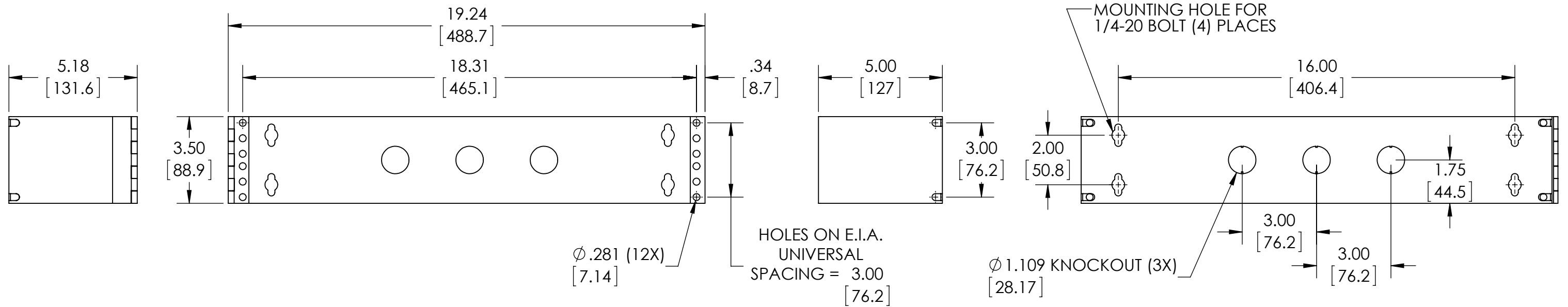
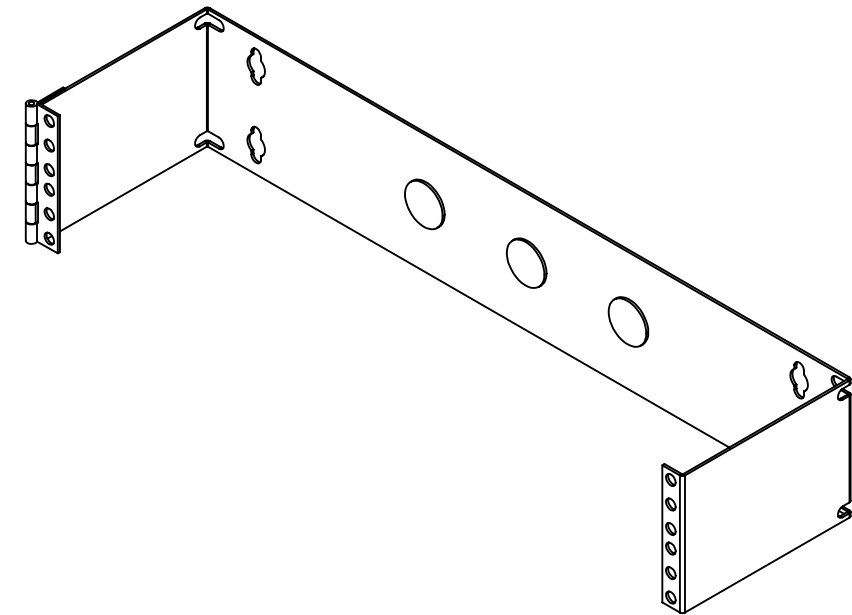
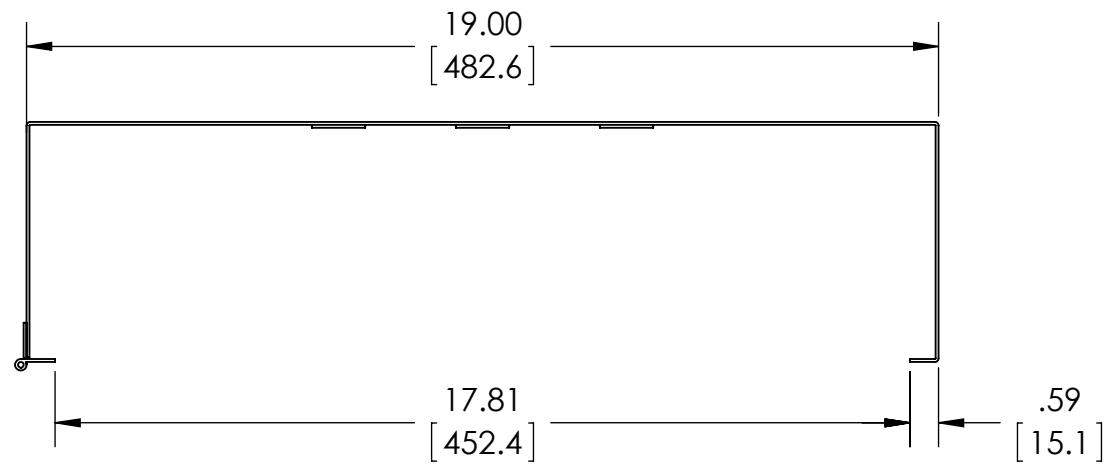

MATERIAL: 16 GA. [1.5mm] STEEL

FINISH: BLACK TEXTURE