

Note: All part numbers are RoHS Compliant.

Index—Eurostyle

One-Piece Board Mount (Cage Clamp)

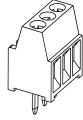

| | Page No. | Page No. | Page No. |
|--------------------|----------|----------|----------|
| 16-30 AWG | Straight | | |
| 2.54 mm Centerline | 8 | — | — |
| 5.08 mm Centerline | 8 | — | — |

Low Profile High Temperature and Standard

| | Page No. | Page No. | Page No. |
|--------------------|----------|----------|----------|
| 16-28 AWG | Straight | | |
| 3.5 mm Centerline | 9 | — | — |
| 3.81 mm Centerline | 9 | — | — |

Stacking with Interlock

| | Straight | Rt.-Angle | |
|--------------------|----------|-----------|---|
| 14-30 AWG | | | |
| 3.50 mm Centerline | 9 | 19 | — |
| 3.81 mm Centerline | 10 | 19 | — |

Low Profile Stacking with Interlock

| | Straight | Rt.-Angle | |
|---------------------|----------|-----------|---|
| 16-30 AWG | | | |
| 5.00 mm Centerline | 11 | 20 | — |
| 5.08 mm Centerline | 11 | 21 | — |
| 10.00 mm Centerline | 16, 17 | 24 | — |
| 10.16 mm Centerline | 18 | 25 | — |

Stacking with Interlock

| | Straight | Rt.-Angle | Angled |
|---------------------|----------|------------|--------|
| 12-30 AWG | | | |
| 5.00 mm Centerline | 12 | 20, 21, 28 | 26 |
| 5.08 mm Centerline | 13, 14 | 21, 22 | 26 |
| 7.50 mm Centerline | 14, 15 | 23 | — |
| 7.62 mm Centerline | 15, 16 | 23 | — |
| 10.00 mm Centerline | 16, 17 | 24 | 27 |
| 10.16 mm Centerline | 18 | 25 | 27 |

High Current Stacking with Interlock

| | Straight | Rt.-Angle | Angled |
|--------------------|----------|-----------|--------|
| 10-24 AWG | | | |
| 6.35 mm Centerline | 29 | — | — |
| 9.52 mm Centerline | 29 | — | 30 |

Multi-Level Stacking with Interlock 1st and 2nd Level

| | |
|--------------------|----|
| 16-30 AWG | |
| 5.00 mm Centerline | 32 |
| 5.08 mm Centerline | 33 |

| | |
|--------------------|--------|
| 12-30 AWG | |
| 5.00 mm Centerline | 32 |
| 5.08 mm Centerline | 33, 34 |

Multi-Level Stacking with Interlock 2nd and 3rd Level

| | |
|--------------------|----|
| 16-30 AWG | |
| 5.08 mm Centerline | 34 |
| 12-30 AWG | |
| 5.08 mm Centerline | 35 |

Multi-Level Stacking with Interlock Three Levels

| | Page No. |
|--------------------|----------|
| 16-30 AWG | |
| 5.00 mm Centerline | 35 |
| 5.08 mm Centerline | 36 |

| | |
|--------------------|----|
| 12-30 AWG | |
| 5.00 mm Centerline | 36 |
| 5.08 mm Centerline | 37 |

Multi-Level Stacking with Interlock 2nd Level

| | |
|--------------------|----|
| 16-30 AWG | |
| 5.00 mm Centerline | 38 |
| 5.08 mm Centerline | 39 |

| | |
|--------------------|--------|
| 12-30 AWG | |
| 5.00 mm Centerline | 38, 39 |
| 5.08 mm Centerline | 40 |

Multi-Level Stacking with Interlock 3rd Level

| | |
|---------------------|----|
| 16-30 AWG | |
| 5.00 mm Centerline | 41 |
| 10.00 mm Centerline | 43 |

| | |
|--------------------|----|
| 12-30 AWG | |
| 5.00 mm Centerline | 41 |
| 5.08 mm Centerline | 42 |

One-Piece Board Mount (Wire Protector Version)

Straight Stacking with Interlock 14-22 AWG

| | |
|--------------------|----|
| 5.00 mm Centerline | 95 |
|--------------------|----|

Low Profile Straight Stacking with Interlock (LT)

| | |
|--------------------|--------|
| 14-22 AWG | |
| 5.00 mm Centerline | 95, 97 |

Straight Stacking with Interlock (LT)

| | |
|--------------------|----|
| 18-26 AWG | |
| 3.50 mm Centerline | 96 |
| 14-22 AWG | |
| 5.00 mm Centerline | 98 |

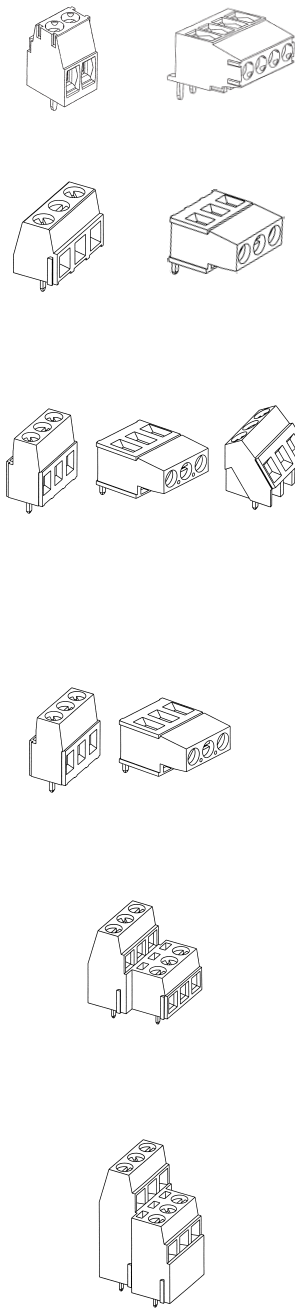

Note: All part numbers are RoHS Compliant.

Index—Eurostyle

One-Piece Board Mount (Wire Protector Version)

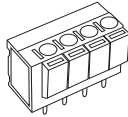
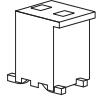
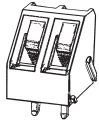

Two-Piece

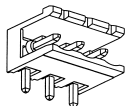
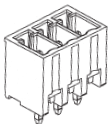
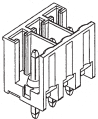
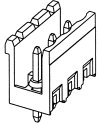

45° Wire Inlet with Interlock (LT)

| 14-22 AWG | Page No. |
|--------------------|----------|
| 5.00 mm Centerline | 99 |
| 5.08 mm Centerline | 99 |

SMT with Wire Trap

| | |
|-------------------|-----|
| 2.5 mm Centerline | 101 |
|-------------------|-----|

Screwless

| 14-22 AWG | |
|--------------------|---------|
| 5.00 mm Centerline | 103-105 |
| 5.08 mm Centerline | 103-105 |

Straight Open End Headers

| | |
|---------------------|----|
| 5.00 mm Centerline | 51 |
| 5.08 mm Centerline | 52 |
| 7.50 mm Centerline | 53 |
| 7.62 mm Centerline | 54 |
| 10.00 mm Centerline | 55 |
| 10.16 mm Centerline | 56 |

Straight Open End Headers with Interlock

| | |
|--------------------|----|
| 3.50 mm Centerline | 49 |
| 3.81 mm Centerline | 50 |
| 5.00 mm Centerline | 57 |
| 5.08 mm Centerline | 57 |

Straight Closed End Headers

| | |
|---------------------|----|
| 3.50 mm Centerline | 49 |
| 3.81 mm Centerline | 50 |
| 5.00 mm Centerline | 51 |
| 5.08 mm Centerline | 52 |
| 7.50 mm Centerline | 53 |
| 7.62 mm Centerline | 54 |
| 10.00 mm Centerline | 55 |
| 10.16 mm Centerline | 56 |

Right-Angle Open End Stacking Headers

| | |
|---------------------|----|
| 5.00 mm Centerline | 59 |
| 5.08 mm Centerline | 61 |
| 7.50 mm Centerline | 62 |
| 7.62 mm Centerline | 63 |
| 10.00 mm Centerline | 64 |
| 10.16 mm Centerline | 65 |

Two-Piece (Continued)

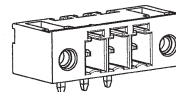
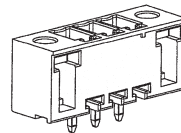
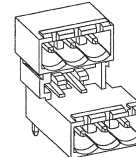
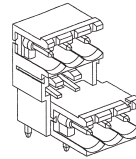
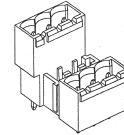
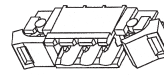
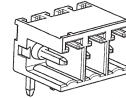
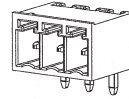

Right-Angle Closed End Headers

| | Page No. |
|---------------------|----------|
| 3.50 mm Centerline | 58 |
| 3.81 mm Centerline | 58 |
| 5.00 mm Centerline | 59 |
| 5.08 mm Centerline | 61 |
| 7.50 mm Centerline | 62 |
| 7.62 mm Centerline | 63 |
| 10.00 mm Centerline | 64 |
| 10.16 mm Centerline | 65 |

Right-Angle Open End Headers with Interlock

| | |
|--------------------|----|
| 5.00 mm Centerline | 66 |
| 5.08 mm Centerline | 66 |

Right-Angle Closed End Headers with Ejectors

| | |
|--------------------|----|
| 5.08 mm Centerline | 67 |
|--------------------|----|

Straight Closed End Double-Row Headers with Interlock

| | |
|---------------------|----|
| 5.00 mm Centerline | 68 |
| 5.08 mm Centerline | 68 |
| 10.00 mm Centerline | 69 |
| 10.16 mm Centerline | 69 |

Right-Angle Open End Double-Row Headers with Interlock

| | |
|--------------------|----|
| 5.00 mm Centerline | 70 |
| 5.08 mm Centerline | 70 |

Right-Angle Closed End Double-Row Headers with Interlock

| | |
|---------------------|----|
| 5.00 mm Centerline | 71 |
| 5.08 mm Centerline | 71 |
| 10.00 mm Centerline | 72 |
| 10.16 mm Centerline | 72 |

Straight Headers with Threaded Flange

| | |
|--------------------|----|
| 3.50 mm Centerline | 45 |
| 3.81 mm Centerline | 45 |
| 5.08 mm Centerline | 46 |

Right-Angle Closed End Headers with Threaded Flange

| | |
|--------------------|----|
| 3.50 mm Centerline | 47 |
| 3.81 mm Centerline | 47 |
| 5.00 mm Centerline | 48 |
| 5.08 mm Centerline | 48 |

Note: All part numbers are RoHS Compliant.

Two-Piece (Continued)

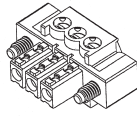

| Right-Angle Plugs with Screw Flange | Page No. |
|--|----------|
| 14-30 AWG | |
| 3.50 mm Centerline | 73 |
| 3.81 mm Centerline | 73 |
| 12-30 AWG | |
| 5.00 mm Centerline | 74 |
| 5.08 mm Centerline | 74 |

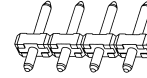

| Unshrouded Pin Headers | Page No. |
|-------------------------------|----------|
| 5.0 mm Centerline | 85 |
| 10.0 mm Centerline | 85 |

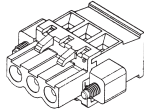

| Straight Plugs with Screw Flange, Left- and Right-Hand Versions | Page No. |
|--|----------|
| 12-30 AWG | |
| 5.08 mm Centerline | 75 |

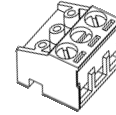

| Special 90°/180° and 90°/270° Plug Connectors | Page No. |
|--|----------|
| 14-30 AWG | |
| 5.0 mm Centerline | 86, 87 |
| 10.0 mm Centerline | 88 |

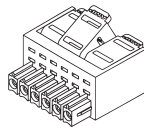

| PIVOT BLOCK Plugs (IDC) | Page No. |
|--------------------------------|----------|
| 22-24 AWG | |
| 3.5 mm Centerline | 102 |

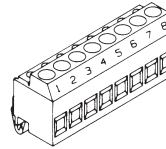

| Flush-Mount Plug-In Connectors with Cage Clamp | Page No. |
|---|----------|
| 12-30 AWG | |
| 5.00 mm Centerline | 89 |
| 5.08 mm Centerline | 91 |

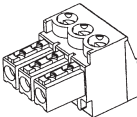

| Right-Angle Plugs | Page No. |
|--------------------------|----------|
| 14-30 AWG | |
| 3.50 mm Centerline | 76 |
| 3.81 mm Centerline | 76 |

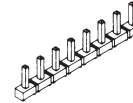

| Unshrouded Pin Headers | Page No. |
|-------------------------------|----------|
| 5.00 mm Centerline | 90 |
| 5.08 mm Centerline | 92 |

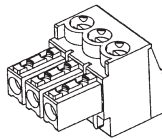

| Right-Angle Plugs with Interlock | Page No. |
|---|----------|
| 14-30 AWG | |
| 3.81 mm Centerline | 80 |

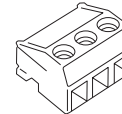

| Flush Mount Plug | Page No. |
|-------------------------|----------|
| 14-22 AWG | |
| 5.00 mm Centerline | 100 |

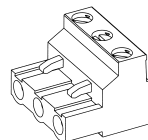

| Right-Angle Plugs with Retention Latch | Page No. |
|---|----------|
| 12-30 AWG | |
| 5.00 mm Centerline | 77 |
| 5.08 mm Centerline | 77 |
| 7.50 mm Centerline | 78 |
| 7.62 mm Centerline | 78 |
| 10.00 mm Centerline | 79 |
| 10.16 mm Centerline | 79 |

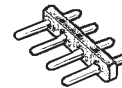

| Straight Unshrouded Pin Header | Page No. |
|---------------------------------------|----------|
| 5.00 mm Centerline | 100 |

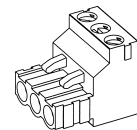

| Right-Angle Stacking Plugs with Retention Latch and Interlock | Page No. |
|--|----------|
| 12-30 AWG | |
| 5.00 mm Centerline | 81 |
| 5.08 mm Centerline | 81 |

Accessories

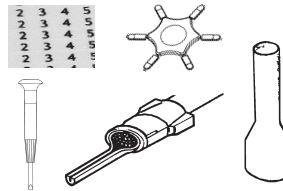

| | |
|--------------------------|----------|
| Labeling | 106 |
| Polarization Keys | 107 |
| Screwdrivers | 107 |
| Wire Pins | 108 |
| Wire Ferrules | 109, 110 |

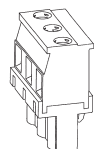

| Straight Plugs with Retention Latch, Left- and Right-Hand Versions | Page No. |
|---|----------|
| 12-30 AWG | |
| 5.00 mm Centerline | 82 |
| 5.08 mm Centerline | 83 |
| 7.50 mm Centerline | 84 |
| 7.62 mm Centerline | 84 |
| 10.00 mm Centerline | 84 |
| 10.16 mm Centerline | 84 |

Stacking Screw Clamp Connectors

Product Facts

n Certified by the VDE Testing
and Certification Institute
VDE File No. 6917
(Two-Piece Version)
VDE File No. 6920
(One-Piece Version)



n Recognized under
the Component Program of
Underwriters
Laboratories Inc.,
File No. E60677



n Certified by Canadian
Standards
Association,
File No. 703157



n Produced under Quality
Management System
certified to ISO 9001

Technical Documents

Product Specification:
108-20166 Terminal Block Connectors,
Stacking PC Board Mount

Application Specification:
114-20079 Terminal Block
Stacking Connectors

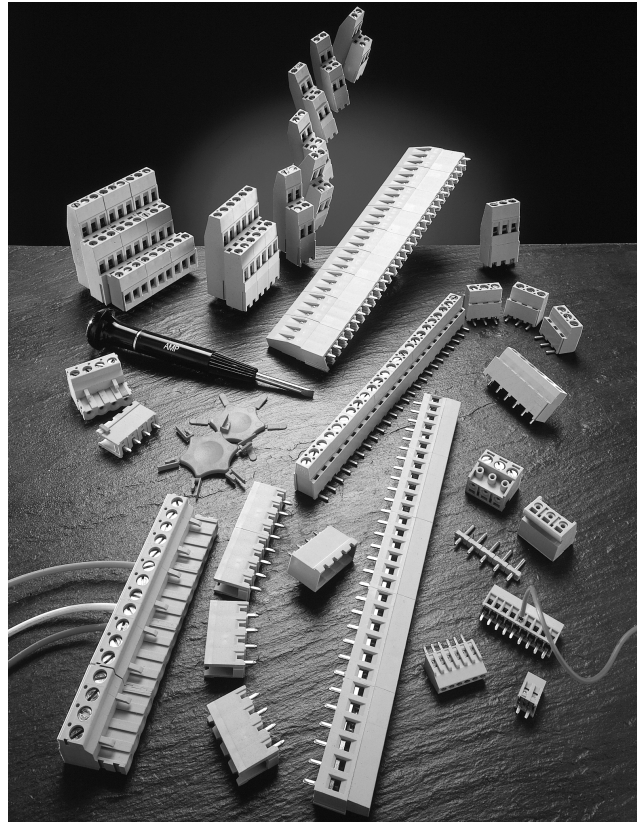

Terminal Block connectors feature the special rising cage clamp design (see illustration on page 7). The modular design of Terminal Block connectors consists of one-piece board mount terminal blocks and plug connectors with mating straight and right-angle shrouded headers. A special version – which can be mated either 90° or 180° – completes the product line. Terminal Block connectors offer several advantages:

- n IR Reflow compatible
- n Terminal Block connectors have a rising cage clamp which promotes numerous reliable connections and disconnections at field installations
- n All blocks are supplied with open screws which shortens the time for connection
- n The double captive screw system guards against lost screws

- n All metal parts are non-magnetic
- n The housing material used is halogen free Polyamide 6.6 according to UL 94V-0 (self-extinguishing); operating temperature -40°C to +105°C
- n The housing funnel entry design enables an easier product application
- n The open bottom design facilitates the PCB washing and reduces trapping of soldering fumes and dirt, with better insulation
- n Available on the board mount connectors is test probe access to determine if an electrical connection has been made
- n Contacts are post tinned with nickel underplate which allows the product to be used in specially corrosive environments

Board mount connectors, as well as pc board plugs and headers, are stackable end-

to-end without loss of centerline spacing.

Ease of assembly is facilitated by built-in interlocks on the housings. Pre-assembled products can be delivered upon request. Adhesive labels are available to number the cavities. Customer specific labeling is also available upon request.

Terminal Block connectors are interchangeable with most existing products and pc board footprint is fully compatible with existing Industry Standards.

Note: All part numbers are RoHS Compliant.

Terminal Block Board Mount Connectors

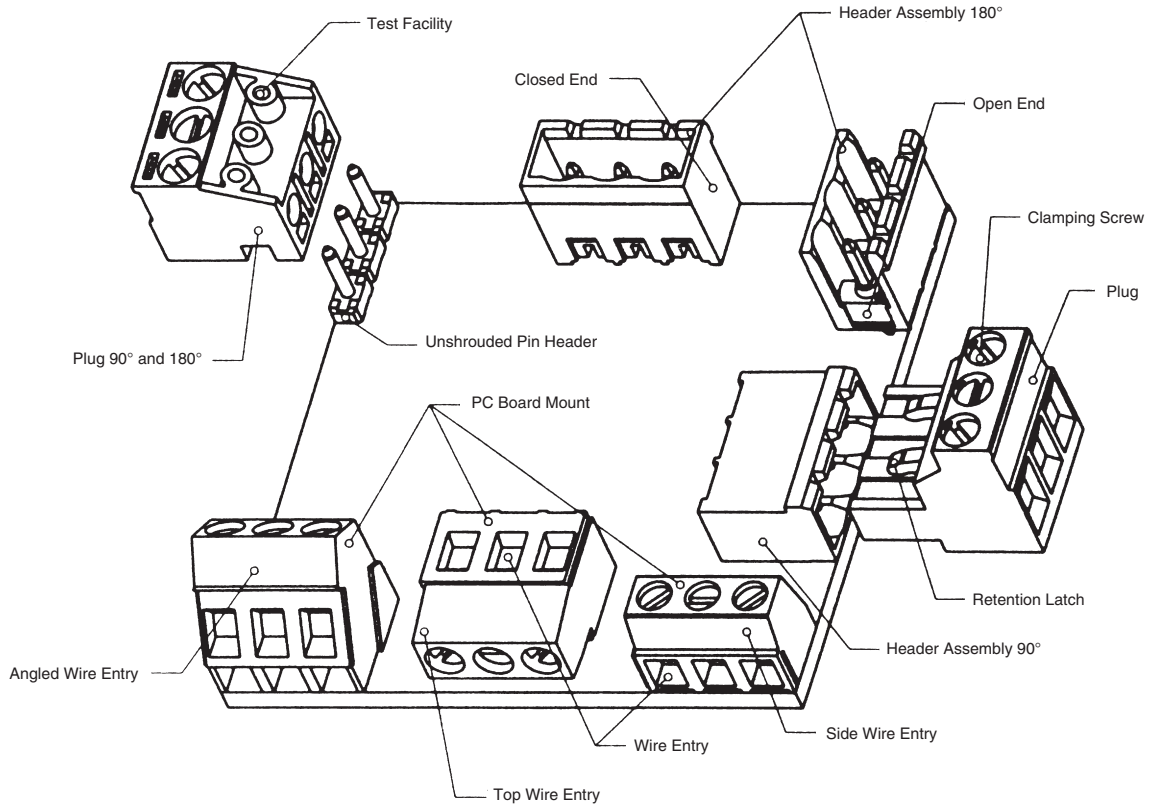

Eurostyle
1

Rising Cage Clamp Design

Cross Section One-Piece Connector

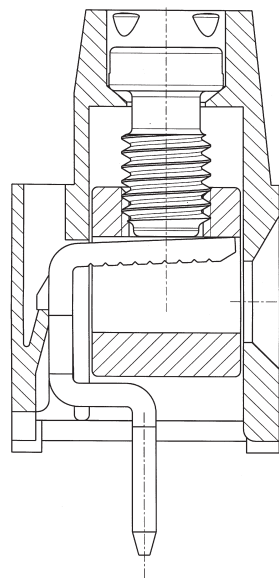

Cross Section Two-Piece Connector

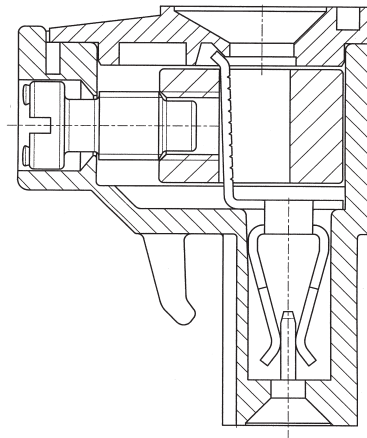

Note: All part numbers are RoHS Compliant.

Board Mount, Side Wire Entry

**Board Mount,
2.54 mm Centerline,
Side Wire Entry**
**UL Rating – 150 V, 10 A
16-30 AWG**

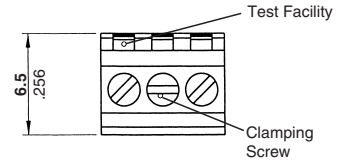
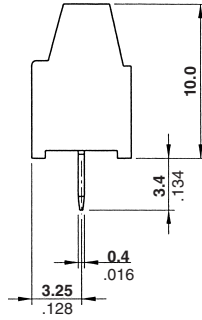
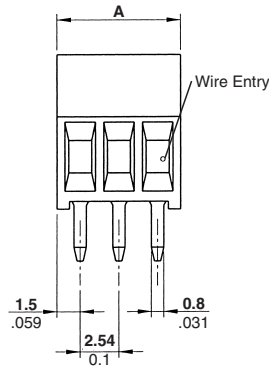
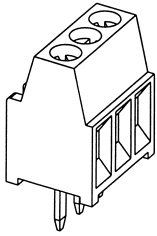

Recommended PC Board Layout

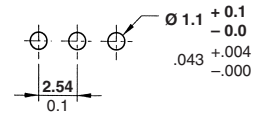

Suggested Screw Torque—
1.73 in.-lbs.

| No. of Positions | Dim. A | Part Numbers | |
|------------------|---------------|--------------|-------------|
| | | Green | Gray |
| 2 | 5.54 [0.218] | 282834-2 | 1546215-2 |
| 3 | 8.08 [0.318] | 282834-3 | 1546215-3 |
| 4 | 10.62 [0.418] | 282834-4 | 1546215-4 |
| 5 | 13.16 [0.518] | 282834-5 | 1546215-5 |
| 6 | 15.70 [0.618] | 282834-6 | 1546215-6 |
| 7 | 18.24 [0.718] | 282834-7 | 1546215-7 |
| 8 | 20.78 [0.818] | 282834-8 | 1546215-8 |
| 9 | 23.32 [0.918] | 282834-9 | 1546215-9 |
| 10 | 25.86 [1.018] | 1-282834-0 | 1-1546215-0 |
| 11 | 28.40 [1.118] | 1-282834-1 | 1-1546215-1 |
| 12 | 30.94 [1.218] | 1-282834-2 | 1-1546215-2 |

**Board Mount,
5.08 mm Centerline,
Side Wire Entry**
Color – Green
**UL Rating – 300 V, 10 A
16-30 AWG**

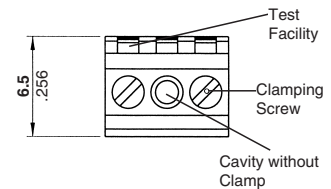
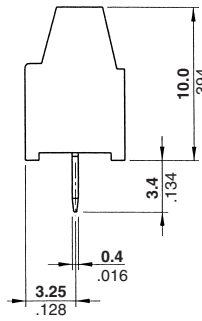
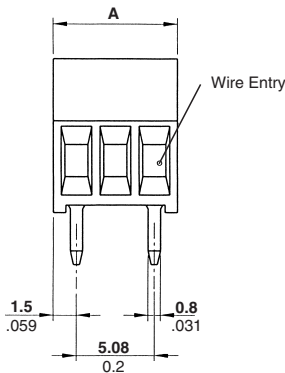
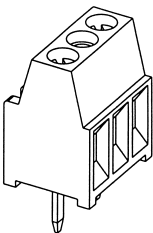

Recommended PC Board Layout

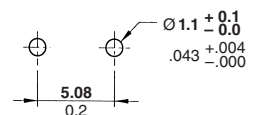

Suggested Screw Torque—
1.73 in.-lbs.

| No. of Positions | Dim. A | Part Numbers |
|------------------|---------------|--------------|
| 2 | 8.08 [0.318] | 282835-2 |
| 3 | 13.16 [0.518] | 282835-3 |
| 4 | 18.24 [0.718] | 282835-4 |
| 5 | 23.32 [0.918] | 282835-5 |
| 6 | 28.40 [1.118] | 282835-6 |

Note: All part numbers are RoHS Compliant.

Board Mount, Side Wire Entry

Board Mount w/Interlock, 3.5 mm Centerline, Side Wire Entry

**UL Rating – 300 V, 12 A
14-30 AWG**

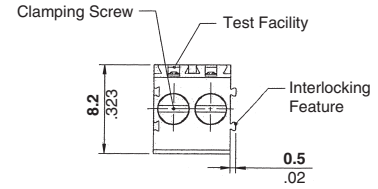
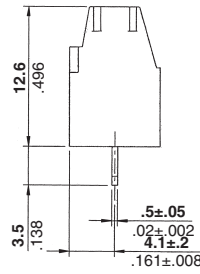
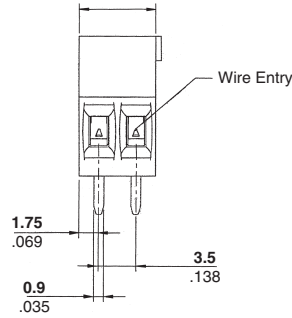
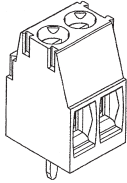

Recommended PC Board Layout

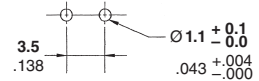

Suggested Screw Torque—
2.2 in.-lbs.

| No. of Positions | Dim. A | Part Numbers | |
|------------------|--------------|--------------|-------------|
| | | Green | Blue |
| 2 | 7.0 [0.276] | 284391-2 | 1546227-2 |
| 3 | 10.5 [0.413] | 284391-3 | 1546227-3 |
| 4 | 14.0 [0.551] | 284391-4 | 1546227-4 |
| 5 | 17.5 [0.689] | 284391-5 | 1546227-5 |
| 6 | 21.0 [0.827] | 284391-6 | 1546227-6 |
| 7 | 24.5 [0.965] | 284391-7 | 1546227-7 |
| 8 | 28.0 [1.102] | 284391-8 | 1546227-8 |
| 9 | 31.5 [1.240] | 284391-9 | 1546227-9 |
| 10 | 35.0 [1.378] | 1-284391-0 | 1-1546227-0 |
| 11 | 38.5 [1.516] | 1-284391-1 | 1-1546227-1 |
| 12 | 42.0 [1.654] | 1-284391-2 | 1-1546227-2 |
| 13 | 45.5 [1.791] | 1-284391-3 | 1-1546227-3 |

| No. of Positions | Dim. A | Part Numbers | |
|------------------|--------------|--------------|-------------|
| | | Green | Blue |
| 14 | 49.0 [1.929] | 1-284391-4 | 1-1546227-4 |
| 15 | 52.5 [2.067] | 1-284391-5 | 1-1546227-5 |
| 16 | 56.0 [2.205] | 1-284391-6 | 1-1546227-6 |
| 17 | 59.5 [2.343] | 1-284391-7 | 1-1546227-7 |
| 18 | 63.0 [2.480] | 1-284391-8 | 1-1546227-8 |
| 19 | 66.5 [2.618] | 1-284391-9 | 1-1546227-9 |
| 20 | 70.0 [2.756] | 2-284391-0 | 2-1546227-0 |
| 21 | 73.5 [2.894] | 2-284391-1 | 2-1546227-1 |
| 22 | 77.0 [3.031] | 2-284391-2 | 2-1546227-2 |
| 23 | 80.5 [3.169] | 2-284391-3 | 2-1546227-3 |
| 24 | 84.0 [3.307] | 2-284391-4 | 2-1546227-4 |
| 25 | 87.5 [3.445] | 2-284391-5 | 2-1546227-5 |

Board Mount 3.5 mm Centerline, Side Wire Entry

**UL Rating – 300 V, 12 A
16-28 AWG**

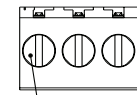
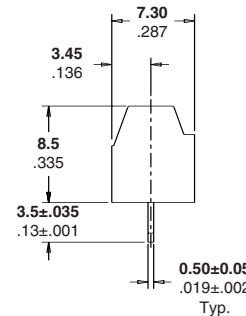
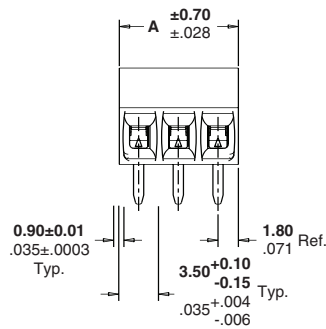
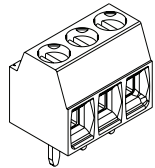

Recommended PC Board Layout

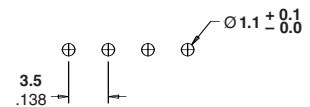

| No. of Positions | Dim. A | Part Numbers | |
|------------------|---------------|--------------|-------------|
| | | Black* | Green |
| 2 | 7.00 [276] | 1776112-2 | 1546551-2 |
| 3 | 10.50 [413] | 1776112-3 | 1546551-3 |
| 4 | 14.00 [551] | 1776112-4 | 1546551-4 |
| 5 | 17.50 [689] | — | 1546551-5 |
| 6 | 21.00 [827] | — | 1546551-6 |
| 7 | 24.50 [965] | — | 1546551-7 |
| 8 | 28.00 [1.102] | — | 1546551-8 |
| 9 | 31.50 [1.240] | — | 1546551-9 |
| 10 | 35.00 [1.378] | — | 1-1546551-0 |
| 11 | 38.50 [1.516] | — | 1-1546551-1 |
| 12 | 42.00 [1.654] | — | 1-1546551-2 |
| 13 | 45.50 [1.791] | — | 1-1546551-3 |

| No. of Positions | Dim. A | Part Numbers | |
|------------------|---------------|--------------|-------------|
| | | Black* | Green |
| 14 | 49.00 [1.929] | — | 1-1546551-4 |
| 15 | 52.50 [2.067] | — | 1-1546551-5 |
| 16 | 56.00 [2.205] | — | 1-1546551-6 |
| 17 | 59.50 [2.343] | — | 1-1546551-7 |
| 18 | 63.00 [2.480] | — | 1-1546551-8 |
| 19 | 66.50 [2.618] | — | 1-1546551-9 |
| 20 | 70.00 [2.756] | — | 2-1546551-0 |
| 21 | 73.50 [2.894] | — | 2-1546551-1 |
| 22 | 77.00 [3.031] | — | 2-1546551-2 |
| 23 | 80.50 [3.169] | — | 2-1546551-3 |
| 24 | 84.00 [3.307] | — | 2-1546551-4 |
| 25 | 87.50 [3.445] | — | 2-1546551-5 |

*Wave solder process capable to 265°C [509°F] for 10 seconds

Note: All part numbers are RoHS Compliant.

Board Mount, Side Wire Entry (Continued)

**Board Mount w/Interlock,
3.81 mm Centerline,
Side Wire Entry
Color – Green**

**UL Rating – 300 V, 12 A
14-30 AWG**

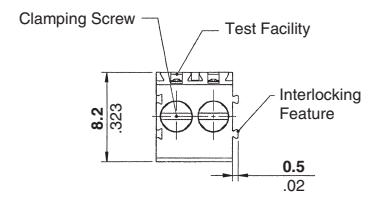
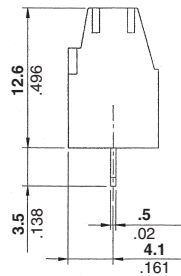
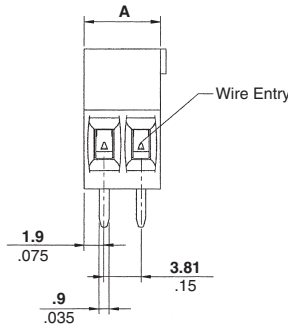
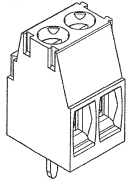

Recommended PC Board Layout

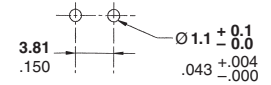

**Suggested Screw Torque—
2.2 in.-lbs.**

| No. of Positions | Dim. A | Part Numbers |
|------------------|---------------|--------------|
| 2 | 7.62 [0.300] | 284392-2 |
| 3 | 11.43 [0.450] | 284392-3 |
| 4 | 15.24 [0.600] | 284392-4 |
| 5 | 19.05 [0.750] | 284392-5 |
| 6 | 22.86 [0.900] | 284392-6 |
| 7 | 26.67 [1.050] | 284392-7 |
| 8 | 30.48 [1.200] | 284392-8 |
| 9 | 34.29 [1.350] | 284392-9 |
| 10 | 38.10 [1.500] | 1-284392-0 |
| 11 | 41.91 [1.650] | 1-284392-1 |
| 12 | 45.72 [1.800] | 1-284392-2 |
| 13 | 49.53 [1.950] | 1-284392-3 |

| No. of Positions | Dim. A | Part Numbers |
|------------------|---------------|--------------|
| 14 | 53.34 [2.100] | 1-284392-4 |
| 15 | 57.15 [2.250] | 1-284392-5 |
| 16 | 60.96 [2.400] | 1-284392-6 |
| 17 | 64.77 [2.550] | 1-284392-7 |
| 18 | 68.58 [2.700] | 1-284392-8 |
| 19 | 72.39 [2.850] | 1-284392-9 |
| 20 | 76.20 [3.000] | 2-284392-0 |
| 21 | 80.01 [3.150] | 2-284392-1 |
| 22 | 83.82 [3.300] | 2-284392-2 |
| 23 | 87.63 [3.450] | 2-284392-3 |
| 24 | 91.44 [3.600] | 2-284392-4 |
| 25 | 95.25 [3.750] | 2-284392-5 |

**Board Mount,
3.81 mm Centerline,
Side Wire Entry**

**UL Rating – 150 V, 12 A
16-28 AWG**

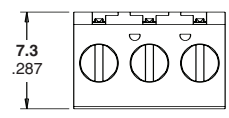
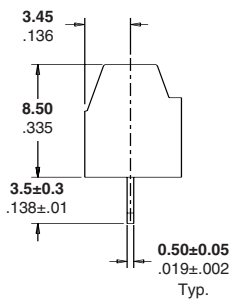
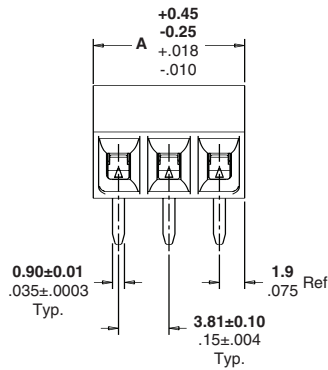
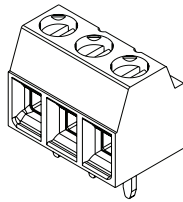

Recommended PC Board Layout

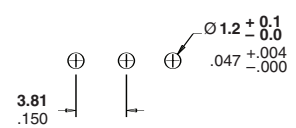

| No. of Positions | Dim. A | Part Numbers | |
|------------------|---------------|--------------|-------------|
| | | Black* | Green |
| 2 | 7.62 [.300] | 1776113-2 | 1546552-2 |
| 3 | 11.43 [.450] | 1776113-3 | 1546552-3 |
| 4 | 15.24 [.600] | 1776113-4 | 1546552-4 |
| 5 | 19.05 [.750] | 1776113-5 | 1546552-5 |
| 6 | 22.86 [.900] | 1776113-6 | 1546552-6 |
| 7 | 26.67 [1.050] | 1776113-7 | 1546552-7 |
| 8 | 30.48 [1.200] | 1776113-8 | 1546552-8 |
| 9 | 34.29 [1.350] | 1776113-9 | 1546552-9 |
| 10 | 38.10 [1.500] | 1-1776113-0 | 1-1546552-0 |
| 11 | 41.91 [1.650] | 1-1776113-1 | 1-1546552-1 |
| 12 | 45.72 [1.800] | 1-1776113-2 | 1-1546552-2 |
| 13 | 49.53 [1.950] | — | 1-1546552-3 |

| No. of Positions | Dim. A | Part Numbers | |
|------------------|---------------|--------------|-------------|
| | | Black* | Green |
| 14 | 53.34 [2.100] | — | 1-1546552-4 |
| 15 | 57.15 [2.250] | — | 1-1546552-5 |
| 16 | 60.96 [2.400] | — | 1-1546552-6 |
| 17 | 64.77 [2.550] | — | 1-1546552-7 |
| 18 | 68.58 [2.700] | — | 1-1546552-8 |
| 19 | 72.39 [2.850] | — | 1-1546552-9 |
| 20 | 76.20 [3.000] | — | 2-1546552-0 |
| 21 | 80.01 [3.150] | — | 2-1546552-1 |
| 22 | 83.82 [3.300] | — | 2-1546552-2 |
| 23 | 87.63 [3.450] | — | 2-1546552-3 |
| 24 | 91.44 [3.600] | — | 2-1546552-4 |
| 25 | 95.25 [3.750] | — | 2-1546552-5 |

*Wave solder process capable to 265°C [509°F] for 10 seconds

Note: All part numbers are RoHS Compliant.

Board Mount, Side Wire Entry (Continued)

Board Mount w/Interlock, Low Profile, 5.0 mm Centerline, Side Wire Entry

**UL Rating – 300 V, 13.5 A
16-30 AWG
10 A for field wiring applications**

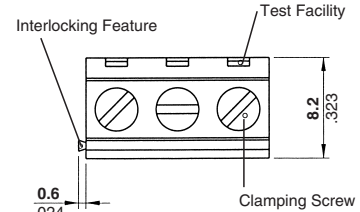
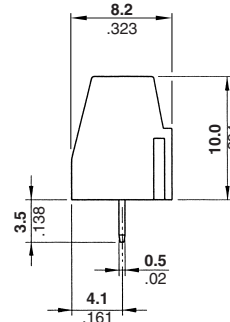
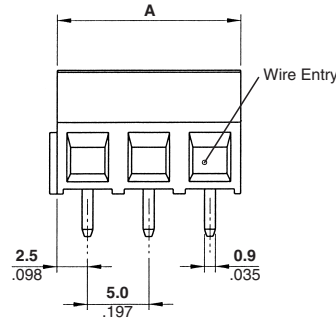
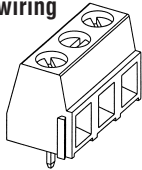

Recommended PC Board Layout

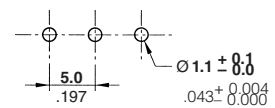

Suggested Screw Torque—
6.0 in.-lbs.

| No. of Positions | Dim. A | Part Numbers | | |
|------------------|--------------|--------------|-------------|-----------|
| | | Green | Gray | Black* |
| 2 | 10.0 [0.394] | 282836-2 | 1546216-2 | 1776118-2 |
| 3 | 15.0 [0.591] | 282836-3 | 1546216-3 | 1776118-3 |
| 4 | 20.0 [0.787] | 282836-4 | 1546216-4 | 1776118-4 |
| 5 | 25.0 [0.984] | 282836-5 | 1546216-5 | 1776118-5 |
| 6 | 30.0 [1.181] | 282836-6 | 1546216-6 | 1776118-6 |
| 7 | 35.0 [1.378] | 282836-7 | 1546216-7 | 1776118-7 |
| 8 | 40.0 [1.575] | 282836-8 | 1546216-8 | 1776118-8 |
| 9 | 45.0 [1.772] | 282836-9 | 1546216-9 | — |
| 10 | 50.0 [1.968] | 1-282836-0 | 1-1546216-0 | — |
| 11 | 55.0 [2.165] | 1-282836-1 | 1-1546216-1 | — |
| 12 | 60.0 [2.362] | 1-282836-2 | 1-1546216-2 | — |
| 13 | 65.0 [2.559] | 1-282836-4 | 1-1546216-3 | — |

| No. of Positions | Dim. A | Part Numbers | | |
|------------------|---------------|--------------|-------------|--------|
| | | Green | Gray | Black* |
| 14 | 70.0 [2.756] | 1-282836-5 | 1-1546216-4 | — |
| 15 | 75.0 [2.953] | 1-282836-6 | 1-1546216-5 | — |
| 16 | 80.0 [3.150] | 1-282836-7 | 1-1546216-6 | — |
| 17 | 85.0 [3.346] | 1-282836-8 | 1-1546216-7 | — |
| 18 | 90.0 [3.543] | 1-282836-9 | 1-1546216-8 | — |
| 19 | 95.0 [3.740] | 2-282836-0 | 1-1546216-9 | — |
| 20 | 100.0 [3.937] | 2-282836-1 | 2-1546216-0 | — |
| 21 | 105.0 [4.134] | 2-282836-2 | 2-1546216-1 | — |
| 22 | 110.0 [4.331] | 2-282836-3 | 2-1546216-2 | — |
| 23 | 115.0 [4.528] | 2-282836-4 | 2-1546216-3 | — |
| 24 | 120.0 [4.724] | 2-282836-5 | 2-1546216-4 | — |
| 25 | 125.0 [4.921] | 2-282836-6 | 2-1546216-5 | — |

*Wave solder process capable to 265°C [509°F] for 10 seconds

Board Mount w/Interlock, Low Profile, 5.08 mm Centerline, Side Wire Entry

**UL Rating – 300 V, 13.5 A
16-30 AWG
10 A for field wiring applications**

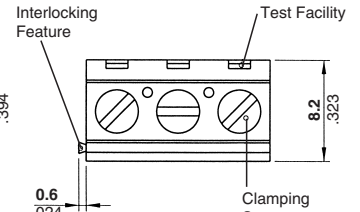
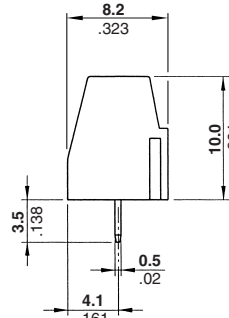
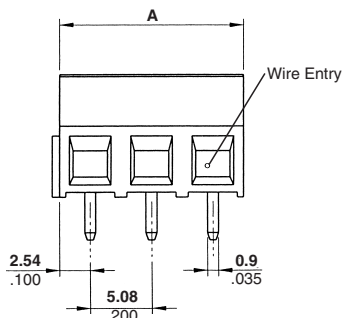
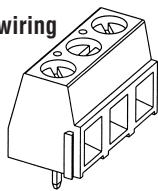

Recommended PC Board Layout

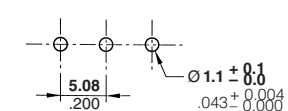

Suggested Screw Torque—
6.0 in.-lbs.

| No. of Positions | Dim. A | Part Numbers | | |
|------------------|---------------|--------------|-------------|-----------|
| | | Green | Gray | Black* |
| 2 | 10.16 [0.400] | 282837-2 | 1546217-2 | 1776119-2 |
| 3 | 15.24 [0.600] | 282837-3 | 1546217-3 | 1776119-3 |
| 4 | 20.32 [0.800] | 282837-4 | 1546217-4 | 1776119-4 |
| 5 | 25.40 [1.000] | 282837-5 | 1546217-5 | 1776119-5 |
| 6 | 30.48 [1.200] | 282837-6 | 1546217-6 | 1776119-6 |
| 7 | 35.56 [1.400] | 282837-7 | 1546217-7 | 1776119-7 |
| 8 | 40.64 [1.600] | 282837-8 | 1546217-8 | 1776119-8 |
| 9 | 45.72 [1.800] | 282837-9 | 1546217-9 | — |
| 10 | 50.80 [2.000] | 1-282837-0 | 1-1546217-0 | — |
| 11 | 55.88 [2.200] | 1-282837-1 | 1-1546217-1 | — |
| 12 | 60.96 [2.400] | 1-282837-2 | 1-1546217-2 | — |
| 13 | 66.04 [2.600] | 1-282837-6 | 1-1546217-6 | — |

| No. of Positions | Dim. A | Part Numbers | | |
|------------------|----------------|--------------|-------------|--------|
| | | Green | Gray | Black* |
| 14 | 71.12 [2.800] | 1-282837-7 | 1-1546217-7 | — |
| 15 | 76.20 [3.000] | 1-282837-8 | 1-1546217-8 | — |
| 16 | 81.28 [3.200] | 1-282837-9 | 1-1546217-9 | — |
| 17 | 86.36 [3.400] | 2-282837-0 | 2-1546217-0 | — |
| 18 | 91.44 [3.600] | 2-282837-1 | 2-1546217-1 | — |
| 19 | 96.52 [3.800] | 2-282837-2 | 2-1546217-2 | — |
| 20 | 101.60 [4.000] | 2-282837-3 | 2-1546217-3 | — |
| 21 | 106.68 [4.200] | 2-282837-4 | 2-1546217-4 | — |
| 22 | 111.76 [4.400] | 2-282837-5 | 2-1546217-5 | — |
| 23 | 116.84 [4.600] | 2-282837-6 | 2-1546217-6 | — |
| 24 | 121.92 [4.800] | 2-282837-7 | 2-1546217-7 | — |
| 25 | 127.00 [5.000] | 2-282837-8 | 2-1546217-8 | — |

*Wave solder process capable to 265°C [509°F] for 10 seconds

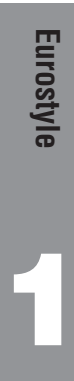

Note: All part numbers are RoHS Compliant.

Board Mount, Side Wire Entry (Continued)

**Board Mount w/Interlock,
5.0 mm Centerline,
Side Wire Entry**

**UL Rating – 300 V, 17.5 A
12-30 AWG
15 A for field wiring
applications**

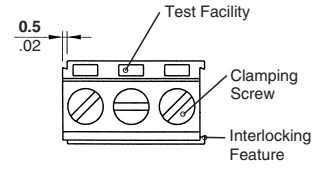
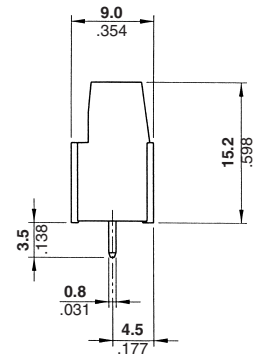
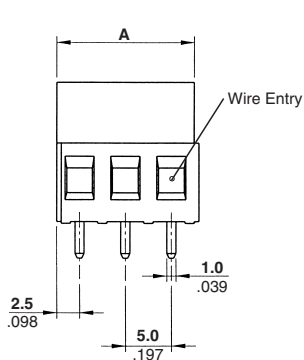
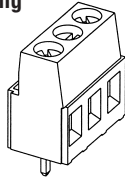

Recommended PC Board Layout

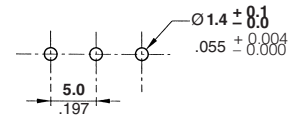

**Suggested Screw Torque—
7.0 in.-lbs.**

| No. of Positions | Dim. A | Part Numbers | | |
|------------------|--------------|--------------|------------|------------|
| | | Green | Blue | Black |
| 2 | 10.0 [0.394] | 796683-2 | 796681-2 | 796682-2 |
| 3 | 15.0 [0.591] | 796683-3 | 796681-3 | 796682-3 |
| 4 | 20.0 [0.787] | 796683-4 | 796681-4 | 796682-4 |
| 5 | 25.0 [0.984] | 796683-5 | 796681-5 | 796682-5 |
| 6 | 30.0 [1.181] | 796683-6 | 796681-6 | 796682-6 |
| 7 | 35.0 [1.378] | 796683-7 | 796681-7 | 796682-7 |
| 8 | 40.0 [1.575] | 796683-8 | 796681-8 | 796682-8 |
| 9 | 45.0 [1.772] | 796683-9 | 796681-9 | 796682-9 |
| 10 | 50.0 [1.968] | 1-796683-0 | 1-796681-0 | 1-796682-0 |
| 11 | 55.0 [2.165] | 1-796683-1 | 1-796681-1 | 1-796682-1 |
| 12 | 60.0 [2.362] | 1-796683-2 | 1-796681-2 | 1-796682-2 |
| 13 | 65.0 [2.559] | 1-796683-3 | 1-796681-3 | 1-796682-3 |

| No. of Positions | Dim. A | Part Numbers | | |
|------------------|---------------|--------------|------------|------------|
| | | Green | Blue | Black |
| 14 | 70.0 [2.756] | 1-796683-4 | 1-796681-4 | 1-796682-4 |
| 15 | 75.0 [2.953] | 1-796683-5 | 1-796681-5 | 1-796682-5 |
| 16 | 80.0 [3.150] | 1-796683-6 | 1-796681-6 | 1-796682-6 |
| 17 | 85.0 [3.346] | 1-796683-7 | 1-796681-7 | 1-796682-7 |
| 18 | 90.0 [3.543] | 1-796683-8 | 1-796681-8 | 1-796682-8 |
| 19 | 95.0 [3.740] | 1-796683-9 | 1-796681-9 | 1-796682-9 |
| 20 | 100.0 [3.937] | 2-796683-0 | 2-796681-0 | 2-796682-0 |
| 21 | 105.0 [4.134] | 2-796683-1 | 2-796681-1 | 2-796682-1 |
| 22 | 110.0 [4.331] | 2-796683-2 | 2-796681-2 | 2-796682-2 |
| 23 | 115.0 [4.528] | 2-796683-3 | 2-796681-3 | 2-796682-3 |
| 24 | 120.0 [4.724] | 2-796683-4 | 2-796681-4 | 2-796682-4 |
| 25 | 125.0 [4.921] | 2-796683-5 | 2-796681-5 | 2-796682-5 |

Note: BUCHANAN Terminal Block Series B02C4VxxT has been superceded/replaced with 796681-x.
RDI Terminal Block Series 5KEV-xx has been superceded/replaced with 796683-x (green) or 796682-x (black).

**Board Mount w/Interlock,
5.0 mm Centerline,
Side Wire Entry
Color – Green**

**UL Rating – 300 V, 24 A
12-30 AWG
20 A for field wiring
applications**

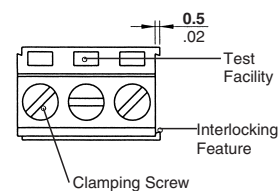
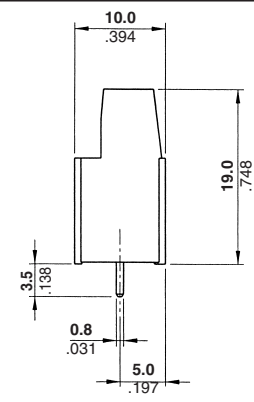
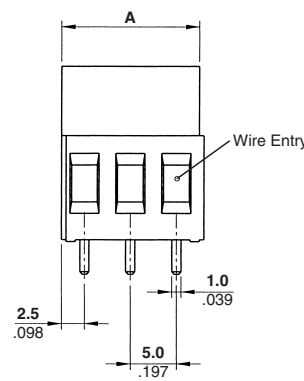
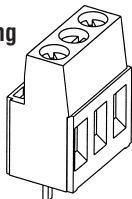

Recommended PC Board Layout

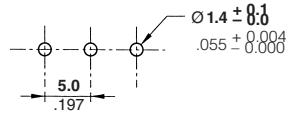

**Suggested Screw Torque—
7.0 in.-lbs.**

| No. of Positions | Dim. A | Part Number |
|------------------|--------------|-------------|
| 2 | 10.0 [.394] | 282856-2 |
| 3 | 15.0 [.591] | 282856-3 |
| 4 | 20.0 [.787] | 282856-4 |
| 5 | 25.0 [.984] | 282856-5 |
| 6 | 30.0 [1.181] | 282856-6 |
| 7 | 35.0 [1.378] | 282856-7 |
| 8 | 40.0 [1.575] | 282856-8 |
| 9 | 45.0 [1.772] | 282856-9 |
| 10 | 50.0 [1.968] | 1-282856-0 |
| 11 | 55.0 [2.165] | 1-282856-1 |
| 12 | 60.0 [2.362] | 1-282856-2 |
| 13 | 65.0 [2.559] | 1-282856-3 |

| No. of Positions | Dim. A | Part Number |
|------------------|---------------|-------------|
| 14 | 70.0 [2.756] | 1-282856-5 |
| 15 | 75.0 [2.953] | 1-282856-6 |
| 16 | 80.0 [3.150] | 1-282856-7 |
| 17 | 85.0 [3.346] | 1-282856-8 |
| 18 | 90.0 [3.543] | 1-282856-9 |
| 19 | 95.0 [3.740] | 2-282856-0 |
| 20 | 100.0 [3.937] | 2-282856-1 |
| 21 | 105.0 [4.134] | 2-282856-2 |
| 22 | 110.0 [4.331] | 2-282856-3 |
| 23 | 115.0 [4.528] | 2-282856-4 |
| 24 | 120.0 [4.724] | 2-282856-5 |
| 25 | 125.0 [4.921] | 2-282856-6 |

Note: All part numbers are RoHS Compliant.

Board Mount, Side Wire Entry (Continued)

Board Mount w/Interlock, 5.08 mm Centerline, Side Wire Entry

UL Rating – 300 V, 17.5 A 12-30 AWG 15 A for field wiring applications

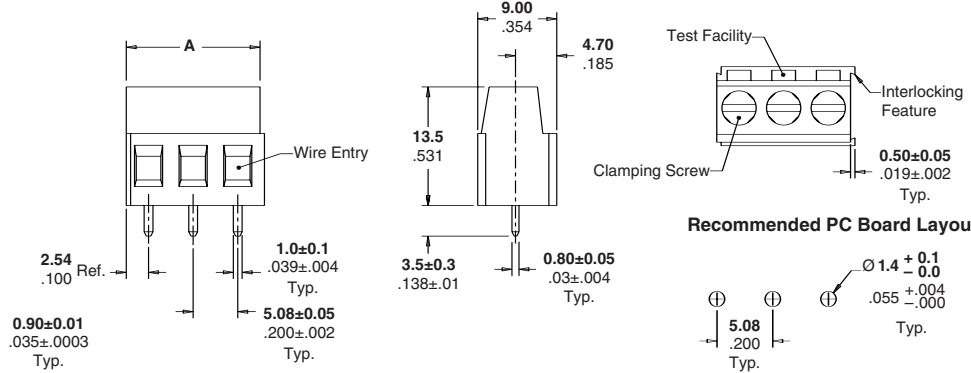
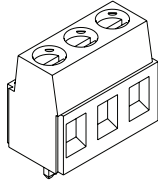

| No. of Positions | Dim. A | Part Numbers | |
|------------------|---------------|--------------|------------|
| | | Black* | Green |
| 2 | 10.16 [0.400] | 1776126-2 | 796911-2 |
| 3 | 15.24 [0.600] | 1776126-3 | 796911-3 |
| 4 | 20.32 [0.800] | — | 796911-4 |
| 5 | 25.40 [1.000] | — | 796911-5 |
| 6 | 30.48 [1.200] | — | 796911-6 |
| 7 | 35.56 [1.400] | — | 796911-7 |
| 8 | 40.64 [1.600] | — | 796911-8 |
| 9 | 45.72 [1.800] | — | 796911-9 |
| 10 | 50.80 [2.000] | — | 1-796911-0 |
| 11 | 55.88 [2.200] | — | 1-796911-1 |
| 12 | 60.96 [2.400] | — | 1-796911-2 |
| 13 | 66.04 [2.600] | — | 1-796911-3 |

*Wave solder process capable to 265°C [509°F] for 10 seconds

| No. of Positions | Dim. A | Part Numbers | |
|------------------|----------------|--------------|------------|
| | | Black* | Green |
| 14 | 71.12 [2.800] | — | 1-796911-4 |
| 15 | 76.20 [3.000] | — | 1-796911-5 |
| 16 | 81.28 [3.200] | — | 1-796911-6 |
| 17 | 86.36 [3.400] | — | 1-796911-7 |
| 18 | 91.44 [3.600] | — | 1-796911-8 |
| 19 | 96.52 [3.800] | — | 1-796911-9 |
| 20 | 101.60 [4.000] | — | 2-796911-0 |
| 21 | 106.68 [4.200] | — | 2-796911-1 |
| 22 | 111.76 [4.400] | — | 2-796911-2 |
| 23 | 116.84 [4.600] | — | 2-796911-3 |
| 24 | 121.92 [4.800] | — | 2-796911-4 |
| 25 | 127.00 [5.000] | — | 2-796911-5 |

Board Mount w/Interlock, 5.08 mm Centerline, Side Wire Entry

UL Rating – 300 V, 17.5 A 12-30 AWG 15 A for field wiring applications

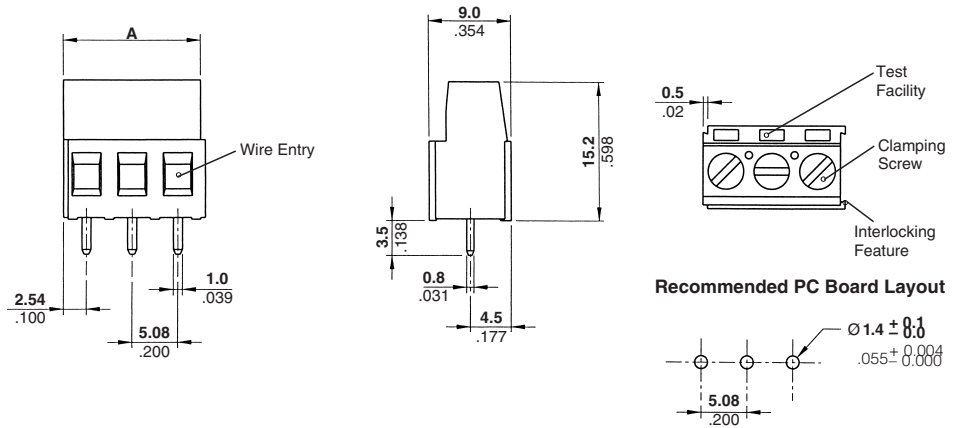
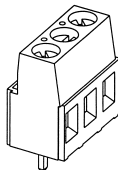

Suggested Screw Torque—
7.0 in.-lbs.

| No. of Positions | Dim. A | Part Numbers | | |
|------------------|---------------|--------------|------------|-------------|
| | | Green | Black | Gray |
| 2 | 10.16 [0.400] | 282841-2 | 796949-2 | 1546218-2 |
| 3 | 15.24 [0.600] | 282841-3 | 796949-3 | 1546218-3 |
| 4 | 20.32 [0.800] | 282841-4 | 796949-4 | 1546218-4 |
| 5 | 25.40 [1.000] | 282841-5 | 796949-5 | 1546218-5 |
| 6 | 30.48 [1.200] | 282841-6 | 796949-6 | 1546218-6 |
| 7 | 35.56 [1.400] | 282841-7 | 796949-7 | 1546218-7 |
| 8 | 40.64 [1.600] | 282841-8 | 796949-8 | 1546218-8 |
| 9 | 45.72 [1.800] | 282841-9 | 796949-9 | 1546218-9 |
| 10 | 50.80 [2.000] | 1-282841-0 | 1-796949-0 | 1-1546218-0 |
| 11 | 55.88 [2.200] | 1-282841-1 | 1-796949-1 | 1-1546218-1 |
| 12 | 60.96 [2.400] | 1-282841-2 | 1-796949-2 | 1-1546218-2 |
| 13 | 66.04 [2.600] | 1-282841-6 | 1-796949-3 | 1-1546218-3 |

| No. of Positions | Dim. A | Part Numbers | | |
|------------------|----------------|--------------|------------|-------------|
| | | Green | Black | Gray |
| 14 | 71.12 [2.800] | 1-282841-7 | 1-796949-4 | 1-1546218-4 |
| 15 | 76.20 [3.000] | 1-282841-8 | 1-796949-5 | 1-1546218-5 |
| 16 | 81.28 [3.200] | 1-282841-9 | 1-796949-6 | 1-1546218-6 |
| 17 | 86.36 [3.400] | 2-282841-0 | 1-796949-7 | 1-1546218-7 |
| 18 | 91.44 [3.600] | 2-282841-1 | 1-796949-8 | 1-1546218-8 |
| 19 | 96.52 [3.800] | 2-282841-2 | 1-796949-9 | 1-1546218-9 |
| 20 | 101.60 [4.000] | 2-282841-3 | 2-796949-0 | 2-1546218-0 |
| 21 | 106.68 [4.200] | 2-282841-4 | 2-796949-1 | 2-1546218-1 |
| 22 | 111.76 [4.400] | 2-282841-5 | 2-796949-2 | 2-1546218-2 |
| 23 | 116.84 [4.600] | 2-282841-6 | 2-796949-3 | 2-1546218-3 |
| 24 | 121.92 [4.800] | 2-282841-7 | 2-796949-4 | 2-1546218-4 |
| 25 | 127.00 [5.000] | 2-282841-8 | 2-796949-5 | 2-1546218-5 |

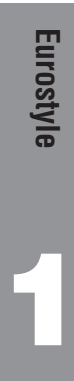

Note: All part numbers are RoHS Compliant.

Board Mount, Side Wire Entry (Continued)

Board Mount w/Interlock, 5.08 mm Centerline, Side Wire Entry
Color – Green

UL Rating – 300 V, 24 A
12-30 AWG
20 A for field wiring applications

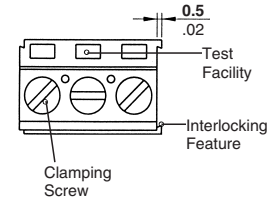
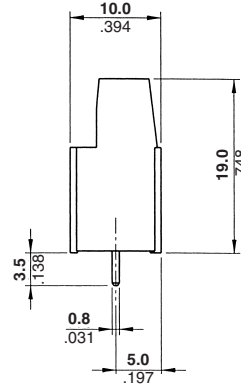
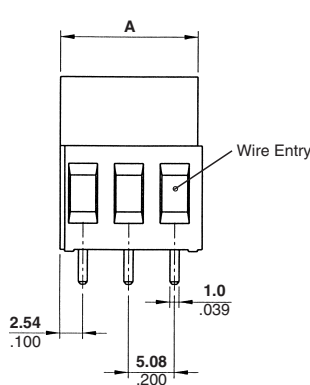
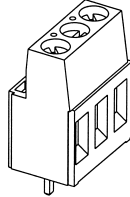

Recommended PC Board Layout

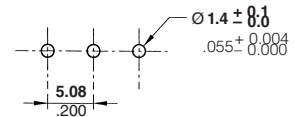

Suggested Screw Torque—
7.0 in.-lbs.

| No. of Positions | Dim. A | Part Numbers |
|------------------|---------------|--------------|
| 2 | 10.16 [0.400] | 282857-2 |
| 3 | 15.24 [0.600] | 282857-3 |
| 4 | 20.32 [0.800] | 282857-4 |
| 5 | 25.40 [1.000] | 282857-5 |
| 6 | 30.48 [1.200] | 282857-6 |
| 7 | 35.56 [1.400] | 282857-7 |
| 8 | 40.64 [1.600] | 282857-8 |
| 9 | 45.72 [1.800] | 282857-9 |
| 10 | 50.80 [2.000] | 1-282857-0 |
| 11 | 55.88 [2.200] | 1-282857-1 |
| 12 | 60.96 [2.400] | 1-282857-2 |
| 13 | 66.04 [2.600] | 1-282857-3 |

| No. of Positions | Dim. A | Part Numbers |
|------------------|----------------|--------------|
| 14 | 71.12 [2.800] | 1-282857-4 |
| 15 | 76.20 [3.000] | 1-282857-5 |
| 16 | 81.28 [3.200] | 1-282857-6 |
| 17 | 86.36 [3.400] | 1-282857-7 |
| 18 | 91.44 [3.600] | 1-282857-8 |
| 19 | 96.52 [3.800] | 1-282857-9 |
| 20 | 101.60 [4.000] | 2-282857-0 |
| 21 | 106.68 [4.200] | 2-282857-1 |
| 22 | 111.76 [4.400] | 2-282857-2 |
| 23 | 116.84 [4.600] | 2-282857-3 |
| 24 | 121.92 [4.800] | 2-282857-4 |
| 25 | 127.00 [5.000] | 2-282857-5 |

Board Mount w/Interlock, 7.5 mm Centerline, Side Wire Entry
Color – Green

UL Rating – 300 V, 17.5 A
12-30 AWG
15 A for field wiring applications

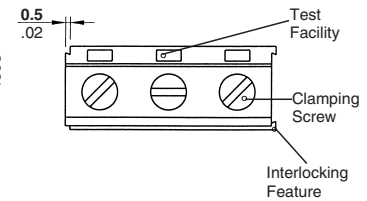
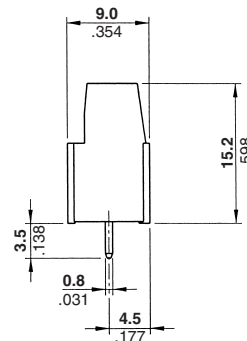
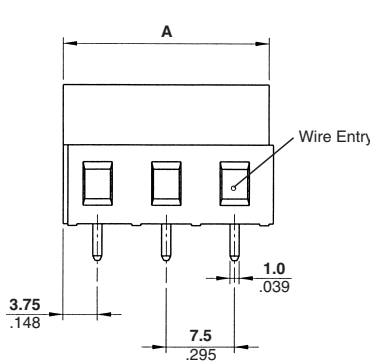
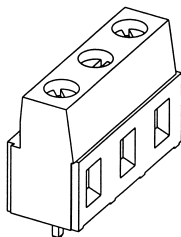

Recommended PC Board Layout

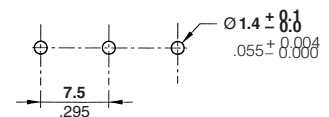

Suggested Screw Torque—
7.0 in.-lbs.

| No. of Positions | Dim. A | Part Numbers |
|------------------|--------------|--------------|
| 2 | 15.0 [0.591] | 282844-2 |
| 3 | 22.5 [0.886] | 282844-3 |
| 4 | 30.0 [1.181] | 282844-4 |

Note: All part numbers are RoHS Compliant.

Board Mount, Side Wire Entry (Continued)

Board Mount w/Interlock, 7.5 mm Centerline, Side Wire Entry

**UL Rating – 300 V, 24 A
12-30 AWG
20 A for field wiring applications**

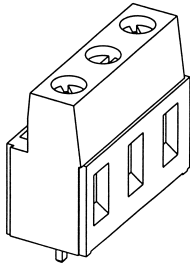

Suggested Screw Torque—
7.0 in.-lbs.

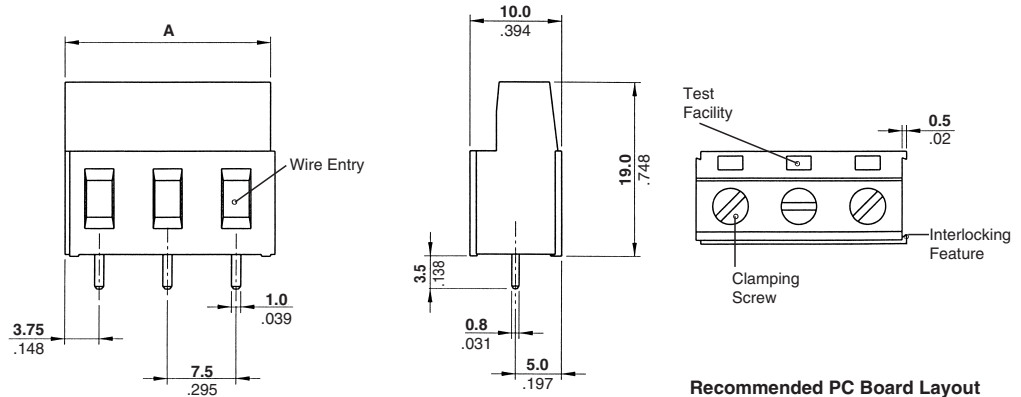

Recommended PC Board Layout

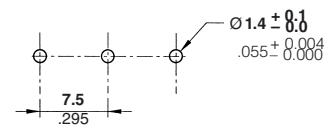

| No. of Positions | Dim. A | Part Numbers | |
|------------------|--------------|--------------|-----------|
| | | Green | Black |
| 2 | 15.0 [0.591] | 282860-2 | 1546062-2 |
| 3 | 22.5 [0.886] | 282860-3 | 1546062-3 |
| 4 | 30.0 [1.181] | 282860-4 | 1546062-4 |

**Board Mount w/Interlock, 7.62 mm Centerline, Side Wire Entry
Color – Green**

**UL Rating – 300 V, 17.5 A
12-30 AWG
15 A for field wiring applications**

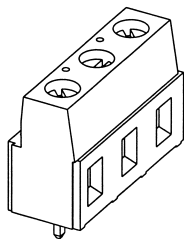

Suggested Screw Torque—
7.0 in.-lbs.

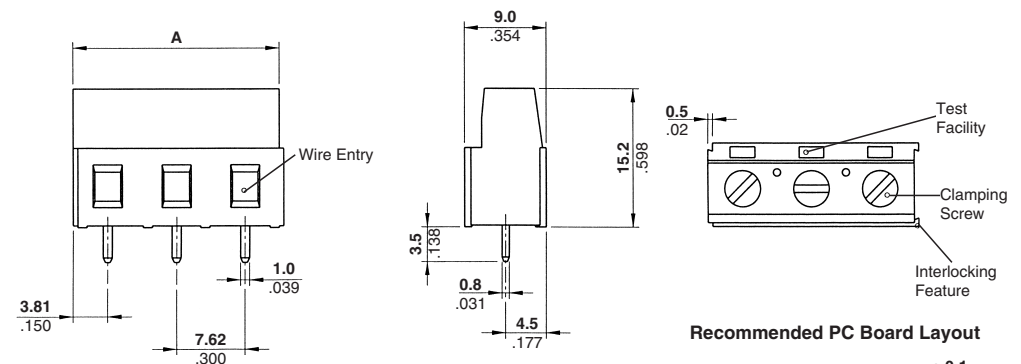

Recommended PC Board Layout

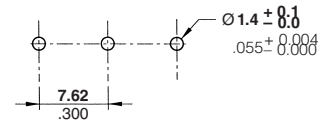

| No. of Positions | Dim. A | Part Numbers |
|------------------|--------------|--------------|
| 2 | 15.24 [.600] | 282845-2 |
| 3 | 22.86 [.900] | 282845-3 |

Note: All part numbers are RoHS Compliant.

Board Mount, Side Wire Entry (Continued)

**Board Mount w/Interlock,
7.62 mm Centerline,
Side Wire Entry
Color – Green**

**UL Rating – 300 V, 24 A
12-30 AWG
20 A for field wiring applications**

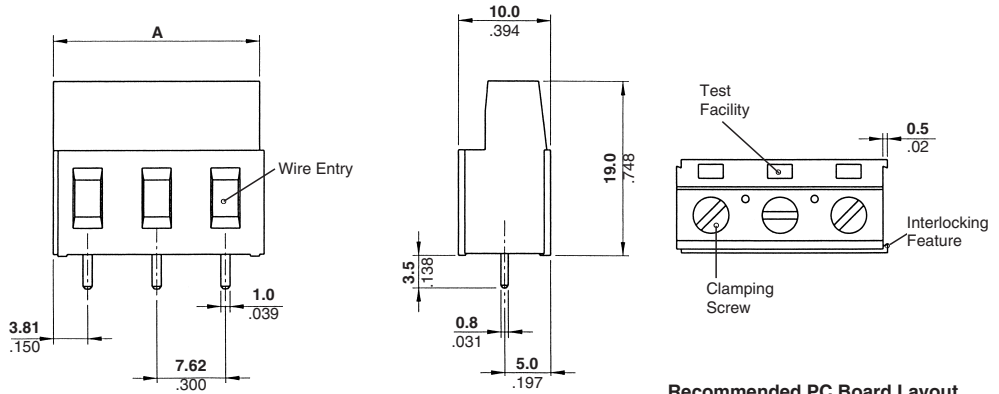
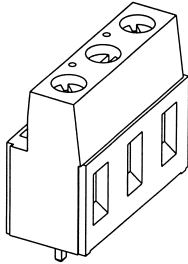

Recommended PC Board Layout

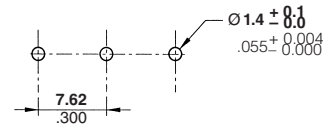

Suggested Screw Torque—
7.0 in.-lbs.

| No. of Positions | Dim. A | Part Numbers |
|------------------|--------------|--------------|
| 2 | 15.24 [.600] | 282861-2 |
| 3 | 22.86 [.900] | 282861-3 |

**Board Mount, Low Profile,
10.0 mm Centerline,
Side Wire Entry**

**UL Rating – 600 V, 13.5 A
16-30 AWG
10 A for field wiring applications**

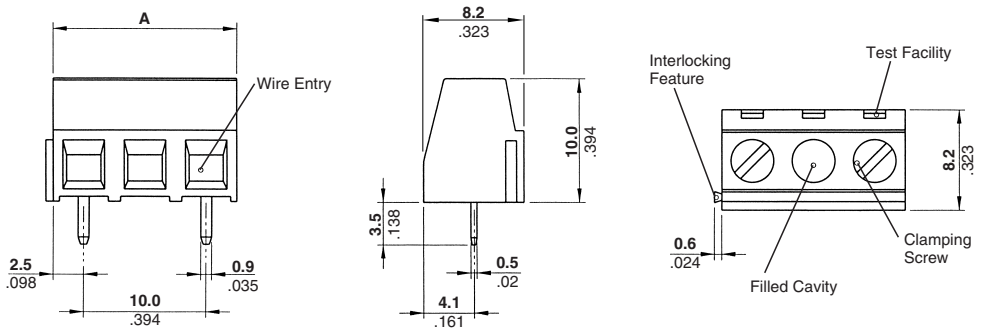
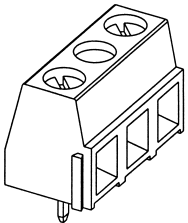

Recommended PC Board Layout

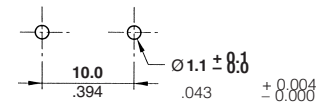

Suggested Screw Torque—
6.0 in.-lbs.

| No. of Positions | Dim. A | Part Numbers | |
|------------------|---------------|--------------|-----------|
| | | Green | Black* |
| 2 | 15.0 [0.591] | 282838-2 | 1776112-2 |
| 3 | 25.0 [0.984] | 282838-3 | 1776112-3 |
| 4 | 35.0 [1.378] | 282838-4 | 1776112-4 |
| 5 | 45.0 [1.772] | 282838-5 | — |
| 6 | 55.0 [2.165] | 282838-6 | — |
| 7 | 65.0 [2.559] | 282838-8 | — |
| 8 | 75.0 [2.953] | 282838-9 | — |
| 9 | 85.0 [3.346] | 1-282838-0 | — |
| 10 | 95.0 [3.740] | 1-282838-1 | — |
| 11 | 105.0 [4.134] | 1-282838-2 | — |
| 12 | 115.0 [4.528] | 1-282838-3 | — |
| 13 | 125.0 [4.921] | 1-282838-4 | — |

*Wave solder process capable to 265°C [509°F] for 10 seconds

Note: All part numbers are RoHS Compliant.

Board Mount, Side Wire Entry (Continued)

Board Mount
10.0 mm Centerline,
Side Wire Entry
Color – Green
UL Rating – 600 V, 17.5 A
12-30 AWG
15 A for field wiring applications

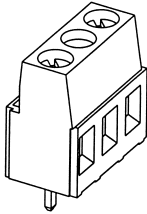

Suggested Screw Torque—
 7.0 in.-lbs.

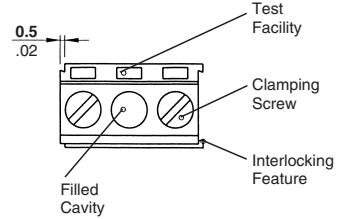
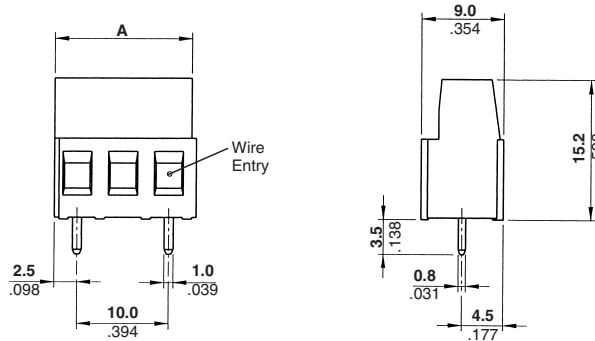

Recommended PC Board Layout

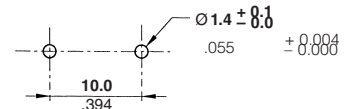

| No. of Positions | Dim. A | Part Numbers |
|------------------|---------------|--------------|
| 2 | 15.0 [0.591] | 282842-2 |
| 3 | 25.0 [0.984] | 282842-3 |
| 4 | 35.0 [1.378] | 282842-4 |
| 5 | 45.0 [1.772] | 282842-5 |
| 6 | 55.0 [2.165] | 282842-6 |
| 7 | 65.0 [2.559] | 282842-7 |
| 8 | 75.0 [2.953] | 282842-8 |
| 9 | 85.0 [3.346] | 282842-9 |
| 10 | 95.0 [3.740] | 1-282842-0 |
| 11 | 105.0 [4.134] | 1-282842-1 |
| 12 | 115.0 [4.528] | 1-282842-2 |
| 13 | 125.0 [4.921] | 1-282842-3 |

Board Mount
10.0 mm Centerline,
Side Wire Entry
Color – See Chart
UL Rating – 600 V, 24 A
12-30 AWG
20 A for field wiring applications

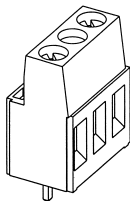

Suggested Screw Torque—
 7.0 in.-lbs.

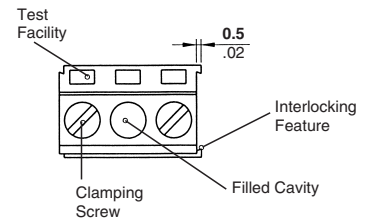
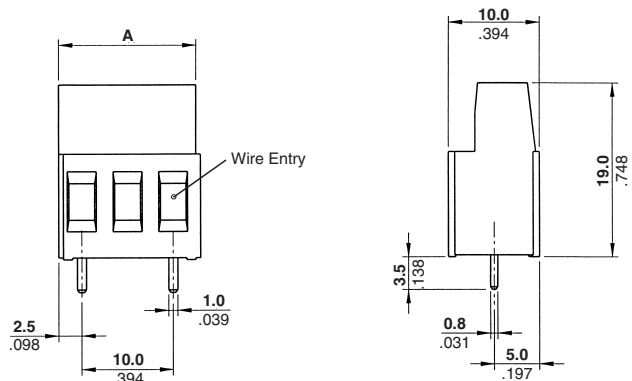

Recommended PC Board Layout

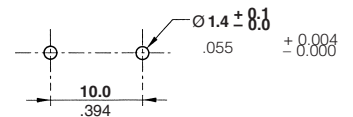

| No. of Positions | Dim. A | Part Numbers | |
|------------------|--------------|--------------|----------|
| | | Green | Blue |
| 2 | 15.0 [0.591] | 282858-2 | 796704-2 |
| 3 | 25.0 [0.984] | 282858-3 | 796704-3 |
| 4 | 35.0 [1.378] | 282858-4 | 796704-4 |
| 5 | 45.0 [1.772] | 282858-5 | 796704-5 |
| 6 | 55.0 [2.165] | 282858-6 | 796704-6 |
| 7 | 65.0 [2.559] | 282858-7 | 796704-7 |

| No. of Positions | Dim. A | Part Numbers | |
|------------------|---------------|--------------|------------|
| | | Green | Blue |
| 8 | 75.0 [2.953] | 282858-8 | 796704-8 |
| 9 | 85.0 [3.346] | 282858-9 | 796704-9 |
| 10 | 95.0 [3.740] | 1-282858-0 | 1-796704-0 |
| 11 | 105.0 [4.134] | 1-282858-1 | 1-796704-1 |
| 12 | 115.0 [4.528] | 1-282858-2 | 1-796704-2 |
| 13 | 125.0 [4.921] | 1-282858-3 | 1-796704-3 |

Note: BUCHANAN Terminal Block Series B03C5VxxT has been superseded/replaced with 796704-x.

Note: All part numbers are RoHS Compliant.

Board Mount, Side Wire Entry (Continued)

Board Mount w/Interlock, Low Profile, 10.16 mm Centerline, Side Wire Entry

UL Rating – 300 V, 13.5 A 16-30 AWG 15 A for field wiring applications

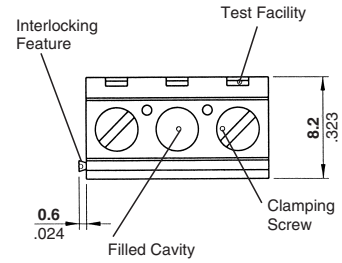
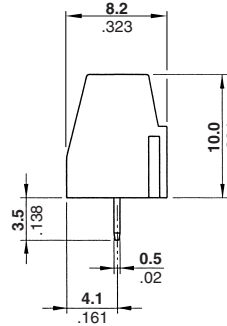
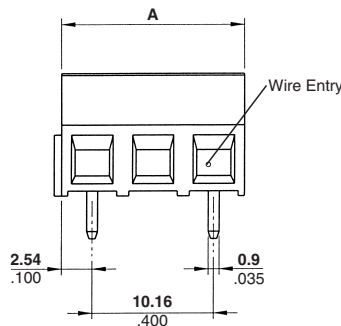
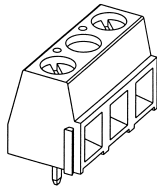

Recommended PC Board Layout

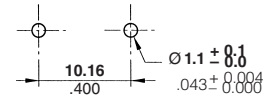

Suggested Screw Torque—
6.0 in.-lbs.

| No. of Positions | Dim. A | Part Numbers | |
|------------------|---------------|--------------|-----------|
| | | Green | Black* |
| 2 | 15.24 [0.600] | 282839-2 | 1776123-2 |
| 3 | 25.40 [1.000] | 282839-3 | 1776123-3 |
| 4 | 35.56 [1.400] | 282839-4 | 1776123-4 |
| 5 | 45.72 [1.800] | 282839-5 | — |
| 6 | 55.88 [2.200] | 282839-6 | — |
| 7 | 66.04 [2.600] | 282839-7 | — |

*Wave solder process capable to 265°C [509°F] for 10 seconds

| No. of Positions | Dim. A | Part Numbers | |
|------------------|----------------|--------------|--------|
| | | Green | Black* |
| 8 | 76.20 [3.000] | 282839-8 | — |
| 9 | 86.36 [3.400] | 282839-9 | — |
| 10 | 96.52 [3.800] | 1-282839-0 | — |
| 11 | 106.68 [4.200] | 1-282839-1 | — |
| 12 | 116.84 [4.600] | 1-282839-2 | — |
| 13 | 127.00 [5.000] | 1-282839-3 | — |

Board Mount 10.16 mm Centerline, Side Wire Entry Color – Green

UL Rating – 600 V, 17.5 A 12-30 AWG 15 A for field wiring applications

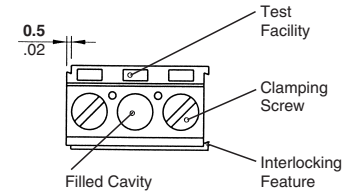
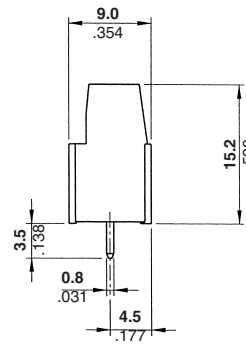
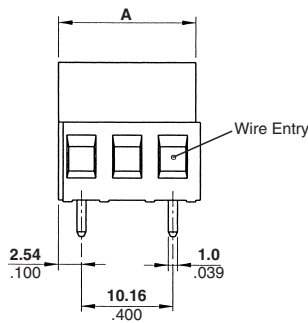
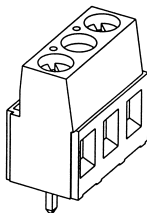

Recommended PC Board Layout

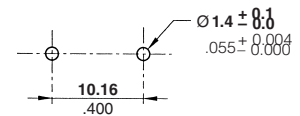

Suggested Screw Torque—
7.0 in.-lbs.

| No. of Positions | Dim. A | Part Numbers |
|------------------|---------------|--------------|
| 2 | 15.24 [0.600] | 282843-2 |
| 3 | 25.40 [1.000] | 282843-3 |
| 4 | 35.56 [1.400] | 282843-4 |
| 5 | 45.72 [1.800] | 282843-5 |
| 6 | 55.88 [2.200] | 282843-6 |
| 7 | 66.04 [2.600] | 282843-7 |

| No. of Positions | Dim. A | Part Numbers |
|------------------|----------------|--------------|
| 8 | 76.20 [3.000] | 282843-8 |
| 9 | 86.36 [3.400] | 282843-9 |
| 10 | 96.52 [3.800] | 1-282843-0 |
| 11 | 106.68 [4.200] | 1-282843-1 |
| 12 | 116.84 [4.600] | 1-282843-2 |
| 13 | 127.00 [5.000] | 1-282843-3 |

Note: All part numbers are RoHS Compliant.

Board Mount, Top Wire Entry

Board Mount w/Interlock, 3.5 mm Centerline, Top Wire Entry, Color – Green

UL Rating – 300 V, 12 A 14-30 AWG

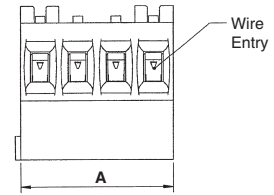
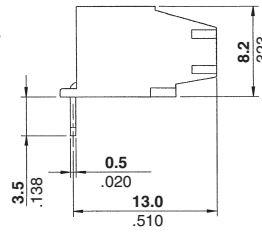
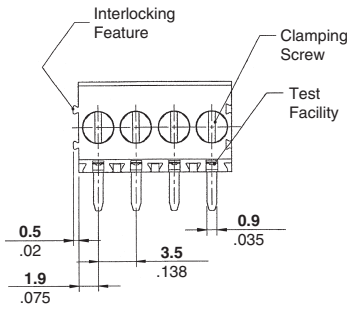
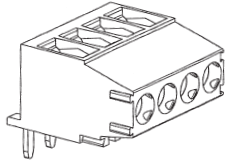

Recommended PC Board Layout

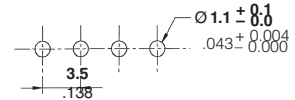

Suggested Screw Torque—
2.2 in.-lbs.

| No. of Positions | Dim. A | Part Numbers |
|------------------|--------------|--------------|
| 2 | 7.0 [0.276] | 284414-2 |
| 3 | 10.5 [0.413] | 284414-3 |
| 4 | 14.0 [0.551] | 284414-4 |
| 5 | 17.5 [0.689] | 284414-5 |
| 6 | 21.0 [0.827] | 284414-6 |
| 7 | 24.5 [0.965] | 284414-7 |
| 8 | 28.0 [1.102] | 284414-8 |
| 9 | 31.5 [1.240] | 284414-9 |
| 10 | 35.0 [1.378] | 1-284414-0 |
| 11 | 38.5 [1.516] | 1-284414-1 |
| 12 | 42.0 [1.654] | 1-284414-2 |
| 13 | 45.5 [1.791] | 1-284414-3 |

| No. of Positions | Dim. A | Part Numbers |
|------------------|--------------|--------------|
| 14 | 49.0 [1.929] | 1-284414-4 |
| 15 | 52.5 [2.067] | 1-284414-5 |
| 16 | 56.0 [2.205] | 1-284414-6 |
| 17 | 59.5 [2.343] | 1-284414-7 |
| 18 | 63.0 [2.480] | 1-284414-8 |
| 19 | 66.5 [2.618] | 1-284414-9 |
| 20 | 70.0 [2.756] | 2-284414-0 |
| 21 | 73.5 [2.894] | 2-284414-1 |
| 22 | 77.0 [3.031] | 2-284414-2 |
| 23 | 80.5 [3.169] | 2-284414-3 |
| 24 | 84.0 [3.307] | 2-284414-4 |
| 25 | 87.5 [3.445] | 2-284414-5 |

Board Mount w/Interlock, 3.81 mm Centerline, Top Wire Entry, Color – Green

UL Rating – 300 V, 12 A 14-30 AWG

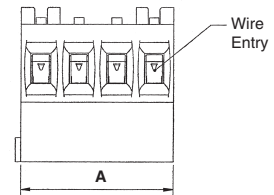
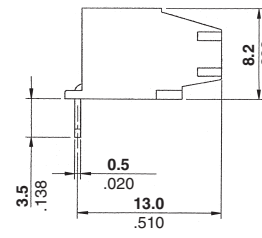
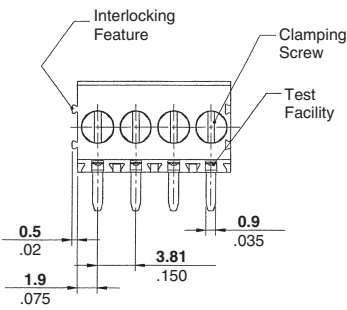
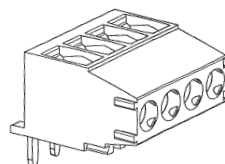

Recommended PC Board Layout

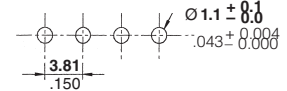

Suggested Screw Torque—
2.2 in.-lbs.

| No. of Positions | Dim. A | Part Numbers |
|------------------|---------------|--------------|
| 2 | 7.62 [0.300] | 284415-2 |
| 3 | 11.43 [0.450] | 284415-3 |
| 4 | 15.24 [0.600] | 284415-4 |
| 5 | 19.05 [0.750] | 284415-5 |
| 6 | 22.86 [0.900] | 284415-6 |
| 7 | 26.67 [1.050] | 284415-7 |
| 8 | 30.48 [1.200] | 284415-8 |
| 9 | 34.29 [1.350] | 284415-9 |
| 10 | 38.10 [1.500] | 1-284415-0 |
| 11 | 41.91 [1.650] | 1-284415-1 |
| 12 | 45.72 [1.800] | 1-284415-2 |
| 13 | 49.53 [1.950] | 1-284415-3 |

| No. of Positions | Dim. A | Part Numbers |
|------------------|---------------|--------------|
| 14 | 53.34 [2.100] | 1-284415-4 |
| 15 | 57.15 [2.250] | 1-284415-5 |
| 16 | 60.96 [2.400] | 1-284415-6 |
| 17 | 64.77 [2.550] | 1-284415-7 |
| 18 | 68.58 [2.700] | 1-284415-8 |
| 19 | 72.39 [2.850] | 1-284415-9 |
| 20 | 76.20 [3.000] | 2-284415-0 |
| 21 | 80.01 [3.150] | 2-284415-1 |
| 22 | 83.82 [3.300] | 2-284415-2 |
| 23 | 87.63 [3.450] | 2-284415-3 |
| 24 | 91.44 [3.600] | 2-284415-4 |
| 25 | 95.25 [3.750] | 2-284415-5 |

Note: All part numbers are RoHS Compliant.

Board Mount, Top Wire Entry (Continued)

**Board Mount, Low Profile
5.0 mm Centerline,
Top Wire Entry**
**UL Rating – 300 V, 13.5 A
16-30 AWG
10 A for field wiring applications**

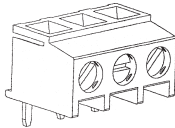

Suggested Screw Torque—
6.0 in.-lbs.

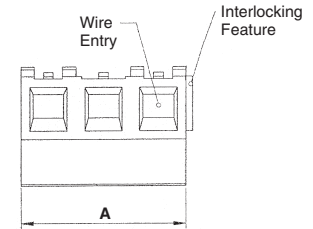
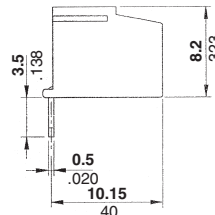
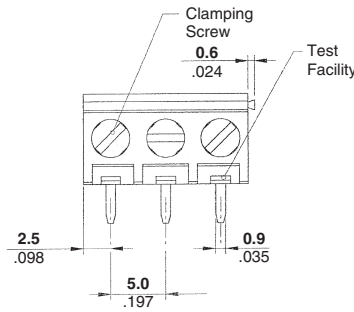

Recommended PC Board Layout

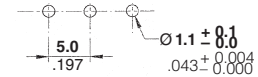

| No. of Positions | Dim. A | Part Numbers | | |
|------------------|--------------|--------------|-------------|-----------|
| | | Green | Gray | Black* |
| 2 | 10.0 [0.394] | 284093-2 | 1546225-2 | 1776120-2 |
| 3 | 15.0 [0.591] | 284093-3 | 1546225-3 | 1776120-3 |
| 4 | 20.0 [0.787] | 284093-4 | 1546225-4 | 1776120-4 |
| 5 | 25.0 [0.984] | 284093-5 | 1546225-5 | 1776120-5 |
| 6 | 30.0 [1.181] | 284093-6 | 1546225-6 | 1776120-6 |
| 7 | 35.0 [1.378] | 284093-7 | 1546225-7 | 1776120-7 |
| 8 | 40.0 [1.575] | 284093-8 | 1546225-8 | 1776120-8 |
| 9 | 45.0 [1.772] | 284093-9 | 1546225-9 | — |
| 10 | 50.0 [1.968] | 1-284093-0 | 1-1546225-0 | — |
| 11 | 55.0 [2.165] | 1-284093-1 | 1-1546225-1 | — |
| 12 | 60.0 [2.362] | 1-284093-2 | 1-1546225-2 | — |
| 13 | 65.0 [2.559] | 1-284093-3 | 1-1546225-3 | — |

| No. of Positions | Dim. A | Part Numbers | | |
|------------------|---------------|--------------|-------------|--------|
| | | Green | Gray | Black* |
| 14 | 70.0 [2.756] | 1-284093-4 | 1-1546225-4 | — |
| 15 | 75.0 [2.953] | 1-284093-5 | 1-1546225-5 | — |
| 16 | 80.0 [3.150] | 1-284093-6 | 1-1546225-6 | — |
| 17 | 85.0 [3.346] | 1-284093-7 | 1-1546225-7 | — |
| 18 | 90.0 [3.543] | 1-284093-8 | 1-1546225-8 | — |
| 19 | 95.0 [3.740] | 1-284093-9 | 1-1546225-9 | — |
| 20 | 100.0 [3.937] | 2-284093-0 | 2-1546225-0 | — |
| 21 | 105.0 [4.134] | 2-284093-1 | 2-1546225-1 | — |
| 22 | 110.0 [4.331] | 2-284093-2 | 2-1546225-2 | — |
| 23 | 115.0 [4.528] | 2-284093-3 | 2-1546225-3 | — |
| 24 | 120.0 [4.724] | 2-284093-4 | 2-1546225-4 | — |
| 25 | 125.0 [4.921] | 2-284093-5 | 2-1546225-5 | — |

*Wave solder process capable to 265°C [509°F] for 10 seconds

**Board Mount w/Interlock,
5.0 mm Centerline,
Top Wire Entry**
**UL Rating – 300 V, 17.5 A
12-30 AWG
15 A for field wiring applications**

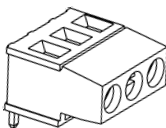

Suggested Screw Torque—
7.0 in.-lbs.

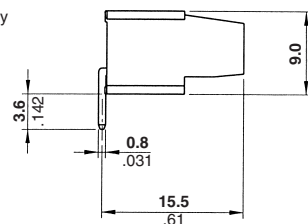
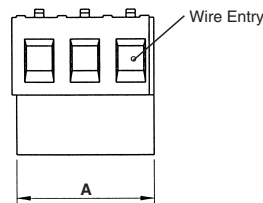

Recommended PC Board Layout

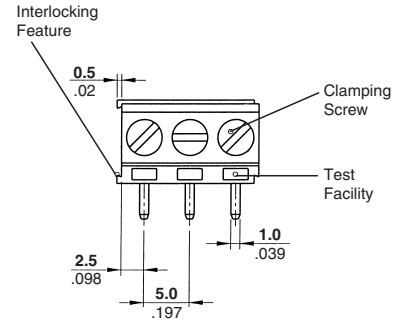
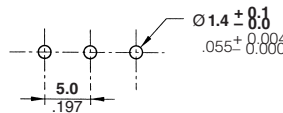

| No. of Positions | Dim. A | Part Numbers | |
|------------------|--------------|--------------|------------|
| | | Green | Blue |
| 2 | 10.0 [0.394] | 796748-2 | 796684-2 |
| 3 | 15.0 [0.591] | 796748-3 | 796684-3 |
| 4 | 20.0 [0.787] | 796748-4 | 796684-4 |
| 5 | 25.0 [0.984] | 796748-5 | 796684-5 |
| 6 | 30.0 [1.181] | 796748-6 | 796684-6 |
| 7 | 35.0 [1.378] | 796748-7 | 796684-7 |
| 8 | 40.0 [1.575] | 796748-8 | 796684-8 |
| 9 | 45.0 [1.772] | 796748-9 | 796684-9 |
| 10 | 50.0 [1.968] | 1-796748-0 | 1-796684-0 |
| 11 | 55.0 [2.165] | 1-796748-1 | 1-796684-1 |
| 12 | 60.0 [2.362] | 1-796748-2 | 1-796684-2 |
| 13 | 65.0 [2.559] | 1-796748-3 | 1-796684-3 |

| No. of Positions | Dim. A | Part Numbers | |
|------------------|---------------|--------------|------------|
| | | Green | Blue |
| 14 | 70.0 [2.756] | 1-796748-4 | 1-796684-4 |
| 15 | 75.0 [2.953] | 1-796748-5 | 1-796684-5 |
| 16 | 80.0 [3.150] | 1-796748-6 | 1-796684-6 |
| 17 | 85.0 [3.346] | 1-796748-7 | 1-796684-7 |
| 18 | 90.0 [3.543] | 1-796748-8 | 1-796684-8 |
| 19 | 95.0 [3.740] | 1-796748-9 | 1-796684-9 |
| 20 | 100.0 [3.937] | 2-796748-0 | 2-796684-0 |
| 21 | 105.0 [4.134] | 2-796748-1 | 2-796684-1 |
| 22 | 110.0 [4.331] | 2-796748-2 | 2-796684-2 |
| 23 | 115.0 [4.528] | 2-796748-3 | 2-796684-3 |
| 24 | 120.0 [4.724] | 2-796748-4 | 2-796684-4 |
| 25 | 125.0 [4.921] | 2-796748-5 | 2-796684-5 |

Note: BUCHANAN Terminal Block Series B02C4HxxT has been superseded/replaced with 796684-xx (blue).

Note: All part numbers are RoHS Compliant.

Board Mount, Top Wire Entry (Continued)

Board Mount w/Interlock, 5.0 mm Centerline, Top Wire Entry
Color – Green
UL Rating – 300 V, 24 A
12-30 AWG
20 A for field wiring applications

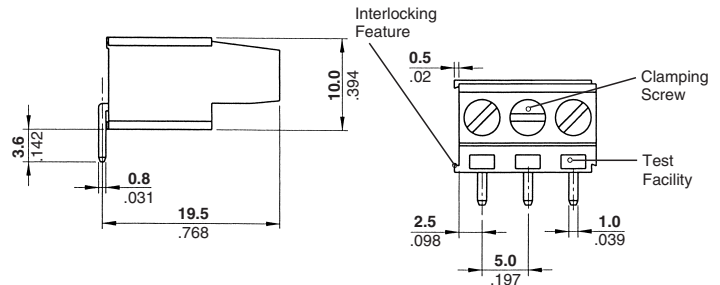
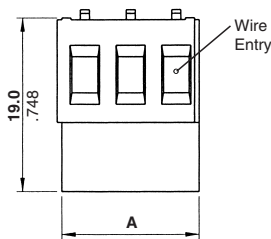
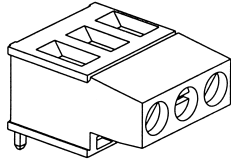

Recommended PC Board Layout

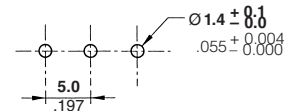

Suggested Screw Torque—
 7.0 in.-lbs.

| No. of Positions | Dim. A | Part Numbers |
|------------------|--------------|--------------|
| 2 | 10.0 [.394] | 282862-2 |
| 3 | 15.0 [.591] | 282862-3 |
| 4 | 20.0 [.787] | 282862-4 |
| 5 | 25.0 [.984] | 282862-5 |
| 6 | 30.0 [1.181] | 282862-6 |
| 7 | 35.0 [1.378] | 282862-7 |
| 8 | 40.0 [1.575] | 282862-8 |
| 9 | 45.0 [1.772] | 282862-9 |
| 10 | 50.0 [1.968] | 1-282862-0 |
| 11 | 55.0 [2.165] | 1-282862-1 |
| 12 | 60.0 [2.362] | 1-282862-2 |
| 13 | 65.0 [2.559] | 1-282862-3 |

| No. of Positions | Dim. A | Part Numbers |
|------------------|---------------|--------------|
| 14 | 70.0 [2.756] | 1-282862-4 |
| 15 | 75.0 [2.953] | 1-282862-5 |
| 16 | 80.0 [3.150] | 1-282862-6 |
| 17 | 85.0 [3.346] | 1-282862-7 |
| 18 | 90.0 [3.543] | 1-282862-8 |
| 19 | 95.0 [3.740] | 1-282862-9 |
| 20 | 100.0 [3.937] | 2-282862-0 |
| 21 | 105.0 [4.134] | 2-282862-1 |
| 22 | 110.0 [4.331] | 2-282862-2 |
| 23 | 115.0 [4.528] | 2-282862-3 |
| 24 | 120.0 [4.724] | 2-282862-4 |
| 25 | 125.0 [4.921] | 2-282862-5 |

Board Mount w/Interlock, Low Profile, 5.08 mm Centerline, Top Wire Entry
UL Rating – 300 V, 13.5 A
16-30 AWG
10 A for field wiring applications

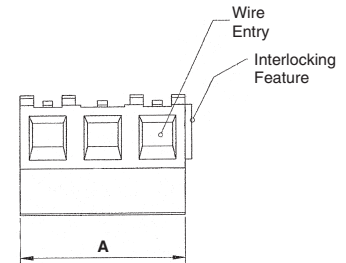
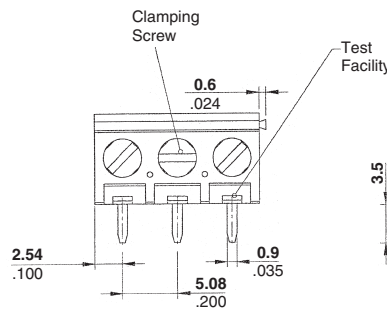
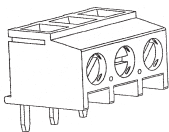

Recommended PC Board Layout

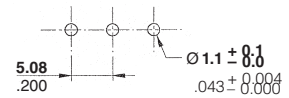

Suggested Screw Torque—
 6.0 in.-lbs.

| No. of Positions | Dim. A | Part Numbers | |
|------------------|---------------|--------------|-----------|
| | | Green | Black* |
| 2 | 10.16 [0.400] | 284094-2 | 1776121-2 |
| 3 | 15.24 [0.600] | 284094-3 | 1776121-3 |
| 4 | 20.32 [0.800] | 284094-4 | 1776121-4 |
| 5 | 25.40 [1.000] | 284094-5 | 1776121-5 |
| 6 | 30.48 [1.200] | 284094-6 | 1776121-6 |
| 7 | 35.56 [1.400] | 284094-7 | 1776121-7 |
| 8 | 40.64 [1.600] | 284094-8 | 1776121-8 |
| 9 | 45.72 [1.800] | 284094-9 | — |
| 10 | 50.80 [2.000] | 1-284094-0 | — |
| 11 | 55.88 [2.200] | 1-284094-1 | — |
| 12 | 60.96 [2.400] | 1-284094-2 | — |
| 13 | 66.04 [2.600] | 1-284094-3 | — |

| No. of Positions | Dim. A | Part Numbers | |
|------------------|----------------|--------------|--------|
| | | Green | Black* |
| 14 | 71.12 [2.800] | 1-284094-4 | — |
| 15 | 76.20 [3.000] | 1-284094-5 | — |
| 16 | 81.28 [3.200] | 1-284094-6 | — |
| 17 | 86.36 [3.400] | 1-284094-7 | — |
| 18 | 91.44 [3.600] | 1-284094-8 | — |
| 19 | 96.52 [3.800] | 1-284094-9 | — |
| 20 | 101.60 [4.000] | 2-284094-0 | — |
| 21 | 106.68 [4.200] | 2-284094-1 | — |
| 22 | 111.76 [4.400] | 2-284094-2 | — |
| 23 | 116.84 [4.600] | 2-284094-3 | — |
| 24 | 121.92 [4.800] | 2-284094-4 | — |
| 25 | 127.00 [5.000] | 2-284094-5 | — |

*Wave solder process capable to 265°C [509°F] for 10 seconds



Note: All part numbers are RoHS Compliant.

Board Mount, Top Wire Entry (Continued)

Board Mount w/Interlock, 5.08 mm Centerline, Top Wire Entry
UL Rating – 300 V, 17.5 A
12-30 AWG
15 A for field wiring applications

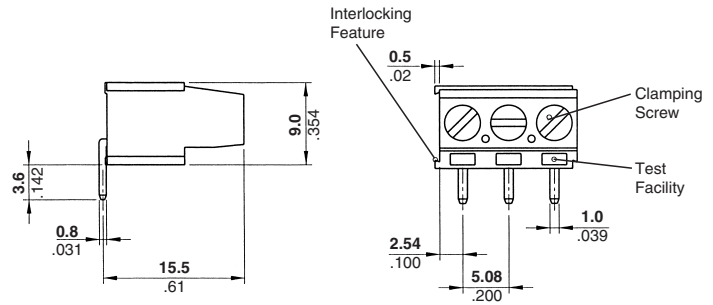
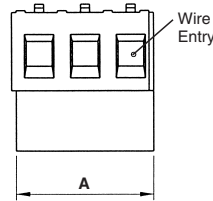
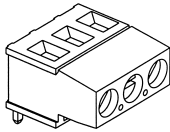

Recommended PC Board Layout

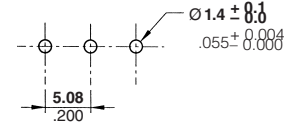

Suggested Screw Torque—
 7.0 in.-lbs.

| No. of Positions | Dim. A | Part Numbers | |
|------------------|---------------|--------------|-------------|
| | | Green | Black |
| 2 | 10.16 [0.400] | 282851-2 | 1546073-2 |
| 3 | 15.24 [0.600] | 282851-3 | 1546073-3 |
| 4 | 20.32 [0.800] | 282851-4 | 1546073-4 |
| 5 | 25.40 [1.000] | 282851-5 | 1546073-5 |
| 6 | 30.48 [1.200] | 282851-6 | 1546073-6 |
| 7 | 35.56 [1.400] | 282851-7 | 1546073-7 |
| 8 | 40.64 [1.600] | 282851-8 | 1546073-8 |
| 9 | 45.72 [1.800] | 282851-9 | 1546073-9 |
| 10 | 50.80 [2.000] | 1-282851-0 | 1-1546073-0 |
| 11 | 55.88 [2.200] | 1-282851-1 | 1-1546073-1 |
| 12 | 60.96 [2.400] | 1-282851-2 | 1-1546073-2 |
| 13 | 66.04 [2.600] | 1-282851-3 | 1-1546073-3 |

| No. of Positions | Dim. A | Part Numbers | |
|------------------|----------------|--------------|-------------|
| | | Green | Black |
| 14 | 71.12 [2.800] | 1-282851-4 | 1-1546073-4 |
| 15 | 76.20 [3.000] | 1-282851-5 | 1-1546073-5 |
| 16 | 81.28 [3.200] | 1-282851-6 | 1-1546073-6 |
| 17 | 86.36 [3.400] | 1-282851-7 | 1-1546073-7 |
| 18 | 91.44 [3.600] | 1-282851-8 | 1-1546073-8 |
| 19 | 96.52 [3.800] | 1-282851-9 | 1-1546073-9 |
| 20 | 101.60 [4.000] | 2-282851-0 | 2-1546073-0 |
| 21 | 106.68 [4.200] | 2-282851-1 | 2-1546073-1 |
| 22 | 111.76 [4.400] | 2-282851-2 | 2-1546073-2 |
| 23 | 116.84 [4.600] | 2-282851-3 | 2-1546073-3 |
| 24 | 121.92 [4.800] | 2-282851-4 | 2-1546073-4 |
| 25 | 127.00 [5.000] | 2-282851-5 | 2-1546073-5 |

Board Mount w/Interlock, 5.08 mm Centerline, Top Wire Entry Color – Green
UL Rating – 300 V, 24 A
12-30 AWG
20 A for field wiring applications

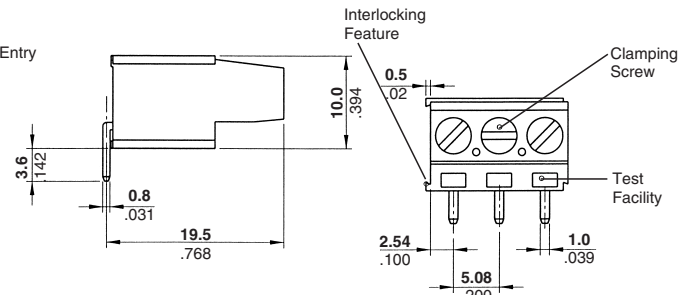
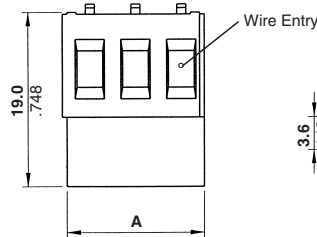
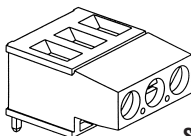

Recommended PC Board Layout

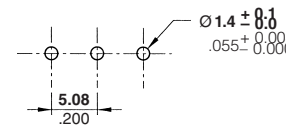

Suggested Screw Torque—
 7.0 in.-lbs.

| No. of Positions | Dim. A | Part Numbers |
|------------------|---------------|--------------|
| | | |
| 2 | 10.16 [0.400] | 282863-2 |
| 3 | 15.24 [0.600] | 282863-3 |
| 4 | 20.32 [0.800] | 282863-4 |
| 5 | 25.40 [1.000] | 282863-5 |
| 6 | 30.48 [1.200] | 282863-6 |
| 7 | 35.56 [1.400] | 282863-7 |
| 8 | 40.64 [1.600] | 282863-8 |
| 9 | 45.72 [1.800] | 282863-9 |
| 10 | 50.80 [2.000] | 1-282863-0 |
| 11 | 55.88 [2.200] | 1-282863-1 |
| 12 | 60.96 [2.400] | 1-282863-2 |
| 13 | 66.04 [2.600] | 1-282863-3 |

| No. of Positions | Dim. A | Part Numbers |
|------------------|----------------|--------------|
| | | |
| 14 | 71.12 [2.800] | 1-282863-4 |
| 15 | 76.20 [3.000] | 1-282863-5 |
| 16 | 81.28 [3.200] | 1-282863-6 |
| 17 | 86.36 [3.400] | 1-282863-7 |
| 18 | 91.44 [3.600] | 1-282863-8 |
| 19 | 96.52 [3.800] | 1-282863-9 |
| 20 | 101.60 [4.000] | 2-282863-0 |
| 21 | 106.68 [4.200] | 2-282863-1 |
| 22 | 111.76 [4.400] | 2-282863-2 |
| 23 | 116.84 [4.600] | 2-282863-3 |
| 24 | 121.92 [4.800] | 2-282863-4 |
| 25 | 127.00 [5.000] | 2-282863-5 |

Note: All part numbers are RoHS Compliant.

Board Mount, Top Wire Entry (Continued)

Top Wire Entry
7.5 mm Centerline,
Color – Green
UL Rating – 300 V, 17.5 A
12-30 AWG
15 A for field wiring applications

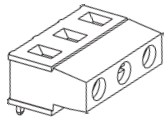

Suggested Screw Torque—
7.0 in.-lbs.

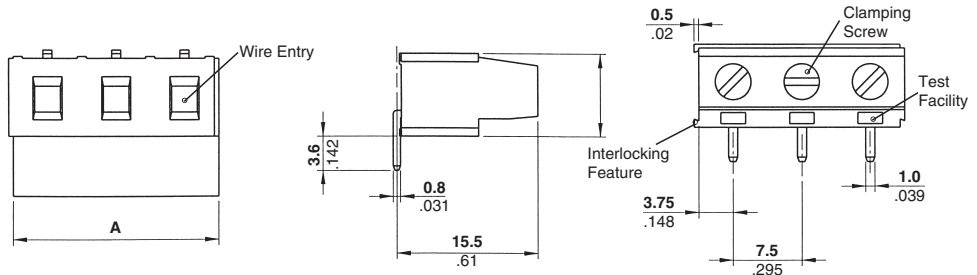

| No. of Positions | Dim. A | Part Numbers |
|------------------|--------------|--------------|
| 2 | 15.0 [0.591] | 282854-2 |
| 3 | 22.5 [0.886] | 282854-3 |
| 4 | 30.0 [1.181] | 282854-4 |

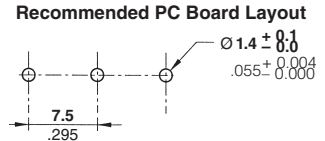

Top Wire Entry
7.62 mm Centerline,
Color – Green
UL Rating – 300 V, 17.5 A
12-30 AWG
15 A for field wiring applications

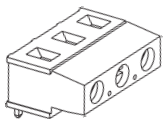

Suggested Screw Torque—
7.0 in.-lbs.

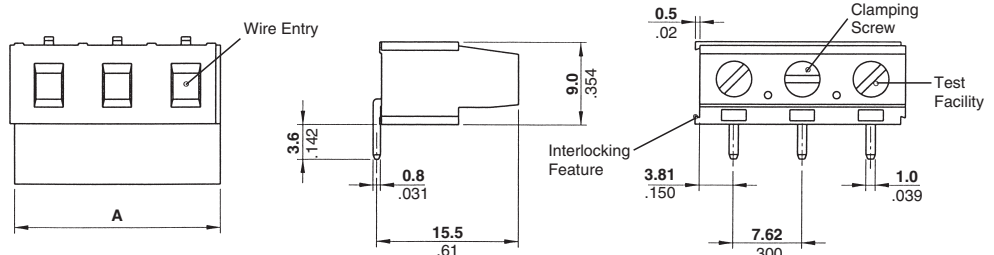

| No. of Positions | Dim. A | Part Numbers |
|------------------|--------------|--------------|
| 2 | 15.24 [.600] | 282855-2 |
| 3 | 22.86 [.900] | 282855-3 |

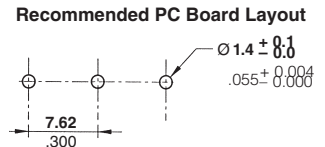

Top Wire Entry
7.62 mm Centerline,
Color – Green
UL Rating – 300 V, 24 A
12-30 AWG
20 A for field wiring applications

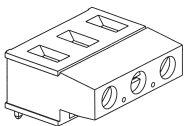

Suggested Screw Torque—
7.0 in.-lbs.

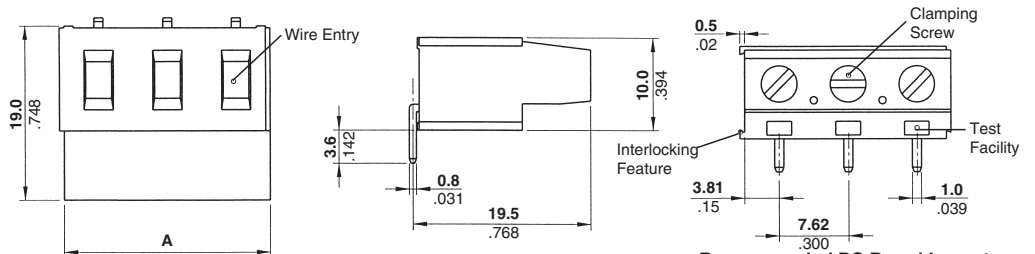

| No. of Positions | Dim. A | Part Numbers |
|------------------|--------------|--------------|
| 2 | 15.24 [.600] | 282867-2 |
| 3 | 22.86 [.900] | 282867-3 |

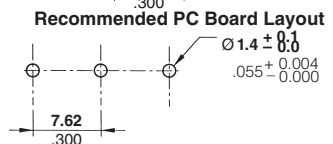

Note: All part numbers are RoHS Compliant.

Board Mount, Top Wire Entry (Continued)

Board Mount, Low Profile
10.0 mm Centerline,
Top Wire Entry,
Color – Black
UL Rating – 600 V, 13.5 A
16-30 AWG
10 A for field wiring applications

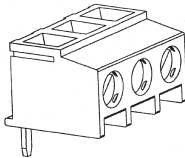

Suggested Screw Torque—
 6.0 in.-lbs.

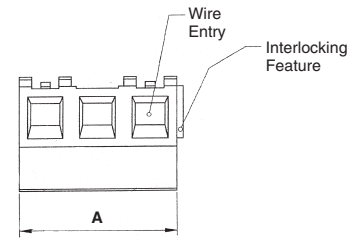
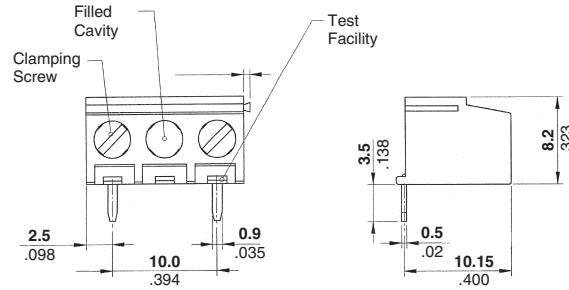

Recommended PC Board Layout

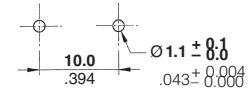

| No. of Positions | Dim. A | Part Numbers |
|------------------|-------------|--------------|
| 2 | 15.0 [.591] | 1776124-2 |
| 3 | 20.0 [.787] | 1776124-3 |
| 4 | 25.0 [.984] | 1776124-4 |

Wave solder process capable to 265°C [509°F] for 10 seconds

Board Mount
10.0 mm Centerline,
Top Wire Entry
Color – Green
UL Rating – 600 V, 17.5 A
12-30 AWG
15 A for field entry applications

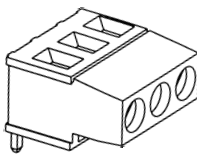

Suggested Screw Torque—
 7.0 in.-lbs.

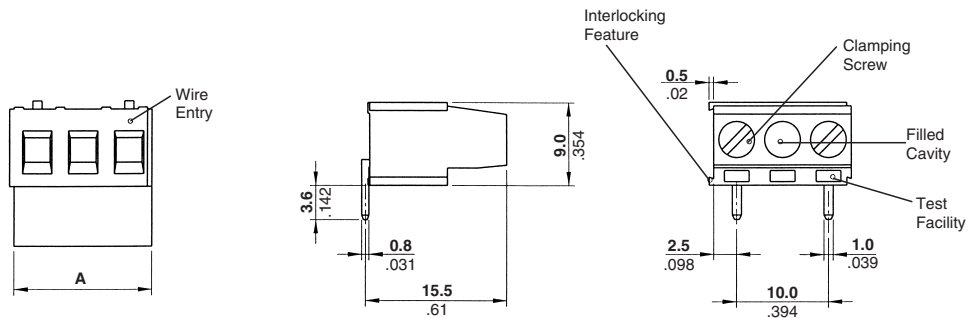

Recommended PC Board Layout

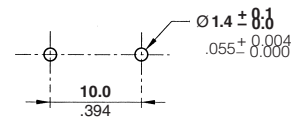

| No. of Positions | Dim. A | Part Numbers |
|------------------|--------------|--------------|
| 2 | 15.0 [.591] | 282852-2 |
| 3 | 20.0 [.787] | 282852-3 |
| 4 | 25.0 [.984] | 282852-4 |
| 5 | 30.0 [1.181] | 282852-5 |
| 6 | 35.0 [1.378] | 282852-6 |
| 7 | 40.0 [1.575] | 282852-7 |
| 8 | 45.0 [1.772] | 282852-8 |
| 9 | 50.0 [1.968] | 282852-9 |
| 10 | 55.0 [2.165] | 1-282852-0 |
| 11 | 60.0 [2.362] | 1-282852-1 |
| 12 | 65.0 [2.559] | 1-282852-2 |
| 13 | 70.0 [2.775] | 1-282852-3 |

Note: All part numbers are RoHS Compliant.

Board Mount, Top Wire Entry (Continued)

Board Mount, Low Profile, 10.16 mm Centerline, Top Wire Entry
Color – Black

UL Rating – 600 V, 13.5 A
16-30 AWG
10 A for field wiring applications

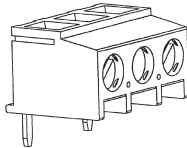

Suggested Screw Torque—
6.0 in.-lbs.

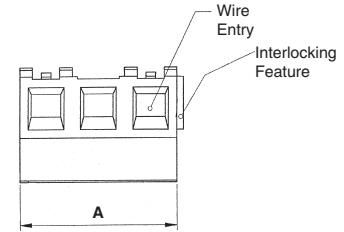
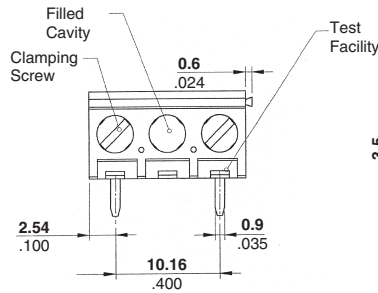

| No. of Positions | Dim. A | Part Numbers |
|------------------|---------------|--------------|
| 2 | 15.24 [0.600] | 1776125-2 |
| 3 | 20.32 [0.800] | 1776125-3 |
| 4 | 25.40 [1.000] | 1776125-4 |

Recommended PC Board Layout

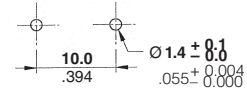

Wave solder process capable to 265°C [509°F] for 10 seconds

Board Mount, 10.16 mm Centerline, Top Wire Entry
Color – Green

UL Rating – 600 V, 17.5 A
12-30 AWG
15 A for field wiring applications

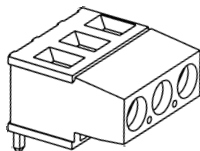

Suggested Screw Torque—
7.0 in.-lbs.

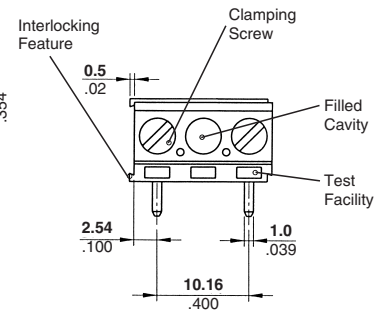
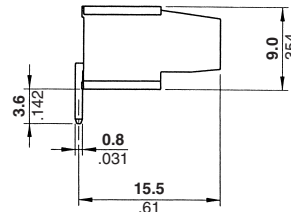
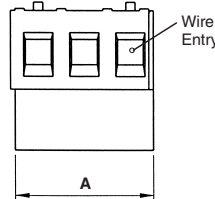

| No. of Positions | Dim. A | Part Numbers |
|------------------|---------------|--------------|
| 2 | 15.24 [0.600] | 282853-2 |
| 3 | 20.32 [0.800] | 282853-3 |
| 4 | 25.40 [1.000] | 282853-4 |
| 5 | 30.48 [1.200] | 282853-5 |
| 6 | 35.56 [1.400] | 282853-6 |
| 7 | 40.64 [1.600] | 282853-7 |
| 8 | 45.72 [1.800] | 282853-8 |
| 9 | 50.80 [2.000] | 282853-9 |
| 10 | 55.88 [2.200] | 1-282853-0 |
| 11 | 60.96 [2.400] | 1-282853-1 |
| 12 | 66.04 [2.600] | 1-282853-2 |
| 13 | 71.12 [2.800] | 1-282853-3 |

Recommended PC Board Layout

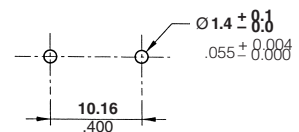

Note: All part numbers are RoHS Compliant.

Board Mount, 35° Angled Wire Entry

**Board Mount w/Interlock,
5.0 mm Centerline,
35° Angled Wire Entry**
**UL Rating – 300 V, 17.5 A
12-30 AWG
15 A for field wiring applications**

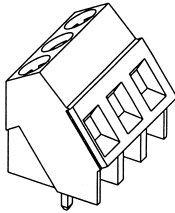

Suggested Screw Torque—
7.0 in.-lbs.

Notes:

1. BUCHANAN Terminal Block Series B04C4VXXT has been superceded/replaced with part number 796688-xx (blue color) and 796689-xx (black color).
2. RDI Terminal Block Series 5LEA-XX has been superceded/replaced with part number 796690-xx (green color).
3. RDI Terminal Block Series 5LEA-XX-1 has been superceded/replaced with part number 796689-xx (black color).

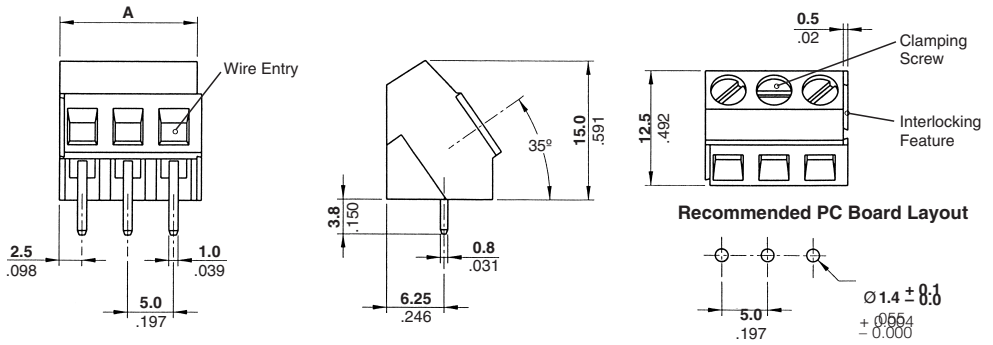

| No. of Positions | Dim. A | Part Numbers | | | |
|------------------|--------------|--------------|------------|------------|------------|
| | | Gray | Blue | Black | Green |
| 2 | 10.0 [0.394] | 1546219-2 | 796688-2 | 796689-2 | 796690-2 |
| 3 | 15.0 [0.591] | 1546219-3 | 796688-3 | 796689-3 | 796690-3 |
| 4 | 20.0 [0.787] | 1546219-4 | 796688-4 | 796689-4 | 796690-4 |
| 5 | 25.0 [0.984] | 1546219-5 | 796688-5 | 796689-5 | 796690-5 |
| 6 | 30.0 [1.181] | 1546219-6 | 796688-6 | 796689-6 | 796690-6 |
| 7 | 35.0 [1.378] | 1546219-7 | 796688-7 | 796689-7 | 796690-7 |
| 8 | 40.0 [1.575] | 1546219-8 | 796688-8 | 796689-8 | 796690-8 |
| 9 | 45.0 [1.772] | 1546219-9 | 796688-9 | 796689-9 | 796690-9 |
| 10 | 50.0 [1.968] | 1-1546219-0 | 1-796688-0 | 1-796689-0 | 1-796690-0 |
| 11 | 55.0 [2.165] | 1-1546219-1 | 1-796688-1 | 1-796689-1 | 1-796690-1 |
| 12 | 60.0 [2.362] | 1-1546219-2 | 1-796688-2 | 1-796689-2 | 1-796690-2 |

**Board Mount w/Interlock,
5.08 mm Centerline,
35° Angled Wire Entry**
**UL Rating – 300 V, 17.5 A
12-30 AWG
15 A for field wiring applications**

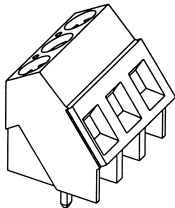

Suggested Screw Torque—
7.0 in.-lbs.

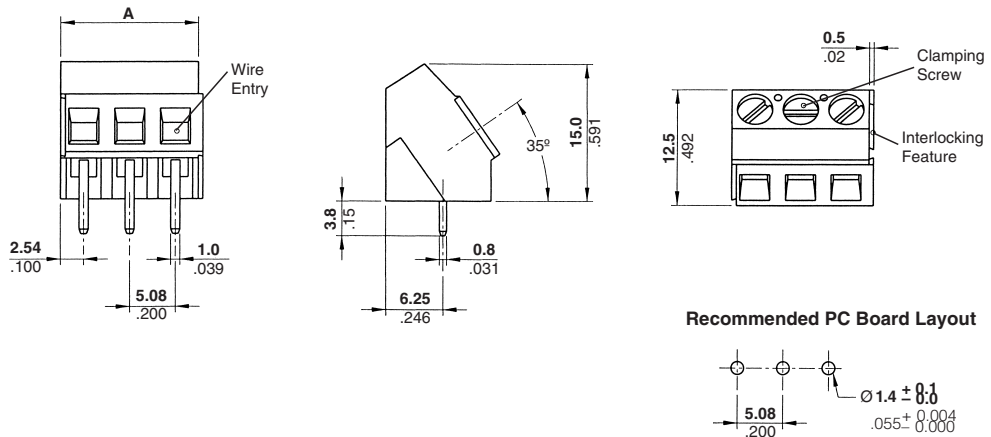

| No. of Positions | Dim. A | Part Numbers | | |
|------------------|---------------|--------------|------------|-------------|
| | | Gray | Green | Black |
| 2 | 10.16 [0.400] | 1546220-2 | 282847-2 | 1546074-2 |
| 3 | 15.24 [0.600] | 1546220-3 | 282847-3 | 1546074-3 |
| 4 | 20.32 [0.800] | 1546220-4 | 282847-4 | 1546074-4 |
| 5 | 25.40 [1.000] | 1546220-5 | 282847-5 | 1546074-5 |
| 6 | 30.48 [1.200] | 1546220-6 | 282847-6 | 1546074-6 |
| 7 | 35.56 [1.400] | 1546220-7 | 282847-7 | 1546074-7 |
| 8 | 40.64 [1.600] | 1546220-8 | 282847-8 | 1546074-8 |
| 9 | 45.72 [1.800] | 1546220-9 | 282847-9 | 1546074-9 |
| 10 | 50.80 [2.000] | 1-1546220-0 | 1-282847-0 | 1-1546074-0 |
| 11 | 55.88 [2.200] | 1-1546220-1 | 1-282847-1 | 1-1546074-1 |
| 12 | 60.96 [2.400] | 1-1546220-2 | 1-282847-2 | 1-1546074-2 |

Note: RDI Terminal Block Series 2EEA-xx has been superceded/replaced with 282847-xx series.

Note: All part numbers are RoHS Compliant.

Board Mount, 35° Angled Wire Entry (Continued)

**Board Mount,
10.0 mm Centerline,
35° Angled Wire Entry
Color – Green**
**UL Rating – 600 V, 17.5 A
12-30 AWG
15 A for field wiring applications**

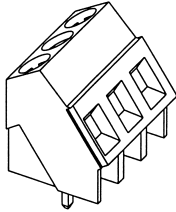

**Suggested Screw Torque—
7.0 in.-lbs.**

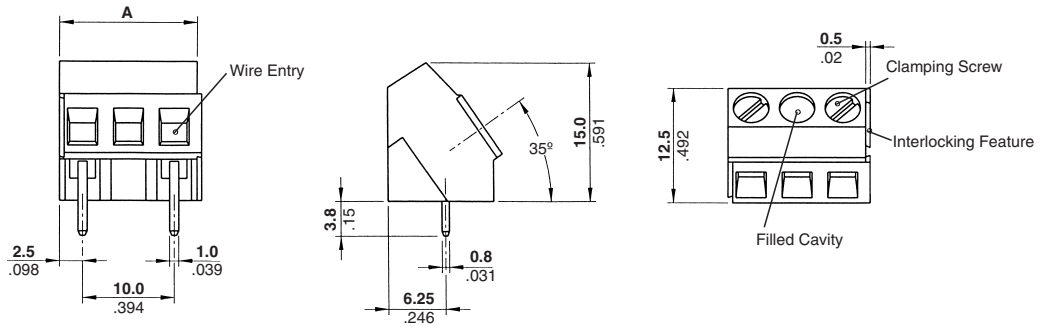

| No. of Positions | Dim. A | Part Numbers |
|------------------|--------------|--------------|
| 2 | 15.0 [0.591] | 282848-2 |
| 3 | 25.0 [0.984] | 282848-3 |
| 4 | 35.0 [1.378] | 282848-4 |
| 5 | 45.0 [1.772] | 282848-5 |
| 6 | 55.0 [2.165] | 282848-6 |

Recommended PC Board Layout

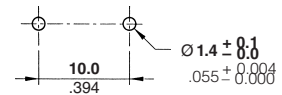

**Board Mount,
10.16 mm Centerline,
35° Angled Wire Entry
Color – Green**
**UL Rating – 600 V, 17.5 A
12-30 AWG
15 A for field wiring applications**

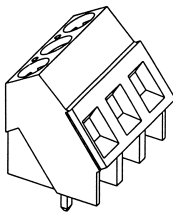

**Suggested Screw Torque—
7.0 in.-lbs.**

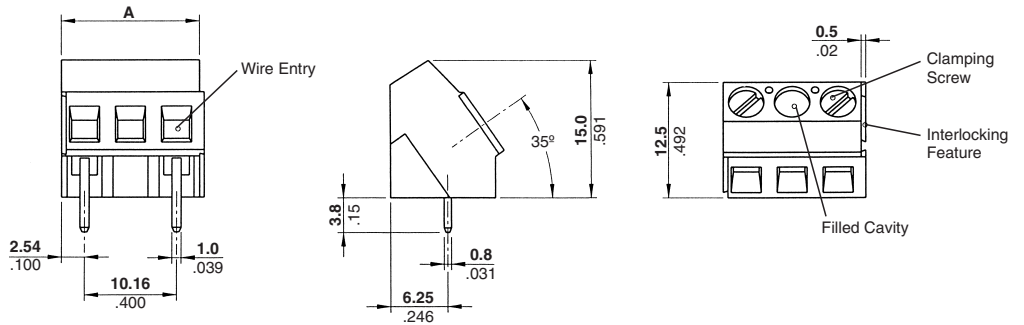

| No. of Positions | Dim. A | Part Numbers |
|------------------|---------------|--------------|
| 2 | 15.24 [0.600] | 282849-2 |
| 3 | 25.40 [1.000] | 282849-3 |
| 4 | 35.56 [1.400] | 282849-4 |
| 5 | 45.72 [1.800] | 282849-5 |
| 6 | 55.88 [2.200] | 282849-6 |

Recommended PC Board Layout

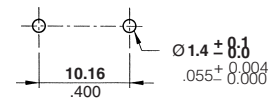

Note: All part numbers are RoHS Compliant.

Board Mount, Bottom Wire Entry

**Board Mount w/Interlock,
5.0 mm Centerline,
270° Bottom Wire Entry
Color – Green**

**UL Rating – 300 V, 17.5 A
12-30 AWG
15 A for field wiring applications**

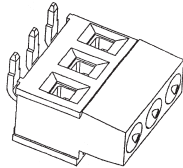

Suggested Screw Torque—
7.0 in.-lbs.

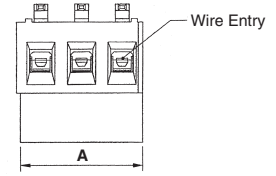
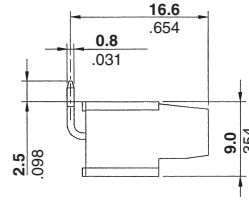
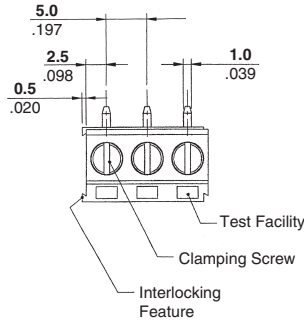

Recommended PC Board Layout

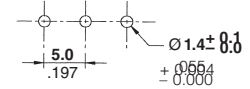

| No. of Positions | Dim. A | Part Numbers |
|------------------|---------------|--------------|
| 2 | 10.0 [0.394] | 284410-2 |
| 3 | 15.0 [0.591] | 284410-3 |
| 4 | 20.0 [0.787] | 284410-4 |
| 5 | 25.0 [0.984] | 284410-5 |
| 6 | 30.0 [1.181] | 284410-6 |
| 7 | 35.0 [1.378] | 284410-7 |
| 8 | 40.0 [1.575] | 284410-8 |
| 9 | 45.0 [1.772] | 284410-9 |
| 10 | 50.0 [1.968] | 1-284410-0 |
| 11 | 55.0 [2.165] | 1-284410-1 |
| 12 | 60.0 [2.362] | 1-284410-2 |
| 13 | 65.0 [2.559] | 1-284410-3 |
| 14 | 70.0 [2.756] | 1-284410-4 |
| 15 | 75.0 [2.953] | 1-284410-5 |
| 16 | 80.0 [3.150] | 1-284410-6 |
| 17 | 85.0 [3.346] | 1-284410-7 |
| 18 | 90.0 [3.543] | 1-284410-8 |
| 19 | 95.0 [3.740] | 1-284410-9 |
| 20 | 100.0 [3.937] | 2-284410-0 |
| 21 | 105.0 [4.134] | 2-284410-1 |
| 22 | 110.0 [4.331] | 2-284410-2 |
| 23 | 115.0 [4.528] | 2-284410-3 |
| 24 | 120.0 [4.724] | 2-284410-4 |
| 25 | 125.0 [4.921] | 2-284410-5 |

Note: All part numbers are RoHS Compliant.

High Current PCB Mount, Side Wire Entry

Product Facts

- Available in (2) centerline spacings: 6.35 mm and 9.52 mm pitch
- (2) position sizes available: 2 and 3 position
- Wire range: 10-24 AWG
- Available in (3) wire entry configurations: side wire, top wire and 35° angle

- Cage clamp style termination
- Product is modular; designed with a dovetail feature to allow building larger position sizes to increase the number of available wire positions
- Green color; other colors available upon request



**Board Mount w/Interlock,
6.35 mm Centerline,
Side Wire Entry,
Color – Green**

**UL Rating—300 V, 30 A
10-24 AWG**

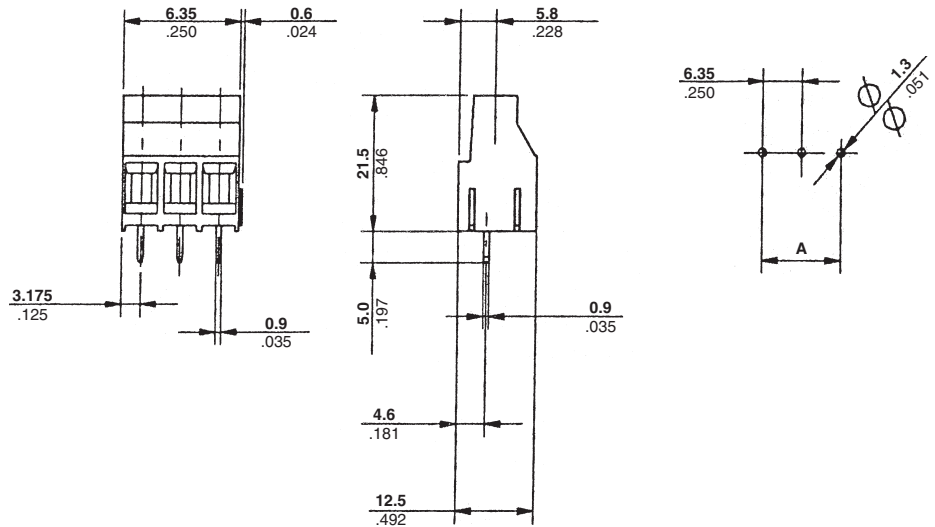

**Suggested Screw Torque—
7.0 in.-lbs.**

| No. of Positions | Dim. A | Part Numbers |
|------------------|-------------|--------------|
| 2 | 6.35 0.250 | 796740-2 |
| 3 | 12.70 0.500 | 796740-3 |

**Board Mount w/Interlock,
9.52 mm Centerline,
Side Wire Entry,
Color – Green**

**UL Rating—600 V, 30 A
10-24 AWG**

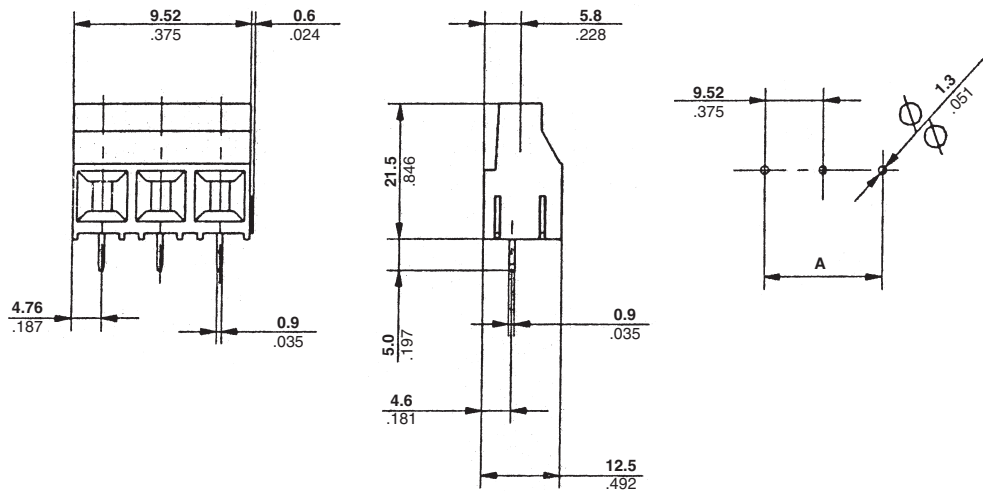

**Suggested Screw Torque—
7.0 in.-lbs.**

| No. of Positions | Dim. A | Part Numbers |
|------------------|-------------|--------------|
| 2 | 9.52 0.375 | 796739-2 |
| 3 | 19.04 0.704 | 796739-3 |

Note: All part numbers are RoHS Compliant.

High Current PCB Mount, 35° Angled Wire Entry

**Board Mount w/Interlock,
9.52 mm Centerline,
35° Wire Entry
Color – Green**

**UL Rating – 600 V, 30 A
10-24 AWG**

**Suggested Screw Torque—
7.0 in.-lbs.**

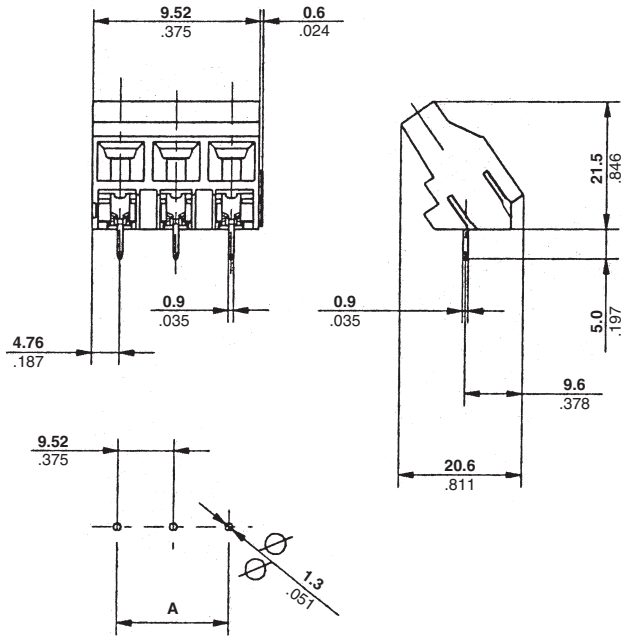

| No. of Positions | Dim. A | Part Numbers |
|------------------|-------------|--------------|
| 2 | 9.52 0.375 | 796741-2 |
| 3 | 19.04 0.704 | 796741-3 |

**Board Mount w/Interlock,
10.16 mm Centerline,
Side Wire Entry
Color – Green or Black**

**UL Rating – 300 V, 52 A
6-8 AWG**

**Suggested Screw Torque—
10.16 in.-lbs.**

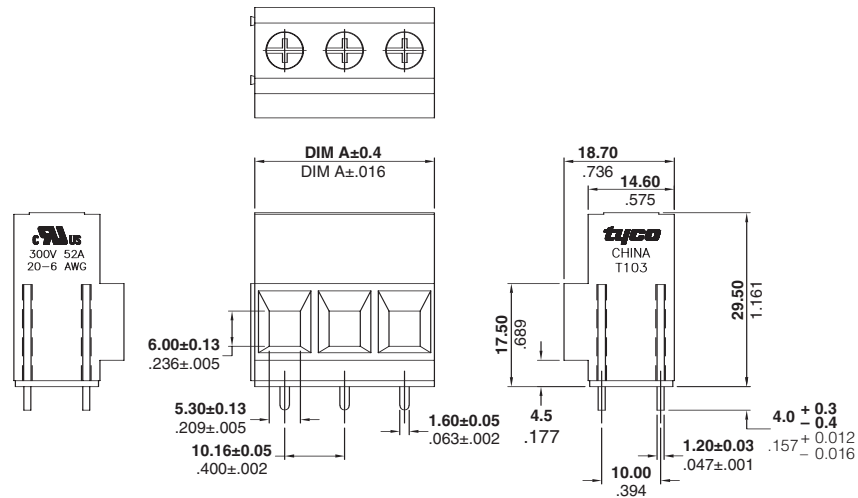

| No. of Positions | Dim. A | Part Numbers | |
|------------------|---------------|--------------|-------------|
| | | Green | Black |
| 2 | 20.32 [.800] | 1776886-2 | 1-1776886-2 |
| 3 | 30.48 [1.200] | 1776886-3 | 1-1776886-3 |

Note: All part numbers are RoHS Compliant.

Board Mount Multi-Level Stacking

Board Mount w/Interlock, Multi-Level Stacking 16-30 AWG

Product Facts

- One-piece board mount terminal blocks
- Interchangeable with existing products of other terminal block suppliers
- PC board footprint fully compatible with existing Industry Standards: pc board thickness 1.6–2.4 mm
- Modular design with interlocking fixture to assemble higher number of ways applies to 5.0 and 5.08 mm centerlines
- Rising screw clamp design
- Funnel entry housing for easier wire insertion
- Test probe access
- Terminal blocks supplied with open captive screws

Tyco Electronics is expanding the range of board mount terminal blocks with its family of multi-level Terminal Block stacking connectors; three different heights are available to combine one-piece blocks, according to the user's need for better space utilization and easier wire accessibility.

5.0, 5.08, 10.0 and 10.16 mm centerline blocks suitable for 1.5 mm² max. solid wire and 1.0 mm² max. stranded wire are described in the following pages.

Mechanical/Environmental Performance

Operating Temperature—

-40°C up to +105°C

Climate Category—

40/110/21 per IEC 68-1

| Level | Height | Level Combinations |
|-----------|---------|--|
| 1st Level | 10.0 mm | 1st and 2nd level; 2nd and 3rd level; three levels, 2nd level; 3rd level |
| 2nd Level | 19.0 mm | |
| 3rd Level | 28.0 mm | |

Board Mount w/Interlock, Multi-Level Stacking 12-30 AWG

5.0, 5.08, 10.0 and 10.16 mm centerline blocks suitable for 4.0 mm² max. solid wire and 2.5 mm² max. stranded wire are described in the following pages.

Mechanical/Environmental Performance

Operating Temperature—

-40°C up to +105°C

Climate Category—

40/110/21 per IEC 68-1

| Level | Height |
|-----------|---------|
| 1st Level | 18.6 mm |
| 2nd Level | 31.5 mm |
| 3rd Level | 45.0 mm |

| Centerline | No. of Pos. | Level Combinations |
|------------|-------------|--|
| 5.00 mm | 2–3 | 1st and 2nd level; 2nd and 3rd level; three levels, 2nd level; 3rd level |
| 5.08 mm | 2–3 | 1st and 2nd level; 2nd and 3rd level; three levels, 2nd level; 3rd level |
| 10.00 mm | 2 | 1st and 2nd level; 2nd and 3rd level; three levels, 2nd level; 3rd level |
| 10.16 mm | 2 | 1st and 2nd level; 2nd and 3rd level; three levels, 2nd level; 3rd level |

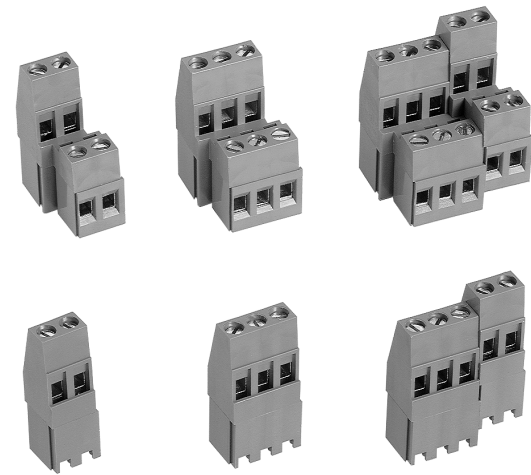

Note: All part numbers are RoHS Compliant.

Board Mount, 1st and 2nd Level Stacking Connectors

Board Mount w/Interlock, 5.0 mm Centerline, 1st and 2nd Level, Stacking Color – Green

**UL Rating – 300 V, 13.5 A
16-30 AWG
10 A for field wiring applications**

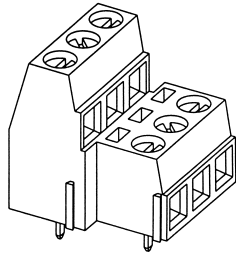

Suggested Screw Torque—
6.0 in.-lb.

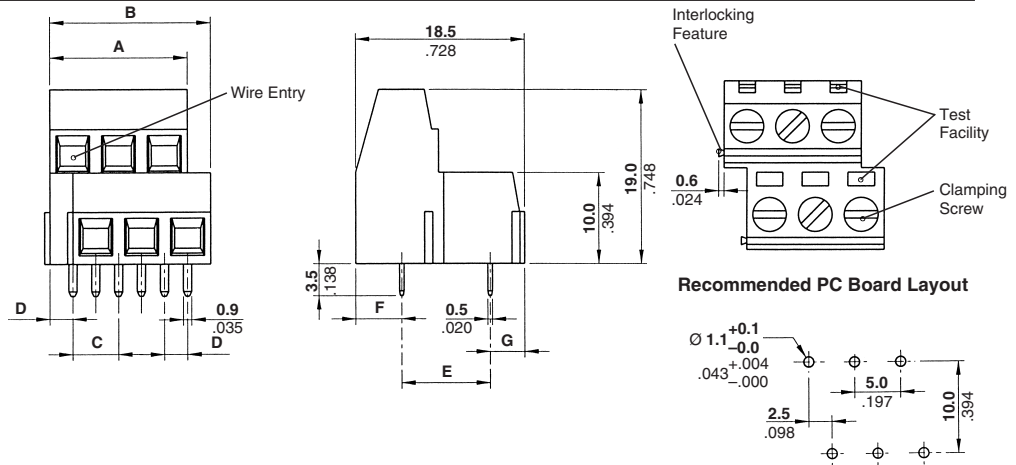

| No. of Positions | Dimensions | | | | | | | Part Numbers |
|------------------|--------------|--------------|-------------|-------------|--------------|-------------|-------------|--------------|
| | A | B | C | D | E | F | G | |
| 2 | 10.0 .394 | 12.5 .492 | 5.0 .197 | 2.5 .098 | 10.0 .394 | 4.4 .173 | 4.1 .161 | 282868-2 |
| 3 | 15.0 .591 | 17.5 .689 | 5.0 .197 | 2.5 .098 | 10.0 .394 | 4.4 .173 | 4.1 .161 | 282868-3 |

Board Mount w/Interlock, 5.0 mm Centerline, 1st and 2nd Level, Stacking

**UL Rating – 300 V, 17.5 A
12-30 AWG
15 A for field wiring applications**

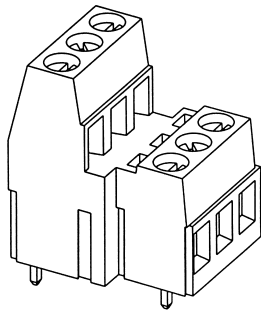

Suggested Screw Torque—
7.0 in.-lb.

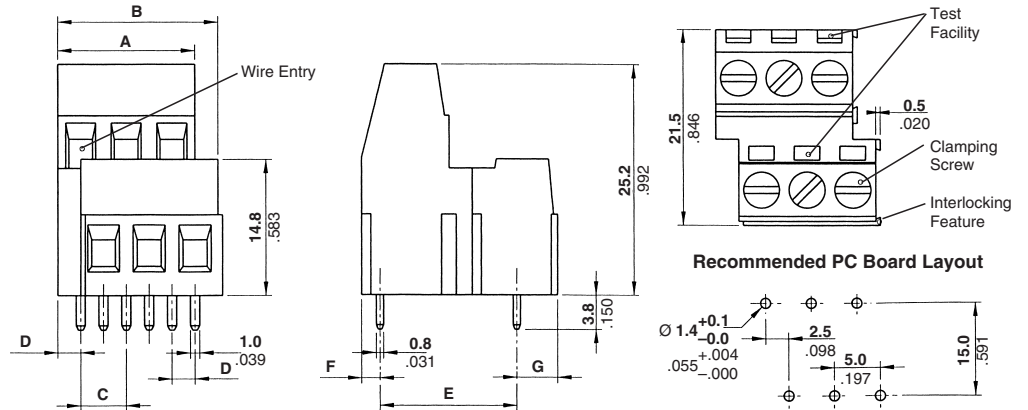

| No. of Positions | Dimensions | | | | | | | Part Numbers | |
|------------------|---------------|---------------|-------------|-------------|--------------|-------------|-------------|--------------|------------|
| | A | B | C | D | E | F | G | Green | Blue |
| 2 | 10.0 .394 | 12.5 .492 | 5.0 .197 | 2.5 .098 | 15.0 .591 | 2.0 .079 | 4.5 .177 | 282888-2 | 796691-2 |
| 3 | 15.0 .591 | 17.5 .689 | 5.0 .197 | 2.5 .098 | 15.0 .591 | 2.0 .079 | 4.5 .177 | 282888-3 | 796691-3 |
| 4 | 20.0 .787 | 22.5 .886 | 5.0 .197 | 2.5 .098 | 15.0 .591 | 2.0 .079 | 4.5 .177 | — | 796691-4 |
| 5 | 25.0 .984 | 27.5 1.083 | 5.0 .197 | 2.5 .098 | 15.0 .591 | 2.0 .079 | 4.5 .177 | — | 796691-5 |
| 6 | 30.0 1.181 | 32.5 1.28 | 5.0 .197 | 2.5 .098 | 15.0 .591 | 2.0 .079 | 4.5 .177 | — | 796691-6 |
| 7 | 35.0 1.378 | 37.5 1.476 | 5.0 .197 | 2.5 .098 | 15.0 .591 | 2.0 .079 | 4.5 .177 | — | 796691-7 |
| 8 | 40.0 1.575 | 42.5 1.673 | 5.0 .197 | 2.5 .098 | 15.0 .591 | 2.0 .079 | 4.5 .177 | — | 796691-8 |
| 9 | 45.0 1.772 | 47.5 1.87 | 5.0 .197 | 2.5 .098 | 15.0 .591 | 2.0 .079 | 4.5 .177 | — | 796691-9 |
| 10 | 50.0 1.968 | 52.5 2.067 | 5.0 .197 | 2.5 .098 | 15.0 .591 | 2.0 .079 | 4.5 .177 | — | 1-796691-0 |
| 11 | 55.0 2.165 | 57.5 2.264 | 5.0 .197 | 2.5 .098 | 15.0 .591 | 2.0 .079 | 4.5 .177 | — | 1-796691-1 |
| 12 | 60.0 2.362 | 62.5 2.461 | 5.0 .197 | 2.5 .098 | 15.0 .591 | 2.0 .079 | 4.5 .177 | — | 1-796691-2 |

Note: BUCHANAN Terminal Block Series B07C4VxxT has been superceded/replaced with 796691-xx (blue).
RDI Terminal Block Series 5LEEV-xx has been superceded/replaced with 796691-xx.

Note: All part numbers are RoHS Compliant.

Board Mount, 1st and 2nd Level Stacking Connectors (Continued)

Board Mount w/Interlock, 5.08 mm Centerline, 1st and 2nd Level, Stacking Color – Green

**UL Rating – 300 V, 13.5 A
16-30 AWG
10 A for field wiring applications**

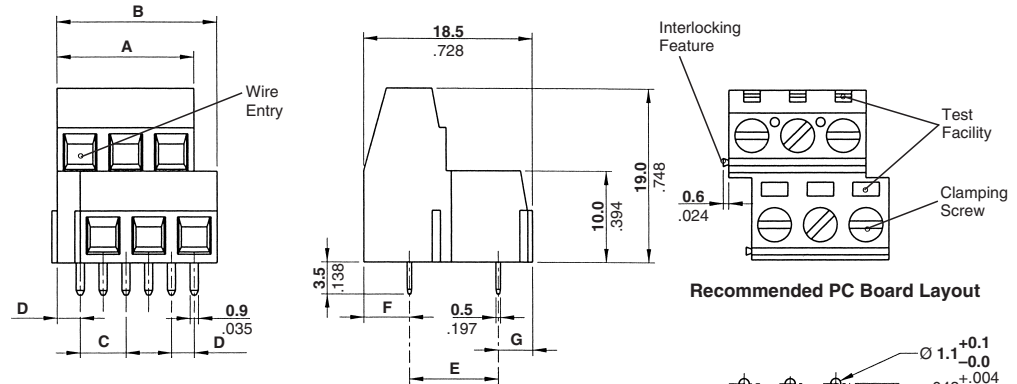
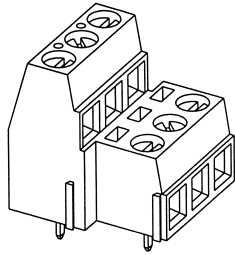

Suggested Screw Torque—
6.0 in.-lb.

| No. of Positions | Dimensions | | | | | | | Part Numbers |
|------------------|---------------|---------------|--------------|--------------|---------------|--------------|-------------|--------------|
| | A | B | C | D | E | F | G | |
| 2 | 10.16 .400 | 12.70 .500 | 5.08 .200 | 2.54 .100 | 10.16 .400 | 4.24 .167 | 4.1 .161 | 282869-2 |
| 3 | 15.24 .600 | 17.78 .700 | 5.08 .200 | 2.54 .100 | 10.16 .400 | 4.24 .167 | 4.1 .161 | 282869-3 |

Board Mount w/Interlock, 5.08 mm Centerline, 1st and 2nd Level, Stacking

**UL Rating – 300 V, 17.5 A
12-30 AWG
15 A for field wiring applications**

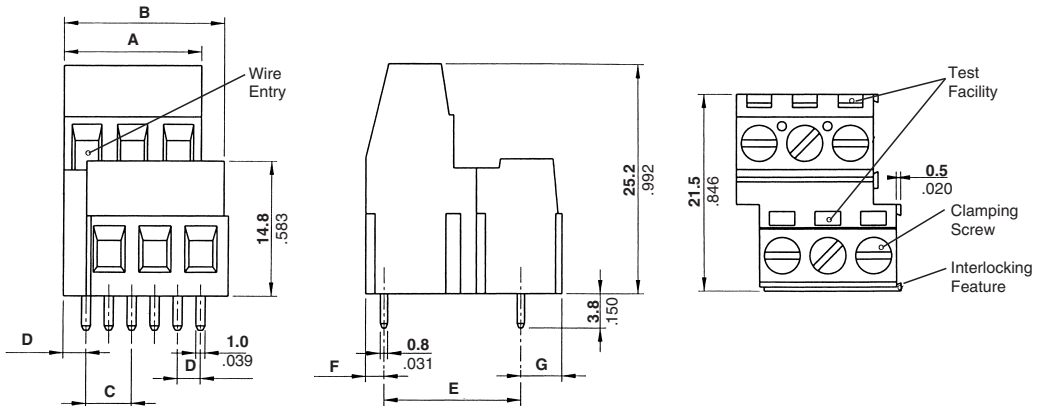
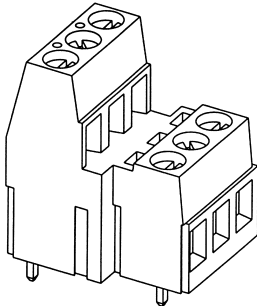

Suggested Screw Torque—
7.0 in.-lb.

| No. of Positions | Dimensions | | | | | | | Part Numbers | | |
|------------------|---------------|---------------|--------------|--------------|---------------|--------------|-------------|--------------|------------|------------|
| | A | B | C | D | E | F | G | Gray | Green | Black |
| 2 | 10.16 .400 | 12.70 .500 | 5.08 .200 | 2.54 .100 | 15.24 .600 | 1.76 .069 | 4.5 .177 | 1546222-2 | 796692-2 | 796984-2 |
| 3 | 15.24 .600 | 17.78 .700 | 5.08 .200 | 2.54 .100 | 15.24 .600 | 1.76 .069 | 4.5 .177 | 1546222-3 | 796692-3 | 796984-3 |
| 4 | 20.32 0.80 | 22.86 0.90 | 5.08 .200 | 2.54 .100 | 15.24 .600 | 1.76 .069 | 4.5 .177 | — | 796692-4 | 796984-4 |
| 5 | 25.40 1.00 | 27.94 1.10 | 5.08 .200 | 2.54 .100 | 15.24 .600 | 1.76 .069 | 4.5 .177 | — | 796692-5 | 796984-5 |
| 6 | 30.48 1.20 | 33.02 1.30 | 5.08 .200 | 2.54 .100 | 15.24 .600 | 1.76 .069 | 4.5 .177 | — | 796692-6 | 796984-6 |
| 7 | 35.56 1.40 | 38.10 1.50 | 5.08 .200 | 2.54 .100 | 15.24 .600 | 1.76 .069 | 4.5 .177 | — | 796692-7 | 796984-7 |
| 8 | 40.64 1.60 | 43.18 1.70 | 5.08 .200 | 2.54 .100 | 15.24 .600 | 1.76 .069 | 4.5 .177 | — | 796692-8 | 796984-8 |
| 9 | 45.72 1.80 | 48.26 1.90 | 5.08 .200 | 2.54 .100 | 15.24 .600 | 1.76 .069 | 4.5 .177 | — | 796692-9 | 796984-9 |
| 10 | 50.80 2.00 | 53.34 2.10 | 5.08 .200 | 2.54 .100 | 15.24 .600 | 1.76 .069 | 4.5 .177 | — | 1-796692-0 | 1-796984-0 |
| 11 | 55.88 2.20 | 58.42 2.30 | 5.08 .200 | 2.54 .100 | 15.24 .600 | 1.76 .069 | 4.5 .177 | — | 1-796692-1 | 1-796984-1 |
| 12 | 60.96 2.40 | 63.50 2.50 | 5.08 .200 | 2.54 .100 | 15.24 .600 | 1.76 .069 | 4.5 .177 | — | 1-796692-2 | 1-796984-2 |

Note: RDI Terminal Block Series 2LEEV-xx/2 has been superseded/replaced with 796692-xx (green).

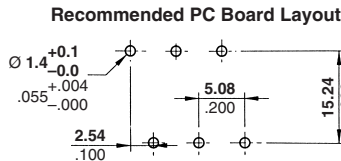

Note: All part numbers are RoHS Compliant.

Board Mount, 1st and 2nd Level Stacking Connectors (Continued)

Board Mount w/Interlock, 5.08 mm Centerline, 1st and 2nd Level, Stacking Color – Green

**UL Rating – 300 V, 24 A
12-30 AWG
20 A for field wiring applications**

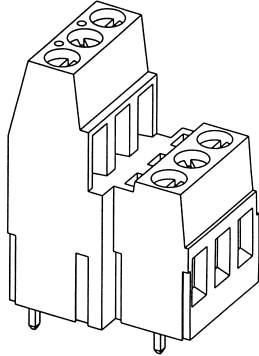

Suggested Screw Torque—
7.0 in.-lb.

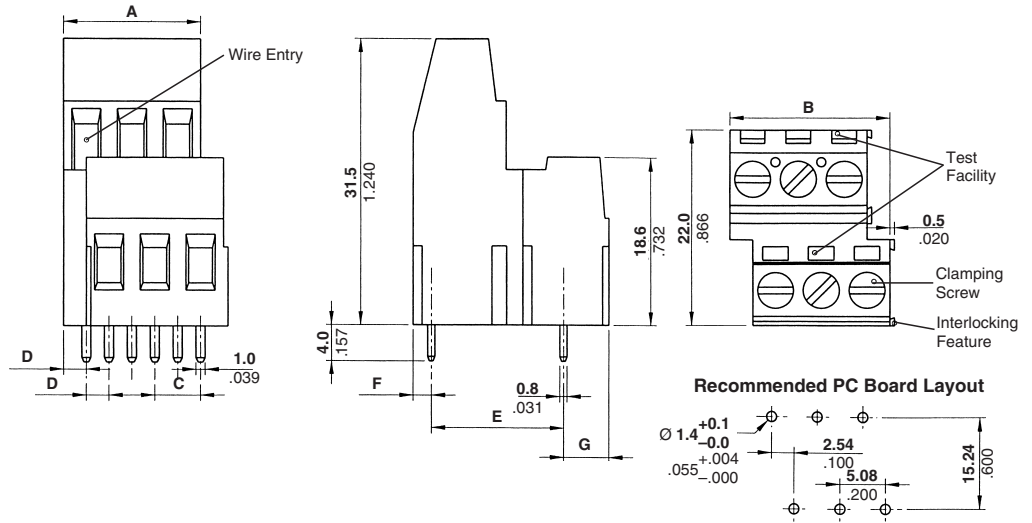

| No. of Positions | Dimensions | | | | | | | Part Numbers |
|------------------|---------------|---------------|--------------|--------------|---------------|--------------|-------------|--------------|
| | A | B | C | D | E | F | G | |
| 2 | 10.16 .400 | 12.70 .500 | 5.08 .200 | 2.54 .100 | 15.24 .600 | 1.76 .069 | 5.0 .197 | 282909-2 |
| 3 | 15.24 .600 | 17.78 .700 | 5.08 .200 | 2.54 .100 | 15.24 .600 | 1.76 .069 | 5.0 .197 | 282909-3 |

Board Mount, 2nd and 3rd Level Stacking Connectors

Board Mount w/Interlock, 5.08 mm Centerline, 2nd and 3rd Level, Stacking Color – Green

**UL Rating – 300 V, 13.5 A
16-30 AWG
10 A for field wiring applications**

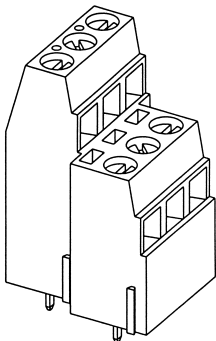

Suggested Screw Torque—
6.0 in.-lb.

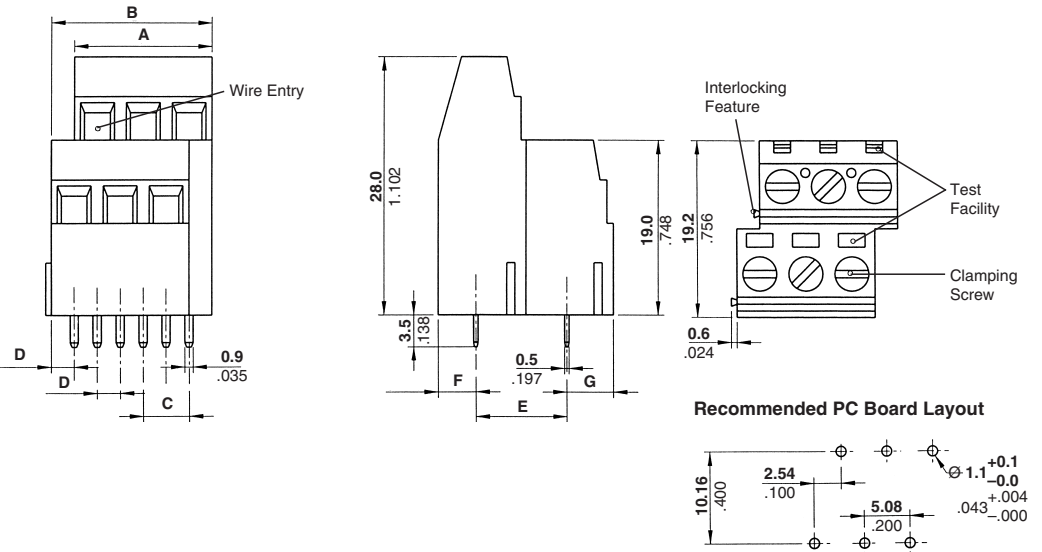

| No. of Positions | Dimensions | | | | | | | Part Numbers |
|------------------|---------------|---------------|--------------|--------------|---------------|--------------|--------------|--------------|
| | A | B | C | D | E | F | G | |
| 2 | 10.16 .400 | 12.70 .500 | 5.08 .200 | 2.54 .100 | 10.16 .400 | 3.78 .149 | 5.26 .207 | 282873-2 |
| 3 | 15.24 .600 | 17.78 .700 | 5.08 .200 | 2.54 .100 | 10.16 .400 | 3.78 .149 | 5.26 .207 | 282873-3 |

Note: All part numbers are RoHS Compliant.

Board Mount, 2nd and 3rd Level Stacking Connectors (Continued)

Board Mount w/Interlock, 5.08 mm Centerline, 2nd and 3rd Level, Stacking Color – Green

**UL Rating – 300 V, 24 A
12-30 AWG
20 A for field wiring applications**

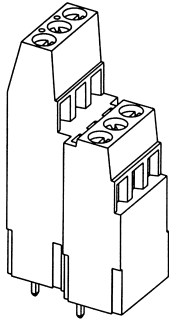

Suggested Screw Torque—
7.0 in.-lb.

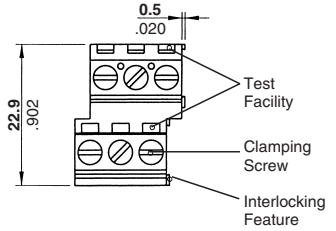
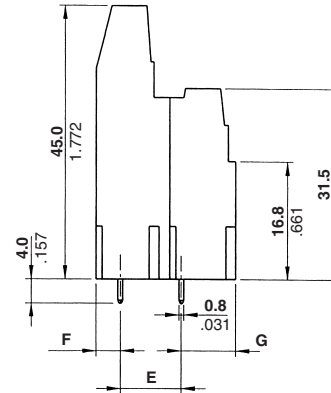
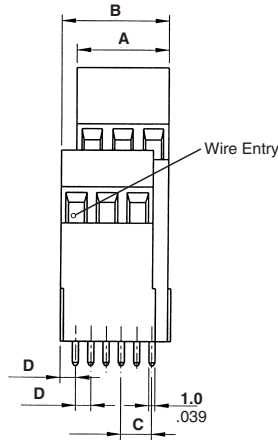

Recommended PC Board Layout

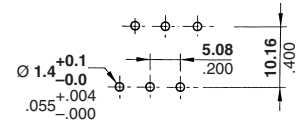

| No. of Positions | Dimensions | | | | | | | Part Numbers |
|------------------|---------------|---------------|--------------|--------------|---------------|-------------|--------------|--------------|
| | A | B | C | D | E | F | G | |
| 2 | 10.16 .400 | 12.70 .500 | 5.08 .200 | 2.54 .100 | 10.16 .400 | 3.6 .142 | 9.14 .360 | 282913-2 |
| 3 | 15.24 .600 | 17.78 .700 | 5.08 .200 | 2.54 .100 | 10.16 .400 | 3.6 .142 | 9.14 .360 | 282913-3 |

Board Mount, Three-Levels Stacking Connectors

Board Mount w/Interlock, 5.0 mm Centerline, Three Levels, Stacking Color – Green

**UL Rating – 300 V, 13.5 A
16-30 AWG
10 A for field wiring applications**

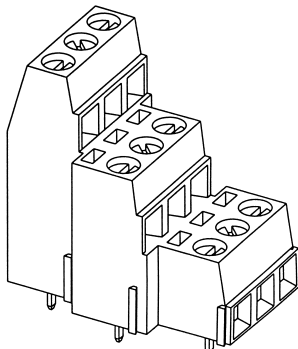

Suggested Screw Torque—
6.0 in.-lb.

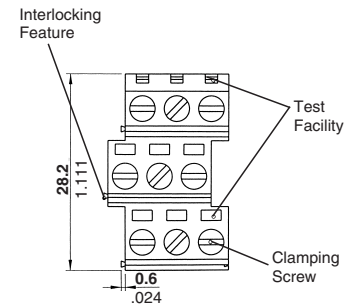
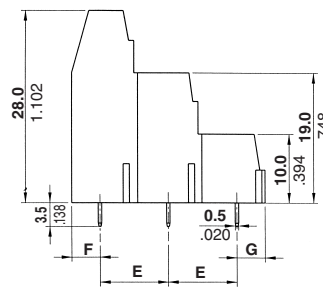
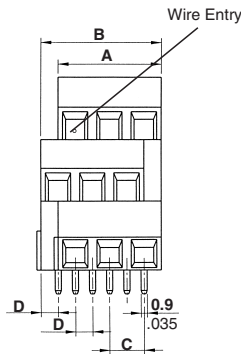

Recommended PC Board Layout

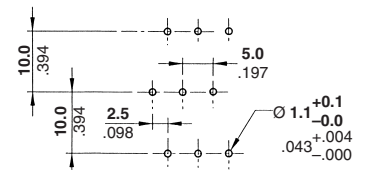

| No. of Positions | Dimensions | | | | | | | Part Numbers |
|------------------|--------------|--------------|-------------|-------------|--------------|-------------|-------------|--------------|
| | A | B | C | D | E | F | G | |
| 2 | 10.0 .394 | 12.5 .492 | 5.0 .197 | 2.5 .098 | 10.0 .394 | 4.1 .161 | 4.1 .161 | 282876-2 |
| 3 | 15.0 .591 | 17.5 .689 | 5.0 .197 | 2.5 .098 | 10.0 .394 | 4.1 .161 | 4.1 .161 | 282876-3 |

Note: All part numbers are RoHS Compliant.

Board Mount, Three-Levels Stacking Connectors

Board Mount w/Interlock
5.0 mm Centerline,
Three Levels, Stacking
Color – Green
UL Rating – 300 V, 24 A
12-30 AWG
20 A for field wiring applications

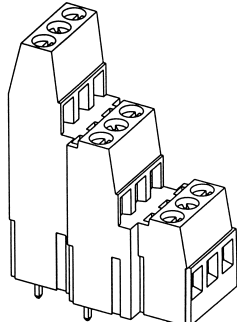

Suggested Screw Torque—
 7.0 in.-lb.

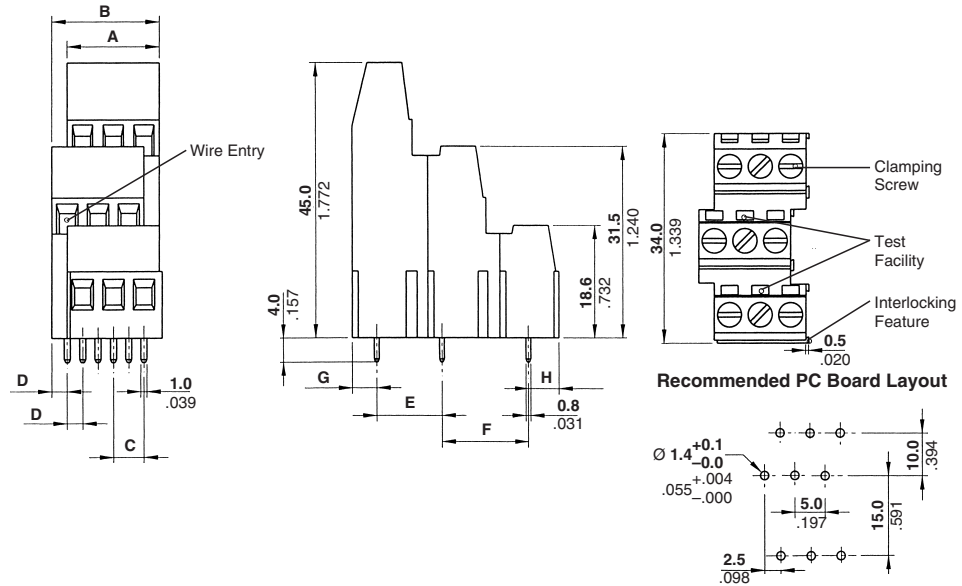

| No. of Positions | Dimensions | | | | | | | | Part Numbers |
|------------------|--------------|--------------|-------------|-------------|--------------|--------------|-------------|-------------|--------------|
| | A | B | C | D | E | F | G | H | |
| 2 | 10.0 .394 | 12.5 .492 | 5.0 .197 | 2.5 .098 | 10.0 .394 | 15.0 .591 | 4.0 .157 | 5.0 .197 | 282916-2 |
| 3 | 15.0 .591 | 17.5 .689 | 5.0 .197 | 2.5 .098 | 10.0 .394 | 15.0 .591 | 4.0 .157 | 5.0 .197 | 282916-3 |

Board Mount w/Interlock
5.08 mm Centerline,
Three Levels, Stacking
Color – Green
UL Rating – 300 V, 13.5 A
16-30 AWG
10 A for field wiring applications

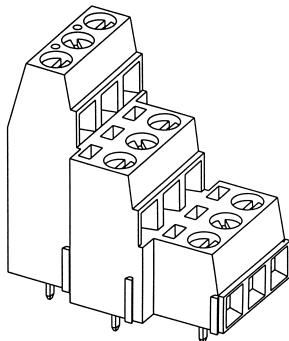

Suggested Screw Torque—
 6.0 in.-lb.

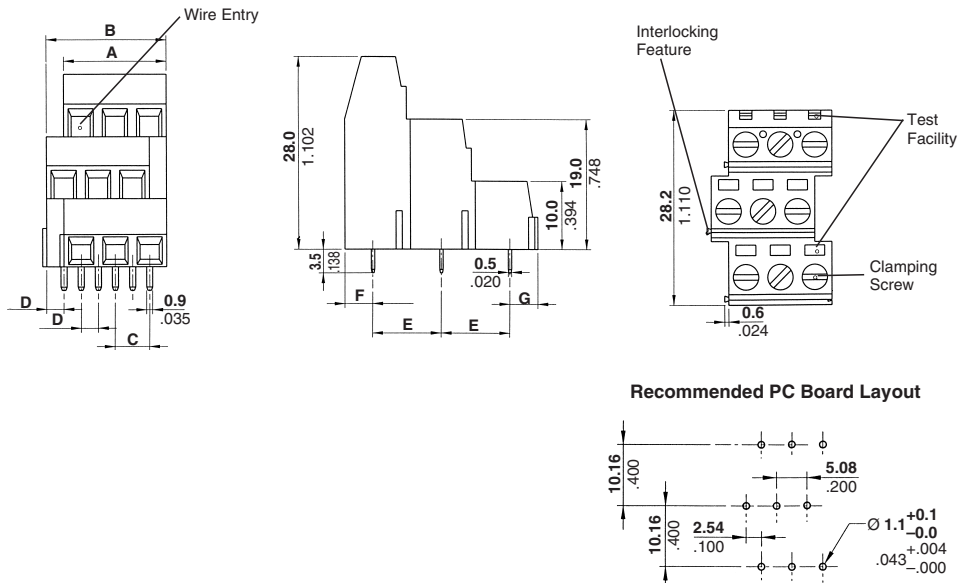

| No. of Positions | Dimensions | | | | | | | Part Number |
|------------------|---------------|---------------|--------------|--------------|---------------|--------------|-------------|-------------|
| | A | B | C | D | E | F | G | |
| 2 | 10.16 .400 | 12.70 .500 | 5.08 .200 | 2.54 .100 | 10.16 .400 | 3.78 .149 | 4.1 .161 | 282877-2 |
| 3 | 15.24 .600 | 17.78 .700 | 5.08 .200 | 2.54 .100 | 10.16 .400 | 3.78 .149 | 4.1 .161 | 282877-3 |

Note: All part numbers are RoHS Compliant.

Board Mount, Three-Levels Stacking Connectors (Continued)

Board Mount w/Interlock
5.08 mm Centerline,
Three Levels, Stacking
UL Rating – 300 V, 17.5 A
12-30 AWG
15 A for field wiring applications

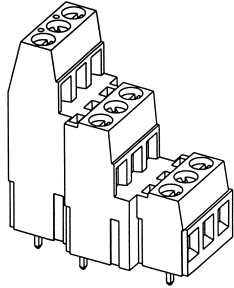

Suggested Screw Torque—
 7.0 in.-lb.

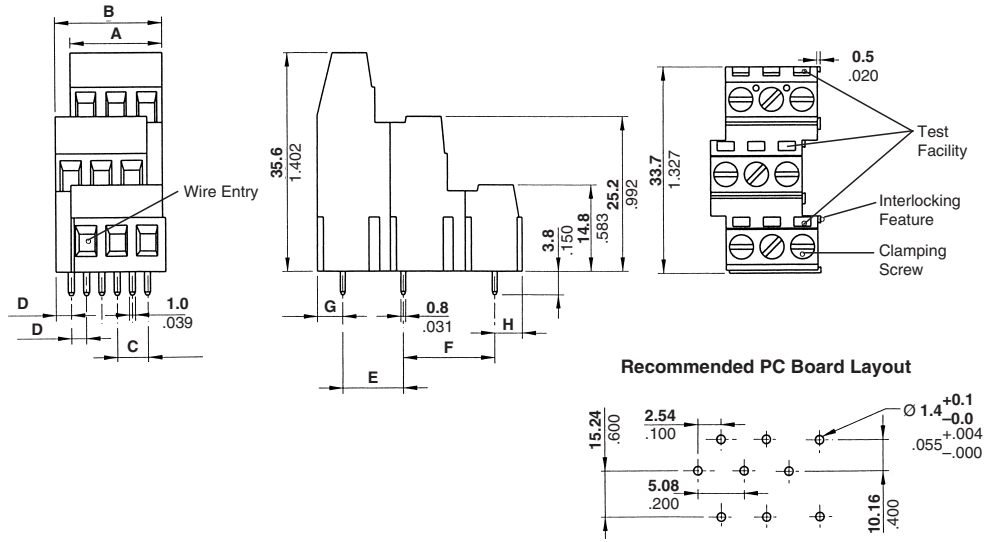

| No. of Positions | Dimensions | | | | | | | | Part Numbers | |
|------------------|------------|-------|------|------|-------|-------|------|------|--------------|-----------|
| | A | B | C | D | E | F | G | H | Green | Black |
| 2 | 10.16 | 12.70 | 5.08 | 2.54 | 10.16 | 15.24 | 3.8 | 4.5 | 282897-2 | 1546233-2 |
| | .400 | .500 | .200 | .100 | .400 | .600 | .150 | .177 | | |
| 3 | 15.24 | 17.78 | 5.08 | 2.54 | 10.16 | 15.24 | 3.8 | 4.5 | 282897-3 | 1546233-3 |
| | .600 | .700 | .200 | .100 | .400 | .600 | .150 | .177 | | |

Board Mount w/Interlock
5.08 mm Centerline,
Three Levels, Stacking
Color – Green
UL Rating – 300 V, 24 A
12-30 AWG
20 A for field wiring applications

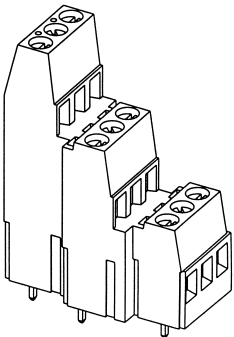

Suggested Screw Torque—
 7.0 in.-lb.

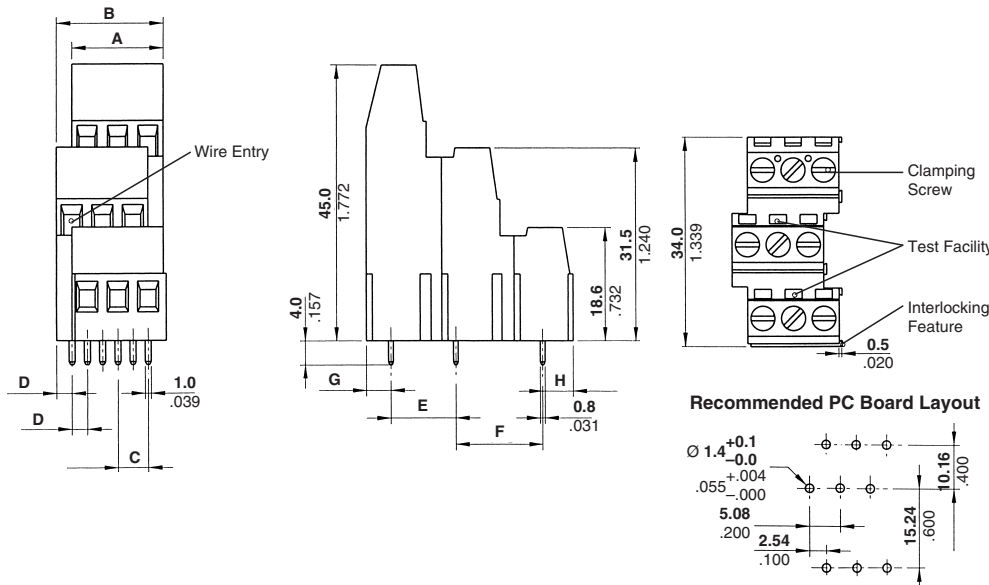

| No. of Positions | Dimensions | | | | | | | | Part Numbers | |
|------------------|------------|-------|------|------|-------|-------|------|------|--------------|-------|
| | A | B | C | D | E | F | G | H | Green | Black |
| 2 | 10.16 | 12.70 | 5.08 | 2.54 | 10.16 | 15.24 | 3.6 | 5.0 | 282917-2 | |
| | .400 | .500 | .200 | .100 | .400 | .600 | .142 | .197 | | |
| 3 | 15.24 | 17.78 | 5.08 | 2.54 | 10.16 | 15.24 | 3.6 | 5.0 | 282917-3 | |
| | .600 | .700 | .200 | .100 | .400 | .600 | .142 | .197 | | |

Note: All part numbers are RoHS Compliant.

Board Mount, 2nd Level Stacking Connectors

Board Mount w/Interlock
5.0 mm Centerline,
2nd Level, Stacking
Color – Green
UL Rating – 300 V, 13.5 A
16-30 AWG
10 A for field wiring applications

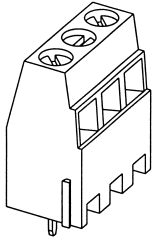

Suggested Screw Torque—
 6.0 in.-lb.

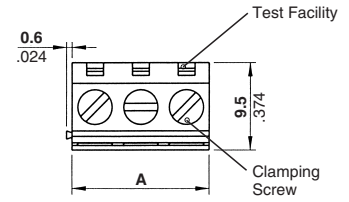
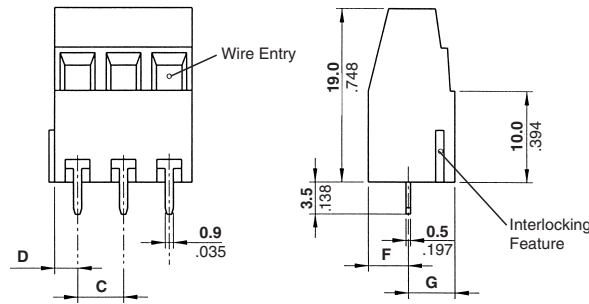

Recommended PC Board Layout

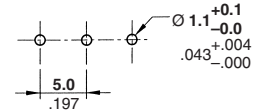

| No. of Positions | Dimensions | | | | | Part Numbers |
|------------------|--------------|-------------|-------------|-------------|-------------|--------------|
| | A | C | D | F | G | |
| 2 | 10.0 .394 | 5.0 .197 | 2.5 .098 | 4.4 .173 | 5.1 .201 | 282880-2 |
| 3 | 15.0 .591 | 5.0 .197 | 2.5 .098 | 4.4 .173 | 5.1 .201 | 282880-3 |

Board Mount w/Interlock
5.0 mm Centerline,
2nd Level, Stacking
Color – Green
UL Rating – 300 V, 17.5 A
12-30 AWG
15 A for field wiring applications

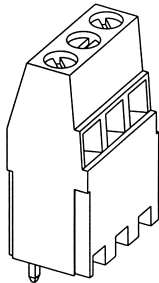

Suggested Screw Torque—
 7.0 in.-lb.

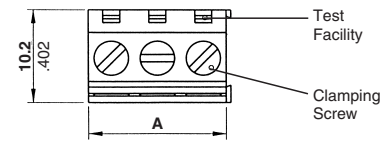
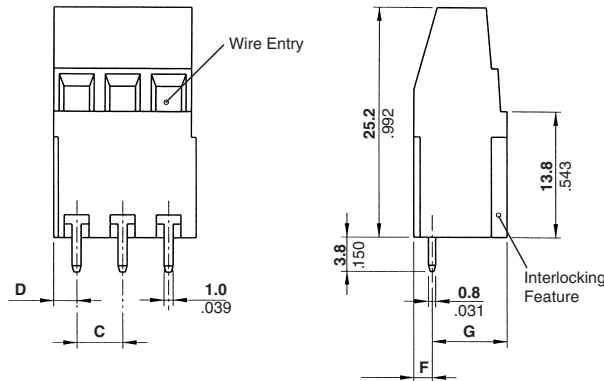

Recommended PC Board Layout

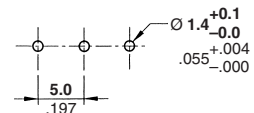

| No. of Positions | Dimensions | | | | | Part Numbers |
|------------------|--------------|-------------|-------------|-------------|-------------|--------------|
| | A | C | D | F | G | |
| 2 | 10.0 .394 | 5.0 .197 | 2.5 .098 | 2.0 .079 | 8.2 .323 | 282900-2 |
| 3 | 15.0 .591 | 5.0 .197 | 2.5 .098 | 2.0 .079 | 8.2 .323 | 282900-3 |

Note: All part numbers are RoHS Compliant.

Board Mount, 2nd Level Stacking Connectors (Continued)

Board Mount w/Interlock
5.0 mm Centerline,
2nd Level, Stacking
Color – Green

UL Rating – 300 V, 24 A
12-30 AWG
20 A for field wiring applications

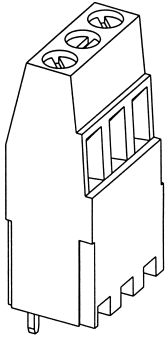

Suggested Screw Torque—
7.0 in.-lb.

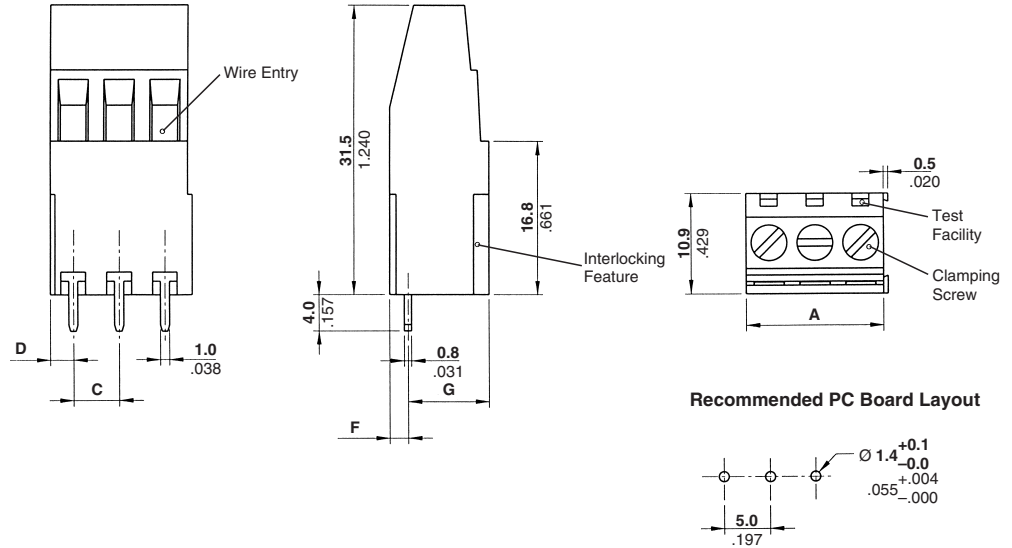

| No. of Positions | Dimensions | | | | | Part Numbers |
|------------------|--------------|-------------|-------------|-------------|-------------|--------------|
| | A | C | D | F | G | |
| 2 | 10.0 .394 | 5.0 .197 | 2.5 .098 | 2.0 .079 | 8.9 .350 | 282920-2 |
| 3 | 15.0 .591 | 5.0 .197 | 2.5 .098 | 2.0 .079 | 8.9 .350 | 282920-3 |

Board Mount w/Interlock
5.08 mm Centerline,
2nd Level, Stacking
Color – Green

UL Rating – 300 V, 13.5 A
16-30 AWG
10 A for field wiring applications

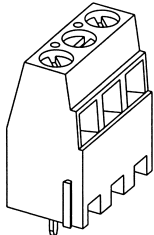

Suggested Screw Torque—
6.0 in.-lb.

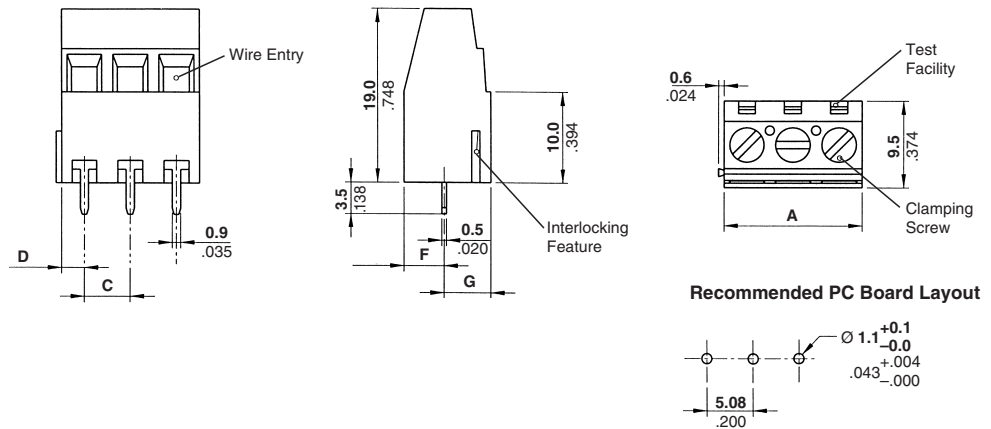

| No. of Positions | Dimensions | | | | | Part Numbers |
|------------------|---------------|--------------|--------------|--------------|--------------|--------------|
| | A | C | D | F | G | |
| 2 | 10.16 .400 | 5.08 .200 | 2.54 .100 | 4.24 .167 | 5.26 .207 | 282881-2 |
| 3 | 15.24 .600 | 5.08 .200 | 2.54 .100 | 4.24 .167 | 5.26 .207 | 282881-3 |



Note: All part numbers are RoHS Compliant.

Board Mount, 2nd Level Stacking Connectors (Continued)

Board Mount w/Interlock
5.08 mm Centerline,
2nd Level, Stacking
Color – Green

UL Rating – 300 V, 17.5 A
12-30 AWG
15 A for field wiring applications

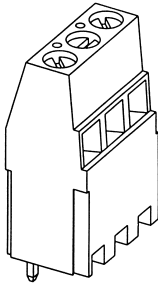

Suggested Screw Torque—
 7.0 in.-lb.

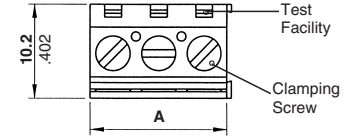
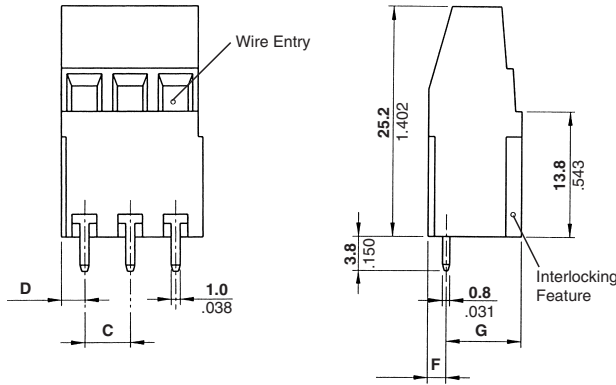

Recommended PC Board Layout

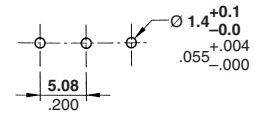

| No. of Positions | Dimensions | | | | | Part Numbers |
|------------------|---------------|--------------|--------------|--------------|--------------|--------------|
| | A | C | D | F | G | |
| 2 | 10.16 .400 | 5.08 .200 | 2.54 .100 | 1.76 .069 | 8.44 .332 | 282901-2 |
| 3 | 15.24 .600 | 5.08 .200 | 2.54 .100 | 1.76 .069 | 8.44 .332 | 282901-3 |

Board Mount w/Interlock
5.08 mm Centerline,
2nd Level, Stacking
Color – Green

UL Rating – 300 V, 24 A
12-30 AWG
20 A for field wiring applications

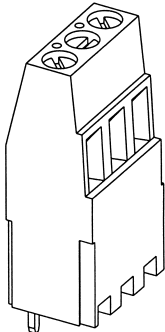

Suggested Screw Torque—
 7.0 in.-lb.

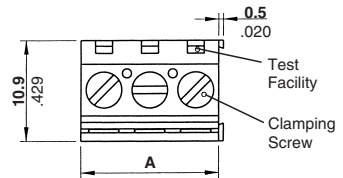
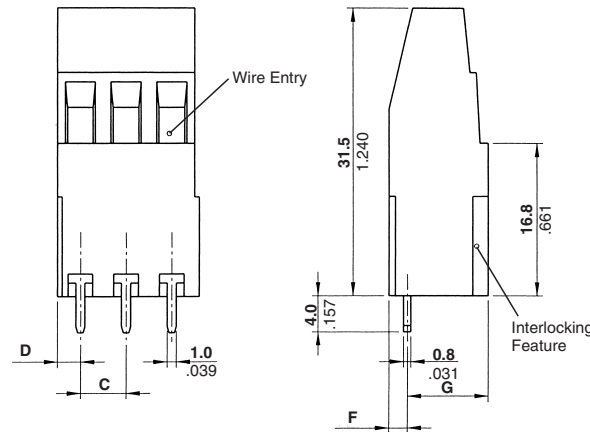

Recommended PC Board Layout

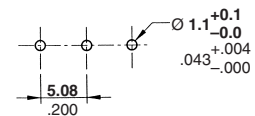

| No. of Positions | Dimensions | | | | | Part Numbers |
|------------------|---------------|--------------|--------------|--------------|--------------|--------------|
| | A | C | D | F | G | |
| 2 | 10.16 .400 | 5.08 .200 | 2.54 .100 | 1.76 .069 | 9.14 .360 | 282921-2 |
| 3 | 15.24 .600 | 5.08 .200 | 2.54 .100 | 1.76 .069 | 9.14 .360 | 282921-3 |

Note: All part numbers are RoHS Compliant.

Board Mount, 3rd Level Stacking Connectors

Board Mount w/Interlock
5.0 mm Centerline,
3rd Level, Stacking
Color – Green
UL Rating – 300 V, 13.5 A
16-30 AWG
10 A for field wiring applications

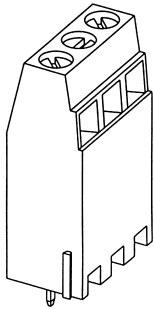

Suggested Screw Torque—
 6.0 in.-lb.

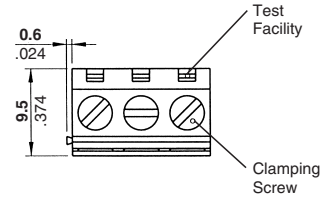
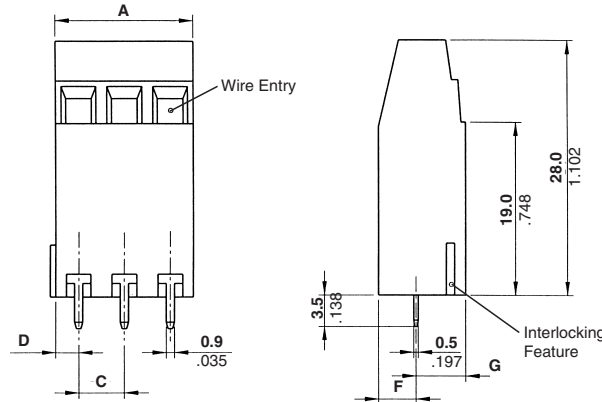

Recommended PC Board Layout

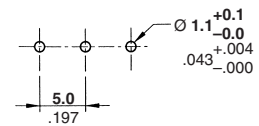

| No. of Positions | Dimensions | | | | | Part Numbers |
|------------------|--------------|-------------|-------------|-------------|-------------|--------------|
| | A | C | D | F | G | |
| 2 | 10.0 .394 | 5.0 .197 | 2.5 .098 | 4.1 .173 | 5.4 .213 | 282884-2 |
| 3 | 15.0 .591 | 5.0 .197 | 2.5 .098 | 4.1 .173 | 5.4 .213 | 282884-3 |

Board Mount w/Interlock
5.0 mm Centerline,
3rd Level, Stacking
Color – Green
UL Rating – 300 V, 24 A
12-30 AWG
20 A for field wiring applications

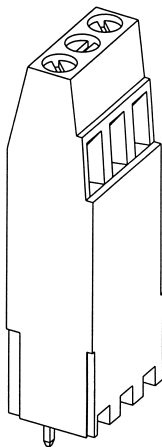

Suggested Screw Torque—
 7.0 in.-lb.

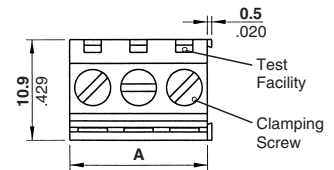
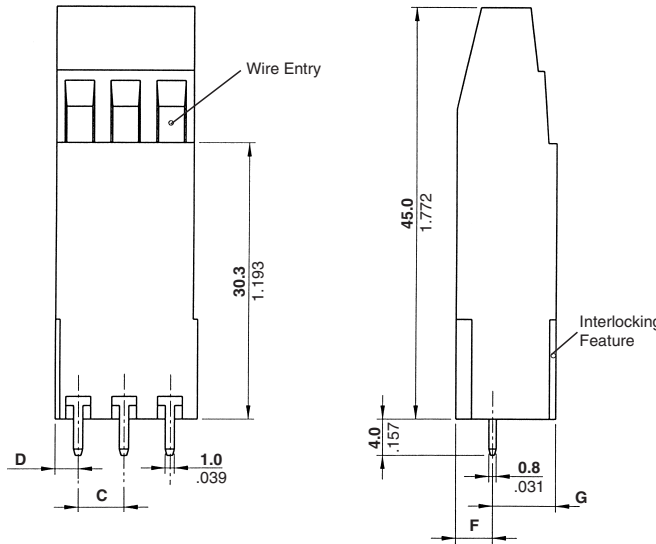

Recommended PC Board Layout

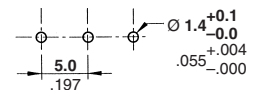

| No. of Positions | Dimensions | | | | | Part Numbers |
|------------------|--------------|-------------|-------------|-------------|-------------|--------------|
| | A | C | D | F | G | |
| 2 | 10.0 .394 | 5.0 .197 | 2.5 .098 | 4.0 .157 | 6.9 .272 | 282924-2 |
| 3 | 15.0 .591 | 5.0 .197 | 2.5 .098 | 4.0 .157 | 6.9 .272 | 282924-3 |

Note: All part numbers are RoHS Compliant.

Board Mount, 3rd Level Stacking Connectors (Continued)

Board Mount w/Interlock
5.08 mm Centerline,
3rd Level, Stacking
Color – Green

UL Rating – 300 V, 17.5 A
12-30 AWG
15 A for field wiring applications

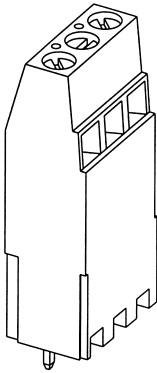

Suggested Screw Torque—
 7.0 in.-lb.

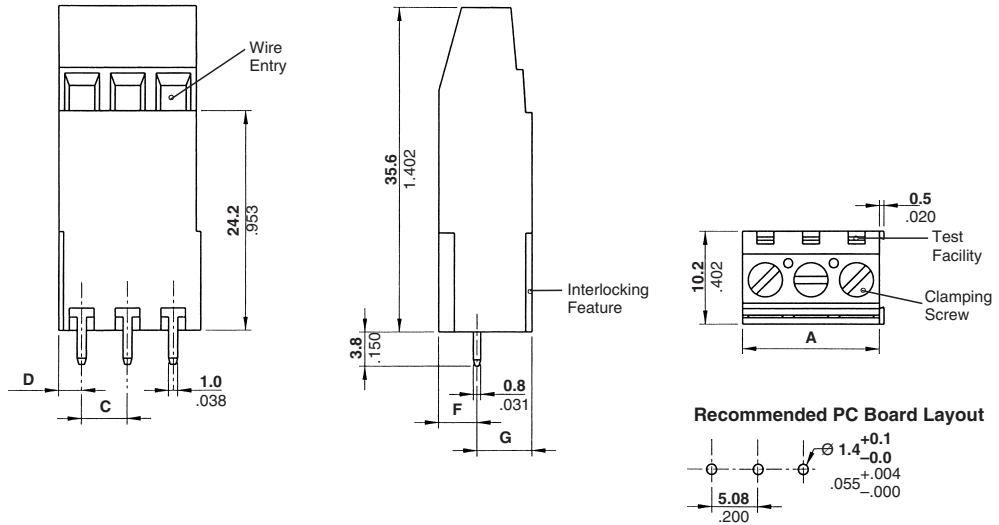

| No. of Positions | Dimensions | | | | | Part Numbers |
|------------------|---------------|--------------|--------------|-------------|-------------|--------------|
| | A | C | D | F | G | |
| 2 | 10.16 .400 | 5.08 .200 | 2.54 .100 | 3.8 .150 | 6.4 .252 | 282905-2 |
| 3 | 15.24 .600 | 5.08 .200 | 2.54 .100 | 3.8 .150 | 6.4 .252 | 282905-3 |

Board Mount w/Interlock
5.08 mm Centerline,
3rd Level, Stacking
Color – Green

UL Rating – 300 V, 24 A
12-30 AWG
20 A for field wiring applications

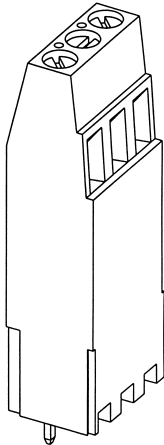

Suggested Screw Torque—
 7.0 in.-lb.

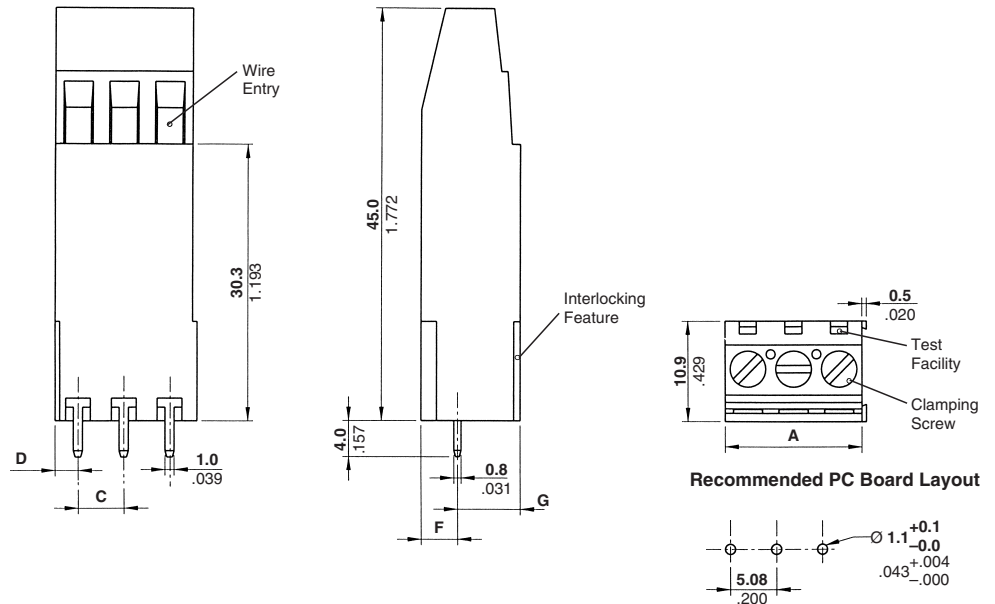

| No. of Positions | Dimensions | | | | | Part Number |
|------------------|---------------|--------------|--------------|-------------|-------------|-------------|
| | A | C | D | F | G | |
| 2 | 10.16 .400 | 5.08 .200 | 2.54 .100 | 3.6 .142 | 7.3 .287 | 282925-2 |
| 3 | 15.24 .600 | 5.08 .200 | 2.54 .100 | 3.6 .142 | 7.3 .287 | 282925-3 |

Note: All part numbers are RoHS Compliant.

Board Mount, 3rd Level Stacking Connectors (Continued)

Board Mount w/Interlock
10.0 mm Centerline,
3rd Level, Stacking
Color – Green

UL Rating – 600 V, 17.5 A
16-30 AWG
15 A for field wiring applications

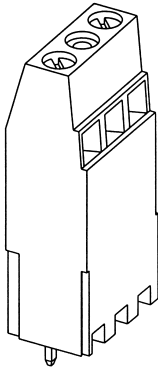

Suggested Screw Torque—
7.0 in.-lb.

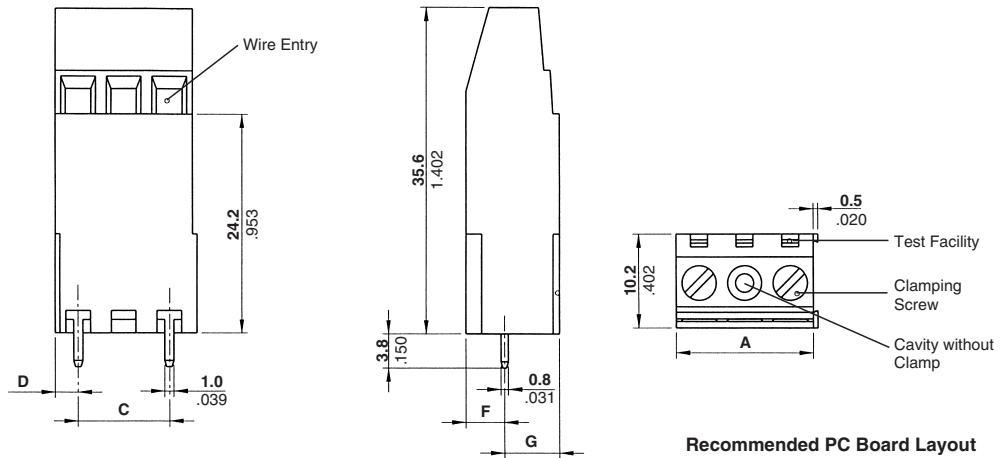

Recommended PC Board Layout

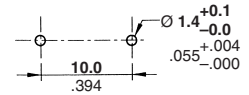

| No. of Positions | Dimensions | | | | | Part Number |
|------------------|--------------|--------------|-------------|-------------|-------------|-------------|
| | A | C | D | F | G | |
| 2 | 15.0 .591 | 10.0 .394 | 2.5 .098 | 4.2 .165 | 6.0 .236 | 282906-2 |



Note: All part numbers are RoHS Compliant.

Two-Piece Terminal Block Connectors

Two-Piece Terminal Block Connectors

Tyco Electronics currently provides a full range of two-piece modular terminal blocks for headers with 3.5, 3.81, 5.0, 5.08, 7.5, 7.62, 10.0 and 10.16 mm centerline.

Product Facts

- n 3.5, 3.81, 5.0, 5.08, 7.5, 7.62, 10.0 and 10.16 mm centerlines
- n Straight and right-angle shrouded headers with open or closed ends
- n Double-sided female contact design
- n Built-in interlocks to assemble higher number of ways
- n Retention latches between plug and header
- n Polarization keys for easier mating
- n Special 90°/180° and 90°/270° Plugs and Unshrouded Headers (5.0 and 10.0mm Centerline)
- n Interchangeable with existing products of most terminal block suppliers
- n PC board footprint fully compatible with existing Industry Standards: pc board thickness 1.6–2.4 mm
- n 2-3-4 way modules with interlocking fixture, 3.5, 3.81, 5.0 and 5.08 mm centerline, to assemble higher number of ways
- n Polarizing keys promote proper mating (see page 108 for keys and page 107 for labeling)
- n Straight and right-angle headers
- n Stackable open end headers
- n Closed end headers
- n Retention latch between plug and header housings
- n Rising cage clamp design
- n Double-sided contact spring
- n Funnel entry plug housing for easier wire insertion
- n Captive screw
- n Plugs supplied with open screw

- n **Screw flange versions available on 3.5, 3.81, 5.0, and 5.08 mm centerlines**
- n **5.0 and 10.0 mm centerlines**
- n **Recognized under the Component Program of Underwriters Laboratories Inc., File No. E60677** 
- n **Certified by Canadian Standards Association, File No. 703157** 
- n **Interchangeable with most existing products**
- n **PC board footprint compatible with the existing Industry Standards**
- n **Rising cage clamp design**
- n **Funnel entry housing for easier wire insertion**
- n **Test probe access**
- n **Terminal blocks supplied with open captive screws**
- n **Adhesive labeling for numbering**

Housing Material—Polyamide 6/6, UL 94V-0 rated
Male Contact—Brass, tin plated
Female Contact—Phosphor bronze, tin plated
Screw Clamp—Brass, nickel plated
Screw—Brass, nickel plated

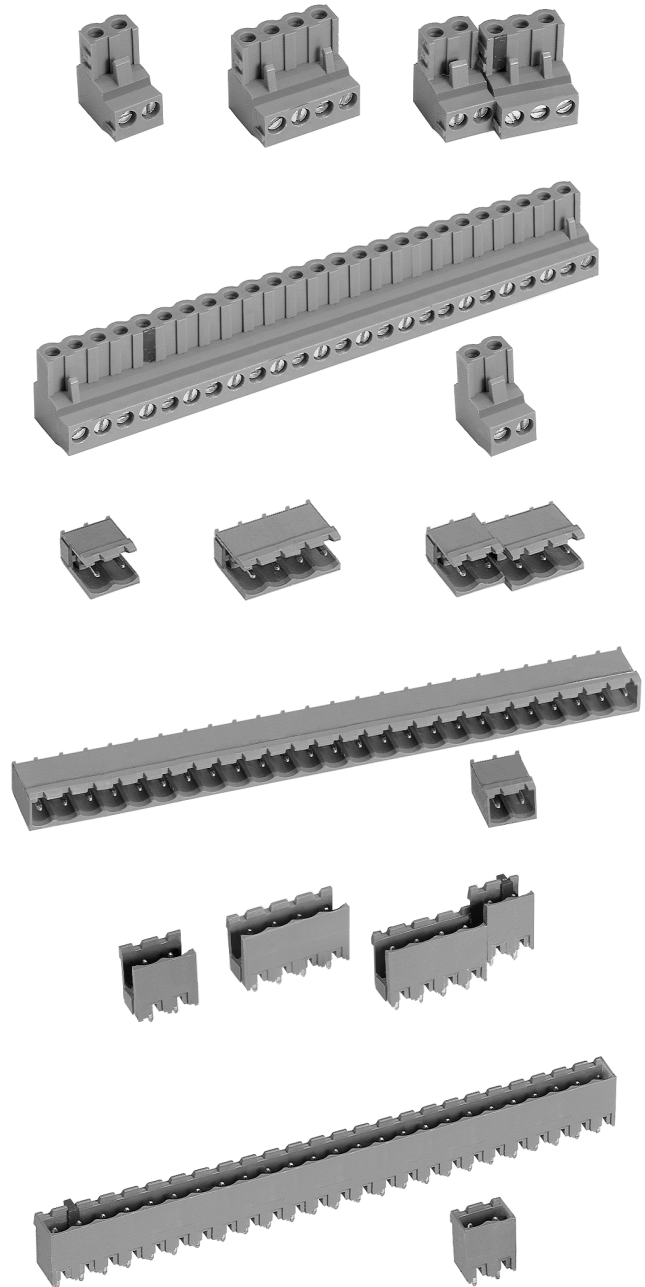

Two-Piece Header and Plug

| Centerline | No. of Positions |
|--------------|------------------|
| 3.50 [.138]* | 2–25 |
| 3.81 [.150]* | 2–25 |
| 5.00 [.197]* | 2–25 |
| 5.08 [.200]* | 2–25 |
| 7.50 [.295] | 2–12 |
| 7.62 [.300] | 2–12 |
| 10.00 [.394] | 2–13 |
| 10.16 [.400] | 2–13 |

*Flanged versions may not reflect standard position size.

Note: All part numbers are RoHS Compliant.

Two-Piece Terminal Block Connectors (Continued)

Straight Header w/Threaded Flange, 3.5 mm Centerline
UL Rating – 300 V, 11 A

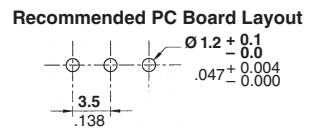
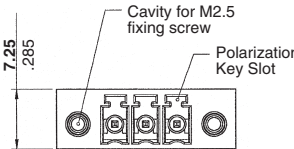
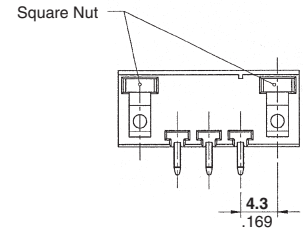
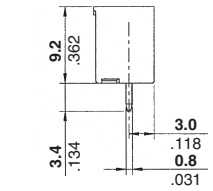
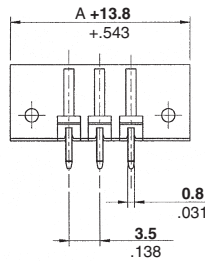
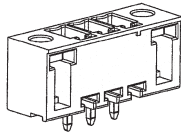

| No. of Positions | Dim. A | Part Numbers | |
|------------------|--------------|--------------|-------------|
| | | Green | Black* |
| 2 | 3.5 [0.138] | 284516-2 | 1776132-2 |
| 3 | 7.0 [0.276] | 284516-3 | 1776132-3 |
| 4 | 10.5 [0.413] | 284516-4 | 1776132-4 |
| 5 | 14.0 [0.551] | 284516-5 | 1776132-5 |
| 6 | 17.5 [0.689] | 284516-6 | 1776132-6 |
| 7 | 21.0 [0.827] | 284516-7 | 1776132-7 |
| 8 | 24.5 [0.965] | 284516-8 | 1776132-8 |
| 9 | 28.0 [1.102] | 284516-9 | 1776132-9 |
| 10 | 31.5 [1.240] | 1-284516-0 | 1-1776132-0 |
| 11 | 35.0 [1.378] | 1-284516-1 | 1-1776132-1 |
| 12 | 38.5 [1.516] | 1-284516-2 | 1-1776132-2 |

| No. of Positions | Dim. A | Part Numbers | |
|------------------|--------------|--------------|--------|
| | | Green | Black* |
| 13 | 42.0 [1.654] | 1-284516-3 | — |
| 14 | 45.5 [1.791] | 1-284516-4 | — |
| 15 | 49.0 [1.929] | 1-284516-5 | — |
| 16 | 52.5 [2.067] | 1-284516-6 | — |
| 17 | 56.0 [2.205] | 1-284516-7 | — |
| 18 | 59.5 [2.343] | 1-284516-8 | — |
| 19 | 63.0 [2.480] | 1-284516-9 | — |
| 20 | 66.5 [2.618] | 2-284516-0 | — |
| 21 | 70.0 [2.756] | 2-284516-1 | — |
| 22 | 73.5 [2.894] | 2-284516-2 | — |
| 23 | 77.0 [3.031] | 2-284516-3 | — |

*Wave solder process capable to 265°C [509°F] for 10 seconds. Dimensions may vary from what is shown for High Temperature Parts. Please check Customer Drawing.

Straight Header w/Threaded Flange, 3.81 mm Centerline
UL Rating – 300 V, 11 A

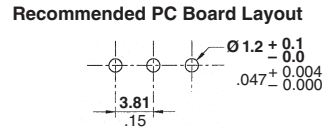
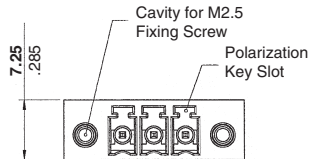
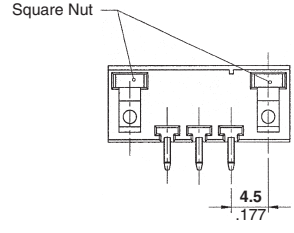
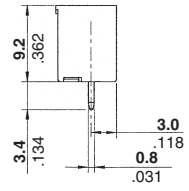
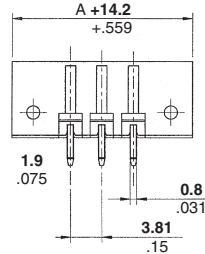
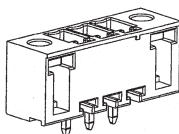

| No. of Positions | Dim. A | Part Numbers | |
|------------------|--------------|--------------|-------------|
| | | Green | Black* |
| 2 | 3.81 [0.15] | 284519-2 | 1776133-2 |
| 3 | 7.62 [0.30] | 284519-3 | 1776133-3 |
| 4 | 11.43 [0.45] | 284519-4 | 1776133-4 |
| 5 | 15.24 [0.60] | 284519-5 | 1776133-5 |
| 6 | 19.05 [0.75] | 284519-6 | 1776133-6 |
| 7 | 22.86 [0.90] | 284519-7 | 1776133-7 |
| 8 | 26.67 [1.05] | 284519-8 | 1776133-8 |
| 9 | 30.48 [1.20] | 284519-9 | 1776133-9 |
| 10 | 34.29 [1.35] | 1-284519-0 | 1-1776133-0 |
| 11 | 38.10 [1.50] | 1-284519-1 | 1-1776133-1 |
| 12 | 41.91 [1.65] | 1-284519-2 | 1-1776133-2 |

| No. of Positions | Dim. A | Part Numbers | |
|------------------|--------------|--------------|--------|
| | | Green | Black* |
| 13 | 45.72 [1.80] | 1-284519-3 | — |
| 14 | 49.53 [1.95] | 1-284519-4 | — |
| 15 | 53.34 [2.10] | 1-284519-5 | — |
| 16 | 57.15 [2.25] | 1-284519-6 | — |
| 17 | 60.96 [2.40] | 1-284519-7 | — |
| 18 | 64.77 [2.55] | 1-284519-8 | — |
| 19 | 68.58 [2.70] | 1-284519-9 | — |
| 20 | 72.39 [2.85] | 2-284519-0 | — |
| 21 | 76.20 [3.00] | 2-284519-1 | — |
| 22 | 80.01 [3.15] | 2-284519-2 | — |
| 23 | 83.82 [3.30] | 2-284519-3 | — |

*Wave solder process capable to 265°C [509°F] for 10 seconds. Dimensions may vary from what is shown for High Temperature Parts. Please check Customer Drawing.



Note: All part numbers are RoHS Compliant.

Two-Piece Terminal Block Connectors (Continued)

**Straight Header w/Locking
Screw Flange,
5.08 mm Centerline,
Color – Green
UL Rating – 300 V, 15 A**

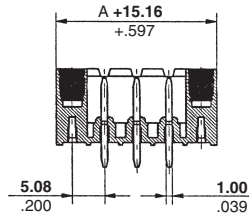
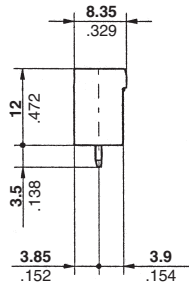

Recommended PC Board Layout

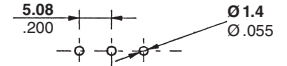

| No. of Positions | Dim. A | Part Numbers |
|------------------|--------------|--------------|
| 2 | 5.08 [0.20] | 796867-2 |
| 3 | 10.16 [0.40] | 796867-3 |
| 4 | 15.24 [0.60] | 796867-4 |
| 5 | 20.32 [0.80] | 796867-5 |
| 6 | 25.40 [1.00] | 796867-6 |
| 7 | 30.48 [1.20] | 796867-7 |
| 8 | 35.56 [1.40] | 796867-8 |
| 9 | 40.64 [1.60] | 796867-9 |
| 10 | 45.72 [1.80] | 1-796867-0 |
| 11 | 50.80 [2.00] | 1-796867-1 |
| 12 | 55.88 [2.20] | 1-796867-2 |

| No. of Positions | Dim. A | Part Numbers |
|------------------|---------------|--------------|
| 13 | 60.96 [2.40] | 1-796867-3 |
| 14 | 66.04 [2.60] | 1-796867-4 |
| 15 | 71.12 [2.80] | 1-796867-5 |
| 16 | 76.20 [3.00] | 1-796867-6 |
| 17 | 81.28 [3.20] | 1-796867-7 |
| 18 | 86.36 [3.40] | 1-796867-8 |
| 19 | 91.44 [3.60] | 1-796867-9 |
| 20 | 96.52 [3.80] | 2-796867-0 |
| 21 | 101.60 [4.00] | 2-796867-1 |
| 22 | 106.68 [4.20] | 2-796867-2 |
| 23 | 111.76 [4.40] | 2-796867-3 |

Note: All part numbers are RoHS Compliant.

Two-Piece Terminal Block Connectors (Continued)

Right-Angle Closed End Header w/Threaded Flange, 3.5 mm Centerline
UL Rating – 300 V, 11 A

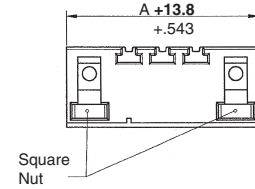
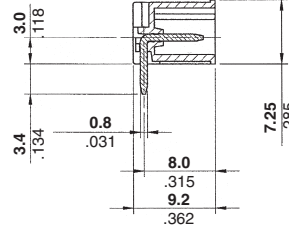
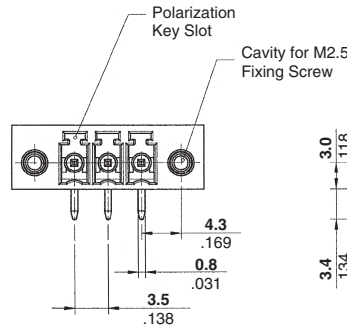
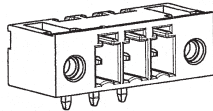

Recommended PC Board Layout

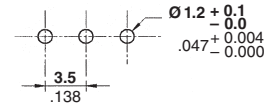

| No. of Positions | Dim. A | Part Numbers | |
|------------------|--------------|--------------|-------------|
| | | Green | Black* |
| 2 | 3.5 [0.138] | 284539-2 | 1776136-2 |
| 3 | 7.0 [0.276] | 284539-3 | 1776136-3 |
| 4 | 10.5 [0.413] | 284539-4 | 1776136-4 |
| 5 | 14.0 [0.551] | 284539-5 | 1776136-5 |
| 6 | 17.5 [0.689] | 284539-6 | 1776136-6 |
| 7 | 21.0 [0.827] | 284539-7 | 1776136-7 |
| 8 | 24.5 [0.965] | 284539-8 | 1776136-8 |
| 9 | 28.0 [1.102] | 284539-9 | 1776136-9 |
| 10 | 31.5 [1.240] | 1-284539-0 | 1-1776136-0 |
| 11 | 35.0 [1.378] | 1-284539-1 | 1-1776136-1 |
| 12 | 38.5 [1.516] | 1-284539-2 | 1-1776136-2 |

| No. of Positions | Dim. A | Part Numbers | |
|------------------|--------------|--------------|--------|
| | | Green | Black* |
| 13 | 42.0 [1.654] | 1-284539-3 | — |
| 14 | 45.5 [1.791] | 1-284539-4 | — |
| 15 | 49.0 [1.929] | 1-284539-5 | — |
| 16 | 52.5 [2.067] | 1-284539-6 | — |
| 17 | 56.0 [2.205] | 1-284539-7 | — |
| 18 | 59.5 [2.343] | 1-284539-8 | — |
| 19 | 63.0 [2.480] | 1-284539-9 | — |
| 20 | 66.5 [2.618] | 2-284539-0 | — |
| 21 | 70.0 [2.756] | 2-284539-1 | — |
| 22 | 73.5 [2.894] | 2-284539-2 | — |
| 23 | 77.0 [3.031] | 2-284539-3 | — |

*Wave solder process capable to 265°C [509°F] for 10 seconds. Dimensions may vary from what is shown for High Temperature Parts. Please check Customer Drawing.

Right-Angle Closed End Header w/Threaded Flange, 3.81 mm Centerline
UL Rating – 300 V, 11 A

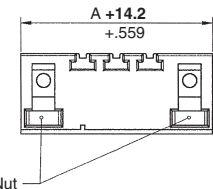
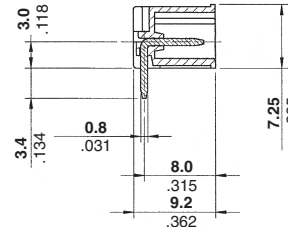
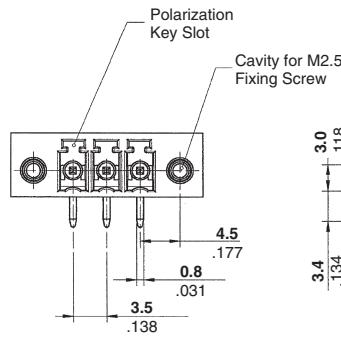
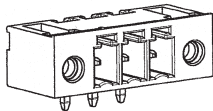

Recommended PC Board Layout

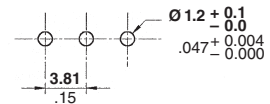

| No. of Positions | Dim. A | Part Numbers | |
|------------------|--------------|--------------|-------------|
| | | Green | Black* |
| 2 | 3.81 [0.15] | 284541-2 | 1776137-2 |
| 3 | 7.62 [0.30] | 284541-3 | 1776137-3 |
| 4 | 11.43 [0.45] | 284541-4 | 1776137-4 |
| 5 | 15.24 [0.60] | 284541-5 | 1776137-5 |
| 6 | 19.05 [0.75] | 284541-6 | 1776137-6 |
| 7 | 22.86 [0.90] | 284541-7 | 1776137-7 |
| 8 | 26.67 [1.05] | 284541-8 | 1776137-8 |
| 9 | 30.48 [1.20] | 284541-9 | 1776137-9 |
| 10 | 34.29 [1.35] | 1-284541-0 | 1-1776137-0 |
| 11 | 38.10 [1.50] | 1-284541-1 | 1-1776137-1 |
| 12 | 41.91 [1.65] | 1-284541-2 | 1-1776137-2 |

| No. of Positions | Dim. A | Part Numbers | |
|------------------|--------------|--------------|--------|
| | | Green | Black* |
| 13 | 45.72 [1.80] | 1-284541-3 | — |
| 14 | 49.53 [1.95] | 1-284541-4 | — |
| 15 | 53.34 [2.10] | 1-284541-5 | — |
| 16 | 57.15 [2.25] | 1-284541-6 | — |
| 17 | 60.96 [2.40] | 1-284541-7 | — |
| 18 | 64.77 [2.55] | 1-284541-8 | — |
| 19 | 68.58 [2.70] | 1-284541-9 | — |
| 20 | 72.39 [2.85] | 2-284541-0 | — |
| 21 | 76.20 [3.00] | 2-284541-1 | — |
| 22 | 80.01 [3.15] | 2-284541-2 | — |
| 23 | 83.82 [3.30] | 2-284541-3 | — |

*Wave solder process capable to 265°C [509°F] for 10 seconds. Dimensions may vary from what is shown for High Temperature Parts. Please check Customer Drawing.

Note: All part numbers are RoHS Compliant.

Two-Piece Terminal Block Connectors (Continued)

Right-Angle Header w/Locking Screw Flange, 5.0 mm Centerline, Color – Green
UL Rating – 300 V, 15 A

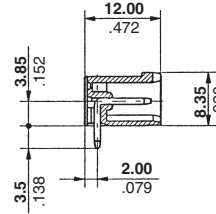
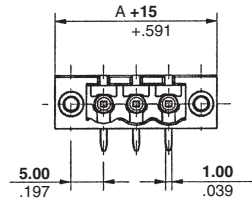
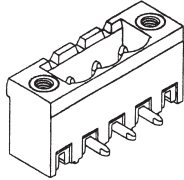

Recommended PC Board Layout

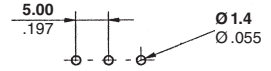

| No. of Positions | Dim. A | Part Numbers |
|------------------|--------------|--------------|
| 2 | 5.0 [0.197] | 796864-2 |
| 3 | 10.0 [0.394] | 796864-3 |
| 4 | 15.0 [0.591] | 796864-4 |
| 5 | 20.0 [0.787] | 796864-5 |
| 6 | 25.0 [0.984] | 796864-6 |
| 7 | 30.0 [1.181] | 796864-7 |
| 8 | 35.0 [1.378] | 796864-8 |

Right-Angle Header w/Locking Screw Flange, 5.08 mm Centerline, Color – Green
UL Rating – 300 V, 15 A

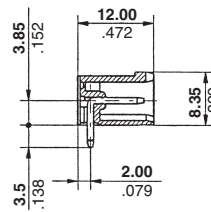
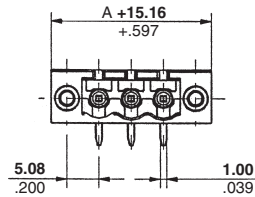
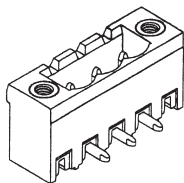

Recommended PC Board Layout

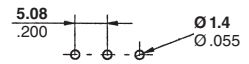

| No. of Positions | Dim. A | Part Numbers |
|------------------|--------------|--------------|
| 2 | 5.08 [0.20] | 796866-2 |
| 3 | 10.16 [0.40] | 796866-3 |
| 4 | 15.24 [0.60] | 796866-4 |
| 5 | 20.32 [0.80] | 796866-5 |
| 6 | 25.40 [1.00] | 796866-6 |
| 7 | 30.48 [1.20] | 796866-7 |
| 8 | 35.56 [1.40] | 796866-8 |
| 9 | 40.64 [1.60] | 796866-9 |
| 10 | 45.72 [1.80] | 1-796866-0 |
| 11 | 50.80 [2.00] | 1-796866-1 |
| 12 | 55.88 [2.20] | 1-796866-2 |

| No. of Positions | Dim. A | Part Numbers |
|------------------|---------------|--------------|
| 13 | 60.96 [2.40] | 1-796866-3 |
| 14 | 66.04 [2.60] | 1-796866-4 |
| 15 | 71.12 [2.80] | 1-796866-5 |
| 16 | 76.20 [3.00] | 1-796866-6 |
| 17 | 81.28 [3.20] | 1-796866-7 |
| 18 | 86.36 [3.40] | 1-796866-8 |
| 19 | 91.44 [3.60] | 1-796866-9 |
| 20 | 96.52 [3.80] | 2-796866-0 |
| 21 | 101.60 [4.00] | 2-796866-1 |
| 22 | 106.68 [4.20] | 2-796866-2 |
| 23 | 111.76 [4.40] | 2-796866-3 |

Note: All part numbers are RoHS Compliant.

Two-Piece Terminal Block Connectors (Continued)

Straight, Open End Headers, 3.5 mm Centerline

UL Rating – 300 V, 11 A

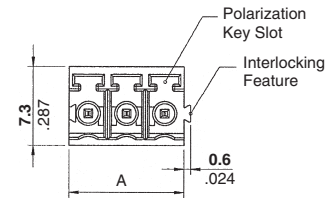
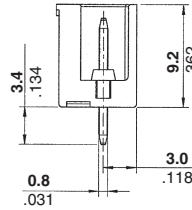
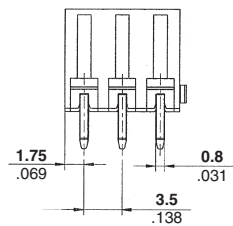
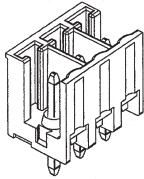

Recommended PC Board Layout

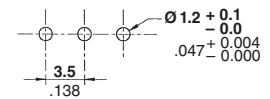

| No. of Positions | Dim. A | Part Numbers Green |
|------------------|--------------|--------------------|
| 2 | 7.0 [0.276] | 284515-2 |
| 3 | 10.5 [0.413] | 284515-3 |
| 4 | 14.0 [0.551] | 284515-4 |
| 5 | 17.5 [0.689] | 284515-5 |
| 6 | 21.0 [0.827] | 284515-6 |
| 7 | 24.5 [0.965] | 284515-7 |
| 8 | 28.0 [1.102] | 284515-8 |
| 9 | 31.5 [1.240] | 284515-9 |
| 10 | 35.0 [1.378] | 1-284515-0 |
| 11 | 38.5 [1.516] | 1-284515-1 |
| 12 | 42.0 [1.654] | 1-284515-2 |
| 13 | 45.5 [1.791] | 1-284515-3 |

| No. of Positions | Dim. A | Part Numbers Green |
|------------------|--------------|--------------------|
| 14 | 49.0 [1.929] | 1-284515-4 |
| 15 | 52.5 [2.067] | 1-284515-5 |
| 16 | 56.0 [2.205] | 1-284515-6 |
| 17 | 59.5 [2.343] | 1-284515-7 |
| 18 | 63.0 [2.480] | 1-284515-8 |
| 19 | 66.5 [2.618] | 1-284515-9 |
| 20 | 70.0 [2.756] | 2-284515-0 |
| 21 | 73.5 [2.894] | 2-284515-1 |
| 22 | 77.0 [3.031] | 2-284515-2 |
| 23 | 80.5 [3.169] | 2-284515-3 |
| 24 | 84.0 [3.307] | 2-284515-4 |
| 25 | 87.5 [3.445] | 2-284515-5 |

Straight, Closed End Headers, 3.5 mm Centerline

UL Rating – 300 V, 11 A

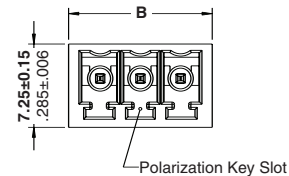
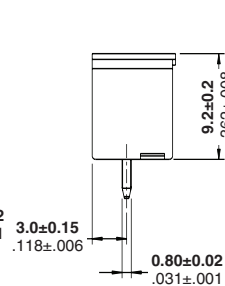
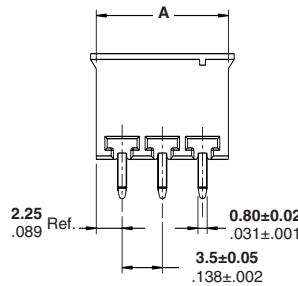
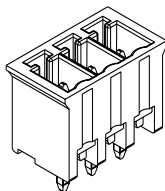

Recommended PC Board Layout

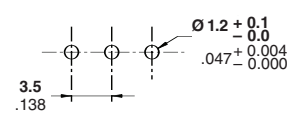

| Number of Positions | Dimensions | | Part Numbers | | |
|---------------------|--------------|--------------|--------------|------------|-------------|
| | A | B | Green | Blue | Black* |
| 2 | 8.0 [0.315] | 9.0 [0.354] | 284514-2 | 796694-2 | 1776130-2 |
| 3 | 11.5 [0.453] | 12.5 [0.492] | 284514-3 | 796694-3 | 1776130-3 |
| 4 | 15.0 [0.590] | 16.0 [0.630] | 284514-4 | 796694-4 | 1776130-4 |
| 5 | 18.5 [0.728] | 19.5 [0.768] | 284514-5 | 796694-5 | 1776130-5 |
| 6 | 22.0 [0.866] | 23.0 [0.906] | 284514-6 | 796694-6 | 1776130-6 |
| 7 | 25.5 [1.004] | 26.5 [1.043] | 284514-7 | 796694-7 | 1776130-7 |
| 8 | 29.0 [1.142] | 30.0 [1.181] | 284514-8 | 796694-8 | 1776130-8 |
| 9 | 32.5 [1.280] | 33.5 [1.319] | 284514-9 | 796694-9 | 1776130-9 |
| 10 | 36.0 [1.417] | 37.0 [1.457] | 1-284514-0 | 1-796694-0 | 1-1776130-0 |
| 11 | 39.5 [1.555] | 40.5 [1.594] | 1-284514-1 | 1-796694-1 | 1-1776130-1 |
| 12 | 43.0 [1.693] | 44.0 [1.732] | 1-284514-2 | 1-796694-2 | 1-1776130-2 |
| 13 | 46.5 [1.831] | 47.5 [1.870] | 1-284514-3 | 1-796694-3 | — |

| Number of Positions | Dimensions | | Part Numbers | | |
|---------------------|--------------|--------------|--------------|------------|--------|
| | A | B | Green | Blue | Black* |
| 14 | 50.0 [1.968] | 51.0 [2.008] | 1-284514-4 | 1-796694-4 | — |
| 15 | 53.5 [2.106] | 54.5 [2.146] | 1-284514-5 | 1-796694-5 | — |
| 16 | 57.0 [2.244] | 58.0 [2.283] | 1-284514-6 | 1-796694-6 | — |
| 17 | 60.5 [2.382] | 61.5 [2.421] | 1-284514-7 | 1-796694-7 | — |
| 18 | 64.0 [2.520] | 65.0 [2.599] | 1-284514-8 | 1-796694-8 | — |
| 19 | 67.5 [2.657] | 68.5 [2.697] | 1-284514-9 | 1-796694-9 | — |
| 20 | 71.0 [2.795] | 72.0 [2.835] | 2-284514-0 | 2-796694-0 | — |
| 21 | 74.5 [2.933] | 75.5 [2.972] | 2-284514-1 | 2-796694-1 | — |
| 22 | 78.0 [3.071] | 79.0 [3.110] | 2-284514-2 | 2-796694-2 | — |
| 23 | 81.5 [3.209] | 82.5 [3.248] | 2-284514-3 | 2-796694-3 | — |
| 24 | 85.0 [3.346] | 86.0 [3.386] | 2-284514-4 | 2-796694-4 | — |
| 25 | 88.5 [3.484] | 89.5 [3.524] | 2-284514-5 | 2-796694-5 | — |

Note: BUCHANAN Terminal Block Series B73N3VxxT has been superseded/replaced with 796694-xx.

*Wave solder process capable to 265°C [509°F] for 10 seconds. Dimensions may vary from what is shown for High Temperature Parts. Please check Customer Drawing.

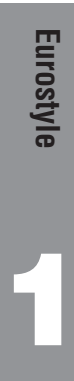

Note: All part numbers are RoHS Compliant.

Two-Piece Terminal Block Connectors (Continued)

**Straight, Open End Headers,
3.81 mm Centerline
Color – Green
UL Rating – 300 V, 11 A**

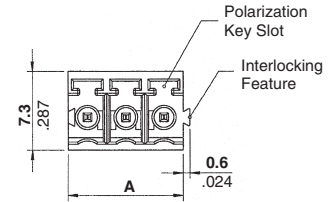
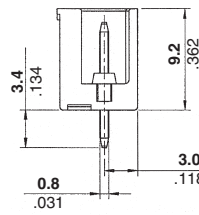
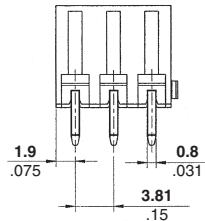
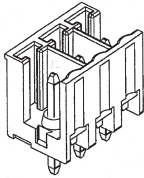

Recommended PC Board Layout

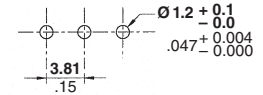

| No. of Positions | Dim. A | Part Numbers |
|------------------|--------------|--------------|
| 2 | 7.62 [0.30] | 284518-2 |
| 3 | 11.43 [0.45] | 284518-3 |
| 4 | 15.24 [0.60] | 284518-4 |
| 5 | 19.05 [0.75] | 284518-5 |
| 6 | 22.86 [0.90] | 284518-6 |
| 7 | 26.67 [1.05] | 284518-7 |
| 8 | 30.48 [1.20] | 284518-8 |
| 9 | 34.29 [1.35] | 284518-9 |
| 10 | 38.10 [1.50] | 1-284518-0 |
| 11 | 41.91 [1.65] | 1-284518-1 |
| 12 | 45.72 [1.80] | 1-284518-2 |
| 13 | 49.53 [1.95] | 1-284518-3 |

| No. of Positions | Dim. A | Part Numbers |
|------------------|--------------|--------------|
| 14 | 53.34 [2.10] | 1-284518-4 |
| 15 | 57.15 [2.25] | 1-284518-5 |
| 16 | 60.96 [2.40] | 1-284518-6 |
| 17 | 64.77 [2.55] | 1-284518-7 |
| 18 | 68.58 [2.70] | 1-284518-8 |
| 19 | 72.39 [2.85] | 1-284518-9 |
| 20 | 76.20 [3.00] | 2-284518-0 |
| 21 | 80.01 [3.15] | 2-284518-1 |
| 22 | 83.82 [3.30] | 2-284518-2 |
| 23 | 87.63 [3.45] | 2-284518-3 |
| 24 | 91.44 [3.60] | 2-284518-4 |
| 25 | 95.25 [3.75] | 2-284518-5 |

**Straight, Closed End Headers,
3.81 mm Centerline
UL Rating – 300 V, 11 A**

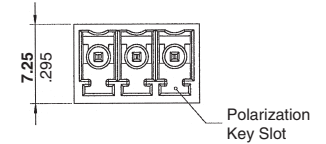
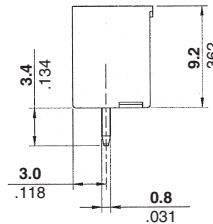
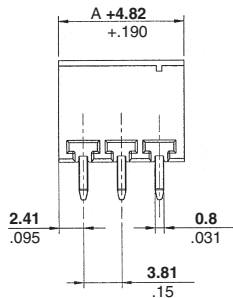
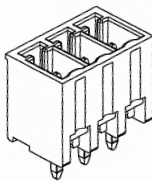

Recommended PC Board Layout

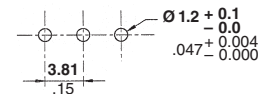

| No. of Positions | Dim. A | Part Numbers | |
|------------------|--------------|--------------|-------------|
| | | Green | Black* |
| 2 | 3.81 [0.15] | 284517-2 | 1776131-2 |
| 3 | 7.62 [0.30] | 284517-3 | 1776131-3 |
| 4 | 11.43 [0.45] | 284517-4 | 1776131-4 |
| 5 | 15.24 [0.60] | 284517-5 | 1776131-5 |
| 6 | 19.05 [0.75] | 284517-6 | 1776131-6 |
| 7 | 22.86 [0.90] | 284517-7 | 1776131-7 |
| 8 | 26.67 [1.05] | 284517-8 | 1776131-8 |
| 9 | 30.48 [1.20] | 284517-9 | 1776131-9 |
| 10 | 34.29 [1.35] | 1-284517-0 | 1-1776131-0 |
| 11 | 38.10 [1.50] | 1-284517-1 | 1-1776131-1 |
| 12 | 41.91 [1.65] | 1-284517-2 | 1-1776131-2 |
| 13 | 45.72 [1.80] | 1-284517-3 | — |

| No. of Positions | Dim. A | Part Numbers | |
|------------------|--------------|--------------|--------|
| | | Green | Black* |
| 14 | 53.34 [2.10] | 1-284517-4 | — |
| 15 | 57.15 [2.25] | 1-284517-5 | — |
| 16 | 60.96 [2.40] | 1-284517-6 | — |
| 17 | 64.77 [2.55] | 1-284517-7 | — |
| 18 | 68.58 [2.70] | 1-284517-8 | — |
| 19 | 72.39 [2.85] | 1-284517-9 | — |
| 20 | 76.20 [3.00] | 2-284517-0 | — |
| 21 | 80.01 [3.15] | 2-284517-1 | — |
| 22 | 83.82 [3.30] | 2-284517-2 | — |
| 23 | 87.63 [3.45] | 2-284517-3 | — |
| 24 | 91.44 [3.60] | 2-284517-4 | — |
| 25 | 95.25 [3.75] | 2-284517-5 | — |

*Wave solder process capable to 265°C [509°F] for 10 seconds. Dimensions may vary from what is shown for High Temperature Parts. Please check Customer Drawing.

Note: All part numbers are RoHS Compliant.

Two-Piece Terminal Block Connectors (Continued)

Straight, Open End Stacking Headers, 5.0 mm Centerline Color – See chart.

UL Rating – 300 V, 15 A

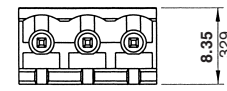
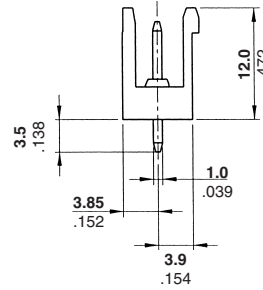
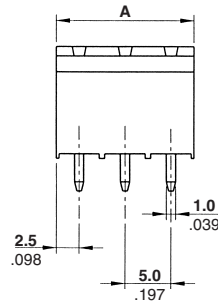
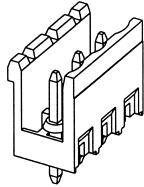

Recommended PC Board Layout

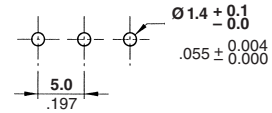

| No. of Positions | Dim. A | Part Numbers | | | | |
|------------------|--------------|--------------|------------|------------|-------------|--|
| | | Gray | Green | Blue | Black* | |
| 2 | 10.0 [0.394] | 1546212-2 | 282822-2 | 796697-2 | 1776138-2 | |
| 3 | 15.0 [0.591] | 1546212-3 | 282822-3 | 796697-3 | 1776138-3 | |
| 4 | 20.0 [0.787] | 1546212-4 | 282822-4 | 796697-4 | 1776138-4 | |
| 5 | 25.0 [0.984] | 1546212-5 | 282822-5 | 796697-5 | 1776138-5 | |
| 6 | 30.0 [1.181] | 1546212-6 | 282822-6 | 796697-6 | 1776138-6 | |
| 7 | 35.0 [1.378] | 1546212-7 | 282822-7 | 796697-7 | 1776138-7 | |
| 8 | 40.0 [1.575] | 1546212-8 | 282822-8 | 796697-8 | 1776138-8 | |
| 9 | 45.0 [1.772] | 1546212-9 | 282822-9 | 796697-9 | 1776138-9 | |
| 10 | 50.0 [1.968] | 1-1546212-0 | 1-282822-0 | 1-796697-0 | 1-1776138-0 | |
| 11 | 55.0 [2.165] | 1-1546212-1 | 1-282822-1 | 1-796697-1 | 1-1776138-1 | |
| 12 | 60.0 [2.362] | 1-1546212-2 | 1-282822-2 | 1-796697-2 | 1-1776138-2 | |
| 13 | 65.0 [2.559] | 1-1546212-3 | 1-282822-3 | 1-796697-3 | — | |

| No. of Positions | Dim. A | Part Numbers | | | | |
|------------------|---------------|--------------|------------|------------|--------|--|
| | | Gray | Green | Blue | Black* | |
| 14 | 70.0 [2.756] | 1-1546212-4 | 1-282822-4 | 1-796697-4 | — | |
| 15 | 75.0 [2.953] | 1-1546212-5 | 1-282822-5 | 1-796697-5 | — | |
| 16 | 80.0 [3.150] | 1-1546212-6 | 1-282822-6 | 1-796697-6 | — | |
| 17 | 85.0 [3.346] | 1-1546212-7 | 1-282822-7 | 1-796697-7 | — | |
| 18 | 90.0 [3.543] | 1-1546212-8 | 1-282822-8 | 1-796697-8 | — | |
| 19 | 95.0 [3.740] | 1-1546212-9 | 1-282822-9 | 1-796697-9 | — | |
| 20 | 100.0 [3.937] | 2-1546212-0 | 2-282822-0 | 2-796697-0 | — | |
| 21 | 105.0 [4.134] | 2-1546212-1 | 2-282822-1 | 2-796697-1 | — | |
| 22 | 110.0 [4.331] | 2-1546212-2 | 2-282822-2 | 2-796697-2 | — | |
| 23 | 115.0 [4.528] | 2-1546212-3 | 2-282822-3 | 2-796697-3 | — | |
| 24 | 120.0 [4.724] | 2-1546212-4 | 2-282822-4 | 2-796697-4 | — | |
| 25 | 125.0 [4.921] | 2-1546212-5 | 2-282822-5 | 2-796697-5 | — | |

Note: BUCHANAN Terminal Block Series B72N4VxxT has been replaced by x-796697-x (blue).

*Wave solder process capable to 265°C [509°F] for 10 seconds. Dimensions may vary from what is shown for High Temperature Parts. Please check Customer Drawing.

Straight, Closed End Headers, 5.0 mm Centerline Color – See chart.

UL Rating – 300 V, 15 A

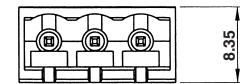
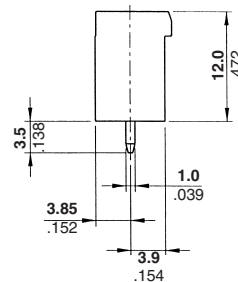
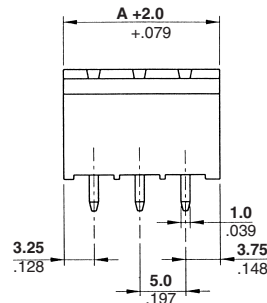
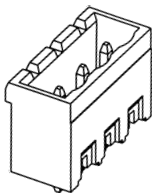

Recommended PC Board Layout

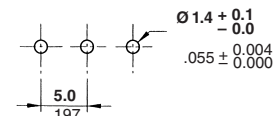

| No. of Pos. | Dim. A | Part Numbers | | | | |
|-------------|--------------|--------------|------------|------------|------------|-------------|
| | | Gray | Green | Blue | Black* | |
| 2 | 10.0 [0.394] | 1546211-2 | 796642-2 | 796699-2 | 796643-2 | 1776146-2 |
| 3 | 15.0 [0.591] | 1546211-3 | 796642-3 | 796699-3 | 796643-3 | 1776146-3 |
| 4 | 20.0 [0.787] | 1546211-4 | 796642-4 | 796699-4 | 796643-4 | 1776146-4 |
| 5 | 25.0 [0.984] | 1546211-5 | 796642-5 | 796699-5 | 796643-5 | 1776146-5 |
| 6 | 30.0 [1.181] | 1546211-6 | 796642-6 | 796699-6 | 796643-6 | 1776146-6 |
| 7 | 35.0 [1.378] | 1546211-7 | 796642-7 | 796699-7 | 796643-7 | 1776146-7 |
| 8 | 40.0 [1.575] | 1546211-8 | 796642-8 | 796699-8 | 796643-8 | 1776146-8 |
| 9 | 45.0 [1.772] | 1546211-9 | 796642-9 | 796699-9 | 796643-9 | 1776146-9 |
| 10 | 50.0 [1.968] | 1-1546211-0 | 1-796642-0 | 1-796699-0 | 1-796643-0 | 1-1776146-0 |
| 11 | 55.0 [2.165] | 1-1546211-1 | 1-796642-1 | 1-796699-1 | 1-796643-1 | 1-1776146-1 |
| 12 | 60.0 [2.362] | 1-1546211-2 | 1-796642-2 | 1-796699-2 | 1-796643-2 | 1-1776146-2 |
| 13 | 65.0 [2.559] | 1-1546211-3 | 1-796642-3 | 1-796699-3 | 1-796643-3 | — |

| No. of Positions | Dim. A | Part Numbers | | | | |
|------------------|---------------|--------------|------------|------------|------------|--|
| | | Gray | Green | Blue | Black | |
| 14 | 70.0 [2.756] | 1-1546211-4 | 1-796642-4 | 1-796699-4 | 1-796643-4 | |
| 15 | 75.0 [2.953] | 1-1546211-5 | 1-796642-5 | 1-796699-5 | 1-796643-5 | |
| 16 | 80.0 [3.150] | 1-1546211-6 | 1-796642-6 | 1-796699-6 | 1-796643-6 | |
| 17 | 85.0 [3.346] | 1-1546211-7 | 1-796642-7 | 1-796699-7 | 1-796643-7 | |
| 18 | 90.0 [3.543] | 1-1546211-8 | 1-796642-8 | 1-796699-8 | 1-796643-8 | |
| 19 | 95.0 [3.740] | 1-1546211-9 | 1-796642-9 | 1-796699-9 | 1-796643-9 | |
| 20 | 100.0 [3.937] | 2-1546211-0 | 2-796642-0 | 2-796699-0 | 2-796643-0 | |
| 21 | 105.0 [4.134] | 2-1546211-1 | 2-796642-1 | 2-796699-1 | 2-796643-1 | |
| 22 | 110.0 [4.331] | 2-1546211-2 | 2-796642-2 | 2-796699-2 | 2-796643-2 | |
| 23 | 115.0 [4.528] | 2-1546211-3 | 2-796642-3 | 2-796699-3 | 2-796643-3 | |
| 24 | 120.0 [4.724] | 2-1546211-4 | 2-796642-4 | 2-796699-4 | 2-796643-4 | |
| 25 | 125.0 [4.921] | 2-1546211-5 | 2-796642-5 | 2-796699-5 | 2-796643-5 | |

Note: BUCHANAN Terminal Block Series B73N4VxxT has been replaced with 796699-xx (blue) and 796643-xx (black).

RDI Terminal Block Series 2EHDV-xx has been replaced with 796642-xx (green) and 796643-xx (black).

*Wave solder process capable to 265°C [509°F] for 10 seconds. Dimensions may vary from what is shown for High Temperature Parts. Please check Customer Drawing.



Note: All part numbers are RoHS Compliant.

Two-Piece Terminal Block Connectors (Continued)

Straight, Open End Stacking Headers, 5.08 mm Centerline Color – See chart. UL Rating – 300 V, 15 A

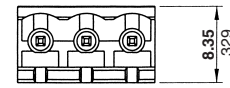
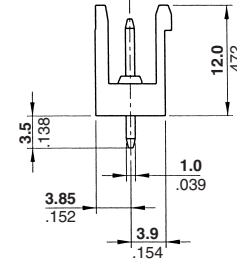
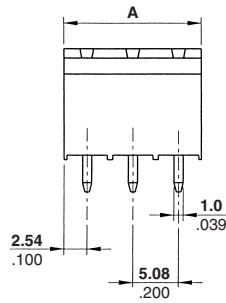
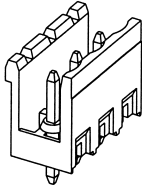

Recommended PC Board Layout

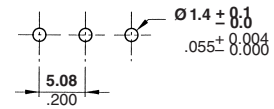

| No. of Positions | Dim. A | Part Numbers | | |
|------------------|--------------|--------------|-------------|-----------|
| | | Green | Gray | Black* |
| 2 | 10.16 [0.40] | 282825-2 | 1546213-2 | 1776139-2 |
| 3 | 15.24 [0.60] | 282825-3 | 1546213-3 | 1776139-3 |
| 4 | 20.32 [0.80] | 282825-4 | 1546213-4 | 1776139-4 |
| 5 | 25.40 [1.00] | 282825-5 | 1546213-5 | 1776139-5 |
| 6 | 30.48 [1.20] | 282825-6 | 1546213-6 | 1776139-6 |
| 7 | 35.56 [1.40] | 282825-7 | 1546213-7 | 1776139-7 |
| 8 | 40.64 [1.60] | 282825-8 | 1546213-8 | 1776139-8 |
| 9 | 45.72 [1.80] | 282825-9 | 1546213-9 | — |
| 10 | 50.80 [2.00] | 1-282825-0 | 1-1546213-0 | — |
| 11 | 55.88 [2.20] | 1-282825-1 | 1-1546213-1 | — |
| 12 | 60.96 [2.40] | 1-282825-2 | 1-1546213-2 | — |
| 13 | 66.04 [2.60] | 1-282825-3 | 1-1546213-3 | — |

| No. of Positions | Dim. A | Part Numbers | | |
|------------------|---------------|--------------|-------------|--------|
| | | Green | Gray | Black* |
| 14 | 71.12 [2.80] | 1-282825-4 | 1-1546213-4 | — |
| 15 | 76.20 [3.00] | 1-282825-5 | 1-1546213-5 | — |
| 16 | 81.28 [3.20] | 1-282825-6 | 1-1546213-6 | — |
| 17 | 86.36 [3.40] | 1-282825-7 | 1-1546213-7 | — |
| 18 | 91.44 [3.60] | 1-282825-8 | 1-1546213-8 | — |
| 19 | 96.52 [3.80] | 1-282825-9 | 1-1546213-9 | — |
| 20 | 101.60 [4.00] | 2-282825-0 | 2-1546213-0 | — |
| 21 | 106.68 [4.20] | 2-282825-1 | 2-1546213-1 | — |
| 22 | 111.76 [4.40] | 2-282825-2 | 2-1546213-2 | — |
| 23 | 116.84 [4.60] | 2-282825-3 | 2-1546213-3 | — |
| 24 | 121.92 [4.80] | 2-282825-4 | 2-1546213-4 | — |
| 25 | 127.00 [5.00] | 2-282825-5 | 2-1546213-5 | — |

*Wave solder process capable to 265°C [509°F] for 10 seconds. Dimensions may vary from what is shown for High Temperature Parts. Please check Customer Drawing.

Straight, Closed End Headers, 5.08 mm Centerline Color – See chart. UL Rating – 300 V, 15 A

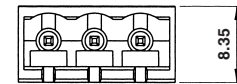
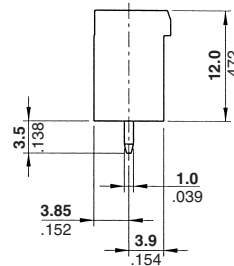
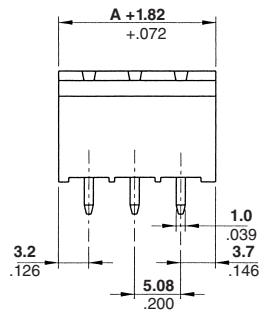
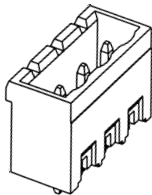

Recommended PC Board Layout

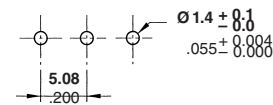

| No. of Pos. | Dim. A | Part Numbers | | | |
|-------------|--------------|--------------|------------|------------|-----------|
| | | Gray | Green | Black | Black* |
| 2 | 10.16 [0.40] | 1546111-2 | 796636-2 | 796637-2 | 1776147-2 |
| 3 | 15.24 [0.60] | 1546111-3 | 796636-3 | 796637-3 | 1776147-3 |
| 4 | 20.32 [0.80] | 1546111-4 | 796636-4 | 796637-4 | 1776147-4 |
| 5 | 25.40 [1.00] | 1546111-5 | 796636-5 | 796637-5 | 1776147-5 |
| 6 | 30.48 [1.20] | 1546111-6 | 796636-6 | 796637-6 | 1776147-6 |
| 7 | 35.56 [1.40] | 1546111-7 | 796636-7 | 796637-7 | 1776147-7 |
| 8 | 40.64 [1.60] | 1546111-8 | 796636-8 | 796637-8 | 1776147-8 |
| 9 | 45.72 [1.80] | 1546111-9 | 796636-9 | 796637-9 | — |
| 10 | 50.80 [2.00] | 1-1546111-0 | 1-796636-0 | 1-796637-0 | — |
| 11 | 55.88 [2.20] | 1-1546111-1 | 1-796636-1 | 1-796637-1 | — |
| 12 | 60.96 [2.40] | 1-1546111-2 | 1-796636-2 | 1-796637-2 | — |
| 13 | 66.04 [2.60] | 1-1546111-3 | 1-796636-3 | 1-796637-3 | — |

| No. of Positions | Dim. A | Part Numbers | | |
|------------------|---------------|--------------|------------|------------|
| | | Gray | Green | Black |
| 14 | 71.12 [2.80] | 1-1546111-4 | 1-796636-4 | 1-796637-4 |
| 15 | 76.20 [3.00] | 1-1546111-5 | 1-796636-5 | 1-796637-5 |
| 16 | 81.28 [3.20] | 1-1546111-6 | 1-796636-6 | 1-796637-6 |
| 17 | 86.36 [3.40] | 1-1546111-7 | 1-796636-7 | 1-796637-7 |
| 18 | 91.44 [3.60] | 1-1546111-8 | 1-796636-8 | 1-796637-8 |
| 19 | 96.52 [3.80] | 1-1546111-9 | 1-796636-9 | 1-796637-9 |
| 20 | 101.60 [4.00] | 2-1546111-0 | 2-796636-0 | 1-796637-0 |
| 21 | 106.68 [4.20] | 2-1546111-1 | 2-796636-1 | 2-796637-1 |
| 22 | 111.76 [4.40] | 2-1546111-2 | 2-796636-2 | 2-796637-2 |
| 23 | 116.84 [4.60] | 2-1546111-3 | 2-796636-3 | 2-796637-3 |
| 24 | 121.92 [4.80] | 2-1546111-4 | 2-796636-4 | 2-796637-4 |
| 25 | 127.00 [5.00] | 2-1546111-5 | 2-796636-5 | 2-796637-5 |

Note: BUCHANAN Terminal Block Series B2EHDVxx has been superceded/replaced with 796636-xx (green) and 796637-xx (black).

*Wave solder process capable to 265°C [509°F] for 10 seconds. Dimensions may vary from what is shown for High Temperature Parts. Please check Customer Drawing.

Note: All part numbers are RoHS Compliant.

Two-Piece Terminal Block Connectors (Continued)

**Straight, Open End Headers, 7.5 mm Centerline
UL Rating – 300 V, 15 A**

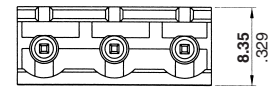
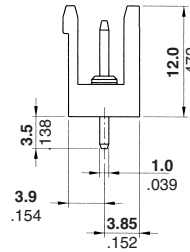
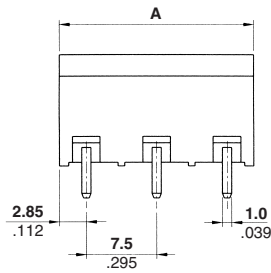
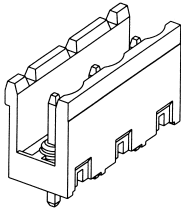

Recommended PC Board Layout

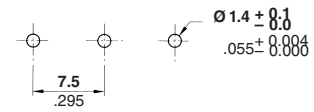

| No. of Positions | Dim. A | Part Numbers | |
|------------------|--------------|--------------|-----------|
| | | Green | Black* |
| 2 | 13.2 [0.520] | 282963-2 | 1776149-2 |
| 3 | 20.7 [0.815] | 282963-3 | 1776149-3 |
| 4 | 28.2 [1.110] | 282963-4 | 1776149-4 |
| 5 | 35.7 [1.406] | 282963-5 | 1776149-5 |
| 6 | 43.2 [1.701] | 282963-6 | 1776149-6 |
| 7 | 50.7 [1.996] | 282963-7 | 1776149-7 |

| No. of Positions | Dim. A | Part Numbers | |
|------------------|--------------|--------------|-------------|
| | | Green | Black* |
| 8 | 58.2 [2.291] | 282963-8 | 1776149-8 |
| 9 | 65.7 [2.587] | 282963-9 | 1776149-9 |
| 10 | 73.2 [2.882] | 1-282963-0 | 1-1776149-0 |
| 11 | 80.7 [3.177] | 1-282963-1 | 1-1776149-1 |
| 12 | 88.2 [3.472] | 1-282963-2 | 1-1776149-2 |

*Wave solder process capable to 265°C [509°F] for 10 seconds. Dimensions may vary from what is shown for High Temperature Parts. Please check Customer Drawing.

**Straight, Closed End Headers, 7.5 mm Centerline
UL Rating – 300 V, 15 A**

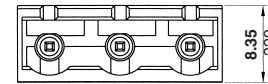
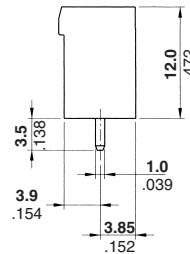
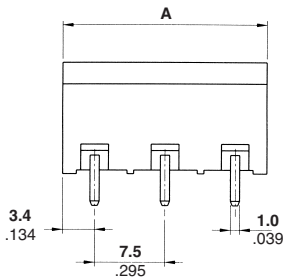
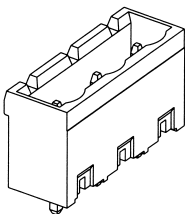

Recommended PC Board Layout

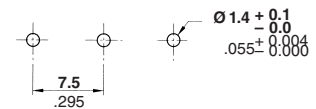

| No. of Positions | Dim. A | Part Numbers | |
|------------------|--------------|--------------|-----------|
| | | Green | Black* |
| 2 | 14.3 [0.563] | 282964-2 | 1776153-2 |
| 3 | 21.8 [0.858] | 282964-3 | 1776153-3 |
| 4 | 29.3 [1.154] | 282964-4 | 1776153-4 |
| 5 | 36.8 [1.449] | 282964-5 | 1776153-5 |
| 6 | 44.3 [1.744] | 282964-6 | 1776153-6 |
| 7 | 51.8 [2.039] | 282964-7 | 1776153-7 |

| No. of Positions | Dim. A | Part Numbers | |
|------------------|--------------|--------------|-------------|
| | | Green | Black* |
| 8 | 59.3 [2.335] | 282964-8 | 1776153-8 |
| 9 | 66.8 [2.630] | 282964-9 | 1776153-9 |
| 10 | 74.3 [2.925] | 1-282964-0 | 1-1776153-0 |
| 11 | 81.8 [3.220] | 1-282964-1 | 1-1776153-1 |
| 12 | 89.3 [3.516] | 1-282964-2 | 1-1776153-2 |

*Wave solder process capable to 265°C [509°F] for 10 seconds. Dimensions may vary from what is shown for High Temperature Parts. Please check Customer Drawing.



Note: All part numbers are RoHS Compliant.

Two-Piece Terminal Block Connectors (Continued)

Straight, Open End Headers, 7.62 mm Centerline
UL Rating – 300 V, 15 A

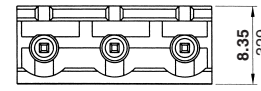
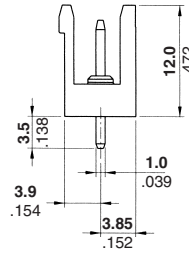
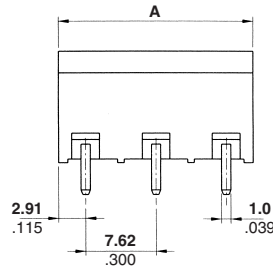
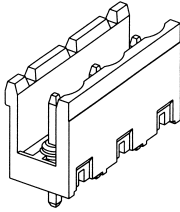

Recommended PC Board Layout

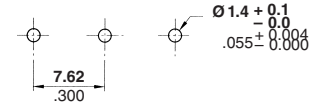

| No. of Positions | Dim. A | Part Numbers | |
|------------------|---------------|--------------|-----------|
| | | Green | Black* |
| 2 | 13.44 [0.529] | 282967-2 | 1776150-2 |
| 3 | 21.06 [0.829] | 282967-3 | 1776150-3 |
| 4 | 28.68 [1.129] | 282967-4 | 1776150-4 |
| 5 | 36.30 [1.429] | 282967-5 | 1776150-5 |
| 6 | 43.92 [1.729] | 282967-6 | 1776150-6 |
| 7 | 51.54 [2.029] | 282967-7 | 1776150-7 |

| No. of Positions | Dim. A | Part Numbers | |
|------------------|---------------|--------------|-------------|
| | | Green | Black* |
| 8 | 59.16 [2.329] | 282967-8 | 1776150-8 |
| 9 | 66.78 [2.629] | 282967-9 | 1776150-9 |
| 10 | 74.40 [2.929] | 1-282967-0 | 1-1776150-0 |
| 11 | 82.02 [3.229] | 1-282967-1 | 1-1776150-1 |
| 12 | 89.64 [3.529] | 1-282967-2 | 1-1776150-2 |

*Wave solder process capable to 265°C [509°F] for 10 seconds. Dimensions may vary from what is shown for High Temperature Parts. Please check Customer Drawing.

Straight, Closed End Headers, 7.62 mm Centerline
UL Rating – 300 V, 15 A

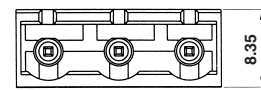
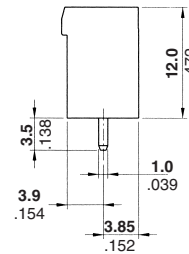
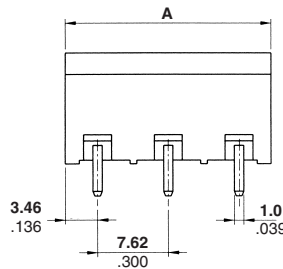
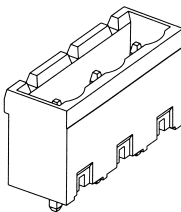

Recommended PC Board Layout

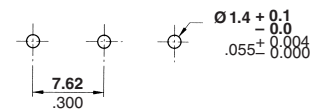

| No. of Positions | Dim. A | Part Numbers | |
|------------------|---------------|--------------|-----------|
| | | Green | Black* |
| 2 | 14.54 [0.572] | 796980-2 | 1776154-2 |
| 3 | 22.16 [0.872] | 796980-3 | 1776154-3 |
| 4 | 29.78 [1.172] | 796980-4 | 1776154-4 |
| 5 | 37.40 [1.472] | 796980-5 | 1776154-5 |
| 6 | 45.02 [1.772] | 796980-6 | 1776154-6 |
| 7 | 52.64 [2.072] | 796980-7 | 1776154-7 |

| No. of Positions | Dim. A | Part Numbers | |
|------------------|---------------|--------------|-------------|
| | | Green | Black* |
| 8 | 60.26 [2.372] | 796980-8 | 1776154-8 |
| 9 | 67.88 [2.672] | 796980-9 | 1776154-9 |
| 10 | 75.50 [2.972] | 1-796980-0 | 1-1776154-0 |
| 11 | 83.12 [3.272] | 1-796980-1 | 1-1776154-1 |
| 12 | 90.74 [3.572] | 1-796980-2 | 1-1776154-2 |

*Wave solder process capable to 265°C [509°F] for 10 seconds. Dimensions may vary from what is shown for High Temperature Parts. Please check Customer Drawing.

Note: All part numbers are RoHS Compliant.

Two-Piece Terminal Block Connectors (Continued)

Straight, Open End Headers, 10.0 mm Centerline
UL Rating – 600 V, 24 A

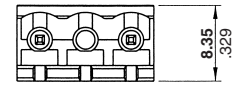
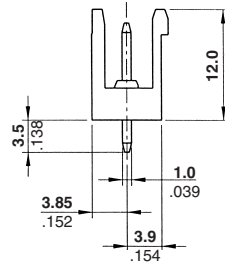
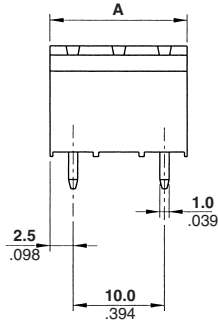
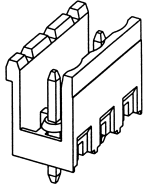

Recommended PC Board Layout

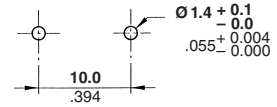

| No. of Positions | Dim. A | Part Numbers | |
|------------------|--------------|--------------|-----------|
| | | Green | Black* |
| 2 | 15.0 [0.591] | 282827-2 | 1776156-2 |
| 3 | 25.0 [0.984] | 282827-3 | 1776156-3 |
| 4 | 35.0 [1.378] | 282827-4 | 1776156-4 |
| 5 | 45.0 [1.772] | 282827-5 | — |
| 6 | 55.0 [2.165] | 282827-6 | — |
| 7 | 65.0 [2.559] | 282827-7 | — |

| No. of Positions | Dim. A | Part Numbers | |
|------------------|---------------|--------------|--------|
| | | Green | Black* |
| 8 | 75.0 [2.953] | 282827-8 | — |
| 9 | 85.0 [3.346] | 282827-9 | — |
| 10 | 95.0 [3.740] | 1-282827-0 | — |
| 11 | 105.0 [4.134] | 1-282827-1 | — |
| 12 | 115.0 [4.528] | 1-282827-2 | — |
| 13 | 125.0 [4.921] | 1-282827-3 | — |

*Wave solder process capable to 265°C [509°F] for 10 seconds. Dimensions may vary from what is shown for High Temperature Parts. Please check Customer Drawing.

Straight, Closed End Headers, 10.0 mm Centerline
UL Rating – 600 V, 24 A

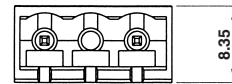
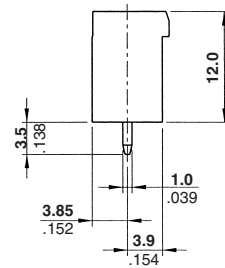
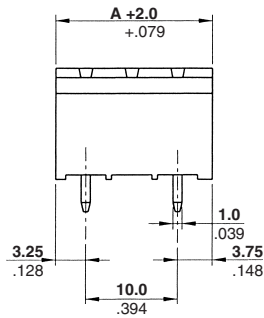
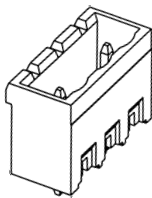

Recommended PC Board Layout

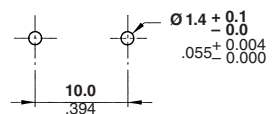

| No. of Positions | Dim. A | Part Numbers | |
|------------------|--------------|--------------|-----------|
| | | Green | Black* |
| 2 | 15.0 [0.591] | 282826-2 | 1776160-2 |
| 3 | 25.0 [0.984] | 282826-3 | 1776160-3 |
| 4 | 35.0 [1.378] | 282826-4 | 1776160-4 |
| 5 | 45.0 [1.772] | 282826-5 | — |
| 6 | 55.0 [2.165] | 282826-6 | — |
| 7 | 65.0 [2.559] | 282826-7 | — |

| No. of Positions | Dim. A | Part Numbers | |
|------------------|---------------|--------------|--------|
| | | Green | Black* |
| 8 | 75.0 [2.953] | 282826-8 | — |
| 9 | 85.0 [3.346] | 282826-9 | — |
| 10 | 95.0 [3.740] | 1-282826-0 | — |
| 11 | 105.0 [4.134] | 1-282826-1 | — |
| 12 | 115.0 [4.528] | 1-282826-2 | — |
| 13 | 125.0 [4.921] | 1-282826-3 | — |

*Wave solder process capable to 265°C [509°F] for 10 seconds. Dimensions may vary from what is shown for High Temperature Parts. Please check Customer Drawing.



Note: All part numbers are RoHS Compliant.

Two-Piece Terminal Block Connectors (Continued)

Straight, Open End Headers, 10.16 mm Centerline UL Rating – 600 V, 15 A

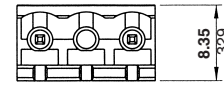
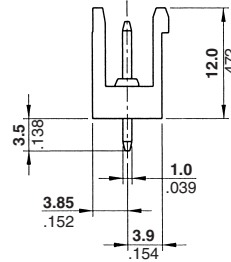
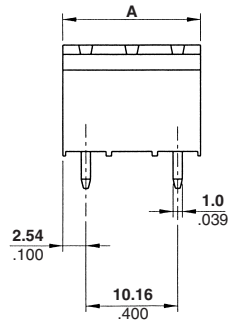
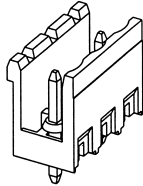

Recommended PC Board Layout

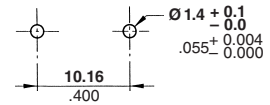

| No. of Positions | Dim. A | Part Numbers | |
|------------------|--------------|--------------|-----------|
| | | Green | Black* |
| 2 | 15.24 [0.60] | 282828-2 | 1776161-2 |
| 3 | 25.40 [1.00] | 282828-3 | 1776161-3 |
| 4 | 35.56 [1.40] | 282828-4 | 1776161-4 |

*Wave solder process capable to 265°C [509°F] for 10 seconds
Dimensions may vary from what is shown for High Temperature Parts.
Please check Customer Drawing.

Straight, Closed End Headers, 10.16 mm Centerline UL Rating – 600 V, 15 A

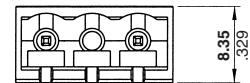
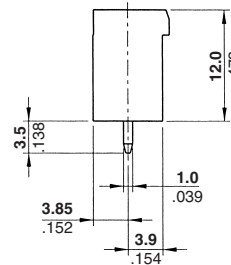
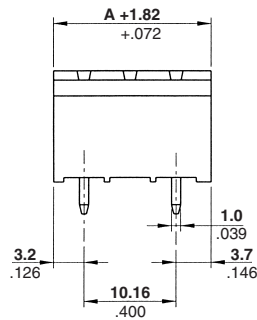
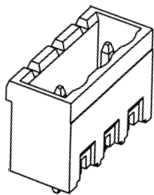

Recommended PC Board Layout

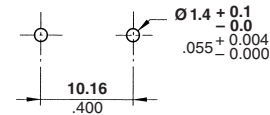

| No. of Positions | Dim. A | Part Numbers | |
|------------------|--------------|--------------|-----------|
| | | Green | Black* |
| 2 | 15.24 [0.60] | 282828-2 | 1776161-2 |
| 3 | 25.40 [1.00] | 282828-3 | 1776161-3 |
| 4 | 35.56 [1.40] | 282828-4 | 1776161-4 |
| 5 | 45.72 [1.80] | 282828-5 | — |
| 6 | 55.88 [2.20] | 282828-6 | — |
| 7 | 66.04 [2.60] | 282828-7 | — |

| No. of Positions | Dim. A | Part Numbers | |
|------------------|---------------|--------------|--------|
| | | Green | Black* |
| 8 | 76.20 [3.00] | 282828-8 | — |
| 9 | 86.36 [3.40] | 282828-9 | — |
| 10 | 96.52 [3.80] | 1-282828-0 | — |
| 11 | 106.68 [4.20] | 1-282828-1 | — |
| 12 | 116.84 [4.60] | 1-282828-2 | — |
| 13 | 127.00 [5.00] | 1-282828-3 | — |

*Wave solder process capable to 265°C [509°F] for 10 seconds. Dimensions may vary from what is shown for High Temperature Parts. Please check Customer Drawing.

Two-Piece Terminal Block Connectors (Continued)

Straight, Open End Stacking Headers w/Interlock, 5.0 mm Centerline
UL Rating – 300 V, 15 A

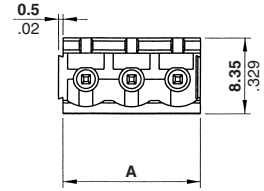
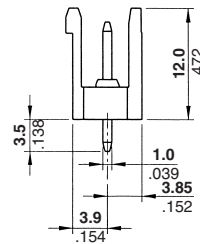
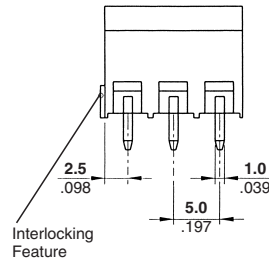
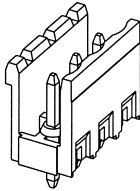

Recommended PC Board Layout

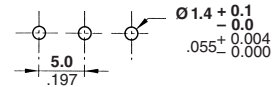

| No. of Positions | Dim. A | Part Numbers | |
|------------------|-------------|--------------|-----------|
| | | Green | Black* |
| 2 | 10.0 [.394] | 282821-2 | 1776142-2 |
| 3 | 15.0 [.591] | 282821-3 | 1776142-3 |
| 4 | 20.0 [.787] | 282821-4 | 1776142-4 |

*Wave solder process capable to 265°C [509°F] for 10 seconds
Dimensions may vary from what is shown for High Temperature Parts.
Please check Customer Drawing.

Straight, Open End Stacking Headers w/Interlock, 5.08 mm Centerline
UL Rating – 300 V, 15 A

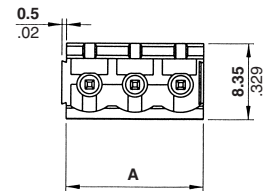
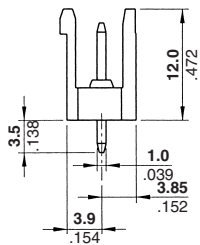
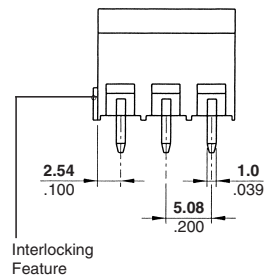
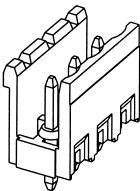

Recommended PC Board Layout

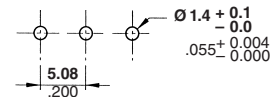

| No. of Positions | Dim. A | Part Numbers | |
|------------------|--------------|--------------|-----------|
| | | Green | Black* |
| 2 | 10.16 [.400] | 282824-2 | 1776143-2 |
| 3 | 15.24 [.600] | 282824-3 | 1776143-3 |
| 4 | 20.32 [.800] | 282824-4 | 1776143-4 |

*Wave solder process capable to 265°C [509°F] for 10 seconds
Dimensions may vary from what is shown for High Temperature Parts.
Please check Customer Drawing.

Note: All part numbers are RoHS Compliant.

Two-Piece Terminal Block Connectors (Continued)

Right-Angle, Closed End Headers, 3.5 mm Centerline Color – See chart. UL Rating – 300 V, 11 A

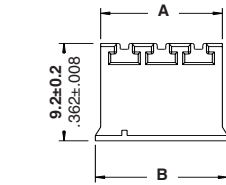
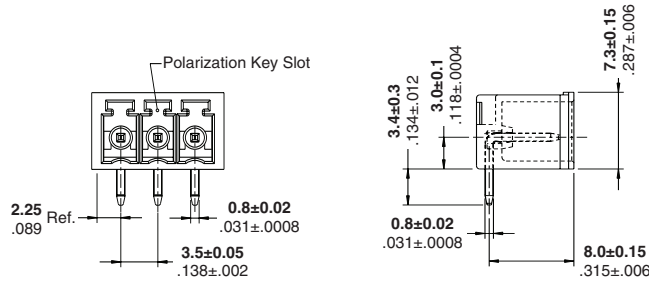
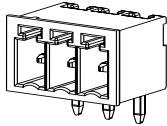

Recommended PC Board Layout

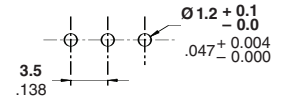

| Number of Positions | Dimensions | | Part Numbers | | |
|---------------------|--------------|--------------|--------------|------------|-----------|
| | A | B | Green | Blue | Black* |
| 2 | 8.0 [0.315] | 9.0 [0.354] | 284512-2 | 796695-2 | 1776134-2 |
| 3 | 11.5 [0.453] | 12.5 [0.492] | 284512-3 | 796695-3 | 1776134-3 |
| 4 | 15.0 [0.590] | 16.0 [0.630] | 284512-4 | 796695-4 | 1776134-4 |
| 5 | 18.5 [0.728] | 19.5 [0.768] | 284512-5 | 796695-5 | 1776134-5 |
| 6 | 22.0 [0.866] | 23.0 [0.906] | 284512-6 | 796695-6 | 1776134-6 |
| 7 | 25.5 [1.004] | 26.5 [1.043] | 284512-7 | 796695-7 | 1776134-7 |
| 8 | 29.0 [1.142] | 30.0 [1.181] | 284512-8 | 796695-8 | 1776134-8 |
| 9 | 32.5 [1.280] | 33.5 [1.319] | 284512-9 | 796695-9 | — |
| 10 | 36.0 [1.417] | 37.0 [1.457] | 1-284512-0 | 1-796695-0 | — |
| 11 | 39.5 [1.555] | 40.5 [1.594] | 1-284512-1 | 1-796695-1 | — |
| 12 | 43.0 [1.693] | 44.0 [1.732] | 1-284512-2 | 1-796695-2 | — |
| 13 | 46.5 [1.831] | 47.5 [1.870] | 1-284512-3 | 1-796695-3 | — |

| Number of Positions | Dimensions | | Part Numbers | | |
|---------------------|--------------|--------------|--------------|------------|--------|
| | A | B | Green | Blue | Black* |
| 14 | 50.0 [1.968] | 51.0 [2.008] | 1-284512-4 | 1-796695-4 | — |
| 15 | 53.5 [2.106] | 54.5 [2.146] | 1-284512-5 | 1-796695-5 | — |
| 16 | 57.0 [2.244] | 58.0 [2.283] | 1-284512-6 | 1-796695-6 | — |
| 17 | 60.5 [2.382] | 61.5 [2.421] | 1-284512-7 | 1-796695-7 | — |
| 18 | 64.0 [2.520] | 65.0 [2.559] | 1-284512-8 | 1-796695-8 | — |
| 19 | 67.5 [2.657] | 68.5 [2.697] | 1-284512-9 | 1-796695-9 | — |
| 20 | 71.0 [2.795] | 72.0 [2.835] | 2-284512-0 | 2-796695-0 | — |
| 21 | 74.5 [2.933] | 75.5 [2.972] | 2-284512-1 | 2-796695-1 | — |
| 22 | 78.0 [3.071] | 79.0 [3.110] | 2-284512-2 | 2-796695-2 | — |
| 23 | 81.5 [3.209] | 82.5 [3.248] | 2-284512-3 | 2-796695-3 | — |
| 24 | 85.0 [3.346] | 86.0 [3.386] | 2-284512-4 | 2-796695-4 | — |
| 25 | 88.5 [3.484] | 89.5 [3.524] | 2-284512-5 | 2-796695-5 | — |

Note: BUCHANAN Terminal Block Series B73N3HxxT has been replaced with Part Number 796695-xx (blue).

*Wave solder process capable to 265°C [509°F] for 10 seconds. Dimensions may vary from what is shown for High Temperature Parts. Please check Customer Drawing.

Right-Angle, Closed End Headers, 3.81 mm Centerline UL Rating – 300 V, 11 A

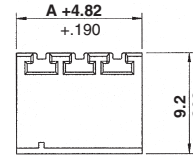
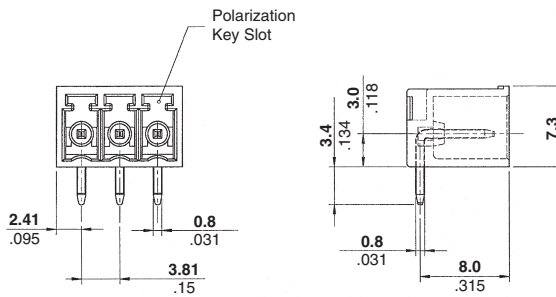
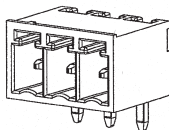

Recommended PC Board Layout

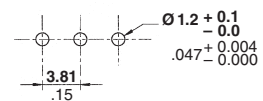

| No. of Positions | Dim. A | Part Numbers | |
|------------------|--------------|--------------|-------------|
| | | Green | Black* |
| 2 | 3.81 [0.15] | 284513-2 | 1776135-2 |
| 3 | 7.62 [0.30] | 284513-3 | 1776135-3 |
| 4 | 11.43 [0.45] | 284513-4 | 1776135-4 |
| 5 | 15.24 [0.60] | 284513-5 | 1776135-5 |
| 6 | 19.05 [0.75] | 284513-6 | 1776135-6 |
| 7 | 22.86 [0.90] | 284513-7 | 1776135-7 |
| 8 | 26.67 [1.05] | 284513-8 | 1776135-8 |
| 9 | 30.48 [1.20] | 284513-9 | 1776135-9 |
| 10 | 34.29 [1.35] | 1-284513-0 | 1-1776135-0 |
| 11 | 38.10 [1.50] | 1-284513-1 | 1-1776135-1 |
| 12 | 41.91 [1.65] | 1-284513-2 | 1-1776135-2 |
| 13 | 45.72 [1.80] | 1-284513-3 | — |

| No. of Positions | Dim. A | Part Numbers | |
|------------------|--------------|--------------|--------|
| | | Green | Black* |
| 14 | 49.53 [1.95] | 1-284513-4 | — |
| 15 | 53.34 [2.10] | 1-284513-5 | — |
| 16 | 57.15 [2.25] | 1-284513-6 | — |
| 17 | 60.96 [2.40] | 1-284513-7 | — |
| 18 | 64.77 [2.55] | 1-284513-8 | — |
| 19 | 68.58 [2.70] | 1-284513-9 | — |
| 20 | 72.39 [2.85] | 2-284513-0 | — |
| 21 | 76.20 [3.00] | 2-284513-1 | — |
| 22 | 80.01 [3.15] | 2-284513-2 | — |
| 23 | 83.82 [3.30] | 2-284513-3 | — |
| 24 | 87.63 [3.45] | 2-284513-4 | — |
| 25 | 91.44 [3.60] | 2-284513-5 | — |

*Wave solder process capable to 265°C [509°F] for 10 seconds. Dimensions may vary from what is shown for High Temperature Parts. Please check Customer Drawing.

Note: All part numbers are RoHS Compliant.

Two-Piece Terminal Block Connectors (Continued)

**Right-Angle,
Open End Stacking Headers,
5.0 mm Centerline
Color – See chart.**

UL Rating – 300 V, 15 A

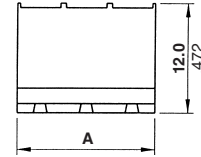
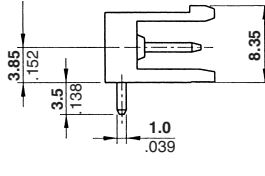
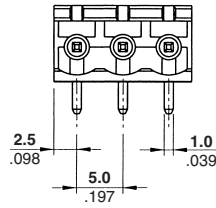
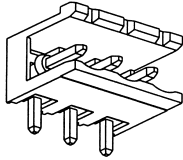

Recommended PC Board Layout

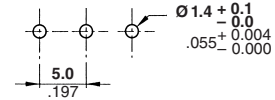

| No. of Pos. | Dim. A | Part Numbers | | | | |
|-------------|---------------|--------------|------------|------------|-------------|-------------|
| | | Gray | Green | Blue | Black | Black* |
| 2 | 10.0 [0.394] | 1546210-2 | 282812-2 | 796698-2 | 1546179-2 | 1776140-2 |
| 3 | 15.0 [0.591] | 1546210-3 | 282812-3 | 796698-3 | 1546179-3 | 1776140-3 |
| 4 | 20.0 [0.787] | 1546210-4 | 282812-4 | 796698-4 | 1546179-4 | 1776140-4 |
| 5 | 25.0 [0.984] | 1546210-5 | 282812-5 | 796698-5 | 1546179-5 | 1776140-5 |
| 6 | 30.0 [1.181] | 1546210-6 | 282812-6 | 796698-6 | 1546179-6 | 1776140-6 |
| 7 | 35.0 [1.378] | 1546210-7 | 282812-7 | 796698-7 | 1546179-7 | 1776140-7 |
| 8 | 40.0 [1.575] | 1546210-8 | 282812-8 | 796698-8 | 1546179-8 | 1776140-8 |
| 9 | 45.0 [1.772] | 1546210-9 | 282812-9 | 796698-9 | 1546179-9 | 1776140-9 |
| 10 | 50.0 [1.968] | 1-1546210-0 | 1-282812-0 | 1-796698-0 | 1-1546179-0 | 1-1776140-0 |
| 11 | 55.0 [2.165] | 1-1546210-1 | 1-282812-1 | 1-796698-1 | 1-1546179-1 | 1-1776140-1 |
| 12 | 60.0 [2.362] | 1-1546210-2 | 1-282812-2 | 1-796698-2 | 1-1546179-2 | 1-1776140-2 |
| 13 | 65.0 [2.559] | 1-1546210-3 | 1-282812-3 | 1-796698-3 | 1-1546179-3 | — |
| 14 | 70.0 [2.756] | 1-1546210-4 | 1-282812-4 | 1-796698-4 | 1-1546179-4 | — |
| 15 | 75.0 [2.953] | 1-1546210-5 | 1-282812-5 | 1-796698-5 | 1-1546179-5 | — |
| 16 | 80.0 [3.150] | 1-1546210-6 | 1-282812-6 | 1-796698-6 | 1-1546179-6 | — |
| 17 | 85.0 [3.346] | 1-1546210-7 | 1-282812-7 | 1-796698-7 | 1-1546179-7 | — |
| 18 | 90.0 [3.543] | 1-1546210-8 | 1-282812-8 | 1-796698-8 | 1-1546179-8 | — |
| 19 | 95.0 [3.740] | 1-1546210-9 | 1-282812-9 | 1-796698-9 | 1-1546179-9 | — |
| 20 | 100.0 [3.937] | 2-1546210-0 | 2-282812-0 | 2-796698-0 | 2-1546179-0 | — |
| 21 | 105.0 [4.134] | 2-1546210-1 | 2-282812-1 | 2-796698-1 | 2-1546179-1 | — |
| 22 | 110.0 [4.331] | 2-1546210-2 | 2-282812-2 | 2-796698-2 | 2-1546179-2 | — |
| 23 | 115.0 [4.528] | 2-1546210-3 | 2-282812-3 | 2-796698-3 | 2-1546179-3 | — |
| 24 | 120.0 [4.724] | 2-1546210-4 | 2-282812-4 | 2-796698-4 | 2-1546179-4 | — |
| 25 | 125.0 [4.921] | 2-1546210-5 | 2-282812-5 | 2-796698-5 | 2-1546179-5 | — |

Note: BUCHANAN Terminal Block Series B72N4HxxT has been replaced with 796698-xx (blue).
*Wave solder process capable to 265°C [509°F] for 10 seconds. Dimensions may vary from what is shown for High Temperature Parts. Please check Customer Drawing.



Note: All part numbers are RoHS Compliant.

Two-Piece Terminal Block Connectors (Continued)

**Right-Angle,
Closed End Headers,
5.0 mm Centerline
Color – See chart.
UL Rating – 300 V, 15 A**

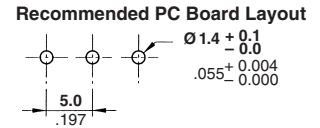
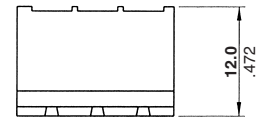
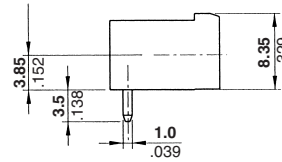
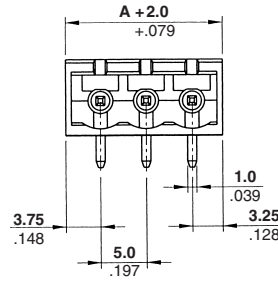
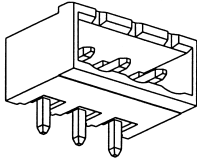

| No. of Pos. | Dim. A | Part Numbers | | | | |
|-------------|---------------|--------------|------------|------------|------------|-----------|
| | | Gray | Green | Blue | Black | Black* |
| 2 | 10.0 [0.394] | 1546209-2 | 796644-2 | 796700-2 | 796645-2 | 1776148-2 |
| 3 | 15.0 [0.591] | 1546209-3 | 796644-3 | 796700-3 | 796645-3 | 1776148-3 |
| 4 | 20.0 [0.787] | 1546209-4 | 796644-4 | 796700-4 | 796645-4 | 1776148-4 |
| 5 | 25.0 [0.984] | 1546209-5 | 796644-5 | 796700-5 | 796645-5 | 1776148-5 |
| 6 | 30.0 [1.181] | 1546209-6 | 796644-6 | 796700-6 | 796645-6 | 1776148-6 |
| 7 | 35.0 [1.378] | 1546209-7 | 796644-7 | 796700-7 | 796645-7 | 1776148-7 |
| 8 | 40.0 [1.575] | 1546209-8 | 796644-8 | 796700-8 | 796645-8 | 1776148-8 |
| 9 | 45.0 [1.772] | 1546209-9 | 796644-9 | 796700-9 | 796645-9 | — |
| 10 | 50.0 [1.968] | 1-1546209-0 | 1-796644-0 | 1-796700-0 | 1-796645-0 | — |
| 11 | 55.0 [2.165] | 1-1546209-1 | 1-796644-1 | 1-796700-1 | 1-796645-1 | — |
| 12 | 60.0 [2.362] | 1-1546209-2 | 1-796644-2 | 1-796700-2 | 1-796645-2 | — |
| 13 | 65.0 [2.559] | 1-1546209-3 | 1-796644-3 | 1-796700-3 | 1-796645-3 | — |
| 14 | 70.0 [2.756] | 1-1546209-4 | 1-796644-4 | 1-796700-4 | 1-796645-4 | — |
| 15 | 75.0 [2.953] | 1-1546209-5 | 1-796644-5 | 1-796700-5 | 1-796645-5 | — |
| 16 | 80.0 [3.150] | 1-1546209-6 | 1-796644-6 | 1-796700-6 | 1-796645-6 | — |
| 17 | 85.0 [3.346] | 1-1546209-7 | 1-796644-7 | 1-796700-7 | 1-796645-7 | — |
| 18 | 90.0 [3.543] | 1-1546209-8 | 1-796644-8 | 1-796700-8 | 1-796645-8 | — |
| 19 | 95.0 [3.740] | 1-1546209-9 | 1-796644-9 | 1-796700-9 | 1-796645-9 | — |
| 20 | 100.0 [3.937] | 2-1546209-0 | 2-796644-0 | 2-796700-0 | 2-796645-0 | — |
| 21 | 105.0 [4.134] | 2-1546209-1 | 2-796644-1 | 2-796700-1 | 2-796645-1 | — |
| 22 | 110.0 [4.331] | 2-1546209-2 | 2-796644-2 | 2-796700-2 | 2-796645-2 | — |
| 23 | 115.0 [4.528] | 2-1546209-3 | 2-796644-3 | 2-796700-3 | 2-796645-3 | — |
| 24 | 120.0 [4.724] | 2-1546209-4 | 2-796644-4 | 2-796700-4 | 2-796645-4 | — |
| 25 | 125.0 [4.921] | 2-1546209-5 | 2-796644-5 | 2-796700-5 | 2-796645-5 | — |

Note: RDI Terminal Block Series 2EHDR-xx has been replaced with 796644-xx (green) and 796645-xx (black).
BUCHANAN Terminal Block Series B73N4HxxT has been replaced with 796700-xx (blue) and 796645-xx (black).

*Wave solder process capable to 265°C [509°F] for 10 seconds. Dimensions may vary from what is shown for High Temperature Parts. Please check Customer Drawing.

Note: All part numbers are RoHS Compliant.

Two-Piece Terminal Block Connectors (Continued)

Right-Angle, Open End Stacking Headers, 5.08 mm Centerline Color – See chart.

UL Rating – 300 V, 15 A

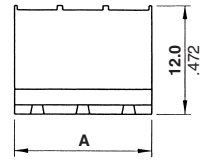
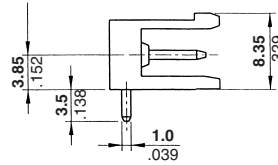
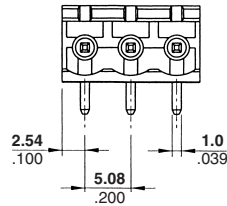
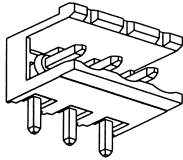

Recommended PC Board Layout

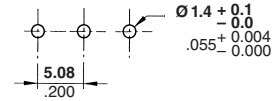

| No. of Positions | Dim. A | Part Numbers | | |
|------------------|--------------|--------------|-------------|-----------|
| | | Green | Gray | Black* |
| 2 | 10.16 [0.40] | 282815-2 | 1546110-2 | 1776141-2 |
| 3 | 15.24 [0.60] | 282815-3 | 1546110-3 | 1776141-3 |
| 4 | 20.32 [0.80] | 282815-4 | 1546110-4 | 1776141-4 |
| 5 | 25.40 [1.00] | 282815-5 | 1546110-5 | 1776141-5 |
| 6 | 30.48 [1.20] | 282815-6 | 1546110-6 | 1776141-6 |
| 7 | 35.56 [1.40] | 282815-7 | 1546110-7 | 1776141-7 |
| 8 | 40.64 [1.60] | 282815-8 | 1546110-8 | 1776141-8 |
| 9 | 45.72 [1.80] | 282815-9 | 1546110-9 | — |
| 10 | 50.80 [2.00] | 1-282815-0 | 1-1546110-0 | — |
| 11 | 55.88 [2.20] | 1-282815-1 | 1-1546110-1 | — |
| 12 | 60.96 [2.40] | 1-282815-2 | 1-1546110-2 | — |
| 13 | 66.04 [2.60] | 1-282815-3 | 1-1546110-3 | — |

| No. of Positions | Dim. A | Part Numbers | | |
|------------------|---------------|--------------|-------------|--------|
| | | Green | Gray | Black* |
| 14 | 71.12 [2.80] | 1-282815-4 | 1-1546110-4 | — |
| 15 | 76.20 [3.00] | 1-282815-5 | 1-1546110-5 | — |
| 16 | 81.28 [3.20] | 1-282815-6 | 1-1546110-6 | — |
| 17 | 86.36 [3.40] | 1-282815-7 | 1-1546110-7 | — |
| 18 | 91.44 [3.60] | 1-282815-8 | 1-1546110-8 | — |
| 19 | 96.52 [3.80] | 1-282815-9 | 1-1546110-9 | — |
| 20 | 101.60 [4.00] | 2-282815-0 | 2-1546110-0 | — |
| 21 | 106.68 [4.20] | 2-282815-1 | 2-1546110-1 | — |
| 22 | 111.76 [4.40] | 2-282815-2 | 2-1546110-2 | — |
| 23 | 116.84 [4.60] | 2-282815-3 | 2-1546110-3 | — |
| 24 | 121.92 [4.80] | 2-282815-4 | 2-1546110-4 | — |
| 25 | 127.00 [5.00] | 2-282815-5 | 2-1546110-5 | — |

*Wave solder process capable to 265°C [509°F] for 10 seconds. Dimensions may vary from what is shown for High Temperature Parts. Please check Customer Drawing.

Right-Angle, Closed End Headers, 5.08 mm Centerline Color – See chart.

UL Rating – 300 V, 15 A

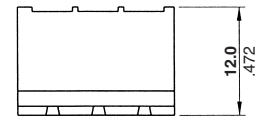
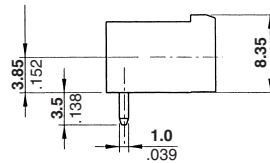
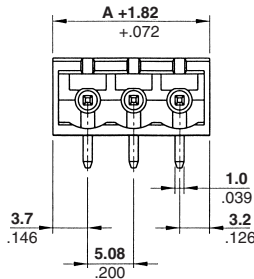
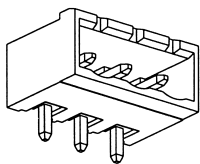

Recommended PC Board Layout

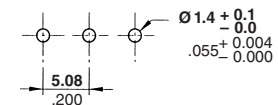

| No. of Pos. | Dim. A | Part Numbers | | | |
|-------------|--------------|--------------|------------|------------|-----------|
| | | Gray | Green | Black | Black* |
| 2 | 10.16 [0.40] | 1546109-2 | 796638-2 | 796639-2 | 1776038-2 |
| 3 | 15.24 [0.60] | 1546109-3 | 796638-3 | 796639-3 | 1776038-3 |
| 4 | 20.32 [0.80] | 1546109-4 | 796638-4 | 796639-4 | 1776038-4 |
| 5 | 25.40 [1.00] | 1546109-5 | 796638-5 | 796639-5 | 1776038-5 |
| 6 | 30.48 [1.20] | 1546109-6 | 796638-6 | 796639-6 | 1776038-6 |
| 7 | 35.56 [1.40] | 1546109-7 | 796638-7 | 796639-7 | 1776038-7 |
| 8 | 40.64 [1.60] | 1546109-8 | 796638-8 | 796639-8 | 1776038-8 |
| 9 | 45.72 [1.80] | 1546109-9 | 796638-9 | 796639-9 | — |
| 10 | 50.80 [2.00] | 1-1546109-0 | 1-796638-0 | 1-796639-0 | — |
| 11 | 55.88 [2.20] | 1-1546109-1 | 1-796638-1 | 1-796639-1 | — |
| 12 | 60.96 [2.40] | 1-1546109-2 | 1-796638-2 | 1-796639-2 | — |
| 13 | 66.04 [2.60] | 1-1546109-3 | 1-796638-3 | 1-796639-3 | — |

| No. of Positions | Dim. A | Part Numbers | | |
|------------------|---------------|--------------|------------|------------|
| | | Gray | Green | Black |
| 14 | 71.12 [2.80] | 1-1546109-4 | 1-796638-4 | 1-796639-4 |
| 15 | 76.20 [3.00] | 1-1546109-5 | 1-796638-5 | 1-796639-5 |
| 16 | 81.28 [3.20] | 1-1546109-6 | 1-796638-6 | 1-796639-6 |
| 17 | 86.36 [3.40] | 1-1546109-7 | 1-796638-7 | 1-796639-7 |
| 18 | 91.44 [3.60] | 1-1546109-8 | 1-796638-8 | 1-796639-8 |
| 19 | 96.52 [3.80] | 1-1546109-9 | 1-796638-9 | 1-796639-9 |
| 20 | 101.60 [4.00] | 2-1546109-0 | 2-796638-0 | 2-796639-0 |
| 21 | 106.68 [4.20] | 2-1546109-1 | 2-796638-1 | 2-796639-1 |
| 22 | 111.76 [4.40] | 2-1546109-2 | 2-796638-2 | 2-796639-2 |
| 23 | 116.84 [4.60] | 2-1546109-3 | 2-796638-3 | 2-796639-3 |
| 24 | 121.92 [4.80] | 2-1546109-4 | 2-796638-4 | 2-796639-4 |
| 25 | 127.00 [5.00] | 2-1546109-5 | 2-796638-5 | 2-796639-5 |

Note: RDI Terminal Block Series 2EHDR-xx has been superceded/replaced with 796638-xx (green) and 796639-xx (black).

*Wave solder process capable to 265°C [509°F] for 10 seconds. Dimensions may vary from what is shown for High Temperature Parts. Please check Customer Drawing.



Two-Piece Terminal Block Connectors (Continued)

**Right-Angle,
Open End Headers,
7.5 mm Centerline
Color – Green**

UL Rating – 300 V, 15 A

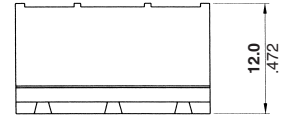
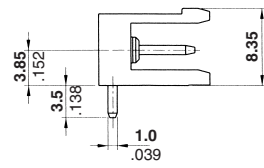
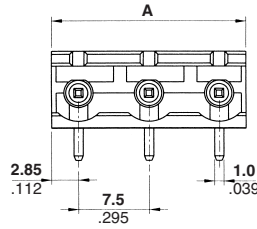
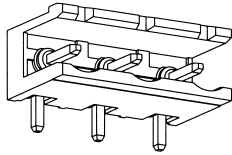

Recommended PC Board Layout

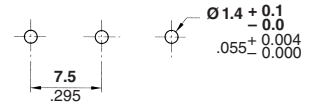

| No. of Positions | Dim. A | Part Numbers |
|------------------|--------------|--------------|
| 2 | 13.2 [0.520] | 282961-2 |
| 3 | 20.7 [0.815] | 282961-3 |
| 4 | 28.2 [1.110] | 282961-4 |
| 5 | 35.7 [1.406] | 282961-5 |
| 6 | 43.2 [1.701] | 282961-6 |
| 7 | 50.7 [1.996] | 282961-7 |

| No. of Positions | Dim. A | Part Numbers |
|------------------|--------------|--------------|
| 8 | 58.2 [2.291] | 282961-8 |
| 9 | 65.7 [2.587] | 282961-9 |
| 10 | 73.2 [2.882] | 1-282961-0 |
| 11 | 80.7 [3.177] | 1-282961-1 |
| 12 | 88.2 [3.472] | 1-282961-2 |

**Right-Angle,
Closed End Headers,
7.5 mm Centerline
Color – Green**

UL Rating – 300 V, 15 A

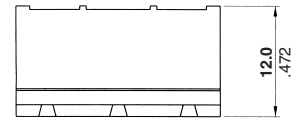
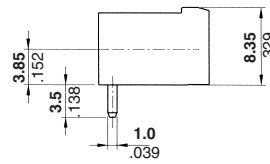
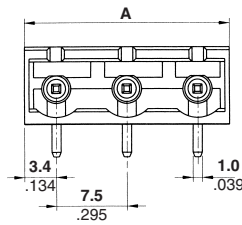
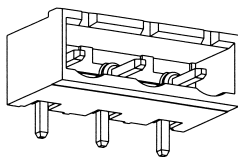

Recommended PC Board Layout

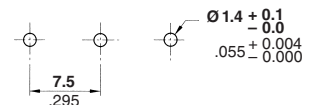

| No. of Positions | Dim. A | Part Numbers |
|------------------|--------------|--------------|
| 2 | 14.3 [0.563] | 282962-2 |
| 3 | 21.8 [0.858] | 282962-3 |
| 4 | 29.3 [1.154] | 282962-4 |
| 5 | 36.8 [1.449] | 282962-5 |
| 6 | 44.3 [1.744] | 282962-6 |
| 7 | 51.8 [2.039] | 282962-7 |

| No. of Positions | Dim. A | Part Numbers |
|------------------|--------------|--------------|
| 8 | 59.3 [2.335] | 282962-8 |
| 9 | 66.8 [2.630] | 282962-9 |
| 10 | 74.3 [2.925] | 1-282962-0 |
| 11 | 81.8 [3.220] | 1-282962-1 |
| 12 | 89.3 [3.516] | 1-282962-2 |

Note: All part numbers are RoHS Compliant.

Two-Piece Terminal Block Connectors (Continued)

Right-Angle, Open End Headers, 7.62 mm Centerline
UL Rating – 300 V, 15 A

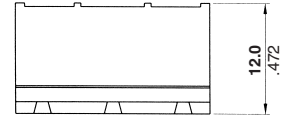
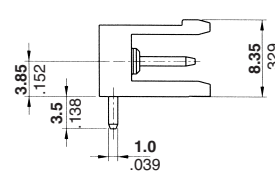
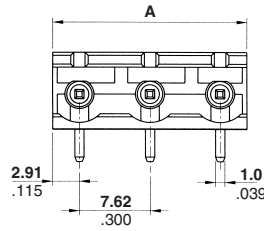
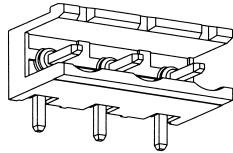

Recommended PC Board Layout

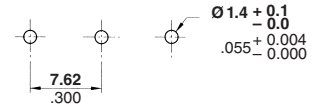

| No. of Positions | Dim. A | Part Numbers | |
|------------------|---------------|--------------|-----------|
| | | Green | Black* |
| 2 | 13.44 [0.529] | 282965-2 | 1776152-2 |
| 3 | 21.06 [0.829] | 282965-3 | 1776152-3 |
| 4 | 28.68 [1.129] | 282965-4 | — |
| 5 | 36.30 [1.429] | 282965-5 | — |
| 6 | 43.92 [1.729] | 282965-6 | — |
| 7 | 51.54 [2.029] | 282965-7 | — |

*Wave solder process capable to 265°C [509°F] for 10 seconds
Dimensions may vary from what is shown for High Temperature Parts.
Please check Customer Drawing.

| No. of Positions | Dim. A | Part Numbers | |
|------------------|---------------|--------------|--------|
| | | Green | Black* |
| 8 | 59.16 [2.329] | 282965-8 | — |
| 9 | 66.78 [2.629] | 282965-9 | — |
| 10 | 74.40 [2.929] | 1-282965-0 | — |
| 11 | 82.02 [3.229] | 1-282965-1 | — |
| 12 | 89.64 [3.529] | 1-282965-2 | — |

Right-Angle, Closed End Headers, 7.62 mm Centerline
UL Rating – 300 V, 15 A

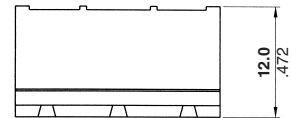
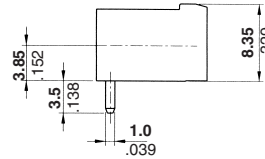
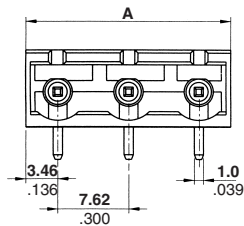
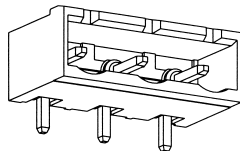

Recommended PC Board Layout

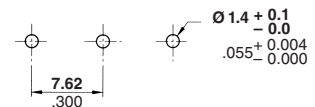

| No. of Positions | Dim. A | Part Numbers | |
|------------------|---------------|--------------|-----------|
| | | Green | Black* |
| 2 | 14.44 [0.568] | 282966-2 | 1776155-2 |
| 3 | 22.06 [0.868] | 282966-3 | 1776155-3 |
| 4 | 29.68 [1.168] | 282966-4 | 1776155-4 |
| 5 | 37.30 [1.468] | 282966-5 | 1776155-5 |
| 6 | 44.92 [1.768] | 282966-6 | 1776155-6 |
| 7 | 52.54 [2.068] | 282966-7 | 1776155-7 |

*Wave solder process capable to 265°C [509°F] for 10 seconds
Dimensions may vary from what is shown for High Temperature Parts.
Please check Customer Drawing.

| No. of Positions | Dim. A | Part Numbers | |
|------------------|---------------|--------------|-------------|
| | | Green | Black* |
| 8 | 60.16 [2.368] | 282966-8 | 1776155-8 |
| 9 | 67.78 [2.668] | 282966-9 | 1776155-9 |
| 10 | 75.40 [2.968] | 1-282966-0 | 1-1776155-0 |
| 11 | 83.02 [3.268] | 1-282966-1 | 1-1776155-1 |
| 12 | 90.64 [3.568] | 1-282966-2 | 1-1776155-2 |

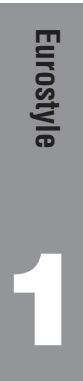

Note: All part numbers are RoHS Compliant.

Two-Piece Terminal Block Connectors (Continued)

Right-Angle, Open End Headers, 10.0 mm Centerline
UL Rating – 600 V, 15 A

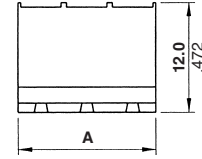
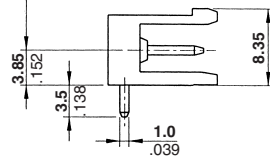
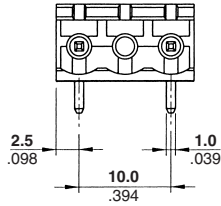
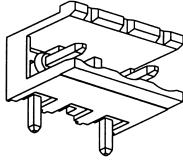

Recommended PC Board Layout

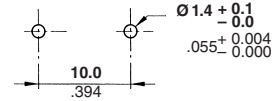

| No. of Positions | Dim. A | Part Numbers | |
|------------------|--------------|--------------|-----------|
| | | Green | Black* |
| 2 | 15.0 [0.591] | 282817-2 | 1776158-2 |
| 3 | 25.0 [0.984] | 282817-3 | 1776158-3 |
| 4 | 35.0 [1.378] | 282817-4 | 1776158-4 |
| 5 | 45.0 [1.772] | 282817-5 | — |
| 6 | 55.0 [2.165] | 282817-6 | — |
| 7 | 65.0 [2.559] | 282817-7 | — |

| No. of Positions | Dim. A | Part Numbers | |
|------------------|---------------|--------------|--------|
| | | Green | Black* |
| 8 | 75.0 [2.953] | 282817-8 | — |
| 9 | 85.0 [3.346] | 282817-9 | — |
| 10 | 95.0 [3.740] | 1-282817-0 | — |
| 11 | 105.0 [4.134] | 1-282817-1 | — |
| 12 | 115.0 [4.528] | 1-282817-2 | — |
| 13 | 125.0 [4.921] | 1-282817-3 | — |

*Wave solder process capable to 265°C [509°F] for 10 seconds. Dimensions may vary from what is shown for High Temperature Parts. Please check Customer Drawing.

Right-Angle, Closed End Headers, 10.0 mm Centerline
UL Rating – 600 V, 15 A

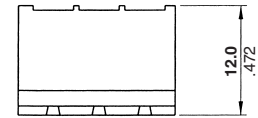
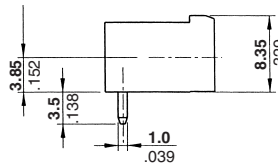
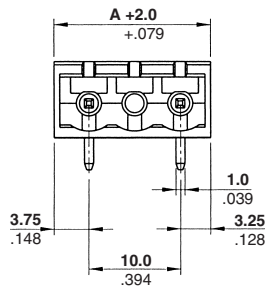
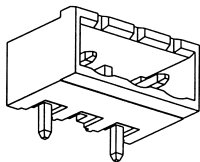

Recommended PC Board Layout

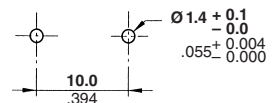

| No. of Positions | Dim. A | Part Numbers | |
|------------------|--------------|--------------|-----------|
| | | Green | Black* |
| 2 | 15.0 [0.591] | 282816-2 | 1776162-2 |
| 3 | 25.0 [0.984] | 282816-3 | 1776162-3 |
| 4 | 35.0 [1.378] | 282816-4 | 1776162-4 |
| 5 | 45.0 [1.772] | 282816-5 | — |
| 6 | 55.0 [2.165] | 282816-6 | — |
| 7 | 65.0 [2.559] | 282816-7 | — |

| No. of Positions | Dim. A | Part Numbers | |
|------------------|---------------|--------------|--------|
| | | Green | Black* |
| 8 | 75.0 [2.953] | 282816-8 | — |
| 9 | 85.0 [3.346] | 282816-9 | — |
| 10 | 95.0 [3.740] | 1-282816-0 | — |
| 11 | 105.0 [4.134] | 1-282816-1 | — |
| 12 | 115.0 [4.528] | 1-282816-2 | — |
| 13 | 125.0 [4.921] | 1-282816-3 | — |

*Wave solder process capable to 265°C [509°F] for 10 seconds. Dimensions may vary from what is shown for High Temperature Parts. Please check Customer Drawing.

Note: All part numbers are RoHS Compliant.

Two-Piece Terminal Block Connectors (Continued)

Right-Angle, Open End Headers, 10.16 mm Centerline
UL Rating – 600 V, 15 A

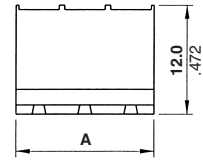
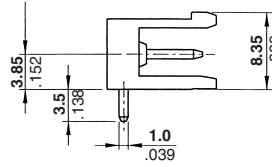
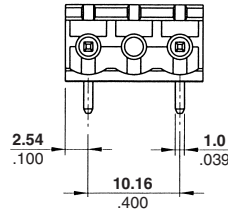
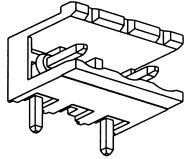

Recommended PC Board Layout

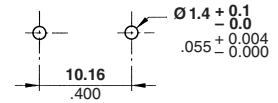

| No. of Positions | Dim. A | Part Numbers | |
|------------------|--------------|--------------|-----------|
| | | Green | Black* |
| 2 | 15.24 [0.60] | 282819-2 | 1776159-2 |
| 3 | 25.40 [1.00] | 282819-3 | 1776159-3 |
| 4 | 35.56 [1.40] | 282819-4 | 1776159-4 |
| 5 | 45.72 [1.80] | 282819-5 | — |
| 6 | 55.88 [2.20] | 282819-6 | — |
| 7 | 66.04 [2.60] | 282819-7 | — |

| No. of Positions | Dim. A | Part Numbers | |
|------------------|---------------|--------------|--------|
| | | Green | Black* |
| 8 | 76.20 [3.00] | 282819-8 | — |
| 9 | 86.36 [3.40] | 282819-9 | — |
| 10 | 96.52 [3.80] | 1-282819-0 | — |
| 11 | 106.68 [4.20] | 1-282819-1 | — |
| 12 | 116.84 [4.60] | 1-282819-2 | — |
| 13 | 127.00 [5.00] | 1-282819-3 | — |

*Wave solder process capable to 265°C [509°F] for 10 seconds. Dimensions may vary from what is shown for High Temperature Parts. Please check Customer Drawing.

Right-Angle, Closed End Headers, 10.16 mm Centerline
UL Rating – 600 V, 15 A

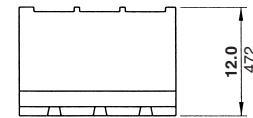
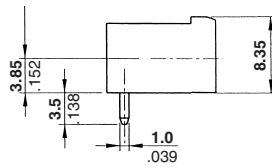
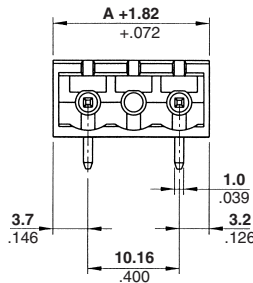
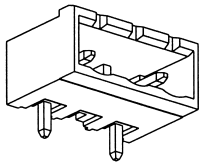

Recommended PC Board Layout

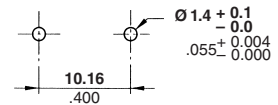

| No. of Positions | Dim. A | Part Numbers | |
|------------------|--------------|--------------|-----------|
| | | Green | Black* |
| 2 | 15.24 [0.60] | 282818-2 | 1776163-2 |
| 3 | 25.40 [1.00] | 282818-3 | 1776163-3 |
| 4 | 35.56 [1.40] | 282818-4 | 1776163-4 |
| 5 | 45.72 [1.80] | 282818-5 | — |
| 6 | 55.88 [2.20] | 282818-6 | — |
| 7 | 66.04 [2.60] | 282818-7 | — |

| No. of Positions | Dim. A | Part Numbers | |
|------------------|---------------|--------------|--------|
| | | Green | Black* |
| 8 | 76.20 [3.00] | 282818-8 | — |
| 9 | 86.36 [3.40] | 282818-9 | — |
| 10 | 96.52 [3.80] | 1-282818-0 | — |
| 11 | 106.68 [4.20] | 1-282818-1 | — |
| 12 | 116.84 [4.60] | 1-282818-2 | — |
| 13 | 127.00 [5.00] | 1-282818-3 | — |

*Wave solder process capable to 265°C [509°F] for 10 seconds. Dimensions may vary from what is shown for High Temperature Parts. Please check Customer Drawing.



Note: All part numbers are RoHS Compliant.

Two-Piece Terminal Block Connectors (Continued)

**Right-Angle,
Open End Stacking Headers
with Interlock,
5.0 mm Centerline
UL Rating – 300 V, 15 A**

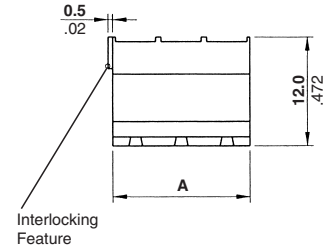
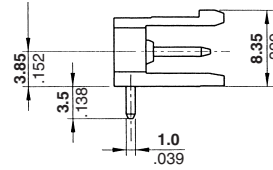
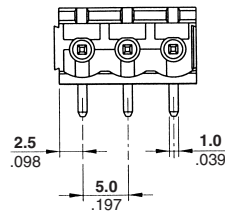
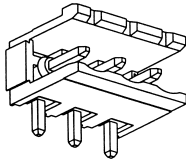

Recommended PC Board Layout

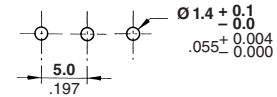

| No. of Positions | Dim. A | Part Numbers | |
|------------------|-------------|--------------|-----------|
| | | Green | Black* |
| 2 | 10.0 [.394] | 282811-2 | 1776144-2 |
| 3 | 15.0 [.591] | 282811-3 | 1776144-3 |
| 4 | 20.0 [.787] | 282811-4 | 1776144-4 |

*Wave solder process capable to 265°C [509°F] for 10 seconds
Dimensions may vary from what is shown for High Temperature Parts.
Please check Customer Drawing.

**Right-Angle,
Open End Stacking Headers
with Interlock,
5.08 mm Centerline
UL Rating – 300 V, 15 A**

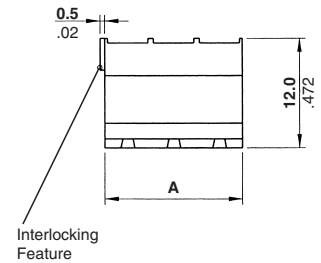
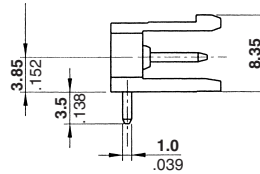
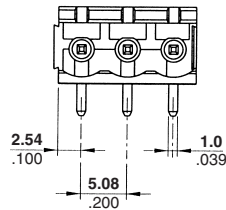
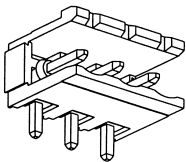

Recommended PC Board Layout

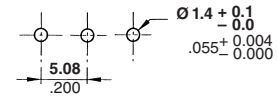

| No. of Positions | Dim. A | Part Numbers | |
|------------------|--------------|--------------|-----------|
| | | Green | Black* |
| 2 | 10.16 [.400] | 282814-2 | 1776145-2 |
| 3 | 15.24 [.600] | 282814-3 | 1776145-3 |
| 4 | 20.32 [.800] | 282814-4 | 1776145-4 |

*Wave solder process capable to 265°C [509°F] for 10 seconds
Dimensions may vary from what is shown for High Temperature Parts.
Please check Customer Drawing.

Note: All part numbers are RoHS Compliant.

Two-Piece Terminal Block Connectors (Continued)

**Right-Angle,
Closed End Headers,
w/Ejectors,
5.08 mm Centerline
Color – Green**
UL Rating – 300 V, 15 A

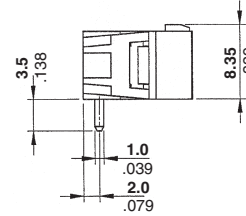
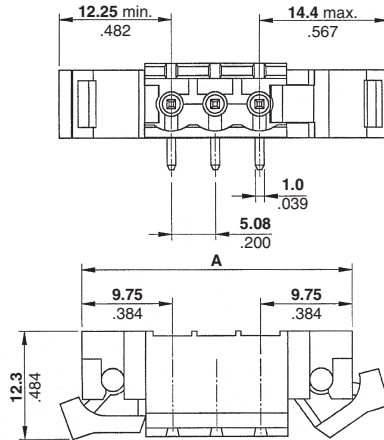
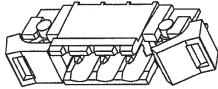

Recommended PC Board Layout

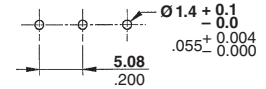

| No. of Positions | Dim. A | Part Numbers |
|------------------|----------------------|--------------|
| 2 | 24.58 [.968] | 284008-2 |
| 3 | 29.66 [1.168] | 284008-3 |
| 4 | 34.74 [1.368] | 284008-4 |
| 5 | 39.82 [1.568] | 284008-5 |
| 6 | 44.90 [1.768] | 284008-6 |
| 7 | 49.98 [1.968] | 284008-7 |
| 8 | 55.06 [2.168] | 284008-8 |
| 9 | 60.14 [2.368] | 284008-9 |
| 10 | 65.22 [2.568] | 1-284008-0 |
| 11 | 70.30 [2.768] | 1-284008-1 |

| No. of Positions | Dim. A | Part Numbers |
|------------------|-----------------------|--------------|
| 12 | 75.38 [2.968] | 1-284008-2 |
| 13 | 80.46 [3.168] | 1-284008-3 |
| 14 | 85.54 [3.368] | 1-284008-4 |
| 15 | 90.62 [3.568] | 1-284008-5 |
| 16 | 95.70 [3.768] | 1-284008-6 |
| 17 | 100.78 [3.968] | 1-284008-7 |
| 18 | 105.86 [4.168] | 1-284008-8 |
| 19 | 110.94 [4.368] | 1-284008-9 |
| 20 | 116.02 [4.568] | 2-284008-0 |
| 21 | 121.10 [4.768] | 2-284008-1 |



Note: All part numbers are RoHS Compliant.

Two-Piece Terminal Block Connectors (Continued)

Vertical, Closed End Double-Row Header
5.0 mm Centerline
 Color – See chart.
 UL Rating – 300 V, 12 A

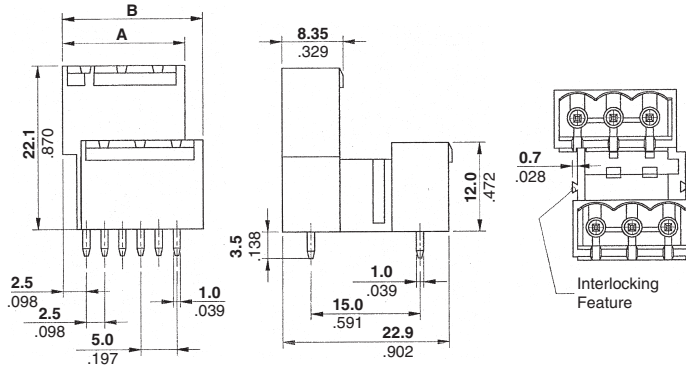
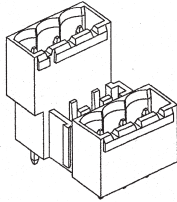

Recommended PC Board Layout

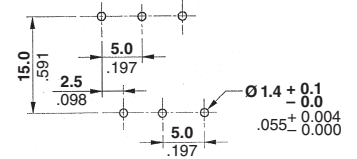

| No. of Positions | Dimensions | | Part Numbers | | |
|------------------|--------------|--------------|--------------|-------------|-----------|
| | A | B | Green | Gray | Black* |
| 2 | 12.0 [0.472] | 14.5 [0.571] | 284056-2 | 1546106-2 | 1776164-2 |
| 3 | 17.0 [0.669] | 19.5 [0.768] | 284056-3 | 1546106-3 | 1776164-3 |
| 4 | 22.0 [0.866] | 24.5 [0.965] | 284056-4 | 1546106-4 | 1776164-4 |
| 5 | 27.0 [1.063] | 29.5 [1.161] | 284056-5 | 1546106-5 | 1776164-5 |
| 6 | 32.0 [1.260] | 34.5 [1.358] | 284056-6 | 1546106-6 | 1776164-6 |
| 7 | 37.0 [1.457] | 39.5 [1.555] | 284056-7 | 1546106-7 | 1776164-7 |
| 8 | 42.0 [1.654] | 44.5 [1.752] | 284056-8 | 1546106-8 | 1776164-8 |
| 9 | 47.0 [1.850] | 49.5 [1.949] | 284056-9 | 1546106-9 | — |
| 10 | 52.0 [2.047] | 54.5 [2.146] | 284056-10 | 1-1546106-0 | — |
| 11 | 57.0 [2.244] | 59.5 [2.343] | 284056-11 | 1-1546106-1 | — |
| 12 | 62.0 [2.441] | 64.5 [2.539] | 284056-12 | 1-1546106-2 | — |
| 13 | 67.0 [2.638] | 69.5 [2.736] | 284056-13 | 1-1546106-3 | — |

*Wave solder process capable to 265°C [509°F] for 10 seconds

| No. of Positions | Dimensions | | Part Numbers | | |
|------------------|---------------|---------------|--------------|-------------|--------|
| | A | B | Green | Gray | Black* |
| 14 | 72.0 [2.835] | 74.5 [2.933] | 284056-14 | 1-1546106-4 | — |
| 15 | 77.0 [3.031] | 79.5 [3.130] | 284056-15 | 1-1546106-5 | — |
| 16 | 82.0 [3.228] | 84.5 [3.327] | 284056-16 | 1-1546106-6 | — |
| 17 | 87.0 [3.425] | 89.5 [3.524] | 284056-17 | 1-1546106-7 | — |
| 18 | 92.0 [3.622] | 94.5 [3.720] | 284056-18 | 1-1546106-8 | — |
| 19 | 97.0 [3.819] | 99.5 [3.917] | 284056-19 | 1-1546106-9 | — |
| 20 | 102.0 [4.016] | 104.5 [4.114] | 284056-20 | 2-1546106-0 | — |
| 21 | 107.0 [4.213] | 109.5 [4.311] | 284056-21 | 2-1546106-1 | — |
| 22 | 112.0 [4.409] | 114.5 [4.508] | 284056-22 | 2-1546106-2 | — |
| 23 | 117.0 [4.606] | 119.5 [4.705] | 284056-23 | 2-1546106-3 | — |
| 24 | 122.0 [4.803] | 124.5 [4.902] | 284056-24 | 2-1546106-4 | — |
| 25 | 127.0 [5.000] | 129.5 [5.098] | 284056-25 | 2-1546106-5 | — |

Vertical, Closed End Double-Row Header
5.08 mm Centerline
 UL Rating – 300 V, 12 A

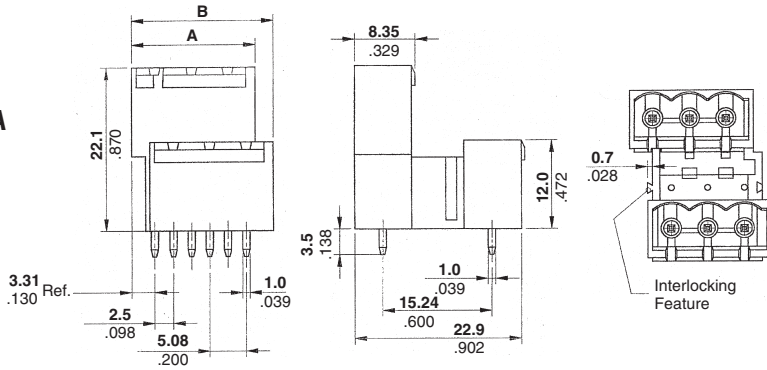
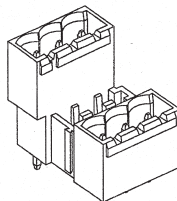

Recommended PC Board Layout

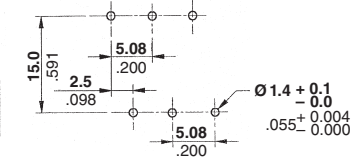

| No. of Positions | Dim. | | Part Numbers | |
|------------------|--------------|--------------|--------------|-----------|
| | A | B | Green | Black* |
| 2 | 12.20 [0.48] | 14.74 [0.58] | 284065-2 | 1776165-2 |
| 3 | 17.28 [0.68] | 19.82 [0.78] | 284065-3 | 1776165-3 |
| 4 | 22.36 [0.88] | 24.90 [0.98] | 284065-4 | 1776165-4 |
| 5 | 27.44 [1.08] | 29.98 [1.18] | 284065-5 | 1776165-5 |
| 6 | 32.52 [1.28] | 35.06 [1.38] | 284065-6 | 1776165-6 |
| 7 | 37.60 [1.48] | 40.14 [1.58] | 284065-7 | 1776165-7 |
| 8 | 42.68 [1.68] | 45.22 [1.78] | 284065-8 | 1776165-8 |
| 9 | 47.76 [1.88] | 50.30 [1.98] | 284065-9 | — |
| 10 | 52.84 [2.08] | 55.38 [2.18] | 1-284065-0 | — |
| 11 | 57.92 [2.28] | 60.46 [2.68] | 1-284065-1 | — |
| 12 | 63.00 [2.48] | 65.54 [2.58] | 1-284065-2 | — |
| 13 | 68.08 [2.68] | 70.62 [2.78] | 1-284065-3 | — |

*Wave solder process capable to 265°C [509°F] for 10 seconds

| No. of Positions | Dim. | | Part Numbers | |
|------------------|---------------|---------------|--------------|--------|
| | A | B | Green | Black* |
| 14 | 72.0 [2.835] | 74.5 [2.933] | 1-284065-4 | — |
| 15 | 77.0 [3.031] | 79.5 [3.130] | 1-284065-5 | — |
| 16 | 82.0 [3.228] | 84.5 [3.327] | 1-284065-6 | — |
| 17 | 87.0 [3.425] | 89.5 [3.524] | 1-284065-7 | — |
| 18 | 92.0 [3.622] | 94.5 [3.720] | 1-284065-8 | — |
| 19 | 97.0 [3.819] | 99.5 [3.917] | 1-284065-9 | — |
| 20 | 102.0 [4.016] | 104.5 [4.114] | 2-284065-0 | — |
| 21 | 107.0 [4.213] | 109.5 [4.311] | 2-284065-1 | — |
| 22 | 112.0 [4.409] | 114.5 [4.508] | 2-284065-2 | — |
| 23 | 117.0 [4.606] | 119.5 [4.705] | 2-284065-3 | — |
| 24 | 122.0 [4.803] | 124.5 [4.902] | 2-284065-4 | — |
| 25 | 127.0 [5.000] | 129.5 [5.098] | 2-284065-5 | — |

Note: All part numbers are RoHS Compliant.

Two-Piece Terminal Block Connectors (Continued)

**Vertical, Closed End
Double-Row Header
10.0 mm Centerline
Color – Black
UL Rating – 600 V, 12 A**

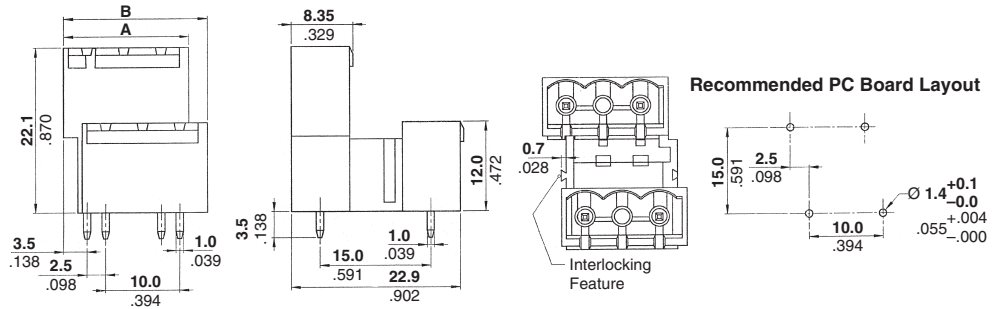
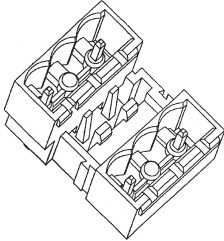

| No. of Positions | Dim. | | Part Numbers* |
|------------------|--------------|--------------|---------------|
| | A | B | |
| 2 | 17.0 [0.669] | 19.5 [0.768] | 1776168-2 |
| 3 | 27.0 [1.063] | 29.5 [1.161] | 1776168-3 |
| 4 | 37.0 [1.457] | 39.5 [1.555] | 1776168-4 |

*Wave solder process capable to 265°C [509°F] for 10 seconds

**Vertical, Closed End
Double-Row Header
10.16 mm Centerline
Color – Black
UL Rating – 600 V, 12 A**

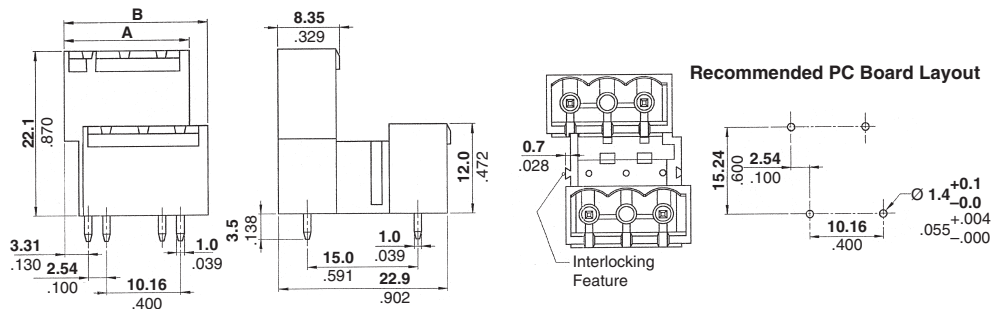
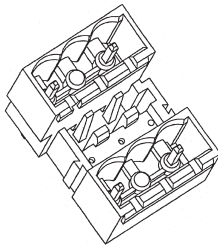

| No. of Positions | Dim. | | Part Numbers* |
|------------------|--------------|--------------|---------------|
| | A | B | |
| 2 | 17.28 [0.68] | 19.82 [0.78] | 1776169-2 |
| 3 | 27.44 [1.08] | 29.98 [1.18] | 1776169-3 |
| 4 | 37.60 [1.48] | 40.14 [1.58] | 1776169-4 |

*Wave solder process capable to 265°C [509°F] for 10 seconds

Note: All part numbers are RoHS Compliant.

Two-Piece Terminal Block Connectors (Continued)

Right-Angle, Open End Double-Row Header w/Interlock, 5.0 mm Centerline Color – Green
UL Rating – 300 V, 12 A

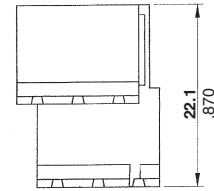
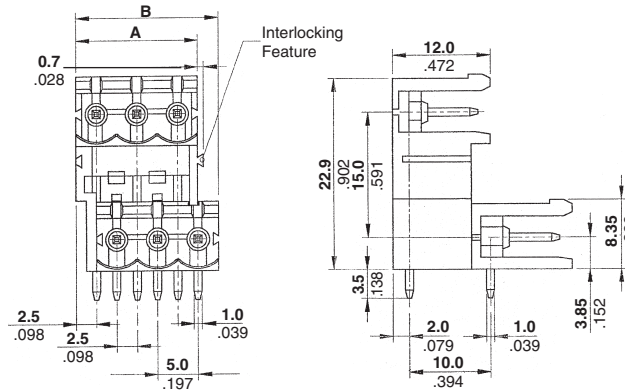
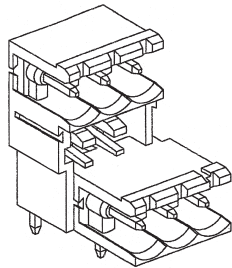

Recommended PC Board Layout

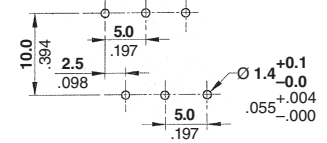

| No. of Positions | Dim. | | Part Numbers |
|------------------|-------------|-------------|--------------|
| | A | B | |
| 2 | 10.0 [.394] | 12.5 [.492] | 284052-2 |
| 3 | 15.0 [.591] | 17.5 [.689] | 284052-3 |

Right-Angle, Open End Double-Row Header w/Interlock, 5.08 mm Centerline Color – See chart.
UL Rating – 300 V, 12 A

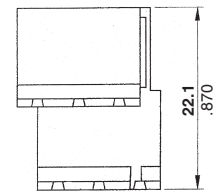
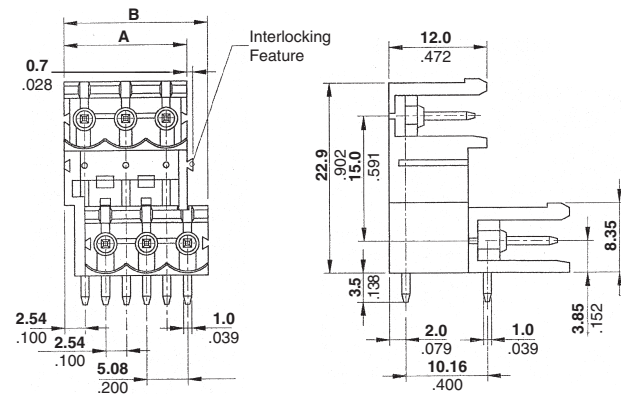
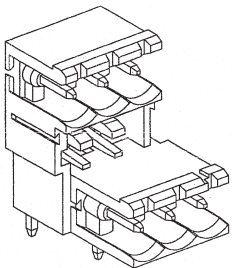

Recommended PC Board Layout

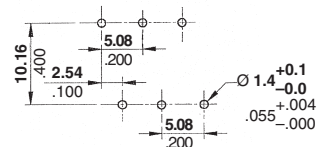

| No. of Positions | Dim. | | Part Numbers | |
|------------------|--------------|--------------|--------------|-----------|
| | A | B | Green | Gray |
| 2 | 10.16 [.400] | 12.70 [.500] | 284053-2 | 1546237-2 |
| 3 | 15.24 [.600] | 17.78 [.700] | 284053-3 | 1546237-3 |

Note: All part numbers are RoHS Compliant.

Two-Piece Terminal Block Connectors (Continued)

Right-Angle, Closed End Double-Row Header w/Interlock, 5.0 mm Centerline Color – Black
UL Rating – 300 V, 12 A

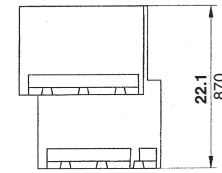
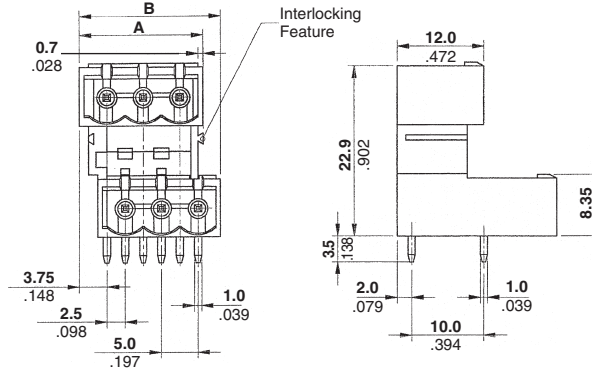
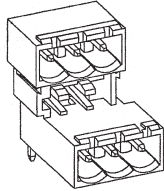

Recommended PC Board Layout

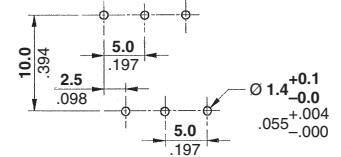

| No. of Positions | Dim. | | Part Numbers* |
|------------------|--------------|--------------|---------------|
| | A | B | |
| 2 | 12.0 [0.472] | 14.5 [0.571] | 1776166-2 |
| 3 | 17.0 [0.669] | 19.5 [0.768] | 1776166-3 |
| 4 | 22.0 [0.866] | 24.5 [0.965] | 1776166-4 |
| 5 | 27.0 [1.063] | 29.5 [1.161] | 1776166-5 |
| 6 | 32.0 [1.260] | 34.5 [1.358] | 1776166-6 |
| 7 | 37.0 [1.457] | 39.5 [1.555] | 1776166-7 |
| 8 | 42.0 [1.654] | 44.5 [1.752] | 1776166-8 |

*Wave solder process capable to 265°C [509°F] for 10 seconds

Right-Angle, Closed End Double-Row Header w/Interlock, 5.08 mm Centerline
UL Rating – 300 V, 12 A

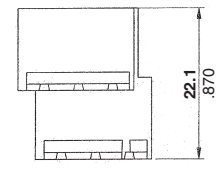
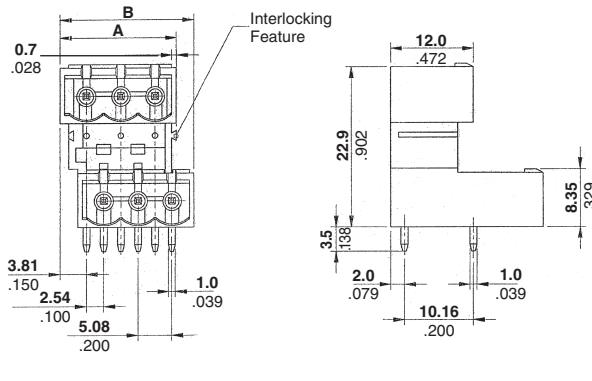
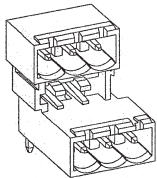

Recommended PC Board Layout

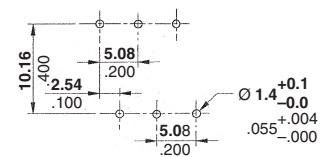

| No. of Positions | Dim. | | Part Numbers | |
|------------------|--------------|--------------|--------------|-----------|
| | A | B | Green | Black* |
| 2 | 12.20 [0.48] | 14.74 [0.58] | 284061-2 | 1776167-2 |
| 3 | 17.28 [0.68] | 19.82 [0.78] | 284061-3 | 1776167-3 |
| 4 | 22.36 [0.88] | 24.90 [0.98] | 284061-4 | 1776167-4 |
| 5 | 27.44 [1.08] | 29.98 [1.18] | 284061-5 | 1776167-5 |
| 6 | 32.52 [1.28] | 35.06 [1.38] | 284061-6 | 1776167-6 |
| 7 | 37.60 [1.48] | 40.14 [1.58] | 284061-7 | 1776167-7 |
| 8 | 42.68 [1.68] | 45.22 [1.78] | 284061-8 | 1776167-8 |
| 9 | 47.76 [1.88] | 50.30 [1.98] | 284061-9 | — |
| 10 | 52.84 [2.08] | 55.38 [2.18] | 1-284061-0 | — |
| 11 | 57.92 [2.28] | 60.46 [2.68] | 1-284061-1 | — |
| 12 | 63.00 [2.48] | 65.54 [2.58] | 1-284061-2 | — |
| 13 | 68.08 [2.68] | 70.62 [2.78] | 1-284061-3 | — |

*Wave solder process capable to 265°C [509°F] for 10 seconds

| No. of Positions | Dim. | | Part Numbers | |
|------------------|---------------|---------------|--------------|--------|
| | A | B | Green | Black* |
| 14 | 73.16 [2.88] | 75.70 [2.98] | 1-284061-4 | — |
| 15 | 78.24 [3.08] | 80.78 [3.18] | 1-284061-5 | — |
| 16 | 83.32 [3.28] | 85.86 [3.38] | 1-284061-6 | — |
| 17 | 88.40 [3.48] | 90.94 [3.58] | 1-284061-7 | — |
| 18 | 93.48 [3.68] | 96.02 [3.78] | 1-284061-8 | — |
| 19 | 98.56 [3.88] | 101.10 [3.98] | 1-284061-9 | — |
| 20 | 103.64 [4.08] | 106.18 [4.18] | 2-284061-0 | — |
| 21 | 108.72 [4.48] | 111.26 [4.38] | 2-284061-1 | — |
| 22 | 113.80 [4.88] | 116.34 [4.58] | 2-284061-2 | — |
| 23 | 118.88 [4.68] | 121.42 [4.78] | 2-284061-3 | — |
| 24 | 123.96 [4.88] | 126.50 [4.98] | 2-284061-4 | — |
| 25 | 129.04 [5.08] | 131.58 [5.18] | 2-284061-5 | — |



Note: All part numbers are RoHS Compliant.

Two-Piece Terminal Block Connectors (Continued)

Right-Angle, Closed End Double-Row Header w/Interlock, 10.0 mm Centerline Color – Black
UL Rating – 600 V, 12 A

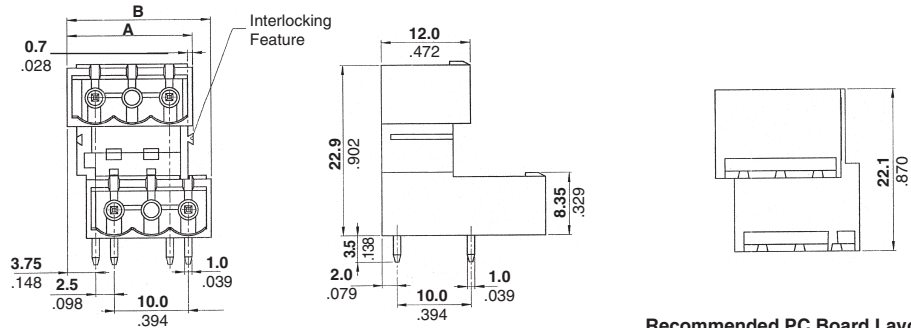
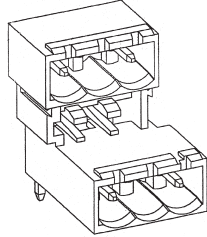

Recommended PC Board Layout

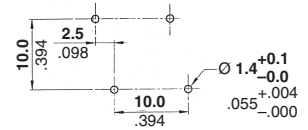

| No. of Positions | Dim. | | Part Numbers* |
|------------------|--------------|--------------|---------------|
| | A | B | |
| 2 | 17.0 [0.669] | 19.5 [0.768] | 1776170-2 |
| 3 | 27.0 [1.063] | 29.5 [1.161] | 1776170-3 |
| 4 | 37.0 [1.457] | 39.5 [1.555] | 1776170-4 |

*Wave solder process capable to 265°C [509°F] for 10 seconds

Right-Angle, Closed End Double-Row Header w/Interlock, 10.16 mm Centerline Color – Black
UL Rating – 600 V, 12 A

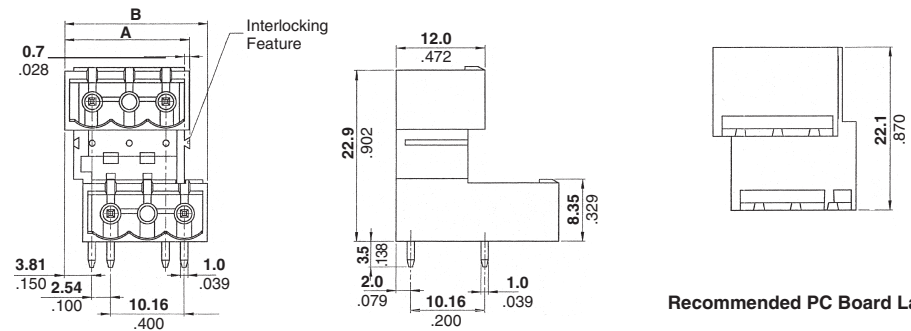
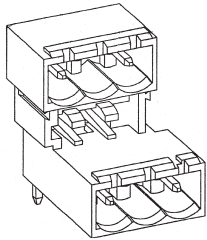

Recommended PC Board Layout

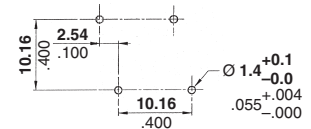

| No. of Positions | Dim. | | Part Numbers* |
|------------------|--------------|--------------|---------------|
| | A | B | |
| 2 | 17.28 [0.68] | 19.82 [0.78] | 1776171-2 |
| 3 | 27.44 [1.08] | 29.98 [1.18] | 1776171-3 |
| 4 | 37.60 [1.48] | 40.14 [1.58] | 1776171-4 |

*Wave solder process capable to 265°C [509°F] for 10 seconds

Two-Piece Terminal Block Connectors (Continued)

Plug, Right-Angle w/Screw Flange
3.5 mm Centerline
Color – Green
UL Rating – 300 V, 11 A
14-30 AWG

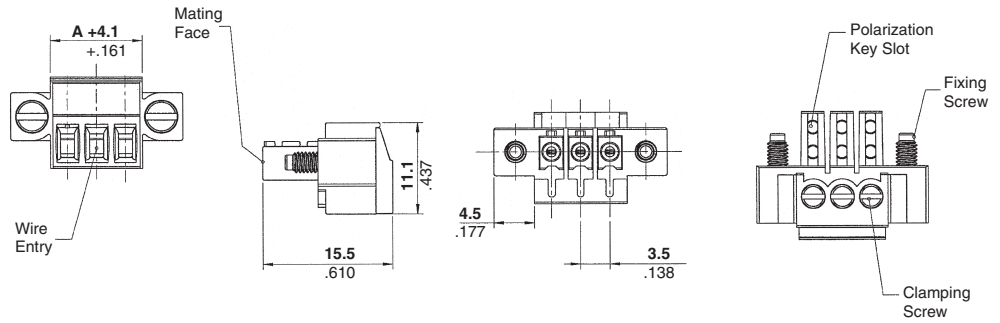
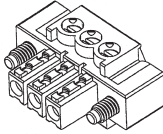

Suggested Screw Torque—
 2.7 in.-lb.

| No. of Positions | Dim. A | Part Numbers |
|------------------|--------------|--------------|
| 2 | 3.5 [0.138] | 284510-2 |
| 3 | 7.0 [0.276] | 284510-3 |
| 4 | 10.5 [0.413] | 284510-4 |
| 5 | 14.0 [0.551] | 284510-5 |
| 6 | 17.5 [0.689] | 284510-6 |
| 7 | 21.0 [0.827] | 284510-7 |
| 8 | 24.5 [0.965] | 284510-8 |
| 9 | 28.0 [1.102] | 284510-9 |
| 10 | 31.5 [1.240] | 1-284510-0 |
| 11 | 35.0 [1.378] | 1-284510-1 |
| 12 | 38.5 [1.516] | 1-284510-2 |

| No. of Positions | Dim. A | Part Numbers |
|------------------|--------------|--------------|
| 13 | 42.0 [1.654] | 1-284510-3 |
| 14 | 45.5 [1.791] | 1-284510-4 |
| 15 | 49.0 [1.929] | 1-284510-5 |
| 16 | 52.5 [2.067] | 1-284510-6 |
| 17 | 56.0 [2.205] | 1-284510-7 |
| 18 | 59.5 [2.343] | 1-284510-8 |
| 19 | 63.0 [2.480] | 1-284510-9 |
| 20 | 66.5 [2.618] | 2-284510-0 |
| 21 | 70.0 [2.756] | 2-284510-1 |
| 22 | 73.5 [2.894] | 2-284510-2 |
| 23 | 77.0 [3.031] | 2-284510-3 |

Plug, Right-Angle w/Screw Flange
3.81 mm Centerline
Color – Green
UL Rating – 300 V, 11 A
14-30 AWG

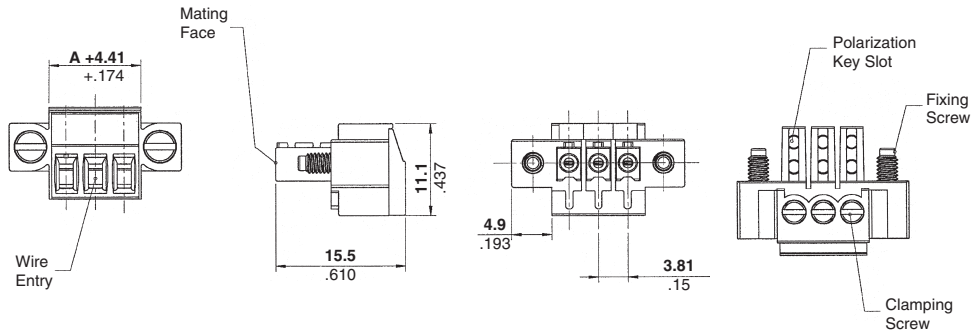
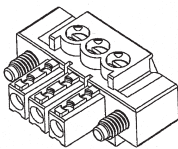

Suggested Screw Torque—
 2.7 in.-lb.

| No. of Positions | Dim. A | Part Numbers |
|------------------|--------------|--------------|
| 2 | 3.81 [0.15] | 284511-2 |
| 3 | 7.62 [0.30] | 284511-3 |
| 4 | 11.43 [0.45] | 284511-4 |
| 5 | 15.24 [0.60] | 284511-5 |
| 6 | 19.05 [0.75] | 284511-6 |
| 7 | 22.86 [0.90] | 284511-7 |
| 8 | 26.67 [1.05] | 284511-8 |
| 9 | 30.48 [1.20] | 284511-9 |
| 10 | 34.29 [1.35] | 1-284511-0 |
| 11 | 38.10 [1.50] | 1-284511-1 |
| 12 | 41.91 [1.65] | 1-284511-2 |

| No. of Positions | Dim. A | Part Numbers |
|------------------|--------------|--------------|
| 13 | 45.72 [1.80] | 1-284511-3 |
| 14 | 49.53 [1.95] | 1-284511-4 |
| 15 | 53.34 [2.10] | 1-284511-5 |
| 16 | 57.15 [2.25] | 1-284511-6 |
| 17 | 60.96 [2.40] | 1-284511-7 |
| 18 | 64.77 [2.55] | 1-284511-8 |
| 19 | 68.58 [2.70] | 1-284511-9 |
| 20 | 72.39 [2.85] | 2-284511-0 |
| 21 | 76.20 [3.00] | 2-284511-1 |
| 22 | 80.01 [3.15] | 2-284511-2 |
| 23 | 83.82 [3.30] | 2-284511-3 |

Note: All part numbers are RoHS Compliant.

Two-Piece Terminal Block Connectors (Continued)

Plug, Right-Angle w/Locking Screw Flange, 5.0 mm Centerline Color – Green

UL Rating – 300 V, 15 A 12-30 AWG

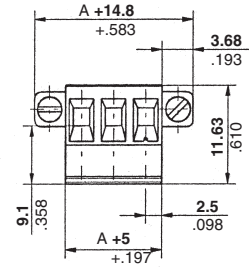
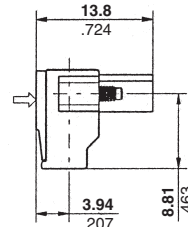
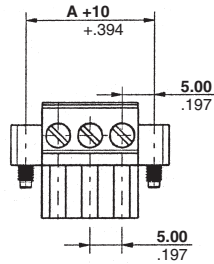
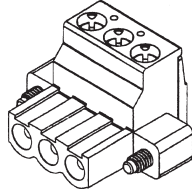

Suggested Screw Torque—
7.0 in.-lb.

| No. of Positions | Dim. A | Part Numbers |
|------------------|--------------|--------------|
| 2 | 5.0 [0.197] | 796858-2 |
| 3 | 10.0 [0.394] | 796858-3 |
| 4 | 15.0 [0.591] | 796858-4 |
| 5 | 20.0 [0.787] | 796858-5 |
| 6 | 25.0 [0.984] | 796858-6 |
| 7 | 30.0 [1.181] | 796858-7 |
| 8 | 35.0 [1.378] | 796858-8 |

Plug, Right-Angle w/Locking Screw Flange, 5.08 mm Centerline Color – Green

UL Rating – 300 V, 15 A 12-30 AWG

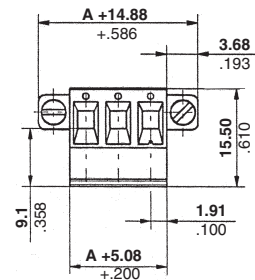
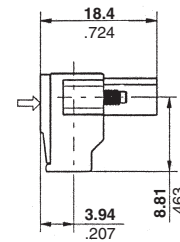
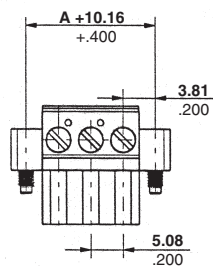
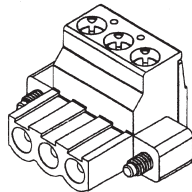

Suggested Screw Torque—
7.0 in.-lb.

| No. of Positions | Dim. A | Part Numbers |
|------------------|--------------|--------------|
| 2 | 5.08 [0.20] | 796859-2 |
| 3 | 10.16 [0.40] | 796859-3 |
| 4 | 15.24 [0.60] | 796859-4 |
| 5 | 20.32 [0.80] | 796859-5 |
| 6 | 25.40 [1.00] | 796859-6 |
| 7 | 30.48 [1.20] | 796859-7 |
| 8 | 35.56 [1.40] | 796859-8 |
| 9 | 40.64 [1.60] | 796859-9 |
| 10 | 45.72 [1.80] | 1-796859-0 |
| 11 | 50.80 [2.00] | 1-796859-1 |
| 12 | 55.88 [2.20] | 1-796859-2 |

| No. of Positions | Dim. A | Part Numbers |
|------------------|---------------|--------------|
| 13 | 60.96 [2.40] | 1-796859-3 |
| 14 | 66.04 [2.60] | 1-796859-4 |
| 15 | 71.12 [2.80] | 1-796859-5 |
| 16 | 76.20 [3.00] | 1-796859-6 |
| 17 | 81.28 [3.20] | 1-796859-7 |
| 18 | 86.36 [3.40] | 1-796859-8 |
| 19 | 91.44 [3.60] | 1-796859-9 |
| 20 | 96.52 [3.80] | 2-796859-0 |
| 21 | 101.60 [4.00] | 2-796859-1 |
| 22 | 106.68 [4.20] | 2-796859-2 |
| 23 | 111.76 [4.40] | 2-796859-3 |

Note: All part numbers are RoHS Compliant.

Two-Piece Terminal Block Connectors (Continued)

**Plug (Left-Hand Version),
Straight w/Locking Screw
Flange,
5.08 mm Centerline
Color – Green**

**UL Rating – 300 V, 15 A
12-30 AWG**

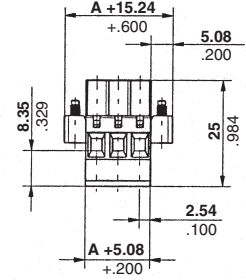
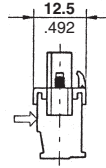
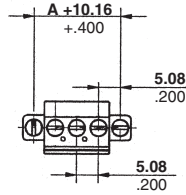
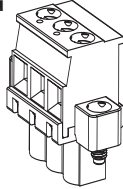

**Suggested Screw Torque—
7.0 in.-lb.**

| No. of Positions | Dim. A | Part Numbers |
|------------------|--------------|--------------|
| 2 | 5.08 [0.20] | 796861-2 |
| 3 | 10.16 [0.40] | 796861-3 |
| 4 | 15.24 [0.60] | 796861-4 |
| 5 | 20.32 [0.80] | 796861-5 |
| 6 | 25.40 [1.00] | 796861-6 |
| 7 | 30.48 [1.20] | 796861-7 |
| 8 | 35.56 [1.40] | 796861-8 |
| 9 | 40.64 [1.60] | 796861-9 |
| 10 | 45.72 [1.80] | 1-796861-0 |
| 11 | 50.80 [2.00] | 1-796861-1 |
| 12 | 55.88 [2.20] | 1-796861-2 |

| No. of Positions | Dim. A | Part Numbers |
|------------------|---------------|--------------|
| 13 | 60.96 [2.40] | 1-796861-3 |
| 14 | 66.04 [2.60] | 1-796861-4 |
| 15 | 71.12 [2.80] | 1-796861-5 |
| 16 | 76.20 [3.00] | 1-796861-6 |
| 17 | 81.28 [3.20] | 1-796861-7 |
| 18 | 86.36 [3.40] | 1-796861-8 |
| 19 | 91.44 [3.60] | 1-796861-9 |
| 20 | 96.52 [3.80] | 2-796861-0 |
| 21 | 101.60 [4.00] | 2-796861-1 |
| 22 | 106.68 [4.20] | 2-796861-2 |
| 23 | 111.76 [4.40] | 2-796861-3 |

**Plug (Right-Hand Version),
Straight w/Locking Screw
Flange,
5.08 mm Centerline
Color – Green**

**UL Rating – 300 V, 15 A
12-30 AWG**

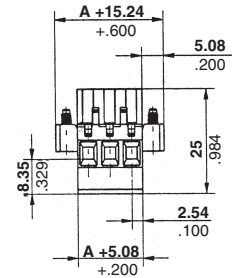
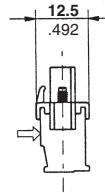
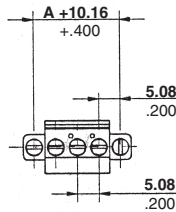
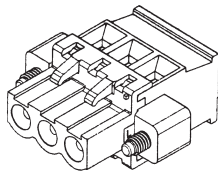

**Suggested Screw Torque—
7.0 in.-lb.**

| No. of Positions | Dim. A | Part Numbers |
|------------------|--------------|--------------|
| 2 | 5.08 [0.20] | 796863-2 |
| 3 | 10.16 [0.40] | 796863-3 |
| 4 | 15.24 [0.60] | 796863-4 |
| 5 | 20.32 [0.80] | 796863-5 |
| 6 | 25.40 [1.00] | 796863-6 |
| 7 | 30.48 [1.20] | 796863-7 |
| 8 | 35.56 [1.40] | 796863-8 |
| 9 | 40.64 [1.60] | 796863-9 |
| 10 | 45.72 [1.80] | 1-796863-0 |
| 11 | 50.80 [2.00] | 1-796863-1 |
| 12 | 55.88 [2.20] | 1-796863-2 |

| No. of Positions | Dim. A | Part Numbers |
|------------------|---------------|--------------|
| 13 | 60.96 [2.40] | 1-796863-3 |
| 14 | 66.04 [2.60] | 1-796863-4 |
| 15 | 71.12 [2.80] | 1-796863-5 |
| 16 | 76.20 [3.00] | 1-796863-6 |
| 17 | 81.28 [3.20] | 1-796863-7 |
| 18 | 86.36 [3.40] | 1-796863-8 |
| 19 | 91.44 [3.60] | 1-796863-9 |
| 20 | 96.52 [3.80] | 2-796863-0 |
| 21 | 101.60 [4.00] | 2-796863-1 |
| 22 | 106.68 [4.20] | 2-796863-2 |
| 23 | 111.76 [4.40] | 2-796863-3 |

Note: All part numbers are RoHS Compliant.

Two-Piece Terminal Block Connectors (Continued)

Plug, Right-Angle, 3.5 mm Centerline Colors – See chart.

UL Rating – 300 V, 11 A 14-30 AWG

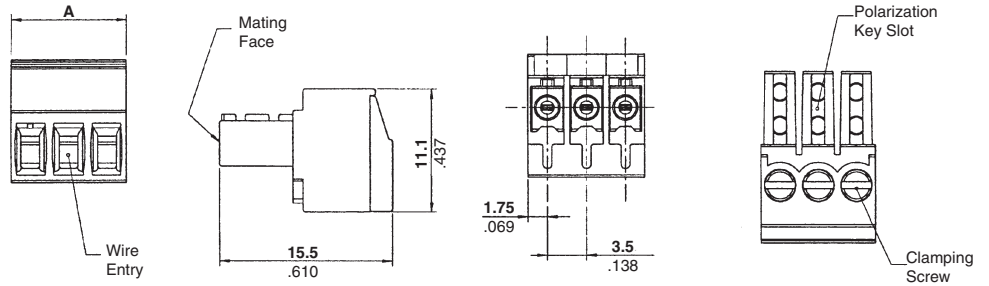
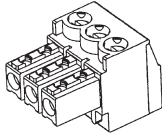

Suggested Screw Torque—2.7 in.-lb.

| No. of Positions | Dim. A | Part Numbers | |
|------------------|--------------|--------------|------------|
| | | Green | Blue |
| 2 | 7.0 [0.276] | 284506-2 | 796693-2 |
| 3 | 10.5 [0.413] | 284506-3 | 796693-3 |
| 4 | 14.0 [0.551] | 284506-4 | 796693-4 |
| 5 | 17.5 [0.689] | 284506-5 | 796693-5 |
| 6 | 21.0 [0.827] | 284506-6 | 796693-6 |
| 7 | 24.5 [0.965] | 284506-7 | 796693-7 |
| 8 | 28.0 [1.102] | 284506-8 | 796693-8 |
| 9 | 31.5 [1.240] | 284506-9 | 796693-9 |
| 10 | 35.0 [1.378] | 1-284506-0 | 1-796693-0 |
| 11 | 38.5 [1.516] | 1-284506-1 | 1-796693-1 |
| 12 | 42.0 [1.654] | 1-284506-2 | 1-796693-2 |
| 13 | 45.5 [1.791] | 1-284506-3 | 1-796693-3 |

| No. of Positions | Dim. A | Part Numbers | |
|------------------|--------------|--------------|------------|
| | | Green | Blue |
| 14 | 49.0 [1.929] | 1-284506-4 | 1-796693-4 |
| 15 | 52.5 [2.067] | 1-284506-5 | 1-796693-5 |
| 16 | 56.0 [2.205] | 1-284506-6 | 1-796693-6 |
| 17 | 59.5 [2.343] | 1-284506-7 | 1-796693-7 |
| 18 | 63.0 [2.450] | 1-284506-8 | 1-796693-8 |
| 19 | 66.5 [2.618] | 1-284506-9 | 1-796693-9 |
| 20 | 70.0 [2.756] | 2-284506-0 | 2-796693-0 |
| 21 | 73.5 [2.894] | 2-284506-1 | 2-796693-1 |
| 22 | 77.0 [3.031] | 2-284506-2 | 2-796693-2 |
| 23 | 80.5 [3.169] | 2-284506-3 | 2-796693-3 |
| 24 | 84.0 [3.307] | 2-284506-4 | 2-796693-4 |
| 25 | 87.5 [3.445] | 2-284506-5 | 2-796693-5 |

Note: BUCHANAN Terminal Block Series B52C3UxxT has been superseded/replaced with 796693-xx (blue).

Plug, Right-Angle, 3.81 mm Centerline Color – Green

UL Rating – 300 V, 11 A 14-30 AWG

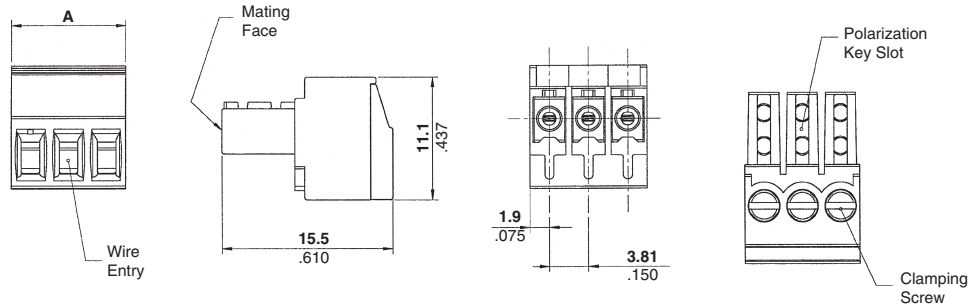
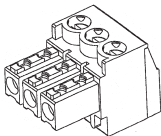

Suggested Screw Torque—2.7 in.-lb.

| No. of Positions | Dim. A | Part Numbers |
|------------------|--------------|--------------|
| 2 | 7.62 [0.30] | 284507-2 |
| 3 | 11.43 [0.45] | 284507-3 |
| 4 | 15.24 [0.60] | 284507-4 |
| 5 | 19.05 [0.75] | 284507-5 |
| 6 | 22.86 [0.90] | 284507-6 |
| 7 | 26.67 [1.05] | 284507-7 |
| 8 | 30.48 [1.20] | 284507-8 |
| 9 | 34.29 [1.35] | 284507-9 |
| 10 | 38.10 [1.50] | 1-284507-0 |
| 11 | 41.91 [1.65] | 1-284507-1 |
| 12 | 45.72 [1.80] | 1-284507-2 |
| 13 | 49.53 [1.95] | 1-284507-3 |

| No. of Positions | Dim. A | Part Numbers |
|------------------|--------------|--------------|
| 14 | 53.34 [2.10] | 1-284507-4 |
| 15 | 57.15 [2.25] | 1-284507-5 |
| 16 | 60.96 [2.40] | 1-284507-6 |
| 17 | 64.77 [2.55] | 1-284507-7 |
| 18 | 68.58 [2.70] | 1-284507-8 |
| 19 | 72.39 [2.85] | 1-284507-9 |
| 20 | 76.20 [3.00] | 2-284507-0 |
| 21 | 80.01 [3.15] | 2-284507-1 |
| 22 | 83.82 [3.30] | 2-284507-2 |
| 23 | 87.63 [3.45] | 2-284507-3 |
| 24 | 91.44 [3.60] | 2-284507-4 |
| 25 | 95.25 [3.75] | 2-284507-5 |

Note: All part numbers are RoHS Compliant.

Two-Piece Terminal Block Connectors (Continued)

Plug, Right-Angle, 5.0 mm Centerline Colors – See chart.

UL Rating – 300 V, 15 A 12-30 AWG

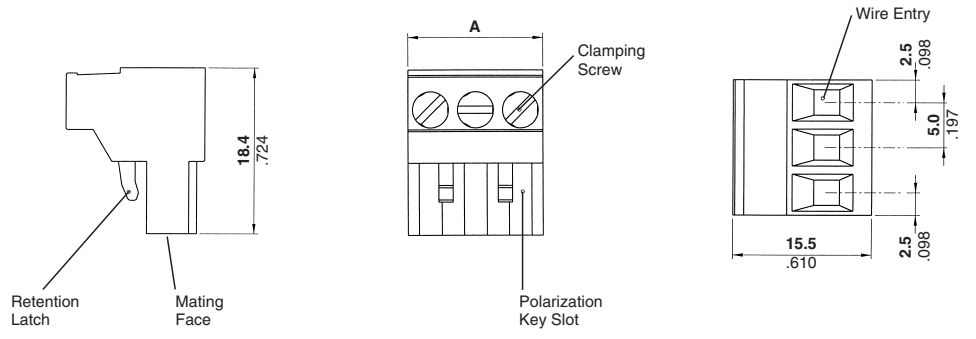
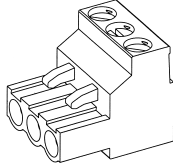

Suggested Screw Torque—
7.0 in.-lb.

| No. of Positions | Dim. A | Part Numbers | | | |
|------------------|--------------|--------------|------------|------------|------------|
| | | Gray | Green | Blue | Black |
| 2 | 10.0 [0.394] | 1546208-2 | 796640-2 | 796696-2 | 796641-2 |
| 3 | 15.0 [0.591] | 1546208-3 | 796640-3 | 796696-3 | 796641-3 |
| 4 | 20.0 [0.787] | 1546208-4 | 796640-4 | 796696-4 | 796641-4 |
| 5 | 25.0 [0.984] | 1546208-5 | 796640-5 | 796696-5 | 796641-5 |
| 6 | 30.0 [1.181] | 1546208-6 | 796640-6 | 796696-6 | 796641-6 |
| 7 | 35.0 [1.378] | 1546208-7 | 796640-7 | 796696-7 | 796641-7 |
| 8 | 40.0 [1.575] | 1546208-8 | 796640-8 | 796696-8 | 796641-8 |
| 9 | 45.0 [1.772] | 1546208-9 | 796640-9 | 796696-9 | 796641-9 |
| 10 | 50.0 [1.968] | 1-1546208-0 | 1-796640-0 | 1-796696-0 | 1-796641-0 |
| 11 | 55.0 [2.165] | 1-1546208-1 | 1-796640-1 | 1-796696-1 | 1-796641-1 |
| 12 | 60.0 [2.362] | 1-1546208-2 | 1-796640-2 | 1-796696-2 | 1-796641-2 |
| 13 | 65.0 [2.559] | 1-1546208-3 | 1-796640-3 | 1-796696-3 | 1-796641-3 |

| No. of Positions | Dim. A | Part Numbers | | | |
|------------------|---------------|--------------|------------|------------|------------|
| | | Gray | Green | Blue | Black |
| 14 | 70.0 [2.756] | 1-1546208-4 | 1-796640-4 | 1-796696-4 | 1-796641-4 |
| 15 | 75.0 [2.953] | 1-1546208-5 | 1-796640-5 | 1-796696-5 | 1-796641-5 |
| 16 | 80.0 [3.150] | 1-1546208-6 | 1-796640-6 | 1-796696-6 | 1-796641-6 |
| 17 | 85.0 [3.346] | 1-1546208-7 | 1-796640-7 | 1-796696-7 | 1-796641-7 |
| 18 | 90.0 [3.543] | 1-1546208-8 | 1-796640-8 | 1-796696-8 | 1-796641-8 |
| 19 | 95.0 [3.740] | 1-1546208-9 | 1-796640-9 | 1-796696-9 | 1-796641-9 |
| 20 | 100.0 [3.937] | 2-1546208-0 | 2-796640-0 | 2-796696-0 | 2-796641-0 |
| 21 | 105.0 [4.134] | 2-1546208-1 | 2-796640-1 | 2-796696-1 | 2-796641-1 |
| 22 | 110.0 [4.331] | 2-1546208-2 | 2-796640-2 | 2-796696-2 | 2-796641-2 |
| 23 | 115.0 [4.528] | 2-1546208-3 | 2-796640-3 | 2-796696-3 | 2-796641-3 |
| 24 | 120.0 [4.724] | 2-1546208-4 | 2-796640-4 | 2-796696-4 | 2-796641-4 |
| 25 | 125.0 [4.921] | 2-1546208-5 | 2-796640-5 | 2-796696-5 | 2-796641-5 |

Note: BUCHANAN Terminal Block Series B52C4UxxT has been replaced with 796696-xx (blue) and 796641-xx (black). RDI Terminal Block Series 5ESDV-xx has been replaced with 796640-xx (green) or 796641-xx (black).

Plug, Right-Angle, 5.08 mm Centerline Colors – See chart.

UL Rating – 300 V, 15 A 12-30 AWG

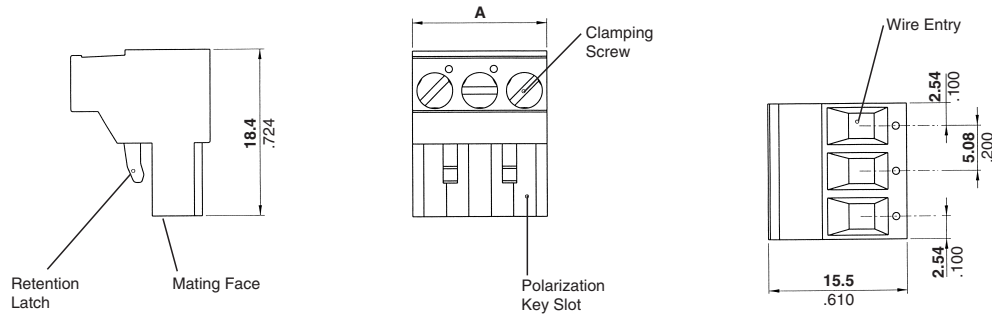
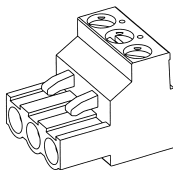

Suggested Screw Torque—
7.0 in.-lb.

| No. of Positions | Dim. A | Part Numbers | | |
|------------------|--------------|--------------|------------|------------|
| | | Gray | Green | Black |
| 2 | 10.16 [0.40] | 1546108-2 | 796634-2 | 796635-2 |
| 3 | 15.24 [0.60] | 1546108-3 | 796634-3 | 796635-3 |
| 4 | 20.32 [0.80] | 1546108-4 | 796634-4 | 796635-4 |
| 5 | 25.40 [1.00] | 1546108-5 | 796634-5 | 796635-5 |
| 6 | 30.48 [1.20] | 1546108-6 | 796634-6 | 796635-6 |
| 7 | 35.56 [1.40] | 1546108-7 | 796634-7 | 796635-7 |
| 8 | 40.64 [1.60] | 1546108-8 | 796634-8 | 796635-8 |
| 9 | 45.72 [1.80] | 1546108-9 | 796634-9 | 796635-9 |
| 10 | 50.80 [2.00] | 1-1546108-0 | 1-796634-0 | 1-796635-0 |
| 11 | 55.88 [2.20] | 1-1546108-1 | 1-796634-1 | 1-796635-1 |
| 12 | 60.96 [2.40] | 1-1546108-2 | 1-796634-2 | 1-796635-2 |
| 13 | 66.04 [2.60] | 1-1546108-3 | 1-796634-3 | 1-796635-3 |

| No. of Positions | Dim. A | Part Numbers | | |
|------------------|---------------|--------------|------------|------------|
| | | Gray | Green | Black |
| 14 | 71.12 [2.80] | 1-1546108-4 | 1-796634-4 | 1-796635-4 |
| 15 | 76.20 [3.00] | 1-1546108-5 | 1-796634-5 | 1-796635-5 |
| 16 | 81.28 [3.20] | 1-1546108-6 | 1-796634-6 | 1-796635-6 |
| 17 | 86.36 [3.40] | 1-1546108-7 | 1-796634-7 | 1-796635-7 |
| 18 | 91.44 [3.60] | 1-1546108-8 | 1-796634-8 | 1-796635-8 |
| 19 | 96.52 [3.80] | 1-1546108-9 | 1-796634-9 | 1-796635-9 |
| 20 | 101.60 [4.00] | 2-1546108-0 | 2-796634-0 | 2-796635-0 |
| 21 | 106.68 [4.20] | 2-1546108-1 | 2-796634-1 | 2-796635-1 |
| 22 | 111.76 [4.40] | 2-1546108-2 | 2-796634-2 | 2-796635-2 |
| 23 | 116.84 [4.60] | 2-1546108-3 | 2-796634-3 | 2-796635-3 |
| 24 | 121.92 [4.80] | 2-1546108-4 | 2-796634-4 | 2-796635-4 |
| 25 | 127.00 [5.00] | 2-1546108-5 | 2-796634-5 | 2-796635-5 |

Note: RDI Terminal Block Series 2ESDV-xx has been replaced with 796634-xx (green) and 796635-xx (black).



Note: All part numbers are RoHS Compliant.

Two-Piece Terminal Block Connectors (Continued)

**Plug, Right-Angle,
7.5 mm Centerline
Color – Green**

**UL Rating – 300 V, 15 A
12-30 AWG**

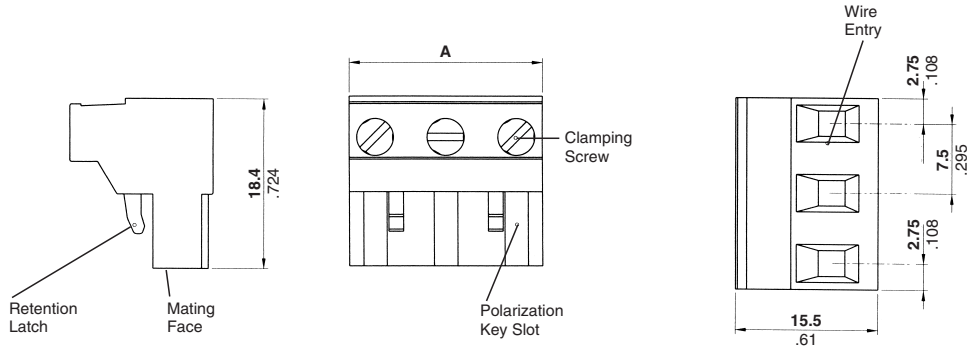
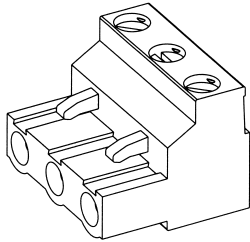

Suggested Screw Torque—
7.0 in.-lb.

| No. of Positions | Dim. A | Part Numbers |
|------------------|--------------|--------------|
| 2 | 13.0 [0.512] | 282959-2 |
| 3 | 20.5 [0.807] | 282959-3 |
| 4 | 28.0 [1.102] | 282959-4 |
| 5 | 35.5 [1.398] | 282959-5 |
| 6 | 43.0 [1.693] | 282959-6 |
| 7 | 50.5 [1.988] | 282959-7 |

| No. of Positions | Dim. A | Part Numbers |
|------------------|--------------|--------------|
| 8 | 58.0 [2.283] | 282959-8 |
| 9 | 65.5 [2.579] | 282959-9 |
| 10 | 73.0 [2.874] | 1-282959-0 |
| 11 | 80.5 [3.169] | 1-282959-1 |
| 12 | 88.0 [3.465] | 1-282959-2 |

**Plug, Right-Angle,
7.62 mm Centerline
Color – Green**

**UL Rating – 300 V, 15 A
12-30 AWG**

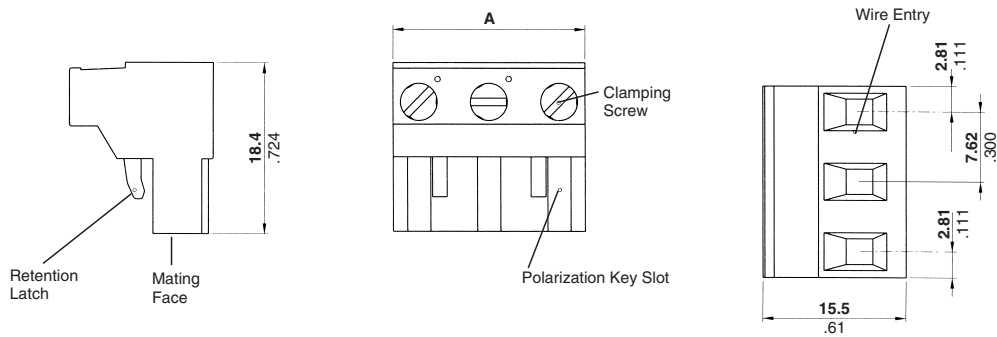
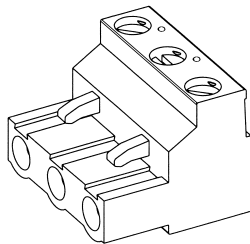

Suggested Screw Torque—
7.0 in.-lb.

| No. of Positions | Dim. A | Part Numbers |
|------------------|---------------|--------------|
| 2 | 13.24 [0.521] | 796981-2 |
| 3 | 20.86 [0.821] | 796981-3 |
| 4 | 28.48 [1.121] | 796981-4 |
| 5 | 36.10 [1.421] | 796981-5 |
| 6 | 43.72 [1.721] | 796981-6 |
| 7 | 51.34 [2.021] | 796981-7 |

| No. of Positions | Dim. A | Part Numbers |
|------------------|---------------|--------------|
| 8 | 58.96 [2.321] | 796981-8 |
| 9 | 66.58 [2.621] | 796981-9 |
| 10 | 74.20 [2.921] | 1-796981-0 |
| 11 | 81.82 [3.221] | 1-796981-1 |
| 12 | 89.44 [3.521] | 1-796981-2 |

Note: All part numbers are RoHS Compliant.

Two-Piece Terminal Block Connectors (Continued)

**Plug, Right-Angle,
10.0 mm Centerline
Color – Green**

**UL Rating – 600 V, 15 A
12-30 AWG**

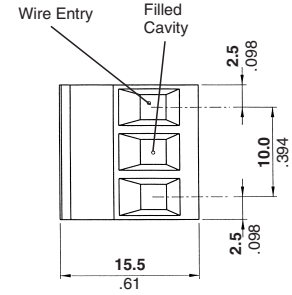
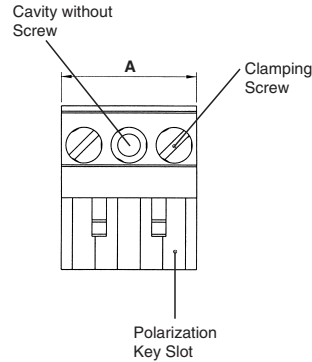
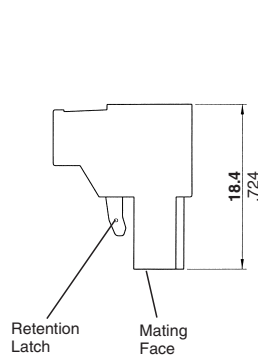
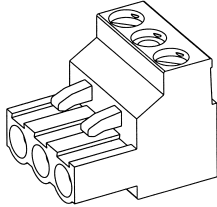

Suggested Screw Torque—
7.0 in.-lb.

| No. of Positions | Dim. A | Part Numbers |
|------------------|--------------|--------------|
| 2 | 15.0 [0.591] | 282808-2 |
| 3 | 25.0 [0.984] | 282808-3 |
| 4 | 35.0 [1.378] | 282808-4 |
| 5 | 45.0 [1.772] | 282808-5 |
| 6 | 55.0 [2.165] | 282808-6 |
| 7 | 65.0 [2.559] | 282808-7 |

| No. of Positions | Dim. A | Part Numbers |
|------------------|---------------|--------------|
| 8 | 75.0 [2.953] | 282808-8 |
| 9 | 85.0 [3.346] | 282808-9 |
| 10 | 95.0 [3.740] | 1-282808-0 |
| 11 | 105.0 [4.134] | 1-282808-1 |
| 12 | 115.0 [4.528] | 1-282808-2 |
| 13 | 125.0 [4.921] | 1-282808-3 |

**Plug, Right-Angle,
10.16 mm Centerline
Color – Green**

**UL Rating – 600 V, 15 A
12-30 AWG**

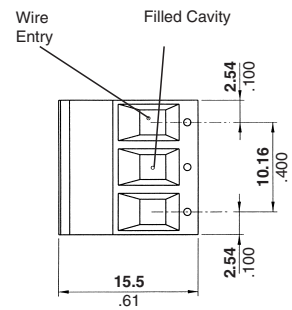
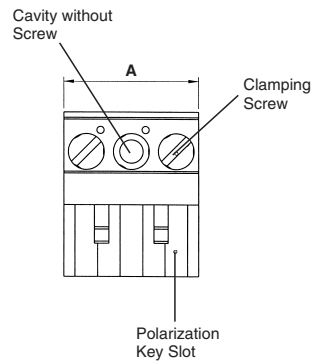
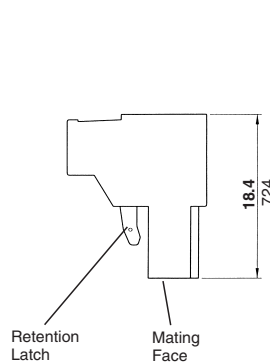
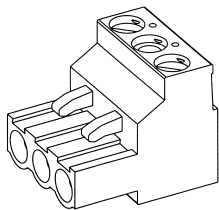

Suggested Screw Torque—
7.0 in.-lb.

| No. of Positions | Dim. A | Part Numbers |
|------------------|--------------|--------------|
| 2 | 15.24 [0.60] | 282809-2 |
| 3 | 25.40 [1.00] | 282809-3 |
| 4 | 35.56 [1.40] | 282809-4 |
| 5 | 45.72 [1.80] | 282809-5 |
| 6 | 55.88 [2.20] | 282809-6 |
| 7 | 66.04 [2.60] | 282809-7 |

| No. of Positions | Dim. A | Part Numbers |
|------------------|---------------|--------------|
| 8 | 76.20 [3.00] | 282809-8 |
| 9 | 86.36 [3.40] | 282809-9 |
| 10 | 96.52 [3.80] | 1-282809-0 |
| 11 | 106.68 [4.20] | 1-282809-1 |
| 12 | 116.84 [4.60] | 1-282809-2 |
| 13 | 127.00 [5.00] | 1-282809-3 |

Note: All part numbers are RoHS Compliant.

Two-Piece Terminal Block Connectors (Continued)

**Plug, Right-Angle w/Interlock,
3.81 mm Centerline
Color – Green**

**UL Rating – 150 V, 12 A
14-30 AWG**

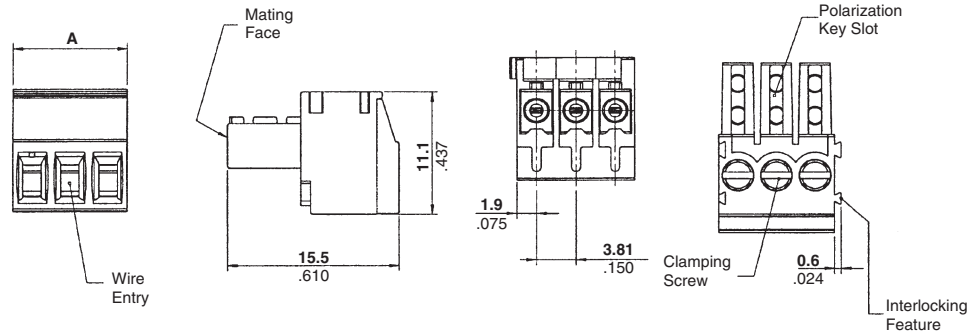
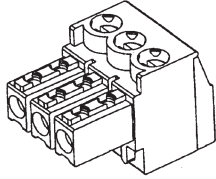

Suggested Screw Torque—
2.2 in.-lb.

| No. of Positions | Dim. A | Part Numbers |
|------------------|--------------|--------------|
| 2 | 7.62 [0.30] | 284509-2 |
| 3 | 11.43 [0.45] | 284509-3 |
| 4 | 15.24 [0.60] | 284509-4 |
| 5 | 19.05 [0.75] | 284509-5 |
| 6 | 22.86 [0.90] | 284509-6 |
| 7 | 26.67 [1.05] | 284509-7 |
| 8 | 30.48 [1.20] | 284509-8 |
| 9 | 34.29 [1.35] | 284509-9 |
| 10 | 38.10 [1.50] | 1-284509-0 |
| 11 | 41.91 [1.65] | 1-284509-1 |
| 12 | 45.72 [1.80] | 1-284509-2 |
| 13 | 49.53 [1.95] | 1-284509-3 |
| 14 | 53.34 [2.10] | 1-284509-4 |
| 15 | 57.15 [2.25] | 1-284509-5 |
| 16 | 60.96 [2.40] | 1-284509-6 |
| 17 | 64.77 [2.55] | 1-284509-7 |
| 18 | 68.58 [2.70] | 1-284509-8 |
| 19 | 72.39 [2.85] | 1-284509-9 |
| 20 | 86.20 [3.00] | 2-284509-0 |
| 21 | 80.01 [3.15] | 2-284509-1 |
| 22 | 83.82 [3.30] | 2-284509-2 |
| 23 | 87.63 [3.45] | 2-284509-3 |
| 24 | 91.44 [3.60] | 2-284509-4 |
| 25 | 95.25 [3.75] | 2-284509-5 |

Two-Piece Terminal Block Connectors (Continued)

Stacking Plug, Right-Angle with Interlock, 5.0 mm Centerline Color – Green

**UL Rating – 300 V, 15 A
12-30 AWG**

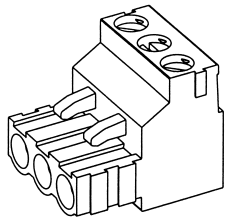

**Suggested Screw Torque—
7.0 in.-lb.**

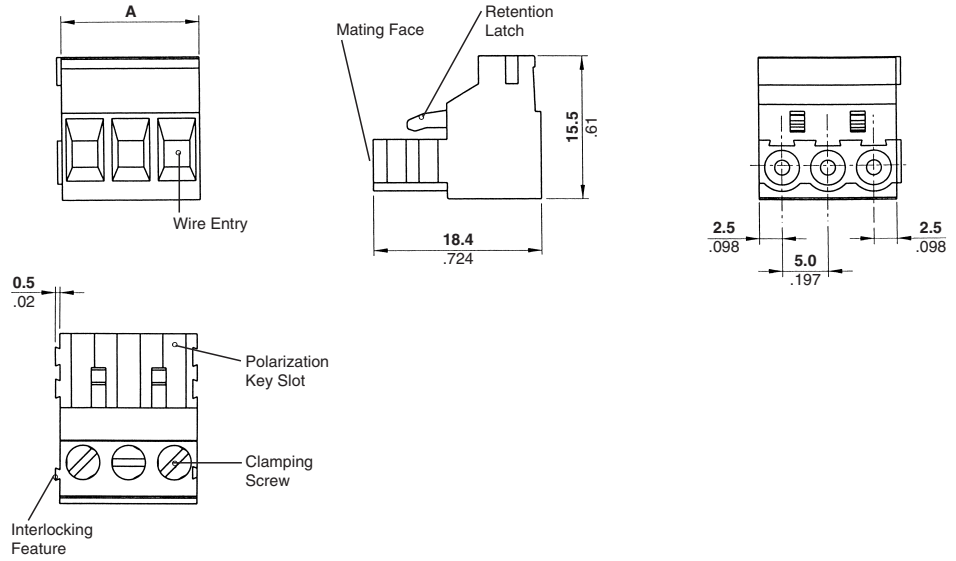

| No. of Positions | Dim. A | Part Numbers |
|------------------|-------------|--------------|
| 2 | 10.0 [.394] | 282805-2 |
| 3 | 15.0 [.591] | 282805-3 |
| 4 | 20.0 [.787] | 282805-4 |

Stacking Plug, Right-Angle with Interlock, 5.08 mm Centerline Color – Green

**UL Rating – 300 V, 15 A
12-30 AWG**

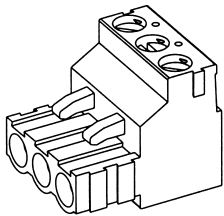

**Suggested Screw Torque—
7.0 in.-lb.**

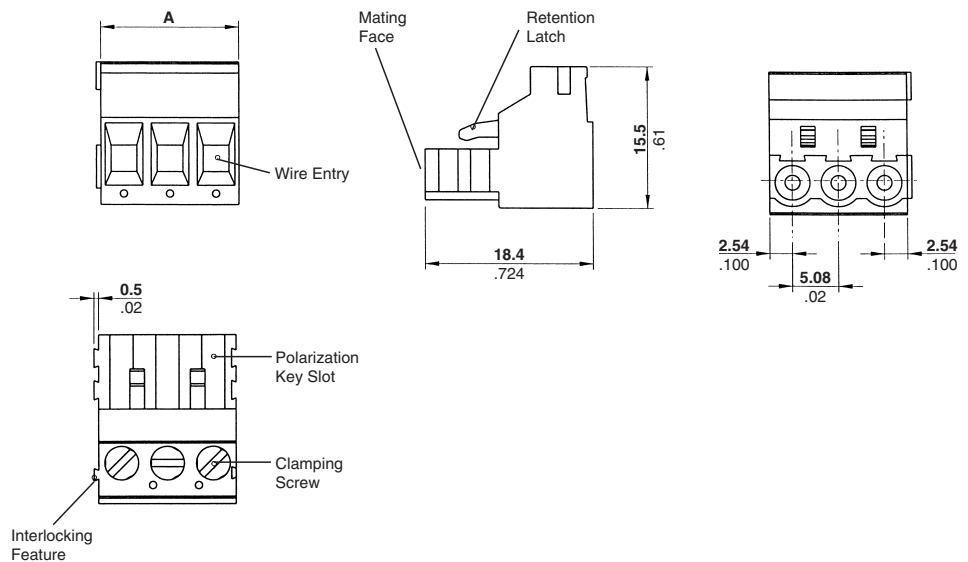

| No. of Positions | Dim. A | Part Numbers |
|------------------|--------------|--------------|
| 2 | 10.16 [.400] | 282807-2 |
| 3 | 15.24 [.600] | 282807-3 |
| 4 | 20.32 [.800] | 282807-4 |

Note: All part numbers are RoHS Compliant.

Straight Plugs

**Plug, Straight,
5.0 mm Centerline
Color – See chart.**

**UL Rating – 300 V, 15 A
12-30 AWG**

**Suggested Screw Torque—
7.0 in.-lbs.**

Left-Hand Version

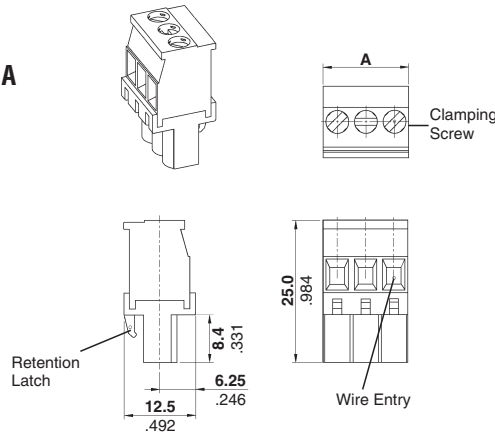

Right-Hand Version

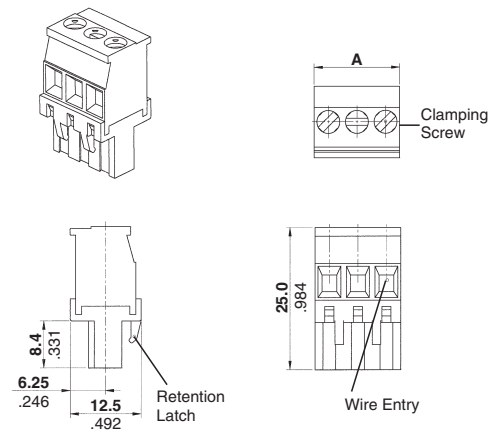

| No. of Positions | Dim. A | Part Numbers | | | | | |
|------------------|---------------|--------------|-------------|-------------|------------|-------------|-------------|
| | | Left-Hand | | | Right-Hand | | |
| | | Green | Black | Gray | Green | Black | Gray |
| 2 | 10.0 [.394] | 284040-2 | 1546118-2 | 1546223-2 | 284046-2 | 1546625-2 | 1546857-2 |
| 3 | 15.0 [.591] | 284040-3 | 1546118-3 | 1546223-3 | 284046-3 | 1546625-3 | 1546857-3 |
| 4 | 20.0 [.787] | 284040-4 | 1546118-4 | 1546223-4 | 284046-4 | 1546625-4 | 1546857-4 |
| 5 | 25.0 [.984] | 284040-5 | 1546118-5 | 1546223-5 | 284046-5 | 1546625-5 | 1546857-5 |
| 6 | 30.0 [1.181] | 284040-6 | 1546118-6 | 1546223-6 | 284046-6 | 1546625-6 | 1546857-6 |
| 7 | 35.0 [1.378] | 284040-7 | 1546118-7 | 1546223-7 | 284046-7 | 1546625-7 | 1546857-7 |
| 8 | 40.0 [1.575] | 284040-8 | 1546118-8 | 1546223-8 | 284046-8 | 1546625-8 | 1546857-8 |
| 9 | 45.0 [1.772] | 284040-9 | 1546118-9 | 1546223-9 | 284046-9 | 1546625-9 | 1546857-9 |
| 10 | 50.0 [1.968] | 1-284040-0 | 1-1546118-0 | 1-1546223-0 | 1-284046-0 | 1-1546625-0 | 1-1546857-0 |
| 11 | 55.0 [2.165] | 1-284040-1 | 1-1546118-1 | 1-1546223-1 | 1-284046-1 | 1-1546625-1 | 1-1546857-1 |
| 12 | 60.0 [2.362] | 1-284040-2 | 1-1546118-2 | 1-1546223-2 | 1-284046-2 | 1-1546625-2 | 1-1546857-2 |
| 13 | 65.0 [2.559] | 1-284040-3 | 1-1546118-3 | 1-1546223-3 | 1-284046-3 | 1-1546625-3 | 1-1546857-3 |
| 14 | 70.0 [2.756] | 1-284040-4 | 1-1546118-4 | 1-1546223-4 | 1-284046-4 | 1-1546625-4 | 1-1546857-4 |
| 15 | 75.0 [2.953] | 1-284040-5 | 1-1546118-5 | 1-1546223-5 | 1-284046-5 | 1-1546625-5 | 1-1546857-5 |
| 16 | 80.0 [3.150] | 1-284040-6 | 1-1546118-6 | 1-1546223-6 | 1-284046-6 | 1-1546625-6 | 1-1546857-6 |
| 17 | 85.0 [3.346] | 1-284040-7 | 1-1546118-7 | 1-1546223-7 | 1-284046-7 | 1-1546625-7 | 1-1546857-7 |
| 18 | 90.0 [3.543] | 1-284040-8 | 1-1546118-8 | 1-1546223-8 | 1-284046-8 | 1-1546625-8 | 1-1546857-8 |
| 19 | 95.0 [3.740] | 1-284040-9 | 1-1546118-9 | 1-1546223-9 | 1-284046-9 | 1-1546625-9 | 1-1546857-9 |
| 20 | 100.0 [3.937] | 2-284040-0 | 2-1546118-0 | 2-1546223-0 | 2-284046-0 | 2-1546625-0 | 2-1546857-0 |
| 21 | 105.0 [4.134] | 2-284040-1 | 2-1546118-1 | 2-1546223-1 | 2-284046-1 | 2-1546625-1 | 2-1546857-1 |
| 22 | 110.0 [4.331] | 2-284040-2 | 2-1546118-2 | 2-1546223-2 | 2-284046-2 | 2-1546625-2 | 2-1546857-2 |
| 23 | 115.0 [4.528] | 2-284040-3 | 2-1546118-3 | 2-1546223-3 | 2-284046-3 | 2-1546625-3 | 2-1546857-3 |
| 24 | 120.0 [4.724] | 2-284040-4 | 2-1546118-4 | 2-1546223-4 | 2-284046-4 | 2-1546625-4 | 2-1546857-4 |
| 25 | 125.0 [4.921] | 2-284040-5 | 2-1546118-5 | 2-1546223-5 | 2-284046-5 | 2-1546625-5 | 2-1546857-5 |

Note: All part numbers are RoHS Compliant.

Straight Plugs (Continued)

**Plug, Straight,
5.08 mm Centerline
Color – See chart.
UL Rating – 300 V, 15 A
12-30 AWG**

**Suggested Screw Torque—
7.0 in.-lbs.**

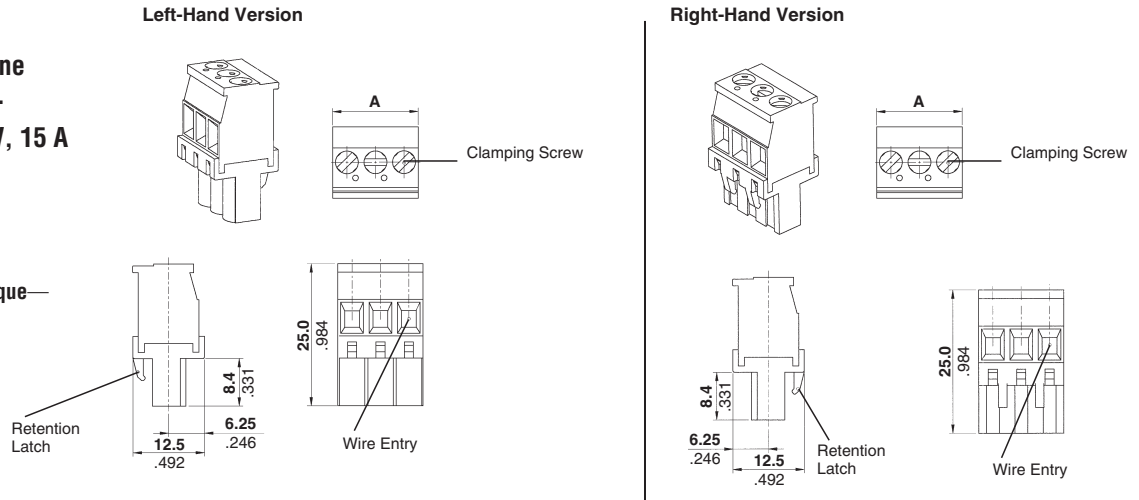

| No. of Positions | Dim. A | Part Numbers | | | | | |
|------------------|----------------|--------------|-------------|-------------|------------|-------------|-------------|
| | | Left-Hand | | | Right-Hand | | |
| | | Green | Black | Gray | Green | Black | Gray |
| 2 | 10.16 [.400] | 284041-2 | 1546105-2 | 1546224-2 | 284047-2 | 1546231-2 | 1546122-2 |
| 3 | 15.24 [.600] | 284041-3 | 1546105-3 | 1546224-3 | 284047-3 | 1546231-3 | 1546122-3 |
| 4 | 20.32 [.800] | 284041-4 | 1546105-4 | 1546224-4 | 284047-4 | 1546231-4 | 1546122-4 |
| 5 | 25.40 [1.000] | 284041-5 | 1546105-5 | 1546224-5 | 284047-5 | 1546231-5 | 1546122-5 |
| 6 | 30.48 [1.200] | 284041-6 | 1546105-6 | 1546224-6 | 284047-6 | 1546231-6 | 1546122-6 |
| 7 | 35.56 [1.400] | 284041-7 | 1546105-7 | 1546224-7 | 284047-7 | 1546231-7 | 1546122-7 |
| 8 | 40.64 [1.600] | 284041-8 | 1546105-8 | 1546224-8 | 284047-8 | 1546231-8 | 1546122-8 |
| 9 | 45.72 [1.800] | 284041-9 | 1546105-9 | 1546224-9 | 284047-9 | 1546231-9 | 1546122-9 |
| 10 | 50.80 [2.000] | 1-284041-0 | 1-1546105-0 | 1-1546224-0 | 1-284047-0 | 1-1546231-0 | 1-1546122-0 |
| 11 | 55.88 [2.200] | 1-284041-1 | 1-1546105-1 | 1-1546224-1 | 1-284047-1 | 1-1546231-1 | 1-1546122-1 |
| 12 | 60.96 [2.400] | 1-284041-2 | 1-1546105-2 | 1-1546224-2 | 1-284047-2 | 1-1546231-2 | 1-1546122-2 |
| 13 | 66.04 [2.600] | 1-284041-3 | 1-1546105-3 | 1-1546224-3 | 1-284047-3 | 1-1546231-3 | 1-1546122-3 |
| 14 | 71.12 [2.800] | 1-284041-4 | 1-1546105-4 | 1-1546224-4 | 1-284047-4 | 1-1546231-4 | 1-1546122-4 |
| 15 | 76.20 [3.000] | 1-284041-5 | 1-1546105-5 | 1-1546224-5 | 1-284047-5 | 1-1546231-5 | 1-1546122-5 |
| 16 | 81.28 [3.200] | 1-284041-6 | 1-1546105-6 | 1-1546224-6 | 1-284047-6 | 1-1546231-6 | 1-1546122-6 |
| 17 | 86.36 [3.400] | 1-284041-7 | 1-1546105-7 | 1-1546224-7 | 1-284047-7 | 1-1546231-7 | 1-1546122-7 |
| 18 | 91.44 [3.600] | 1-284041-8 | 1-1546105-8 | 1-1546224-8 | 1-284047-8 | 1-1546231-8 | 1-1546122-8 |
| 19 | 96.52 [3.800] | 1-284041-9 | 1-1546105-9 | 1-1546224-9 | 1-284047-9 | 1-1546231-9 | 1-1546122-9 |
| 20 | 101.60 [4.000] | 2-284041-0 | 2-1546105-0 | 2-1546224-0 | 2-284047-0 | 2-1546231-0 | 2-1546122-0 |
| 21 | 106.68 [4.200] | 2-284041-1 | 2-1546105-1 | 2-1546224-1 | 2-284047-1 | 2-1546231-1 | 2-1546122-1 |
| 22 | 111.76 [4.400] | 2-284041-2 | 2-1546105-2 | 2-1546224-2 | 2-284047-2 | 2-1546231-2 | 2-1546122-2 |
| 23 | 116.84 [4.600] | 2-284041-3 | 2-1546105-3 | 2-1546224-3 | 2-284047-3 | 2-1546231-3 | 2-1546122-3 |
| 24 | 121.92 [4.800] | 2-284041-4 | 2-1546105-4 | 2-1546224-4 | 2-284047-4 | 2-1546231-4 | 2-1546122-4 |
| 25 | 127.00 [5.000] | 2-284041-5 | 2-1546105-5 | 2-1546224-5 | 2-284047-5 | 2-1546231-5 | 2-1546122-5 |



Note: All part numbers are RoHS Compliant.

Straight Plugs (Continued)

**Plug, Straight,
7.5 mm and 10.0 mm Centerline
Color – Green**

**UL Rating – 300 V, 15 A
12-30 AWG**

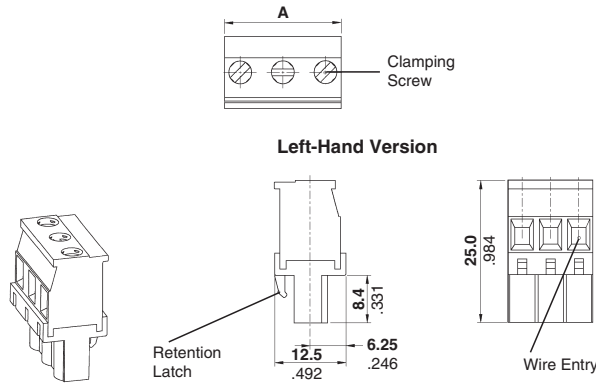

Suggested Screw Torque—7.0 in.-lbs.

| No. of Positions | Dim. A | 7.5 mm Centerline Part Numbers | |
|------------------|--------------|--------------------------------|------------|
| | | Wire Entry | |
| | | Left-Hand | Right-Hand |
| 2 | 13.0 [.512] | 284042-2 | |
| 3 | 20.5 [.807] | 284042-3 | |
| 4 | 28.0 [1.102] | 284042-4 | |
| 5 | 35.5 [1.398] | 284042-5 | |
| 6 | 43.0 [1.693] | 284042-6 | |
| 7 | 50.5 [1.988] | 284042-7 | |
| 8 | 58.0 [2.283] | 284042-8 | |
| 9 | 65.5 [2.579] | 284042-9 | |
| 10 | 73.0 [2.874] | 1-284042-0 | |
| 11 | 80.5 [3.169] | 1-284042-1 | |
| 12 | 88.0 [3.465] | 1-284042-2 | |

| No. of Positions | Dim. A | 10.0 mm Centerline Part Numbers | |
|------------------|---------------|---------------------------------|------------|
| | | Wire Entry | |
| | | Left-Hand | Right-Hand |
| 2 | 15.0 [0.591] | 284044-2 | |
| 3 | 25.0 [0.984] | 284044-3 | |
| 4 | 35.0 [1.378] | 284044-4 | |
| 5 | 45.0 [1.772] | 284044-5 | |
| 6 | 55.0 [2.165] | 284044-6 | |
| 7 | 65.0 [2.559] | 284044-7 | |
| 8 | 75.0 [2.953] | 284044-8 | |
| 9 | 85.0 [3.346] | 284044-9 | |
| 10 | 95.0 [3.740] | 1-284044-0 | |
| 11 | 105.0 [4.134] | 1-284044-1 | |
| 12 | 115.0 [4.528] | 1-284044-2 | |
| 13 | 125.0 [4.921] | 1-284044-3 | |

**Plug, Straight,
7.62 mm and 10.16 mm Centerline**

**UL Rating – 300 V, 15 A
12-30 AWG**

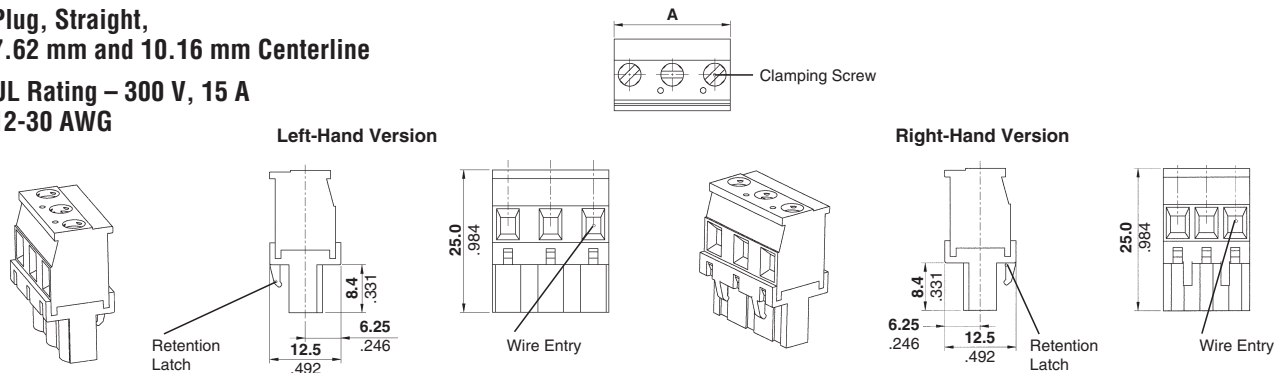

Suggested Screw Torque—7.0 in.-lbs.

| No. of Positions | Dim. A | 7.62 mm Centerline Part Numbers | | |
|------------------|---------------|---------------------------------|-------------|------------|
| | | Wire Entry | | |
| | | Left-Hand | Black | Right-Hand |
| 2 | 13.24 [.521] | 284043-2 | 1546935-2 | 284049-2 |
| 3 | 20.86 [.821] | 284043-3 | 1546935-3 | 284049-3 |
| 4 | 28.48 [1.121] | 284043-4 | 1546935-4 | 284049-4 |
| 5 | 36.10 [1.421] | 284043-5 | 1546935-5 | 284049-5 |
| 6 | 43.72 [1.721] | 284043-6 | 1546935-6 | 284049-6 |
| 7 | 51.34 [2.021] | 284043-7 | 1546935-7 | 284049-7 |
| 8 | 58.96 [2.321] | 284043-8 | 1546935-8 | 284049-8 |
| 9 | 66.58 [2.621] | 284043-9 | 1546935-9 | 284049-9 |
| 10 | 74.20 [2.921] | 1-284043-0 | 1-1546935-0 | 1-284049-0 |
| 11 | 81.82 [3.221] | 1-284043-1 | 1-1546935-1 | 1-284049-1 |
| 12 | 89.44 [3.521] | 1-284043-2 | — | 1-284049-2 |

| No. of Positions | Dim. A | 10.16 mm Centerline Part Numbers | | |
|------------------|----------------|----------------------------------|------------|-------------|
| | | Wire Entry | | |
| | | Left-Hand | Green | Right-Hand |
| 2 | 15.24 [0.600] | 284045-2 | 284051-2 | 1776538-2 |
| 3 | 25.40 [1.000] | 284045-3 | 284051-3 | 1776538-3 |
| 4 | 35.56 [1.400] | 284045-4 | 284051-4 | 1776538-4 |
| 5 | 45.72 [1.800] | 284045-5 | 284051-5 | 1776538-5 |
| 6 | 55.88 [2.200] | 284045-6 | 284051-6 | 1776538-6 |
| 7 | 66.04 [2.600] | 284045-7 | 284051-7 | 1776538-7 |
| 8 | 76.20 [3.000] | 284045-8 | 284051-8 | 1776538-8 |
| 9 | 86.36 [3.400] | 284045-9 | 284051-9 | 1776538-9 |
| 10 | 96.52 [3.800] | 1-284045-0 | 1-284051-0 | 1-1776538-0 |
| 11 | 106.68 [4.200] | 1-284045-1 | 1-284051-1 | 1-1776538-1 |
| 12 | 116.84 [4.600] | 1-284045-2 | 1-284051-2 | 1-1776538-2 |
| 13 | 127.00 [5.000] | 1-284045-3 | 1-284051-3 | — |

Note: All part numbers are RoHS Compliant.

Unshrouded Straight Pin Headers

Unshrouded Straight Pin Headers, 5.0 mm Centerline Color – Black UL Rating – 300 V, 12 A

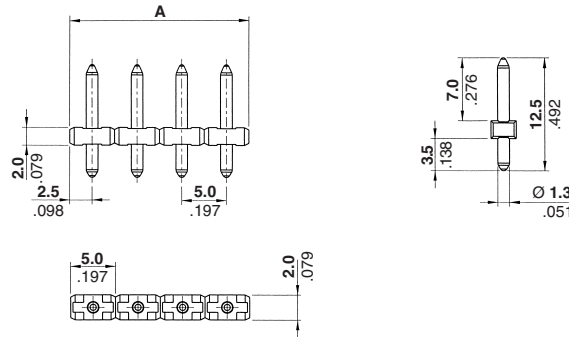
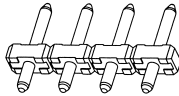

Recommended PC Board Layout

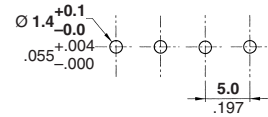

| No. of Positions | Dim. A | Part Numbers* |
|------------------|--------------|---------------|
| 2 | 10.0 [.394] | 1546931-2 |
| 3 | 15.0 [.591] | 1546931-3 |
| 4 | 20.0 [.787] | 1546931-4 |
| 5 | 25.0 [.984] | 1546931-5 |
| 6 | 30.0 [1.181] | 1546931-6 |
| 7 | 35.0 [1.378] | 1546931-7 |
| 8 | 40.0 [1.575] | 1546931-8 |
| 9 | 45.0 [1.772] | 1546931-9 |
| 10 | 50.0 [1.968] | 1-1546931-0 |
| 11 | 55.0 [2.165] | 1-1546931-1 |
| 12 | 60.0 [2.362] | 1-1546931-2 |
| 13 | 65.0 [2.559] | 1-1546931-3 |

| No. of Positions | Dim. A | Part Numbers* |
|------------------|---------------|---------------|
| 14 | 70.0 [2.756] | 1-1546931-4 |
| 15 | 75.0 [2.953] | 1-1546931-5 |
| 16 | 80.0 [3.150] | 1-1546931-6 |
| 17 | 85.0 [3.346] | 1-1546931-7 |
| 18 | 90.0 [3.543] | 1-1546931-8 |
| 19 | 95.0 [3.740] | 1-1546931-9 |
| 20 | 100.0 [3.937] | 2-1546931-0 |
| 21 | 105.0 [4.134] | 2-1546931-1 |
| 22 | 110.0 [4.331] | 2-1546931-2 |
| 23 | 115.0 [4.528] | 2-1546931-3 |
| 24 | 120.0 [4.724] | 2-1546931-4 |
| 25 | 125.0 [4.921] | 2-1546931-5 |

Note: Mate with Special Plug Connectors on pages 86 and 87.
*Wave solder process capable to 265°C [509°F] for 10 seconds.

Unshrouded Straight Pin Headers, 10.0 mm Centerline Color – Black UL Rating – 300 V, 12 A

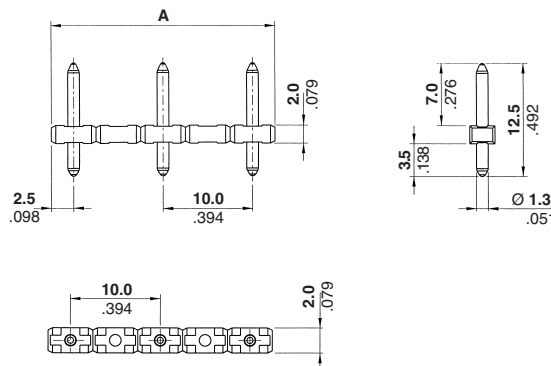
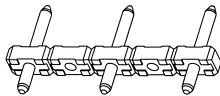

Recommended PC Board Layout

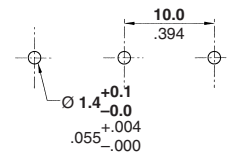

| No. of Positions | Dim. A | Part Numbers* |
|------------------|--------------|---------------|
| 2 | 15.0 [.591] | 1546932-2 |
| 3 | 25.0 [.984] | 1546932-3 |
| 4 | 35.0 [1.378] | 1546932-4 |
| 5 | 45.0 [1.772] | 1546932-5 |
| 6 | 55.0 [2.165] | 1546932-6 |

Note: Mate with Special Plug Connectors on page 88.
*Wave solder process capable to 265°C [509°F] for 10 seconds.

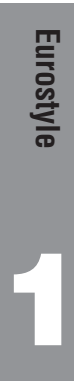

Note: All part numbers are RoHS Compliant.

Special Plug Connectors

Special 90°/180° Plug Connectors, 5.0 mm Centerline Color – See chart.

UL Rating – 300 V, 12 A 14-30 AWG

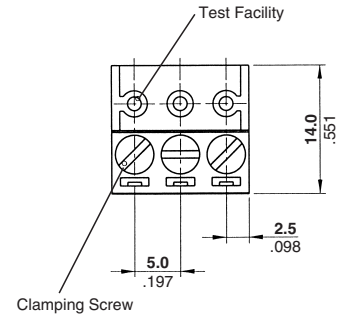
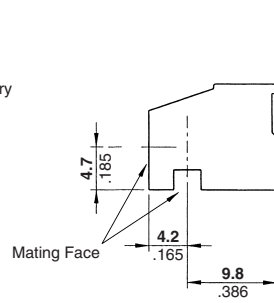
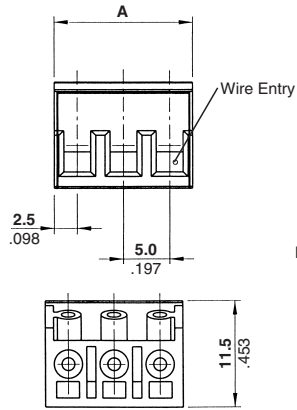
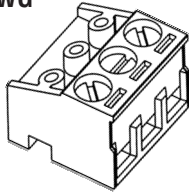

Suggested Screw Torque—6.0 in.-lbs.

| No. of Positions | Dim. A | Part Numbers | |
|------------------|--------------|--------------|-------------|
| | | Green | Black |
| 2 | 10.0 [.394] | 282830-2 | 1546018-2 |
| 3 | 15.0 [.591] | 282830-3 | 1546018-3 |
| 4 | 20.0 [.787] | 282830-4 | 1546018-4 |
| 5 | 25.0 [.984] | 282830-5 | 1546018-5 |
| 6 | 30.0 [1.181] | 282830-6 | 1546018-6 |
| 7 | 35.0 [1.378] | 282830-7 | 1546018-7 |
| 8 | 40.0 [1.575] | 282830-8 | 1546018-8 |
| 9 | 45.0 [1.772] | 282830-9 | 1546018-9 |
| 10 | 50.0 [1.968] | 1-282830-0 | 1-1546018-0 |
| 11 | 55.0 [2.165] | 1-282830-1 | 1-1546018-1 |
| 12 | 60.0 [2.362] | 1-282830-2 | 1-1546018-2 |
| 13 | 65.0 [2.559] | 1-282830-4 | 1-1546018-3 |

Note: Mate only with 1546931 (black) pin headers.

| No. of Positions | Dim. A | Part Numbers | |
|------------------|---------------|--------------|-------------|
| | | Green | Black |
| 14 | 70.0 [.591] | 1-282830-5 | 1-1546018-4 |
| 15 | 75.0 [.787] | 1-282830-6 | 1-1546018-5 |
| 16 | 80.0 [.984] | 1-282830-7 | 1-1546018-6 |
| 17 | 85.0 [1.181] | 1-282830-8 | 1-1546018-7 |
| 18 | 90.0 [1.378] | 1-282830-9 | 1-1546018-8 |
| 19 | 95.0 [1.575] | 2-282830-0 | 1-1546018-9 |
| 20 | 100.0 [1.772] | 2-282830-1 | 2-1546018-0 |
| 21 | 105.0 [1.968] | 2-282830-2 | 2-1546018-1 |
| 22 | 110.0 [2.165] | 2-282830-3 | 2-1546018-2 |
| 23 | 115.0 [2.362] | 2-282830-4 | 2-1546018-3 |
| 24 | 120.0 [2.362] | 2-282830-5 | 2-1546018-4 |
| 25 | 125.0 [2.362] | 2-282830-6 | 2-1546018-5 |

Special 90°/270° Plug Connectors, 5.0 mm Centerline Color – Gray

UL Rating – 300 V, 12 A 14-30 AWG

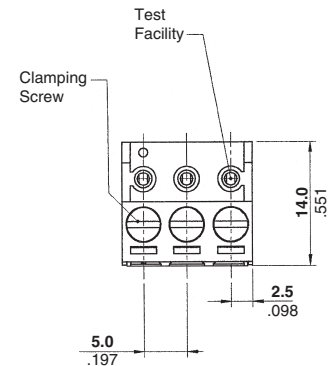
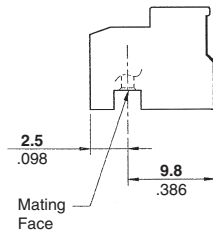
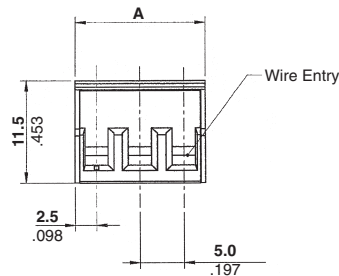
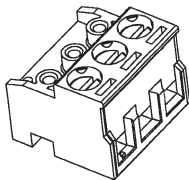

Suggested Screw Torque—6.0 in.-lbs.

| No. of Positions | Dim. A | Part Numbers |
|------------------|--------------|--------------|
| | | |
| 2 | 10.0 [.394] | 1546226-2 |
| 3 | 15.0 [.591] | 1546226-3 |
| 4 | 20.0 [.787] | 1546226-4 |
| 5 | 25.0 [.984] | 1546226-5 |
| 6 | 30.0 [1.181] | 1546226-6 |
| 7 | 35.0 [1.378] | 1546226-7 |
| 8 | 40.0 [1.575] | 1546226-8 |
| 9 | 45.0 [1.772] | 1546226-9 |
| 10 | 50.0 [1.968] | 1-1546226-0 |
| 11 | 55.0 [2.165] | 1-1546226-1 |
| 12 | 60.0 [2.362] | 1-1546226-2 |
| 13 | 65.0 [2.559] | 1-1546226-3 |

Note: Mate only with 1546931 (black) pin headers.

| No. of Positions | Dim. A | Part Numbers |
|------------------|---------------|--------------|
| | | |
| 14 | 70.0 [.591] | 1-1546226-4 |
| 15 | 75.0 [.787] | 1-1546226-5 |
| 16 | 80.0 [.984] | 1-1546226-6 |
| 17 | 85.0 [1.181] | 1-1546226-7 |
| 18 | 90.0 [1.378] | 1-1546226-8 |
| 19 | 95.0 [1.575] | 1-1546226-9 |
| 20 | 100.0 [1.772] | 2-1546226-0 |
| 21 | 105.0 [1.968] | 2-1546226-1 |
| 22 | 110.0 [2.165] | 2-1546226-2 |
| 23 | 115.0 [2.362] | 2-1546226-3 |
| 24 | 120.0 [2.362] | 2-1546226-4 |
| 25 | 125.0 [2.362] | 2-1546226-5 |

Note: All part numbers are RoHS Compliant.

Special Plug Connectors with Latch

Special 90°/270° Plug Connectors with Latch, 5.0 mm Centerline Color – Green

**UL Rating – 300 V, 12 A
14-30 AWG**

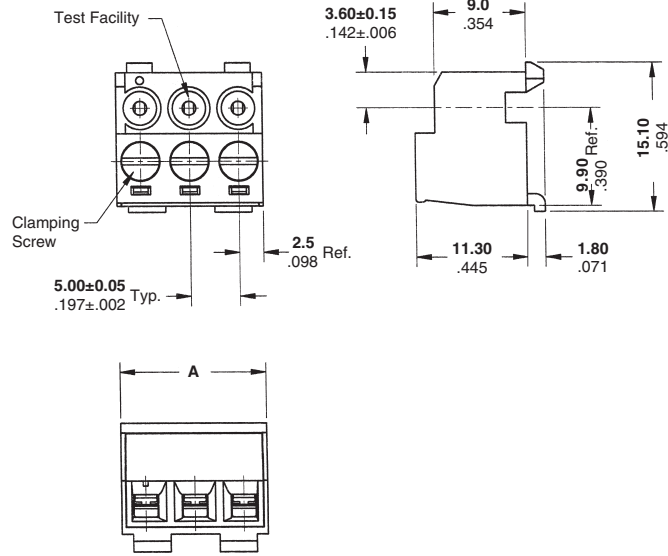
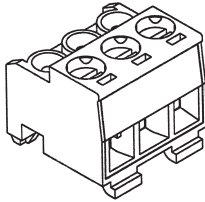

Suggested Screw Torque—6.0 in.-lbs.

| No. of Positions | Dimension A | Part Numbers |
|------------------|--------------|--------------|
| 2 | 10.0 [0.394] | 1546173-2 |
| 3 | 15.0 [0.591] | 1546173-3 |
| 4 | 20.0 [0.787] | 1546173-4 |
| 5 | 25.0 [0.984] | 1546173-5 |
| 6 | 30.0 [1.181] | 1546173-6 |
| 7 | 35.0 [1.378] | 1546173-7 |
| 8 | 40.0 [1.575] | 1546173-8 |
| 9 | 45.0 [1.772] | 1546173-9 |
| 10 | 50.0 [1.969] | 1-1546173-0 |
| 11 | 55.0 [2.165] | 1-1546173-1 |
| 12 | 60.0 [2.362] | 1-1546173-2 |

Note: Mate only with 1546931 (black) pin headers.



Note: All part numbers are RoHS Compliant.

Special Plug Connectors

Special 90°/180° Plug Connectors, 10.0 mm Centerline Color – Green
UL Rating – 600 V, 12 A
14-30 AWG

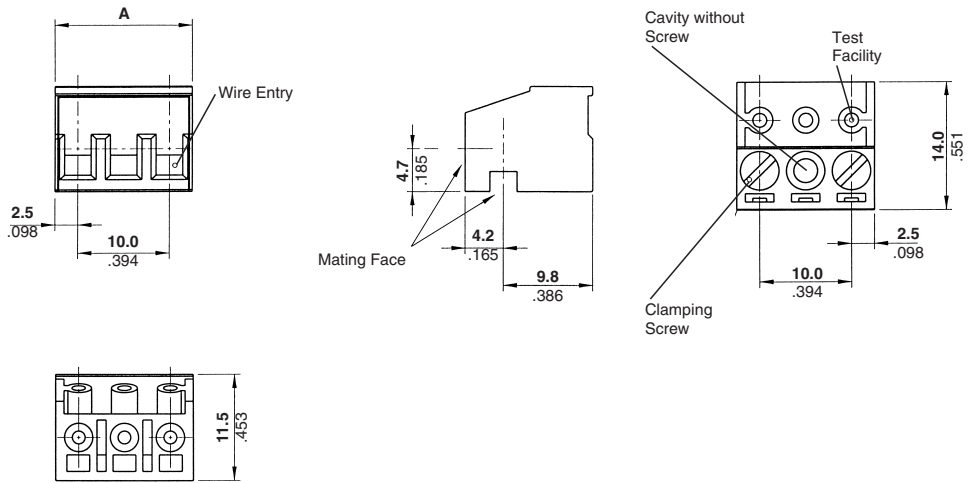
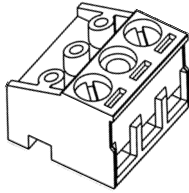

Suggested Screw Torque—6.0 in.-lbs.

| No. of Positions | Dim. A | Part Numbers |
|------------------|--------------|--------------|
| 2 | 15.0 [.591] | 282831-2 |
| 3 | 25.0 [.984] | 282831-3 |
| 4 | 35.0 [1.378] | 282831-4 |
| 5 | 45.0 [1.772] | 282831-5 |
| 6 | 55.0 [2.165] | 282831-6 |

Note: Mate only with 1546932 pin headers.

Note: All part numbers are RoHS Compliant.

Flush-Mount Connectors

5 mm Pitch

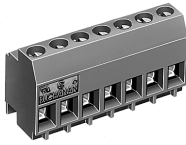

B51C4U (universal mounting)

A DIM
5 mm: A = N x 5
N = # of Poles

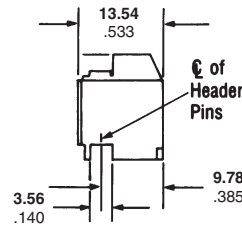
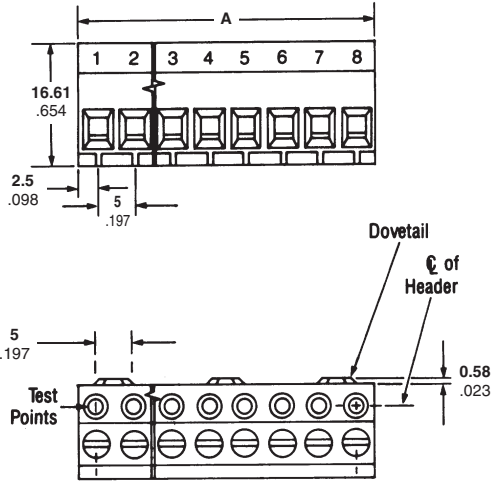

5 mm Flush-Mount Plug-In Connectors with Cage Clamp Series B51C4 (Mate with Series B71N4 Pin Headers)

Material & Finish

Housing Material—Polyamide, Type 6/6

Flammability—UL94V-0

Color—Black

Wire Entry Contact and Spring—Phosphor bronze, tin plated

Wire Cage—Hardened steel, zinc plated, yellow chromate treated

Screw—M2.5 x 6.2mm, steel, zinc plated, clear chromate treated

Mechanical Properties

Pitch (terminal spacing)—5mm

Wire Strip Length—6.4mm

Recommended Tightening Torque—0.5Nm [4.4 in-lbs]

Electrical Properties

Maximum Current—15A

Operating Voltage—300V (5mm)

Wire Range—12-30 AWG

Dielectric Withstand—2200V (5mm)

Environmental Properties

Operating Temperature Range—-60°C to +105°C [-76°F to +221°F]

| No. of Positions | 5mm Universal | |
|------------------|---------------|----------------|
| | Part Number | Catalog Number |
| 2 | 1437426-1 | B51C4U02T |
| 3 | 1437426-3 | B51C4U03T |
| 4 | 1437426-9 | B51C4U04T |
| 5 | 1-1437426-3 | B51C4U05T |
| 6 | 1-1437426-6 | B51C4U06T |
| 7 | 2-1437426-0 | B51C4U07T |
| 8 | 2-1437426-5 | B51C4U08T |
| 9 | 2-1437426-8 | B51C4U09T |
| 10 | 3-1437426-2 | B51C4U10T |
| 11 | 3-1437426-6 | B51C4U11T |
| 12 | 3-1437426-9 | B51C4U12T |
| 13 | 4-1437426-6 | B51C4U13T |
| 14 | 4-1437426-9 | B51C4U14T |
| 15 | 5-1437426-1 | B51C4U15T |
| 16 | 5-1437426-3 | B51C4U16T |
| 17 | — | B51C4U17T |
| 18 | 5-1437426-6 | B51C4U18T |
| 19 | — | B51C4U19T |
| 20 | 5-1437426-7 | B51C4U20T |
| 21 | — | B51C4U21T |
| 22 | 5-1437426-8 | B51C4U22T |
| 23 | — | B51C4U23T |
| 24 | 5-1437426-9 | B51C4U24T |

Note: All part numbers are RoHS Compliant.

Flush-Mount Pin Headers

5 mm Pitch



5 mm Flush-Mount Pin Headers Series B71N4 (Mate with Series B51C4 Connectors)

Material & Finish

Housing Material—Liquid crystal polymer

Flammability—UL94V-0

Color—Black

Solder Pin—Phosphor bronze, tin plated

Mechanical Properties

Pitch (Pin Spacing)—5mm

Recommended PCB Hole Dia.—1.7mm

Electrical Properties

Maximum Current—15A

Operating Voltage—300V (5mm)

Environmental Properties

Operating Temperature Range—-30°C to +105°C [-22°F to 221°F] Tin contact system

(Vertical Solder Pins)

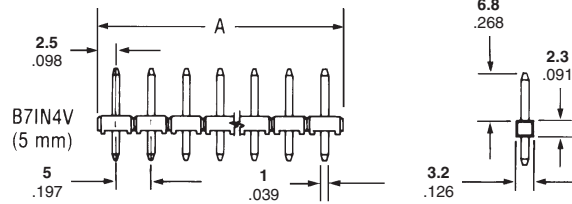

Series B51C4 Plug-in Connector

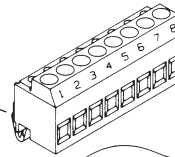

Series B71N4 Vertical Pin Header

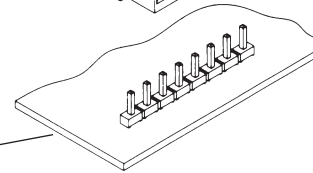

| No. of Positions | Dimension A | Part Number | Catalog Number |
|------------------|----------------|-------------|----------------|
| 2 | 10.00 [.394] | 1776452-2 | B71N4V02T |
| 3 | 15.00 [.591] | 1776452-3 | B71N4V03T |
| 4 | 15.00 [.591] | 1776452-4 | B71N4V04T |
| 5 | 25.00 [.984] | 1776452-5 | B71N4V05T |
| 6 | 30.00 [1.181] | 1776452-6 | B71N4V06T |
| 7 | 35.00 [1.378] | 1776452-7 | B71N4V07T |
| 8 | 40.00 [1.575] | 1776452-8 | B71N4V08T |
| 9 | 45.00 [1.772] | 1776452-9 | B71N4V09T |
| 10 | 50.00 [1.969] | 1-1776452-0 | B71N4V10T |
| 11 | 55.00 [2.165] | 1-1776452-1 | B71N4V11T |
| 12 | 60.00 [2.362] | 1-1776452-2 | B71N4V12T |
| 13 | 65.00 [2.559] | 1-1776452-3 | B71N4V13T |
| 14 | 70.00 [2.756] | 1-1776452-4 | B71N4V14T |
| 15 | 75.00 [2.953] | 1-1776452-5 | B71N4V15T |
| 16 | 80.00 [3.150] | 1-1776452-6 | B71N4V16T |
| 17 | 85.00 [3.346] | 1-1776452-7 | B71N4V17T |
| 18 | 90.00 [3.543] | 1-1776452-8 | B71N4V18T |
| 19 | — | — | B71N4V19T |
| 20 | 100.00 [3.937] | 2-1776452-0 | B71N4V20T |
| 21 | — | — | B71N4V21T |
| 22 | 110.00 [4.331] | 2-1776452-2 | B71N4V22T |
| 23 | — | — | B71N4V23T |
| 24 | 120.00 [4.724] | 2-1776452-4 | B71N4V24T |



Note: All part numbers are RoHS Compliant.

Flush-Mount Connectors

5.08 mm Pitch



B51C8U (universal mounting)

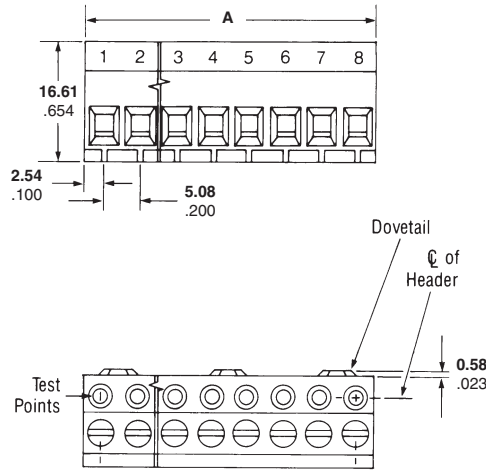

5.08 mm Flush-Mount Plug-In Connectors with Cage Clamp Series B51C8 (Mate with Series B71N8 Pin Headers)

Material & Finish

Housing Material—Polyamide, Type 6/6

Flammability—UL94V-0

Color—Blue

Wire Entry Contact and Spring—Phosphor bronze, tin plated

Wire Cage—Hardened steel, zinc plated, yellow chromate treated

Screw—M2.5 x 6.2mm, steel, zinc plated, clear chromate treated

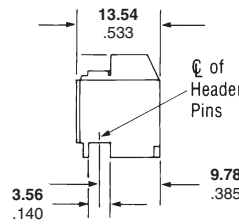

Mechanical Properties

Pitch (terminal spacing)—5.08mm

Mounting—Universal (vertical & horizontal)

Wire Strip Length—6.4mm

Recommended Tightening Torque—0.5 Nm (4.4 in-lbs)

Electrical Properties

Maximum Current—15A

Operating Voltage—300V (5.08mm)

Wire Range—12-30 AWG

Dielectric Withstand—2200V (5.08mm)

Environmental Properties

Operating Temperature Range—-60°C to +105°C [-76°F to 221°F]

| No. of Positions | Dim. A | Part Number | Catalog Number |
|------------------|---------------|-------------|----------------|
| 2 | 10.16 [.400] | 7-1437426-1 | B51C8U02T |
| 3 | 15.24 [.600] | 7-1437426-2 | B51C8U03T |
| 4 | 20.32 [.800] | 7-1437426-4 | B51C8U04T |
| 5 | 25.40 [1.000] | 7-1437426-5 | B51C8U05T |
| 6 | 30.48 [1.200] | 7-1437426-7 | B51C8U06T |
| 7 | 35.56 [1.400] | 7-1437426-8 | B51C8U07T |
| 8 | 40.64 [1.600] | 8-1437426-0 | B51C8U08T |
| 9 | 45.72 [1.800] | 8-1437426-1 | B51C8U09T |
| 10 | 50.80 [2.000] | 8-1437426-3 | B51C8U10T |
| 11 | 55.88 [2.200] | 8-1437426-6 | B51C8U11T |
| 12 | 60.96 [2.400] | 8-1437426-7 | B51C8U12T |
| 13 | 66.04 [2.600] | 9-1437426-0 | B51C8U13T |
| 14 | 71.12 [2.800] | 9-1437426-1 | B51C8U14T |
| 15 | 76.20 [3.000] | 9-1437426-2 | B51C8U15T |



Note: All part numbers are RoHS Compliant.

Flush-Mount Pin Headers

5.08 mm Pitch



5.08 mm Flush-Mount Pin Headers Series B71N8 (Mates with Series B51C8 Connectors)

Material & Finish

Housing Material—Liquid crystal polymer

Flammability—UL94V-0

Color—Brown

Pin—Phosphor bronze, tin plated

Mechanical Properties

Pitch (pin spacing)—5.08mm

Recommended PCB Hole Dia.—1.7mm

Electrical Properties

Maximum Current—15A

Operating Voltage—300V (5mm)

Environmental Properties

Operating Temperature Range—
-30°C to +105°C [-22°F to 221°F] Tin contact system

(vertical solder pins)

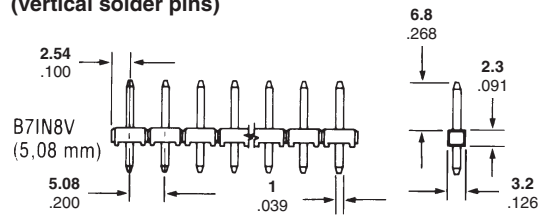

Series B51C8 Plug-in Connector

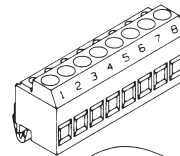

Series B71N8 Vertical Pin Header

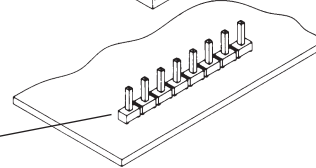

| No. of Positions | Part Number | Catalog Number |
|------------------|-------------|----------------|
| 2 | 1776453-2 | B71N8V02T |
| 3 | 1776453-3 | B71N8V03T |
| 4 | 1776453-4 | B71N8V04T |
| 5 | 1776453-5 | B71N8V05T |
| 6 | 1776453-6 | B71N8V06T |
| 7 | 1776453-7 | B71N8V07T |
| 8 | 1776453-8 | B71N8V08T |
| 9 | 1776453-9 | B71N8V09T |
| 10 | 1-1776453-0 | B71N8V10T |
| 11 | 1-1776453-1 | B71N8V11T |
| 12 | 1-1776453-2 | B71N8V12T |
| 13 | — | B71N8V13T |
| 14 | 1-1776453-4 | B71N8V14T |
| 15 | — | B71N8V15T |
| 16 | 1-1776453-6 | B71N8V16T |
| 17 | 1-1776453-7 | B71N8V17T |
| 18 | 1-1776453-8 | B71N8V18T |
| 19 | — | B71N8V19T |
| 20 | 2-1776453-0 | B71N8V20T |
| 21 | — | B71N8V21T |
| 22 | 2-1776453-2 | B71N8V22T |
| 23 | — | B71N8V23T |
| 24 | 2-1776453-4 | B71N8V24T |



LR28387 E63810

Wire Protector Versions

Product Facts

- **Modular configuration designed with a dovetail and special detent to provide a more reliable attachment after combining smaller sizes to increase the number of available wire positions**
- **Accepts various wire ranges from 14-22 AWG**
- **Exceptional UL Flammability Classification. All are rated to a flammability classification of UL 94V-0. To achieve the UL94V-0 classification, all materials are tested and proven to be self-extinguishing**
- **UL Recognition File No. E28476**
- **CSA Certification File No. 209071**
- **Pitches Available**
 - **5.0 mm and 5.08 mm Low Profile**
 - **Side and top wire entry**
 - **3.5 mm Side Entry Only**
 - **5.00 mm**
 - **5.0 mm and 5.08 mm 45° wire entry**
- **Various position sizes available**
- **Ink marking available**
- **Other colors available upon request other than those listed in catalog**

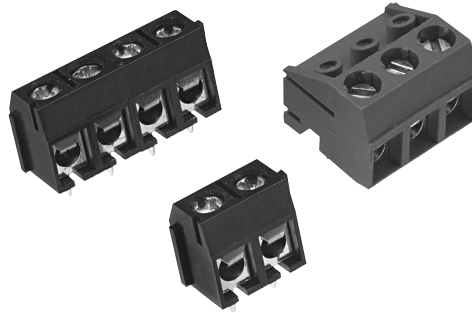

Has full wire guard protection so that the screw does not press directly on the wire. Offers "Lower Profile" terminal block than the cage clamp style. Designed for infrequent terminations.

The screw is able to accommodate both Slot head and Phillips style screwdrivers.

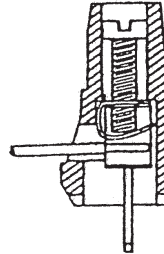

Open

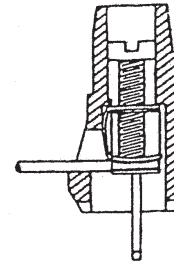

Closed

Note: All part numbers are RoHS Compliant.

PCB Mount, Straight, Top Wire Entry Connectors

Terminal Block PCB Mount
Top Wire Entry
w/Interlock
5.0 mm Pitch (LT)
Color – Blue
UL Rating – 250 V, 10 A
14-22 AWG

Suggested Screw Torque—
4.0 in.-lbs.

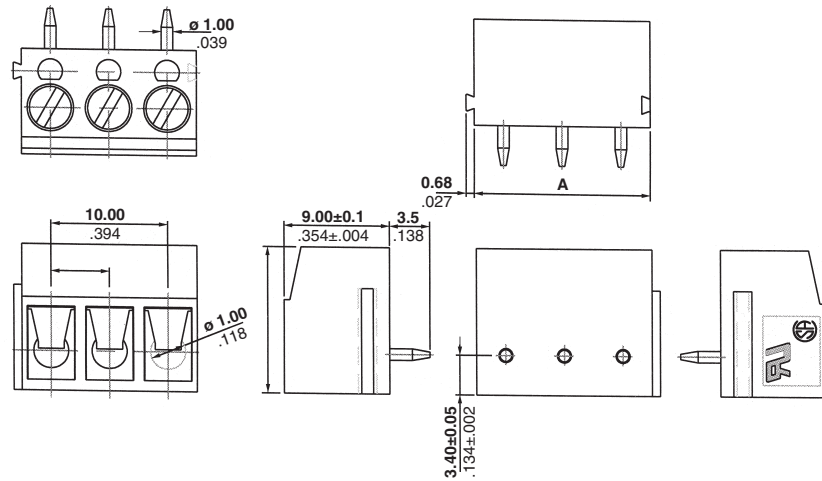

| No. of Positions | Dim. A | Part Numbers |
|------------------|---------------|--------------|
| 2 | 10.0 [0.394] | 1776492-2 |
| 3 | 15.0 [0.591] | 1776492-3 |
| 4 | 20.0 [0.787] | 1776492-4 |
| 5 | 25.0 [0.984] | 1776492-5 |
| 6 | 30.0 [1.181] | 1776492-6 |
| 7 | 35.0 [1.378] | 1776492-7 |
| 8 | 40.0 [1.575] | 1776492-8 |
| 9 | 45.0 [1.772] | 1776492-9 |
| 10 | 50.0 [1.968] | 1-1776492-0 |
| 11 | 55.0 [2.165] | 1-1776492-1 |
| 12 | 60.0 [2.362] | 1-1776492-2 |
| 13 | 65.0 [2.559] | 1-1776492-3 |
| 14 | 70.0 [2.756] | 1-1776492-4 |
| 15 | 75.0 [2.953] | 1-1776492-5 |
| 16 | 80.0 [3.150] | 1-1776492-6 |
| 17 | 85.0 [3.346] | 1-1776492-7 |
| 18 | 90.0 [3.543] | 1-1776492-8 |
| 19 | 95.0 [3.740] | 1-1776492-9 |
| 20 | 100.0 [3.937] | 2-1776492-0 |
| 21 | 105.0 [4.134] | 2-1776492-1 |
| 22 | 110.0 [4.331] | 2-1776492-2 |
| 23 | 115.0 [4.528] | 2-1776492-3 |
| 24 | 120.0 [4.724] | 2-1776492-4 |

Wave solder process capable to 265°C [509°F] for 10 seconds

Note: All part numbers are RoHS Compliant.

PCB Mount, Straight, Top Wire Entry Connectors (Continued)

**Terminal Block PCB Mount
Top Wire Entry
Low Profile w/Interlock
5.0 mm Pitch (LT)
Color – See chart.**

**UL Rating – 250 V, 10 A
14-22 AWG**

**Suggested Screw Torque—
4.5 in.-lbs.**

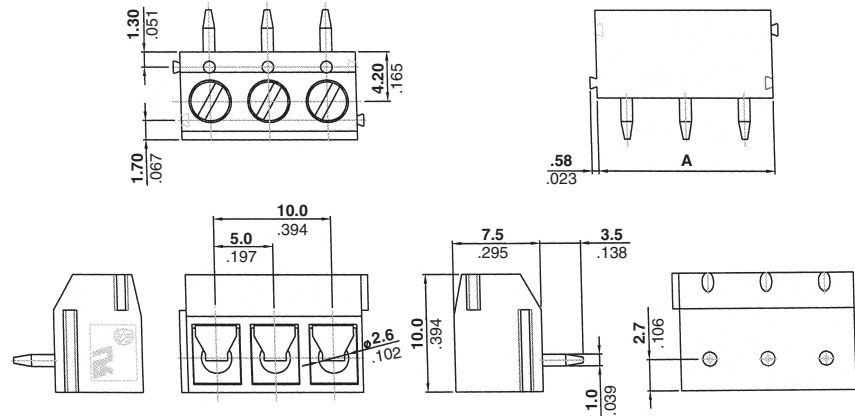

| No. of Positions | Dim. A | Part No. | |
|------------------|---------------|-------------|-------------|
| | | Blue | Green |
| 2 | 10.0 [.394] | 1776555-2 | 1776267-2 |
| 3 | 15.0 [.591] | 1776555-3 | 1776267-3 |
| 4 | 20.0 [.787] | 1776555-4 | 1776267-4 |
| 5 | 25.0 [.984] | 1776555-5 | 1776267-5 |
| 6 | 30.0 [1.181] | 1776555-6 | 1776267-6 |
| 7 | 35.0 [1.378] | 1776555-7 | 1776267-7 |
| 8 | 40.0 [1.575] | 1776555-8 | 1776267-8 |
| 9 | 45.0 [1.772] | 1776555-9 | 1776267-9 |
| 10 | 50.0 [1.968] | 1-1776555-0 | 1-1776267-0 |
| 11 | 55.0 [2.165] | 1-1776555-1 | 1-1776267-1 |
| 12 | 60.0 [2.362] | 1-1776555-2 | 1-1776267-2 |
| 13 | 65.0 [2.559] | 1-1776555-3 | 1-1776267-3 |
| 14 | 70.0 [.591] | 1-1776555-4 | 1-1776267-4 |
| 15 | 75.0 [.787] | 1-1776555-5 | 1-1776267-5 |
| 16 | 80.0 [.984] | 1-1776555-6 | 1-1776267-6 |
| 17 | 85.0 [1.181] | 1-1776555-7 | 1-1776267-7 |
| 18 | 90.0 [1.378] | 1-1776555-8 | 1-1776267-8 |
| 19 | 95.0 [1.575] | 1-1776555-9 | 1-1776267-9 |
| 20 | 100.0 [1.772] | 2-1776555-0 | 2-1776267-0 |
| 21 | 105.0 [1.968] | 2-1776555-1 | 2-1776267-1 |
| 22 | 110.0 [2.165] | 2-1776555-2 | 2-1776267-2 |
| 23 | 115.0 [2.362] | 2-1776555-3 | 2-1776267-3 |
| 24 | 120.0 [2.362] | 2-1776555-4 | 2-1776267-4 |

Wave solder process capable to 265°C [509°F] for 10 seconds



Note: All part numbers are RoHS Compliant.

PCB Mount, Straight, Side Wire Entry Connectors

**Terminal Block PCB Mount
Side Wire Entry
w/Interlock
3.5 mm Pitch (LT)
Color – Blue
UL Rating – 250 V, 7 A
18-26 AWG**

Suggested Screw Torque—
2.5 in.-lbs.

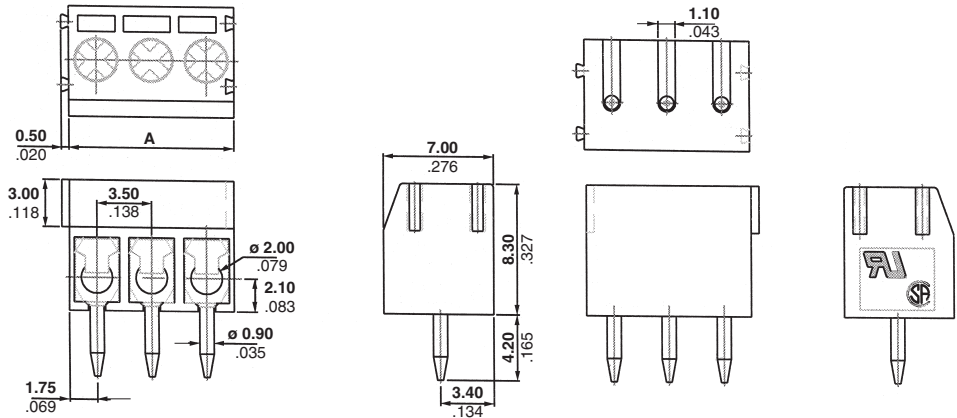

| No. of Positions | Dim. A | Part Numbers |
|------------------|---------------|--------------|
| 2 | 7.00 [.276] | 1776275-2 |
| 3 | 10.50 [.413] | 1776275-3 |
| 4 | 14.00 [.551] | 1776275-4 |
| 5 | 17.50 [.689] | 1776275-5 |
| 6 | 21.00 [.827] | 1776275-6 |
| 7 | 24.50 [.965] | 1776275-7 |
| 8 | 28.00 [1.102] | 1776275-8 |
| 9 | 31.50 [1.240] | 1776275-9 |
| 10 | 35.00 [1.378] | 1-1776275-0 |
| 11 | 38.50 [1.516] | 1-1776275-1 |
| 12 | 42.00 [1.654] | 1-1776275-2 |
| 13 | 45.50 [1.791] | 1-1776275-3 |
| 14 | 49.00 [1.929] | 1-1776275-4 |
| 15 | 52.50 [2.067] | 1-1776275-5 |
| 16 | 54.00 [2.126] | 1-1776275-6 |
| 17 | 57.50 [2.264] | 1-1776275-7 |
| 18 | 61.00 [2.402] | 1-1776275-8 |
| 19 | 64.50 [2.539] | 1-1776275-9 |
| 20 | 68.00 [2.677] | 2-1776275-0 |
| 21 | 71.50 [2.815] | 2-1776275-1 |
| 22 | 75.00 [2.953] | 2-1776275-2 |
| 23 | 78.50 [3.091] | 2-1776275-3 |
| 24 | 82.00 [3.228] | 2-1776275-4 |

Wave solder process capable to 265°C [509°F] for 10 seconds

Note: All part numbers are RoHS Compliant.

PCB Mount, Straight, Side Wire Entry Connectors (Continued)

**Terminal Block PCB Mount
Side Wire Entry
Low Profile w/Interlock
5.0 mm Pitch (LT)**

**UL Rating – 250 V, 10 A
14-22 AWG**

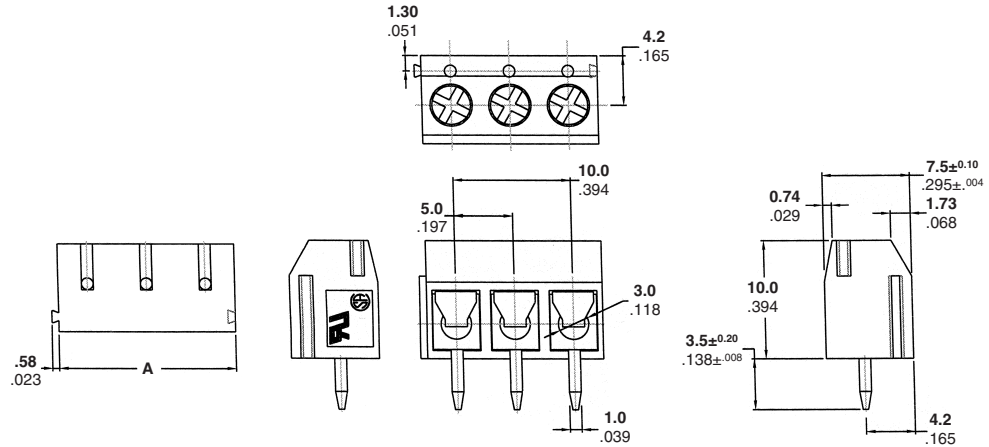

Suggested Screw Torque—
4.5 in.-lbs.

| No. of Positions | Dim. A | Part Numbers | | | |
|------------------|---------------|--------------|-------------|-------------|-------------|
| | | Blue | Green | Gray | Black |
| 2 | 10.0 [.394] | 1776244-2 | 1776266-2 | 1776504-2 | 1776269-2 |
| 3 | 15.0 [.591] | 1776244-3 | 1776266-3 | 1776504-3 | 1776269-3 |
| 4 | 20.0 [.787] | 1776244-4 | 1776266-4 | 1776504-4 | 1776269-4 |
| 5 | 25.0 [.984] | 1776244-5 | 1776266-5 | 1776504-5 | 1776269-5 |
| 6 | 30.0 [1.181] | 1776244-6 | 1776266-6 | 1776504-6 | 1776269-6 |
| 7 | 35.0 [1.378] | 1776244-7 | 1776266-7 | 1776504-7 | 1776269-7 |
| 8 | 40.0 [1.575] | 1776244-8 | 1776266-8 | 1776504-8 | 1776269-8 |
| 9 | 45.0 [1.772] | 1776244-9 | 1776266-9 | 1776504-9 | 1776269-9 |
| 10 | 50.0 [1.968] | 1-1776244-0 | 1-1776266-0 | 1-1776504-0 | 1-1776269-0 |
| 11 | 55.0 [2.165] | 1-1776244-1 | 1-1776266-1 | 1-1776504-1 | 1-1776269-1 |
| 12 | 60.0 [2.362] | 1-1776244-2 | 1-1776266-2 | 1-1776504-2 | 1-1776269-2 |
| 13 | 65.0 [2.559] | 1-1776244-3 | 1-1776266-3 | 1-1776504-3 | 1-1776269-3 |
| 14 | 70.0 [.591] | 1-1776244-4 | 1-1776266-4 | 1-1776504-4 | 1-1776269-4 |
| 15 | 75.0 [.787] | 1-1776244-5 | 1-1776266-5 | 1-1776504-5 | 1-1776269-5 |
| 16 | 80.0 [.984] | 1-1776244-6 | 1-1776266-6 | 1-1776504-6 | 1-1776269-6 |
| 17 | 85.0 [1.181] | 1-1776244-7 | 1-1776266-7 | 1-1776504-7 | 1-1776269-7 |
| 18 | 90.0 [1.378] | 1-1776244-8 | 1-1776266-8 | 1-1776504-8 | 1-1776269-8 |
| 19 | 95.0 [1.575] | 1-1776244-9 | 1-1776266-9 | 1-1776504-9 | 1-1776269-9 |
| 20 | 100.0 [1.772] | 2-1776244-0 | 2-1776266-0 | 2-1776504-0 | 2-1776269-0 |
| 21 | 105.0 [1.968] | 2-1776244-1 | 2-1776266-1 | 2-1776504-1 | 2-1776269-1 |
| 22 | 110.0 [2.165] | 2-1776244-2 | 2-1776266-2 | 2-1776504-2 | 2-1776269-2 |
| 23 | 115.0 [2.362] | 2-1776244-3 | 2-1776266-3 | 2-1776504-3 | 2-1776269-3 |
| 24 | 120.0 [2.362] | 2-1776244-4 | 2-1776266-4 | 2-1776504-4 | 2-1776269-4 |

Wave solder process capable to 265°C [509°F] for 10 seconds



Note: All part numbers are RoHS Compliant.

PCB Mount, Straight, Side Wire Entry Connectors (Continued)

Terminal Block PCB Mount
Side Wire Entry
w/Interlock
5.00 mm Pitch (LT)
Color – Blue
UL Rating – 250 V, 10 A
14-22 AWG

Suggested Screw Torque—
4.5 in.-lbs.

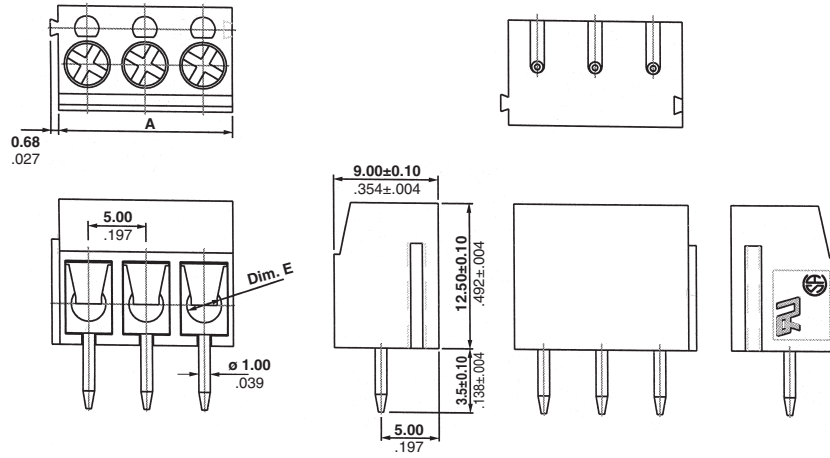

| No. of Positions | Dim. A | Part Numbers |
|------------------|----------------|--------------|
| 2 | 10.00 [.394] | 1776491-2 |
| 3 | 15.00 [.591] | 1776491-3 |
| 4 | 20.00 [.787] | 1776491-4 |
| 5 | 25.00 [.984] | 1776491-5 |
| 6 | 30.00 [1.181] | 1776491-6 |
| 7 | 35.00 [1.378] | 1776491-7 |
| 8 | 40.00 [1.575] | 1776491-8 |
| 9 | 45.00 [1.772] | 1776491-9 |
| 10 | 50.00 [1.969] | 1-1776491-0 |
| 11 | 55.00 [2.165] | 1-1776491-1 |
| 12 | 60.00 [2.362] | 1-1776491-2 |
| 13 | 65.00 [2.559] | 1-1776491-3 |
| 14 | 70.00 [2.756] | 1-1776491-4 |
| 15 | 75.00 [2.953] | 1-1776491-5 |
| 16 | 80.00 [3.150] | 1-1776491-6 |
| 17 | 85.00 [3.346] | 1-1776491-7 |
| 18 | 90.00 [3.543] | 1-1776491-8 |
| 19 | 95.00 [3.740] | 1-1776491-9 |
| 20 | 100.00 [3.937] | 2-1776491-0 |
| 21 | 105.00 [4.134] | 2-1776491-1 |
| 22 | 110.00 [4.331] | 2-1776491-2 |
| 23 | 115.00 [4.525] | 2-1776491-3 |
| 24 | 120.00 [4.724] | 2-1776491-4 |

Wave solder process capable to 265°C [509°F] for 10 seconds

45° Wire Inlet Connectors

Terminal Block
45° Wire Inlet w/Interlock
5.00 mm Pitch (LT)
Color – Blue
UL Rating – 250 V, 10 A
14-22 AWG

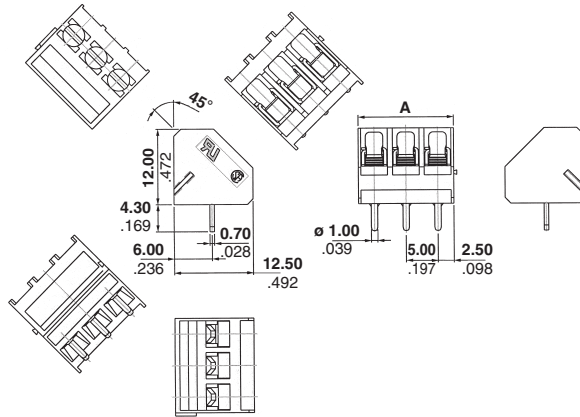

Suggested Screw Torque—
4.0 in.-lbs.

| No. of Positions | Dim. A | Part Numbers |
|------------------|---------------|--------------|
| 2 | 10.00 [.394] | 1776252-2 |
| 3 | 15.00 [.591] | 1776252-3 |
| 4 | 20.00 [.787] | 1776252-4 |
| 5 | 25.00 [.984] | 1776252-5 |
| 6 | 30.00 [1.181] | 1776252-6 |
| 7 | 35.00 [1.378] | 1776252-7 |
| 8 | 40.00 [1.575] | 1776252-8 |
| 9 | 45.00 [1.772] | 1776252-9 |
| 10 | 50.00 [1.969] | 1-1776252-0 |
| 11 | 55.00 [2.165] | 1-1776252-1 |
| 12 | 60.00 [2.362] | 1-1776252-2 |
| 13 | 65.00 [2.559] | 1-1776252-3 |

| No. of Positions | Dim. A | Part Numbers |
|------------------|----------------|--------------|
| 14 | 70.00 [2.756] | 1-1776252-4 |
| 15 | 75.00 [2.953] | 1-1776252-5 |
| 16 | 80.00 [3.150] | 1-1776252-6 |
| 17 | 85.00 [3.346] | 1-1776252-7 |
| 18 | 90.00 [3.543] | 1-1776252-8 |
| 19 | 95.00 [3.740] | 1-1776252-9 |
| 20 | 100.00 [3.937] | 2-1776252-0 |
| 21 | 105.00 [4.134] | 2-1776252-1 |
| 22 | 110.00 [4.331] | 2-1776252-2 |
| 23 | 115.00 [4.528] | 2-1776252-3 |
| 24 | 120.00 [4.724] | 2-1776252-4 |

Wave solder process capable to 265°C [509°F] for 10 seconds

Terminal Block
45° Wire Inlet w/Interlock
5.08 mm Pitch (LT)
Color – Blue
UL Rating – 250 V, 10 A
14-22 AWG

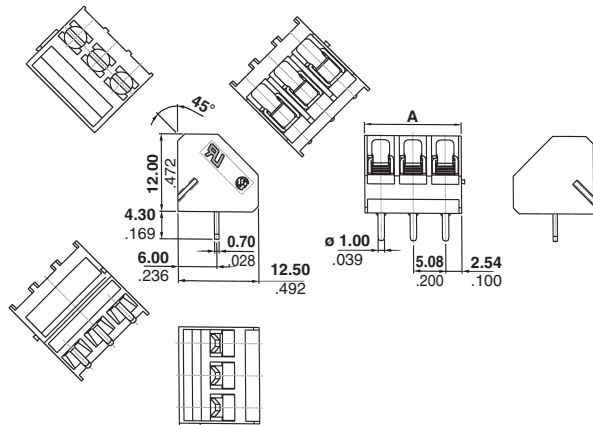

Suggested Screw Torque—
4.0 in.-lbs.

| No. of Positions | Dim. A | Part Numbers |
|------------------|---------------|--------------|
| 2 | 10.16 [.400] | 1776258-2 |
| 3 | 15.24 [.600] | 1776258-3 |
| 4 | 20.32 [.800] | 1776258-4 |
| 5 | 25.40 [1.000] | 1776258-5 |
| 6 | 30.48 [1.200] | 1776258-6 |
| 7 | 35.56 [1.400] | 1776258-7 |
| 8 | 40.64 [1.600] | 1776258-8 |
| 9 | 45.72 [1.800] | 1776258-9 |
| 10 | 50.80 [2.000] | 1-1776258-0 |
| 11 | 55.88 [2.200] | 1-1776258-1 |
| 12 | 60.96 [2.400] | 1-1776258-2 |
| 13 | 66.04 [2.600] | 1-1776258-3 |

| No. of Positions | Dim. A | Part Numbers |
|------------------|----------------|--------------|
| 14 | 71.12 [2.800] | 1-1776258-4 |
| 15 | 76.20 [3.000] | 1-1776258-5 |
| 16 | 81.28 [3.200] | 1-1776258-6 |
| 17 | 86.36 [3.400] | 1-1776258-7 |
| 18 | 91.44 [3.600] | 1-1776258-8 |
| 19 | 96.52 [3.800] | 1-1776258-9 |
| 20 | 101.60 [4.000] | 2-1776258-0 |
| 21 | 106.68 [4.200] | 2-1776258-1 |
| 22 | 111.76 [4.400] | 2-1776258-2 |
| 23 | 116.84 [4.600] | 2-1776258-3 |
| 24 | 121.92 [4.800] | 2-1776258-4 |

Wave solder process capable to 265°C [509°F] for 10 seconds

Note: All part numbers are RoHS Compliant.

Plug, Flush Mount

**Plug
Flush Mount
5.00 mm Pitch
Color – See chart.**

**UL Rating – 250/300 V, 10 A
14-22 AWG**

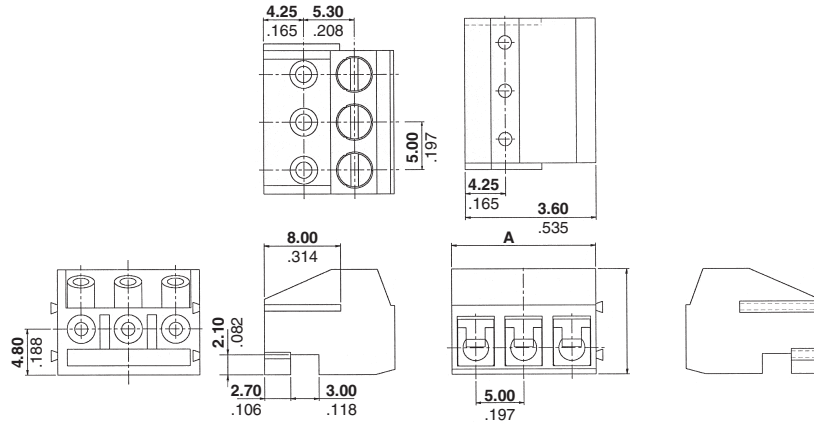

Suggested Screw Torque—
4.5 in.-lbs.

| No. of Positions | Dim. A | Part No. | |
|------------------|---------------|-------------|-------------|
| | | Black | Blue |
| 2 | 10.00 [.394] | 1776280-2 | 1776263-2 |
| 3 | 15.00 [.591] | 1776280-3 | 1776263-3 |
| 4 | 20.00 [.787] | 1776280-4 | 1776263-4 |
| 5 | 25.00 [.984] | 1776280-5 | 1776263-5 |
| 6 | 30.00 [1.181] | 1776280-6 | 1776263-6 |
| 7 | 35.00 [1.378] | 1776280-7 | 1776263-7 |
| 8 | 40.00 [1.575] | 1776280-8 | 1776263-8 |
| 9 | 45.00 [1.772] | 1776280-9 | 1776263-9 |
| 10 | 50.00 [1.969] | 1-1776280-0 | 1-1776263-0 |
| 11 | 55.00 [2.165] | 1-1776280-1 | 1-1776263-1 |
| 12 | 60.00 [2.362] | 1-1776280-2 | 1-1776263-2 |
| 13 | 65.00 [2.559] | 1-1776280-3 | 1-1776263-3 |

| No. of Positions | Dim. A | Part No. | |
|------------------|----------------|-------------|-------------|
| | | Black | Blue |
| 14 | 70.00 [2.756] | 1-1776280-4 | 1-1776263-4 |
| 15 | 75.00 [2.953] | 1-1776280-5 | 1-1776263-5 |
| 16 | 80.00 [3.150] | 1-1776280-6 | 1-1776263-6 |
| 17 | 85.00 [3.346] | 1-1776280-7 | 1-1776263-7 |
| 18 | 90.00 [3.543] | 1-1776280-8 | 1-1776263-8 |
| 19 | 95.00 [3.740] | 1-1776280-9 | 1-1776263-9 |
| 20 | 100.00 [3.937] | 2-1776280-0 | 2-1776263-0 |
| 21 | 105.00 [4.134] | 2-1776280-1 | 2-1776263-1 |
| 22 | 110.00 [4.331] | 2-1776280-2 | 2-1776263-2 |
| 23 | 115.00 [4.528] | 2-1776280-3 | 2-1776263-3 |
| 24 | 120.00 [4.724] | 2-1776280-4 | 2-1776263-4 |

Header, Straight Mount

**Header
Straight Mount,
Unshrouded
5.00 mm Pitch
Color – Blue
UL Rating – 250/300 V, 10 A**

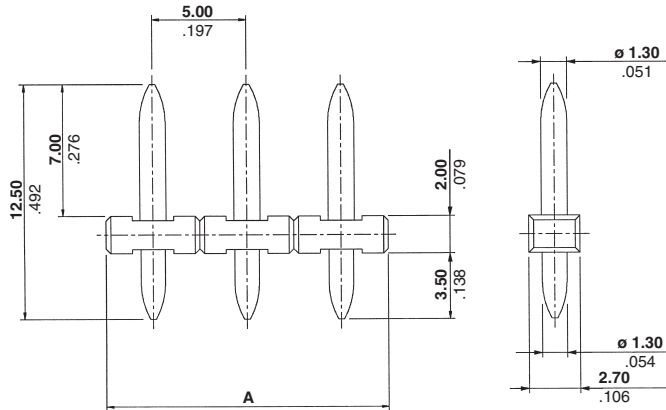

| No. of Positions | Dim. A | Part Numbers |
|------------------|---------------|--------------|
| 2 | 10.00 [.394] | 1776489-2 |
| 3 | 15.00 [.591] | 1776489-3 |
| 4 | 20.00 [.787] | 1776489-4 |
| 5 | 25.00 [.984] | 1776489-5 |
| 6 | 30.00 [1.181] | 1776489-6 |
| 7 | 35.00 [1.378] | 1776489-7 |
| 8 | 40.00 [1.575] | 1776489-8 |
| 9 | 45.00 [1.772] | 1776489-9 |
| 10 | 50.00 [1.969] | 1-1776489-0 |
| 11 | 55.00 [2.165] | 1-1776489-1 |
| 12 | 60.00 [2.362] | 1-1776489-2 |
| 13 | 65.00 [2.559] | 1-1776489-3 |

| No. of Positions | Dim. A | Part Numbers |
|------------------|----------------|--------------|
| 14 | 70.00 [2.756] | 1-1776489-4 |
| 15 | 75.00 [2.953] | 1-1776489-5 |
| 16 | 80.00 [3.150] | 1-1776489-6 |
| 17 | 85.00 [3.346] | 1-1776489-7 |
| 18 | 90.00 [3.543] | 1-1776489-8 |
| 19 | 95.00 [3.740] | 1-1776489-9 |
| 20 | 100.00 [3.937] | 2-1776489-0 |
| 21 | 105.00 [4.134] | 2-1776489-1 |
| 22 | 110.00 [4.331] | 2-1776489-2 |
| 23 | 115.00 [4.528] | 2-1776489-3 |
| 24 | 120.00 [4.724] | 2-1776489-4 |

Wave solder process capable to 265°C [509°F] for 10 seconds

Note: All part numbers are RoHS Compliant.

Wire Trap

2.5 mm Pitch

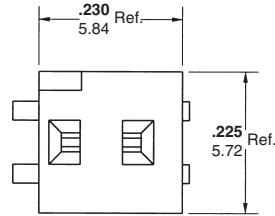
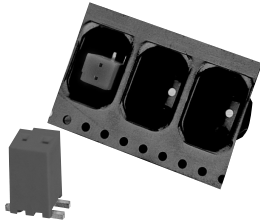

2.5 mm Surface Mount, Technology with Wire Trap, Series SMC

Material & Finish

Housing Material—Polyphenylene Sulfide (PPS)

Flammability—UL94V-0

Color—Black

Contact—Phosphor bronze, tin plated over nickel

Mechanical Properties

Pitch (terminal spacing)—2.5mm [.098]

Wire Strip Length—5.5mm min, 7.11mm max. [0.22" min, 0.28" max]

Max. Wire Insulation Diameter—1.7mm [.067]

Packaging—Tape and reel and loose piece

Electrical Properties

Maximum Current—3A

Operating Voltage—250V

Wire Range—24 AWG, stranded tin

Dielectric Withstand—1500 VAC

Environmental Properties

Max. Operating Temperature—105°C [221°F]

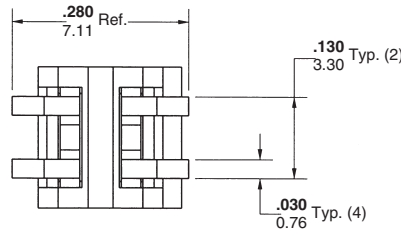
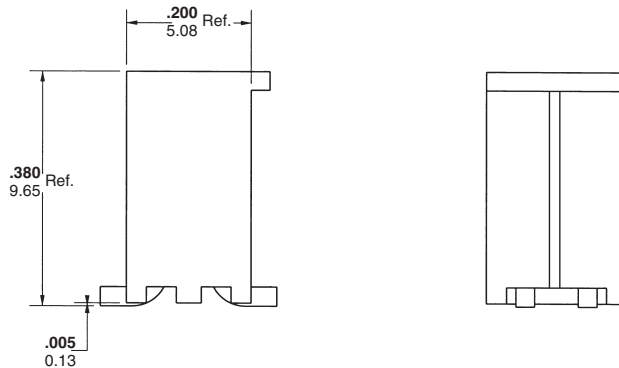

Surface Mount with Wire Trap

Product Facts

- n Available in 2.5 mm pitch
- n Accepts 24 AWG stranded tin
- n 2 position Connector
- n Current capability: 3 A
- n 250 V
- n Packaging: Tape and Reel and Loose Piece (25 pcs/bag)

| Description | No. of Positions | Part Number | Catalog Number |
|-------------------------|------------------|-------------|----------------|
| Tape & Reel, 500 pieces | 2 | 1776226-1 | SMC2402 |
| 25 pieces | 2 | 1776227-1 | SM2V02 |

Note: All part numbers are RoHS Compliant.

PIVOT BLOCK 3.5 mm Plugs

Product Facts

- 3.5 mm [.138] centerline IDC plug
- Alternative to screw clamp plugs
- Two-piece pluggable terminal block system
- Mates with 3.5 mm horizontal and vertical terminal block headers on pages 45, 47, 49 and 58
- Proven pivot wire termination
- Multi-position connector, IDC termination and tactile feel when terminated
- No wire stripping required
- Flanged version available
- Designs available to terminate solid and stranded wires: 22-24 AWG (2-16 positions)
- Wire stuffer allows visual inspection of wire termination
- Screwdriver required to open wire stuffer

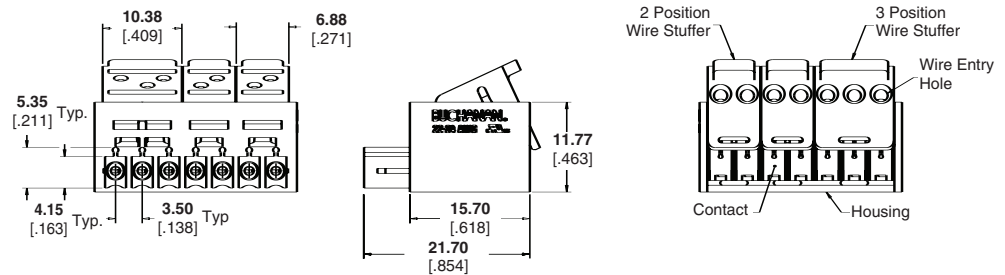
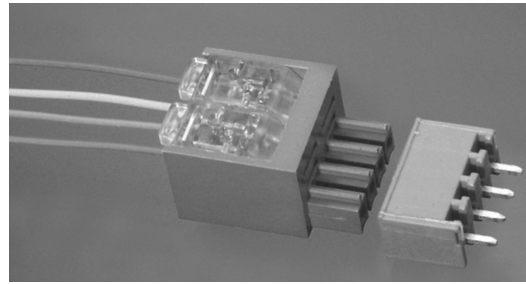

Material and Finish

- Wire Stuffer**—Polycarbonate
- Housing**—PBT Polyester, Green (standard color), blue also available
- Contact**—Phosphor Bronze
- Plating**—Tin over Nickel

Performance Characteristics

Mechanical Properties

- 10 cycles min. durability wire termination
- 15 lbs. closing force max. (2 position)
- 10 lbs. opening force max. (2 position)
- Screws for mounting flange M2.5 fixing screw

Electrical Properties

- Maximum current 5A (22-24 AWG)
- Operating voltage 250 V
- Dielectric withstanding 1500 VAC

Technical Documents

Product Specification:
108-1981

Application Specification:
114-13037

| No. of Positions | Description | 22-24 AWG | |
|------------------|---------------------------|------------------|-------------------|
| | | Part Number Blue | Part Number Green |
| 2 | IDC T/B | 1776279-2 | 1776282-2 |
| | IDC T/B with Screw Flange | 1776281-2 | 1776283-2 |
| 3 | IDC T/B | 1776279-3 | 1776282-3 |
| | IDC T/B with Screw Flange | 1776281-3 | 1776283-3 |
| 4 | IDC T/B | 1776279-4 | 1776282-4 |
| | IDC T/B with Screw Flange | 1776281-4 | 1776283-4 |
| 5 | IDC T/B | 1776279-5 | 1776282-5 |
| | IDC T/B with Screw Flange | 1776281-5 | 1776283-5 |
| 6 | IDC T/B | 1776279-6 | 1776282-6 |
| | IDC T/B with Screw Flange | 1776281-6 | 1776283-6 |
| 7 | IDC T/B | 1776279-7 | 1776282-7 |
| | IDC T/B with Screw Flange | 1776281-7 | 1776283-7 |
| 8 | IDC T/B | 1776279-8 | 1776282-8 |
| | IDC T/B with Screw Flange | 1776281-8 | 1776283-8 |
| 9 | IDC T/B | 1776279-9 | 1776282-9 |
| | IDC T/B with Screw Flange | 1776281-9 | 1776283-9 |
| 10 | IDC T/B | 1-1776279-0 | 1-1776282-0 |
| | IDC T/B with Screw Flange | 1-1776281-0 | 1-1776283-0 |
| 11 | IDC T/B | 1-1776279-1 | 1-1776282-1 |
| | IDC T/B with Screw Flange | 1-1776281-1 | 1-1776283-1 |
| 12 | IDC T/B | 1-1776279-2 | 1-1776282-2 |
| | IDC T/B with Screw Flange | 1-1776281-2 | 1-1776283-2 |
| 13 | IDC T/B | 1-1776279-3 | 1-1776282-3 |
| | IDC T/B with Screw Flange | 1-1776281-3 | 1-1776283-3 |
| 14 | IDC T/B | 1-1776279-4 | 1-1776282-4 |
| | IDC T/B with Screw Flange | 1-1776281-4 | 1-1776283-4 |
| 15 | IDC T/B | 1-1776279-5 | 1-1776282-5 |
| | IDC T/B with Screw Flange | 1-1776281-5 | 1-1776283-5 |
| 16 | IDC T/B | 1-1776279-6 | 1-1776282-6 |
| | IDC T/B with Screw Flange | 1-1776281-6 | 1-1776283-6 |

Note: All part numbers are RoHS Compliant.

Vertical Screwless Wire Connectors

Product Facts

- Contact design allows for retermination
- Terminates 16-18 AWG solid wire and 18 AWG bonded wire
- Through-hole solder mount with kinked legs for PCB retention

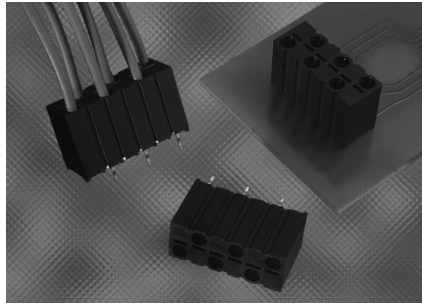

Material and Finish

Housing—UL94V-0 rated PBT
Contact—Phosphor Bronze
Contact Finish—Pre-tin over nickel underplate

Performance Characteristics

Mechanical Properties

5 cycles min. durability wire termination
Wire Retention—5 lb. [22.25N]
Pitch—.138 [3.5 mm] staggered centerline

Electrical Properties

Maximum current 2A
 Operating voltage 600 V
 Dielectric withstanding 2200 VAC

Technical Documents

Product Specification:
108-2059

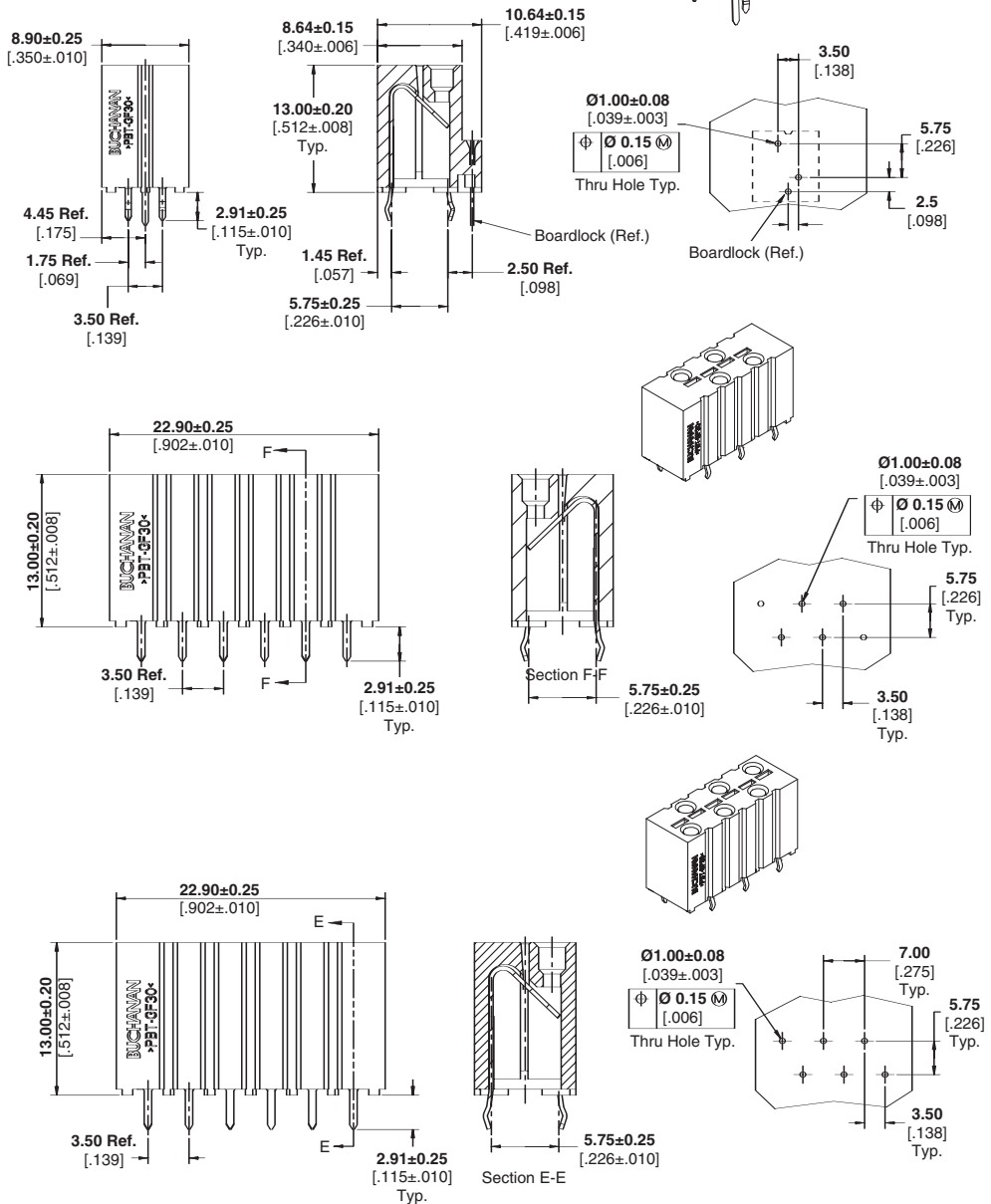

Application Specification:
114-13075



| No. of Positions | Description | Part Numbers |
|------------------|-------------|--------------|
| 2 | W/Boardlock | 1811957-1 |
| 4 | — | 1811444-1 |
| 6 | — | 1811398-1 |

Screwless Terminal Blocks

Product Facts

- Available in 5.0 mm [.197] and 5.08 mm [.200] pitch sizes
- Wire range 14-22 AWG
- Current capability: 10 A (5.08 mm [.200] lever version)
- Vertical and right-angle wire insertion provides options to meet different application needs
- No special tool required, levers can be easily actuated with a finger or a screwdriver
- Screwless saves time when installing wires
- UL Recognition 
- CSA Certification 

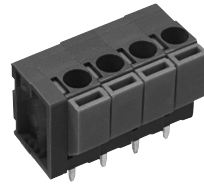

5.0 mm and 5.08 mm Pitch
(Pages 104, 105)

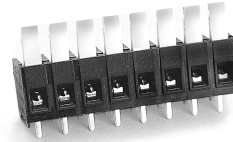

Series 2SV
5.08 mm Pitch
(Below)

Screwless Terminal Blocks are suitable for both solid and stranded wires and offers a fast way to complete wire connections. The lever is fully integrated into the body of the terminal

block, which means no special tools are required.

The spring is made from stainless steel strip so that there is a strong connection.

5.08 mm Standard Connectors with Screwless Clamp Series 2SV

Material & Finish

Housing Material—Thermoplastic polyester

Flammability—UL94V-0

Color—Black

Clamping Terminal and Solder Pin—Acid-tin over copper alloy

Mechanical Properties

Pitch (terminal spacing)—5.08mm [.200]

Recommended PCB Hole Dia.—1.4mm [.055]

Electrical Properties

Maximum Current—10 A

Operating Voltage—150/300V (limited ratings)

Wire Range—18-22 AWG

Environmental Properties

Max. Operating Temperature—130°C [266°F]

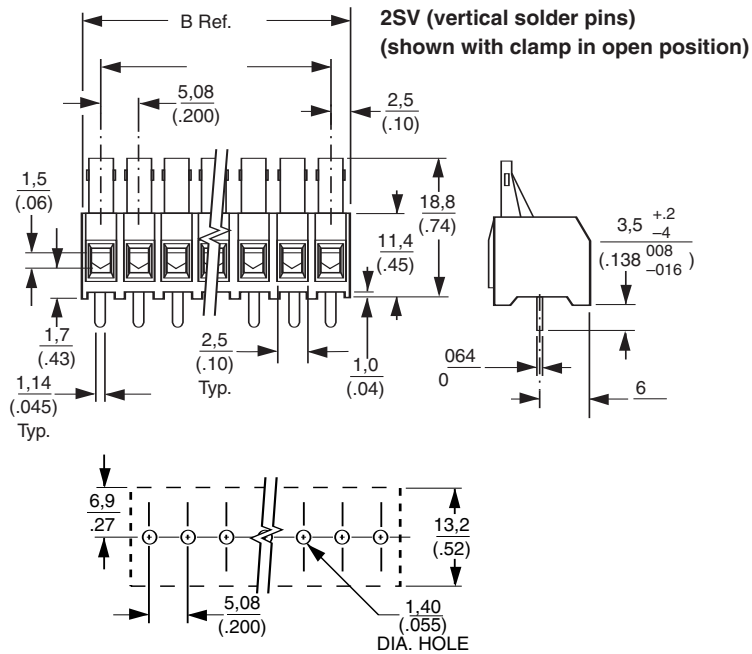

| No. of Positions | Dimensions | | Part Number | Catalog Number |
|------------------|------------|------------|-------------|----------------|
| | A | B | | |
| 2 | 0.2 [5.1] | 0.4 [10.2] | 1437671-1 | 2SV-02 |
| 3 | 0.4 [10.2] | 0.6 [15.2] | 1437671-4 | 2SV-03 |
| 4 | 0.6 [15.2] | 0.8 [20.3] | 1437671-6 | 2SV-04 |
| 5 | 0.8 [20.3] | 1.0 [25.4] | 1437671-7 | 2SV-05 |
| 6 | 1.0 [25.4] | 1.2 [30.5] | 1437671-9 | 2SV-06 |
| 7 | 1.2 [30.5] | 1.4 [35.6] | 1-1437671-0 | 2SV-07 |
| 8 | 1.4 [35.6] | 1.6 [40.6] | 1-1437671-1 | 2SV-08 |
| 9 | 1.6 [40.6] | 1.8 [45.7] | 1-1437671-2 | 2SV-09 |
| 10 | 1.8 [45.7] | 2.0 [50.8] | 1-1437671-3 | 2SV-10 |
| 11 | 2.0 [50.8] | 2.2 [55.9] | 1-1437671-4 | 2SV-11 |
| 12 | 2.2 [55.9] | 2.4 [61.0] | 1-1437671-5 | 2SV-12 |
| 13 | 2.4 [61.0] | 2.6 [66.0] | 1-1437671-6 | 2SV-13 |
| 14 | 2.6 [66.0] | 2.8 [71.1] | 1-1437671-9 | 2SV-14 |
| 15 | 2.8 [71.1] | 3.0 [76.2] | 2-1437671-0 | 2SV-15 |
| 16 | 3.0 [76.2] | 3.2 [81.3] | 2-1437671-1 | 2SV-16 |

Note: All part numbers are RoHS Compliant.

Screwless, Side Wire Entry Connectors

**Board Mount Screwless,
5.0 mm Pitch,
Side Wire Entry,
Terminal Block
Color – Green**

**UL Rating – 300 V, 10 A
14-22 AWG**

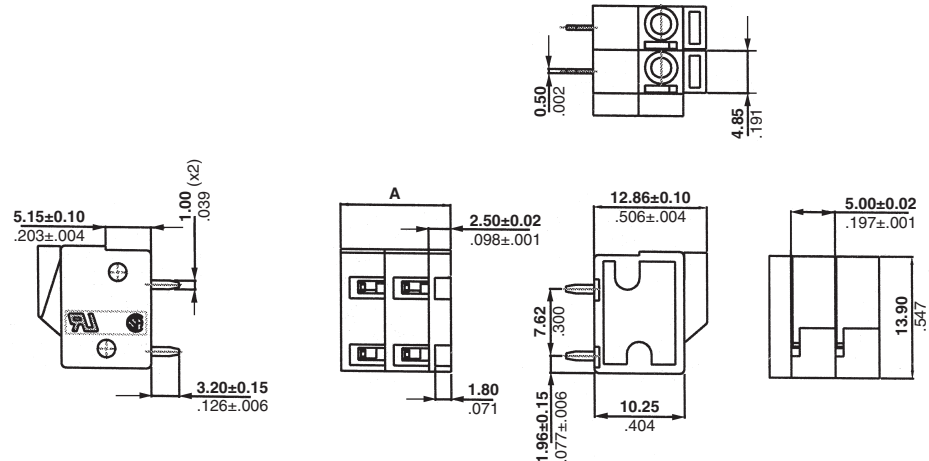

| No. of Positions | Dim. A | Part Numbers |
|------------------|---------------|--------------|
| 2 | 12.50 [.492] | 1776261-2 |
| 3 | 17.50 [.689] | 1776261-3 |
| 4 | 22.50 [.886] | 1776261-4 |
| 5 | 27.50 [1.083] | 1776261-5 |
| 6 | 32.50 [1.280] | 1776261-6 |
| 7 | 37.50 [1.476] | 1776261-7 |
| 8 | 42.50 [1.673] | 1776261-8 |
| 9 | 47.50 [1.870] | 1776261-9 |
| 10 | 52.20 [2.055] | 1-1776261-0 |
| 11 | 57.50 [2.264] | 1-1776261-1 |
| 12 | 62.50 [2.461] | 1-1776261-2 |

Wave solder process capable to 265°C [509°F] for 10 seconds

**Board Mount Screwless,
5.08 mm Pitch,
Side Wire Entry,
Terminal Block
Color – Green**

**UL Rating – 300 V, 10 A
14-22 AWG**

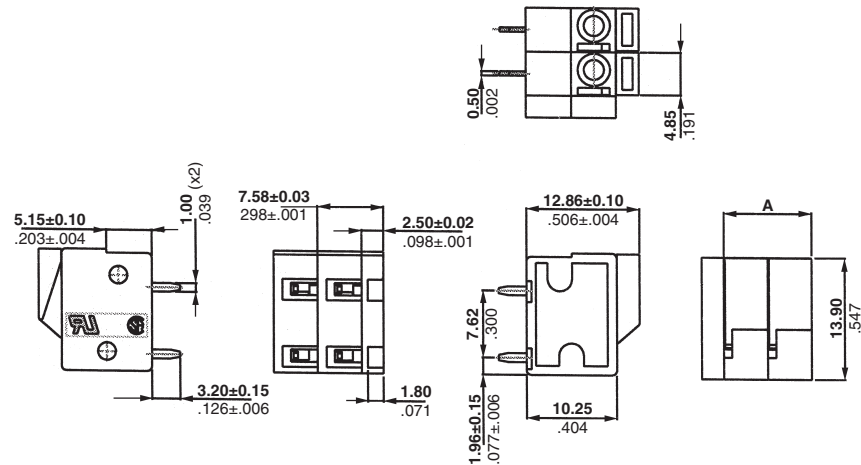

| No. of Positions | Dim. A | Part Numbers |
|------------------|---------------|--------------|
| 2 | 10.16 [.400] | 1776262-2 |
| 3 | 15.24 [.600] | 1776262-3 |
| 4 | 20.32 [.800] | 1776262-4 |
| 5 | 25.40 [1.000] | 1776262-5 |
| 6 | 30.48 [1.200] | 1776262-6 |
| 7 | 35.56 [1.400] | 1776262-7 |
| 8 | 40.64 [1.600] | 1776262-8 |
| 9 | 45.72 [1.800] | 1776262-9 |
| 10 | 50.80 [2.000] | 1-1776262-0 |
| 11 | 55.88 [2.200] | 1-1776262-1 |
| 12 | 60.96 [2.400] | 1-1776262-2 |

Wave solder process capable to 265°C [509°F] for 10 seconds

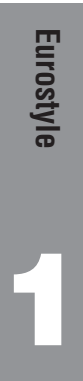

Note: All part numbers are RoHS Compliant.

Screwless, Top Wire Entry Connectors

**Board Mount Screwless,
5.0 mm Pitch,
Top Wire Entry,
Terminal Block
Color – Green**

**UL Rating – 300 V, 10 A
14-22 AWG**

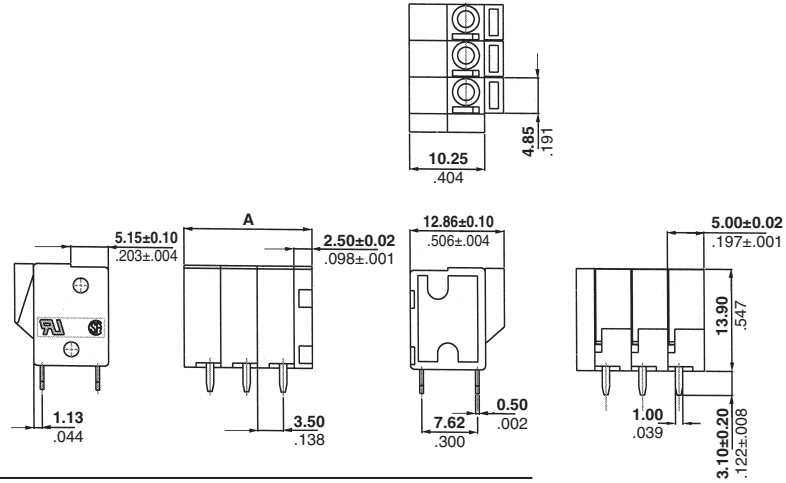

| No. of Positions | Dim. A | Part Numbers |
|------------------|---------------|--------------|
| 2 | 12.50 [.492] | 1776259-2 |
| 3 | 17.50 [.689] | 1776259-3 |
| 4 | 22.50 [.886] | 1776259-4 |
| 5 | 27.50 [1.083] | 1776259-5 |
| 6 | 32.50 [1.280] | 1776259-6 |
| 7 | 37.50 [1.476] | 1776259-7 |
| 8 | 42.50 [1.673] | 1776259-8 |
| 9 | 47.50 [1.870] | 1776259-9 |
| 10 | 52.20 [2.055] | 1-1776259-0 |
| 11 | 57.50 [2.264] | 1-1776259-1 |
| 12 | 62.50 [2.461] | 1-1776259-2 |

Wave solder process capable to 265°C [509°F] for 10 seconds

**Board Mount Screwless,
5.08 mm Pitch,
Top Wire Entry,
Terminal Block
Color – Green**

**UL Rating – 300 V, 10 A
14-22 AWG**

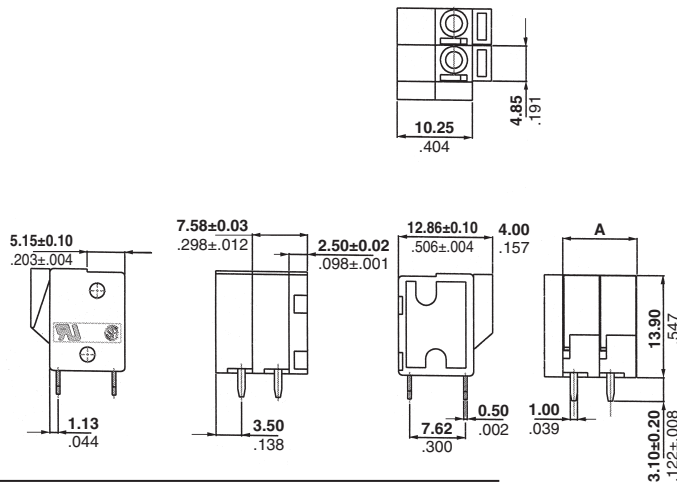

| No. of Positions | Dim. A | Part Numbers |
|------------------|---------------|--------------|
| 2 | 10.16 [.400] | 1776260-2 |
| 3 | 15.24 [.600] | 1776260-3 |
| 4 | 20.32 [.800] | 1776260-4 |
| 5 | 25.40 [1.000] | 1776260-5 |
| 6 | 30.48 [1.200] | 1776260-6 |
| 7 | 35.56 [1.400] | 1776260-7 |
| 8 | 40.64 [1.600] | 1776260-8 |
| 9 | 45.72 [1.800] | 1776260-9 |
| 10 | 50.80 [2.000] | 1-1776260-0 |
| 11 | 55.88 [2.200] | 1-1776260-1 |
| 12 | 60.96 [2.400] | 1-1776260-2 |

Wave solder process capable to 265°C [509°F] for 10 seconds

Note: All part numbers are RoHS Compliant.

Labeling

Labeling

If you need to number Terminal Block connectors, Tyco Electronics makes available an easy-to-use numbering system based on adhesive labels with proper centerline.

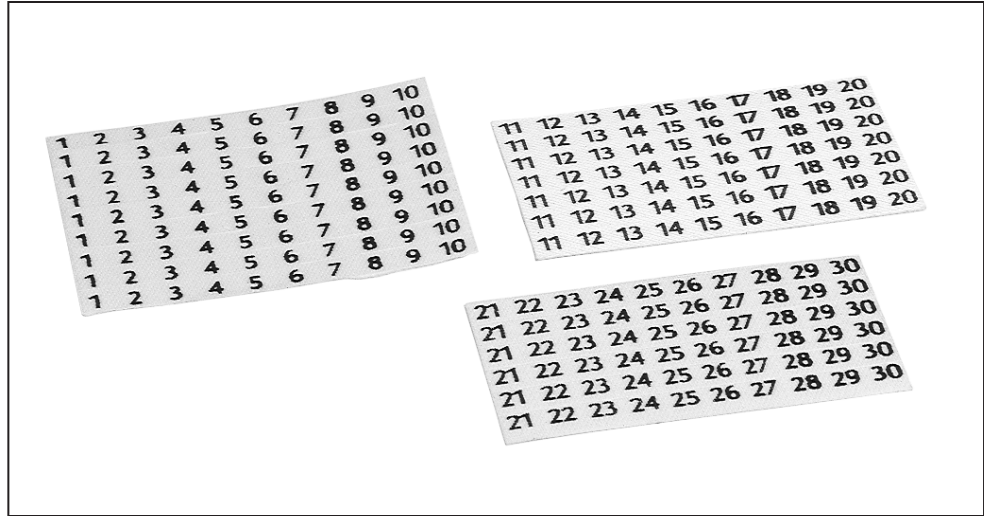

| Centerline | Number of Positions | Numbering from...up to | Part Numbers |
|------------------------|---------------------|------------------------|--------------|
| 3.5 [.138] | 10 | 1 ... 10 | 284627-1 |
| 3.5 [.138] | 10 | 11 ... 20 | 284627-2 |
| 3.5 [.138] | 10 | 21 ... 30 | 284627-3 |
| 3.5 [.138] | 10 | 31 ... 40 | 284627-4 |
| 3.5 [.138] | 10 | 41 ... 50 | 284627-5 |
| 3.5 [.138] | 10 | 51 ... 60 | 284627-6 |
| 3.81 [.150] | 10 | 1 ... 10 | 284628-1 |
| 3.81 [.150] | 10 | 11 ... 20 | 284628-2 |
| 3.81 [.150] | 10 | 21 ... 30 | 284628-3 |
| 3.81 [.150] | 10 | 31 ... 40 | 284628-4 |
| 3.81 [.150] | 10 | 41 ... 50 | 284628-5 |
| 3.81 [.150] | 10 | 51 ... 60 | 284628-6 |
| 5.0-5.08 [.197-.200] | 10 | 1 ... 10 | 282928-1 |
| 5.0-5.08 [.197-.200] | 10 | 11 ... 20 | 282928-2 |
| 5.0-5.08 [.197-.200] | 10 | 21 ... 30 | 282928-3 |
| 5.0-5.08 [.197-.200] | 10 | 31 ... 40 | 282928-4 |
| 5.0-5.08 [.197-.200] | 10 | 41 ... 50 | 282928-5 |
| 5.0-5.08 [.197-.200] | 10 | 51 ... 60 | 282928-6 |
| 7.5-7.62 [.295-.300] | 10 | 1 ... 10 | 282930-1 |
| 7.5-7.62 [.295-.300] | 10 | 11 ... 20 | 282930-2 |
| 7.5-7.62 [.295-.300] | 10 | 21 ... 30 | 282930-3 |
| 10.0-10.16 [.394-.400] | 10 | 1 ... 10 | 282929-1 |
| 10.0-10.16 [.394-.400] | 10 | 11 ... 20 | 282929-2 |
| 10.0-10.16 [.394-.400] | 10 | 21 ... 30 | 282929-3 |

There are 12 adhesive labels per sheet. Please ask for customized labeling.

Note: All part numbers are RoHS Compliant.

Accessories

Polarization Keys

Polarization keys help prevent wrong mating of two-piece Terminal Block connectors (not valid for special version).

Special keys allow you to differentiate counterparts, meeting OEMs' requirement for error-free interconnections.

Color – Red

For Plugs

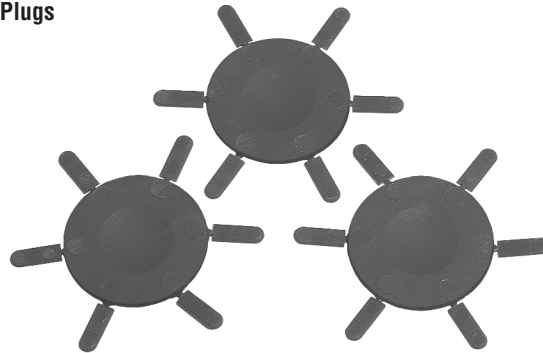

For Headers

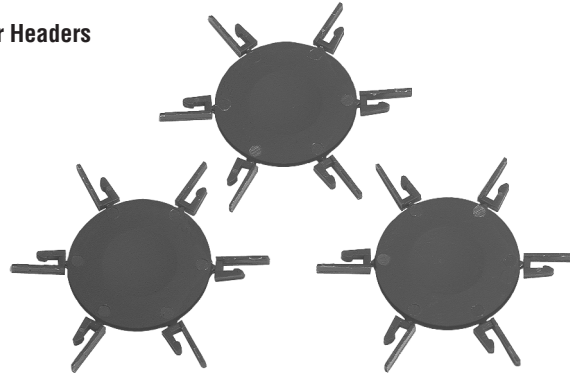

| Application | Part Number* |
|----------------------------------|--------------|
| Two-piece Terminal Block Plugs | 282969-1 |
| Two-piece Terminal Block Headers | 282970-1 |
| 3.5, 3.81 mm [.138, .150] Plug | 1546050-1 |
| 3.5, 3.81 mm [.138, .150] Header | 1546051-1 |

*Comprised of 1 Circular Carrier with 6 Keys.

Screwdrivers

Screwdrivers are additional accessories to facilitate the application of Terminal Block stacking connectors.

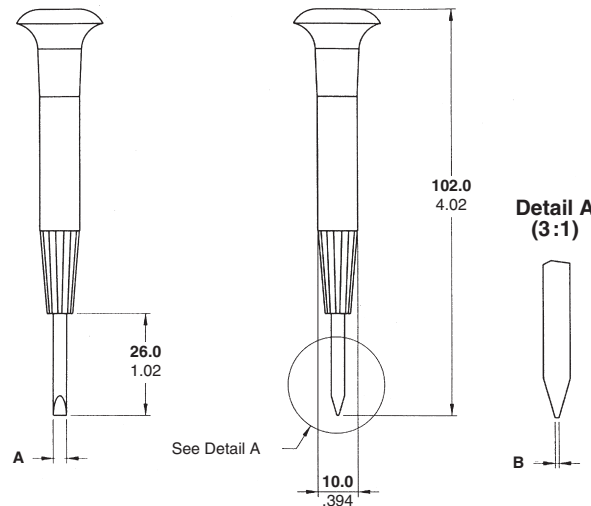

| Screw | Dimensions | | Part Number |
|--------------|------------|------------|-------------|
| | A | B | |
| M 1.6 [.063] | 1.8 [.071] | 0.3 [.012] | 785730-1 |
| M 3.0 [.118] | 2.5 [.098] | 0.6 [.024] | 785730-2 |

Accessories (Continued)

PLASTI-GRIP

Wire Pins

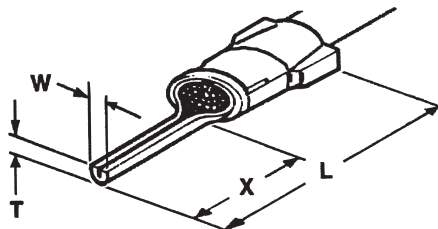

| Wire Size Range AWG | Wire Size (mm ²) | DIN Wire Size Range (mm ²) | Insulation Diameter Max. (mm ²) | Insulation Color | Dimensions | | | | Part Number | Packaging Unit | CERTI-CRIMP Hand Tool | |
|------------------------|---------------------------------|--|---|---------------------|------------|------------|------------|------------|----------------|-------------------|-----------------------------|---------|
| | | | | | X | W | T | L | | | | |
| 22-16 | 0.25-1.60 | 0.35-0.50-0.75- 1.00-1.50 | 0.5-1.0 | 3.7 | Red | 9.9 [.390] | 1.8 [.071] | 1.8 [.071] | 23.8 [.937] | 165167-0 | 100 | 47386 |
| 16-14 | 1.00-2.60 | 1.0-1.5-2.5 | >1.0-2.5 | 4.9 | Blue | 6.7 [.264] | 1.8 [.071] | 1.8 [.071] | 20.7 [.815] | 165075 | 100 | 47387-7 |
| | | | | | | 9.9 [.390] | 1.8 [.071] | 1.8 [.071] | 23.7 [.933] | 165171 | 100 | 47387-7 |
| 12-10 | 2.70-6.60 | 4.0-6.0 | >2.5-6.0 | 6.4 | Yellow | 9.9 [.390] | 2.6 [.102] | 2.6 [.102] | 29.2 [1.150] | 165085-0 | 100 | 59239-4 |

PIDG

Wire Pins

Material and Finish

Pin – Copper, tin plated
Insulation Sleeve –
Nylon

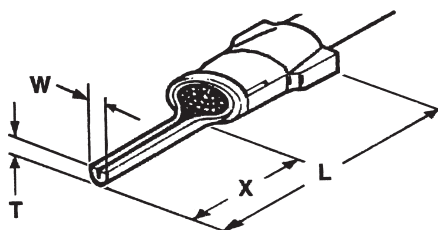

| Wire Size Range AWG | Wire Size (mm ²) | DIN Wire Size Range (mm ²) | Insulation Diameter Max. (mm ²) | Insulation Color | Dimensions | | | | Part Number | Packaging Unit | CERTI-CRIMP Hand Tool | |
|------------------------|---------------------------------|--|---|---------------------|------------|-------------|------------|------------|----------------|-------------------|-----------------------------|---------|
| | | | | | X | W | T | L | | | | |
| 26-22 | 0.10-0.40 | 0.14-0.20- 0.25-0.35 | 0.14-0.35 | 2.1 | Yellow | 6.7 [.264] | 1.1 [.043] | 1.1 [.043] | 18.2 [.717] | 165514-1 | 500 | 46121 |
| 22-16 | 0.25-1.60 | 0.35-0.50-0.75- 1.00-1.50 | 0.5-1.0 | 3.6 | Red | 6.7 [.264] | 1.8 [.071] | 1.8 [.071] | 19.7 [.776] | 165142-0 | 500 | 47386 |
| | | | | | | 9.9 [.390] | 1.9 [.075] | 1.8 [.071] | 22.9 [.902] | 165168-0 | 500 | 47386 |
| | | | | | | 6.7 [.264] | 1.8 [.071] | 1.8 [.071] | 20.3 [.799] | 165046-0 | 500 | 47387-7 |
| 16-14 | 1.00-2.60 | 1.0-1.5-2.5 | >1.0-2.5 | 4.3 | Blue | 9.9 [.390] | 1.8 [.071] | 1.8 [.071] | 23.6 [.929] | 165172-0 | 500 | 47387-7 |
| | | | | | | 15.2 [.598] | 2.7 [.106] | 2.3 [.091] | 29.1 [1.146] | 9-160402-2 | 500 | 47387-7 |
| 12-10 | 2.70-6.60 | 4.0-6.0 | >2.5-6.0 | 6.4 | Yellow | 9.9 [.390] | 2.6 [.102] | 2.6 [.102] | 28.5 [1.122] | 165049-0 | 500 | 59239-4 |

Related Product Data

For more information on AMP
Standard Terminals and Splices or
Quick-Connect FASTON Receptacles
and Tabs, request Catalog 82042.

Accessories (Continued)

Wire Ferrules

These Wire Ferrules, suitable for the most common wire range of 0.5 mm² through 10.0 mm², [20AWG-7AWG] are terminated with hand tools.

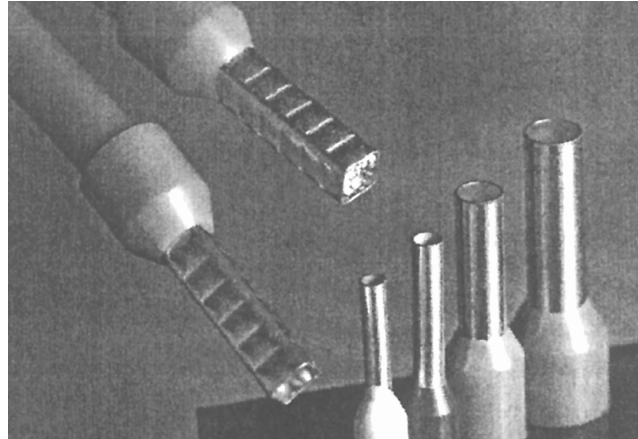

DIN Wire Ferrules Tubing Form with Plastic Sleeve According to DIN 46228, Part 4

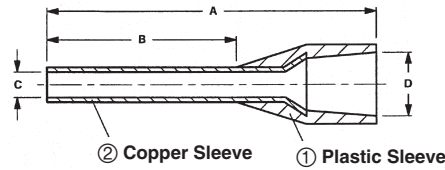

| Wire Size Range AWG (mm ²) | Insulation Diameter Max | Version | Insulation Color | Dimensions | | | | Strip Length | Part Number | Packaging Unit | |
|---|-------------------------|------------|------------------|------------|-------------|-------------|------------|--------------|-------------|----------------|-----|
| | | | | A | B | C | D | | | | |
| 20 | 0.50 | 2.3 [.091] | Normal | White | 14.0 [.551] | 8.0 [.315] | 1.0 [.039] | 2.6 [.102] | 10.0 [.394] | 966067-2 | 500 |
| 18 | 0.75 | 2.5 [.098] | Normal | Grey | 14.0 [.551] | 8.0 [.315] | 1.2 [.047] | 2.8 [.110] | 10.0 [.394] | 966067-5 | 500 |
| 17 | 1.00 | 2.7 [.106] | Normal | Red | 14.0 [.551] | 8.0 [.315] | 1.4 [.055] | 3.0 [.118] | 10.0 [.394] | 966067-9 | 500 |
| 16 | 1.50 | 3.2 [.126] | Normal | Black | 14.0 [.551] | 8.0 [.315] | 1.7 [.067] | 3.5 [.138] | 10.0 [.394] | 1-966067-2 | 500 |
| 14 | 2.50 | 3.9 [.154] | Normal | Blue | 14.0 [.551] | 8.0 [.315] | 2.2 [.087] | 4.2 [.165] | 10.0 [.394] | 1-966067-6 | 500 |
| 11 | 4.00 | 4.5 [.177] | Normal | Grey | 17.0 [.669] | 10.0 [.394] | 2.8 [.110] | 4.8 [.189] | 12.0 [.472] | 1-966067-9 | 500 |
| 10 | 6.00 | 6.0 [.236] | Normal | Yellow | 20.0 [.787] | 12.0 [.472] | 3.5 [.138] | 6.3 [.248] | 14.0 [.551] | 2-966067-2 | 100 |
| 7 | 10.00 | 7.3 [.287] | Normal | Red | 22.0 [.866] | 12.0 [.472] | 4.5 [.177] | 7.6 [.299] | 15.0 [.591] | 2-966067-4 | 100 |

Double Wire Ferrules Tubing Form with Plastic Sleeve, According to DIN 46228, Part 4

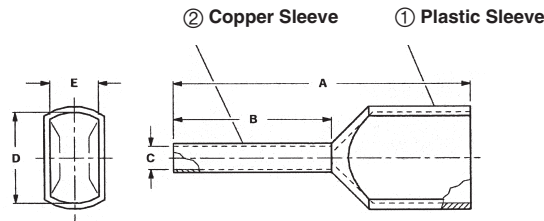

| Wire Size Range AWG (mm ²) | Insulation Diameter Max | Version | Insulation Color | Dimensions | | | | | Strip Length | Part Number | Packaging Unit | |
|---|-------------------------|------------|------------------|------------|-------------|-------------|-------------|------------|--------------|-------------|----------------|-----|
| | | | | A | B | C | D | E | | | | |
| 2 x 20 | 2 x 0.50 | 2.1 [.083] | Normal | White | 15.0 [.591] | 8.0 [.315] | 1.4 [.055] | 4.7 [.185] | 2.5 [.098] | 10.0 [.394] | 966144-1 | 500 |
| 2 x 18 | 2 x 0.75 | 2.2 [.087] | Normal | Grey | 15.0 [.591] | 8.0 [.315] | 1.7 [.067] | 5.0 [.197] | 2.8 [.110] | 10.0 [.394] | 966144-2 | 500 |
| 2 x 18 | 2 x 0.75 | 2.2 [.087] | Long | Grey | 17.0 [.669] | 10.0 [.394] | 1.7 [.067] | 5.0 [.197] | 2.8 [.110] | 12.0 [.472] | 966144-3 | 500 |
| 2 x 17 | 2 x 1.00 | 2.5 [.098] | Normal | Red | 15.0 [.591] | 8.0 [.315] | 1.95 [.077] | 5.4 [.213] | 3.4 [.134] | 10.0 [.394] | 966144-4 | 500 |
| 2 x 16 | 2 x 1.50 | 3.0 [.118] | Normal | Black | 16.0 [.630] | 8.0 [.315] | 2.2 [.087] | 6.6 [.260] | 3.6 [.142] | 10.0 [.394] | 966144-6 | 500 |
| 2 x 14 | 2 x 2.50 | 3.6 [.142] | Normal | Blue | 18.5 [.728] | 10.0 [.394] | 2.8 [.110] | 7.8 [.307] | 4.2 [.165] | 12.0 [.472] | 966144-8 | 250 |
| 2 x 11 | 2 x 4.00 | 4.1 [.161] | Normal | Grey | 23.0 [.906] | 12.0 [.472] | 3.7 [.146] | 8.8 [.346] | 4.9 [.193] | 14.0 [.551] | 1-966144-0 | 100 |

Note: All part numbers are RoHS Compliant.

Accessories (Continued)

DIN Tubular End Sleeve with Plastic Sleeve

According to DIN 46228, Part 4, in Strip Form

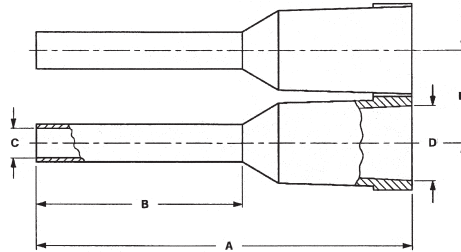

| Wire Size Range AWG (mm ²) | Insulation Diameter Max. | Insulation Color | Dimensions | | | | | Strip Length | Part Number | Packaging Unit |
|---|--------------------------|------------------|-------------|------------|------------|------------|------------|--------------|-------------|----------------|
| | | | A | B | C | D | E | | | |
| 20 0.50 | 2.4 [.094] | White | 14.5 [.571] | 8.0 [.315] | 1.1 [.043] | 2.8 [.110] | 3.5 [.138] | 10.0 [.394] | 1241000-1 | 1,000 |
| 18 0.75 | 2.6 [.102] | Grey | 14.5 [.571] | 8.0 [.315] | 1.3 [.051] | 2.9 [.114] | 3.5 [.138] | 10.0 [.394] | 1241001-1 | 1,000 |
| 17 1.00 | 2.9 [.114] | Red | 14.5 [.571] | 8.0 [.315] | 1.5 [.059] | 3.2 [.126] | 3.9 [.154] | 10.0 [.394] | 1241002-1 | 1,000 |
| 16 1.50 | 3.2 [.126] | Black | 14.5 [.571] | 8.0 [.315] | 1.8 [.071] | 3.4 [.134] | 4.1 [.161] | 10.0 [.394] | 1241003-1 | 1,000 |
| 14 2.50 | 4.0 [.157] | Blue | 14.5 [.571] | 8.0 [.315] | 2.3 [.091] | 4.3 [.169] | 5.0 [.197] | 10.0 [.394] | 1241004-1 | 500 |
| 14 2.50 | 4.0 [.157] | Grey | 14.5 [.571] | 8.0 [.315] | 2.3 [.091] | 4.3 [.169] | 5.0 [.197] | 10.0 [.394] | 1241004-2 | 500 |

Product Facts

- Self-adjusting rectangular crimp profile for DIN-style crimp
- Only two hand tools are needed to crimp wire sizes from 0.14 mm² through 10.0 mm²
- Adjustable crimp pressure
- Crimp control

Application Tooling

Crimp Hand Tool for Wire Ferrules

This newly designed self-adjusting die set offers a time-saving crimping process and uniform crimp. A ratchet system provides for a complete crimp cycle before releasing. The crimp is according to DIN specification.

The tool handles are contoured for comfort.

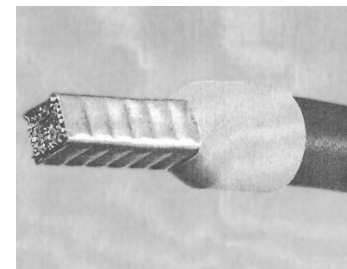
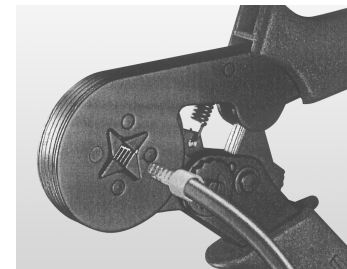
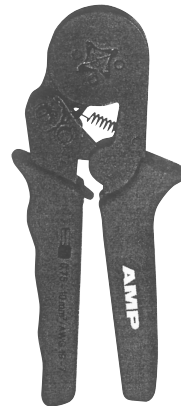

Loose Piece Tooling

| Wire Size Range (mm ²) | Part Number |
|------------------------------------|-------------|
| 0.14-6.00 | 539660-1 |
| 0.75-10.0 | 539661-1 |

Strip Form Tooling

| End Sleeve Part Number | Applicator Part No. | | |
|------------------------|---------------------|--------------|--------------|
| | CLS IV+ Lead Maker | K Terminator | G Terminator |
| 1241000-1 | —* | —* | —* |
| 1241001-1 | —* | —* | —* |
| 1241002-2 | —* | —* | —* |
| 1241003-1 | —* | —* | —* |
| 1241004-1 | —* | —* | —* |
| 1241004-2 | —* | —* | —* |

*Contact the Tooling Assistance Center for Part Number