



# ▶ Industrial Controls

CATALOG 803 NORTH AMERICAN EDITION

OUR COMMITMENT MAKES THE DIFFERENCE ▶

**BACO**<sup>®</sup>  
**CONTROLS**

## BACO fully committed into the future

A key player on the market for control and signalling units, cam switches and disconnect switches, BACO is recognized for its professional expertise and compliance with safety standards. BACO is committed to a quality charter based on the quality and reliability of its numerous and flexible solutions.

### CONTROL AND SIGNALING UNITS

#### ► A wide range

- Pushbuttons, Selector Switches, Emergency Stops and Pilot Lights
- Excellent modularity for a large choice of combinations with a minimum number of items
- Customized products to meet the most specific needs



### CAM SWITCHES

#### ► A reference on the market

- A worldwide reputation of know-how for more than 50 years
- A range from 10 to 63 A (panel mount or enclosed)
- More than 50,000 different electrical diagrams available
- Numerous specific functions and special engravings



### DISCONNECT SWITCHES

#### ► Great flexibility in use

- Compactness
- Flexible combinations for customized applications
- Reversible terminal blocks for front or rear mounting saving valuable time during installation



### THE BACO QUALITY COMMITMENT

BACO products have a 10-year guarantee and are exceptionally reliable, that is why they are ideal for integration into systems that do not tolerate any failure (military, aeronautical, space exploration, medical research equipment, etc.). Moreover, BACO product ranges offer ingenious and reliable solutions that are fast and easy to implement.

That's why BACO is now providing a 10-year guarantee on all products. This guarantee strengthens the assurance of having a solid and committed brand by your side. With BACO, you can be sure that you have made the right choice.

## General Terms and Conditions:

Please visit [www.bacocontrols.com](http://www.bacocontrols.com) for our current terms and conditions.

This publication is based on information available at the time of printing. Specifications, dimensions and other technical data subject to change without notice and without obligation.

# Contents

---

## 8 ► CONTROL AND SIGNALING UNITS Ø 22

Complete Devices - Non-illuminated heads Ø 22 .....	12
Complete Devices - Illuminated heads Ø 22 .....	21
Non-illuminated heads Ø 22 .....	29
Illuminated heads Ø 22 .....	48
Block sub-assemblies.....	57
Clips.....	68
Blocks.....	69
Legend Plates.....	76
Accessories.....	86
Din-Rail Assemblies.....	92
Control Stations .....	93
Empty Enclosures.....	100
Technical Specifications.....	106

## 120 ► CONTROL AND SIGNALING UNITS Ø 30

Complete Devices - Non-illuminated heads Ø 30 .....	121
Complete Devices - Illuminated heads Ø 30 .....	127
Non illuminated heads Ø 30 .....	133
Illuminated heads Ø 30 .....	141
Block sub-assemblies.....	57
Clips.....	68
Blocks.....	69
Legend Plates.....	145
Accessories.....	148
Control Stations .....	151
Empty Enclosures.....	153
Technical Specifications.....	154

## 157 ► DISCONNECT SWITCHES

25A / 32A.....	158
50A / 63A.....	172
80A / 100A.....	183
Technical Specifications.....	196

## 201 ► CAM SWITCHES

PR ONE CAM Switches.....	201
Mini Cam Switches.....	208
Single Hole Mounting Ø 22 (PR12).....	210
On/Off.....	212
Main Switches.....	214
Changeover without Off.....	216
Changeover with Off.....	218
Three Way with Off.....	220
Motor Switches.....	222
Ammeter / Voltmeter Switches.....	230
Binary Code Switches.....	233
Technical Specifications.....	234

# CATALOG PART NUMBER INDEX

PART NUMBER	PAGE	PART NUMBER	PAGE	PART NUMBER	PAGE	PART NUMBER	PAGE	PART NUMBER	PAGE	PART NUMBER	PAGE
<b>CONTROL AND SIGNALLING UNITS</b>		333E10.....	58	333EAWM20.....	62	333EDAWL01.....	67	333ERAWH10.....	64	33EAYH.....	71
455.....	89	333E11.....	58	333EAYH.....	61	333EDAWL10.....	66	333ERAWH11.....	65	33EAYL.....	71
1424A.....	89	333E12.....	58	333EAYH01.....	62	333EDAWL11.....	67	333ERAWL.....	64	33EAYL4.....	71
331E.....	68	333E20.....	58	333EAYH10.....	61	333EDAWM.....	66	333ERAWL01.....	65	33EAYM.....	71
331E01.....	58	333E21.....	58	333EAYH11.....	63	333EDAWM01.....	67	333ERAWL10.....	64	33EFH.....	75
331E01.....	58	333E30.....	58	333EAYH20.....	62	333EDAWM10.....	66	333ERAWL11.....	65	33EFM.....	75
331E10.....	58	333EABH01.....	62	333EAYL.....	61	333EDAWM11.....	67	333ERAWM.....	64	33EHC.....	74
331E10.....	58	333EABH10.....	61	333EAYL01.....	62	333EDAYH.....	66	333ERAWM01.....	65	33ELC.....	74
331EABH.....	61	333EABH11.....	63	333EAYL10.....	61	333EDAYH01.....	67	333ERAWM10.....	64	33ET.....	74
331EABL.....	61	333EABH20.....	62	333EAYL11.....	63	333EDAYH10.....	66	333ERAWM11.....	65	33ETT.....	74
331EABM.....	61	333EABL.....	61	333EAYL20.....	62	333EDAYH11.....	67	333ERAYH.....	64	33EX.....	75
331EAGH.....	61	333EABL01.....	62	333EAYM.....	61	333EDAYL.....	66	333ERAYH01.....	65	33EY.....	75
331EAGL.....	61	333EABL10.....	61	333EAYM01.....	62	333EDAYL01.....	67	333ERAYH10.....	64	33P01.....	70
331EAGM.....	61	333EABL11.....	63	333EAYM10.....	61	333EDAYL10.....	66	333ERAYH11.....	65	33P01Y7.....	70
331EARH.....	61	333EABL20.....	62	333EAYM11.....	63	333EDAYL11.....	67	333ERAYL.....	64	33P10.....	70
331EARL.....	61	333EABM.....	61	333EAYM20.....	62	333EDAYM.....	66	333ERAYL01.....	65	33P10Y7.....	70
331EARM.....	61	333EABM01.....	62	333ED01.....	60	333EDAYM01.....	67	333ERAYL10.....	64	33R01.....	69
331EAWH.....	61	333EABM10.....	61	333ED02.....	60	333EDAYM10.....	66	333ERAYL11.....	65	33R10.....	69
331EAWL.....	61	333EABM11.....	63	333ED03.....	60	333EDAYM11.....	67	333ERAYM.....	64	33RABH.....	72
331EAWM.....	61	333EABM20.....	62	333ED10.....	60	333ER01.....	59	333ERAYM01.....	65	33RABL.....	72
331EAYH.....	61	333EAGH.....	61	333ED11.....	60	333ER02.....	59	333ERAYM10.....	64	33RABM.....	72
331EAYL.....	61	333EAGH01.....	62	333ED20.....	60	333ER03.....	59	333ERAYM11.....	65	33RAGH.....	72
331EAYM.....	61	333EAGH10.....	61	333ED30.....	60	333ER10.....	59	334E11.....	58	33RAGL.....	72
331ED01.....	60	333EAGH11.....	63	333EDABH.....	66	333ER11.....	59	334E22.....	58	33RAGM.....	72
331ED10.....	60	333EAGH20.....	62	333EDABH01.....	67	333ER20.....	59	335E.....	68	33RARH.....	72
331EDABH.....	66	333EAGL.....	61	333EDABH10.....	66	333ER30.....	59	33D01.....	69	33RARL.....	72
331EDABL.....	66	333EAGL01.....	62	333EDABH11.....	67	333ERABH.....	64	33D10.....	69	33RARM.....	72
331EDABM.....	66	333EAGL10.....	61	333EDABL.....	66	333ERABH01.....	65	33DABH.....	72	33RAWH.....	72
331EDAGH.....	66	333EAGL11.....	63	333EDABL01.....	67	333ERABH10.....	64	33DABL.....	72	33RAWL.....	72
331EDAGL.....	66	333EAGL20.....	62	333EDABL10.....	66	333ERABH11.....	65	33DABM.....	72	33RAWM.....	72
331EDAGM.....	66	333EAGM.....	61	333EDABL11.....	67	333ERABL.....	64	33DAGH.....	72	33RAYH.....	72
331EDARH.....	66	333EAGM01.....	62	333EDABM.....	66	333ERABL01.....	65	33DAGL.....	72	33RAYL.....	72
331EDARL.....	66	333EAGM10.....	61	333EDABM01.....	67	333ERABL10.....	64	33DAGM.....	72	33RAYM.....	72
331EDARM.....	66	333EAGM11.....	63	333EDABM10.....	66	333ERABL11.....	65	33DARH.....	72	33RFH.....	75
331EDAWH.....	66	333EAGM20.....	62	333EDABM11.....	67	333ERABM.....	64	33DARL.....	72	33RFM.....	75
331EDAWL.....	66	333EARH.....	61	333EDAGH.....	66	333ERABM01.....	65	33DARM.....	72	33S01.....	70
331EDAWM.....	66	333EARH01.....	62	333EDAGH01.....	67	333ERABM10.....	64	33DAWH.....	72	33S10.....	70
331EDAYH.....	66	333EARH10.....	61	333EDAGH10.....	66	333ERABM11.....	65	33DAWL.....	72	33SABH.....	73
331EDAYL.....	66	333EARH11.....	63	333EDAGH11.....	67	333ERAGH.....	64	33DAWM.....	72	33SABL.....	73
331EDAYM.....	66	333EARL.....	61	333EDAGL.....	66	333ERAGH01.....	65	33DAYH.....	72	33SABM.....	73
331ER01.....	59	333EARL01.....	62	333EDAGL01.....	67	333ERAGH10.....	64	33DAYL.....	72	33SAGH.....	73
331ER10.....	59	333EARL10.....	61	333EDAGL10.....	66	333ERAGH11.....	65	33DAYM.....	72	33SAGL.....	73
331ERABH.....	64	333EARL11.....	63	333EDAGL11.....	67	333ERAGL.....	64	33E01.....	69	33SAGM.....	73
331ERABL.....	64	333EARL20.....	62	333EDAGM.....	66	333ERAGL01.....	65	33E01C.....	69	33SARH.....	73
331ERABM.....	64	333EARM.....	61	333EDAGM01.....	67	333ERAGL10.....	64	33E01Y7.....	69	33SARL.....	73
331ERAGH.....	64	333EARM01.....	62	333EDAGM10.....	66	333ERAGL11.....	65	33E10.....	69	33SARM.....	73
331ERAGL.....	64	333EARM10.....	61	333EDAGM11.....	67	333ERAGM.....	64	33E10Y7.....	69	33SAWH.....	73
331ERAGM.....	64	333EARM11.....	63	333EDARH.....	66	333ERAGM01.....	65	33E11.....	69	33SAWL.....	73
331ERARH.....	64	333EARM20.....	62	333EDARH01.....	67	333ERAGM10.....	64	33EABH.....	71	33SAWM.....	73
331ERARL.....	64	333EAWH.....	61	333EDARH10.....	66	333ERAGM11.....	65	33EABL.....	71	33SAYH.....	73
331ERARM.....	64	333EAWH01.....	62	333EDARH11.....	67	333ERARH.....	64	33EABL4.....	71	33SAYL.....	73
331ERAWH.....	64	333EAWH10.....	61	333EDARL.....	66	333ERARH01.....	65	33EABM.....	71	33SAYM.....	73
331ERAWL.....	64	333EAWH11.....	63	333EDARL01.....	67	333ERARH10.....	64	33EAGH.....	71	907150RED.....	140
331ERAWM.....	64	333EAWH20.....	62	333EDARL10.....	66	333ERARH11.....	65	33EAGL.....	71	BNT206.....	105
331ERAYH.....	64	333EAWL.....	61	333EDARL11.....	67	333ERARL.....	64	33EAGL4.....	71	BNT210.....	105
331ERAYL.....	64	333EAWL01.....	62	333EDARM.....	66	333ERARL01.....	65	33EAGM.....	71	BNT215.....	105
331ERAYM.....	64	333EAWL10.....	61	333EDARM01.....	67	333ERARL10.....	64	33EARH.....	71	BNT217.....	105
333E.....	68	333EAWL11.....	63	333EDARM10.....	66	333ERARL11.....	65	33EARL.....	71	BNT220.....	105
333E01.....	58	333EAWL20.....	62	333EDAWH.....	66	333ERARM.....	64	33EARL4.....	71	BNT223.....	105
333E02.....	58	333EAWM.....	61	333EDAWH01.....	67	333ERARM01.....	65	33EARM.....	71	BNT225.....	105
333E03.....	58	333EAWM01.....	62	333EDAWH10.....	66	333ERARM10.....	64	33EAWH.....	71	BNT226.....	105
		333EAWM10.....	61	333EDAWHT1.....	67	333ERAWH.....	64	33EAWL.....	71	BNT227.....	105
		333EAWM11.....	63	333EDAWL.....	66	333ERAWH01.....	65	33EAWL4.....	71	BNT231.....	105
								33EAWM.....	71	BNT237.....	105

# CATALOG PART NUMBER INDEX

PART NUMBER	PAGE	PART NUMBER	PAGE	PART NUMBER	PAGE	PART NUMBER	PAGE	PART NUMBER	PAGE	PART NUMBER	PAGE
BNT240.....	105	L21AC02.....	33	L21KA08.....	38	L21LD00.....	43	L21NE00.....	44	L22AM04A.....	30
BNT242.....	105	L21AC03.....	33	L21KB01.....	38	L21LF00.....	43	L21NJ00.....	44	L22AM05A.....	30
BNT243.....	105	L21AC04.....	33	L21KB02.....	38	L21LG00.....	43	L21NK00.....	44	L22AM06A.....	30
BNT253.....	105	L21AD01.....	33	L21KB03.....	38	L21LH00.....	43	L21NL00.....	44	L22AQ10.....	48
BNT254.....	105	L21AD01S.....	33	L21KB08.....	38	L21LK00.....	43	L21RP03.....	47	L22AQ20.....	48
BNT255.....	105	L21AD02.....	33	L21KC01.....	38	L21MA01.....	40	L21TA03.....	42	L22AQ40.....	48
BPA201.....	105	L21AD03.....	33	L21KC02.....	38	L21MA02.....	40	L21TB03.....	42	L22AQ50.....	48
BPA202.....	105	L21AD04.....	33	L21KC03.....	38	L21MA03.....	40	L21TF03.....	42	L22AQ60.....	48
BPA203.....	105	L21AD06.....	33	L21KC08.....	38	L21MA08.....	40	L21UA03.....	42	L22AW01.....	31
BPA206.....	105	L21AE01.....	33	L21KD01.....	38	L21MB01.....	40	L21UB03.....	42	L22AW02.....	31
BPA208.....	105	L21AE03.....	33	L21KD02.....	38	L21MB02.....	40	L21UC03.....	42	L22AW03.....	31
BPA301.....	153	L21AH00.....	48	L21KD03.....	38	L21MB03.....	40	L21UD03.....	42	L22AX01.....	31
BPA302.....	153	L21AH10.....	48	L21KD08.....	38	L21MB08.....	40	L21UK03.....	42	L22AX02.....	31
BPA303.....	153	L21AH20.....	48	L21KE01.....	38	L21MC01.....	40	L21VB03.....	46	L22AX03.....	31
BPA306.....	153	L21AH40.....	48	L21KE02.....	38	L21MC02.....	40	L22AA00.....	29	L22AX04.....	31
BPA308.....	153	L21AH50.....	48	L21KE03.....	38	L21MC03.....	40	L22AA01.....	29	L22AX05.....	31
BPP201.....	153	L21AH60.....	48	L21KE08.....	38	L21MC08.....	40	L22AA02.....	29	L22AX06.....	31
BPP202.....	153	L21AK10.....	49	L21KF01.....	38	L21MD01.....	40	L22AA03.....	29	L22AZ10.....	49
BPP203.....	153	L21AK20.....	49	L21KF02.....	38	L21MD02.....	40	L22AA04.....	29	L22AZ20.....	49
BPP204.....	153	L21AK40.....	49	L21KF03.....	38	L21MD03.....	40	L22AA05.....	29	L22AZ40.....	49
BPP210.....	153	L21AK50.....	49	L21KF08.....	38	L21MD08.....	40	L22AA06.....	29	L22AZ50.....	49
BPP301.....	153	L21AK60.....	49	L21KG10.....	53	L21ME10.....	54	L22AA81.....	29	L22AZ60.....	49
BPP302.....	153	L21AL10.....	50	L21KG20.....	53	L21ME20.....	54	L22AA82.....	29	L22CA01.....	34
BPP303.....	153	L21AL20.....	50	L21KG30.....	53	L21ME30.....	54	L22AA83.....	29	L22CA02.....	34
BPP304.....	153	L21AL40.....	50	L21KH10.....	53	L21MF10.....	54	L22AB01.....	31	L22CA03.....	34
BPP310.....	153	L21AL50.....	50	L21KH20.....	53	L21MF20.....	54	L22AB01B.....	31	L22CA04.....	34
L20SC10H.....	56	L21CA01.....	34	L21KH30.....	53	L21MF30.....	54	L22AB02.....	31	L22CA05.....	34
L20SC10L.....	56	L21CA02.....	34	L21KJ10.....	53	L21MG10.....	54	L22AB03.....	31	L22CA06.....	34
L20SC10M.....	56	L21CA03.....	34	L21KJ20.....	53	L21MG20.....	54	L22AB04.....	31	L22CB01.....	34
L20SC20H.....	56	L21CA04.....	34	L21KJ30.....	53	L21MG30.....	54	L22AB05.....	31	L22CB02.....	34
L20SC20L.....	56	L21CA05.....	34	L21KK10.....	53	L21MH10.....	54	L22AB06.....	31	L22CB03.....	34
L20SC20M.....	56	L21CA06.....	34	L21KK20.....	53	L21MH20.....	54	L22AC01.....	33	L22CB04.....	34
L20SC40H.....	56	L21CB01.....	34	L21KK30.....	53	L21MH30.....	54	L22AC02.....	33	L22CB05.....	34
L20SC40L.....	56	L21CB02.....	34	L21KL10.....	53	L21MJ10.....	54	L22AC03.....	33	L22CB06.....	34
L20SC40M.....	56	L21CB03.....	34	L21KL20.....	53	L21MJ20.....	54	L22AC04.....	33	L22CH10.....	51
L20SC50H.....	56	L21CB04.....	34	L21KL30.....	53	L21MJ30.....	54	L22AD01.....	33	L22CH20.....	51
L20SC50L.....	56	L21CB05.....	34	L21KM10.....	53	L21MK01.....	40	L22AD01S.....	33	L22CH40.....	51
L20SC50M.....	56	L21CB06.....	34	L21KM20.....	53	L21MK02.....	40	L22AD02.....	33	L22CH50.....	51
L20SC60H.....	56	L21CH10.....	51	L21KM30.....	53	L21MK03.....	40	L22AD03.....	33	L22CH60.....	51
L20SC60L.....	56	L21CH20.....	51	L21KP01.....	39	L21MK08.....	40	L22AD04.....	33	L22CK10.....	51
L20SC60M.....	56	L21CH40.....	51	L21KP02.....	39	L21ML30.....	55	L22AD06.....	33	L22CK20.....	51
L20SE10.....	55	L21CH50.....	51	L21KP03.....	39	L21MM30.....	55	L22AE01.....	33	L22CK40.....	51
L20SE20.....	55	L21CH60.....	51	L21KP08.....	39	L21MN30.....	55	L22AE03.....	33	L22CK50.....	51
L20SE40.....	55	L21CK10.....	51	L21KQ01.....	39	L21MP30.....	55	L22AH00.....	48	L22CK60.....	51
L20SE50.....	55	L21CK20.....	51	L21KQ02.....	39	L21MR01.....	41	L22AH10.....	48	L22DC01.....	34
L20SE60.....	55	L21CK40.....	51	L21KQ03.....	39	L21MR02.....	41	L22AH20.....	48	L22DD01.....	35
L21AA00.....	29	L21CK50.....	51	L21KR01.....	39	L21MR03.....	41	L22AH40.....	48	L22DD01C.....	35
L21AA01.....	29	L21CK60.....	51	L21KR02.....	39	L21MR08.....	41	L22AH50.....	48	L22DD01S.....	35
L21AA02.....	29	L21HA01.....	45	L21KR03.....	39	L21MS01.....	41	L22AH60.....	48	L22DD02.....	35
L21AA03.....	29	L21HA02.....	45	L21KS01.....	39	L21MS02.....	41	L22AK10.....	49	L22DD03.....	35
L21AA04.....	29	L21HA03.....	45	L21KS02.....	39	L21MS03.....	41	L22AK20.....	49	L22DD04.....	35
L21AA05.....	29	L21HA04.....	45	L21KS03.....	39	L21MS08.....	41	L22AK40.....	49	L22DL10.....	52
L21AA06.....	29	L21HA05.....	45	L21KT01.....	39	L21MT01.....	41	L22AK50.....	49	L22DM10.....	52
L21AA81.....	29	L21HA06.....	45	L21KT02.....	39	L21MT02.....	41	L22AK60.....	49	L22DM20.....	52
L21AA82.....	29	L21HA363949.....	45	L21KT03.....	39	L21MT03.....	41	L22AL10.....	50	L22DM40.....	52
L21AA83.....	29	L21HB01.....	45	L21KU01.....	39	L21MT08.....	41	L22AL20.....	50	L22DM50.....	52
L21AB01.....	31	L21HB02.....	45	L21KU02.....	39	L21MU01.....	41	L22AL40.....	50	L22DN10.....	53
L21AB01B.....	31	L21HB03.....	45	L21KU03.....	39	L21MU02.....	41	L22AL50.....	50	L22DQ01.....	36
L21AB02.....	31	L21HB04.....	45	L21KV30.....	54	L21MU03.....	41	L22AM01.....	30	L22DR01.....	36
L21AB03.....	31	L21HB05.....	45	L21KX30.....	54	L21MU08.....	41	L22AM01A.....	30	L22DU01.....	37
L21AB04.....	31	L21HB06.....	45	L21KY30.....	54	L21NA00.....	44	L22AM02.....	30	L22DU01A.....	37
L21AB05.....	31	L21KA01.....	38	L21LA00.....	43	L21NB00.....	44	L22AM02A.....	30	L22EC01.....	34
L21AB06.....	31	L21KA02.....	38	L21LB00.....	43	L21NC00.....	44	L22AM03.....	30	L22EC02.....	34
L21AC01.....	33	L21KA03.....	38	L21LC00.....	43	L21ND00.....	44	L22AM03A.....	30	L22EC03.....	34



# CATALOG PART NUMBER INDEX

PART NUMBER	PAGE	PART NUMBER	PAGE	PART NUMBER	PAGE	PART NUMBER	PAGE	PART NUMBER	PAGE	PART NUMBER	PAGE
L22EC04.....	34	L22KJ30.....	53	L22MG30.....	54	L23CH10.....	49	LBX10110.....	94	LWA0204.....	87
L22ED01.....	35	L22KK10.....	53	L22MH10.....	54	L23CH20.....	49	LBX101910.....	95	LWA0205.....	87
L22ED01G.....	35	L22KK20.....	53	L22MH20.....	54	L23CH40.....	49	LBX101910S.....	95	LWA0209.....	89
L22ED01S.....	35	L22KK30.....	53	L22MH30.....	54	L23CH50.....	49	LBX10210.....	94	LWA0215.....	91
L22ED02.....	35	L22KL10.....	53	L22MJ10.....	54	L23CH60.....	49	LBX10510.....	95	LWA0216.....	91
L22ED03.....	35	L22KL20.....	53	L22MJ20.....	54	L61BA22.....	33	LBX10510S.....	95	LWA0219.....	90
L22ED04.....	35	L22KL30.....	53	L22MJ30.....	54	L61BA22B.....	33	LBX10610.....	94	LWA0220.....	90
L22EL10.....	52	L22KM10.....	53	L22MK01.....	40	L61BA22F.....	33	LBX107210.....	94	LWA0223.....	87
L22EL20.....	52	L22KM20.....	53	L22MK02.....	40	L61BA22G.....	33	LBX11210.....	96	LWA0225.....	88
L22EL40.....	52	L22KM30.....	53	L22MK03.....	40	L61QA21.....	32	LBX11301.....	97	LWA0226.....	90
L22EM10.....	52	L22KP01.....	39	L22MK08.....	40	L61QA21B.....	32	LBX11302.....	97	LWA0228.....	87
L22EM20.....	52	L22KP02.....	39	L22ML30.....	55	L61QA21V.....	32	LBX11311.....	97	LWA0229.....	91
L22EM40.....	52	L22KP03.....	39	L22MM30.....	55	L61QA22.....	32	LBX12510.....	94	LWA0230.....	90
L22ER01.....	37	L22KP08.....	39	L22MN30.....	55	L61QA22K.....	32	LBX12610.....	94	LWA0234.....	88
L22ER01F.....	37	L22KQ01.....	39	L22MP30.....	55	L61QA33C.....	32	LBX130003.....	95	LWA0237.....	89
L22ER01K.....	37	L22KQ02.....	39	L22MR01.....	41	L61QA53.....	32	LBX130004.....	95	LWA0238.....	90
L22GM01.....	35	L22KQ03.....	39	L22MR02.....	41	L61QB21.....	32	LBX130005.....	95	LWA0238-101.....	92
L22GQ01.....	36	L22KR01.....	39	L22MR03.....	41	L61QB21B.....	32	LBX130006.....	95	LWA0238-104.....	92
L22GR01.....	37	L22KR02.....	39	L22MR08.....	41	L61QH21.....	50	LBX130007.....	95	LWA0238-301.....	92
L22HA01.....	45	L22KR03.....	39	L22MS01.....	41	L61QH21A.....	50	LBX130009.....	95	LWA0238-401.....	92
L22HA02.....	45	L22KS01.....	39	L22MS02.....	41	L61QH22A.....	50	LBX130010.....	95	LWA0238-402.....	92
L22HA03.....	45	L22KS02.....	39	L22MS03.....	41	L61QH22V.....	50	LBX130028.....	94	LWA0240.....	88
L22HA04.....	45	L22KS03.....	39	L22MS08.....	41	L61QK21.....	50	LBX130057.....	96	LWA0251.....	87
L22HA05.....	45	L22KT01.....	39	L22MT01.....	41	L61QK21A.....	50	LBX130065.....	96	LWA0252.....	87
L22HA06.....	45	L22KT02.....	39	L22MT02.....	41	L61QK53.....	50	LBX130066.....	96	LWA0253.....	87
L22HA363949.....	45	L22KT03.....	39	L22MT03.....	41	L61QM21.....	32	LBX130067.....	96	LWA0255.....	87
L22HB01.....	45	L22KU01.....	39	L22MT08.....	41	L61QM21B.....	32	LBX130068.....	96	LWB11.....	81
L22HB02.....	45	L22KU02.....	39	L22MU01.....	41	L61QN21.....	50	LBX130069.....	96	LWB12.....	81
L22HB03.....	45	L22KU03.....	39	L22MU02.....	41	L61QN21A.....	50	LBX130071.....	96	LWB13.....	81
L22HB04.....	45	L22KV30.....	54	L22MU03.....	41	L62BA22.....	33	LBX130072.....	96	LWB14.....	81
L22HB05.....	45	L22KX30.....	54	L22MU08.....	41	L62BA22A.....	33	LBX130074.....	95	LWB16.....	81
L22HB06.....	45	L22KY30.....	54	L22NA00.....	44	L62BA22B.....	33	LBX130075.....	95	LWB19.....	81
L22KA01.....	38	L22LA00.....	43	L22NB00.....	44	L62BA22F.....	33	LBX14101.....	97	LWE16.....	81
L22KA02.....	38	L22LB00.....	43	L22NC00.....	44	L62BA22G.....	33	LBX14102.....	97	LWE16100.....	80
L22KA03.....	38	L22LC00.....	43	L22ND00.....	44	L62QA21.....	32	LBX14111.....	97	LWE16200.....	80
L22KA08.....	38	L22LD00.....	43	L22NE00.....	44	L62QA21B.....	32	LBX14201.....	97	LWE16300.....	80
L22KB01.....	38	L22LF00.....	43	L22NJ00.....	44	L62QA21V.....	32	LBX14202.....	97	LWE16400.....	80
L22KB02.....	38	L22LG00.....	43	L22NK00.....	44	L62QA22.....	32	LBX14211.....	97	LWE60.....	80
L22KB03.....	38	L22LH00.....	43	L22NL00.....	44	L62QA22K.....	32	LBX15301.....	97	LWE60100.....	80
L22KB08.....	38	L22LK00.....	43	L22RP03.....	47	L62QA33.....	32	LBX15302.....	97	LWE60200.....	80
L22KC01.....	38	L22MA01.....	40	L22TA03.....	42	L62QA33C.....	32	LBX15311.....	97	LWE60300.....	80
L22KC02.....	38	L22MA02.....	40	L22TB03.....	42	L62QA53.....	32	LBX17301.....	96	LWE60431.....	80
L22KC03.....	38	L22MA03.....	40	L22TF03.....	42	L62QB21.....	32	LBX17302.....	96	LWE60900.....	80
L22KC08.....	38	L22MA08.....	40	L22UA03.....	42	L62QB21B.....	32	LBX17311.....	96	LWE70.....	80
L22KD01.....	38	L22MB01.....	40	L22UB03.....	42	L62QH21.....	50	LBX20120.....	98	LWE70300.....	80
L22KD02.....	38	L22MB02.....	40	L22UC03.....	42	L62QH21A.....	50	LBX201660.....	98	LWE70900.....	80
L22KD03.....	38	L22MB03.....	40	L22UD03.....	42	L62QH22A.....	50	LBX210770.....	98	LWE80.....	80
L22KD08.....	38	L22MB08.....	40	L22UK03.....	42	L62QH22V.....	50	LBX30008.....	99	LWE80300.....	80
L22KE01.....	38	L22MC01.....	40	L22VA03H.....	46	L62QK21.....	50	LBX30430.....	99	LWE80431.....	80
L22KE02.....	38	L22MC02.....	40	L22VA03L.....	46	L62QK21A.....	50	LBX308830.....	99	LWE80900.....	80
L22KE03.....	38	L22MC03.....	40	L22VA03M.....	46	L62QK53.....	50	LBX323870.....	99	LWG3.....	78
L22KE08.....	38	L22MC08.....	40	L23AA01.....	31	L62QM21.....	32	LM11.....	74	LWG31.....	76
L22KF01.....	38	L22MD01.....	40	L23AA02.....	31	L62QM21B.....	32	LM2A.....	47	LWG33.....	76
L22KF02.....	38	L22MD02.....	40	L23AA03.....	31	L62QN21.....	50	LM2F.....	47	LWG35.....	76
L22KF03.....	38	L22MD03.....	40	L23AA04.....	31	L62QN21A.....	50	LM4A.....	47	LWG37.....	76
L22KF08.....	38	L22MD08.....	40	L23AA05.....	31	LBX0100.....	100	LM4F.....	47	LWG39.....	76
L22KG10.....	53	L22ME10.....	54	L23AA06.....	31	LBX0100J.....	100	LMAC.....	47	LWP2.....	78
L22KG20.....	53	L22ME20.....	54	L23AA81.....	31	LBX0100JB.....	100	LME3.....	68	LWP21.....	77
L22KG30.....	53	L22ME30.....	54	L23AA82.....	31	LBX0100NR.....	100	LME5.....	68	LWP23.....	77
L22KH10.....	53	L22MF10.....	54	L23AH10.....	49	LBX0200.....	100	LMV2A.....	47	LWP25.....	77
L22KH20.....	53	L22MF20.....	54	L23AH20.....	49	LBX0200J.....	100	LMV2F.....	47	LWP27.....	77
L22KH30.....	53	L22MF30.....	54	L23AH40.....	49	LBX0300.....	100	LMV4A.....	47	LWP29.....	77
L22KJ10.....	53	L22MG10.....	54	L23AH50.....	49	LBX0400.....	101	LMV4F.....	47	LWP3.....	78
L22KJ20.....	53	L22MG20.....	54	L23AH60.....	49	LBX0500.....	101	LWA0203.....	87	LWP31.....	76

# CATALOG PART NUMBER INDEX

PART NUMBER	PAGE	PART NUMBER	PAGE	PART NUMBER	PAGE	PART NUMBER	PAGE	PART NUMBER	PAGE	PART NUMBER	PAGE
LWP33.....	76	T11AK30.....	14	T11HG04.....	140	T11MD03.....	136	UA0011.....	149	0165229LS.....	177
LWP35.....	76	T11AK40.....	141	T11HG05.....	140	T11MD08.....	136	UA0012.....	149	0165229NS.....	175
LWP37.....	76	T11AK50.....	141	T11HG06.....	140	T11ME10.....	143	UA0013.....	149	0165229SS.....	176
LWP39.....	76	T11AK60.....	141	T11KA01.....	136	T11ME20.....	143	UA0014.....	149	0165239LS.....	177
LWP4.....	78	T11AM10.....	142	T11KA03.....	136	T11ME50.....	143	UA0016.....	149	0165239NS.....	175
LWP41.....	77	T11AM20.....	142	T11KA08.....	136	T11MG10.....	143	UA0202.....	149	0165239SS.....	176
LWP43.....	77	T11AM40.....	142	T11KB01.....	136	T11MG20.....	143	UA0209.....	150	0165309LS.....	177
LWP45.....	77	T11AM50.....	142	T11KB03.....	136	T11MG50.....	143	UA0215.....	150	0165309NS.....	175
LWP47.....	77	T11AP10.....	141	T11KB08.....	136	T11MH10.....	143	UA0219.....	149	0165309SS.....	176
LWP49.....	77	T11AP20.....	141	T11KC01.....	136	T11MH20.....	143	UA0225.....	150	0165319LS.....	177
M20-BK.....	91	T11AP30.....	141	T11KC03.....	136	T11MH50.....	143	UA0228.....	149	0165319NS.....	175
PG11-GY.....	91	T11AP40.....	141	T11KC08.....	136	T11MJ10.....	143	UE00300.....	145	0165319SS.....	176
PG13-GY.....	91	T11AP50.....	141	T11KD01.....	136	T11MJ20.....	143	UG3.....	147	0165329LS.....	177
PG16-GY.....	91	T11AP60.....	141	T11KD03.....	136	T11MJ50.....	143	UG31.....	146	0165329NS.....	175
PG21-GY.....	91	T11CB01.....	134	T11KD08.....	136	T11MK01.....	136	UG33.....	146	0165329SS.....	176
PG29-GY.....	91	T11CB02.....	134	T11KE01.....	136	T11MK03.....	136	UG37.....	146	0165339LS.....	177
T10SA10.....	144	T11CB03.....	134	T11KE03.....	136	T11MK08.....	136	UG39.....	146	0165339NS.....	175
T10SA20.....	144	T11CB04.....	134	T11KE08.....	136	T11MR01.....	137	UP3.....	147	0165339SS.....	176
T10SA30.....	144	T11CB05.....	134	T11KF01.....	136	T11MR03.....	137	UP31.....	146	0165409LS.....	188
T10SA40.....	144	T11CB06.....	134	T11KF03.....	136	T11MR08.....	137	UP33.....	146	0165409NS.....	186
T10SA50.....	144	T11CK10.....	142	T11KF08.....	136	T11MT01.....	137	UP37.....	146	0165409SS.....	187
T10SA60.....	144	T11CK20.....	142	T11KG10.....	143	T11MT03.....	137	UP39.....	146	0165419LS.....	188
T10SB10.....	144	T11CK30.....	142	T11KG20.....	143	T11MT08.....	137	UWE60.....	145	0165419NS.....	186
T10SB20.....	144	T11CK40.....	142	T11KG50.....	143	T11MU01.....	137	UWE60300.....	145	0165419SS.....	187
T10SB30.....	144	T11CK50.....	142	T11KJ10.....	143	T11MU03.....	137	UWE60431.....	145	0165429LS.....	188
T10SB40.....	144	T11DD01.....	135	T11KJ20.....	143	T11MU08.....	137	UWE70.....	145	0165429NS.....	186
T10SB50.....	144	T11DD01S.....	135	T11KJ50.....	143	T11MW01.....	137	UWE70300.....	145	0165429SS.....	187
T10SB60.....	144	T11DD02.....	135	T11KK10.....	143	T11MW02.....	137	UWE80300.....	145	0165439LS.....	188
T11AA01.....	133	T11DD03.....	135	T11KK20.....	143	T11MW03.....	137	UWE80431.....	145	0165439NS.....	186
T11AA02.....	133	T11DD04.....	135	T11KK50.....	143	T11NA00.....	138	WA0210.....	88	0165439SS.....	187
T11AA03.....	133	T11ED01.....	135	T11KM10.....	143	T11NC00.....	138			0165509LS.....	188
T11AA04.....	133	T11ED01S.....	135	T11KM20.....	143	T11ND00.....	138			0165509NS.....	186
T11AA05.....	133	T11ED02.....	135	T11KM50.....	143	T11NK00.....	138			0165509SS.....	187
T11AA06.....	133	T11ED03.....	135	T11KP01.....	137	T15AA01.....	133			0165519LS.....	188
T11AA81.....	133	T11ED04.....	135	T11KP03.....	137	T15AA02.....	133	0165009LS.....	165	0165519NS.....	186
T11AA82.....	133	T11FD01.....	135	T11KP08.....	137	T15AA03.....	133	0165009NS.....	163	0165519SS.....	187
T11AA83.....	133	T11FD01S.....	135	T11KQ01.....	137	T15AA04.....	133	0165009SS.....	164	0165529LS.....	188
T11AB01.....	133	T11FD02.....	135	T11KQ03.....	137	T15AA05.....	133	0165019LS.....	165	0165529NS.....	186
T11AB02.....	133	T11FD03.....	135	T11KQ08.....	137	T15AA06.....	133	0165019NS.....	163	0165529SS.....	187
T11AB03.....	133	T11FD04.....	135	T11KR01.....	137	T15A10.....	144	0165019SS.....	164	0165539LS.....	188
T11AB04.....	133	T11GF00.....	139	T11KR03.....	137	T15A20.....	144	0165029LS.....	165	0165539NS.....	186
T11AB05.....	133	T11GG00.....	139	T11KR08.....	137	T15A30.....	144	0165029NS.....	163	0165539SS.....	187
T11AB06.....	133	T11GH00.....	139	T11KS01.....	137	T15A40.....	144	0165029SS.....	164	0168009LS.....	165
T11AD01.....	134	T11GJ00.....	139	T11KS03.....	137	T15A50.....	144	0165039LS.....	165	0168009NS.....	163
T11AD01S.....	134	T11GK00.....	139	T11KS08.....	137	T15A60.....	144	0165039NS.....	163	0168009SS.....	164
T11AD02.....	134	T11GL00.....	139	T11KT01.....	137	T15SB10.....	144	0165039SS.....	164	0168019LS.....	165
T11AD03.....	134	T11GM00.....	139	T11KT03.....	137	T15SB20.....	144	0165109LS.....	165	0168019NS.....	163
T11AD04.....	134	T11GM01.....	135	T11KT08.....	137	T15SB30.....	144	0165109NS.....	163	0168019SS.....	164
T11AE01.....	134	T11GP01.....	135	T11KU01.....	137	T15SB40.....	144	0165109SS.....	164	0168029LS.....	165
T11AE03.....	134	T11HA01.....	140	T11KU03.....	137	T15SB60.....	144	0165119LS.....	165	0168029NS.....	163
T11AG01.....	133	T11HA02.....	140	T11KU08.....	137	T52QA02.....	134	0165119NS.....	163	0168029SS.....	164
T11AG02.....	133	T11HA03.....	140	T11LA00.....	138	T52QA20.....	134	0165119SS.....	164	0168039LS.....	165
T11AG03.....	133	T11HA04.....	140	T11LB00.....	138	TBPA301-101.....	151	0165129LS.....	165	0168039NS.....	163
T11AG04.....	133	T11HA05.....	140	T11LC00.....	138	TBPA301-104.....	151	0165129NS.....	163	0168039SS.....	164
T11AG05.....	133	T11HA06.....	140	T11LD00.....	138	TBPA301-201.....	151	0165129SS.....	164	0168109LS.....	165
T11AG06.....	133	T11HB01.....	140	T11LF00.....	138	TBPA301-204.....	151	0165139LS.....	165	0168109NS.....	163
T11AH10.....	141	T11HB02.....	140	T11LG00.....	138	TBPA301-301.....	152	0165139NS.....	163	0168109SS.....	164
T11AH20.....	141	T11HB03.....	140	T11MA01.....	136	TBPA301-311.....	152	0165139SS.....	164	0168119LS.....	165
T11AH30.....	141	T11HB04.....	140	T11MA03.....	136	TBPA301-321.....	152	0165209LS.....	177	0168119NS.....	163
T11AH40.....	141	T11HB05.....	140	T11MA08.....	136	TBPA301-401.....	151	0165209NS.....	175	0168119SS.....	164
T11AH50.....	141	T11HB06.....	140	T11MC01.....	136	TBPA302-001.....	152	0165209SS.....	176	0168129LS.....	165
T11AH60.....	141	T11HG01.....	140	T11MC03.....	136	TBPA302-002.....	152	0165219LS.....	177	0168129NS.....	163
T11AK10.....	14	T11HG02.....	140	T11MC08.....	136	TBPA302-002.....	152	0165219NS.....	175	0168129SS.....	164
T11AK20.....	14	T11HG03.....	140	T11MD01.....	136	TBPA304-402.....	151	0165219SS.....	176	0168139LS.....	165

## DISCONNECT SWITCHES

# CATALOG PART NUMBER INDEX

PART NUMBER	PAGE	PART NUMBER	PAGE	PART NUMBER	PAGE	PART NUMBER	PAGE	PART NUMBER	PAGE	PART NUMBER	PAGE
0168139NS.....	163	0172024.....	161	0172232.....	173	0172492.....	190	0174091.....	166	0174321.....	172
0168139SS.....	164	0172029.....	166	0172239.....	179	0172500.....	191	0174092.....	167	0174322.....	173
0168209LS.....	177	0172031.....	158	0172261.....	178	0172501.....	183	0174101.....	158	0174325.....	174
0168209NS.....	175	0172032.....	159	0172262.....	179	0172502.....	184	0174102.....	159	0174329.....	178
0168209SS.....	176	0172033.....	160	0172265.....	180	0172509.....	189	0174105.....	162	0174331.....	172
0168219LS.....	177	0172039.....	167	0172267.....	171	0172511.....	183	0174109.....	166	0174332.....	173
0168219NS.....	175	0172061.....	166	0172271.....	178	0172512.....	184	0174111.....	158	0174335.....	174
0168219SS.....	176	0172062.....	167	0172272.....	179	0172519.....	190	0174112.....	159	0174339.....	179
0168229LS.....	177	0172065.....	168	0172275.....	180	0172521.....	183	0174115.....	162	0174399.....	170
0168229NS.....	175	0172071.....	166	0172277.....	193	0172522.....	184	0174119.....	167	0174401.....	183
0168229SS.....	176	0172072.....	167	0172281.....	178	0172529.....	189	0174121.....	158	0174402.....	184
0168239LS.....	177	0172075.....	168	0172282.....	179	0172531.....	183	0174122.....	159	0174405.....	185
0168239NS.....	175	0172081.....	166	0172291.....	178	0172532.....	184	0174125.....	162	0174409.....	189
0168239SS.....	176	0172082.....	167	0172292.....	179	0172539.....	190	0174129.....	166	0174411.....	183
0168309LS.....	177	0172091.....	166	0172292.....	179	0172549.....	170	0174131.....	158	0174412.....	184
0168309NS.....	175	0172092.....	167	0172300.....	180	0172549.....	170	0174132.....	159	0174415.....	185
0168309SS.....	176	0172100.....	168	0172301.....	172	0172559.....	170	0174135.....	162	0174417.....	185
0168319LS.....	177	0172101.....	158	0172302.....	173	0172561.....	189	0174139.....	167	0174421.....	183
0168319NS.....	175	0172102.....	159	0172309.....	178	0172562.....	190	0174161.....	166	0174422.....	184
0168319SS.....	176	0172103.....	160	0172311.....	172	0172565.....	191	0174162.....	167	0174425.....	185
0168329LS.....	177	0172104.....	161	0172312.....	173	0172567.....	193	0174171.....	166	0174429.....	189
0168329NS.....	175	0172109.....	166	0172319.....	179	0172569.....	181	0174172.....	167	0174431.....	183
0168329SS.....	176	0172111.....	158	0172321.....	172	0172571.....	189	0174179.....	171	0174432.....	184
0168339LS.....	177	0172112.....	159	0172322.....	173	0172572.....	190	0174181.....	166	0174435.....	185
0168339NS.....	175	0172113.....	160	0172329.....	178	0172575.....	191	0174182.....	167	0174449.....	171
0168339SS.....	176	0172114.....	161	0172331.....	172	0172579.....	181	0174189.....	171	0174461.....	189
0168409LS.....	188	0172119.....	167	0172332.....	173	0172581.....	189	0174191.....	166	0174462.....	190
0168409NS.....	186	0172121.....	158	0172339.....	179	0172582.....	190	0174199.....	171	0174472.....	190
0168409SS.....	187	0172122.....	159	0172361.....	178	0172585.....	191	0174201.....	172	0174481.....	189
0168419LS.....	188	0172123.....	160	0172362.....	179	0172589.....	182	0174202.....	173	0174482.....	190
0168419NS.....	186	0172124.....	161	0172365.....	180	0172591.....	189	0174205.....	174	0174491.....	189
0168419SS.....	187	0172129.....	166	0172367.....	182	0172592.....	190	0174209.....	178	0174492.....	190
0168429LS.....	188	0172129.....	166	0172371.....	178	0172595.....	191	0174211.....	172	0174501.....	183
0168429NS.....	186	0172131.....	158	0172372.....	179	0172599.....	192	0174212.....	173	0174502.....	184
0168429SS.....	186	0172132.....	159	0172377.....	182	0172601.....	169	0174215.....	174	0174505.....	185
0168429SS.....	187	0172133.....	160	0172375.....	180	0172602.....	169	0174219.....	179	0174509.....	189
0168439LS.....	188	0172139.....	167	0172377.....	182	0172603.....	169	0174221.....	172	0174511.....	183
0168439NS.....	186	0172161.....	166	0172381.....	178	0172604.....	169	0174222.....	173	0174512.....	184
0168439SS.....	187	0172162.....	167	0172382.....	179	0172612.....	181	0174225.....	174	0174515.....	185
0168509LS.....	188	0172165.....	168	0172385.....	180	0172621.....	192	0174229.....	178	0174519.....	190
0168509NS.....	186	0172167.....	171	0172391.....	178	0172622.....	192	0174231.....	172	0174521.....	183
0168509SS.....	187	0172171.....	166	0172392.....	179	0172629.....	171	0174232.....	173	0174522.....	184
0168519LS.....	188	0172172.....	167	0172395.....	180	0172649.....	171	0174235.....	174	0174525.....	185
0168519NS.....	186	0172177.....	171	0172399.....	170	0174001.....	158	0174239.....	179	0174529.....	189
0168519SS.....	187	0172175.....	168	0172400.....	191	0174002.....	159	0174249.....	171	0174531.....	183
0168529LS.....	188	0172177.....	171	0172401.....	183	0174005.....	162	0174259.....	171	0174532.....	184
0168529NS.....	186	0172179.....	168	0172402.....	184	0174009.....	166	0174261.....	178	0174535.....	185
0168529SS.....	187	0172181.....	166	0172409.....	189	0174011.....	158	0174262.....	179	0174539.....	190
0168539LS.....	188	0172182.....	167	0172411.....	183	0174012.....	159	0174269.....	193	0174561.....	189
0168539NS.....	186	0172185.....	168	0172412.....	184	0174015.....	162	0174271.....	178	0174562.....	190
0168539SS.....	187	0172189.....	171	0172419.....	190	0174019.....	167	0174272.....	179	0174569.....	171
0172000.....	168	0172191.....	166	0172421.....	183	0174021.....	158	0174281.....	178	0174571.....	189
0172001.....	158	0172192.....	167	0172422.....	184	0174022.....	159	0174282.....	179	0174572.....	190
0172002.....	159	0172195.....	168	0172429.....	189	0174025.....	162	0174291.....	178	0174581.....	189
0172003.....	160	0172199.....	171	0172431.....	183	0174029.....	166	0174292.....	179	0174582.....	190
0172004.....	161	0172199.....	171	0172432.....	184	0174031.....	158	0174301.....	172	0174591.....	189
0172009.....	166	0172200.....	180	0172439.....	190	0174032.....	159	0174302.....	173	0174592.....	190
0172011.....	158	0172201.....	172	0172461.....	189	0174035.....	162	0174305.....	174	0174599.....	171
0172012.....	159	0172202.....	173	0172462.....	190	0174039.....	167	0174309.....	178	0174601.....	169
0172013.....	160	0172209.....	178	0172465.....	191	0174061.....	166	0174311.....	172	0174602.....	169
0172014.....	161	0172211.....	172	0172465.....	191	0174062.....	167	0174312.....	173	0174612.....	181
0172019.....	167	0172212.....	172	0172471.....	189	0174071.....	166	0174315.....	174	0174621.....	192
0172021.....	158	0172219.....	179	0172472.....	190	0174072.....	167	0174319.....	179	0174622.....	192
0172022.....	159	0172221.....	172	0172475.....	191	0174081.....	166				
0172023.....	160	0172222.....	173	0172481.....	189	0174082.....	167				
		0172229.....	178	0172482.....	190						
		0172231.....	172	0172491.....	189						



# CATALOG PART NUMBER INDEX

PART NUMBER	PAGE	PART NUMBER	PAGE	PART NUMBER	PAGE	PART NUMBER	PAGE	PART NUMBER	PAGE	PART NUMBER	PAGE
<b>CAM SWITCHES</b>											
223501.....	208	HB03AQ7.....	212	ID02AQ7.....	220	NC51DC113.....	210	NZ52BXQ.....	229	TC51DXQ.....	217
223502.....	208	HB04ABQ.....	213	ID03AQ7.....	220	NC51DC123.....	210	NZ52CQ1.....	228	TC52DXQ.....	216
223503.....	208	HB04AQ7.....	212	IS3BV733-IP65.....	215	NC51DQ1.....	216	NZ52CXQ.....	229	TC53DQ1.....	217
223504.....	208	HC01GAQ.....	219	IS3CQ72.....	214	NC51DX80.....	210	SB01AQ1.....	212	TC53DXQ.....	216
223505.....	208	HC01GQ7.....	218	IS3EV733-IP65.....	214	NC51DXQ.....	217	SB01AXQ.....	213	TC54DQ1.....	216
223506.....	208	HC02GBQ.....	219	IS4BV733-IP65.....	215	NC52DC113.....	210	SB02AQ1.....	212	TC54DXQ.....	217
223507.....	208	HC02GQ7.....	218	IS4EV733-IP65.....	214	NC52DC123.....	210	SB02AXQ.....	213	TD01AQ1.....	220
223508.....	208	HC03GCQ.....	219	IZ11GCQ.....	223	NC52DQ1.....	216	SB03AQ1.....	212	TD01AXQ.....	221
223511.....	208	HC03GQ7.....	218	IZ11GQ7.....	222	NC52DX80.....	210	SB03AXQ.....	213	TD02AQ1.....	220
223512.....	208	HC04GDO.....	219	IZ13GQ7.....	224	NC52DXQ.....	217	SB04AQ1.....	212	TD02AXQ.....	221
223513.....	208	HC04GQ7.....	218	IZ51BDQ.....	227	NC53DC113.....	210	SB04AXQ.....	213	TD03AQ1.....	220
223514.....	208	HC51DAQ.....	217	IZ51BQ7.....	226	NC53DC123.....	210	SC01GQ1.....	218	TD03AXQ.....	221
223515.....	208	HC51DQ7.....	216	IZ52BDQ.....	229	NC53DQ1.....	216	SC01GXQ.....	219	TS3EV493-IP65.....	214
223516.....	208	HC52DBQ.....	217	IZ52BQ7.....	228	NC53DX80.....	210	SC02GQ1.....	218	TS3XV483-IP65.....	215
223517.....	208	HC52DQ7.....	216	IZ52CDQ.....	229	NC53DXQ.....	217	SC02GXQ.....	219	TS4EV493-IP65.....	214
223521.....	208	HC53DCQ.....	217	IZ52CQ7.....	228	NC54DC113.....	210	SC03GQ1.....	218	TS4XV483-IP65.....	215
223522.....	208	HC53DQ7.....	216	NB01AC113.....	210	NC54DC123.....	210	SC03GXQ.....	219	TZ11GQ1.....	222
223523.....	208	HC54DDQ.....	217	NB01AC123.....	210	NC54DQ1.....	216	SC04GQ1.....	218	TZ11GXQ.....	223
223525.....	208	HC54DQ7.....	216	NB01AC1C1.....	210	NC54DX80.....	210	SC04GXQ.....	219	TZ13GQ1.....	224
223526.....	208	HD01ABQ.....	221	NB01AQ1.....	212	NC54DXQ.....	217	SC51DQ1.....	216	TZ13GXQ.....	225
223527.....	208	HD01AQ7.....	220	NB01AX80.....	210	ND01AC113.....	211	SC51DXQ.....	217	TZ51BQ1.....	226
223528.....	208	HD02ACQ.....	221	NB01AXQ.....	213	ND01AC123.....	211	SC52DQ1.....	216	TZ51BXQ.....	227
223529.....	208	HD02AQ7.....	220	NB02AC113.....	210	ND01AC1C1.....	211	SC52DXQ.....	217	TZ52BQ1.....	228
227600.....	202	HD03AQ7.....	220	NB02AC123.....	210	ND01AQ1.....	220	SC53DQ1.....	216	TZ52BXQ.....	229
227601.....	202	HS3BV733-IP65.....	215	NB02AC1C1.....	210	ND01AX80.....	211	SC53DXQ.....	217	TZ52CQ1.....	228
227602.....	202	HS3EV733-IP65.....	214	NB02AQ1.....	212	ND01AXQ.....	221	SC54DQ1.....	216	TZ52CXQ.....	229
227603.....	202	HS4BV733-IP65.....	215	NB02AX80.....	210	ND02AC113.....	211	SC54DXQ.....	217	ZB01AQ7.....	212
227604.....	202	HS4EV733-IP65.....	214	NB02AXQ.....	213	ND02AC123.....	211	SD01AQ1.....	220	ZB01AXQ.....	213
227605.....	202	HZ11GCQ.....	214	NB03AC113.....	210	ND02AQ1.....	220	SD01AXQ.....	221	ZB02AQ7.....	212
227606.....	202	HZ11GQ7.....	222	NB03AC123.....	210	ND02AX80.....	211	SD02AQ1.....	220	ZB02AXQ.....	213
227608.....	202	HZ13GQ7.....	224	NB03AC1C1.....	210	ND02AXQ.....	221	SD02AXQ.....	221	ZB03AQ7.....	212
227609.....	202	HZ51BDQ.....	227	NB03AQ1.....	212	ND02AQ1.....	220	SD03AQ1.....	220	ZB03AXQ.....	213
227610.....	202	HZ51BQ7.....	226	NB03AX80.....	210	ND02AX80.....	211	SD03AXQ.....	221	ZB04AQ7.....	212
227611.....	202	HZ52BDQ.....	229	NB03AXQ.....	213	ND02AXQ.....	221	S53EV493-IP65.....	214	ZB04AXQ.....	213
227612.....	202	HZ52BQ7.....	228	NB04AC113.....	210	ND03AC113.....	211	S53XV483-IP65.....	215	ZC01GQ7.....	218
227613.....	202	HZ52CDQ.....	229	NB04AC123.....	210	ND03AC123.....	211	S54EV493-IP65.....	214	ZC01GXQ.....	219
227614.....	202	HZ52CQ7.....	228	NB04AC1C1.....	210	ND03AC1C1.....	211	S54XV483-IP65.....	215	ZC02GQ7.....	218
227615.....	202	IB01AAQ.....	213	NB04AQ1.....	212	ND03AQ1.....	220	SZ11GQ1.....	222	ZC02GXQ.....	219
227616.....	202	IB01AQ7.....	212	NB04AX80.....	210	ND03AX80.....	211	SZ11GXQ.....	223	ZC03GQ7.....	218
227617.....	202	IB02AAQ.....	213	NB04AXQ.....	213	ND03AXQ.....	221	SZ13GQ1.....	224	ZC03GXQ.....	219
227618.....	203	IB02AQ7.....	212	NB04X80.....	210	ND04AC113.....	211	SZ13GXQ.....	225	ZC04GQ7.....	218
227619.....	203	IB03ABQ.....	213	NC01GC113.....	211	ND04AC123.....	211	SZ51BQ1.....	226	ZC04GXQ.....	219
227620.....	203	IB03AQ7.....	212	NC01GC123.....	211	ND04AQ1.....	220	SZ51BXQ.....	227	ZC51DQ7.....	216
227621.....	203	IB04ABQ.....	213	NC01GC1C1.....	211	ND04AX80.....	211	SZ52BQ1.....	228	ZC51DXQ.....	217
227622.....	203	IB04AQ7.....	212	NC01GQ1.....	218	NS3EV493-IP65.....	214	SZ52BXQ.....	229	ZC52DXQ.....	217
227623.....	204	IC01GAQ.....	219	NC01GX80.....	211	NS3XV483-IP65.....	215	SZ52CQ1.....	228	ZC53DQ7.....	216
227624.....	203	IC01GQ7.....	218	NC01GXQ.....	219	NS4EV493-IP65.....	214	SZ52CXQ.....	229	ZC53DXQ.....	217
227625.....	203	IC02GBQ.....	219	NC02GC113.....	211	NS4XV483-IP65.....	215	TB01AQ1.....	212	ZC54DQ7.....	216
227626.....	203	IC02GQ7.....	218	NC02GC1C1.....	211	NY11AQ1.....	230	TB01AXQ.....	213	ZC54DXQ.....	217
227627.....	203	IC03GCQ.....	219	NC02GQ1.....	218	NY11AX80.....	230	TB02AQ1.....	212	ZD01AQ7.....	220
227628.....	204	IC03GQ7.....	218	NC02GX80.....	211	NY14AQ1.....	230	TB02AXQ.....	213	ZD01AXQ.....	221
227629.....	204	IC04GDQ.....	219	NC02GXQ.....	219	NY14AX80.....	230	TB03AQ1.....	212	ZD02AQ7.....	220
227630.....	203	IC04GQ7.....	218	NC03GC113.....	211	NY17AQ1.....	231	TB03AXQ.....	213	ZD02AXQ.....	221
227631.....	203	IC51DAQ.....	217	NC03GC123.....	211	NY17AX80.....	231	TB04AQ1.....	212	ZD03AQ7.....	220
227632.....	203	IC51DQ7.....	216	NC03GC1C1.....	211	NY31AQ1.....	232	TB04AXQ.....	213	ZS3EV733-IP65.....	214
227633.....	203	IC52DBQ.....	217	NC03GQ1.....	218	NY31AX80.....	232	TC01GQ1.....	218	ZS3XV483-IP65.....	215
227634.....	204	IC52DQ7.....	216	NC03GX80.....	211	NY37GQ1.....	232	TC01GXQ.....	219	ZS4EV733-IP65.....	214
227635.....	204	IC52CDQ.....	217	NC03GXQ.....	219	NY71AQ1.....	231	TC02GQ1.....	218	ZS4XV483-IP65.....	215
227636.....	204	IC53DCQ.....	217	NC04GC113.....	211	NY71AX80.....	231	TC02GXQ.....	219	ZZ11GQ7.....	222
227637.....	204	IC53DQ7.....	216	NC04GC123.....	211	NY71AX80.....	231	TC03GQ1.....	218	ZZ11GXQ.....	223
HB01AAQ.....	213	IC54DDQ.....	217	NC04GC1C1.....	211	NY31AQ1.....	232	TC03GXQ.....	219	ZZ13GQ7.....	224
HB01AQ7.....	212	IC54DQ7.....	216	NC04GQ1.....	218	NY37GQ1.....	232	TC04GQ1.....	218	ZZ51BQ7.....	226
HB02AAQ.....	213	ID01ABQ.....	221	NC04GX80.....	211	NY37GX80.....	232	TC04GXQ.....	219		
HB02AQ7.....	212	ID01AQ7.....	220	NC04GXQ.....	219	NZ11GQ1.....	222	TC51DQ1.....	216		
HB03ABQ.....	213	ID02ACQ.....	221			NZ11GXQ.....	223				
						NZ13GQ1.....	224				
						NZ13GXQ.....	225				
						NZ51BQ1.....	226				
						NZ51BXQ.....	227				
						NZ52BQ1.....	228				

# A complete range of devices

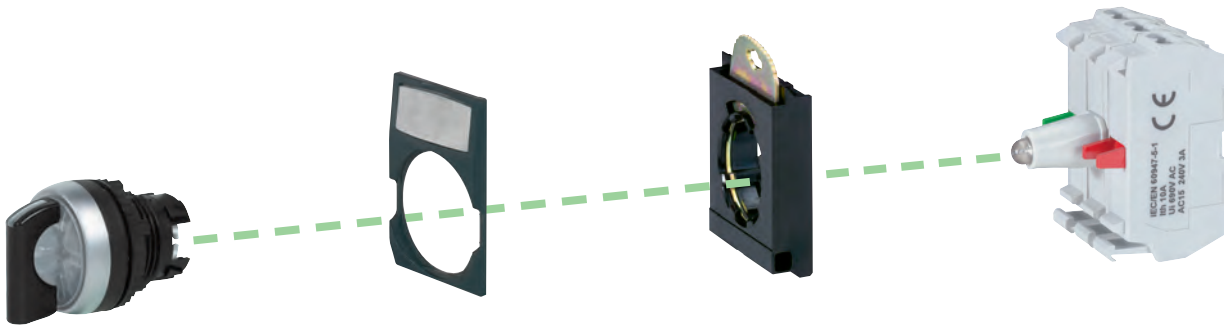

### Heads

- Integrated Anti-Rotation Ring
- NEMA 4x, IP66, IP67, IP69k
- Modern ergonomic design
- Wide range of functions

### Accessories

- Legend plates
- Guards
- Shrouds

### Clips

- Enhanced rigidity
- Metal locking lever
- Available in 1, 3 or 5 positions

### Contact/LED Modules

- Simple to snap onto clips
- Stackable
- LED blocks

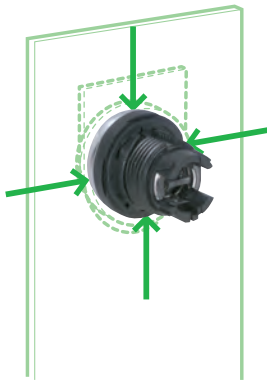

### Auto-grip ring

Specially designed gasket holds heads firmly in the mounting hole during assembly



### Locking ring

Tighten the locking ring to 3 Nm fix the head to the panel



### Fixing

Locate block onto head and lock in place by rotating the metal latch

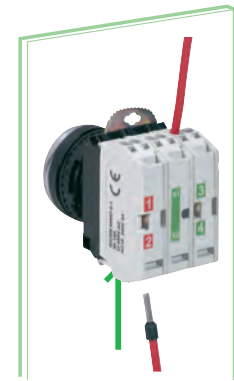

### Quick connection

No tool required for wires with ferrules. New plug-in terminals



### Screw Terminals

Our most popular option for a traditional connection



### Plug In Terminals

Using spring clamp terminals for a completely safe and time saving solution



### Faston Terminals

Quickly and easily wire using 1/4" or .110" connectors

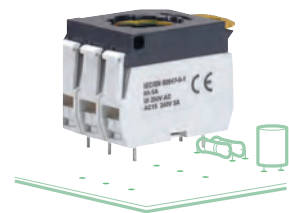

### PCB Terminals

No tool required for wires with ferrules. New plug-in terminals

# Providing solutions for all applications



IK5

**Twin touch**  
innovative design



IP66 / IP69K  
NEMA 4x



**Mushroom head**  
EN 418 / ISO 13850  
illuminated

**Illuminated head**  
5 colors,  
LED light source

**Selector switches**  
with key, handle,  
lever handle, or  
knob



Ø 22.3 mm cut-out



Optional cut-out required  
for anti-rotation tab



## Legend Plates

- Frames can be rotated to 4 positions (0° ; 90° ; 180° and 270°)
- Special legend plate for twin touch
- Choice between 5 colors, blank or pre-engraved



## Tampo Printing

- Durable markings
- Button plates can be mounted in 4 positions (0° ; 90° ; 180° and 270°)



## Bezels

- Choice of Chrome or Black Bezel

## COMPLETE UNITS

- Control and signalling units are supplied ready for use with head, clip and block(s)
- A single product code provides a solution for the most common needs



## SEPARATE UNITS & CUSTOMIZED SOLUTIONS

- Maximum flexibility
- For numerous possible solutions

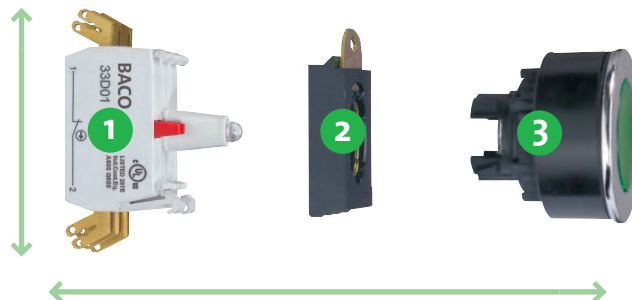

# Products for severe environments

## ► BACO provides solutions for harsh industrial environments.

BACO's 22mm control and signalling devices are available in plastic bodies and can be fitted with an external shroud to protect against liquid and dust ingress into the head itself. All 22mm devices are rated to a minimum IP66 and Type 4X environmental ratings. Many standard operators have more stringent IP67 and IP69K ratings.



**Emergency Stops**  
IP66  
IP69K  
NEMA 4X



**Pushbuttons**  
IP66  
IP69K  
NEMA 4X



**Selectors**  
IP66  
IP69K  
NEMA 4X



**Twin Touch**  
IP66  
NEMA 4X



**Pilot Lights**  
IP66  
IP69K  
NEMA 4X

### ► What is IP69K?

- IP69K is an IEC protection degree rating
- A device having the IP69K rating is **protected against close-range high pressure, high temperature spray downs**

### ► Do I need IP69K protection?

- If your application is in the food, beverage or pharmaceutical industry chances are you already require IP69K ratings.
- Any high-pressure, high temperature wash down applications would benefit from IP69K protection.

► Tough and robust according to **IP69K**

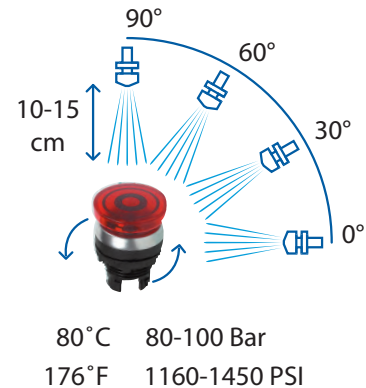

## ► Additional ratings for harsh environments

► Watertight according to **NEMA 4x**

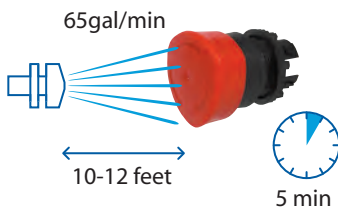

► Waterproof according to **IP66**

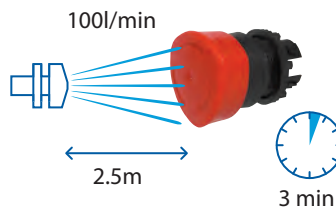

► Waterproof according to **IP67**

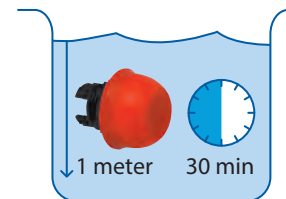

# Customized Solutions!

---

## ► Baco Controls provides custom Control Stations

Baco Controls offers the convenience of ordering custom assembled control stations. We have laser engraving machines to create custom nameplates for your application. We offer various enclosure sizes and materials to meet your specifications.





# Complete units: Part Numbering System

## ► NON-ILLUMINATED COMPLETE UNITS

L21AA01 - **3** **E** **1** **1** **Y7**  
a b c d e

Part number of non-illuminated operator head.  
 See pages 29 to 44 for non-illuminated operator heads.

*a*

CLIP	
Code	Description
1	single module
3	three modules
4	three modules (when using 33E11 contact blocks)
5	five modules

*b*

TERMINAL STYLE	
Code	Description
E	Screw and Clamp
ED	Stab (Quick Connect)
EP	PCB
ER	Plug In

*c*

N.O. (NORMALLY OPEN) CONTACTS	
Code	Description
0	No Contact
1	1 N.O.
2	2 N.O.
3	3 N.O.
4	4 N.O.
5	5 N.O.
6	6 N.O.

*d*

N.C. (NORMALLY CLOSED) CONTACTS	
Code	Description
0	No Contact
1	1 N.C.
2	2 N.C.
3	3 N.C.
4	4 N.C.
5	5 N.C.
6	6 N.C.

*e*

SPECIALTY BLOCKS	
Code	Description
C	Late Break N.C. (Screw and Clamp terminals only)
Y7	Gold Plated Contacts (Screw and Clamp or PCB terminals only)

# Complete units: Push-buttons $\varnothing$ 22mm

## ► SPRING RETURN - NON-ILLUMINATED

 Technical Info (p. 106)

### FLUSH



L21AA01-1E01

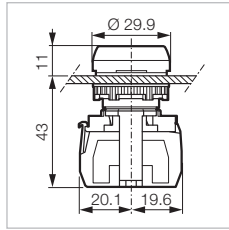

#### WITH SINGLE POSITION CLIP

● Red	NC
● Green	NO
● Black	NC
● Black	NO
● Yellow	NO
○ White	NO
● Blue	NO

Chrome Bezel  
Part Number

Black Bezel  
Part Number

L21AA01-1E01
L21AA02-1E10
L21AA03-1E01
L21AA03-1E10
L21AA04-1E10
L21AA05-1E10
L21AA06-1E10

L22AA01-1E01
L22AA02-1E10
L22AA03-1E01
L22AA03-1E10
L22AA04-1E10
L22AA05-1E10
L22AA06-1E10

#### WITH INTERNATIONAL SYMBOLS

 Red	NC
 Green	NO

L21AA81-1E01
L21AA82-1E10

L22AA81-1E01
L22AA82-1E10



L22AA02-3E10

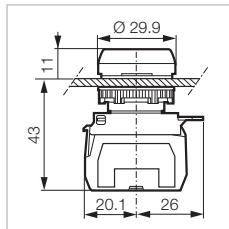

#### WITH THREE POSITION CLIP

● Red	NC
● Green	NO
● Black	NC
● Black	NO
● Yellow	NO
○ White	NO
● Blue	NO

L21AA01-3E01
L21AA02-3E10
L21AA03-3E01
L21AA03-3E10
L21AA04-3E10
L21AA05-3E10
L21AA06-3E10

L22AA01-3E01
L22AA02-3E10
L22AA03-3E01
L22AA03-3E10
L22AA04-3E10
L22AA05-3E10
L22AA06-3E10

● Red	NO + NC
● Green	NO + NC
● Black	NO + NC
● Yellow	NO + NC
○ White	NO + NC
● Blue	NO + NC

L21AA01-3E11
L21AA02-3E11
L21AA03-3E11
L21AA04-3E11
L21AA05-3E11
L21AA06-3E11

L22AA01-3E11
L22AA02-3E11
L22AA03-3E11
L22AA04-3E11
L22AA05-3E11
L22AA06-3E11

### PROJECTING



L21AB04-3E11

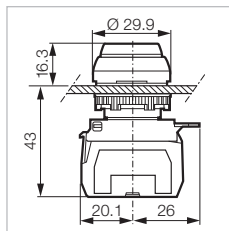

#### WITH SINGLE POSITION CLIP

● Red	NC
● Green	NO
● Black	NO
● Yellow	NO
○ White	NO
● Blue	NO

L21AB01-1E01
L21AB02-1E10
L21AB03-1E10
L21AB04-1E10
L21AB05-1E10
L21AB06-1E10

L22AB01-1E01
L22AB02-1E10
L22AB03-1E10
L22AB04-1E10
L22AB05-1E10
L22AB06-1E10

#### WITH THREE POSITION CLIP

● Red	NO + NC
● Green	NO + NC
● Black	NO + NC
● Yellow	NO + NC
○ White	NO + NC
● Blue	NO + NC

L21AB01-3E11
L21AB02-3E11
L21AB03-3E11
L21AB04-3E11
L21AB05-3E11
L21AB06-3E11

L22AB01-3E11
L22AB02-3E11
L22AB03-3E11
L22AB04-3E11
L22AB05-3E11
L22AB06-3E11

#### WITH INTERNATIONAL SYMBOL

 Red	NC
---	----

L21AB01B-1E01
---------------

L22AB31A70-1E01
-----------------

# Complete units: Push-buttons $\phi$ 22mm

## ► SPRING RETURN - NON-ILLUMINATED

 Technical Info (p.106)

### $\phi$ 32 MUSHROOM



L21AC01-1E01

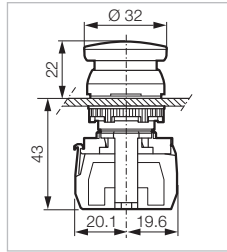

#### WITH SINGLE POSITION CLIP

● Red	NC
● Green	NO
● Black	NO
● Yellow	NO

#### WITH THREE POSITION CLIP

● Red	NC
● Green	NO
● Black	NO
● Yellow	NO

Chrome Bezel  
Part Number

Black Bezel  
Part Number

L21AC01-1E01
L21AC02-1E10
L21AC03-1E10
L21AC04-1E10

L22AC01-1E01
L22AC02-1E10
L22AC03-1E10
L22AC04-1E10

### $\phi$ 40 MUSHROOM



L22AD01-3E01

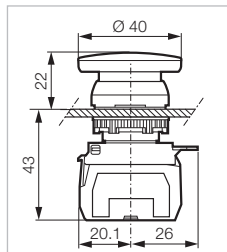

#### WITH SINGLE POSITION CLIP

● Red	NC
● Green	NO
● Black	NO
● Yellow	NO

#### WITH THREE POSITION CLIP

● Red	NC
● Green	NO
● Black	NO
● Yellow	NO

L21AD01-1E01
L21AD02-1E10
L21AD03-1E10
L21AD04-1E10

L22AD01-1E01
L22AD02-1E10
L22AD03-1E10
L22AD04-1E10

L21AD01-3E01
L21AD02-3E10
L21AD03-3E10
L21AD04-3E10

L22AD01-3E01
L22AD02-3E10
L22AD03-3E10
L22AD04-3E10

### FLUSH-FLUSH

#### Twin touch



L62QA21-3E11

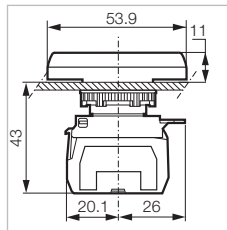

#### WITH INTERNATIONAL SYMBOLS

ⓘ Green	NO
Ⓞ Red	NC

#### WITH TEXT

● Green (START)	NO
● Red (STOP)	NC

L61QA21-3E11

L62QA21-3E11

L61QA21B-3E11

L62QA21B-3E11

### FLUSH-PROJECTING

#### Twin touch



L61QB21-3E11

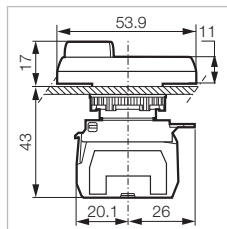

#### WITH INTERNATIONAL SYMBOLS

ⓘ Green	NO
Ⓞ Red	NC

#### WITH TEXT

● Green (START)	NO
● Red (STOP)	NC

L61QB21-3E11

L62QB21-3E11

L61QB21B-3E11

L62QB21B-3E11

# Complete units: Push-buttons $\phi$ 22mm

## ► SPRING RETURN - NON-ILLUMINATED

 Technical Info (p.106)

### FLUSH-PROJECTING-FLUSH

Triple touch

Chrome Bezel  
Part Number



Black Bezel  
Part Number

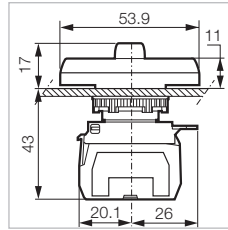

L62BA22G-3E21





**WITH ARROWS AND TEXT**

-  Green NO
-  Red (STOP) NC
-  Green NO

L61BA22-3E21



L62BA22-3E21

-  Green NO
-  Red (STOP) NC
-  Green NO

L61BA22B-3E21

L62BA22B-3E21

**WITH TEXT**

-  Green (UP) NO
-  Red (STOP) NC
-  Green (DOWN) NO

L61BA22G-3E21

L62BA22G-3E21





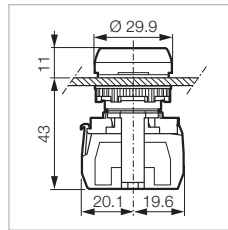

## ► MAINTAINED - NON-ILLUMINATED

### FLUSH



L21CA01-1E01



-  Red NC
-  Green NO
-  Black NO
-  Yellow NO
-  White NO
-  Blue NO

L21CA01-1E01

L22CA01-1E01

L21CA02-1E10

L22CA02-1E10

L21CA03-1E10

L22CA03-1E10

L21CA04-1E10





L22CA04-1E10

L21CA05-1E10

L22CA05-1E10

L21CA06-1E10

L22CA06-1E10

-  Red NO + NC
-  Green NO + NC
-  Black NO + NC
-  Yellow NO + NC
-  White NO + NC
-  Blue NO + NC

L21CA01-3E11

L22CA01-3E11

L21CA02-3E11

L22CA02-3E11

L21CA03-3E11

L22CA03-3E11

L21CA04-3E11

L22CA04-3E11

L21CA05-3E11

L22CA05-3E11

L21CA06-3E11





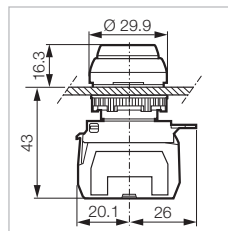

L22CA06-3E11

### PROJECTING



L21CB04-3E11



-  Red NC
-  Green NO
-  Black NO
-  Yellow NO
-  White NO
-  Blue NO

L21CB01-1E01

L22CB01-1E01

L21CB02-1E10

L22CB02-1E10

L21CB03-1E10

L22CB03-1E10

L21CB04-1E10







L22CB04-1E10

L21CB05-1E10

L22CB05-1E10

L21CB06-1E10

L22CB06-1E10

-  Red NO + NC
-  Green NO + NC
-  Black NO + NC
-  Yellow NO + NC
-  White NO + NC
-  Blue NO + NC

L21CB01-3E11

L22CB01-3E11

L21CB02-3E11

L22CB02-3E11

L21CB03-3E11

L22CB03-3E11

L21CB04-3E11

L22CB04-3E11

L21CB05-3E11

L22CB05-3E11

L21CB06-3E11

L22CB06-3E11

# Complete units: Mushroom heads $\varnothing$ 22MM

## ► MAINTAINED - NON-ILLUMINATED

 Technical Info (p.106)

### $\varnothing$ 40 MUSHROOM

Push-pull to reset

Black Bezel  
Part Number



L22DD01-3E01

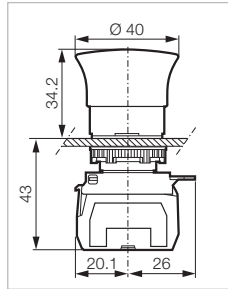

- Red NC
- Red 2 NC
- Red NO + NC

**WITH TEXT**

- Red (STOP STOP STOP) NC
- Green NO
- Black NC
- Black NO
- Yellow NO

- L22DD01-3E01
- L22DD01-3E02
- L22DD01-3E11

L22DD01S-3E01

- L22DD02-3E10
- L22DD03-3E01
- L22DD03-3E10
- L22DD04-3E10

### $\varnothing$ 32 MUSHROOM

Push-turn to reset



L22EC01-3E01

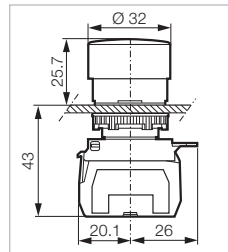

- Red NC
- Red 2 NC
- Red NO + NC

- Green NO
- Black NC
- Black NO
- Yellow NO

- L22EC01-3E01
- L22EC01-3E02
- L22EC01-3E11

- L22EC02-3E10
- L22EC03-3E01
- L22EC03-3E10
- L22EC04-3E10

### $\varnothing$ 40 MUSHROOM

Push-turn to reset



L22ED01-3E11

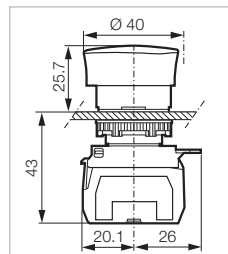

- Red NC
- Red 2 NC
- Red NO + NC

**WITH TEXT**

- Red (STOP STOP STOP) NC
- Green NO
- Black NC
- Black NO
- Yellow NO

- L22ED01-3E01
- L22ED01-3E02
- L22ED01-3E11

L22ED01S-3E01

- L22ED02-3E10
- L22ED03-3E01
- L22ED03-3E10
- L22ED04-3E10

### $\varnothing$ 40 MUSHROOM

Key to reset



L22GM01-3E01

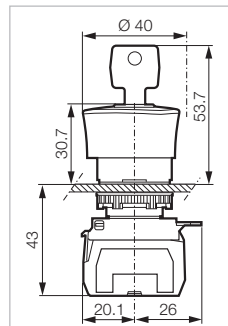

Supplied with 2 keys profile n°455

- Red NC
- Red 2 NC
- Red NO + NC

- L22GM01-3E01
- L22GM01-3E02
- L22GM01-3E11



# Complete units: Mushroom heads $\varnothing$ 22MM

 Technical Info (p.106)

## ► EMERGENCY STOP MAINTAINED - NON-ILLUMINATED

Black Bezel  
Part Number

$\varnothing$  40 ISO13850

Push-pull to reset



L22DR01-3E11

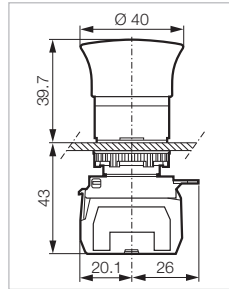

Head position visible from the side with yellow collar  
Compliant with the requirements of emergency stop:  
ISO 13850

- Red NC
- Red 2 NC
- Red NO + NC

L22DR01-3E01  
L22DR01-3E02  
L22DR01-3E11

$\varnothing$  40 ISO13850

Push-turn to reset



L22ER01-3E11

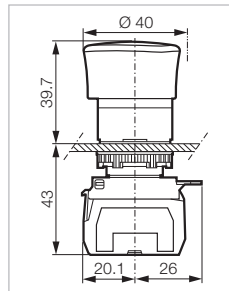

Head position visible from the side with yellow collar  
Compliant with the requirements of emergency stop:  
ISO 13850

- Red NC
- Red 2 NC
- Red NO + NC

L22ER01-3E01  
L22ER01-3E02  
L22ER01-3E11

$\varnothing$  40 ISO13850

Key to reset



L22GR01-3E11

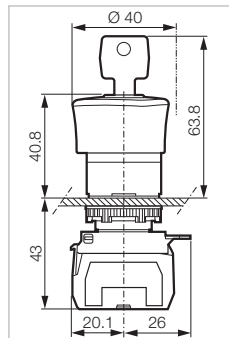

Double position indicator: head and collar  
Compliant with the requirements of emergency stop:  
ISO 13850  
Supplied with 2 keys profile n°455

- Red NC
- Red 2 NC
- Red NO + NC

L22GR01-3E01  
L22GR01-3E02  
L22GR01-3E11

# Complete units: Selector switches $\varnothing$ 22mm

## ▶ SELECTOR SWITCHES - NON-ILLUMINATED

 Technical Info (p.106)

### WITH HANDLE

#### 2 positions

Chrome Bezel  
Part Number

Black Bezel  
Part Number



L21KE03-1E10

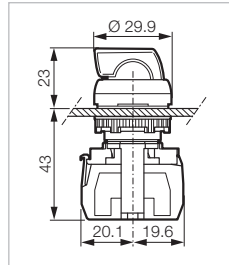

#### MAINTAINED POSITIONS - 45°

● Red		NC	
● Green		NO	
● Black		NO	
● Black		2 NO	
● Black		NO + NC	
● Grey		NO	



#### SPRING RETURN - 45°

● Red		NC	
● Green		NO	
● Black		NO	
● Black		2 NO	
● Black		NO + NC	
● Grey		NO	



#### MAINTAINED POSITIONS - 90°

● Red		NC	
● Green		NO	
● Black		NO	
● Black		2 NO	
● Black		NO + NC	
● Grey		NO	



L21KA01-1E01  
L21KA02-1E10  
L21KA03-1E10  
L21KA03-3E20  
L21KA03-3E11  
L21KA08-1E10

L22KA01-1E01  
L22KA02-1E10  
L22KA03-1E10  
L22KA03-3E20  
L22KA03-3E11  
L22KA08-1E10

L21KB01-1E01  
L21KB02-1E10  
L21KB03-1E10  
L21KB03-3E20  
L21KB03-3E11  
L21KB08-1E10

L22KB01-1E01  
L22KB02-1E10  
L22KB03-1E10  
L22KB03-3E20  
L22KB03-3E11  
L22KB08-1E10

L21KE01-1E01  
L21KE02-1E10  
L21KE03-1E10  
L21KE03-3E20  
L21KE03-3E11  
L21KE08-1E10

L22KE01-1E01  
L22KE02-1E10  
L22KE03-1E10  
L22KE03-3E20  
L22KE03-3E11  
L22KE08-1E10

### WITH HANDLE

#### 3 positions



L21MA03-3E20

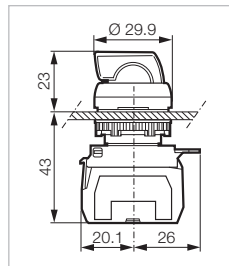

#### MAINTAINED POSITIONS - 45°

● Red		2 NO	
● Green		2 NO	
● Black		2 NO	
● Grey		2 NO	



#### SPRING RETURN - 45°

● Red		2 NO	
● Green		2 NO	
● Black		2 NO	
● Grey		2 NO	



#### MAINTAINED / SPRING RETURN - 45°

● Red		2 NO	
● Green		2 NO	
● Black		2 NO	
● Grey		2 NO	



L21MA01-3E20  
L21MA02-3E20  
L21MA03-3E20  
L21MA08-3E20

L22MA01-3E20  
L22MA02-3E20  
L22MA03-3E20  
L22MA08-3E20

L21MD01-3E20  
L21MD02-3E20  
L21MD03-3E20  
L21MD08-3E20

L22MD01-3E20  
L22MD02-3E20  
L22MD03-3E20  
L22MD08-3E20

L21MC01-3E20  
L21MC02-3E20  
L21MC03-3E20  
L21MC08-3E20

L22MC01-3E20  
L22MC02-3E20  
L22MC03-3E20  
L22MC08-3E20

# Complete units: Selector switches $\varnothing$ 22mm

## ▶ SELECTOR SWITCHES - NON-ILLUMINATED

 Technical Info (p.106)

**WITH KNOB** **2 and 3 positions** Chrome Bezel  
Part Number Black Bezel  
Part Number



L21UA03-3E20

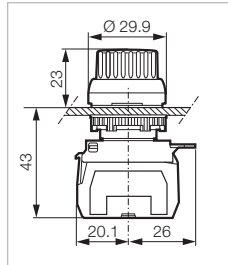

**MAINTAINED POSITIONS - 45°**

- Black
- Black
- Black



NO  
2 NO  
NO + NC

L21TA03-1E10  
L21TA03-3E20  
L21TA03-3E11

L22TA03-1E10  
L22TA03-3E20  
L22TA03-3E11

**MAINTAINED POSITIONS - 45°**

- Black



2 NO

L21UA03-3E20

L22UA03-3E20

### WITH KEY

#### 2 positions



L21LA00-1E10

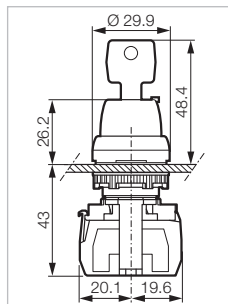

Supplied with 2 keys profile n°455

**MAINTAINED POSITIONS - 45°**

Key free in position 0

- Black
- Black
- Black



NO  
2 NO  
NO + NC

L21LA00-1E10  
L21LA00-3E20  
L21LA00-3E11

L22LA00-1E10  
L22LA00-3E20  
L22LA00-3E11

**SPRING RETURN - 45°**

Key free in position 0

- Black
- Black
- Black



NO  
2 NO  
NO + NC

L21LB00-1E10  
L21LB00-3E20  
L21LB00-3E11

L22LB00-1E10  
L22LB00-3E20  
L22LB00-3E11

**MAINTAINED - 90°**

Key free in both positions

- Black
- Black
- Black



NO  
2 NO  
NO + NC

L21LG00-1E10  
L21LG00-3E20  
L21LG00-3E11

L22LG00-1E10  
L22LG00-3E20  
L22LG00-3E11

### WITH KEY

#### 3 positions



L21NA00-3E20

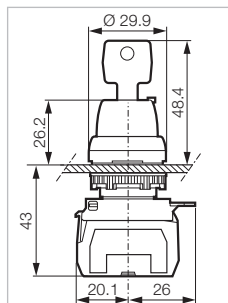

Supplied with 2 keys profile n°455

**MAINTAINED POSITIONS - 45°**

Key free in position 0

- Black



2 NO

L21NA00-3E20

L22NA00-3E20

**SPRING RETURN - 45°**

Key free in position 0

- Black



2 NO

L21ND00-3E20

L22ND00-3E20

# Complete units: Joysticks $\phi$ 22MM

## ▶ JOYSTICK SWITCHES - NON ILLUMINATED

 Technical Info (p.106)

### HEAD, CLIP AND MODULE(S)

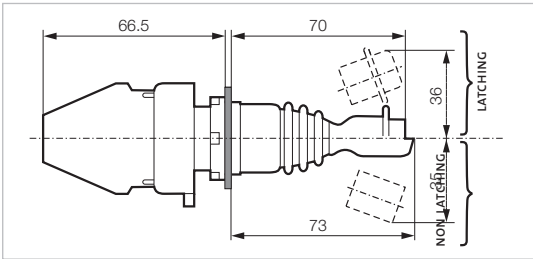

All contacts are open in the center position (0). Complete units shown feature one or two independent contact closed in each position A,B,C, and D.



LM2F-3M2

#### HEAD DOES NOT LOCK IN CENTER POSITION 0

##### 2 POSITIONS WITH OFF

		# Contacts Closed Per Position	Total # Contacts	Part Number
maintained	A ↓ 0 ↑ B	1	2	LM2F-3M2
		2	4	LM2F-3M4
spring return	A ↓ 0 ↑ B	1	2	LM2A-3M2
		2	4	LM2A-3M4

##### 4 POSITIONS WITH OFF

maintained	A ↓ 0 ↑ B	1	4	LM4F-3M4
	C ← 0 → D	2	8	LM4F-5M8
spring-return	A ↓ 0 ↑ B	1	4	LM4A-3M4
	C ← 0 → D	2	8	LM4A-5M8



LMV4F-5M8

#### HEAD LOCKS IN CENTER POSITION 0

##### 2 POSITIONS WITH OFF

maintained	A ↓ 0 ↑ B	1	2	LMV2F-3M2
		2	4	LMV2F-3M4
spring return	A ↓ 0 ↑ B	1	2	LMV2A-3M2
		2	4	LMV2A-3M4

##### 4 POSITIONS WITH OFF

maintained	A ↓ 0 ↑ B	1	4	LMV4F-3M4
	C ← 0 → D	2	8	LMV4F-5M8
spring return	A ↓ 0 ↑ B	1	4	LMV4A-3M4
	C ← 0 → D	2	8	LMV4A-5M8

# Complete units: Part Numbering System

## ► ILLUMINATED COMPLETE UNITS

L21AH20 - **3** **EA** **G** **M** **1** **1** **Y7**  
a b c d e f g

Part number of illuminated operator head.  
 See pages 48 to 56 for illuminated operator heads.

*a*

CLIP	
Code	Description
1	single module
3	three modules
4	three modules (when using 33E11 contact blocks)
5	five modules

*b*

TERMINAL STYLE	
Code	Description
EA	Screw and Clamp
EDA	Stab (Quick Connect)
EPA	PCB
ERA	Plug In

*c*

LED COLOR	
Code	Description
R	Red
G	Green
Y	Yellow
W	White
B	Blue

*d*

LED VOLTAGE	
Code	Description
L	12/24 Vac/dc
L4	48 Vac/dc
M	130 Vac
H	230 Vac

*e*

N.O. (NORMALLY OPEN) CONTACTS	
Code	Description
o	No Contact
1	1 N.O.
2	2 N.O.
3	3 N.O.
4	4 N.O.

*f*

N.C. (NORMALLY CLOSED) CONTACTS	
Code	Description
o	No Contact
1	1 N.C.
2	2 N.C.
3	3 N.C.
4	4 N.C.

*g*

SPECIALTY BLOCKS	
Code	Description
C	Late Break N.C. (Screw and Clamp terminals only)
Y7	Gold Plated Contacts (Screw and Clamp or PCB terminals only)



# Complete units: Pushbuttons $\varnothing$ 22mm

## ► SPRING RETURN - ILLUMINATED

 Technical Info (p.106)

### FLUSH

Chrome Bezel  
Part Number

Black Bezel  
Part Number



L21AH20-3EAGL11

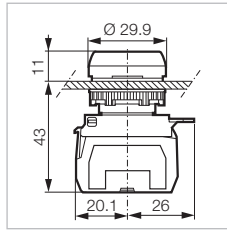

LED blocks

**12/24 Vac/dc**

● Red	NO+NC
● Green	NO+NC
● Yellow	NO+NC
○ White	NO+NC
● Blue	NO+NC

L21AH10-3EARL11
L21AH20-3EAGL11
L21AH40-3EAYL11
L21AH50-3EAWL11
L21AH60-3EABL11

L22AH10-3EARL11
L22AH20-3EAGL11
L22AH40-3EAYL11
L22AH50-3EAWL11
L22AH60-3EABL11

**130 Vac**

● Red	NO+NC
● Green	NO+NC
● Yellow	NO+NC
○ White	NO+NC
● Blue	NO+NC

L21AH10-3EARM11
L21AH20-3EAGM11
L21AH40-3EAYM11
L21AH50-3EAWM11
L21AH60-3EABM11

L22AH10-3EARM11
L22AH20-3EAGM11
L22AH40-3EAYM11
L22AH50-3EAWM11
L22AH60-3EABM11

### PROJECTING



L21AK40-3EAYM11

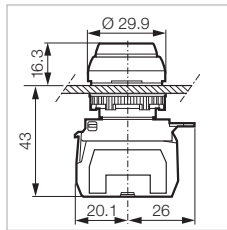

LED blocks

**12/24 Vac/dc**

● Red	NO+NC
● Green	NO+NC
● Yellow	NO+NC
○ White	NO+NC
● Blue	NO+NC

L21AK10-3EARL11
L21AK20-3EAGL11
L21AK40-3EAYL11
L21AK50-3EAWL11
L21AK60-3EABL11

L22AK10-3EARL11
L22AK20-3EAGL11
L22AK40-3EAYL11
L22AK50-3EAWL11
L22AK60-3EABL11

**130 Vac**

● Red	NO+NC
● Green	NO+NC
● Yellow	NO+NC
○ White	NO+NC
● Blue	NO+NC

L21AK10-3EARM11
L21AK20-3EAGM11
L21AK40-3EAYM11
L21AK50-3EAWM11
L21AK60-3EABM11

L22AK10-3EARM11
L22AK20-3EAGM11
L22AK40-3EAYM11
L22AK50-3EAWM11
L22AK60-3EABM11

### $\varnothing$ 32 MUSHROOM



L21AL10-3EARL11

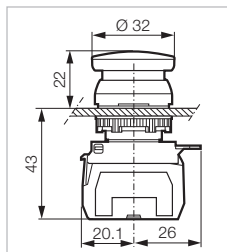

LED blocks

**12/24 Vac/dc**

● Red	NO+NC
● Green	NO+NC
● Yellow	NO+NC
○ White	NO+NC
● Blue	NO+NC

L21AL10-3EARL11
L21AL20-3EAGL11
L21AL40-3EAYL11
L21AL50-3EAWL11
L21AL60-3EABL11

L22AL10-3EARL11
L22AL20-3EAGL11
L22AL40-3EAYL11
L22AL50-3EAWL11
L22AL60-3EABL11

**130 Vac**

● Red	NO+NC
● Green	NO+NC
● Yellow	NO+NC
○ White	NO+NC
● Blue	NO+NC

L21AL10-3EARM11
L21AL20-3EAGM11
L21AL40-3EAYM11
L21AL50-3EAWM11
L21AL60-3EABM11

L22AL10-3EARM11
L22AL20-3EAGM11
L22AL40-3EAYM11
L22AL50-3EAWM11
L22AL60-3EABM11

# Complete units: Pushbuttons $\phi$ 22MM

## ► SPRING RETURN - ILLUMINATED

 Technical Info (p. 106)

### TWIN TOUCH - FLUSH-FLUSH

Chrome Bezel  
Part Number

Black Bezel  
Part Number



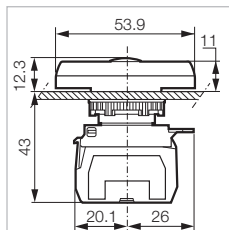

L61QH21-3EAWM11



Center part illuminated - White LED Block (other colors available)

#### 12/24 VAC/DC - WITH INTERNATIONAL SYMBOLS

	Green	NO		
	Red	NC	L61QH21-3EAWL11	L62QH21-3EAWL11

#### 12/24 VAC/DC - WITH TEXT

	Green (START)	NO		
	Red (STOP)	NC	L61QH21A-3EAWL11	L62QH21A-3EAWL11

#### 130 VAC - WITH INTERNATIONAL SYMBOLS

	Green	NO		
	Red	NC	L61QH21-3EAWM11	L62QH21-3EAWM11

#### 130 VAC - WITH TEXT

	Green (START)	NO		
	Red (STOP)	NC	L61QH21A-3EAWM11	L62QH21A-3EAWM11

#### 230 VAC - WITH INTERNATIONAL SYMBOLS

	Green	NO		
	Red	NC	L61QH21-3EAWH11	L62QH21-3EAWH11

#### 230 VAC - WITH TEXT

	Green (START)	NO		
	Red (STOP)	NC	L61QH21A-3EAWH11	L62QH21A-3EAWH11

### TWIN TOUCH - FLUSH-PROJECTING



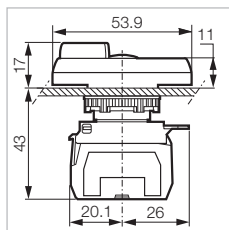

L61QK21A-3EAWL11



Center part illuminated - White LED Block (other colors available)

#### 12/24 VAC/DC - WITH INTERNATIONAL SYMBOLS

	Green	NO		
	Red	NC	L61QK21-3EAWL11	L62QK21-3EAWL11

#### 12/24 VAC/DC - WITH TEXT

	Green (START)	NO		
	Red (STOP)	NC	L61QK21A-3EAWL11	L62QK21A-3EAWL11



#### 130 VAC - WITH INTERNATIONAL SYMBOLS

	Green	NO		
	Red	NC	L61QK21-3EAWM11	L62QK21-3EAWM11

#### 130 VAC - WITH TEXT

	Green (START)	NO		
	Red (STOP)	NC	L61QK21A-3EAWM11	L62QK21A-3EAWM11

#### 230 VAC - WITH INTERNATIONAL SYMBOLS

	Green	NO		
	Red	NC	L61QK21-3EAWH11	L62QK21-3EAWH11

#### 230 VAC - WITH TEXT

	Green (START)	NO		
	Red (STOP)	NC	L61QK21A-3EAWH11	L62QK21A-3EAWH11

# Complete units: Pushbuttons $\varnothing$ 22mm

## ► MAINTAINED - ILLUMINATED

 Technical Info (p.106)

### FLUSH



L21CH20-3EAGL1

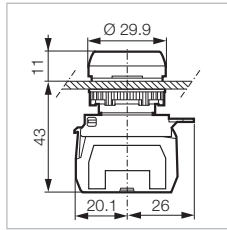

#### LED blocks

##### 12/24 Vac/Dc

● Red	NO+NC
● Green	NO+NC
● Yellow	NO+NC
○ White	NO+NC
● Blue	NO+NC

Chrome Bezel  
Part Number

Black Bezel  
Part Number

L21CH10-3EARL11
L21CH20-3EAGL11
L21CH40-3EAYL11
L21CH50-3EAWL11
L21CH60-3EABL11

L22CH10-3EARL11
L22CH20-3EAGL11
L22CH40-3EAYL11
L22CH50-3EAWL11
L22CH60-3EABL11

##### 130 Vac

● Red	NO+NC
● Green	NO+NC
● Yellow	NO+NC
○ White	NO+NC
● Blue	NO+NC

L21CH10-3EARM11
L21CH20-3EAGM11
L21CH40-3EAYM11
L21CH50-3EAWM11
L21CH60-3EABM11

L22CH10-3EARM11
L22CH20-3EAGM11
L22CH40-3EAYM11
L22CH50-3EAWM11
L22CH60-3EABM11

##### 230 Vac

● Red	NO+NC
● Green	NO+NC
● Yellow	NO+NC
○ White	NO+NC
● Blue	NO+NC

L21CH10-3EARH11
L21CH20-3EAGH11
L21CH40-3EAYH11
L21CH50-3EAWH11
L21CH60-3EABH11

L22CH10-3EARH11
L22CH20-3EAGH11
L22CH40-3EAYH11
L22CH50-3EAWH11
L22CH60-3EABH11

### PROJECTING



L21CK40-3EAYL11

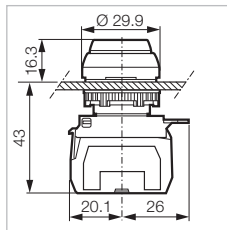

#### LED blocks

##### 12/24 Vac/Dc

● Red	NO+NC
● Green	NO+NC
● Yellow	NO+NC
○ White	NO+NC
● Blue	NO+NC

L21CK10-3EARL11
L21CK20-3EAGL11
L21CK40-3EAYL11
L21CK50-3EAWL11
L21CK60-3EABL11

L22CK10-3EARL11
L22CK20-3EAGL11
L22CK40-3EAYL11
L22CK50-3EAWL11
L22CK60-3EABL11

##### 130 Vac

● Red	NO+NC
● Green	NO+NC
● Yellow	NO+NC
○ White	NO+NC
● Blue	NO+NC

L21CK10-3EARM11
L21CK20-3EAGM11
L21CK40-3EAYM11
L21CK50-3EAWM11
L21CK60-3EABM11

L22CK10-3EARM11
L22CK20-3EAGM11
L22CK40-3EAYM11
L22CK50-3EAWM11
L22CK60-3EABM11

##### 230 Vac

● Red	NO+NC
● Green	NO+NC
● Yellow	NO+NC
○ White	NO+NC
● Blue	NO+NC

L21CK10-3EARH11
L21CK20-3EAGH11
L21CK40-3EAYH11
L21CK50-3EAWH11
L21CK60-3EABH11

L22CK10-3EARH11
L22CK20-3EAGH11
L22CK40-3EAYH11
L22CK50-3EAWH11
L22CK60-3EABH11

# Complete units: Pushbuttons $\varnothing$ 22MM

 Technical Info (p.106)

## ► MAINTAINED - ILLUMINATED

### $\varnothing$ 40 MUSHROOM

Push-pull to reset

Black Bezel  
Part Number



L22DM10-3EARM11

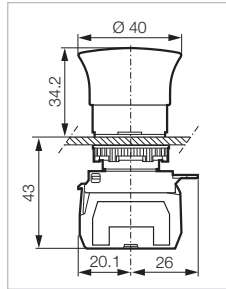

Red LED block

12/24 Vac/Dc

- Red NC
- Red 2 NC
- Red NO + NC

L22DM10-3EARL01  
L22DM10-3EARL02  
L22DM10-3EARL11

130 Vac

- Red NC
- Red 2 NC
- Red NO + NC

L22DM10-3EARM01  
L22DM10-3EARM02  
L22DM10-3EARM11

### $\varnothing$ 40 MUSHROOM

Push-turn to reset



L22EM10-3EARL02

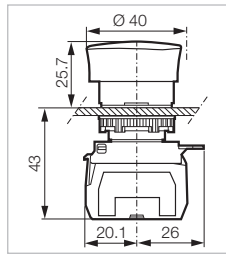

Red LED block

12/24 Vac/Dc

- Red NC
- Red 2 NC
- Red NO + NC

L22EM10-3EARL01  
L22EM10-3EARL02  
L22EM10-3EARL11

130 Vac

- Red NC
- Red 2 NC
- Red NO + NC

L22EM10-3EARM01  
L22EM10-3EARM02  
L22EM10-3EARM11

## ► EMERGENCY STOP MAINTAINED - ILLUMINATED

### $\varnothing$ 40 ISO 13850

Push-pull to reset



L22DN10-3EARM02

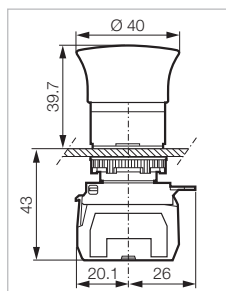

Head position visible from the side with yellow collar Compliant with the requirements of emergency stop:  $\varnothing$  ISO 13850

Red LED block

12/24 Vac/Dc

- Red NC
- Red 2 NC
- Red NO + NC

L22DN10-3EARL01  
L22DN10-3EARL02  
L22DN10-3EARL11

130 Vac







- Red NC
- Red 2 NC
- Red NO + NC

L22DN10-3EARM01  
L22DN10-3EARM02  
L22DN10-3EARM11

# Complete units: Selector switches $\varnothing$ 22mm

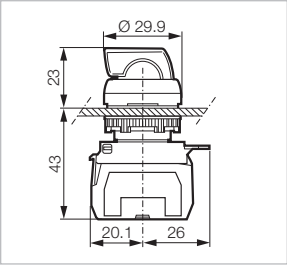
## ▶ SELECTOR SWITCHES - ILLUMINATED

 Technical Info (p.106)





WITH HANDLE	2 positions		Chrome Bezel Part Number	Black Bezel Part Number	
 <p>L21KG10-3EARL11</p>	<b>LED COLOR / HANDLE COLOR</b>  <b>MAINTAINED POSITIONS - 45°</b> <b>12/24 Vac/Dc</b> <ul style="list-style-type: none"> <li>● Red / Red</li> <li>● Green / Green</li> <li>○ White / Black</li> <li>● Yellow / Black</li> <li>● Blue / Black</li> </ul>		NO + NC NO + NC NO + NC NO + NC NO + NC	<b>L21KG10-3EARL11</b> <b>L21KG20-3EAGL11</b> <b>L21KG30-3EAWL11</b> <b>L21KG30-3EAYL11</b> <b>L21KG30-3EABL11</b>	<b>L22KG10-3EARL11</b> <b>L22KG20-3EAGL11</b> <b>L22KG30-3EAWL11</b> <b>L22KG30-3EAYL11</b> <b>L22KG30-3EABL11</b>
	<b>130 Vac</b> <ul style="list-style-type: none"> <li>● Red / Red</li> <li>● Green / Green</li> <li>○ White / Black</li> <li>● Yellow / Black</li> <li>● Blue / Black</li> </ul>		NO + NC NO + NC NO + NC NO + NC NO + NC	<b>L21KG10-3EARM11</b> <b>L21KG20-3EAGM11</b> <b>L21KG30-3EAWM11</b> <b>L21KG30-3EAYM11</b> <b>L21KG30-3EABM11</b>	<b>L22KG10-3EARM11</b> <b>L22KG20-3EAGM11</b> <b>L22KG30-3EAWM11</b> <b>L22KG30-3EAYM11</b> <b>L22KG30-3EABM11</b>
	<b>SPRING RETURN - 45°</b> <b>12/24 Vac/Dc</b> <ul style="list-style-type: none"> <li>● Red / Red</li> <li>● Green / Green</li> <li>○ White / Black</li> <li>● Yellow / Black</li> <li>● Blue / Black</li> </ul>		NO + NC NO + NC NO + NC NO + NC NO + NC	<b>L21KH10-3EARL11</b> <b>L21KH20-3EAGL11</b> <b>L21KH30-3EAWL11</b> <b>L21KH30-3EAYL11</b> <b>L21KH30-3EABL11</b>	<b>L22KH10-3EARL11</b> <b>L22KH20-3EAGL11</b> <b>L22KH30-3EAWL11</b> <b>L22KH30-3EAYL11</b> <b>L22KH30-3EABL11</b>
	<b>130 Vac</b> <ul style="list-style-type: none"> <li>● Red / Red</li> <li>● Green / Green</li> <li>○ White / Black</li> <li>● Yellow / Black</li> <li>● Blue / Black</li> </ul>		NO + NC NO + NC NO + NC NO + NC NO + NC	<b>L21KH10-3EARM11</b> <b>L21KH20-3EAGM11</b> <b>L21KH30-3EAWM11</b> <b>L21KH30-3EAYM11</b> <b>L21KH30-3EABM11</b>	<b>L22KH10-3EARM11</b> <b>L22KH20-3EAGM11</b> <b>L22KH30-3EAWM11</b> <b>L22KH30-3EAYM11</b> <b>L22KH30-3EABM11</b>
	<b>MAINTAINED POSITIONS - 90°</b> <b>12/24 Vac/Dc</b> <ul style="list-style-type: none"> <li>● Red / Red</li> <li>● Green / Green</li> <li>○ White / Black</li> <li>● Yellow / Black</li> <li>● Blue / Black</li> </ul>		NO + NC NO + NC NO + NC NO + NC NO + NC	<b>L21KL10-3EARL11</b> <b>L21KL20-3EAGL11</b> <b>L21KL30-3EAWL11</b> <b>L21KL30-3EAYL11</b> <b>L21KL30-3EABL11</b>	<b>L22KL10-3EARL11</b> <b>L22KL20-3EAGL11</b> <b>L22KL30-3EAWL11</b> <b>L22KL30-3EAYL11</b> <b>L22KL30-3EABL11</b>
	<b>130 Vac</b> <ul style="list-style-type: none"> <li>● Red / Red</li> <li>● Green / Green</li> <li>○ White / Black</li> <li>● Yellow / Black</li> <li>● Blue / Black</li> </ul>		NO + NC NO + NC NO + NC NO + NC NO + NC	<b>L21KL10-3EARM11</b> <b>L21KL20-3EAGM11</b> <b>L21KL30-3EAWM11</b> <b>L21KL30-3EAYM11</b> <b>L21KL30-3EABM11</b>	<b>L22KL10-3EARM11</b> <b>L22KL20-3EAGM11</b> <b>L22KL30-3EAWM11</b> <b>L22KL30-3EAYM11</b> <b>L22KL30-3EABM11</b>



# Complete units: Selector switches $\phi$ 22mm

## ▶ SELECTOR SWITCHES - ILLUMINATED

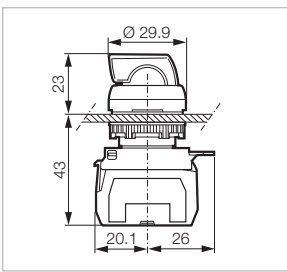
 Technical Info (p.106)

WITH HANDLE	3 positions		Chrome Bezel Part Number	Black Bezel Part Number
 <p>L21ME20-3EAGL20</p>	<b>LED COLOR / HANDLE COLOR</b> <b>MAINTAINED POSITIONS - 45°</b> <b>12/24 Vac/Dc</b> <ul style="list-style-type: none"> <li>● Red / Red</li> <li>● Green / Green</li> <li>○ White / Black</li> <li>● Yellow / Black</li> <li>● Blue / Black</li> </ul>		2 NO 2 NO 2 NO 2 NO 2 NO <b>L21ME10-3EARL20</b> <b>L21ME20-3EAGL20</b> <b>L21ME30-3EAWL20</b> <b>L21ME30-3EAYL20</b> <b>L21ME30-3EABL20</b>	<b>L22ME10-3EARL20</b> <b>L22ME20-3EAGL20</b> <b>L22ME30-3EAWL20</b> <b>L22ME30-3EAYL20</b> <b>L22ME30-3EABL20</b>
	<b>130 Vac/Dc</b> <ul style="list-style-type: none"> <li>● Red / Red</li> <li>● Green / Green</li> <li>○ White / Black</li> <li>● Yellow / Black</li> <li>● Blue / Black</li> </ul>	2 NO 2 NO 2 NO 2 NO 2 NO <b>L21ME10-3EARM20</b> <b>L21ME20-3EAGM20</b> <b>L21ME30-3EAWM20</b> <b>L21ME30-3EAYM20</b> <b>L21ME30-3EABM20</b>	<b>L22ME10-3EARM20</b> <b>L22ME20-3EAGM20</b> <b>L22ME30-3EAWM20</b> <b>L22ME30-3EAYM20</b> <b>L22ME30-3EABM20</b>	
	<b>SPRING RETURN - 45°</b> <b>12/24 Vac/Dc</b> <ul style="list-style-type: none"> <li>● Red / Red</li> <li>● Green / Green</li> <li>○ White / Black</li> <li>● Yellow / Black</li> <li>● Blue / Black</li> </ul>		2 NO 2 NO 2 NO 2 NO 2 NO <b>L21MH10-3EARL20</b> <b>L21MH20-3EAGL20</b> <b>L21MH30-3EAWL20</b> <b>L21MH30-3EAYL20</b> <b>L21MH30-3EABL20</b>	<b>L22MH10-3EARL20</b> <b>L22MH20-3EAGL20</b> <b>L22MH30-3EAWL20</b> <b>L22MH30-3EAYL20</b> <b>L22MH30-3EABL20</b>
	<b>130 Vac</b> <ul style="list-style-type: none"> <li>● Red / Red</li> <li>● Green / Green</li> <li>○ White / Black</li> <li>● Yellow / Black</li> <li>● Blue / Black</li> </ul>	2 NO 2 NO 2 NO 2 NO 2 NO <b>L21MH10-3EARM20</b> <b>L21MH20-3EAGM20</b> <b>L21MH30-3EAWM20</b> <b>L21MH30-3EAYM20</b> <b>L21MH30-3EABM20</b>	<b>L22MH10-3EARM20</b> <b>L22MH20-3EAGM20</b> <b>L22MH30-3EAWM20</b> <b>L22MH30-3EAYM20</b> <b>L22MH30-3EABM20</b>	
	<b>MAINTAINED / SPRING RETURN - 45°</b> <b>12/24 Vac/Dc</b> <ul style="list-style-type: none"> <li>● Red / Red</li> <li>● Green / Green</li> <li>○ White / Black</li> <li>● Yellow / Black</li> <li>● Blue / Black</li> </ul>		NO + NC NO + NC NO + NC NO + NC NO + NC <b>L21MG10-3EARL11</b> <b>L21MG20-3EAGL11</b> <b>L21MG30-3EAWL11</b> <b>L21MG30-3EAYL11</b> <b>L21MG30-3EABL11</b>	<b>L22MG10-3EARL11</b> <b>L22MG20-3EAGL11</b> <b>L22MG30-3EAWL11</b> <b>L22MG30-3EAYL11</b> <b>L22MG30-3EABL11</b>
	<b>130 Vac</b> <ul style="list-style-type: none"> <li>● Red / Red</li> <li>● Green / Green</li> <li>○ White / Black</li> <li>● Yellow / Black</li> <li>● Blue / Black</li> </ul>	NO + NC NO + NC NO + NC NO + NC NO + NC <b>L21MG10-3EARM11</b> <b>L21MG20-3EAGM11</b> <b>L21MG30-3EAWM11</b> <b>L21MG30-3EAYM11</b> <b>L21MG30-3EABM11</b>	<b>L22MG10-3EARM11</b> <b>L22MG20-3EAGM11</b> <b>L22MG30-3EAWM11</b> <b>L22MG30-3EAYM11</b> <b>L22MG30-3EABM11</b>	

# Complete units: Pilot lights $\phi$ 22MM

## ► PILOT LIGHTS

### ONE-PIECE WITH INTEGRATED LED

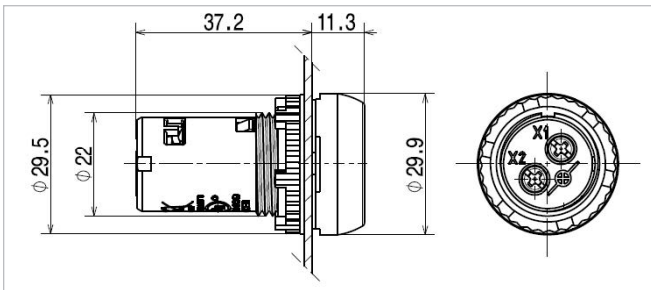

#### 24 Vac/Dc

- Red
- Green
- Yellow
- White
- Blue

#### Part Number

- L20SC10L
- L20SC20L
- L20SC40L
- L20SC50L
- L20SC60L

#### With Text or Symbol Part Number \*\*

- L20SC31L [ ] [ ] [ ] [ ]
- L20SC32L [ ] [ ] [ ] [ ]
- L20SC34L [ ] [ ] [ ] [ ]
- L20SC35L [ ] [ ] [ ] [ ]
- L20SC36L [ ] [ ] [ ] [ ]

#### 130 Vac/Dc

- Red
- Green
- Yellow
- White
- Blue

- L20SC10M
- L20SC20M
- L20SC40M
- L20SC50M
- L20SC60M

- L20SC31M [ ] [ ] [ ] [ ]
- L20SC32M [ ] [ ] [ ] [ ]
- L20SC34M [ ] [ ] [ ] [ ]
- L20SC35M [ ] [ ] [ ] [ ]
- L20SC36M [ ] [ ] [ ] [ ]

#### 230 Vac/Dc\*

- Red
- Green
- Yellow
- White
- Blue

- L20SC10H
- L20SC20H
- L20SC40H
- L20SC50H
- L20SC60H

- L20SC31H [ ] [ ] [ ] [ ]
- L20SC32H [ ] [ ] [ ] [ ]
- L20SC34H [ ] [ ] [ ] [ ]
- L20SC35H [ ] [ ] [ ] [ ]
- L20SC36H [ ] [ ] [ ] [ ]

\* 230V DC rating is Self-Declared.

\*\* Code to be added to end of part number.  
See p. 82 to 85 for standard text and symbol options.  
For custom text or symbol please contact us.

### HEAD, CLIP AND LED MODULE



L20SE20-1EAGM

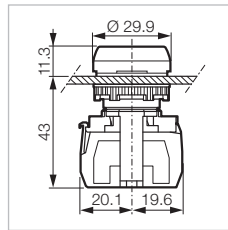

#### 12/24 Vac/Dc

- Red
- Green
- Yellow
- White
- Blue

#### 1 POSITION CLIP Part Number

- L20SE10-1EARL
- L20SE20-1EAGL
- L20SE40-1EAYL
- L20SE50-1EAWL
- L20SE60-1EABL

#### 3 POSITION CLIP Part Number

- L20SE10-3EARL
- L20SE20-3EAGL
- L20SE40-3EAYL
- L20SE50-3EAWL
- L20SE60-3EABL

#### 130Vac

- Red
- Green
- Yellow
- White
- Blue

- L20SE10-1EARM
- L20SE20-1EAGM
- L20SE40-1EAYM
- L20SE50-1EAWM
- L20SE60-1EABM

- L20SE10-3EARM
- L20SE20-3EAGM
- L20SE40-3EAYM
- L20SE50-3EAWM
- L20SE60-3EABM

#### 230Vac

- Red
- Green
- Yellow
- White
- Blue

- L20SE10-1EARH
- L20SE20-1EAGH
- L20SE40-1EAYH
- L20SE50-1EAWH
- L20SE60-1EABH



- L20SE10-3EARH
- L20SE20-3EAGH
- L20SE40-3EAYH
- L20SE50-3EAWH
- L20SE60-3EABH

# Operator Heads: $\phi$ 22MM

► SPRING RETURN - NON-ILLUMINATED

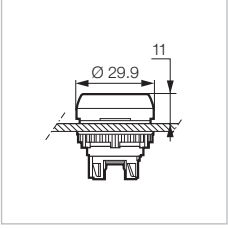

Technical Info (p.106)

FLUSH		Chrome Bezel Part Number	Black Bezel Part Number
		<ul style="list-style-type: none"> <li>● Red L21AA01</li> <li>● Green L21AA02</li> <li>● Black L21AA03</li> <li>● Yellow L21AA04</li> <li>○ White L21AA05</li> <li>● Blue L21AA06</li> </ul>	<ul style="list-style-type: none"> <li>L22AA01</li> <li>L22AA02</li> <li>L22AA03</li> <li>L22AA04</li> <li>L22AA05</li> <li>L22AA06</li> </ul>
L21AA02		<b>WITH INTERNATIONAL SYMBOL</b>	
		<ul style="list-style-type: none"> <li>Ⓢ Red L21AA81</li> <li>Ⓢ Green L21AA82</li> <li>Ⓢ Black L21AA83</li> </ul>	<ul style="list-style-type: none"> <li>L22AA81</li> <li>L22AA82</li> <li>L22AA83</li> </ul>
L22AA34328		<b>WITH TEXT OR SYMBOL</b> (see p. 80 to 83) Code to be added at the end of the part number. For custom text or symbol please contact us.	
		<ul style="list-style-type: none"> <li>● Red L21AA31</li> <li>● Green L21AA32</li> <li>● Black L21AA33</li> <li>● Yellow L21AA34</li> <li>○ White L21AA35</li> <li>● Blue L21AA36</li> </ul>	<ul style="list-style-type: none"> <li>L22AA31</li> <li>L22AA32</li> <li>L22AA33</li> <li>L22AA34</li> <li>L22AA35</li> <li>L22AA36</li> </ul>
L21AA00		<b>WITHOUT CAP</b>	
		Pushbutton caps (see p. 86)	
		L21AA00	L22AA00

# Operator Heads: Ø 22MM

► SPRING RETURN - NON-ILLUMINATED



Technical Info (p.106)

FLUSH WITH SHROUD

Reinforced degree of protection: IP 67

Black Bezel  
Part Number



L22AM01A

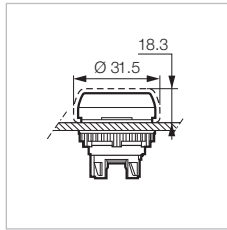

Supplied with flat shroud

**TRANSPARENT SHROUD**

- Red
- Green
- Black
- Yellow
- White
- Blue

Components  
Operator + Shroud

- L22AA01 + LWA0255
- L22AA02 + LWA0255
- L22AA03 + LWA0255
- L22AA04 + LWA0255
- L22AA05 + LWA0255
- L22AA06 + LWA0255

- L22AM01A**
- L22AM02A**
- L22AM03A**
- L22AM04A**
- L22AM05A**
- L22AM06A**

**WITH TEXT OR SYMBOL** (see p. 82 to 85)

Code to be added at the end of the part number.

For custom text or symbol please contact us.

- Red
- Green
- Black
- Yellow
- White
- Blue

- L22AA31[ ] [ ] + LWA0255
- L22AA32[ ] [ ] + LWA0255
- L22AA33[ ] [ ] + LWA0255
- L22AA34[ ] [ ] + LWA0255
- L22AA35[ ] [ ] + LWA0255
- L22AA36[ ] [ ] + LWA0255

- L22AM31[ ] [ ]**
- L22AM32[ ] [ ]**
- L22AM33[ ] [ ]**
- L22AM34[ ] [ ]**
- L22AM35[ ] [ ]**
- L22AM36[ ] [ ]**

**COLORED SHROUD**

- Red
- Green
- Black

- L22AA01 + LWA0251
- L22AA02 + LWA0252
- L22AA03 + LWA0253

- L22AM01**
- L22AM02**
- L22AM03**

# Operator Heads: $\varnothing$ 22MM

## ► SPRING RETURN - NON-ILLUMINATED



Technical Info (p.106)

### SUPER FLUSH

Chrome Bezel  
Part Number

Black Bezel  
Part Number



L23AA02

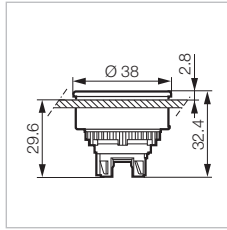

Metal chrome bezel  
Panel cut-out  $\varnothing$  30mm

- Red L23AA01
- Green L23AA02
- Black L23AA03
- Yellow L23AA04
- White L23AA05
- Blue L23AA06

**WITH INTERNATIONAL SYMBOL**

- Red L23AA81
- Green L23AA82

### PROJECTING



L21AB01

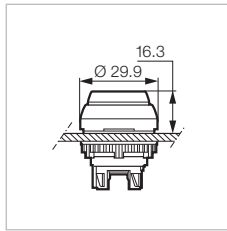

- Red L21AB01
- Green L21AB02
- Black L21AB03
- Yellow L21AB04
- White L21AB05
- Blue L21AB06

- L22AB01
- L22AB02
- L22AB03
- L22AB04
- L22AB05
- L22AB06

**WITH INTERNATIONAL SYMBOL**

- Red L21AB01B L22AB01B

### PROJECTING WITH SHROUD

Reinforced degree of protection: IP 67

Black Bezel  
Part Number



L22AX04

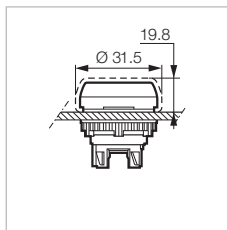

Supplied with domed shroud

**TRANSPARENT SHROUD**

Components  
Operator + Shroud

- Red L22AB01 + LWA0228 L22AX01
- Green L22AB02 + LWA0228 L22AX02
- Black L22AB03 + LWA0228 L22AX03
- Yellow L22AB04 + LWA0228 L22AX04
- White L22AB05 + LWA0228 L22AX05
- Blue L22AB06 + LWA0228 L22AX06

**COLORED SHROUD**

- Red L22AB01 + LWA0203 L22AW01
- Green L22AB02 + LWA0204 L22AW02
- Black L22AB03 + LWA0205 L22AW03

# Operator Heads: $\phi$ 22MM

## ► SPRING RETURN - NON-ILLUMINATED

 Technical Info (p.106)

### FLUSH-FLUSH

Twin touch - degree of protection: IP66

Chrome Bezel  
Part Number

Black Bezel  
Part Number



L61QA21

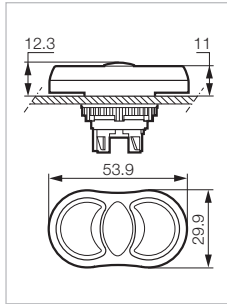

#### WITH INTERNATIONAL SYMBOLS

-  Green
-  Red

L61QA21



L62QA21

-  White
-  Black

L61QA53

L62QA53



#### WITH TEXT

-  Green (START)
-  Red (STOP)

L61QA21B

L62QA21B

#### WITH SYMBOLS OR ARROWS

-  Green  $\triangleleft$  (symbol for OPEN)
-  Green  $\triangleright$  (symbol for CLOSE)

L61QA22

L62QA22

-  Green  $\uparrow$
-  Green  $\downarrow$

L61QA22K

L62QA22K

-  Black  $\uparrow$
-  Black  $\downarrow$

L61QA33C

L62QA33C

#### BLANK

-  Green
-  Red

L61QA21V

L62QA21V

### FLUSH-PROJECTING

Twin touch - degree of protection: IP66



L61QB21

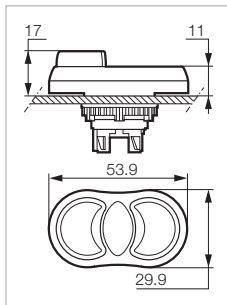



#### WITH INTERNATIONAL SYMBOLS

-  Green
-  Red

L61QB21

L62QB21

#### WITH TEXT

-  Green (START)
-  Red (STOP)

L61QB21B

L62QB21B

### FLUSH-PROJECTING WITH SHROUD

Twin touch - reinforced degree of protection: IP67



L61QM21

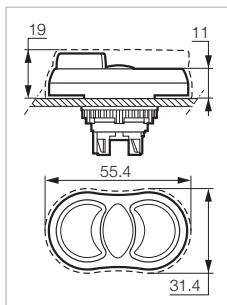

Supplied with transparent shroud



#### WITH INTERNATIONAL SYMBOLS

-  Green
-  Red

L61QM21

L62QM21

#### WITH TEXT

-  Green (START)
-  Red (STOP)

L61QM21B

L62QM21B



# Operator Heads: Ø 22MM

## ► SPRING RETURN - NON-ILLUMINATED



Technical Info (p.106)

### FLUSH-PROJECTING-FLUSH

Twin touch - degree of protection: IP66

Chrome Bezel Part Number

Black Bezel Part Number



L61BA22

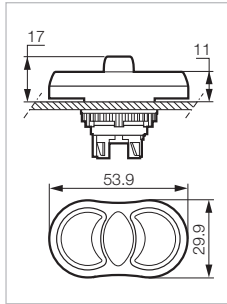

#### WITH ARROWS AND TEXT

- Green
- Red (STOP)
- Green

L61BA22

L62BA22

- Green
- Red (STOP)
- Green

L61BA22B

L62BA22B

#### WITH TEXT

- Green (UP)
- Red (STOP)
- Green (DOWN)

L61BA22G

L62BA22G

- Green (OPEN)
- Red (STOP)
- Green (CLOSE)

L61BA22F

L62BA22F

### Ø 32 MUSHROOM



L21AC03

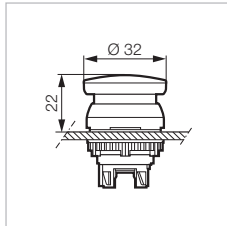

- Red
- Green
- Black
- Yellow

L21AC01  
L21AC02  
L21AC03  
L21AC04

L22AC01  
L22AC02  
L22AC03  
L22AC04

### Ø 40 MUSHROOM



L21AD01

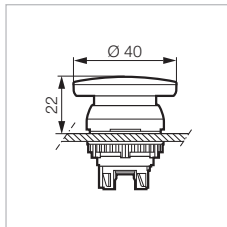

- Red
- Green
- Black
- Yellow
- Blue

L21AD01  
L21AD02  
L21AD03  
L21AD04  
L21AD06

L22AD01  
L22AD02  
L22AD03  
L22AD04  
L22AD06

#### WITH TEXT

- Red (STOP STOP STOP)

L21AD01S

L22AD01S

### Ø 70 MUSHROOM



L21AE03

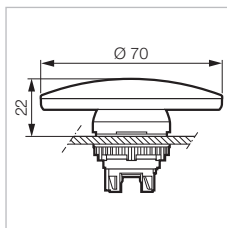

- Red
- Black

L21AE01  
L21AE03

L22AE01  
L22AE03

# Operator Heads: $\varnothing$ 22MM

## ► MAINTAINED - NON-ILLUMINATED



Technical Info (p.106)

### FLUSH

Chrome Bezel  
Part Number

Black Bezel  
Part Number

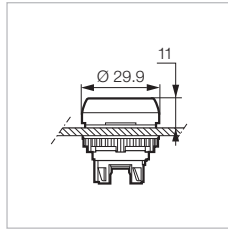

- Red
- Green
- Black
- Yellow
- White
- Blue

- L21CA01
- L21CA02
- L21CA03
- L21CA04
- L21CA05
- L21CA06

- L22CA01
- L22CA02
- L22CA03
- L22CA04
- L22CA05
- L22CA06

L21CA01

### PROJECTING

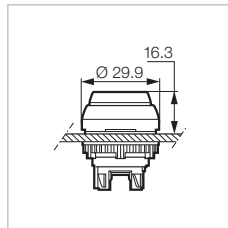

- Red
- Green
- Black
- Yellow
- White
- Blue

- L21CB01
- L21CB02
- L21CB03
- L21CB04
- L21CB05
- L21CB06

- L22CB01
- L22CB02
- L22CB03
- L22CB04
- L22CB05
- L22CB06

L21CB02

### $\varnothing$ 32 MUSHROOM

Push-turn to reset

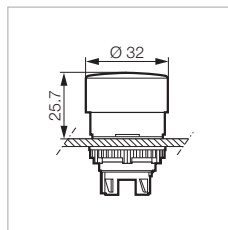

- Red
- Green
- Black
- Yellow

- L22EC01
- L22EC02
- L22EC03
- L22EC04

L22EC01

### $\varnothing$ 32 MUSHROOM

Push-pull to reset

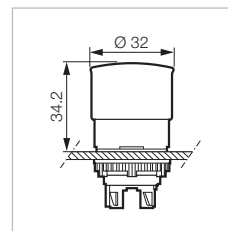

- Red

- L22DC01

L22DC01

# Operator Heads: $\varnothing$ 22MM

## ► MAINTAINED - NON-ILLUMINATED



Technical Info (p.106)

### $\varnothing$ 40 - MUSHROOM

Push-pull to reset

Black Bezel  
Part Number



L22DD01

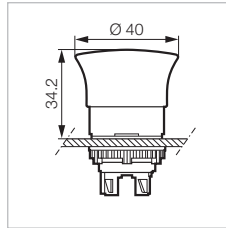

- Red
- Green
- Black
- Yellow

L22DD01  
L22DD02  
L22DD03  
L22DD04

**WITH TEXT**

- Red (STOP STOP STOP)

L22DD01S

**WITH INTERNATIONAL SYMBOL**

- Red

L22DD01C

### $\varnothing$ 40 MUSHROOM

Push-turn to reset



L22ED01

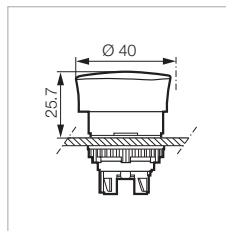

- Red
- Green
- Black
- Yellow

L22ED01  
L22ED02  
L22ED03  
L22ED04

**WITH TEXT**

- Red (STOP STOP STOP)

L22ED01S

**WITH WHITE ARROWS**

- Red

L22ED01G

### $\varnothing$ 40 - MUSHROOM

Key to reset



L22GM01

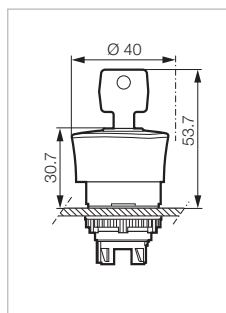

Supplied with 2 keys profile n° 455

- Red

L22GM01

# Operator Heads: $\varnothing$ 22MM

## ► EMERGENCY STOP MAINTAINED - NON-ILLUMINATED



Technical Info (p.106)

Black Bezel  
Part Number

$\varnothing$  32 ISO 13850

Push-pull



L22DQ01

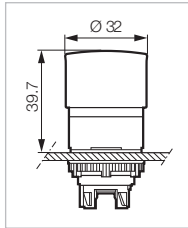

Head position visible from the side with yellow collar  
Compliant with the requirements of emergency stop:  
ISO 13850

● Red

L22DQ01

$\varnothing$  32 ISO 13850

Key to reset



L22GQ01

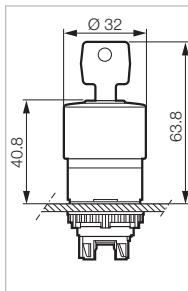

Supplied with 2 keys profile n° 455  
Head position visible from the side with yellow collar  
Compliant with the requirements of emergency stop:  
ISO 13850

● Red

L22GQ01

$\varnothing$  40 ISO 13850

Push-pull to reset



L22DR01

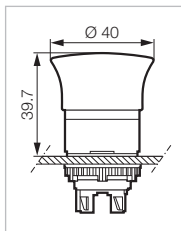

Head position visible from the side with yellow collar  
Compliant with the requirements of emergency stop:  
ISO 13850

● Red

L22DR01

# Operator Heads: Ø 22MM

## ► EMERGENCY STOP MAINTAINED - NON-ILLUMINATED



Technical Info (p.106)

Ø 40 ISO 13850

Push-turn to reset

Black Bezel  
Part Number



L22ER01

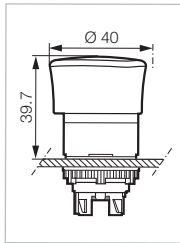

Head position visible from the side with yellow collar  
Compliant with the requirements of emergency stop:  
ISO 13850

● Red

L22ER01

WITH TEXT

● Red (EMO)

L22ER01F

WITH SYMBOL IEC 60947-5-5 / ISO 13850

Red

L22ER01K



L22ER01K

Ø 40 ISO 13850

Key to reset



L22GR01

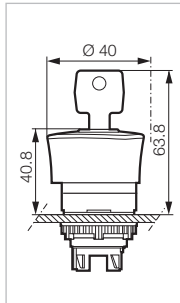

Supplied with 2 keys profile n° 455  
Head position visible from the side with yellow collar  
Compliant with the requirements of emergency stop:  
ISO 13850

● Red

L22GR01

Ø 54 ISO 13850

Push-pull to reset with flag indicator



L22DU01

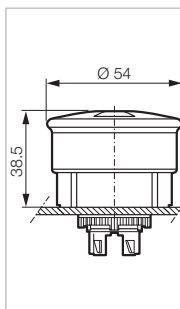

Head position visible from the side with yellow collar  
Compliant with the requirements of emergency stop:  
ISO 13850

● Red - (O- I)

L22DU01A

● Red - (STOP - I)

L22DU01

# Operator Heads: $\phi$ 22MM

## ▶ SELECTOR SWITCHES - NON-ILLUMINATED



Technical Info (p.106)

### WITH HANDLE

2 positions

Chrome Bezel  
Part Number

Black Bezel  
Part Number



L21KA03

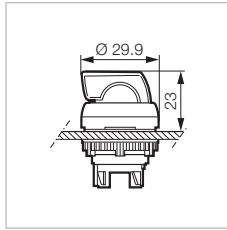

#### MAINTAINED POSITIONS - 45°

- Red
- Green
- Black
- Grey



L21KA01  
L21KA02  
L21KA03  
L21KA08

L22KA01  
L22KA02  
L22KA03  
L22KA08

#### SPRING RETURN - 45°

- Red
- Green
- Black
- Grey



L21KB01  
L21KB02  
L21KB03  
L21KB08

L22KB01  
L22KB02  
L22KB03  
L22KB08

#### MAINTAINED POSITIONS - 45°

- Red
- Green
- Black
- Grey



L21KC01  
L21KC02  
L21KC03  
L21KC08

L22KC01  
L22KC02  
L22KC03  
L22KC08

#### SPRING RETURN - 45°

- Red
- Green
- Black
- Grey



L21KD01  
L21KD02  
L21KD03  
L21KD08

L22KD01  
L22KD02  
L22KD03  
L22KD08

#### MAINTAINED POSITIONS - 90°

- Red
- Green
- Black
- Grey



L21KE01  
L21KE02  
L21KE03  
L21KE08

L22KE01  
L22KE02  
L22KE03  
L22KE08

#### MAINTAINED POSITIONS - 90°

- Red
- Green
- Black
- Grey



L21KF01  
L21KF02  
L21KF03  
L21KF08

L22KF01  
L22KF02  
L22KF03  
L22KF08



# Operator Heads: $\varnothing$ 22MM

## ▶ SELECTOR SWITCHES - NON-ILLUMINATED



Technical Info (p.106)

### WITH LEVER HANDLE

2 positions

Chrome Bezel  
Part Number

Black Bezel  
Part Number



L21KP03

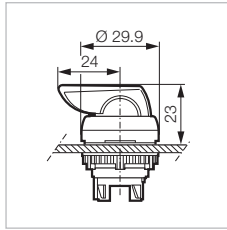

#### MAINTAINED POSITIONS - 45°

- Red
- Green
- Black
- Grey



L21KP01  
L21KP02  
L21KP03  
L21KP08

L22KP01  
L22KP02  
L22KP03  
L22KP08

#### SPRING RETURN - 45°

- Red
- Green
- Black



L21KQ01  
L21KQ02  
L21KQ03

L22KQ01  
L22KQ02  
L22KQ03

#### MAINTAINED POSITIONS - 45°

- Red
- Green
- Black



L21KR01  
L21KR02  
L21KR03

L22KR01  
L22KR02  
L22KR03

#### SPRING RETURN - 45°

- Red
- Green
- Black



L21KS01  
L21KS02  
L21KS03

L22KS01  
L22KS02  
L22KS03

#### MAINTAINED POSITIONS - 90°

- Red
- Green
- Black



L21KT01  
L21KT02  
L21KT03

L22KT01  
L22KT02  
L22KT03

#### MAINTAINED POSITIONS - 90°

- Red
- Green
- Black



L21KU01  
L21KU02  
L21KU03







L22KU01  
L22KU02  
L22KU03

# Operator Heads: $\varnothing$ 22mm

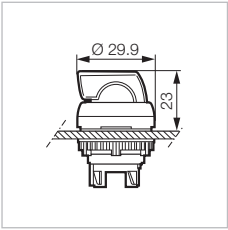
## ▶ SELECTOR SWITCHES - NON-ILLUMINATED



Technical Info (p.106)

WITH HANDLE	3 positions	Chrome Bezel Part Number	Black Bezel Part Number
 <p>L21MA03</p>		<b>MAINTAINED POSITIONS - 45°</b>	
		<ul style="list-style-type: none"> <li>● Red</li> <li>● Green</li> <li>● Black</li> <li>● Grey</li> </ul>	
 <p>L21MA08</p>		<b>SPRING RETURN FROM LEFT TO 0 - 45°</b>	
		<ul style="list-style-type: none"> <li>● Red</li> <li>● Green</li> <li>● Black</li> <li>● Grey</li> </ul>	
		<b>SPRING RETURN FROM RIGHT TO 0 - 45°</b>	
		<ul style="list-style-type: none"> <li>● Red</li> <li>● Green</li> <li>● Black</li> <li>● Grey</li> </ul>	
		<b>SPRING RETURN TO 0 - 45°</b>	
		<ul style="list-style-type: none"> <li>● Red</li> <li>● Green</li> <li>● Black</li> <li>● Grey</li> </ul>	
		<b>MAINTAINED POSITIONS - 90°</b>	
		<ul style="list-style-type: none"> <li>● Red</li> <li>● Green</li> <li>● Black</li> <li>● Grey</li> </ul>	

# Operator Heads: $\varnothing$ 22MM

## ▶ SELECTOR SWITCHES - NON-ILLUMINATED



Technical Info (p.106)

### WITH LEVER HANDLE

3 positions

Chrome Bezel  
Part Number

Black Bezel  
Part Number



L21MR03

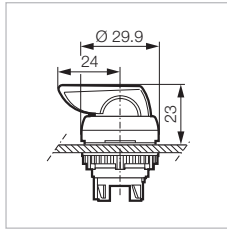

#### MAINTAINED POSITIONS - 45°

- Red
- Green
- Black
- Grey



L21MR01  
L21MR02  
L21MR03  
L21MR08

L22MR01  
L22MR02  
L22MR03  
L22MR08

#### SPRING RETURN FROM LEFT TO 0 - 45°

- Red
- Green
- Black
- Grey



L21MS01  
L21MS02  
L21MS03  
L21MS08

L22MS01  
L22MS02  
L22MS03  
L22MS08

#### SPRING RETURN FROM RIGHT TO 0 - 45°

- Red
- Green
- Black
- Grey



L21MT01  
L21MT02  
L21MT03  
L21MT08

L22MT01  
L22MT02  
L22MT03  
L22MT08

#### SPRING RETURN TO 0 - 45°

- Red
- Green
- Black
- Grey



L21MU01  
L21MU02  
L21MU03  
L21MU08

L22MU01  
L22MU02  
L22MU03  
L22MU08

# Operator Heads: $\varnothing$ 22MM

## ▶ SELECTOR SWITCHES - NON-ILLUMINATED



Technical Info (p. 106)

### WITH KNOB

#### 2 positions

Chrome Bezel  
Part Number

Black Bezel  
Part Number



L21TF03

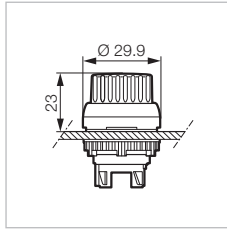

#### MAINTAINED POSITIONS - 45°

● Black L21TA03

L21TA03

L22TA03

#### SPRING RETURN - 45°

● Black L21TB03

L21TB03

L22TB03

#### MAINTAINED POSITIONS - 90°

L21TF03  
● Black L21TF03

L21TF03

L22TF03

### WITH KNOB

#### 3 positions



L21UA03

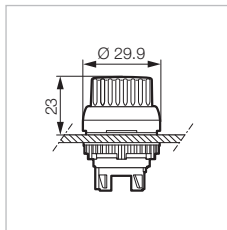

#### MAINTAINED POSITIONS - 45°

● Black L21UA03

L21UA03

L22UA03

#### SPRING RETURN FROM LEFT TO 0 - 45°

● Black L21UB03

L21UB03

L22UB03

#### SPRING RETURN FROM RIGHT TO 0 - 45°

● Black L21UC03

L21UC03

L22UC03

#### SPRING RETURN TO 0 - 45°

● Black L21UD03

L21UD03

L22UD03

#### MAINTAINED POSITIONS - 90°

● Black L21UK03

L21UK03

L22UK03

# Operator Heads: Ø 22MM

## ▶ SELECTOR SWITCHES - NON-ILLUMINATED



Technical Info (p.106)

WITH KEY	2 positions	Chrome Bezel Part Number	Black Bezel Part Number
----------	-------------	--------------------------	-------------------------



L21LG00

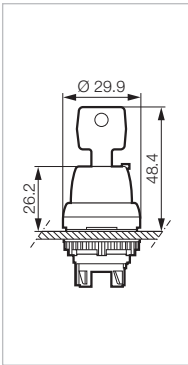

Supplied with 2 keys profile n° 455

KEY FREE IN POSITION:

**MAINTAINED POSITIONS - 45°**

● Black		0	<b>L21LA00</b>	<b>L22LA00</b>
---------	--	---	----------------	----------------

**SPRING RETURN - 45°**

● Black		0	<b>L21LB00</b>	<b>L22LB00</b>
---------	--	---	----------------	----------------

**MAINTAINED POSITIONS - 45°**

● Black		0	<b>L21LC00</b>	<b>L22LC00</b>
---------	--	---	----------------	----------------

**SPRING RETURN - 45°**

● Black		0	<b>L21LD00</b>	<b>L22LD00</b>
---------	--	---	----------------	----------------

**MAINTAINED POSITIONS - 90°**

● Black		0	<b>L21LF00</b>	<b>L22LF00</b>
---------	--	---	----------------	----------------

**MAINTAINED POSITIONS - 90°**

● Black		0 - 1	<b>L21LG00</b>	<b>L22LG00</b>
---------	--	-------	----------------	----------------

**MAINTAINED POSITIONS - 90°**

● Black		0 - 1	<b>L21LH00</b>	<b>L22LH00</b>
---------	--	-------	----------------	----------------

**MAINTAINED POSITIONS - 90°**

● Black		1	<b>L21LK00</b>	<b>L22LK00</b>
---------	--	---	----------------	----------------

FOR KEY PROFILE N° 1424A ADD SUFFIX "A" TO END OF ABOVE PART NUMBERS (IE. L21LA00A)

# Operator Heads: Ø 22MM

## ▶ SELECTOR SWITCHES - NON-ILLUMINATED



Technical Info (p.106)

WITH KEY	3 positions	Chrome Bezel Part Number	Black Bezel Part Number
----------	-------------	--------------------------	-------------------------



L21NA00

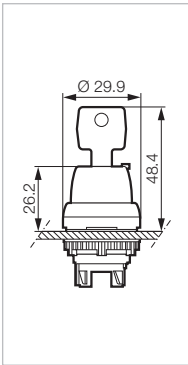

Supplied with 2 keys profile n° 455

KEY FREE IN POSITION:

**MAINTAINED POSITIONS - 45°**

● Black



0

L21NA00

L22NA00

**SPRING RETURN FROM LEFT TO 0 - 45°**

● Black



0

L21NB00

L22NB00

**SPRING RETURN FROM RIGHT TO 0 - 45°**

● Black



0

L21NC00

L22NC00

**SPRING RETURN TO 0 - 45°**

● Black



0

L21ND00

L22ND00

**MAINTAINED POSITIONS - 45°**

● Black



1 - 2

L21NE00

L22NE00

**SPRING RETURN FROM RIGHT TO 0 - 45°**

● Black



1

L21NJ00

L22NJ00

**MAINTAINED POSITIONS - 90°**

● Black



1 - 0 - 2

L21NK00

L22NK00

**MAINTAINED POSITIONS - 90°**

● Black



0

L21NL00

L22NL00

FOR KEY PROFILE N° 1424A ADD SUFFIX "A" TO END OF ABOVE PART NUMBERS (IE. L21NA00A)

# Operator Heads: Ø 22MM

## ▶ MECHANICAL ACTUATOR MOMENTARY - NON-ILLUMINATED



Technical Info (p.106)

### ADJUSTABLE MECHANICAL ACTUATOR - FLUSH

Chrome Bezel  
Part Number

Black Bezel  
Part Number

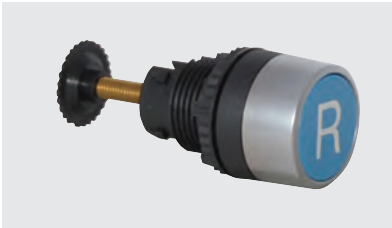

L21HA36949

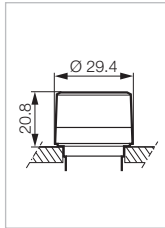

To be used without electrical block

Stroke 11 mm

Adjustable: 26 mm min to 46 mm max / front side of panel

#### WITHOUT TEXT OR SYMBOL

● Red	L21HA01	L22HA01
● Green	L21HA02	L22HA02
● Black	L21HA03	L22HA03
● Yellow	L21HA04	L22HA04
○ White	L21HA05	L22HA05
● Blue	L21HA06	L22HA06

#### WITH TEXT OR SYMBOL (see p. 80 to 83)

Code to be added at the end of the part number

For custom text or symbol please contact us.

● Red	L21HA31	L22HA31
● Green	L21HA32	L22HA32
● Black	L21HA33	L22HA33
● Yellow	L21HA34	L22HA34
○ White	L21HA35	L22HA35
● Blue	L21HA36	L22HA36
● R Blue	L21HA363949	L22HA363949

### ADJUSTABLE MECHANICAL ACTUATOR - PROJECTING



L21HB06

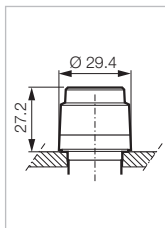

To be used without electrical block

Stroke 11 mm

Adjustable: 26 mm min to 46 mm max / front side of panel

● Red	L21HB01	L22HB01
● Green	L21HB02	L22HB02
● Black	L21HB03	L22HB03
● Yellow	L21HB04	L22HB04
○ White	L21HB05	L22HB05
● Blue	L21HB06	L22HB06



# Operator Heads: $\phi$ 22MM

► USB INTERFACE 3.0 A/A CONNECTION



Technical Info (p. 106)

Chrome Bezel  
Part Number



L21VB03

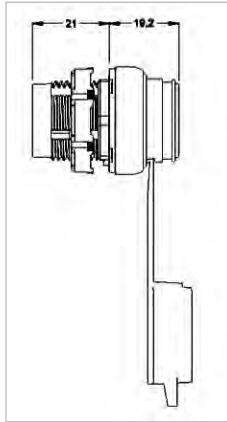

USB interface 3.0 type A/A connection  
USB Class: 3.0 (backward compatible with USB class 2.0)

**L21VB03**

Black Bezel  
Part Number



L22VA03L

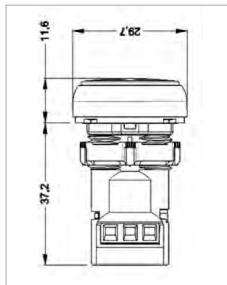

24 V AC/DC buzzer pulse or continuous sound  
130 V AC/DC buzzer pulse or continuous sound  
230 V AC/DC buzzer pulse or continuous sound

Buzzers operate at 80 dB at 10cm

**L22VA03L**  
**L22VA03M**  
**L22VA03H**

# Operator Heads: $\phi$ 22MM

## ▶ BUTTON FOR POTENTIOMETER - NON-ILLUMINATED



Technical Info (p.106)

Chrome Bezel  
Part Number

Black Bezel  
Part Number

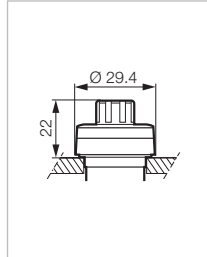

Head + mounting base for potentiometer with Plastic chrome bezel

Shaft  $\phi$  6 or 6.35 mm  
Potentiometer length 46 to 51 mm

**L21RP03**

**L22RP03**

**NOTE: POTENTIOMETER NOT INCLUDED**

L21RP03

## ▶ JOYSTICKS - NON-ILLUMINATED

Part Number



LM2F

Heads supplied with a 3 position clip  
Specific electrical blocks (p. 71)

### HEAD DOES NOT LOCK IN POSITION 0

#### 2 DIRECTIONS - 3 POSITIONS

2 maintained

A - 0 - B

**LM2F**

2 spring-return

A → 0 ← B

**LM2A**

#### 4 DIRECTIONS - 5 POSITIONS

4 maintained

A  
C - 0 - D  
B

**LM4F**

4 spring-return

A  
C → 0 ← D  
B

**LM4A**

### HEAD LOCKS IN POSITION 0

#### 2 DIRECTIONS - 3 POSITIONS

2 maintained

A - 0 - B

**LMV2F**

2 spring-return

A → 0 ← B

**LMV2A**

#### 4 DIRECTIONS - 5 POSITIONS

4 maintained

A  
C - 0 - D  
B

**LMV4F**

4 spring-return

A  
C → 0 ← D  
B

**LMV4A**

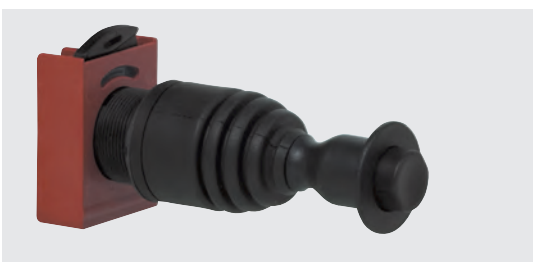

LMV4F

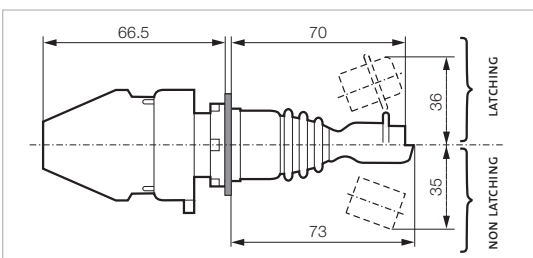

# Operator Heads: $\phi$ 22MM

## ► SPRING RETURN - ILLUMINATED



Technical Info (p. 106)

### FLUSH

Chrome Bezel  
Part Number

Black Bezel  
Part Number



L21AH20

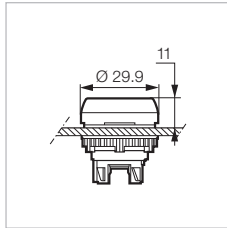

- Red
- Green
- Yellow
- White
- Blue--

L21AH10  
L21AH20  
L21AH40  
L21AH50  
L21AH60

L22AH10  
L22AH20  
L22AH40  
L22AH50  
L22AH60

**WITH TEXT OR SYMBOL** (see p. 82 to 85)  
Code to be added at the end of the part number.  
For custom text or symbol please contact us.



L21AH00

- Red
- Green
- Yellow
- White
- Blue

L21AH31□□□□  
L21AH32□□□□  
L21AH34□□□□  
L21AH35□□□□  
L21AH36□□□□

L22AH31□□□□  
L22AH32□□□□  
L22AH34□□□□  
L22AH35□□□□  
L22AH36□□□□

**WITHOUT CAP**

L21AH00

L22AH00

Pushbutton caps (see p. 84)

### FLUSH WITH SHROUD

Reinforced degree of protection: IP 67



L22AQ40

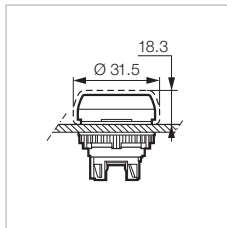

Supplied with flat shroud

**TRANSPARENT SHROUD**

Components  
Operator + Shroud

- Red
- Green
- Yellow
- White
- Blue

L22AH10 + LWA0255  
L22AH20 + LWA0255  
L22AH40 + LWA0255  
L22AH50 + LWA0255  
L22AH60 + LWA0255

L22AQ10  
L22AQ20  
L22AQ40  
L22AQ50  
L22AQ60

**WITH TEXT OR SYMBOL** (see p. 82 to 85)  
Code to be added at the end of the part number.  
For custom text or symbol please contact us.

- Red
- Green
- Yellow
- White
- Blue

L22AH31□□□□ + LWA0255  
L22AH32□□□□ + LWA0255  
L22AH34□□□□ + LWA0255  
L22AH35□□□□ + LWA0255  
L22AH36□□□□ + LWA0255

L22AQ31□□□□  
L22AQ32□□□□  
L22AQ34□□□□  
L22AQ35□□□□  
L22AQ36□□□□

# Operator Heads: $\phi$ 22MM

## ► SPRING RETURN - ILLUMINATED



Technical Info (p.106)

### SUPER FLUSH

Chrome Bezel  
Part Number

Black Bezel  
Part Number



L23AH10

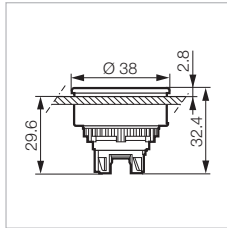

**METAL CHROME BEZEL**  
Panel cut-out  $\phi$  30 mm

**WITHOUT ENGRAVING**

- Red L23AH10
- Green L23AH20
- Yellow L23AH40
- White L23AH50
- Blue L23AH60

**WITH TEXT OR SYMBOL** (see p. 82 to 85)  
Code to be added at the end of the part number.  
For custom text or symbol please contact us.

- Red L23AH31□□□□
- Green L23AH32□□□□
- Yellow L23AH34□□□□
- White L23AH35□□□□
- Blue L23AH36□□□□

### PROJECTING



L21AK20

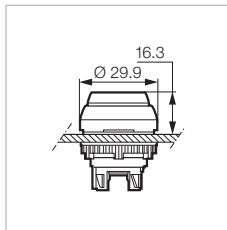

- Red L21AK10
- Green L21AK20
- Yellow L21AK40
- White L21AK50
- Blue L21AK60

- L22AK10
- L22AK20
- L22AK40
- L22AK50
- L22AK60

### PROJECTING WITH SHROUD



L22AZ10

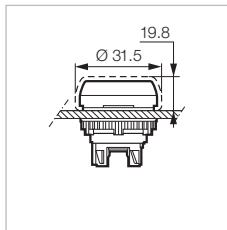

Supplied with domed shroud

**TRANSPARENT SHROUD**

- Red L22AK10 + LWA0228
- Green L22AK20 + LWA0228
- Yellow L22AK40 + LWA0228
- White L22AK50 + LWA0228
- Blue L22AK60 + LWA0228

Components  
Operator + Shroud

- L22AZ10
- L22AZ20
- L22AZ40
- L22AZ50
- L22AZ60

# Operator Heads: Ø 22MM

## ► SPRING RETURN - ILLUMINATED



Technical Info (p. 106)

### Ø 32 MUSHROOM



L21AL10

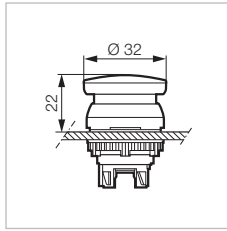

Push

- Red
- Green
- Yellow
- White

Chrome Bezel  
Part Number

Black Bezel  
Part Number

- L21AL10
- L21AL20
- L21AL40
- L21AL50

- L22AL10
- L22AL20
- L22AL40
- L22AL50

### FLUSH-FLUSH

Twin touch - degree of protection: IP66



L62QH21

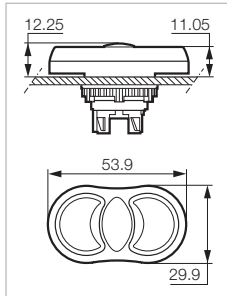

**CENTRAL PART ILLUMINATED  
WITH INTERNATIONAL SYMBOLS**

- Green
- Red

L61QH21

L62QH21

**BLANK**

- Green
- Green

L61QH22V

L62QH22V

**WITH TEXT**

- Green (START)
- Red (STOP)

L61QH21A

L62QH21A

**WITH ARROWS**

- ↑ Green (up arrow)
- ↓ Green (down arrow)

L61QH22A

L62QH22A

### FLUSH-PROJECTING

Twin touch - degree of protection: IP66



L61QK21

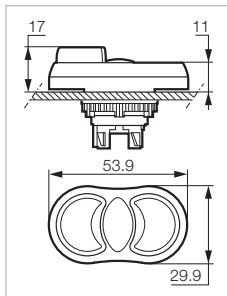

**CENTRAL PART ILLUMINATED**

- Green
- Red

L61QK21

L62QK21

**WITH INTERNATIONAL SYMBOLS**

- White
- Black

L61QK53

L62QK53

**WITH TEXT**

- Green (START)
- Red (STOP)

L61QK21A

L62QK21A

### FLUSH-PROJECTING WITH SHROUD

Twin touch - reinforced degree of protection: IP67



L62QN21

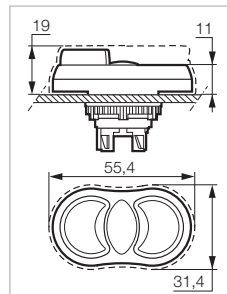

**CENTRAL PART ILLUMINATED  
WITH INTERNATIONAL SYMBOLS**

- Green
- Red

L61QN21

L62QN21

**WITH TEXT**

- Green (START)
- Red (STOP)

L61QN21A

L62QN21A

# Operator Heads: $\phi$ 22MM

## ▶ MAINTAINED - ILLUMINATED



Technical Info (p.106)

### FLUSH

Chrome Bezel  
Part Number

Black Bezel  
Part Number



L21CH20

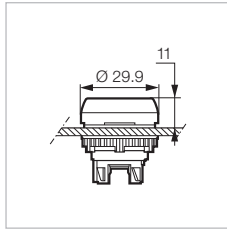

- Red
- Green
- Yellow
- White
- Blue

- L21CH10
- L21CH20
- L21CH40
- L21CH50
- L21CH60

- L22CH10
- L22CH20
- L22CH40
- L22CH50
- L22CH60

### SUPER FLUSH



L23CH10

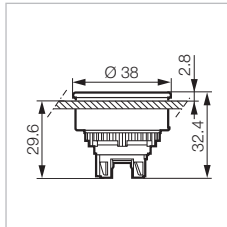

Metal chrome bezel  
Panel Cut-out  $\phi$  30 mm

- Red
- Green
- Yellow
- White
- Blue

- L23CH10
- L23CH20
- L23CH40
- L23CH50
- L23CH60

### PROJECTING



L21CK20

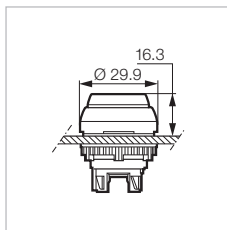

- Red
- Green
- Yellow
- White
- Blue

- L21CK10
- L21CK20
- L21CK40
- L21CK50
- L21CK60

- L22CK10
- L22CK20
- L22CK40
- L22CK50
- L22CK60



# Operator Heads: $\phi$ 22MM

► MAINTAINED - ILLUMINATED



Technical Info (p.106)

$\phi$  32 MUSHROOM

Push-turn to reset

Black Bezel  
Part Number



L22EL10

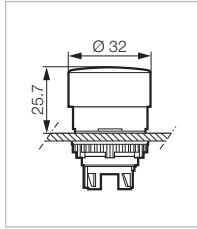

- Red
- Green
- Yellow

- L22EL10
- L22EL20
- L22EL40

$\phi$  32 MUSHROOM

Push-pull to reset



L22DL10

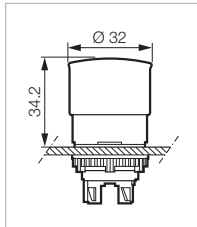

- Red

- L22DL10

$\phi$  40 MUSHROOM

Push-turn to reset



L22EM10

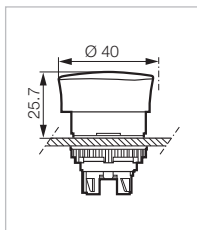

- Red
- Green
- Yellow

- L22EM10
- L22EM20
- L22EM40

$\phi$  40 MUSHROOM

Push-pull to reset



L22DM10

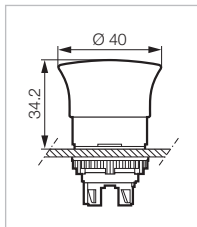

- Red
- Green
- Yellow
- White

- L22DM10
- L22DM20
- L22DM40
- L22DM50

# Operator Heads: $\varnothing$ 22MM

## EMERGENCY STOP MAINTAINED - ILLUMINATED



Technical Info (p. 106)

$\varnothing$  40 ISO 13850

Push-pull to reset

Chrome Bezel  
Part Number

Black Bezel  
Part Number



L22DN10

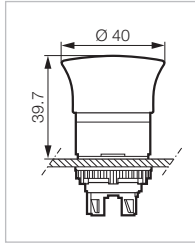

Black bezel  
Head position visible from the side with yellow collar  
Compliant with the requirements of emergency stop:  
ISO 13850

- Red

L22DN10

## SELECTOR SWITCHES - ILLUMINATED

WITH HANDLE

2 positions



L21KJ30

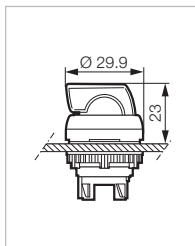

Maintained positions - 45°

- Red
- Green
- Black



L21KG10  
L21KG20  
L21KG30

L22KG10  
L22KG20  
L22KG30

Spring return- 45°

- Red
- Green
- Black



L21KH10  
L21KH20  
L21KH30

L22KH10  
L22KH20  
L22KH30

Maintained positions - 45°

- Red
- Green
- Black



L21KJ10  
L21KJ20  
L21KJ30

L22KJ10  
L22KJ20  
L22KJ30

Spring return- 45°

- Red
- Green
- Black



L21KK10  
L21KK20  
L21KK30

L22KK10  
L22KK20  
L22KK30

Maintained positions - 90°

- Red
- Green
- Black



L21KL10  
L21KL20  
L21KL30

L22KL10  
L22KL20  
L22KL30

Maintained positions - 90°

- Red
- Green
- Black



L21KM10  
L21KM20  
L21KM30

L22KM10  
L22KM20  
L22KM30

# Operator Heads: $\varnothing$ 22mm

## ▶ SELECTOR SWITCHES - ILLUMINATED



Technical Info (p.106)

### WITH LEVER HANDLE

2 positions

Chrome Bezel  
Part Number

Black Bezel  
Part Number



L21KV30

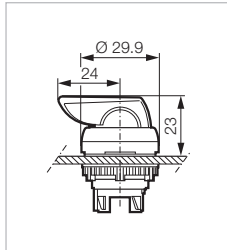

Maintained positions - 45°

● Black

L21KV30

L22KV30

Maintained positions - 45°

● Black

L21KX30

L22KX30

Spring return - 45°

● Black

L21KY30

L22KY30

### WITH HANDLE

3 positions



L21ME10

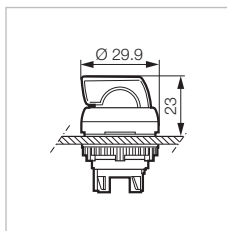

Maintained positions - 45°

● Red  
● Green  
● Black

L21ME10  
L21ME20  
L21ME30

L22ME10  
L22ME20  
L22ME30

Spring return from left to 0 - 45°

● Red  
● Green  
● Black

L21MF10  
L21MF20  
L21MF30

L22MF10  
L22MF20  
L22MF30

Spring return from right to 0 - 45°

● Red  
● Green  
● Black

L21MG10  
L21MG20  
L21MG30

L22MG10  
L22MG20  
L22MG30

Spring return to 0 - 45°

● Red  
● Green  
● Black

L21MH10  
L21MH20  
L21MH30

L22MH10  
L22MH20  
L22MH30

Maintained positions - 90°

● Red  
● Green  
● Black

L21MJ10  
L21MJ20  
L21MJ30

L22MJ10  
L22MJ20  
L22MJ30

# Operator Heads: $\varnothing$ 22MM

## ▶ SELECTOR SWITCHES - ILLUMINATED



Technical Info (p.106)

### WITH LEVER HANDLE



L21ML30

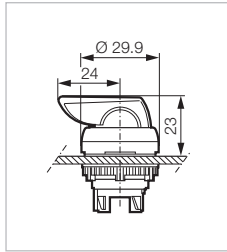

### 3 positions

Chrome Bezel  
Part Number

Black Bezel  
Part Number

Maintained positions - 45°

- Black



L21ML30

L22ML30

Spring return from left to 0 - 45°

- Black



L21MM30

L22MM30

Spring return from right to 0 - 45°

- Black



L21MN30

L22MN30

Spring return to 0 - 45°

- Black



L21MP30

L22MP30

## ▶ PILOT LIGHTS - HEAD ONLY



L20SE20

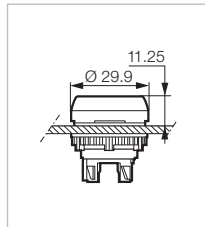

- Red
- Green
- Yellow
- White
- Blue

L20SE10  
L20SE20  
L20SE40  
L20SE50  
L20SE60

**WITH TEXT OR SYMBOL** (see p. 82 to 85)  
Code to be added at the end of the part number.  
For custom text or symbol please contact us.

- Red
- Green
- Yellow
- White
- Blue

L20SE31□□□□  
L20SE32□□□□  
L20SE34□□□□  
L20SE35□□□□  
L20SE36□□□□

# Operator Heads: $\phi$ 22MM

## ▶ ONE-PIECE PILOT LIGHTS

### ONE-PIECE WITH INTEGRATED LED

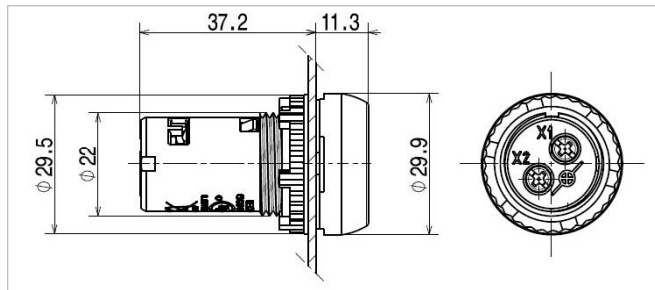

**24 Vac/Dc**

- Red
- Green
- Yellow
- White
- Blue

Part Number

- L20SC10L
- L20SC20L
- L20SC40L
- L20SC50L
- L20SC60L

With Text or Symbol  
Part Number \*\*

- L20SC31L [ ] [ ] [ ] [ ]
- L20SC32L [ ] [ ] [ ] [ ]
- L20SC34L [ ] [ ] [ ] [ ]
- L20SC35L [ ] [ ] [ ] [ ]
- L20SC36L [ ] [ ] [ ] [ ]

**130 Vac/Dc**

- Red
- Green
- Yellow
- White
- Blue

- L20SC10M
- L20SC20M
- L20SC40M
- L20SC50M
- L20SC60M

- L20SC31M [ ] [ ] [ ] [ ]
- L20SC32M [ ] [ ] [ ] [ ]
- L20SC34M [ ] [ ] [ ] [ ]
- L20SC35M [ ] [ ] [ ] [ ]
- L20SC36M [ ] [ ] [ ] [ ]

**230 Vac/Dc\***

- Red
- Green
- Yellow
- White
- Blue

- L20SC10H
- L20SC20H
- L20SC40H
- L20SC50H
- L20SC60H

- L20SC31H [ ] [ ] [ ] [ ]
- L20SC32H [ ] [ ] [ ] [ ]
- L20SC34H [ ] [ ] [ ] [ ]
- L20SC35H [ ] [ ] [ ] [ ]
- L20SC36H [ ] [ ] [ ] [ ]

\* 230V DC rating is Self-Declared.

\*\* Code to be added to end of part number.  
See p. 82 to 85 for standard text and symbol options.  
For custom text or symbol please contact us.

## ▶ SUPER FLUSH PILOT LIGHTS - HEAD ONLY

### SUPER FLUSH

Chrome Bezel  
Part Number



L23SE10

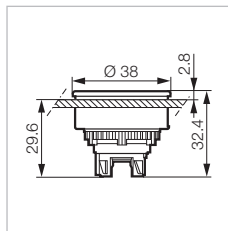

**METAL CHROME BEZEL**  
Panel cut-out  $\phi$  30 mm

- Red
- Green
- Yellow
- White
- Blue

- L23SE10
- L23SE20
- L23SE40
- L23SE50
- L23SE60

# Block holder clips for assembly as you require

1, 3 or 5-position clips

► CLIP

*"A flexible configuration for assembly in any order..."*

► 1 BLOCK



► 3 BLOCKS



► 5 BLOCKS

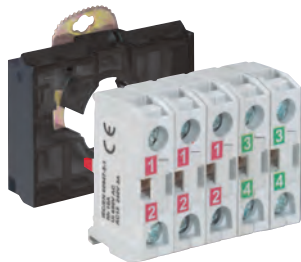

► MODULAR

Stacking without accessories



► BLOCK

*"Imaginatively designed to be safe, robust and durable"*

► MATERIAL

- IP20 as "finger safe"
- Electrical insulation
- Corrosion-resistant



► ENVIRONMENT

- Respect for the environment, RoHS compliant



- Snap fit, tools not required to attach contact blocks
- Cost effective solution: 1 position clip
- Blocks can be stacked on 2 levels, up to 3 blocks wide (blocks cannot be stacked using 5 row clip)
- Blocks can be assembled in any order (except pilot light)
- Optimized dimensions: reduced depth of blocks

- LED blocks: combine long life and economy
- Corrosion resistant to some chemicals and sea air, etc
- Conform to standard EN IEC 60947-5-1
- Conform to RoHS European directive concerning restriction of hazardous substances

## Separate units: Blocks sub-assemblies

### ▶ CONTACT BLOCKS - FOR NON-ILLUMINATED HEADS

 Technical Info (p.106)

#### SCREW TERMINALS

#### 1 position clip

Part Number



331E10

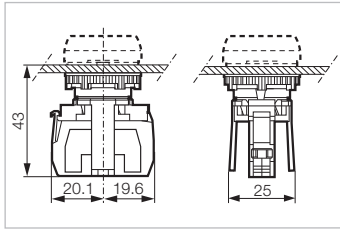

NO



331E10

NC



331E01

#### SCREW TERMINALS

#### 3 position clip



333E21

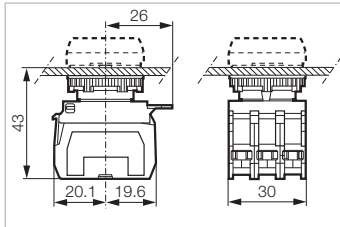

NO



333E10

NC



333E01

2 NO



333E20

2 NC



333E02

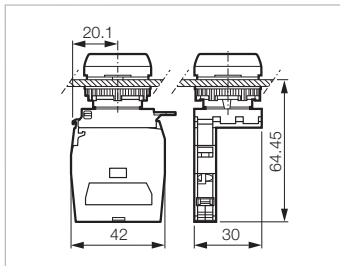

NO/NC

NO + NC



333E11

3 NO



333E30

3 NC



333E03

2 NO + NC



333E21

NO + 2 NC



333E12

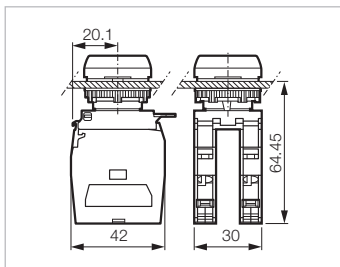

2 NO/NC

NO/NC



334E11

2 NO/NC



334E22



## Separate units: Blocks sub-assemblies

### ▶ CONTACT BLOCKS - FOR NON-ILLUMINATED HEADS

 Technical Info (p.106)

#### PLUG-IN TERMINALS

#### 1 position clip

Part Number

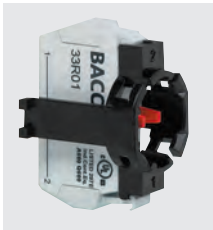

331ER01

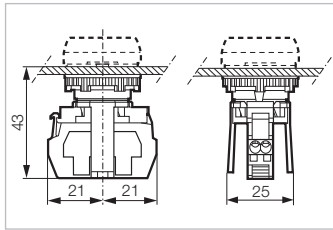

NO



331ER10

NC



331ER01

#### PLUG-IN TERMINALS

#### 3 position clip



333ER11

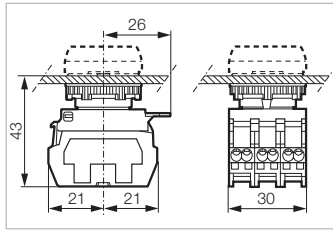

NO



333ER10

NC



333ER01

2 NO



333ER20

2 NC



333ER02

NO + NC



333ER11

3 NO



333ER30

3 NC



333ER03

## Separate units: Blocks sub-assemblies

### ▶ CONTACT BLOCKS - FOR NON-ILLUMINATED HEADS

 Technical Info (p. 106)

#### FASTON TERMINALS

#### 1 position clip

Part Number



331ED10

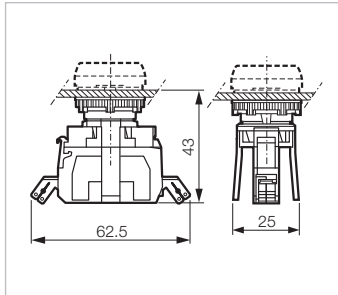

NO



331ED10

NC



331ED01

#### FASTON TERMINALS

#### 3 position clip



333ED20

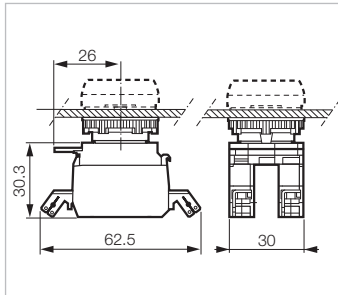

NO



333ED10

NC



333ED01

2 NO



333ED20

2 NC



333ED02

NO + NC



333ED11

3 NO



333ED30

3 NC







333ED03

## Separate units: Blocks sub-assemblies

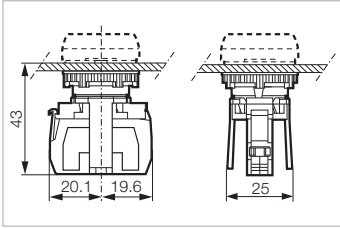
### ▶ CONTACT BLOCKS - FOR ILLUMINATED HEADS

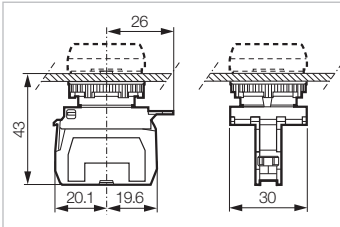
 Technical Info (p.106)

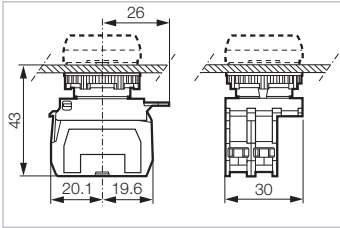
SCREW TERMINALS	LED block	1 POSITION CLIP Part Number	3 POSITION CLIP Part Number
 <p>331EAGL</p>	 <p>LED X1 ⊗ X2</p> <p>12/24 Vac/Vdc</p> <ul style="list-style-type: none"> <li>○ White</li> <li>● Red</li> <li>● Green</li> <li>● Blue</li> <li>● Yellow</li> </ul>	<p>331EAWL</p> <p>331EARL</p> <p>331EAGL</p> <p>331EABL</p> <p>331EAYL</p>	<p>333EAWL</p> <p>333EARL</p> <p>333EAGL</p> <p>333EABL</p> <p>333EAYL</p>
 <p>333EAGL</p>	 <p>130 Vac</p> <ul style="list-style-type: none"> <li>○ White</li> <li>● Red</li> <li>● Green</li> <li>● Blue</li> <li>● Yellow</li> </ul>	<p>331EAWM</p> <p>331EARM</p> <p>331EAGM</p> <p>331EABM</p> <p>331EAYM</p>	<p>333EAWM</p> <p>333EARM</p> <p>333EAGM</p> <p>333EABM</p> <p>333EAYM</p>
<p>SCREW TERMINALS</p>	<p>3 position clip: NO + LED block</p>		
 <p>333EAWM10</p>	 <p>NO      LED 3 — 4      X1 ⊗ X2</p> <p>12/24 Vac/Vdc</p> <ul style="list-style-type: none"> <li>○ White</li> <li>● Red</li> <li>● Green</li> <li>● Blue</li> <li>● Yellow</li> </ul>		<p>333EAWL10</p> <p>333EARL10</p> <p>333EAGL10</p> <p>333EABL10</p> <p>333EAYL10</p>
	<p>130 Vac</p> <ul style="list-style-type: none"> <li>○ White</li> <li>● Red</li> <li>● Green</li> <li>● Blue</li> <li>● Yellow</li> </ul>		<p>333EAWM10</p> <p>333EARM10</p> <p>333EAGM10</p> <p>333EABM10</p> <p>333EAYM10</p>
	<p>230 Vac</p> <ul style="list-style-type: none"> <li>○ White</li> <li>● Red</li> <li>● Green</li> <li>● Blue</li> <li>● Yellow</li> </ul>		<p>333EAWH10</p> <p>333EARH10</p> <p>333EAGH10</p> <p>333EABH10</p> <p>333EAYH10</p>

# Separate units: Blocks sub-assemblies

## ▶ CONTACT BLOCKS - FOR ILLUMINATED HEADS

 Technical Info (p.106)

### SCREW TERMINALS

#### 3 position clip: LED block + NC

Part Number



333EAWL01

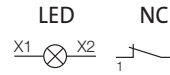
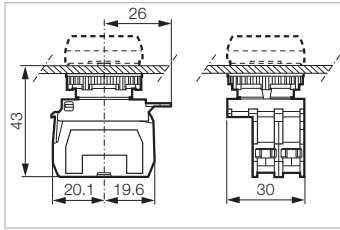

#### 12/24 Vac/Vdc

- White
- Red
- Green
- Blue
- Yellow

- 333EAWL01
- 333EARL01
- 333EAGL01
- 333EABL01
- 333EAYL01

#### 130 Vac

- White
- Red
- Green
- Blue
- Yellow

- 333EAWM01
- 333EARM01
- 333EAGM01
- 333EABM01
- 333EAYM01

#### 230 Vac

- White
- Red
- Green
- Blue
- Yellow

- 333EAWH01
- 333EARH01
- 333EAGH01
- 333EABH01
- 333EAYH01

### SCREW TERMINALS

#### 3 position clip: NO + LED block + NO



333EARL20

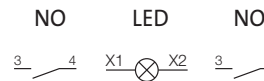
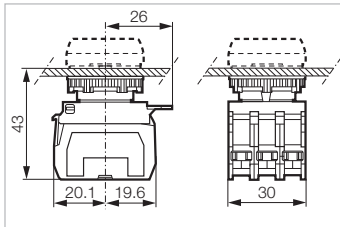

#### 12/24 Vac/dc

- White
- Red
- Green
- Blue
- Yellow

- 333EAWL20
- 333EARL20
- 333EAGL20
- 333EABL20
- 333EAYL20

#### 130 Vac

- White
- Red
- Green
- Blue
- Yellow

- 333EAWM20
- 333EARM20
- 333EAGM20
- 333EABM20
- 333EAYM20

#### 230 Vac

- White
- Red
- Green
- Blue
- Yellow

- 333EAWH20
- 333EARH20
- 333EAGH20
- 333EABH20
- 333EAYH20

## Separate units: Blocks sub-assemblies

### ▶ CONTACT BLOCKS - FOR ILLUMINATED HEADS



#### SCREW TERMINALS

3 position clip: NO + LED block + NC

Part Number



333EARL11

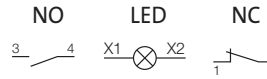
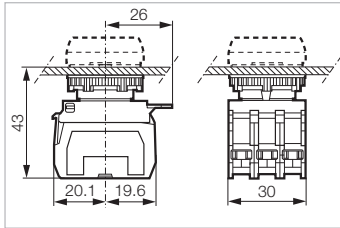

12/24 Vac/Vdc

- White
- Red
- Green
- Blue
- Yellow

- 333EAWL11
- 333EARL11
- 333EAGL11
- 333EABL11
- 333EAYL11

130 Vac

- White
- Red
- Green
- Blue
- Yellow

- 333EAWM11
- 333EARM11
- 333EAGM11
- 333EABM11
- 333EAYM11

230 Vac

- White
- Red
- Green
- Blue
- Yellow

- 333EAWH11
- 333EARH11
- 333EAGH11
- 333EABH11
- 333EAYH11

#### SCREW TERMINALS

3 position clip: NO/NC + LED block + NO/NC



334EARL22

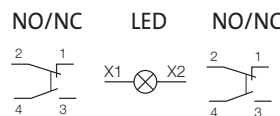

12/24 Vac/Vdc

- White
- Red
- Green
- Blue
- Yellow

- 334EAWL22
- 334EARL22
- 334EAGL22
- 334EABL22
- 334EAYL22

130 Vac

- White
- Red
- Green
- Blue
- Yellow

- 334EAWM22
- 334EARM22
- 334EAGM22
- 334EABM22
- 334EAYM22

230 Vac

- White
- Red
- Green
- Blue
- Yellow



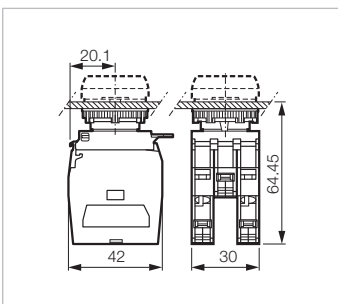







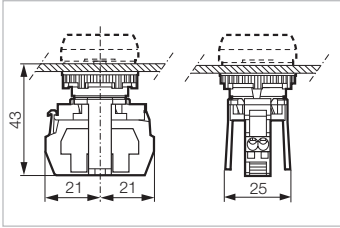

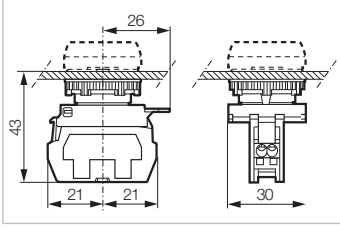
- 334EAWH22
- 334EARH22
- 334EAGH22
- 334EABH22
- 334EAYH22

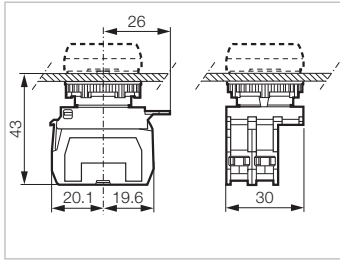

## Separate units: Blocks sub-assemblies

### ▶ CONTACT BLOCKS - FOR ILLUMINATED HEADS

 Technical Info (p.106)

PLUG-IN TERMINALS	LED block	1 POSITION CLIP Part Number	3 POSITION CLIP Part Number
 <p>331ERAGH</p>		<p>LED</p> 	
 <p>333ERAGH</p>			
 <p>333ERAGH</p>			
<p>PLUG-IN TERMINALS</p>  <p>333ERAGL10</p>		<p>NO</p>  <p>LED</p> 	
 <p>333ERAGL10</p>			
 <p>333ERAGL10</p>			

# Separate units: Blocks sub-assemblies

## ▶ CONTACT BLOCKS - FOR ILLUMINATED HEADS

 Technical Info (p.106)

### PLUG-IN TERMINALS

3 position clip: LED block + NC

Part Number



333ERAGH01

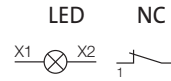
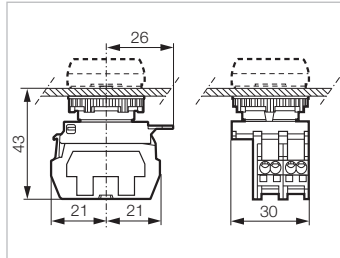

#### 12/24 Vac/Vdc

- White
- Red
- Green
- Blue
- Yellow

- 333ERAWL01
- 333ERARL01
- 333ERAGL01
- 333ERABL01
- 333ERAYL01

#### 130 Vac

- White
- Red
- Green
- Blue
- Yellow

- 333ERAWM01
- 333ERARM01
- 333ERAGM01
- 333ERABM01
- 333ERAYM01

#### 230 Vac

- White
- Red
- Green
- Blue
- Yellow

- 333ERAWH01
- 333ERARH01
- 333ERAGH01
- 333ERABH01
- 333ERAYH01

### PLUG-IN TERMINALS

3 position clip: NO + LED block + NC



333ERAGH11

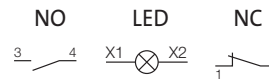
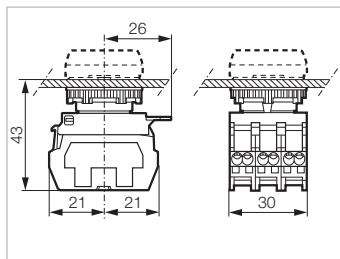

#### 12/24 Vac/Vdc

- White
- Red
- Green
- Blue
- Yellow

- 333ERAWL11
- 333ERARL11
- 333ERAGL11
- 333ERABL11
- 333ERAYL11

#### 130 Vac

- White
- Red
- Green
- Blue
- Yellow

- 333ERAWM11
- 333ERARM11
- 333ERAGM11
- 333ERABM11
- 333ERAYM11

#### 230 Vac

- White
- Red
- Green
- Blue
- Yellow



- 333ERAWH11
- 333ERARH11
- 333ERAGH11
- 333ERABH11
- 333ERAYH11



## Separate units: Blocks sub-assemblies

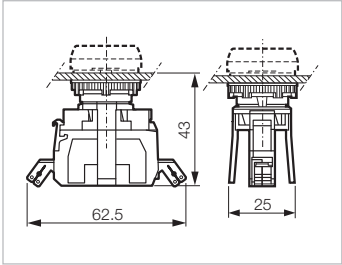

### ▶ CONTACT BLOCKS - FOR ILLUMINATED HEADS

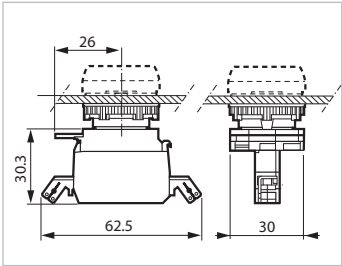
 Technical Info (p.106)

FASTON TERMINALS	LED block	1 POSITION CLIP Part Number	3 POSITION CLIP Part Number
 331EDARL		LED 	
 333EDARL			

### FASTON TERMINALS

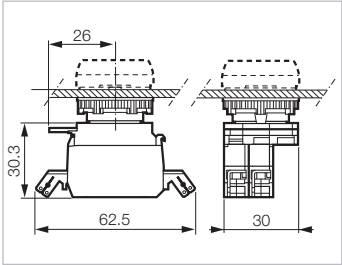
### 3 position clip: NO + LED block

 333EDARL10		NO    LED  	

# Separate units: Blocks sub-assemblies

## ▶ CONTACT BLOCKS - FOR ILLUMINATED HEADS

 Technical Info (p.106)

FASTON TERMINALS

3 position clip: LED block + NC

Part Number



333EDARM01

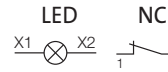
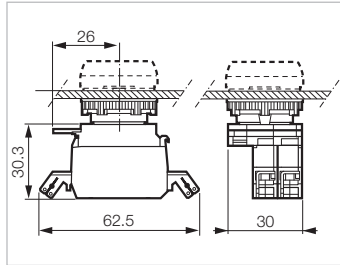

12/24 Vac/Vdc

- White
- Red
- Green
- Blue
- Yellow

- 333EDAWL01
- 333EDARL01
- 333EDAGL01
- 333EDABL01
- 333EDAYL01

130 Vac

- White
- Red
- Green
- Blue
- Yellow

- 333EDAWM01
- 333EDARM01
- 333EDAGM01
- 333EDABM01
- 333EDAYM01

230 Vac

- White
- Red
- Green
- Blue
- Yellow

- 333EDAWH01
- 333EDARH01
- 333EDAGH01
- 333EDABH01
- 333EDAYH01

FASTON TERMINALS

3 position clip: NO + LED block + NC



333EDARL11

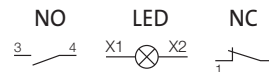
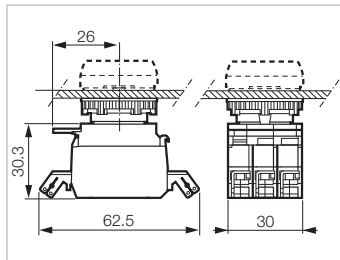

12/24 Vac/Vdc

- White
- Red
- Green
- Blue
- Yellow

- 333EDAWL11
- 333EDARL11
- 333EDAGL11
- 333EDABL11
- 333EDAYL11

130 Vac

- White
- Red
- Green
- Blue
- Yellow

- 333EDAWM11
- 333EDARM11
- 333EDAGM11
- 333EDABM11
- 333EDAYM11

230 Vac

- White
- Red
- Green
- Blue
- Yellow

- 333EDAWH11
- 333EDARH11
- 333EDAGH11
- 333EDABH11
- 333EDAYH11

# Separate units: Clips

► CLIPS

 Technical Info (p.106)

CLIPS Part Number



331E

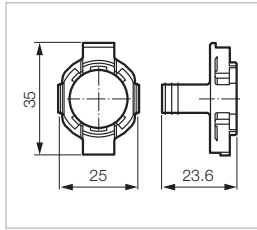

To be combined with blocks (p. 69 to 75)

1 position

**331E**



333E

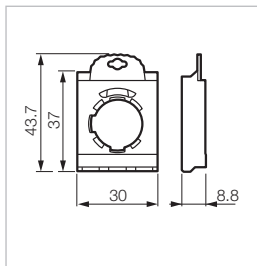

3 positions

**333E**

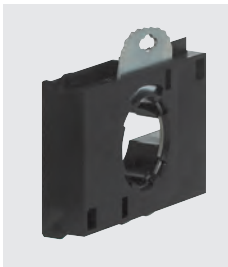

335E

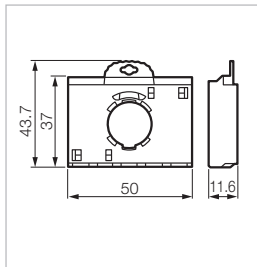

5 positions (only for  $\varnothing$  22 heads)

**335E**

CLIPS - JOYSTICK ONLY



LME3

3 positions (only for Joystick operators)

**LME3**



LME5

5 positions (only for Joystick operators)

**LME5**

# Separate units: Blocks

## ▶ CONTACT BLOCKS

 Technical Info (p.106)

### SCREW TERMINALS

Part Number



33E10

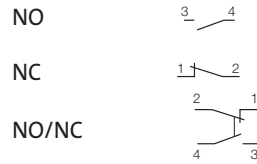
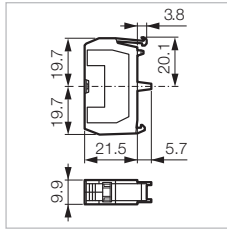

33E11

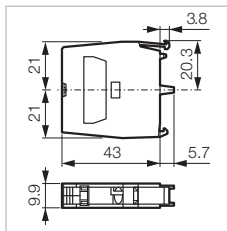

**Gold plated contacts**  
for low current applications



### FASTON TERMINALS



33D01

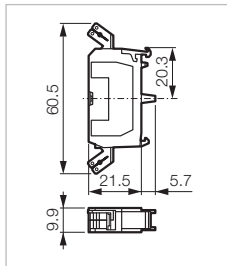

### PLUG-IN TERMINALS



33R01

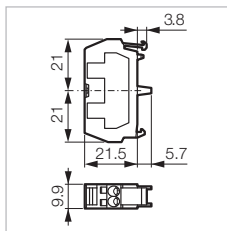

# Separate units: Blocks

## ▶ CONTACT BLOCKS

 Technical Info (p.106)

### FOR PCB (PIN-STYLE TERMINALS)

Part Number



33P10

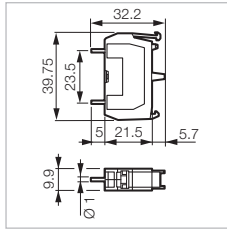

NO 

**33P10**

NC 

**33P01**

**Gold plated contacts**  
for low current applications

NO 

**33P10Y7**

NC 

**33P01Y7**

### FOR CONTROL STATIONS (SCREW TERMINALS)



33S01

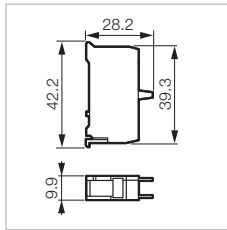

For empty LBX control stations (p. 94 to 101)  
Base mounted

NO 

**33S10**

NC 

**33S01**

# Separate units: Blocks

▶ LED BLOCKS

 Technical Info (p.106)

SCREW TERMINALS

Part Number



33EARL

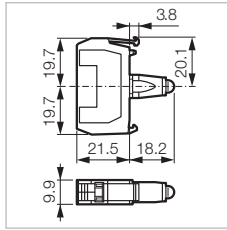

**12/24 Vac/Vdc**

- White
- Red
- Green
- Blue
- Yellow

- 33EAWL
- 33EARL
- 33EAGL
- 33EABL
- 33EAYL

**48 Vac/Vdc**

- White
- Red
- Green
- Blue
- Yellow

- 33EAWL4
- 33EARL4
- 33EAGL4
- 33EABL4
- 33EAYL4

**130 Vac**

- White
- Red
- Green
- Blue
- Yellow

- 33EAWM
- 33EARM
- 33EAGM
- 33EABM
- 33EAYM

**230 Vac**

- White
- Red
- Green
- Blue
- Yellow

- 33EAWH
- 33EARH
- 33EAGH
- 33EABH
- 33EAYH

**110 Vdc\***

- White

- 33EAWDM\*

\* NOT UL CERTIFIED

# Separate units: Blocks

## ▶ LED BLOCKS

 Technical Info (p.106)

### PLUG-IN TERMINALS

Part Number



33RAGH

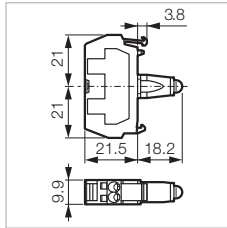

#### 12/24 Vac/Vdc

- White
- Red
- Green
- Blue
- Yellow

- 33RAWL
- 33RARL
- 33RAGL
- 33RABL
- 33RAYL

#### 130 Vac

- White
- Red
- Green
- Blue
- Yellow

- 33RAWM
- 33RARM
- 33RAGM
- 33RABM
- 33RAYM

#### 230 Vac

- White
- Red
- Green
- Blue
- Yellow

- 33RAWH
- 33RARH
- 33RAGH
- 33RABH
- 33RAYH

### FASTON TERMINALS



33DARL

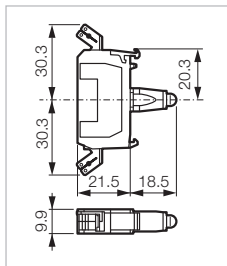

#### 12/24 Vac/Vdc

- White
- Red
- Green
- Blue
- Yellow

- 33DAWL
- 33DARL
- 33DAGL
- 33DABL
- 33DAYL

#### 130 Vac

- White
- Red
- Green
- Blue
- Yellow

- 33DAWM
- 33DARM
- 33DAGM
- 33DABM
- 33DAYM

#### 230 Vac

- White
- Red
- Green
- Blue
- Yellow

- 33DAWH
- 33DARH
- 33DAGH
- 33DABH
- 33DAYH



# Separate units: Blocks

## ▶ LED BLOCKS

 Technical Info (p. 106)

### FOR PCB (PIN STYLE)

Part Number



33PAWL

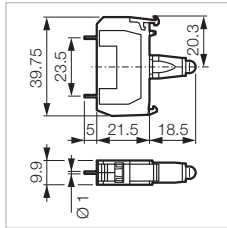

12/24 Vac/Vdc

- White
- Red
- Green
- Blue
- Yellow

- 33PAWL
- 33PARL
- 33PAGL
- 33PABL
- 33PAYL

### FOR CONTROL STATIONS (SCREW TERMINALS)



33SAGH

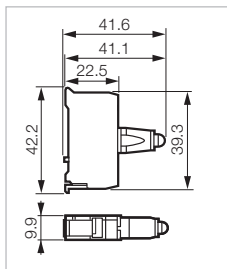

For empty LBX control stations (p. 98 to 99)  
Base mounted



12/24 Vac/Vdc

- White
- Red
- Green
- Blue
- Yellow

- 33SAWL
- 33SARL
- 33SAGL
- 33SABL
- 33SAYL

130 Vac

- White
- Red
- Green
- Blue
- Yellow

- 33SAWM
- 33SARM
- 33SAGM
- 33SABM
- 33SAYM

230 Vac

- White
- Red
- Green
- Blue
- Yellow

- 33SAWH
- 33SARH
- 33SAGH
- 33SABH
- 33SAYH

# Separate units: Blocks

## ► SPECIFIC BLOCKS

 Technical Info (p.106)

### FOR JOYSTICKS (SCREW TERMINALS)

Part Number



LM11

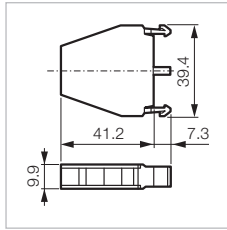

Joysticks (p. 47)

NO/NC



LM11

### LAMP-TEST BLOCKS (SCREW TERMINALS)



33ET

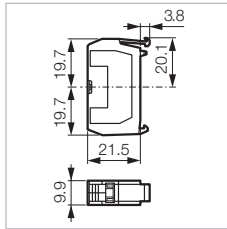

For 24 and 48 V

1 diode

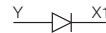

33ET

2 diodes

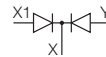

33ETT

### TRANSFORMER BLOCKS (SCREW TERMINALS)



33EHC

230/24 V  
400/24V

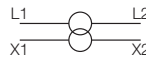

33EHC  
33ELC

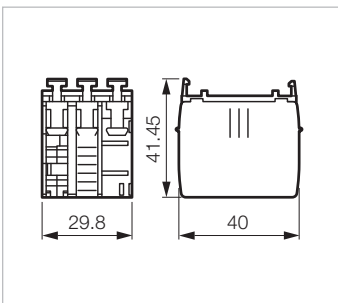

# Separate units: Blocks

## ► SPECIFIC BLOCKS

 Technical Info (p. 106)

### FILTER BLOCKS (SCREW TERMINALS)

Part Number



33EFH

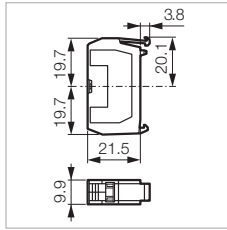

Prevents from voltage peaks for LED block  
To be wired in parallel of the LED block

130 Vac  
230 Vac



**33EFM**  
**33EFH**

### FILTER BLOCKS (PLUG-IN TERMINALS)



33RFH

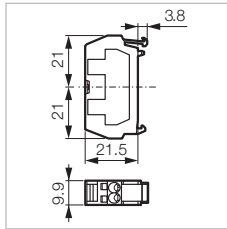

Prevents from voltage peaks for LED block  
To be wired in parallel with the LED block

130 Vac  
230 Vac



**33RFM**  
**33RFH**

### JUNCTION BLOCK (SCREW TERMINALS)



33EY

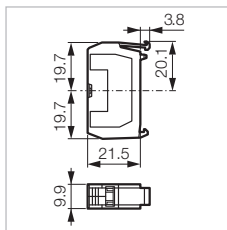

2 interconnected  
terminals



**33EY**

### EMPTY BLOCK



33EX

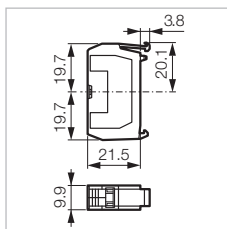

For empty positions on 3 or 5 position clip

**33EX**

## Accessories: $\phi$ 22MM

### ► COMPLETE LEGEND PLATES (FRAME + INSERT)

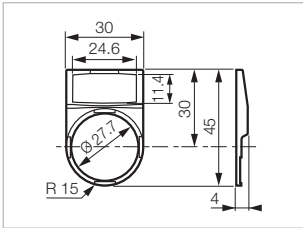
		Standard model - 30 x 45 mm	Part Number
 <p>LWP31</p>		<p>Round shape Black frame and legend plate unassembled 2 lines maximum, 13 characters per line</p> <p><b>WITHOUT ENGRAVING</b></p> <ul style="list-style-type: none"> <li>● Red</li> <li>● Black</li> <li>○ White</li> <li>● Alu</li> </ul>	<p>LWP31 LWP33 LWP35 LWP39</p>
		<p><b>WITH TEXT OR SYMBOL</b> (see p. 82 to 85) Code to be added at the end of the part number. For custom text or symbol please contact us.</p> <ul style="list-style-type: none"> <li>● Red - white engraving</li> <li>● Black - white engraving</li> <li>○ White - black engraving</li> <li>● Alu - black engraving</li> </ul> <p><b>PROTECTIVE MASK FOR LEGEND PLATE (PAPER OR OTHER...)</b></p> <ul style="list-style-type: none"> <li>○ Transparent</li> </ul>	<p>LWP31□□□□ LWP33□□□□ LWP35□□□□ LWP39□□□□</p> <p>LWP37</p>

### Large model - 40 x 45 mm

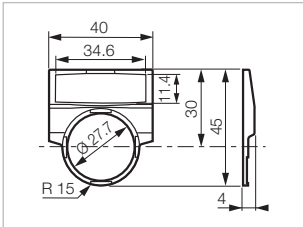
 <p>LWG33</p>		<p>Round shape Black frame and legend plate unassembled 2 lines maximum, 18 characters per line</p> <p><b>WITHOUT ENGRAVING</b></p> <ul style="list-style-type: none"> <li>● Red</li> <li>● Black</li> <li>○ White</li> <li>● ---</li> </ul>	<p>LWG31 LWG33 LWG35 LWG39</p>
		<p><b>WITH TEXT OR SYMBOL</b> (see p. 82 to 85) Code to be added at the end of the part number. For custom text or symbol please contact us.</p> <ul style="list-style-type: none"> <li>● Red - white engraving</li> <li>● Black - white engraving</li> <li>○ White - black engraving</li> <li>● Alu - black engraving</li> </ul> <p><b>PROTECTIVE MASK FOR LEGEND PLATE (PAPER OR OTHER...)</b></p> <ul style="list-style-type: none"> <li>○ Transparent</li> </ul>	<p>LWG31□□□□ LWG33□□□□ LWG35□□□□ LWG39□□□□</p> <p>LWG37</p>

## Accessories: $\phi$ 22mm

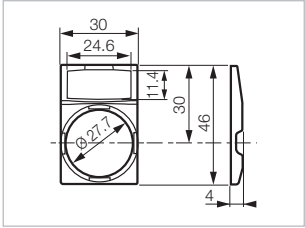

### ► COMPLETE LEGEND PLATES (FRAME + INSERT)

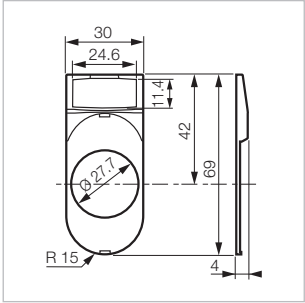
		Standard model - 30 x 46 mm	Part Number
 <p>LWP45</p>		<p>Square shape Black frame and legend plate unassembled 2 lines maximum, 13 characters per line</p> <p><b>WITHOUT ENGRAVING</b></p> <ul style="list-style-type: none"> <li><input type="radio"/> Red</li> <li><input type="radio"/> Black</li> <li><input type="radio"/> White</li> <li><input type="radio"/> Alu</li> </ul>	<p>LWP41 LWP43 LWP45 LWP49</p>
		<p><b>WITH TEXT OR SYMBOL</b> (see p. 82 to 85) Code to be added at the end of the part number. For custom text or symbol please contact us.</p> <ul style="list-style-type: none"> <li><input type="radio"/> Red - white engraving</li> <li><input type="radio"/> Black - white engraving</li> <li><input type="radio"/> White - black engraving</li> <li><input type="radio"/> Alu - black engraving</li> </ul>	<p>LWP41□□□□ LWP43□□□□ LWP45□□□□ LWP49□□□□</p>
		<p><b>PROTECTIVE MASK FOR LEGEND PLATE (PAPER OR OTHER...)</b></p> <ul style="list-style-type: none"> <li><input type="radio"/> Transparent</li> </ul>	<p>LWP47</p>

		Standard model - 30 x 69 mm	
 <p>LWP29381</p>		<p>Round shape for Twin and Triple Touch operators Black frame and legend plate unassembled 2 lines maximum, 13 characters per line</p> <p><b>WITHOUT ENGRAVING</b></p> <ul style="list-style-type: none"> <li><input type="radio"/> Red</li> <li><input type="radio"/> Black</li> <li><input type="radio"/> White</li> <li><input type="radio"/> Alu</li> </ul>	<p>LWP21 LWP23 LWP25 LWP29</p>
		<p><b>WITH TEXT OR SYMBOL</b> (see p. 82 to 85) Code to be added at the end of the part number. For custom text or symbol please contact us.</p> <ul style="list-style-type: none"> <li><input type="radio"/> Red - white engraving</li> <li><input type="radio"/> Black - white engraving</li> <li><input type="radio"/> White - black engraving</li> <li><input type="radio"/> Alu - black engraving</li> </ul>	<p>LWP21□□□□ LWP23□□□□ LWP25□□□□ LWP29□□□□</p>
		<p><b>PROTECTIVE MASK FOR LEGEND PLATE (PAPER OR OTHER...)</b></p> <ul style="list-style-type: none"> <li><input type="radio"/> Transparent</li> </ul>	<p>LWP27</p>

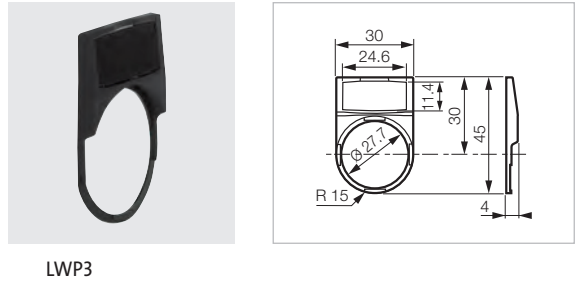
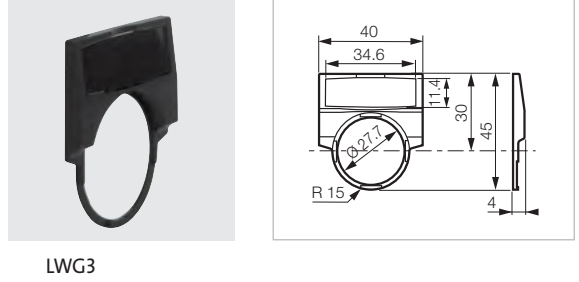

## Accessories: $\phi$ 22MM

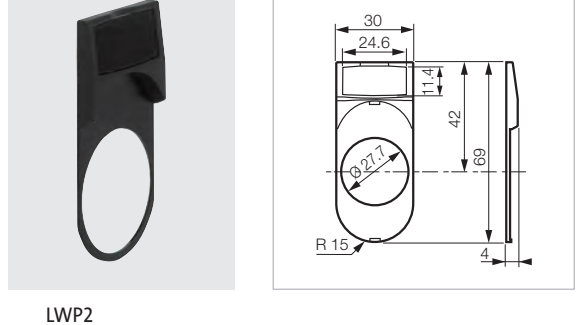

### ► LEGEND PLATES - FRAMES ONLY

ROUND	Standard model	Part Number
 <p data-bbox="176 672 231 700">LWP3</p>	<p data-bbox="752 452 1239 480">For use with standard model legend plate inserts</p> <ul data-bbox="752 508 833 536" style="list-style-type: none"> <li>● Black</li> </ul>	<p data-bbox="1386 508 1449 536"><b>LWP3</b></p>
 <p data-bbox="176 1060 231 1088">LWG3</p>	<p data-bbox="752 743 875 771"><b>Large model</b></p> <p data-bbox="752 836 1201 864">For use with large model legend plate inserts</p> <ul data-bbox="752 892 833 920" style="list-style-type: none"> <li>● Black</li> </ul>	<p data-bbox="1386 892 1449 920"><b>LWG3</b></p>
 <p data-bbox="176 1448 231 1476">LWP4</p>	<p data-bbox="752 1131 908 1159"><b>Standard model</b></p> <p data-bbox="752 1224 1239 1252">For use with standard model legend plate inserts</p> <ul data-bbox="752 1280 833 1308" style="list-style-type: none"> <li>● Black</li> </ul>	<p data-bbox="1386 1280 1449 1308"><b>LWP4</b></p>
 <p data-bbox="176 1880 231 1908">LWP2</p>	<p data-bbox="752 1519 908 1548"><b>Standard model</b></p> <p data-bbox="752 1612 1239 1640">For use with standard model legend plate inserts</p> <ul data-bbox="752 1668 833 1696" style="list-style-type: none"> <li>● Black</li> </ul>	<p data-bbox="1386 1668 1449 1696"><b>LWP2</b></p>

## Accessories: $\phi$ 22MM

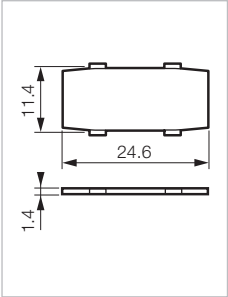
### ► LEGEND PLATES - INSERTS ONLY

TO BE ENGRAVED	Standard model	Part Number
 <p>LIA5</p>  <p>LIA1</p>	 <p>2 lines maximum 13 characters per line For use with standard model legend plate frames</p> <p><b>WITHOUT ENGRAVING</b></p> <ul style="list-style-type: none"> <li><input checked="" type="radio"/> Red</li> <li><input checked="" type="radio"/> Black</li> <li><input type="radio"/> White</li> <li><input type="radio"/> Alu</li> </ul> <p><b>WITH TEXT OR SYMBOL</b> (see p. 82 to 85) Code to be added at the end of the part number. For custom text or symbol please contact us.</p> <ul style="list-style-type: none"> <li><input checked="" type="radio"/> Red - white engraving</li> <li><input checked="" type="radio"/> Black - white engraving</li> <li><input type="radio"/> White - black engraving</li> <li><input type="radio"/> Alu - black engraving</li> </ul> <p><b>PROTECTIVE MASK FOR LEGEND PLATE (PAPER OR OTHER...)</b></p> <ul style="list-style-type: none"> <li><input type="radio"/> Transparent</li> </ul>	<p>LIA1 LIA3 LIA5 LIA9</p> <p>LIA1□□□ LIA3□□□ LIA5□□□ LIA9□□□</p> <p>LIA7</p>

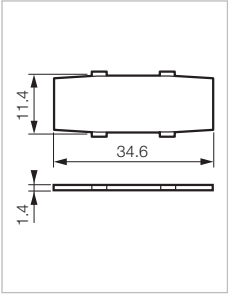
TO BE ENGRAVED	Large model	Part Number
 <p>LIB9</p>  <p>LIB3</p>	 <p>2 lines maximum 18 characters per line For use with large model legend plate frame</p> <p><b>Without engraving</b></p> <ul style="list-style-type: none"> <li><input type="radio"/> White</li> <li><input checked="" type="radio"/> Red</li> <li><input type="radio"/> Alu</li> <li><input checked="" type="radio"/> Black</li> </ul> <p><b>WITH TEXT OR SYMBOL</b> (see p. 82 to 85) Code to be added at the end of the part number. For custom text or symbol please contact us.</p> <ul style="list-style-type: none"> <li><input type="radio"/> White - black engraving</li> <li><input checked="" type="radio"/> Red - white engraving</li> <li><input type="radio"/> Alu - black engraving</li> <li><input checked="" type="radio"/> Black - white engraving</li> </ul> <p><b>Protective mask for legend plate (paper or other...)</b></p> <ul style="list-style-type: none"> <li><input type="radio"/> Transparent</li> </ul>	<p>LIB5 LIB1 LIB9 LIB3</p> <p>LIB5□□□ LIB1□□□ LIB9□□□ LIB3□□□</p> <p>LIB7</p>

## Accessories: $\phi$ 22MM

### ▶ LEGEND PLATES - EMERGENCY STOP

#### PLASTIC LEGEND PLATES (27.4mm diameter hole)

Part Number



LWE60300

Plastic - Yellow with black engraving

**60mm diameter**

Blank	LWE60
EMERGENCY STOP	LWE60300
EMO	LWE60900
ARRET D'URGENCE	LWE60100
NOT AUS	LWE60200

**70mm diameter**

Blank	LWE70
EMERGENCY STOP	LWE70300
EMO	LWE70900

**80mm diameter**

Blank	LWE80
EMERGENCY STOP	LWE80300
EMO	LWE80900

**NOTES:**

- 1) Custom diameters and engravings available please contact us for details.
- 2) Contact us for use with guards on page 88.

#### METAL LEGEND PLATES (22.4mm diameter hole)



LWE16300

Metal - Yellow with black lettering

**60mm diameter** (With ISO 13850 symbol and text)

Blank	LWE16
EMERGENCY STOP + 	LWE16300
ARRET D'URGENCE + 	LWE16100
NOT AUS + 	LWE16232

**80mm diameter** (With ISO 13850 symbol and text)

EMERGENCY STOP + 	LWE00300
ARRET D'URGENCE + 	LWE00100
NOT AUS + 	LWE00232



LWE16352

**60mm diameter** (Without symbol, text only)

EMERGENCY STOP	LWE16352
ARRET D'URGENCE	LWE16152
NOT AUS	LWE16200

**80mm diameter** (Without symbol, text only)

EMERGENCY STOP	LWE00352
ARRET D'URGENCE	LWE00152
NOT AUS	LWE00200



## Accessories: $\phi$ 22MM

### ► LEGEND PLATES FOR LBX ENCLOSURES

#### INDIVIDUAL LEGEND PLATES (27.4mm diameter hole)

Part Number

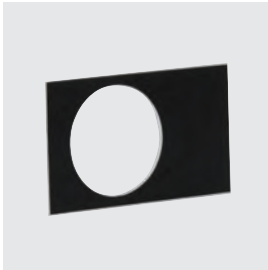

LWB13

Plastic - Rectangular shape

#### WITHOUT ENGRAVING

- Red
- Black
- Yellow
- White
- Blue
- Alu

- LWB11
- LWB13
- LWB14
- LWB15
- LWB16
- LWB19

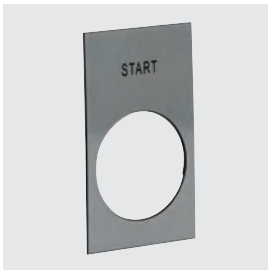

LWB19H301

#### WITH TEXT (see p. 82 to 85) FOR HORIZONTAL MOUNTING

Code to be added at the end of the part number.  
For custom text or symbol please contact us.

- Red - white engraving
- Black - white engraving
- Yellow - black engraving
- White - black engraving
- Blue - white engraving
- Alu - black engraving

- LWBH11□□□
- LWBH13□□□
- LWBH14□□□
- LWBH15□□□
- LWBH16□□□
- LWBH19□□□

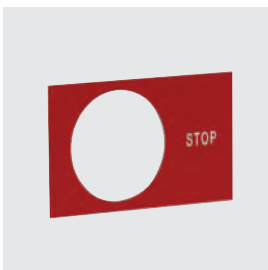

LWB11V302

#### WITH TEXT (see p. 82 to 85) FOR VERTICAL MOUNTING

Code to be added at the end of the part number.  
For custom text or symbol please contact us.

- Red - white engraving
- Black - white engraving
- Yellow - black engraving
- White - black engraving
- Blue - white engraving
- Alu - black engraving

- LWBV11□□□
- LWBV13□□□
- LWBV14□□□
- LWBV15□□□
- LWBV16□□□
- LWBV19□□□

#### MULTI HOLE LEGEND PLATES

SINGLE PIECE MULTI-HOLE  
LEGEND PLATES ARE AVAILABLE

CONTACT US FOR DETAILS.

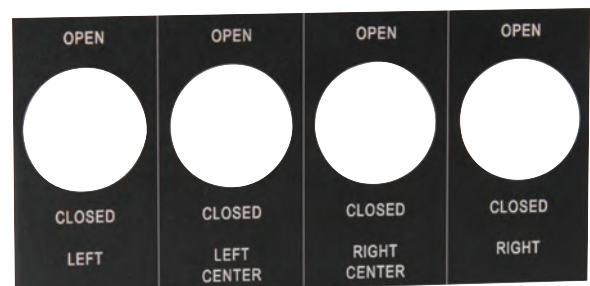
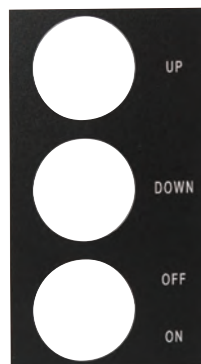
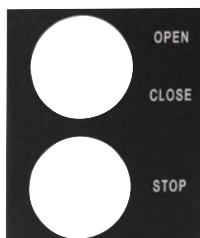

# Engravings

► STANDARD TEXT

**UNIVERSAL TEXT** Code

0-I.....	081
I-II.....	082
I-O-I.....	091
I-II-III.....	092
0-I-START.....	093
0-I-II.....	094

CUSTOM TEXT AVAILABLE  
UPON REQUEST

**TEXT** Code Code Code

AUTO.....	402	EXHAUSTER.....	438	IN.....	476
AUTO CUT.....	403	FAST.....	310	IN OUT.....	477
AUTO HAND.....	404	FAST OFF SLOW.....	439	INCH.....	329
AUTO HAND OFF.....	405	FAST SLOW.....	440	INCH RETURN.....	478
AUTO MAN.....	401	FASTER.....	441	INCH REV.....	480
AUTO MAN OFF.....	406	FAULT.....	442	INCH REVERSE.....	481
AUTO MANUAL.....	407	FEED HOLD.....	443	INCH RUN.....	482
AUTO O HAND.....	408	FEED OFF.....	444	INCHING.....	483
AUTO OFF MAN.....	409	FEED ON.....	445	INCREASE.....	484
AUTO OFF MANUAL.....	410	FEED START.....	446	INSPECT.....	485
AUTO RETURN.....	411	FEED STOP.....	447		
		FEEDER OFF.....	448	JOG.....	328
BLOWER.....	413	FEEDER ON.....	449	JOG FOR.....	486
BRAKE.....	414	FOR.....	450	JOG FORWARD.....	487
		FOR AUTO REV.....	451	JOG FWD.....	488
CLAMP.....	415	FOR O REV.....	452	JOG OFF RUN.....	489
CLOSE.....	314	FOR OFF REV.....	453	JOG REV.....	490
CLOSE CIRCUIT.....	416	FOR REV.....	454	JOG REVERSE.....	491
CLOSE OPEN.....	417	FOR STOP REV.....	455	JOG RUN.....	492
CONTROL OFF.....	418	FORWARD.....	305	JOG SAFE RUN.....	493
CONTROL ON.....	419	FORWARD AUTO REVERSE.....	456	JOG STOP RUN.....	494
CYCLE.....	420	FORWARD OFF REVERSE.....	392		
CYCLE ON.....	421	FORWARD REVERSE.....	457	LAST STOP.....	495
CYCLE START.....	422	FORWARD STOP REVERSE.....	458	LEFT.....	311
CYCLE STOP.....	423	FULL SPEED.....	459	LEFT RIGHT.....	496
		FWD.....	460	LOC REM.....	497
DECREASE.....	424	FWD AUTO REV.....	461	LOCAL OFF REMOTE.....	393
DOWN.....	336	FWD O REV.....	462	LOCAL REMOTE.....	498
DOWN OFF UP.....	425	FWD OFF REV.....	463	LOW.....	499
DOWN UP.....	426	FWD REV.....	464	LOW HIGH.....	501
DRIVE START.....	427	FWD STOP REV.....	465	LOW OFF HIGH.....	502
DRIVE STOP.....	428			LOW OFF RAISE.....	503
		HAND.....	466	LOW SPEED.....	504
EMERG STOP.....	429	HAND AUTO.....	383	LOWER.....	308
EMERGENCY.....	430	HAND I AUTO.....	467	LOWER OFF RAISE.....	505
EMERGENCY OFF.....	431	HAND O AUTO.....	468	LOWER RAISE.....	506
EMERGENCY STOP.....	300	HAND OFF AUTO.....	391	LUBE CYCLE.....	507
EMERGENCY STOP PULL TO RESET.....	432	HAND ON.....	469	LUBE FAIL.....	508
EMERGENCY STOP TURN TO RESET.....	433	HAND START.....	470		
EMERGENCY STOP TWIST TO RESET.....	434	HAND STOP.....	471		
EMO.....	900	HEAT.....	472		
ENABLE.....	435	HIGH.....	473		
ENTER.....	436	HIGH LOW.....	474		
ERROR.....	437	HIGH OFF LOW.....	475		

# Engravings

► STANDARD TEXT

TEXT	Code	Code	Code
MAN AUTO .....	509	REV FWD .....	552
MAN O AUTO .....	510	REV OFF FOR .....	553
MAN OFF AUTO .....	511	REV OFF FWD .....	554
MANUAL .....	512	REVERSE .....	306
MANUAL AUTO .....	513	REVERSE FORWARD .....	555
MANUAL OFF AUTO .....	514	REVERSE OFF FORWARD .....	556
MOTOR RUN .....	515	REVERSING .....	557
MOTOR RUNNING .....	516	RIGHT .....	312
MOTOR START .....	517	RIGHT LEFT .....	558
MOTOR STOP .....	518	ROTATE CCW .....	559
MOTOR STOPPED .....	519	ROTATE CW .....	560
OFF .....	304	RUN .....	327
OFF CIRCUIT .....	520	RUN JOG .....	561
OFF COOLANT ON .....	521	RUN SAFE JOG .....	562
OFF LIGHT ON .....	522	RUNNING .....	563
OFF ON .....	382	SAFE .....	564
OFF RUN .....	523	SAFE RUN .....	565
OFF RUN START .....	523	SEQ TEST .....	566
ON .....	303	SEQUENCE TEST .....	567
ON CIRCUIT .....	524	SETUP .....	568
ON OFF .....	525	SETUP RUN .....	569
ON OFF AUTO .....	526	SETUP SERVICE .....	570
ON STOP SAFE .....	527	SLOW .....	309
OPEN .....	313	SLOW FAST .....	571
OPEN CIRCUIT .....	528	SLOW OFF FAST .....	572
OPEN CLOSE .....	529	SLOW OFF START .....	573
OPEN OFF CLOSE .....	530	SLOW SPEED .....	574
OUT .....	531	SLOW STOP FAST .....	575
OVERLOAD .....	532	SLOWEST .....	576
OVERLOAD RESET .....	533	SOFT SPEED .....	577
OVERLOAD TRIP .....	534	SOUND ALARM .....	578
OVERLOAD TRIPPED .....	535	SPEED .....	579
POWER OFF .....	536	SPINDLE CLOSED .....	580
POWER ON .....	330	SPINDLE OPEN .....	581
PULL TO RESET .....	537	START .....	301
PULL TO START .....	538	START CYCLE .....	582
PURGE .....	539	START FEED .....	583
PUSH TO STOP .....	540	START JOG .....	584
PUSH TO STOP PULL TO START .....	541	START STOP .....	585
PUSH TO STOP TURN TO START .....	542	STOP .....	302
PUSH TO STOP TWIST TO START .....	543	STOP CYCLE .....	586
PUSH TO TEST .....	544	STOP FEED .....	587
RAISE .....	307	STOP RESET .....	588
RAISE LOWER .....	545	STOP START .....	381
RAISE OFF LOWER .....	546	SUMMER OFF WINTER .....	589
READY .....	547	SUMMER WINTER .....	590
RELEASE BRAKE .....	548	SUPPLY ON .....	591
RESET .....	315	SYSTEM ON .....	592
RETURN .....	549	TEST .....	593
REV .....	550	TRANSFER .....	594
REV FOR .....	551	TRIP .....	595

CUSTOM TEXT AVAILABLE  
UPON REQUEST









# Engravings

▶ STANDARD SYMBOLS ISO/DIN











	Description	Symbol	Code
CUSTOM SYMBOLS AVAILABLE UPON REQUEST	Continuous straight-line movement ISO 1		A01
	Alternating straight-line movement ISO 5		A05
	Continuous rotating movement clockwise ISO 7A - DIN 100		A07
	Continuous rotating mov. anti-clockwise ISO 7B		B07
	Forward ISO 16		A16
	Increase in value ISO 28		A28
	Decrease in value ISO 29		A29
	Adjustable ISO 62		A62
	Clamp, block apply pressure ISO 63A		A63
	Clamp, block apply pressure ISO 63B		B63
	Unclamp, release ISO 64A		A64
	Unclamp, release ISO 64B		B64
	Brake ISO 65		A65
	Release brake ISO 66		A66
	Automatic cycle (or semi-automatic) ISO 67		A67
	Manual control ISO 68		A68
	“ON” close circuit ISO 69		A69
	“STOP” close circuit ISO 70		A70
	ON/OFF close + open circuit ISO 71		A71
	Close circuit manual impulse ISO 72		A72
Clutch ISO 74 - DIN 46		A74	
De-clutch ISO 75 - DIN 45		A75	

## Engravings

### ▶ STANDARD SYMBOLS ISO/DIN

	Description	Symbol	Code
CUSTOM SYMBOLS AVAILABLE UPON REQUEST	Warning "live" (energized) ISO 92 - DIN 131		A92
	Main switch ISO 94		A94
	Lubrication jet ISO 101		C01
	Machine lighting ISO 102 - DIN 139		C02
	Greasing ISO 107 - DIN 175		C07
	Blow ISO 108 - DIN 263		C08
	Suction ISO 109 - DIN 264		C09
	Sound alarm DIN 155		D01

### ▶ ADDITIONAL STANDARD SYMBOLS

	Description	Symbol	Code
CUSTOM SYMBOLS AVAILABLE UPON REQUEST			A01
			B01
			E01
			F01
			A62
			B62
			E62
			F62
			003
			004
		005	

## Accessories: $\phi$ 22MM

### ► FLUSH PUSHBUTTON CAPS

#### NON ILLUMINATED

Part Number



LT05

For use with **L21AA, L22AA, L21CA, and L22CA** operators

**WITHOUT TEXT OR SYMBOL**

● Red	LT01
● Green	LT02
● Black	LT03
● Yellow	LT04
○ White	LT05
● Blue	LT06

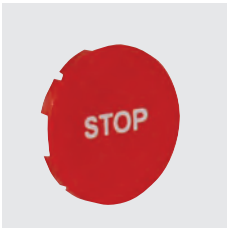

LT21302

**WITH TEXT OR SYMBOL** (see p. 82 to 85)  
Code to be added at the end of the part number.  
For custom text or symbol please contact us.

● Red - white lettering	LT21□□□□
● Green - white lettering	LT22□□□□
● Black - white lettering	LT23□□□□
● Yellow - black lettering	LT24□□□□
○ White - black lettering	LT25□□□□
● Blue - white lettering	LT26□□□□

#### ILLUMINATED



LT20

For use with **L21AH, L22AH, L21CH, and L22CH** operators

**WITHOUT TEXT OR SYMBOL**

● Red	LT10
● Green	LT20
● Yellow	LT40
○ White	LT50
● Blue	LT60



LT34308

**WITH TEXT OR SYMBOL** (see p. 82 to 85)  
Code to be added at the end of the part number.  
For custom text or symbol please contact us.

● Red - white lettering	LT31□□□□
● Green - white lettering	LT32□□□□
● Yellow - black lettering	LT34□□□□
○ White - black lettering	LT35□□□□
● Blue - white lettering	LT36□□□□

## Accessories: $\phi$ 22MM

### ► SHROUDS - REINFORCED DEGREE OF PROTECTION: IP 67

FOR FLUSH PUSH-BUTTONS	Flat Shroud	Part Number
 <p>LWA0252</p>	○ Transparent	LWA0255
	● Red	LWA0251
	● Green	LWA0252
	● Black	LWA0253

FOR FLUSH OR PROJECTED PUSH-BUTTONS	Domed Shroud	Part Number
 <p>LWA0203</p>	○ Transparent	LWA0228
	● Red	LWA0203
	● Green	LWA0204
	● Black	LWA0205

FOR TWIN TOUCH OR TRIPLE TOUCH OPERATORS		Part Number
 <p>LWA0223</p>	For twin touch flush-projecting or triple touch	LWA0223
	○ Transparent	

## Accessories: $\phi$ 22mm

### ► MISCELLANEOUS

#### FIXING TOOL

Part Number



LWA0234

Fixing tool for locking ring - 22mm only

**LWA0234**

Fixing tool for locking ring - 22mm & 30mm

**WAO210**

#### GUARD

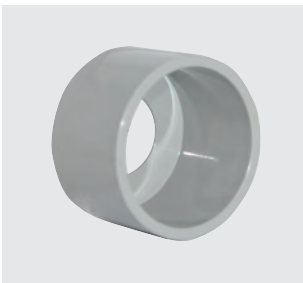

LWA0225

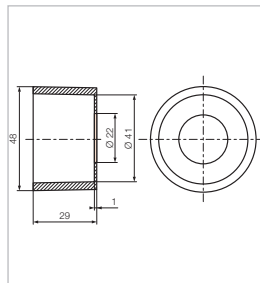

For spring return button and spring return mushroom head  
(max.  $\phi$  40)

● Grey

**LWA0225**

#### PADLOCKABLE GUARD



LWA0240

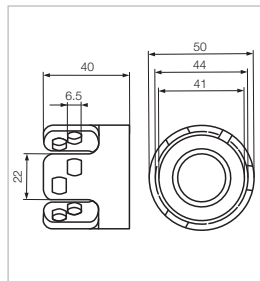

For maintained mushroom head

● Yellow

**LWA0240**

#### HALF GUARD RING



LWA0242

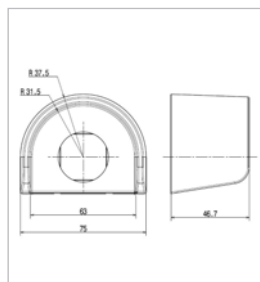

For maintained mushroom head

● Yellow

**LWA0242**



## Accessories: $\phi$ 22mm

### ► MISCELLANEOUS

#### REPLACEMENT KEYS

Part Number



455 / 1424A

Replacement keys (set of 2) - key profile 455

**455**

Replacement keys (set of 2) - key profile 1424A

**1424A**

#### ANTI-ROTATION CLAW PLATE



LWA0237

Metal claw plate

**LWA0237**

#### ANTI-ROTATION RING



LWA209

Plastic anti rotation ring - 22mm

**LWA0209**

#### LOCKING NUT



04006305

Plastic locking nut for 22mm operators

**04006305**

## ► MISCELLANEOUS

### SQUARE FRAME

Part Number



LWA0230

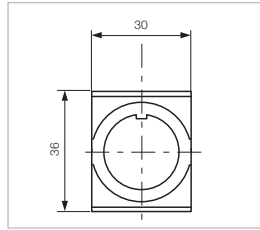

For turning a round shape button or a pilot light into a square shape

- Black

**LWA0230**

### MOUNTING HOLE REDUCTION RING (Ø 30mm to 22mm)



LWA0219

Converts Ø 30 mm panel cut-out to 22 mm hole

- Grey
- Yellow

**LWA0219**  
**LWA0220**

### PUSH BUTTON SUPPORT CLIP-ON TO DIN RAIL



LWA0238

For pilot lights, spring return buttons and selector switches

**LWA0238**

### PADLOCKABLE SHROUD

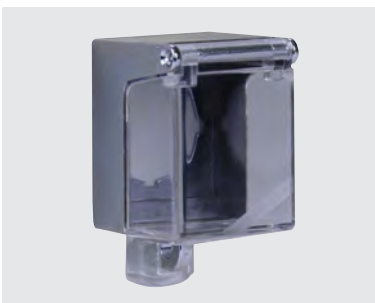

LWA0226

Only for: Flush pushbuttons  
Projected pushbuttons  
Selector switches (not lever handle or key)

**LWA0226**

## ► MISCELLANEOUS

### SCREWDRIVER - FOR PLUG IN TERMINAL BLOCKS



2.5mm (.098") flat head screwdriver  
for use with plug in terminal blocks

**45040**

45040

### BLANKING PLUG

Part Number



- Black
- Grey

**LWA0229**  
**LWA0215**

LWA0229

### TERMINAL FOR LBX ENCLOSURES (GROUND OR NEUTRAL)



For control station  
Base mounted

**LWA0216**

LWA0216

### CABLE GLANDS



M20-BK



PG16-GY

	Size	Cable Thickness	
● Black	M20	6mm - 12mm	<b>M20-BK</b>
● Grey	PG11	3mm - 7mm	<b>PG11-GY</b>
● Grey	PG13.5	6mm - 12mm	<b>PG13-GY</b>
● Grey	PG16	10mm - 14mm	<b>PG16-GY</b>
● Grey	PG21	13mm - 18mm	<b>PG21-GY</b>
● Grey	PG29	18mm - 25mm	<b>PG29-GY</b>

# Din-Rail Assemblies ø 22

▶ NON ILLUMINATED

 Technical Info (p.106)

**SPRING RETURN - FLUSH**

Part Number



LWA0238-101

● Green

NO



**Marking**

START

LWA0238-101

● Red

NC



STOP

LWA0238-104

**SELECTOR SWITCH - WITH HANDLE**



LWA0238-401

● Black

NO



**Marking**

OFF ON

LWA0238-401

**SELECTOR SWITCH - WITH KEY**



LWA0238-402

● Black

NO



**Marking**

OFF ON

LWA0238-402

**MUSHROOM HEAD Ø 40 - MAINTAINED**

Push-turn to reset



LWA0238-301

● Red

NC



**Marking**

EMERGENCY STOP

LWA0238-301

# Control Stations

solutions....



**Control stations with mushroom heads**  
pre-assembled



**Standard Control stations with buttons**  
1, 2 or 3 buttons



**Empty Enclosures**  
1, 2, 3, 4 or 5 holes



**Custom Pre-Assembled Enclosures**  
1, 2, 3, 4 or 5 holes

## ► ADVANTAGES

*"All types of control station applications can be achieved"*

- Multipurpose, pre-equipped with pushbuttons, emergency stops, selector switches, key switches, etc.
- Enclosures for custom assembly 1,2,3,4 or 5 holes
- Up to 3 blocks per position
- Innovative design

# Control Stations $\varnothing$ 22

## ▶ CONTROL STATIONS - NON-ILLUMINATED

 Technical Info (p.106)

### SPRING RETURN - FLUSH

Part Number

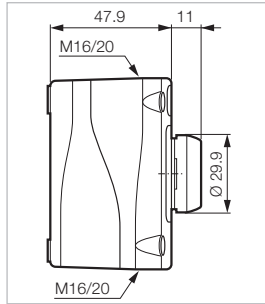

- Green
- Red

NO  
NC



#### Marking



LBX10110  
LBX10610

LBX10110

### MUSHROOM HEAD $\varnothing$ 40 - SPRING RETURN

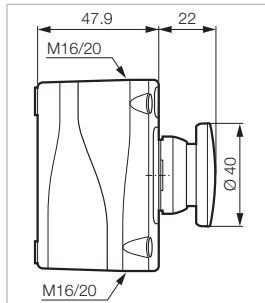

- Green
- Red
- Red

NO  
NC  
NO

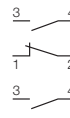

#### Marking



LBX107210  
LBX10210  
LBX130028

LBX10210

### SELECTOR SWITCH - WITH HANDLE

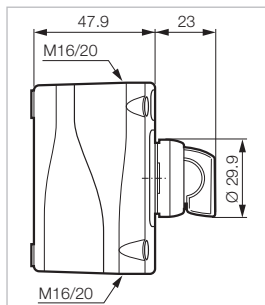

2 Maintained positions - 90°

- Black
- Black
- Black

NO  
NC + NO  
2 NO

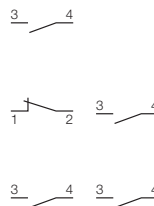

#### Marking



LBX12510  
LBX12511  
LBX12520

LBX12510

### SELECTOR SWITCH - WITH KEY

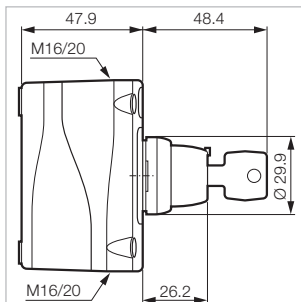

Supplied with 2 keys profile n° 455

2 Maintained positions - 90°  
Key free in position 0-1

- Black

NO



#### Marking



LBX12610

LBX12610

# Control Stations $\varnothing$ 22

## ► CONTROL STATIONS - NON-ILLUMINATED

 Technical Info (p. 106)

### MUSHROOM HEAD $\varnothing$ 40 - MAINTAINED



Push-turn to reset

Part Number

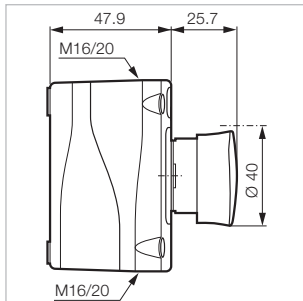

LBX10510

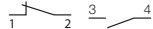
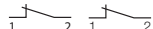

● Red	NC		EMERGENCY STOP	<b>LBX10510</b>
● Red	NC + NO		EMERGENCY STOP	<b>LBX130006</b>
● Red	2 NC		EMERGENCY STOP	<b>LBX130005</b>
● Red	NO		EMERGENCY STOP	<b>LBX130007</b>

**WITH STOP STOP STOP TEXT ON BUTTON HEAD**

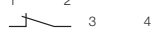
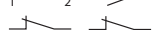
● Red	NC		EMERGENCY STOP	<b>LBX10510S</b>
● Red	NC + NO		EMERGENCY STOP	<b>LBX130010</b>
● Red	2 NC		EMERGENCY STOP	<b>LBX130009</b>

For contact blocks attached to operator please contact us.



LBX130009

### MUSHROOM HEAD $\varnothing$ 40 - MAINTAINED

Push-pull to reset



LBX101910

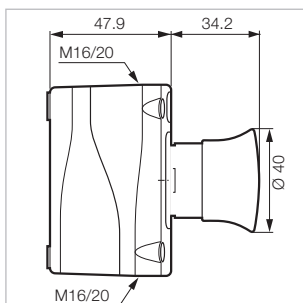

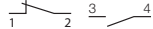
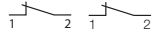
● Red	NC		EMERGENCY STOP	<b>LBX101910</b>
● Red	NC + NO		EMERGENCY STOP	<b>LBX130004</b>
● Red	2 NC		EMERGENCY STOP	<b>LBX130003</b>

**WITH STOP STOP STOP TEXT ON BUTTON HEAD**

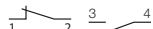
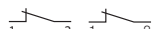
● Red	NC		EMERGENCY STOP	<b>LBX101910S</b>
● Red	NC + NO		EMERGENCY STOP	<b>LBX130074</b>
● Red	2 NC		EMERGENCY STOP	<b>LBX130075</b>

For contact blocks attached to operator please contact us.



LBX101910S

# Control Stations Ø 22

## ▶ CONTROL STATIONS - NON-ILLUMINATED

 Technical Info (p.106)

### MUSHROOM HEAD Ø 40 - MAINTAINED

Key to reset



Part Number

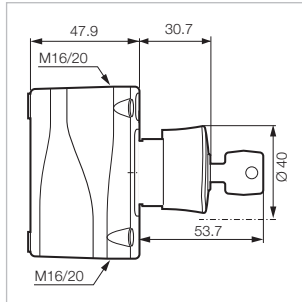

LBX11210



Supplied with 2 keys profile n° 455

● Red	NC		EMERGENCY STOP	<b>LBX11210</b>
● Red	NC + NO		EMERGENCY STOP	<b>LBX130071</b>
● Red	2 NC		EMERGENCY STOP	<b>LBX130072</b>

For contact blocks attached to operator please contact us.

### MUSHROOM HEAD Ø 40 ISO 13850





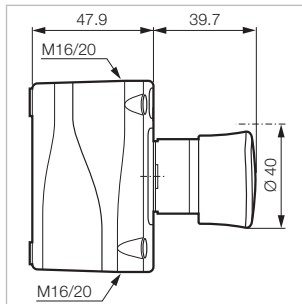

Push-turn to reset





LBX17301



Compliant with the requirements of emergency stop: ISO 13850

● Red	NC		EMERGENCY STOP + 	<b>LBX17301</b>
● Red	NC + NO		EMERGENCY STOP + 	<b>LBX17311</b>
● Red	2 NC		EMERGENCY STOP + 	<b>LBX17302</b>

#### WITH EN13850 SYMBOL ON BUTTON HEAD

● Red	NC		EMERGENCY STOP	<b>LBX130065</b>
● Red	NC + NO		EMERGENCY STOP	<b>LBX130057</b>
● Red	2 NC		EMERGENCY STOP	<b>LBX130066</b>

#### WITH EMO TEXT ON BUTTON HEAD (WITHOUT EMERGENCY STOP ON ENCLOSURE)

● Red	NC			<b>LBX130067</b>
● Red	NC + NO			<b>LBX130068</b>
● Red	2 NC			<b>LBX130069</b>



LBX130057



LBX130069

For contact blocks attached to operator please contact us.



# Control Stations Ø 22

## ► CONTROL STATIONS - NON-ILLUMINATED

 Technical Info (p. 106)

### MUSHROOM HEAD Ø 40 ISO 13850

Push-pull to reset





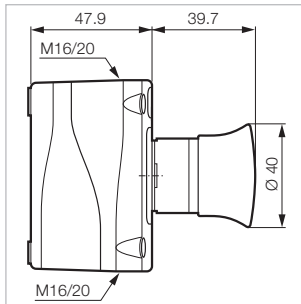

Part Number



LBX15301



Compliant with the requirements of emergency stop:  
ISO 13850

- |       |         |  |  |                 |
|-------|---------|--|--|-----------------|
| ● Red | NC      |  | EMERGENCY STOP +  | <b>LBX15301</b> |
| ● Red | NC + NO |  | EMERGENCY STOP +  | <b>LBX15311</b> |
| ● Red | 2 NC    |  | EMERGENCY STOP +  | <b>LBX15302</b> |

For contact blocks attached to operator please contact us.

### MUSHROOM HEAD Ø 40 ISO 13850





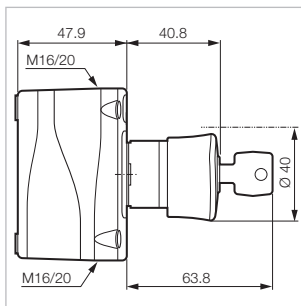

Key to reset



LBX11302



Compliant with the requirements of emergency stop:  
ISO 13850  
Supplied with 2 keys profile n° 455

- |       |         |  |  |                 |
|-------|---------|--|--|-----------------|
| ● Red | NC      |  | EMERGENCY STOP +  | <b>LBX11301</b> |
| ● Red | NC + NO |  | EMERGENCY STOP +  | <b>LBX11311</b> |
| ● Red | 2 NC    |  | EMERGENCY STOP +  | <b>LBX11302</b> |

For contact blocks attached to operator please contact us.

### MUSHROOM HEAD Ø 54 ISO 13850





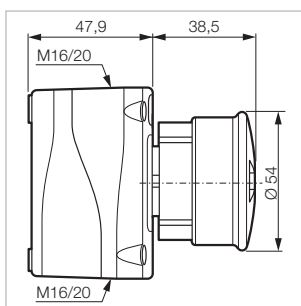

Push-pull to reset with flag indicator









LBX14201



Compliant with the requirements of emergency stop:  
ISO 13850  
Double position indicator: head and collar

- |       |         |  |   |                 |
|-------|---------|--|---|-----------------|
| ● Red | NC      |  |  | <b>LBX14101</b> |
| ● Red | NC + NO |  |  | <b>LBX14111</b> |
| ● Red | 2 NC    |  |  | <b>LBX14102</b> |

- |       |         |  |  |                 |
|-------|---------|--|--|-----------------|
| ● Red | NC      |  | STOP -  | <b>LBX14201</b> |
| ● Red | NC + NO |  | STOP -  | <b>LBX14211</b> |
| ● Red | 2 NC    |  | STOP -  | <b>LBX14202</b> |

For contact blocks attached to operator please contact us.

# Control Stations ø 22

## ► CONTROL STATIONS - NON-ILLUMINATED

 Technical Info (p.106)

### SPRING RETURN - FLUSH

Part Number

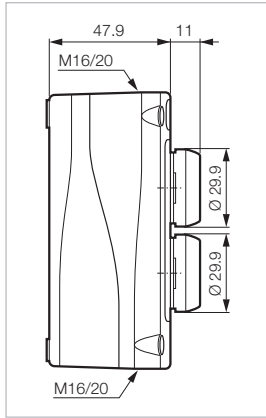

- Green
- Red

NO  
NC



Marking



LBX20120

LBX20120

### SPRING RETURN - FLUSH/MUSHROOM

Marking

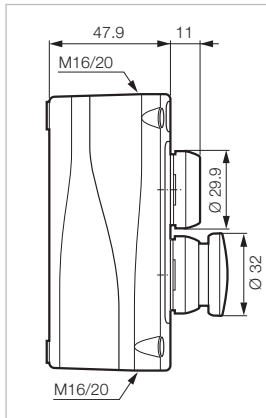

- Green
- Red

NO  
NC



LBX210660

LBX210660

### SPRING RETURN/MAINTAINED - FLUSH/MUSHROOM (PUSH-TURN)

Marking

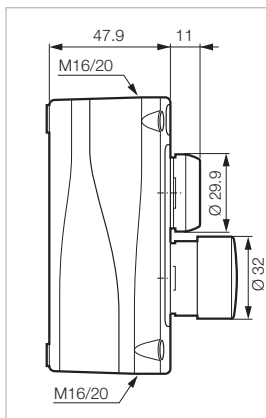

- Green
- Red

NO  
NC



LBX210770

LBX210770

# Control Stations ø 22

## ▶ CONTROL STATIONS - NON-ILLUMINATED

 Technical Info (p. 106)



### SPRING RETURN - FLUSH

Part Number

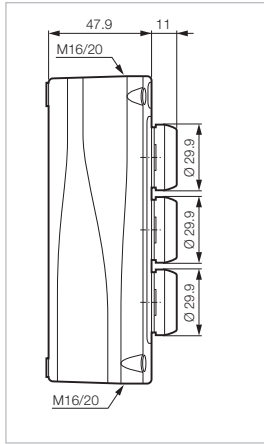

LBX323870





● Red 24VAC/DC Pilot Light  
 ● Green NO   
 ● Red NC 

Marking





LBX30008

● Red 130VAC Pilot Light  
 ● Green NO   
 ● Red NC 

Marking



LBX323870

● Red 230VAC Pilot Light  
 ● Green NO   
 ● Red NC 

Marking







LBX324110

### SPRING RETURN - FLUSH

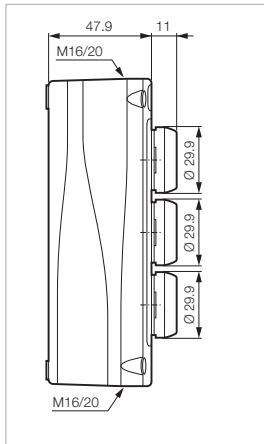

LBX30430



● Green NO   
 ● Red NC   
 ● Green NO 

Marking







LBX30430

### SPRING RETURN /MAINTAINED - FLUSH/MUSHROOM (PUSH-TURN)

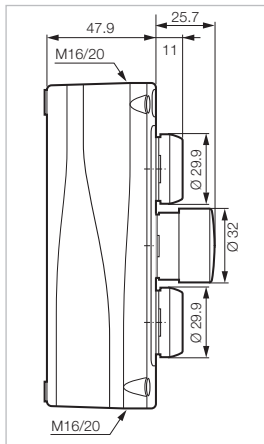

LBX308830



● Green NO   
 ● Red NC   
 ● Green NO 

Marking



LBX308830

# Control Stations $\emptyset$ 22

## ▶ EMPTY ENCLOSURES

 Technical Info (p.106)

### 1 HOLE

Part Number



LBX0100J

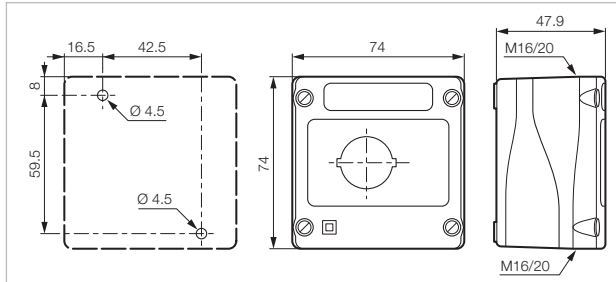

**Black base**

- Grey cover
- Yellow cover
- Yellow cover\*
- Yellow cover\*\*
- Black cover
- Red cover

- LBX0100
- LBX0100J
- LBX0100JB
- LBX130167
- LBX0100NR
- LBX0100RN

\* WITH 'EMERGENCY STOP' TEXT  
 \* WITH IEC 60417-5438 / ISO 13850 SYMBOL 

**Red base**

- Red cover

- LBX0100RG

### 2 HOLES



LBX0200

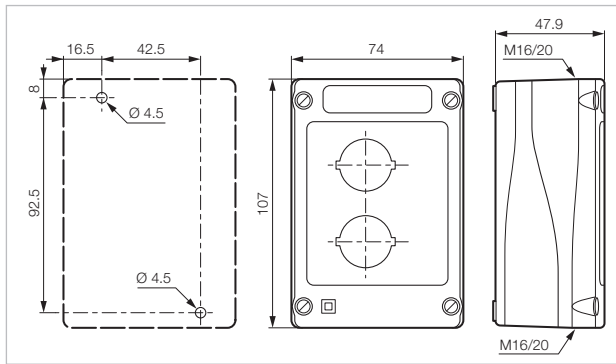

**Black base**

- Grey cover
- Yellow cover

- LBX0200
- LBX0200J

### 3 HOLES



LBX0300

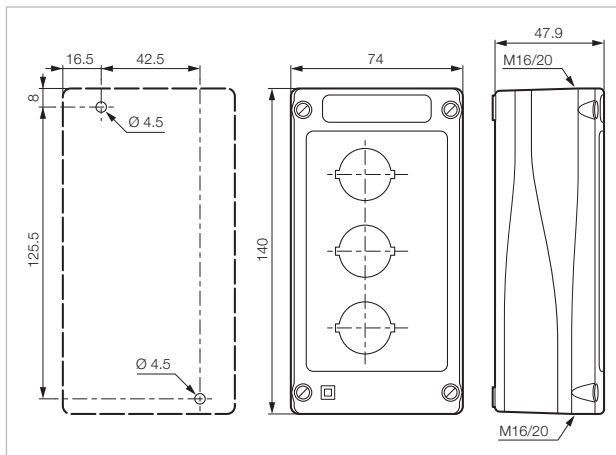

**Black base**

- Grey cover

- LBX0300

# Control Stations $\varnothing$ 22

## ▶ EMPTY ENCLOSURES

 Technical Info (p. 106)

### 4 HOLES

Part Number



LBX0400

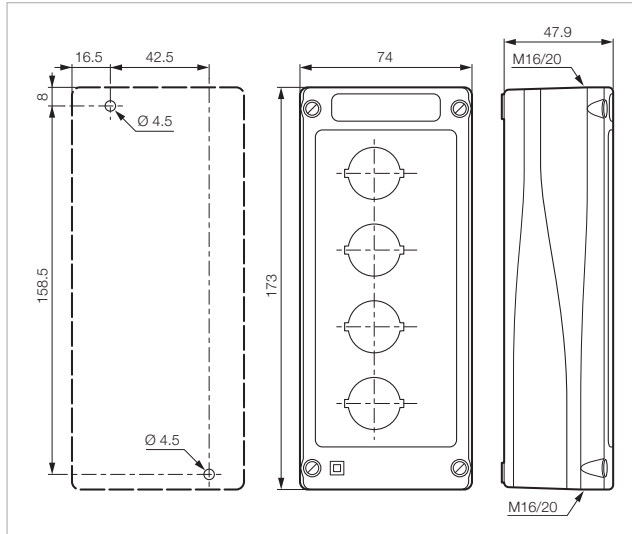

**Black base**

- Grey cover

**LBX0400**

### 5 HOLES



LBX0500

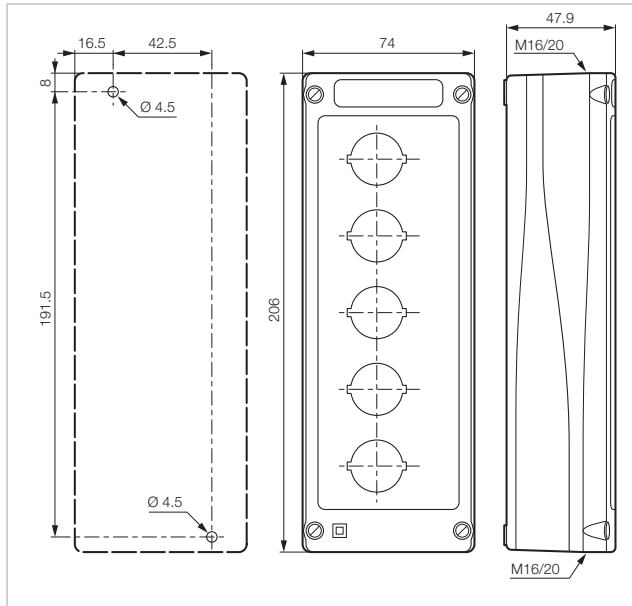

**Black base**

- Grey cover

**LBX0500**

### CABLE GLAND FOR LBX ENCLOSURES



M20-BK

	Size	Cable Thickness	
● Black	M20	6mm - 12mm	<b>M20-BK</b>

## LBX ENCLOSURE SPECIAL REQUEST FORM

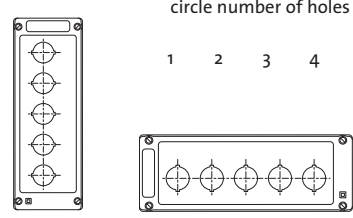
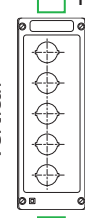
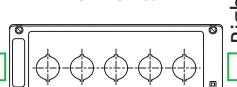
MOUNTING NUMBER OF HOLES	CABLE GLAND	COMMENTS
<div style="text-align: center;">circle number of holes</div> <div style="text-align: center;">1   2   3   4   5</div>  <div style="display: flex; justify-content: space-around; margin-top: 10px;"> <span><input type="checkbox"/> Vertical</span> <span><input type="checkbox"/> Horizontal</span> </div>	<div style="display: flex; justify-content: space-between; align-items: center;"> <div style="text-align: center;"> <input type="checkbox"/> Top    <input type="checkbox"/> Bottom         </div> <div style="text-align: center;"> <input type="checkbox"/> Left    <input type="checkbox"/> Right         </div> </div>	<hr/> <hr/> <hr/> <hr/> <hr/> <hr/> <hr/> <hr/>

<b>DUTY LABEL MARKING</b> <small>(contact us for details)</small>	<b>BLOCKS</b>	<b>SWITCHES</b>	<b>LEGEND PLATES</b>	<b>ENCLOSURE MARKING</b>
--	---------------	-----------------	----------------------	--------------------------

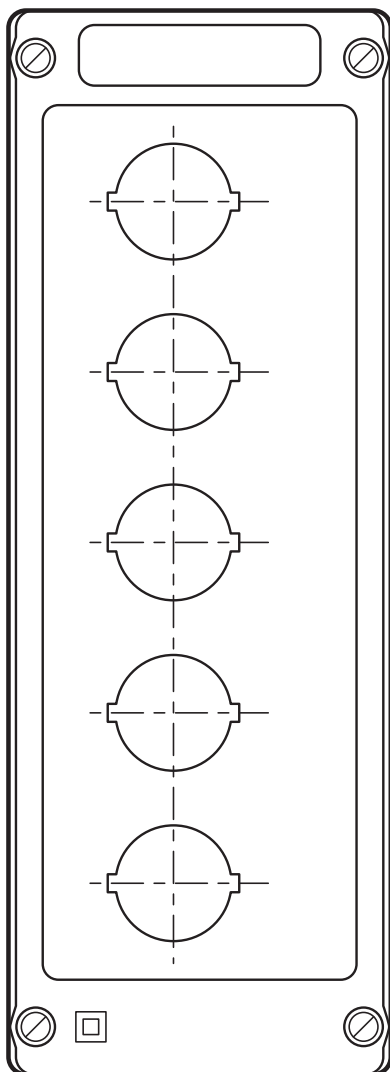

Enter contact block part number in each mounting position. LED modules must be in position 3.

2
3
1

2
3
1

2
3
1

2
3
1

2
3
1

Enter switch part number for each position. For text or symbol on the switch head enter text or symbol code.

Switch Part Number:
Text or Symbol code:

Switch Part Number:
Text or Symbol code:

Switch Part Number:
Text or Symbol code:

Switch Part Number:
Text or Symbol code:

Switch Part Number:
Text or Symbol code:

Enter legend plate part number for each position. See page 101 for available legend plates. For text or symbol on the legend plate enter text or symbol code.

Legend Plate Part number:
Text or Symbol code:

Legend Plate Part number:
Text or Symbol code:

Legend Plate Part number:
Text or Symbol code:

Legend Plate Part number:
Text or Symbol code:

Legend Plate Part number:
Text or Symbol code:

For silk-screened text or symbol directly on the enclosure enter text or symbol code.

Text or Symbol code:
----------------------

Text or Symbol code:
----------------------

Text or Symbol code:
----------------------

Text or Symbol code:
----------------------



Text or Symbol code:
----------------------



See pages 80 to 83 for available text and symbol options. For custom text or symbols please contact us.



## Control Stations $\varnothing$ 22

### ► CONTROL STATIONS - MUSHROOM BUTTONS WITH GUARDS

 Technical Info (p. 106)

MUSHROOM HEAD $\varnothing$ 40	Push-pull to reset	No Guard Part Number	Padlockable Guard Part Number	Half Guard Part Number
		<ul style="list-style-type: none"> <li>● Red NC LSS15301</li> <li>● Red NC + NO LSS15311</li> <li>● Red 2 NC LSS15302</li> </ul>	<ul style="list-style-type: none"> <li>LSS15301G</li> <li>LSS15311G</li> <li>LSS15302G</li> </ul>	<ul style="list-style-type: none"> <li>LSS15301G2</li> <li>LSS15311G2</li> <li>LSS15302G2</li> </ul>
LSS15301	LSS15301G			



MUSHROOM HEAD $\varnothing$ 40	Push-turn to reset	No Guard Part Number	Padlockable Guard Part Number	Half Guard Part Number
		<ul style="list-style-type: none"> <li>● Red NC LSS17301</li> <li>● Red NC + NO LSS17311</li> <li>● Red 2 NC LSS17302</li> </ul>	<ul style="list-style-type: none"> <li>LSS17301G</li> <li>LSS17311G</li> <li>LSS17302G</li> </ul>	<ul style="list-style-type: none"> <li>LSS17301G2</li> <li>LSS17311G2</li> <li>LSS17302G2</li> </ul>
LSS17301	LSS17301G2			



MUSHROOM HEAD $\varnothing$ 40	Push-key to reset	No Guard Part Number	Padlockable Guard Part Number	Half Guard Part Number
		<ul style="list-style-type: none"> <li>● Red NC LSS11301</li> <li>● Red NC + NO LSS11311</li> <li>● Red 2 NC LSS11302</li> </ul>	<ul style="list-style-type: none"> <li>LSS11301G</li> <li>LSS11311G</li> <li>LSS11302G</li> </ul>	<ul style="list-style-type: none"> <li>LSS11301G2</li> <li>LSS11311G2</li> <li>LSS11302G2</li> </ul>
LSS11301G	LSS11301G2			

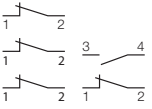

# Control Stations $\varnothing$ 22

## ▶ CONTROL STATIONS - EMERGENCY STOPS WITH GUARDS

 Technical Info (p. 106)

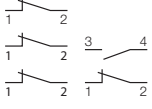
MUSHROOM HEAD $\varnothing$ 40		Push-pull to reset	Padlockable Guard Part Number	Half Guard Part Number
		<ul style="list-style-type: none"> <li>● Red NC</li> <li>● Red NC + NO</li> <li>● Red 2 NC</li> </ul> 	<p>LBPA15301G LBPA15311G LBPA15302G</p>	<p>LBPA15301G2 LBPA15311G2 LBPA15302G2</p>
LBX15301	LBX15301			

MUSHROOM HEAD $\varnothing$ 40		Push-turn to reset	Padlockable Guard Part Number	Half Guard Part Number
		<ul style="list-style-type: none"> <li>● Red NC</li> <li>● Red NC + NO</li> <li>● Red 2 NC</li> </ul> 	<p>LBPA17301G LBPA17311G LBPA17302G</p>	<p>LBPA17301G2 LBPA17311G2 LBPA17302G2</p>
LBX17301	LBX17301			

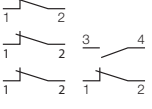
MUSHROOM HEAD $\varnothing$ 40		Push-key to reset	Padlockable Guard Part Number	Half Guard Part Number
		<ul style="list-style-type: none"> <li>● Red NC</li> <li>● Red NC + NO</li> <li>● Red 2 NC</li> </ul> 	<p>LBPA11301G LBPA11311G LBPA11302G</p>	<p>LBPA11301G2 LBPA11311G2 LBPA11302G2</p>
LBX17301	LBX17301			



## Control Stations ø 22

### ► PRE-DRILLED POLYCARBONATE ENCLOSURES



BPA202

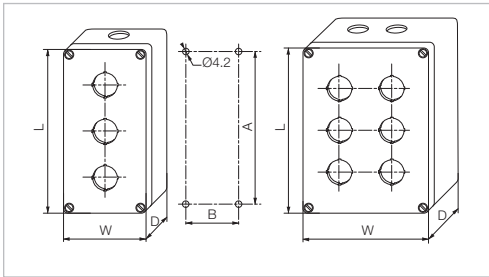

Number of Holes	Cable Gland Hole Entries	Dimensions (mm)					Part Number
		L	W	D	A	B	
1	1 x PG13-GY	82	80	55	70	50	<b>BPA201</b>
2	1 x PG13-GY	120	80	55	108	50	<b>BPA202</b>
3	1 x PG13-GY	160	80	55	148	50	<b>BPA203</b>
1	1 x PG16-GY	82	80	85	70	50	<b>BPP201</b>
2	1 x PG16-GY	120	80	85	108	50	<b>BPP202</b>
3	1 x PG16-GY	160	80	85	148	50	<b>BPP203</b>
4	2 x PG16-GY	122	120	85	110	90	<b>BPP204</b>
6	2 x PG16-GY	200	120	75	188	90	<b>BPA206</b>
8	2 x PG16-GY	200	120	75	188	90	<b>BPA208</b>
10	2 x PG16-GY	240	120	100	288	90	<b>BPP210</b>

### ► EMPTY POLYCARBONATE ENCLOSURES



BNT220



BNT251

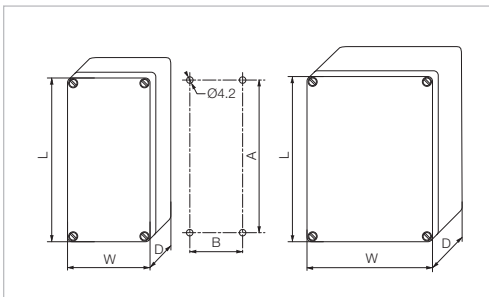

L	W	D	Dimensions (mm)		Part Number
			A	B	
65	50	35	53	38	<b>BNT206</b>
82	80	55	70	50	<b>BNT210</b>
82	80	85	70	50	<b>BNT225</b>
120	80	55	108	50	<b>BNT215</b>
120	80	85	108	50	<b>BNT226</b>
122	120	55	110	90	<b>BNT217</b>
122	120	85	110	90	<b>BNT227</b>
160	80	55	148	50	<b>BNT220</b>
160	80	85	148	50	<b>BNT231</b>
200	120	75	188	90	<b>BNT237</b>
200	150	75	188	119	<b>BNT223</b>
240	120	100	228	90	<b>BNT242</b>
240	160	120	228	130	<b>BNT243</b>
250	160	90	238	130	<b>BNT240</b>

### CABLE GLANDS



PG16-GY

Size	Cable Thickness	Part Number
● Grey PG11	3mm - 7mm	<b>PG11-GY</b>
● Grey PG13.5	6mm - 12mm	<b>PG13-GY</b>
● Grey PG16	10mm - 14mm	<b>PG16-GY</b>
● Grey PG21	13mm - 18mm	<b>PG21-GY</b>
● Grey PG29	18mm - 25mm	<b>PG29-GY</b>

# Technical Specifications

## ▶ GENERAL

Characteristics	Data	Standards
▶ Storage temperature	- 40 °C to + 70 °C	
▶ Operating temperature	- 25 °C to + 70 °C	
▶ Climatic resistance	Constant humid heat Cyclic damp heat Resistance to sea air	IEC 60068-2-3 IEC 60068-2-30 IEC 60068-2-52
▶ Degree of protection	IP 65 for adjustable mechanical actuators IP 65 for USB interface IP 66 for standard heads IP 67 for shrouded heads IP 66 for equipped control stations IP 69 and IP 69k for pushbuttons (except twin/triple touch) IP 69 and IP 69k for selector switches IP 69 and IP 69k for pilot lights IP 69 and IP 69k for emergency stops IP 69 and IP 69k for audible warning buzzers  IP20 at the rear of the panel for contact blocks and one piece pilot lights  Type 1, 2, 3, 3R, 3S, 4, 4X, 12, and 13 for heads and control stations	IEC 60529 IEC 60529 IEC 60529 IEC 60529 IEC 60529 IEC 60529 - ISO 20653 IEC 60529 - ISO 20653 IEC 60529 - ISO 20653 IEC 60529 - ISO 20653 IEC 60529 - ISO 20653 NEMA standard
z		
▶ Protection against mechanical impacts	IK 05 illuminated and non-illuminated heads IK 07 empty control station	IEC 62262
▶ Electrical insulation	Class II - heads and control station	IEC 60947-5-1
▶ Terminal marking		IEC 60947-1
▶ Tightening torques	Locking ring: recommended 3 N.m or tightened with the fixing tool to hand tight after pressure point plus another half turn. terminals: max. 1.2 N.m	
▶ Approvals	UL United states and Canada BV Bureau Véritas Certification OC/CB	UL 508, CSA 22.2 Marine rules IEC 60947-5-1 IEC 60947-5-5 IEC 60947-5-4
▶ Vibrations	withstand vibration Fc test: 2 to 25 Hz, 1.6 mm; 25-100 Hz, 4 g	IEC 60068-2-6

## Technical Specifications

---

### ► HEADS

Characteristics	Data
► Mechanical endurance	Spring return: 5,000,000 Push-push: 500,000 Selector switches: 300,000 Mushroom head maintained function ISO 13850: 100,000 Mushroom head maintained function: 150,000
► Activation force in N	Spring return + NO: 6.5 Spring return + NC: 4.5 Additional NO contact: 4.5 Additional NC contact: 3.0 Push-pull mushroom head + NO + NC: 27 Push-turn mushroom head + NO + NC: 22 Push-pull mushroom head EN 418 + NO + NC: 37 Push-turn mushroom head EN 418 + NO + NC: 60
► Activation force in Nm	Selector switch + NO: 0.04 Additional NO contact: 0.03

### ► EMERGENCY STOP ACTUATORS - ISO 13850:

According to IEC60947-5-5, the emergency stop function can be provided by an ISO13850 mushroom head combined with a "positive opening" NC contact block.

The mechanism of our ISO13850 mushroom heads is so designed that a "push" action of sufficient force to open the contact systematically triggers an irreversible locking of this opening. This generates an "emergency stop" signal which can be cancelled only by deliberate manual resetting of the mushroom head (pull, turn or unlocking by key).

This function allows the generation of an "emergency stop" signal for any equipment subject to directive 98/37CE (machinery safety) completed by the IEC 60204-1 standard.

The ISO13850 mushroom heads also comply with the safety requirements detailed in standard ISO13850.

# Technical Specifications

## ▶ CONTACT BLOCKS

Screw and plug-in connection characteristics	Data	Standards																																									
▶ Rated insulation voltage	690 V AC 600 V AC	IEC/EN 60947-1 UL 508																																									
▶ NC contacts	Positive opening	IEC/EN 60947-5-1																																									
▶ Rated impulse voltage Uimp Pollution degree	6kV 3																																										
▶ Conventional thermal current in free air conditions	AC15: 10 A DC13: 2.5 A	IEC 60947-5-1																																									
▶ Electrical ratings	<p><b>Alternating current</b> AC15 - A 600 Ue = 120 V, Ie = 6 A Ue = 240 V, Ie = 3 A Ue = 380 V, Ie = 1.9 A Ue = 480 V, Ie = 1.5 A Ue = 500 V, Ie = 1.4 A Ue = 600 V, Ie = 1.2 A</p> <p><b>Minimum operating current</b> - standard blocks Ue = 24 V DC and Ie = 5 mA Failure rate &lt; 10<sup>-8</sup></p> <p><b>UL508</b></p> <p>Alternating Current 50/60Hz - <b>A600</b> Continuous Current - 10 amps Rated Voltage - 600Vac</p> <table border="1"> <thead> <tr> <th rowspan="2">Voltage</th> <th colspan="2">Max. Amps</th> <th rowspan="2">Voltage</th> <th colspan="2">Max. Amps</th> </tr> <tr> <th>Make</th> <th>Break</th> <th>Make</th> <th>Break</th> </tr> </thead> <tbody> <tr> <td>72</td> <td>60</td> <td>10</td> <td>24</td> <td>2.5</td> <td>2.5</td> </tr> <tr> <td>120</td> <td>60</td> <td>6.0</td> <td>125</td> <td>0.55</td> <td>0.55</td> </tr> <tr> <td>240</td> <td>30</td> <td>3.0</td> <td>250</td> <td>0.27</td> <td>0.27</td> </tr> <tr> <td>480</td> <td>15</td> <td>1.5</td> <td>301-600</td> <td>0.10</td> <td>0.10</td> </tr> <tr> <td>600</td> <td>12</td> <td>1.2</td> <td></td> <td></td> <td></td> </tr> </tbody> </table>	Voltage	Max. Amps		Voltage	Max. Amps		Make	Break	Make	Break	72	60	10	24	2.5	2.5	120	60	6.0	125	0.55	0.55	240	30	3.0	250	0.27	0.27	480	15	1.5	301-600	0.10	0.10	600	12	1.2				<p><b>Direct current</b> DC13 - Q 600 Ue = 125 V, Ie = 0.55 A Ue = 250 V, Ie = 0.27 A Ue = 400 V, Ie = 0.15 A Ue = 500 V, Ie = 0.13 A Ue = 600 V, Ie = 0.1 A</p> <p>- gold plated contacts Ue = 5 V DC and Ie = 1 mA Failure rate &lt; 10<sup>-8</sup></p> <p>Direct Current - <b>Q600</b> Continuous Current - 2.5 amps Rated Voltage - 600Vdc</p>	IEC 60947-5-1
Voltage	Max. Amps		Voltage	Max. Amps																																							
	Make	Break		Make	Break																																						
72	60	10	24	2.5	2.5																																						
120	60	6.0	125	0.55	0.55																																						
240	30	3.0	250	0.27	0.27																																						
480	15	1.5	301-600	0.10	0.10																																						
600	12	1.2																																									
▶ Electrical operating life	<p><b>1 million cycles for:</b> - AC15 - B 300 Ue = 120 V, Ie = 3 A Ue = 240 V, Ie = 1.5 A</p> <p>- DC13 - R 300 Ue = 125 V, Ie = 0.22 A Ue = 250 V, Ie = 0.1 A</p>																																										
▶ Applicable wire sizes	Rigid or flexible wire without ferrule: 0.5 mm <sup>2</sup> to 2 x 2.5 mm <sup>2</sup> Rigid or flexible wire with ferrule: 0.5 mm <sup>2</sup> to 2 x 1.5 mm <sup>2</sup>																																										

# Technical Specifications

## ▶ CONTACT BLOCKS

Faston connection	Data	Standards																																																
▶ Rated insulation voltage	320 V AC 300 V AC	IEC/EN60947-1 UL 508																																																
▶ NC contacts	Positive opening	IEC/EN 60947-5-1																																																
▶ Rated impulse voltage Uimp Pollution degree	6 kV 3																																																	
▶ Conventional thermal current in free air conditions	AC 15: 10 A DC 13: 2.5 A	IEC 60947-5-1																																																
▶ Electrical ratings	<p><b>Alternating current</b> AC15 - A 300 Ue = 120 V, Ie = 6 A Ue = 240 V, Ie = 3 A</p> <p><b>Minimum current of use</b> Ue = 24 V DC and Ie = 5 mA Failure rate &lt; 10<sup>-8</sup></p> <p><b>UL508</b></p> <table border="0"> <tr> <td colspan="3">Alternating Current 50/60Hz - <b>A300</b></td> <td colspan="3">Direct Current - <b>Q300</b></td> </tr> <tr> <td colspan="3">Continuous Current - 10 amps</td> <td colspan="3">Continuous Current - 2.5 amps</td> </tr> <tr> <td colspan="3">Rated Voltage - 300Vac</td> <td colspan="3">Rated Voltage - 300Vdc</td> </tr> <tr> <td></td> <td>Max. Amps</td> <td>Max. Amps</td> <td></td> <td>Max. Amps</td> <td>Max. Amps</td> </tr> <tr> <td>Voltage</td> <td>Make</td> <td>Break</td> <td>Voltage</td> <td>Make</td> <td>Break</td> </tr> <tr> <td>72</td> <td>60</td> <td>10</td> <td>24</td> <td>2.5</td> <td>2.5</td> </tr> <tr> <td>120</td> <td>60</td> <td>6.0</td> <td>125</td> <td>0.55</td> <td>0.55</td> </tr> <tr> <td>240</td> <td>30</td> <td>3.0</td> <td>250</td> <td>0.27</td> <td>0.27</td> </tr> </table>	Alternating Current 50/60Hz - <b>A300</b>			Direct Current - <b>Q300</b>			Continuous Current - 10 amps			Continuous Current - 2.5 amps			Rated Voltage - 300Vac			Rated Voltage - 300Vdc				Max. Amps	Max. Amps		Max. Amps	Max. Amps	Voltage	Make	Break	Voltage	Make	Break	72	60	10	24	2.5	2.5	120	60	6.0	125	0.55	0.55	240	30	3.0	250	0.27	0.27	IEC 60947-5-1
Alternating Current 50/60Hz - <b>A300</b>			Direct Current - <b>Q300</b>																																															
Continuous Current - 10 amps			Continuous Current - 2.5 amps																																															
Rated Voltage - 300Vac			Rated Voltage - 300Vdc																																															
	Max. Amps	Max. Amps		Max. Amps	Max. Amps																																													
Voltage	Make	Break	Voltage	Make	Break																																													
72	60	10	24	2.5	2.5																																													
120	60	6.0	125	0.55	0.55																																													
240	30	3.0	250	0.27	0.27																																													
▶ Electrical operating life	<p><b>1 million cycles for:</b></p> <p>- AC15 - B 300 Ue = 120 V, Ie = 3 A Ue = 240 V, Ie = 1.5 A</p> <p>- DC13 - R 300 Ue = 125 V, Ie = 0.22 A Ue = 250 V, Ie = 0.1 A</p>																																																	
▶ Faston size	6.35 mm (0.25") or 2 x 2.8 mm (0.110")																																																	

# Technical Specifications

## ▶ CONTACT BLOCKS

Pin-style connection (for PCB)	Data	Standards																													
▶ Rated insulation voltage	250 V AC 250 V AC	IEC/EN60947-1 UL 508																													
▶ NC contacts	Positive opening	IEC/EN 60947-5-1																													
▶ Rated impulse voltage Uimp Pollution degree	4 kV 3																														
▶ Conventional thermal current in free air conditions	AC 15: 5 A DC 13: 1 A	IEC 60947-5-1																													
▶ Electrical ratings	<p><b>Alternating current</b> AC 15 - B 300 Ue = 120 V, Ie = 3 A Ue = 240 V, Ie = 1,5 A</p> <p><b>Minimum current of use</b> - standard blocks Ue = 24 V DC and Ie = 5 mA Failure rate &lt; 10<sup>-8</sup></p> <p><b>UL508</b></p> <p>Alternating Current 50/60Hz - <b>B300</b> Continuous Current - 5 amps Rated Voltage - 300Vac</p> <table border="1"> <thead> <tr> <th rowspan="2">Voltage</th> <th colspan="2">Max. Amps</th> <th rowspan="2">Voltage</th> <th colspan="2">Max. Amps</th> </tr> <tr> <th>Make</th> <th>Break</th> <th>Make</th> <th>Break</th> </tr> </thead> <tbody> <tr> <td>72</td> <td>30</td> <td>5.0</td> <td>24</td> <td>1.0</td> <td>1.0</td> </tr> <tr> <td>120</td> <td>30</td> <td>3.0</td> <td>125</td> <td>0.22</td> <td>0.22</td> </tr> <tr> <td>240</td> <td>15</td> <td>1.5</td> <td>250</td> <td>0.11</td> <td>0.11</td> </tr> </tbody> </table>	Voltage	Max. Amps		Voltage	Max. Amps		Make	Break	Make	Break	72	30	5.0	24	1.0	1.0	120	30	3.0	125	0.22	0.22	240	15	1.5	250	0.11	0.11	<p><b>Direct current</b> DC13 - R 300 Ue = 125 V, Ie = 0.22 A Ue = 250 V, Ie = 0.1 A</p> <p>- gold plated contacts Ue = 5 V DC and Ie = 1 mA Failure rate &lt; 10<sup>-8</sup></p> <p>Direct Current - <b>R300</b> Continuous Current - 1 amp Rated Voltage - 300Vdc</p>	IEC 60947-5-1 IEC 60947-5-4
Voltage	Max. Amps		Voltage	Max. Amps																											
	Make	Break		Make	Break																										
72	30	5.0	24	1.0	1.0																										
120	30	3.0	125	0.22	0.22																										
240	15	1.5	250	0.11	0.11																										
▶ Electrical operating life	<p><b>1 million cycles for:</b> - AC15 - B 300 Ue = 120 V, Ie = 3 A Ue = 240 V, Ie = 1,5 A</p> <p>- DC13 - R 300 Ue = 125 V, Ie = 0.22 A Ue = 250 V, Ie = 0.1 A</p>																														
▶ Pin diameter	∅ 1 mm																														

## Technical Specifications

### ▶ LED BLOCKS FOR ILLUMINATED HEADS

Characteristics	Data	Standards
▶ Rated insulation voltage	300 V	IEC/EN 60947-5-1
▶ Rated impulse voltage Uimp Pollution degree	4 kV (with filter block see p. 70) 3	IEC/EN 60947-1
▶ Operating voltage	12 to 24 V AC/DC 48 V AC/DC (for LED block) 130 V AC 230 V AC	
▶ Frequency	50 or 60 Hz	
▶ Lifetime at rated supply voltage	Red and yellow: 100 000 hours at 25 °C Other colors: 50 000 hours at 25 °C	
▶ Consumption of LED blocks	Voltage:	- 24 V: 25 mA ± 20% - 48 V: 15 mA ± 5% - 130 V: 20 mA ± 10% - 230 V: 16 mA ± 30%

### ▶ ONE PIECE PILOT LIGHT WITH INTEGRATED LED

Characteristics	Data	Standards
▶ Rated insulation voltage	300 V	IEC 60947-5-1
▶ Rated impulse withstand voltage Uimp	4 kV	IEC/EN 60947-1
▶ Bulb rating	400 V max. - 2.6 W max. 240 V max. - 2.6 W max.	IEC 60947-5-1 UL 508
▶ Lifetime at rated supply voltage	Red: 100 000 hours at 25 °C Other colors: 50 000 hours at 25 °C	

## Technical Specifications

### ▶ USB INTERFACE 3.0

Characteristics	Data	Standards
▶ Rated insulation voltage	5 V AC/DC	IEC 60947-5-1
▶ Rated Current	1.8 A	IEC 60947-5-1
▶ Insulation resistance	≥ 100 M	
▶ Contact resistance	≤ 30 M	
▶ USB Class	3.0 (backward compatible with USB class 2.0)	
▶ Data Transmission	5 Gbps (625 MB/sec)	
▶ Recommended Fixing Tool	Tightening flat wrench size 26mm	

### ▶ AUDIBLE WARNING BUZZERS

Characteristics	Data	Standards
▶ Supply Voltage	18 to 30 V AC/DC 85 to 140 V AC/DC 185 to 265 V AC/DC	IEC 60947-5-1
▶ Rated impulse voltage Uimp	4 KV	IEC 60947-5-1
▶ Sound Power	80 dB @ 10cm	
▶ Frequency	50 or 60 Hz	
▶ Maximum power consumption	≤ 20 mA	
▶ Lifetime at rated supply voltage	30,000 hours (continuously powered)	
▶ Recommended Fixing Tool	Tightening flat wrench size 26mm	
▶ Wiring Connections	Pulse Tone - Wire terminals 1 and C Continuous Tone - Wire terminals 3 and C	



# Technical Specifications

## ▶ PANEL CUT-OUT

### DRILLING

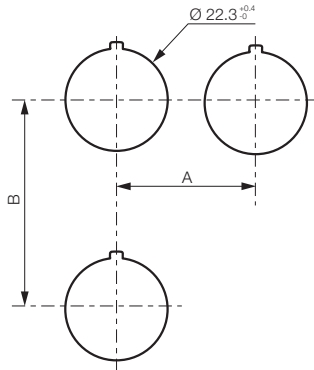

For heads equipped with electrical blocks with screw or plug-in terminals

#### Minimum interval (mm)

	= 30	With or without legend (usual case)
	= 33	IP 67 (silicon shroud)
	= 40	With large legend plate
A	> 40	For mushroom head $\varnothing$ 40
	> 45	For selector switch with long handle
	= 38	For super-flush button
	= 50	With 5 position clip
B	= 45	With or without legend plate (usual case)
	= 54	With double touch
	= 77	With double touch + legend plate
	= 50	Joystick

### DRILLING FOR SUPER-FLUSH BUTTON

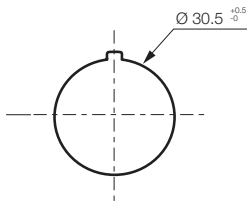

### DRILLING WHEN USING THE ANTI-ROTATION RING (OPTIONAL)

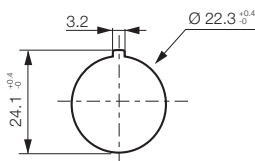

### THICKNESS OF PANEL (E)

E = 1 to 6 mm

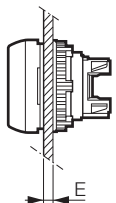

# Technical Specifications

## NON-ILLUMINATED

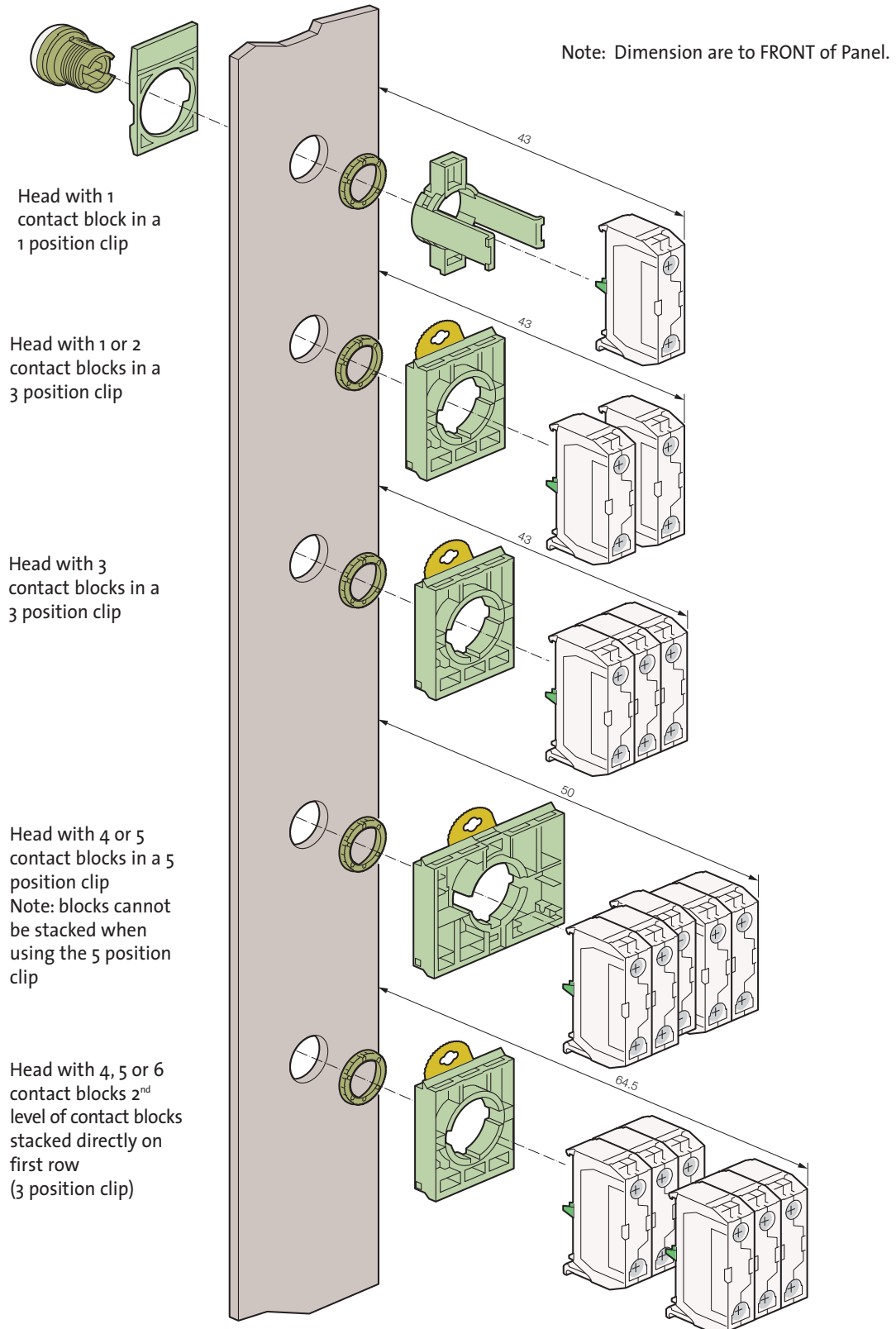

# Technical Specifications

## ILLUMINATED

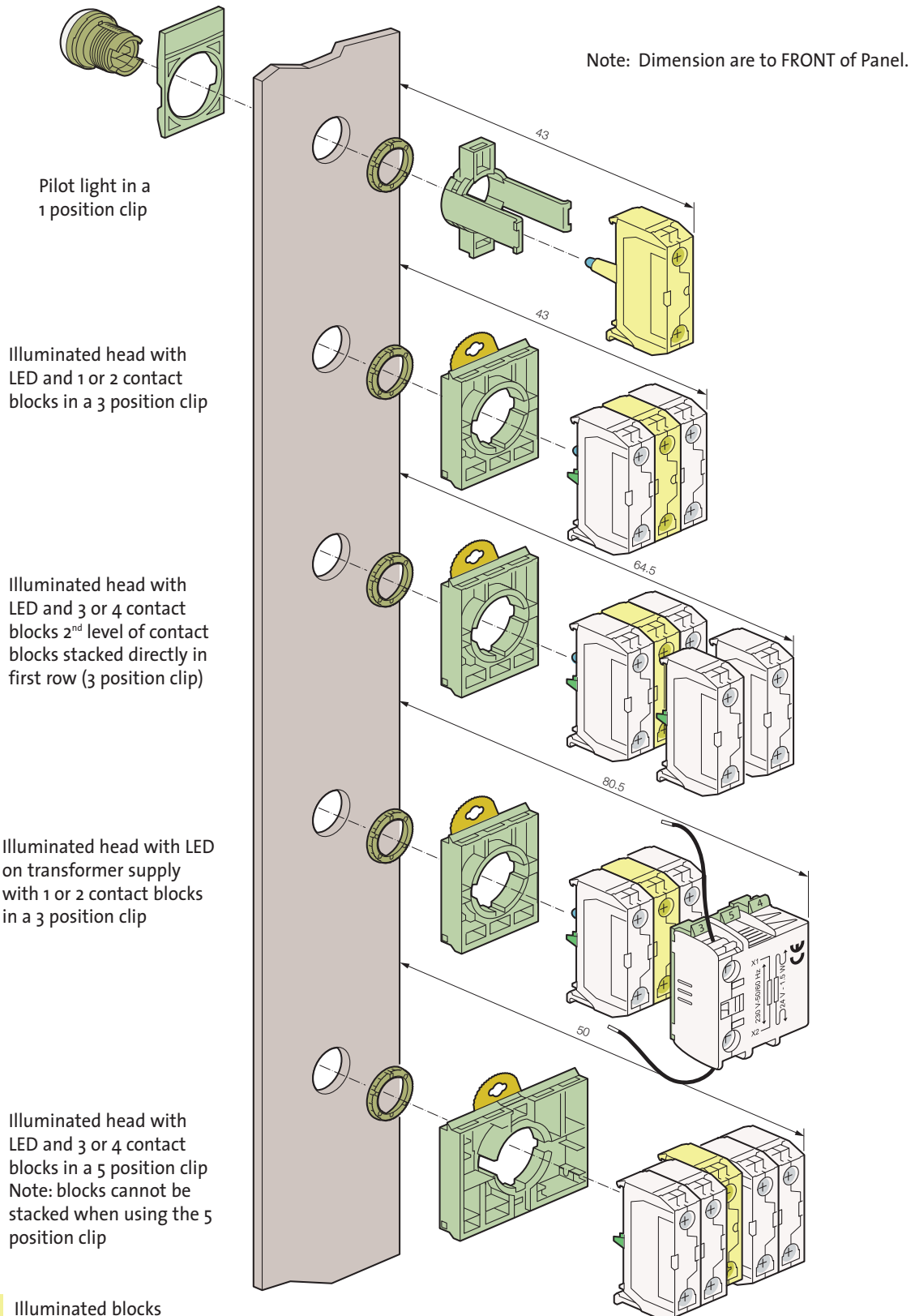

# Technical Specifications

## MECHANICAL OPERATION - 2 POSITION SELECTOR SWITCHES

For 2 position selector switches

**Handle position**  
(view from front of panel)

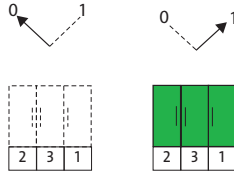

**Contacts block actuation**  
(clip position)

Non operated block



Operated block



333E10			
MODULE PART No.	CLIP POSITION	0	1
33E10	1	O	X

333E01			
MODULE PART No.	CLIP POSITION	0	1
33E01	2	X	O

333E11			
MODULE PART No.	CLIP POSITION	0	1
33E10	1	O	X
33E01	2	X	O

333E20			
MODULE PART No.	CLIP POSITION	0	1
33E10	1	O	X
33E10	2	O	X

333E02			
MODULE PART No.	CLIP POSITION	0	1
33E01	1	X	O
33E01	2	X	O

333E12			
MODULE PART No.	CLIP POSITION	0	1
33E10	1	O	X
33E01	2	X	O
33E01	3	X	O

333E30			
MODULE PART No.	CLIP POSITION	0	1
33E10	1	O	X
33E10	2	O	X
33E10	3	O	X

333E03			
MODULE PART No.	CLIP POSITION	0	1
33E01	1	X	O
33E01	2	X	O
33E01	3	X	O

333E21			
MODULE PART No.	CLIP POSITION	0	1
33E10	1	O	X
33E01	2	X	O
33E10	3	O	X

333E22			
MODULE PART No.	CLIP POSITION	0	1
33E10	1	O	X
33E10	2	O	X
33E01	4	X	O
33E01	5	X	O

334E22			
MODULE PART No.	CLIP POSITION	0	1
33E11	1	O	X
		X	O
33E11	2	O	X
		X	O

335E22A			
MODULE PART No.	CLIP POSITION	0	1
33E01	1	X	O
33E01	2	X	O
33E10	4	O	X
33E10	5	O	X

333E33			
MODULE PART No.	CLIP POSITION	0	1
33E10	1	O	X
33E10	2	O	X
33E10	3	O	X
33E01	4	X	O
33E01	5	X	O
33E01	6	X	O

# Technical Specifications

## MECHANICAL OPERATION - 3 POSITION SELECTOR SWITCHES

For 3 position selector switches

**Handle position**  
(view from front of panel)

**Contacts block actuation**  
(clip position)

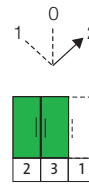
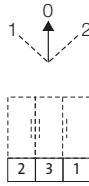
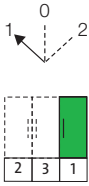

Non operated block



Operated block



333E20				
MODULE PART No.	CLIP POSITION	1	0	2
33E10	1	X	O	O
33E10	2	O	O	X

333E02				
MODULE PART No.	CLIP POSITION	1	0	2
33E01	1	O	X	X
33E01	2	X	X	O

333E11				
MODULE PART No.	CLIP POSITION	1	0	2
33E10	1	X	O	O
33E01	2	X	X	O

333E11A				
MODULE PART No.	CLIP POSITION	1	0	2
33E01	1	O	X	X
33E10	2	O	O	X

333E30				
MODULE PART No.	CLIP POSITION	1	0	2
33E10	1	X	O	O
33E10	2	O	O	X
33E10	3	O	O	X

334E22				
MODULE PART No.	CLIP POSITION	1	0	2
33E11	1	X	O	O
		O	X	X
33E11	2	O	O	X
		X	X	O

333E22				
MODULE PART No.	CLIP POSITION	1	0	2
33E10	1	X	O	O
33E10	2	O	O	X
33E01	4	O	X	X
33E01	5	X	X	O

335E22A				
MODULE PART No.	CLIP POSITION	1	0	2
33E01	1	O	X	X
33E01	2	X	X	O
33E10	4	O	O	X
33E10	5	X	O	O

# Technical Specifications

## MECHANICAL OPERATION - TWIN/TRIPLE TOUCH

For twin/triple touch switches

**Operator View**  
(highlighted button is depressed)



**Contacts block actuation**  
(clip position)

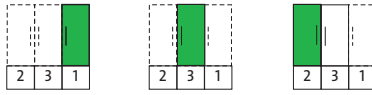

Non operated block



Operated block



## MECHANICAL OPERATION - JOYSTICKS

For Joysticks

### 2 position

**TWO BLOCK CLIP (LME3 - STANDARD WITH JOYSTICK HEAD)**

LM11 in Clip Location	Terminal Numbers	Position		
		A	O	B
1	3-4	X	O	O
	1-2	O	O	X
2	3-4	O	O	X
	1-2	X	O	O

A  
|  
O  
|  
B

### 4 position

**TWO BLOCK CLIP (LME3 - STANDARD WITH JOYSTICK HEAD)**

LM11 in Clip Location	Terminal Numbers	Position				
		A	B	O	C	D
1	3-4	O	O	O	O	X
	1-2	O	O	O	X	O
2	3-4	O	X	O	O	O
	1-2	X	O	O	O	O

A  
|  
C - O - D  
|  
B

**FOUR BLOCK CLIP (LME5)**

LM11 in Clip Location	Terminal Numbers	Position		
		A	O	B
1	3-4	X	O	O
	1-2	O	O	X
2	3-4	O	O	X
	1-2	X	O	O
3	3-4	X	O	O
	1-2	O	O	X
4	3-4	O	O	X
	1-2	X	O	O

A  
|  
O  
|  
B

**FOUR BLOCK CLIP (LME5)**

LM11 in Clip Location	Terminal Numbers	Position				
		A	B	O	C	D
1	3-4	O	O	O	O	X
	1-2	O	O	O	X	O
2	3-4	O	X	O	O	O
	1-2	X	O	O	O	O
3	3-4	O	O	O	O	X
	1-2	O	O	O	X	O
4	3-4	O	X	O	O	O
	1-2	X	O	O	O	O

A  
|  
C - O - D  
|  
B

# Technical Specifications

## ▶ DIAGRAMS

### PUSH-TO-TEST LED PILOT LIGHT DIAGRAMS

Lamp-testing module with 1 diode (33ET) for direct supply 24 V and 48V

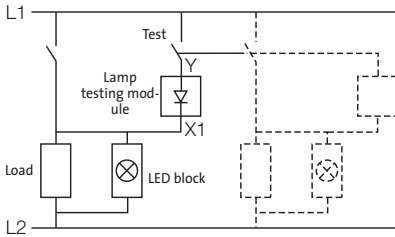

Lamp-testing module with 2 diodes (33ETT) for direct supply 24 V and 48 V

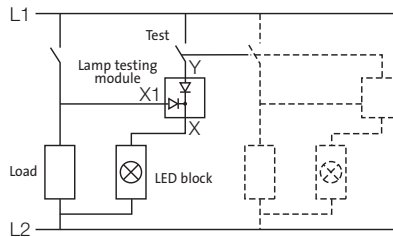

Lamp-testing assembly for direct supply 130 V and 240 V

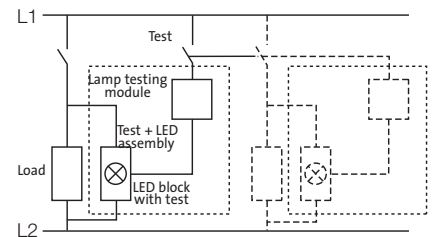

### PRINTED CIRCUIT BOARD MOUNTING

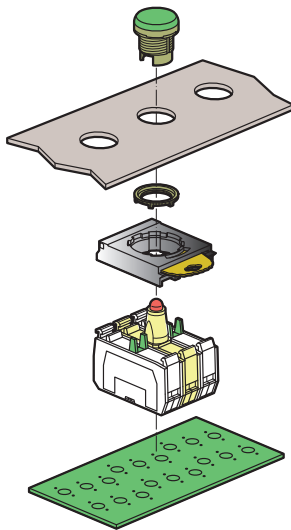

### PCB BOARD DRILL PLAN

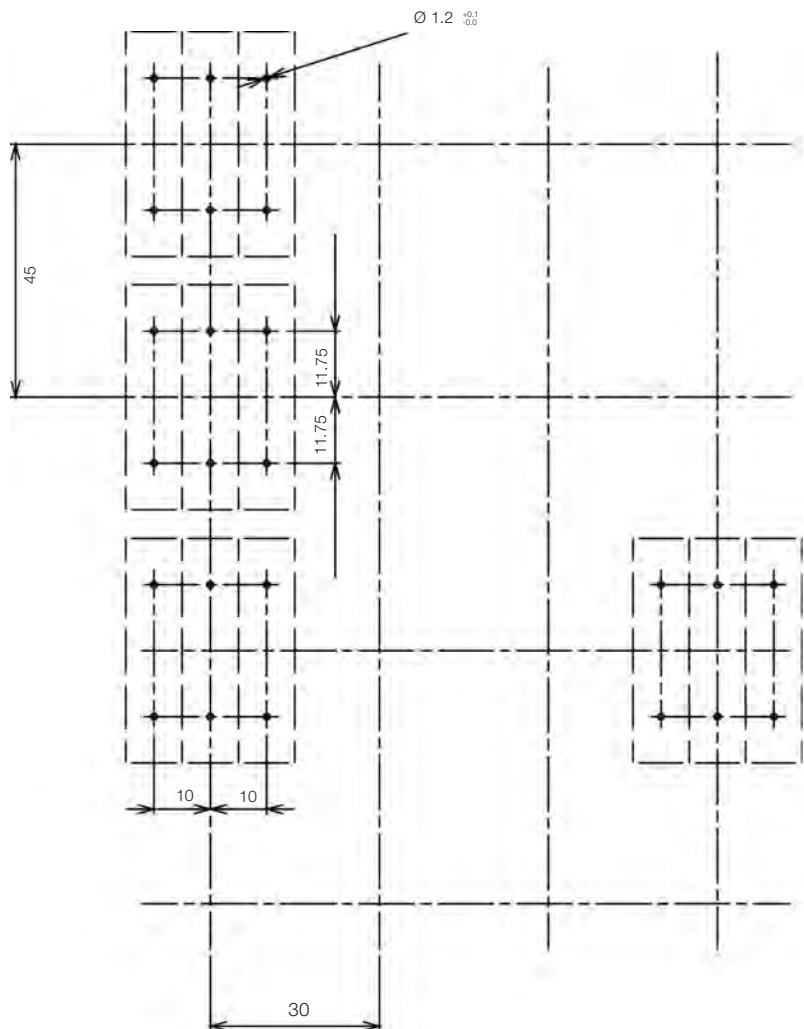

### PCB TERMINAL - SINGLE CLIP

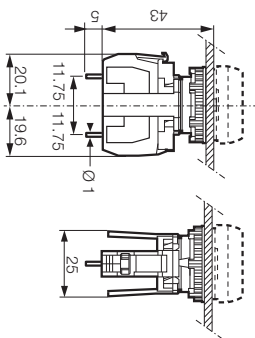

### PCB TERMINAL - 3 POSITION CLIP

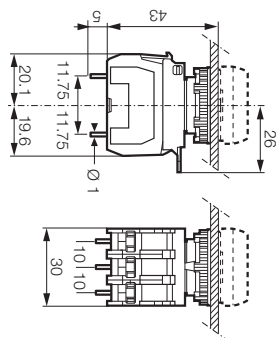

# Baco simplifies your choice

---



--- **AA** -- definition of **function**

**T11** AA -- choice of **bezel**

T11 AA **02** color of **head**

## ▶ HEAD COLOR CODES

---

01 ● red	04 ● yellow
02 ● green	05 ○ white
03 ● black	06 ● blue

## ▶ BEZEL CODES

---

T11	chrome brilliant plastic
T12	black plastic
T13	grey plastic
T14	Chrome brass
T16	Matt chrome plastic

## ▶ ADVANTAGES

---

- Ø 30 heads use the same clips and blocks as Ø 22 heads
- Fully compatible with the new Ø 22 range
- Wide choice of bezels



# Complete units: Part Numbering System

## ► NON-ILLUMINATED COMPLETE UNITS

T11AA01 - **3** **E** **1** **1** **Y7**  
a b c d e

Part number of non-illuminated operator head.  
 See pages 133 to 139 for non-illuminated operator heads.

*a*

CLIP	
Code	Description
1	single module
3	three modules
4	three modules (when using 33E11 contact blocks)
5	five modules

*b*

TERMINAL STYLE	
Code	Description
E	Screw and Clamp
ED	Stab (Quick Connect)
EP	PCB
ER	Plug In

*c*

N.O. (NORMALLY OPEN) CONTACTS	
Code	Description
0	No Contact
1	1 N.O.
2	2 N.O.
3	3 N.O.
4	4 N.O.
5	5 N.O.
6	6 N.O.

*d*

N.C. (NORMALLY CLOSED) CONTACTS	
Code	Description
0	No Contact
1	1 N.C.
2	2 N.C.
3	3 N.C.
4	4 N.C.
5	5 N.C.
6	6 N.C.

*e*

SPECIALTY BLOCKS	
Code	Description
C	Late Break N.C. (Screw and Clamp terminals only)
Y7	Gold Plated Contacts (Screw and Clamp or PCB terminals only)

## Complete units: Pushbuttons $\phi$ 30MM

### ► SPRING RETURN - NON-ILLUMINATED



Technical Info (p. 154)

#### FLUSH

Chrome Bezel  
Part Number



T11AA02-3E10

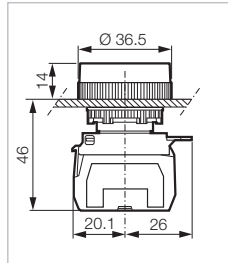

● Red	NC
● Green	NO
● Black	NC
● Black	NO
● Yellow	NO
○ White	NO
● Blue	NO

T11AA01-3E01
T11AA02-3E10
T11AA03-3E01
T11AA03-3E10
T11AA04-3E10
T11AA05-3E10
T11AA06-3E10

● Red	NO + NC
● Green	NO + NC
● Black	NO + NC
● Yellow	NO + NC
○ White	NO + NC
● Blue	NO + NC

T11AA01-3E11
T11AA02-3E11
T11AA03-3E11
T11AA04-3E11
T11AA05-3E11
T11AA06-3E11

#### WITH INTERNATIONAL SYMBOLS

Ⓡ Red	NC
Ⓢ Green	NO

T11AA81-3E01
T11AA82-3E10

#### FLUSH WITH DEEP COLLAR



T15AA03-3E10

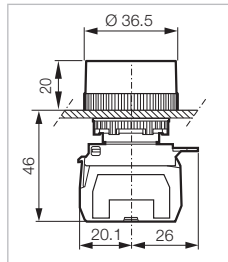

● Red	NC
● Green	NO
● Black	NC
● Black	NO
● Yellow	NO
○ White	NO
● Blue	NO

T15AA01-3E01
T15AA02-3E10
T15AA03-3E01
T15AA03-3E10
T15AA04-3E10
T15AA05-3E10
T15AA06-3E10

#### PROJECTING



T11AB01-3E01

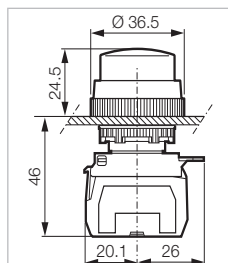

● Red	NC
● Green	NO
● Black	NO
● Yellow	NO
○ White	NO
● Blue	NO

T11AB01-3E01
T11AB02-3E10
T11AB03-3E10
T11AB04-3E10
T11AB05-3E10
T11AB06-3E10

# Complete units: Pushbuttons $\phi$ 30MM

## ► SPRING RETURN - NON-ILLUMINATED

 Technical Info (p.154)

### $\phi$ 40 MUSHROOM

Chrome Bezel  
Part Number



T11AD01-3E01

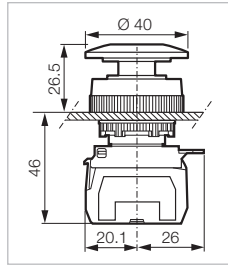

● Red	NC	T11AD01-3E01
● Green	NO	T11AD02-3E10
● Black	NC	T11AD03-3E01
● Black	NO	T11AD03-3E10
● Yellow	NO	T11AD04-3E10
● Red	NO + NC	T11AD01-3E11
● Green	NO + NC	T11AD02-3E11
● Black	NO + NC	T11AD03-3E11
● Yellow	NO + NC	T11AD04-3E11

### $\phi$ 70 MUSHROOM



T11AE01-3E01

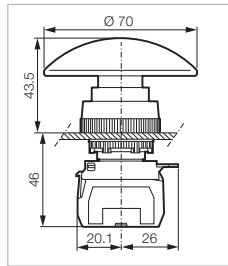

● Red	NC	T11AE01-3E01
● Black	NC	T11AE03-3E01
● Black	NO	T11AE03-3E10

## ► MAINTAINED - NON-ILLUMINATED

### PROJECTING



T11CB02-3E10

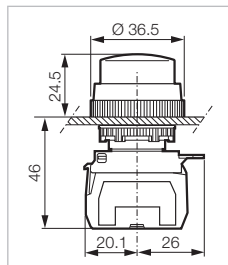

● Red	NC	T11CB01-3E01
● Green	NO	T11CB02-3E10
● Black	NC	T11CB03-3E01
● Black	NO	T11CB03-3E10
● Yellow	NO	T11CB04-3E10
○ White	NO	T11CB05-3E10
● Blue	NO	T11CB06-3E10

# Complete units: Mushroom heads $\varnothing$ 30mm

## ▶ MAINTAINED - NON-ILLUMINATED

 Technical Info (p. 154)

### $\varnothing$ 40 MUSHROOM

Push-pull to reset

Chrome Bezel  
Part Number

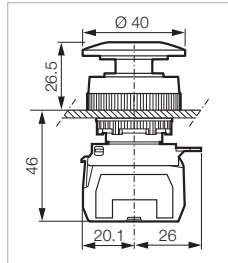

- Red NC
- Red 2 NC
- Red NO + NC

**WITH TEXT**

- Red (STOP STOP STOP) NC
- Red (STOP STOP STOP) 2 NC
- Red (STOP STOP STOP) NO + NC

- T11DD01-3E01
- T11DD01-3E02
- T11DD01-3E11

T11DD01-3E01

### $\varnothing$ 40 MUSHROOM

Push-turn to reset

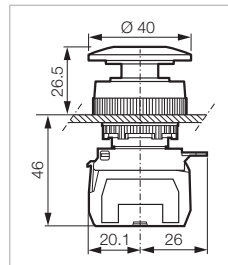

- Red NC
- Red 2 NC
- Red NO + NC

**WITH TEXT**

- Red (STOP STOP STOP) NC
- Red (STOP STOP STOP) 2 NC
- Red (STOP STOP STOP) NO + NC

- T11ED01-3E01
- T11ED01-3E02
- T11ED01-3E11

T11ED01-3E11

### $\varnothing$ 40 MUSHROOM

Key to reset

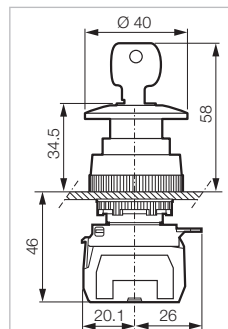

Supplied with 2 keys profile n° 455

- Red NC
- Red 2 NC
- Red NO + NC

- T11GM01-3E01
- T11GM01-3E02
- T11GM01-3E11

T11GM01-3E02

# Complete units: Selector switches $\varnothing$ 30MM

## ▶ SELECTOR SWITCHES - NON-ILLUMINATED

 Technical Info (p. 154)

### WITH HANDLE

### 2 positions

Chrome Bezel  
Part Number



T11KA03-3E10

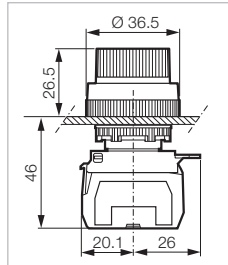

#### Maintained positions - 45°

● Red		NC
● Black		NO
● Black		2 NO
● Black		NO + NC
● Grey		NO

T11KA01-3E01
T11KA03-3E10
T11KA03-3E20
T11KA03-3E11
T11KA08-3E10

#### Spring Return - 45°

● Red		NC
● Black		NO
● Black		2 NO
● Black		NO + NC
● Grey		NO

T11KB01-3E01
T11KB03-3E10
T11KB03-3E20
T11KB03-3E11
T11KB08-3E10

#### Maintained positions - 90°

● Red		NC
● Black		NO
● Black		2 NO
● Black		NO + NC
● Grey		NO

T11KE01-3E01
T11KE03-3E10
T11KE03-3E20
T11KE03-3E11
T11KE08-3E10

### WITH HANDLE

### 3 positions



T11MA03-3E20

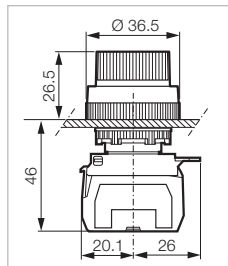

#### Maintained positions - 45°

● Red		2 NO
● Black		2 NO
● Grey		2 NO

T11MA01-3E20
T11MA03-3E20
T11MA08-3E20

#### Spring return - 45°

● Red		2 NO
● Black		2 NO
● Grey		2 NO

T11MD01-3E20
T11MD03-3E20
T11MD08-3E20

#### Maintained / Spring Return - 45°

● Red		NO + NC
● Black		NO + NC
● Grey		NO + NC

T11MC01-3E11
T11MC03-3E11
T11MC08-3E11

# Complete units: Selector switches $\varnothing$ 30MM

 Technical Info (p. 154)

## ▶ SELECTOR SWITCHES - NON-ILLUMINATED

WITH KEY

2 positions

Chrome Bezel  
Part Number



T11LA00-3E10

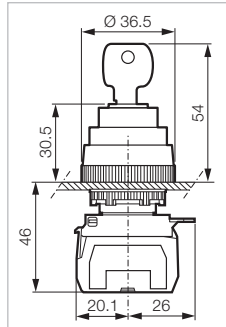

Supplied with 2 keys profile n°455

Maintained positions - 45°  
Key free in position 0

- Black NO
- Black 2 NO
- Black NO + NC



T11LA00-3E10  
T11LA00-3E20  
T11LA00-3E11

Spring Return - 45°  
Key free in position 0

- Black NO
- Black 2 NO
- Black NO + NC



T11LB00-3E10  
T11LB00-3E20  
T11LB00-3E11

Maintained - 90°  
Key free in both positions

- Black NO
- Black 2 NO
- Black NO + NC



T11LG00-3E10  
T11LG00-3E20  
T11LG00-3E11

WITH KEY

3 positions



T11NA00-3E20

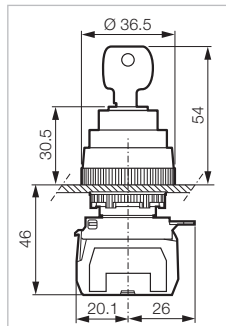

Supplied with 2 keys profile n°455

Maintained positions - 45°  
Key free in position 0

- Black 1 NO 2 NO



T11NA00-3E20

Spring Return - 45°  
Key free in position 0

- Black 1 NO 2 NO



T11ND00-3E20

# Complete units: Part Numbering System

## ► ILLUMINATED COMPLETE UNITS

T11AH20 - **3** **EA** **G** **M** **1** **1** **Y7**  
a b c d e f g

Part number of illuminated operator head.  
 See pages 141 to 144 for illuminated operator heads.

*a*

CLIP	
Code	Description
1	single module
3	three modules
4	three modules (when using 33E11 contact blocks)
5	five modules

*b*

TERMINAL STYLE	
Code	Description
EA	Screw and Clamp
EDA	Stab (Quick Connect)
EPA	PCB
ERA	Plug In

*c*

LED COLOR	
Code	Description
R	Red
G	Green
Y	Yellow
W	White
B	Blue

*d*

LED VOLTAGE	
Code	Description
L	12/24 Vac/dc
L4	48 Vac/dc
M	130 Vac
H	230 Vac

*e*

N.O. (NORMALLY OPEN) CONTACTS	
Code	Description
o	No Contact
1	1 N.O.
2	2 N.O.
3	3 N.O.
4	4 N.O.

*f*

N.C. (NORMALLY CLOSED) CONTACTS	
Code	Description
o	No Contact
1	1 N.C.
2	2 N.C.
3	3 N.C.
4	4 N.C.

*g*

SPECIALTY BLOCKS	
Code	Description
C	Late Break N.C. (Screw and Clamp terminals only)
Y7	Gold Plated Contacts (Screw and Clamp or PCB terminals only)

# Complete units: Pushbuttons $\varnothing$ 30MM

## ► SPRING RETURN - ILLUMINATED

 Technical Info (p.154)

### FLUSH

Chrome Bezel  
Part Number



T11AH20-3EAGL1

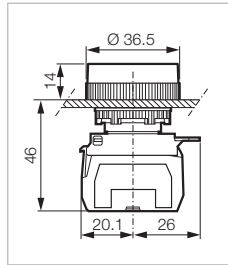

LED blocks  
12/24 Vac/dc

- Red NO+NC
- Green NO+NC
- Clear NO+NC
- Yellow NO+NC
- White NO+NC
- Blue NO+NC

- T11AH10-3EARL11
- T11AH20-3EAGL11
- T11AH30-3EAWL11
- T11AH40-3EAYL11
- T11AH50-3EAWL11
- T11AH60-3EABL11

130 Vac

- Red NO+NC
- Green NO+NC
- Clear NO+NC
- Yellow NO+NC
- White NO+NC
- Blue NO+NC

- T11AH10-3EARM11
- T11AH20-3EAGM11
- T11AH30-3EAWM11
- T11AH40-3EAYM11
- T11AH50-3EAWM11
- T11AH60-3EABM11

### FLUSH



T15AH10-3EARL11

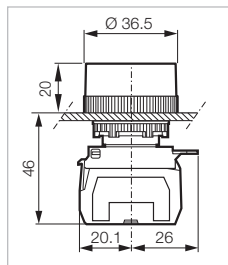

LED blocks  
12/24 Vac/dc

- Red NO+NC
- Green NO+NC
- Clear NO+NC
- Yellow NO+NC
- White NO+NC
- Blue NO+NC

- T15AH10-3EARL11
- T15AH20-3EAGL11
- T15AH30-3EAWL11
- T15AH40-3EAYL11
- T15AH50-3EAWL11
- T15AH60-3EABL11

130 Vac

- Red NO+NC
- Green NO+NC
- Clear NO+NC
- Yellow NO+NC
- White NO+NC
- Blue NO+NC

- T15AH10-3EARM11
- T15AH20-3EAGM11
- T15AH30-3EAWM11
- T15AH40-3EAYM11
- T15AH50-3EAWM11
- T15AH60-3EABM11

### PROJECTING



T11AK40-3EAYM11

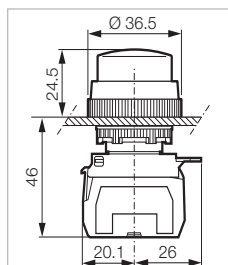

LED blocks  
12/24 Vac/dc

- Red NO+NC
- Green NO+NC
- Clear NO+NC
- Yellow NO+NC
- White NO+NC
- Blue NO+NC

- T11AK10-3EARL11
- T11AK20-3EAGL11
- T11AK30-3EAWL11
- T11AK40-3EAYL11
- T11AK50-3EAWL11
- T11AK60-3EABL11

130 Vac

- Red NO+NC
- Green NO+NC
- Clear NO+NC
- Yellow NO+NC
- White NO+NC
- Blue NO+NC

- T11AK10-3EARM11
- T11AK20-3EAGM11
- T11AK30-3EAWM11
- T11AK40-3EAYM11
- T11AK50-3EAWM11
- T11AK60-3EABM11



# Complete units: Pushbuttons $\phi$ 30MM

## ► SPRING RETURN - ILLUMINATED

 Technical Info (p.154)

### $\phi$ 40 MUSHROOM

Chrome Bezel  
Part Number



T11AM10-3EARL11

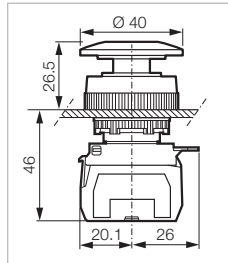

#### LED blocks

##### 12/24 Vac/dc

● Red	NO+NC	T11AM10-3EARL11
● Green	NO+NC	T11AM20-3EAGL11
● Yellow	NO+NC	T11AM40-3EAYL11
○ White	NO+NC	T11AM50-3EAWL11
● Blue	NO+NC	T11AM60-3EABL11

##### 130 Vac

● Red	NO+NC	T11AM10-3EARM11
● Green	NO+NC	T11AM20-3EAGM11
● Yellow	NO+NC	T11AM40-3EAYM11
○ White	NO+NC	T11AM50-3EAWM11
● Blue	NO+NC	T11AM60-3EABM11

## ► MAINTAINED - ILLUMINATED

### PROJECTING



T11CK20-3EAGL11

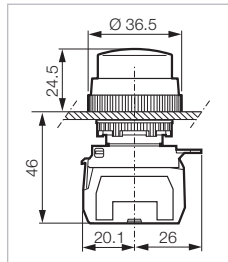

#### LED blocks

##### 12/24 Vac/dc

● Red	NO+NC	T11CK10-3EARL11
● Green	NO+NC	T11CK20-3EAGL11
● Yellow	NO+NC	T11CK40-3EAYL11
○ White	NO+NC	T11CK50-3EAWL11
● Blue	NO+NC	T11CK60-3EABL11

##### 130 Vac

● Red	NO+NC	T11CK10-3EARM11
● Green	NO+NC	T11CK20-3EAGM11
● Yellow	NO+NC	T11CK40-3EAYM11
○ White	NO+NC	T11CK50-3EAWM11
● Blue	NO+NC	T11CK60-3EABM11

##### 230 Vac

● Red	NO+NC	T11CK10-3EARH11
● Green	NO+NC	T11CK20-3EAGH11
● Yellow	NO+NC	T11CK40-3EAYH11
○ White	NO+NC	T11CK50-3EAWH11
● Blue	NO+NC	T11CK60-3EABH11

# Complete units: Selector switches $\phi$ 30mm

## ▶ SELECTOR SWITCHES - ILLUMINATED

 Technical Info (p.154)

WITH HANDLE

2 positions

Chrome Bezel  
Part Number



T1KG10-3EARL11

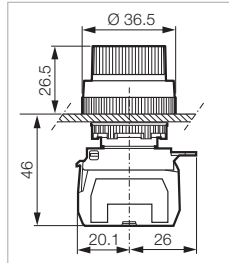

Maintained positions - 45°

12/24 Vac/Dc

- Red
- Green
- White



- NO + NC
- NO + NC
- NO + NC

- T11KG10-3EARL11
- T11KG20-3EAGL11
- T11KG50-3EAWL11

130 Vac

- Red
- Green
- White

- NO + NC
- NO + NC
- NO + NC

- T11KG10-3EARM11
- T11KG20-3EAGM11
- T11KG50-3EAWM11

Spring Return - 45°

12/24 Vac/Dc

- Red
- Green
- White



- NO + NC
- NO + NC
- NO + NC

- T11KK10-3EARL11
- T11KK20-3EAGL11
- T11KK50-3EAWL11

130 Vac

- Red
- Green
- White

- NO + NC
- NO + NC
- NO + NC

- T11KK10-3EARM11
- T11KK20-3EAGM11
- T11KK50-3EAWM11

Maintained positions - 90°

12/24 Vac/Dc

- Red
- Green
- White



- NO + NC
- NO + NC
- NO + NC

- T11KM10-3EARL11
- T11KM20-3EAGL11
- T11KM50-3EAWL11

130 Vac

- Red
- Green
- White

- NO + NC
- NO + NC
- NO + NC

- T11KM10-3EARM11
- T11KM20-3EAGM11
- T11KM50-3EAWM11

# Complete units: Selector switches $\phi$ 30MM

## ▶ SELECTOR SWITCHES - ILLUMINATED

 Technical Info (p. 154)

WITH HANDLE

3 positions

Chrome Bezel  
Part Number



T11ME20-3EAGL20

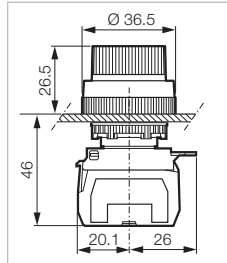

Maintained positions - 45°

12/24 Vac/dc

- Red
- Green
- White



- 2 NO
- 2 NO
- 2 NO

- T11ME10-3EARL20
- T11ME20-3EAGL20
- T11ME50-3EAWL20

130 Vac/dc

- Red
- Green
- White

- 2 NO
- 2 NO
- 2 NO

- T11ME10-3EARM20
- T11ME20-3EAGM20
- T11ME50-3EAWM20

Maintained / Spring Return - 45°

12/24 Vac/dc

- Red
- Green
- White



- NO + NC
- NO + NC
- NO + NC

- T11MG10-3EARL11
- T11MG20-3EAGL11
- T11MG50-3EAWL11

130 Vac

- Red
- Green
- White

- NO + NC
- NO + NC
- NO + NC

- T11MG10-3EARM11
- T11MG20-3EAGM11
- T11MG50-3EAWM11

Spring Return - 45°

12/24 Vac/dc

- Red
- Green
- White



- 2 NO
- 2 NO
- 2 NO

- T11MH10-3EARL20
- T11MH20-3EAGL20
- T11MH50-3EAWL20

130 Vac

- Red
- Green
- White



- 2 NO
- 2 NO
- 2 NO

- T11MH10-3EARM20
- T11MH20-3EAGM20
- T11MH50-3EAWM20

# Complete units: Pilot lights $\varnothing$ 30mm

► PILOT LIGHTS

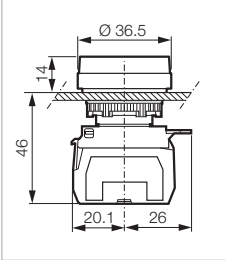
 Technical Info (p. 154)

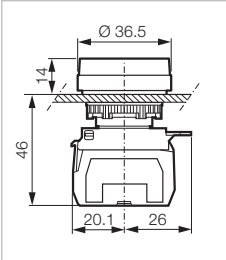
HEAD, CLIP AND MODULE		Ribbed Lens Part Number	Smooth Lens Part Number
 <p>T10SA10-3EARL</p>		<p><b>WITH THREE POSITION CLIP</b> <b>12/24 VAC/DC</b></p> <ul style="list-style-type: none"> <li>● Red</li> <li>● Green</li> <li>○ Clear</li> <li>● Yellow</li> <li>○ White</li> <li>● Blue</li> </ul>	
		<p><b>130 Vac</b></p> <ul style="list-style-type: none"> <li>● Red</li> <li>● Green</li> <li>○ Clear</li> <li>● Yellow</li> <li>○ White</li> <li>● Blue</li> </ul>	<p>T10SA10-3EARL T10SA20-3EAGL T10SA30-3EAWL T10SA40-3EAYL T10SA50-3EAWL T10SA60-3EABL</p>
 <p>T10SB20-3EAGM</p>		<p><b>230 Vac</b></p> <ul style="list-style-type: none"> <li>● Red</li> <li>● Green</li> <li>○ Clear</li> <li>● Yellow</li> <li>○ White</li> <li>● Blue</li> </ul>	
		<p><b>130 Vac</b></p> <ul style="list-style-type: none"> <li>● Red</li> <li>● Green</li> <li>○ Clear</li> <li>● Yellow</li> <li>○ White</li> <li>● Blue</li> </ul>	<p>T10SA10-3EARM T10SA20-3EAGM T10SA30-3EAWM T10SA40-3EAYM T10SA50-3EAWM T10SA60-3EABM</p>
		<p>T10SA10-3EARH T10SA20-3EAGH T10SA30-3EAWH T10SA40-3EAYH T10SA50-3EAWH T10SA60-3EABH</p>	<p>T10SB10-3EARH T10SB20-3EAGH T10SB30-3EAWH T10SB40-3EAYH T10SB50-3EAWH T10SB60-3EABH</p>

# Operator Heads: $\varnothing$ 30mm

## ► SPRING RETURN - NON-ILLUMINATED

 Technical Info (p. 154)

### FLUSH

Chrome Bezel  
Part Number



T11AA01

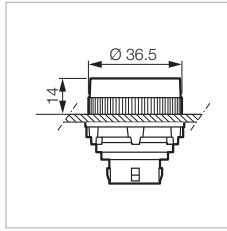

- Red
- Green
- Black
- Yellow
- White
- Blue

- T11AA01
- T11AA02
- T11AA03
- T11AA04
- T11AA05
- T11AA06

#### WITH INTERNATIONAL SYMBOL

-  Red
-  Green
-  Black

- T11AA81
- T11AA82
- T11AA83

### FLUSH WITH DEEP COLLAR



T15AA02

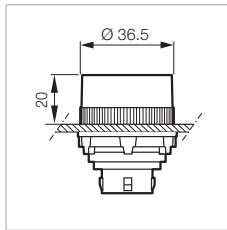

- Red
- Green
- Black
- Yellow
- White
- Blue

- T15AA01
- T15AA02
- T15AA03
- T15AA04
- T15AA05
- T15AA06

### FLUSH WITH SHROUD

Reinforced degree of protection: IP 67



T11AG03

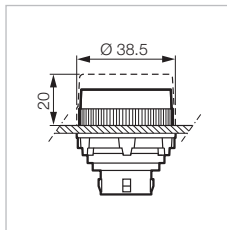

#### TRANSPARENT SHROUD

- Red
- Green
- Black
- Yellow
- White
- Blue

Components  
Operator + Shroud

- T11AA01 + UA0228
- T11AA02 + UA0228
- T11AA03 + UA0228
- T11AA04 + UA0228
- T11AA05 + UA0228
- T11AA06 + UA0228

- T11AG01
- T11AG02
- T11AG03
- T11AG04
- T11AG05
- T11AG06

### PROJECTING



T11AB01

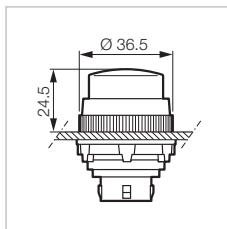

- Red
- Green
- Black
- Yellow
- White
- Blue

- T11AB01
- T11AB02
- T11AB03
- T11AB04
- T11AB05
- T11AB06

# Operator Heads: $\phi$ 30mm

## ► SPRING RETURN - NON-ILLUMINATED



Technical Info (p. 154)

### $\phi$ 40 MUSHROOM

Chrome Bezel  
Part Number

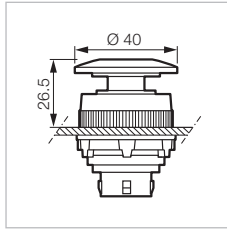

- Red
- Green
- Black
- Yellow

- T11AD01
- T11AD02
- T11AD03
- T11AD04

**WITH TEXT**

- Red (STOP STOP STOP)

T11AD01S

T11AD01

### $\phi$ 70 MUSHROOM

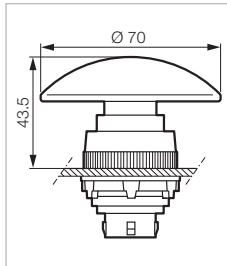

- Red - plastic
- Black - plastic

- T11AE01
- T11AE03

T11AE01

### FLUSH-FLUSH

### Twin touch

Black Bezel  
Part Number

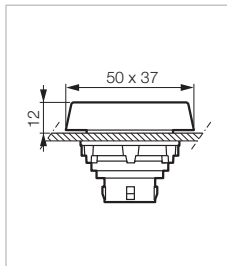

**WITH INTERNATIONAL SYMBOLS**

- Green
- Red

T52QA02

**WITH TEXT**

- Green (START)
- Red (STOP)

T52QA20

T52QA02

## ► MAINTAINED - NON-ILLUMINATED

### PROJECTING

Chrome Bezel  
Part Number

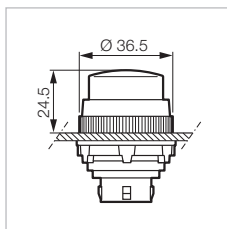

- Red
- Green
- Black
- Yellow
- White
- Blue

- T11CB01
- T11CB02
- T11CB03
- T11CB04
- T11CB05
- T11CB06

T11CB02

# Operator Heads: $\varnothing$ 30mm

## ► MAINTAINED - NON-ILLUMINATED

 Technical Info (p. 154)

**$\varnothing$  40 MUSHROOM** Chrome Bezel  
Part Number



T11DD01

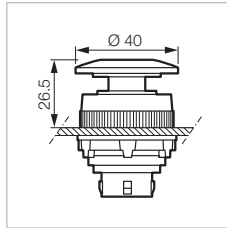

Push-pull to reset

- Red
- Green
- Black
- Yellow

- T11DD01
- T11DD02
- T11DD03
- T11DD04

WITH TEXT

- Red (STOP STOP STOP)

T11DD01S

## **$\varnothing$ 40 MUSHROOM**

Push-turn to reset



T11ED01

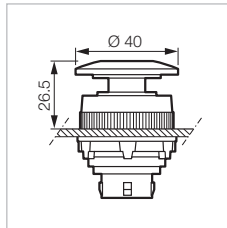

- Red
- Green
- Black
- Yellow

- T11ED01
- T11ED02
- T11ED03
- T11ED04

WITH TEXT

- Red (STOP STOP STOP)

T11ED01S

MANUAL LATCHING (Push in - Turn to Latch)

- Red
- Green
- Black
- Yellow

- T11FD01
- T11FD02
- T11FD03
- T11FD04

## **$\varnothing$ 40 MUSHROOM**

Key to reset



T11GM01

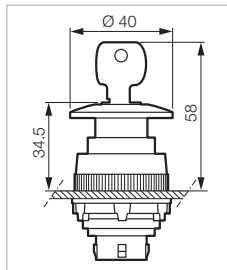

Supplied with 2 keys profile n°455

- Red

T11GM01

## **$\varnothing$ 70 MUSHROOM**

Key to reset



T11GP01

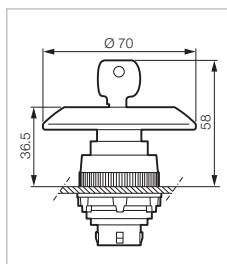

Supplied with 2 keys profile n°455

- Red

T11GP01

# Operator Heads: $\varnothing$ 30mm

## ▶ SELECTOR SWITCHES - NON-ILLUMINATED

 Technical Info (p. 154)

### WITH HANDLE

### 2 positions

Chrome Bezel  
Part Number



T11KA03

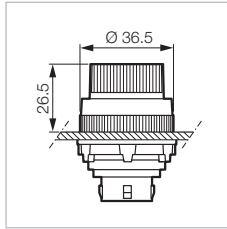

#### MAINTAINED POSITIONS - 45°

- Red
- Black
- Grey



T11KA01  
T11KA03  
T11KA08

#### SPRING RETURN - 45°

- Red
- Black
- Grey



T11KB01  
T11KB03  
T11KB08

#### MAINTAINED POSITIONS - 45°

- Red
- Black
- Grey



T11KC01  
T11KC03  
T11KC08

#### SPRING RETURN - 45°

- Red
- Black
- Grey



T11KD01  
T11KD03  
T11KD08

#### MAINTAINED POSITIONS - 90°

- Red
- Black
- Grey



T11KE01  
T11KE03  
T11KE08

#### MAINTAINED POSITIONS - 90°

- Red
- Black
- Grey



T11KF01  
T11KF03  
T11KF08

### WITH HANDLE

### 3 positions



T11MA01

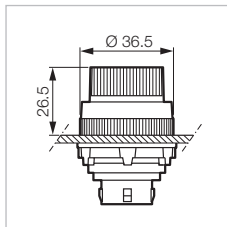

#### MAINTAINED POSITIONS - 45°

- Red
- Black
- Grey



T11MA01  
T11MA03  
T11MA08

#### SPRING RETURN FROM RIGHT TO 0 - 45°

- Red
- Black
- Grey



T11MC01  
T11MC03  
T11MC08

#### SPRING RETURN TO 0 - 45°

- Red
- Black
- Grey



T11MD01  
T11MD03  
T11MD08

#### MAINTAINED POSITIONS - 90°

- Red
- Black
- Grey



T11MK01  
T11MK03  
T11MK08



# Operator Heads: $\varnothing$ 30mm

## ▶ SELECTOR SWITCHES - NON-ILLUMINATED

 Technical Info (p.154)

### WITH HANDLE

2 positions

Chrome Bezel  
Part Number

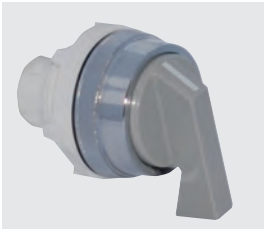

T11KP08

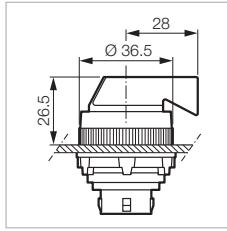

**MAINTAINED POSITIONS - 45°**

- Red
- Black
- Grey



T11KP01  
T11KP03  
T11KP08

**SPRING RETURN - 45°**

- Red
- Black
- Grey



T11KQ01  
T11KQ03  
T11KQ08

**MAINTAINED POSITIONS - 45°**

- Red
- Black
- Grey



T11KR01  
T11KR03  
T11KR08

**SPRING RETURN - 45°**

- Red
- Black
- Grey



T11KS01  
T11KS03  
T11KS08

**MAINTAINED POSITIONS - 90°**

- Red
- Black
- Grey



T11KT01  
T11KT03  
T11KT08

**MAINTAINED POSITIONS - 90°**

- Red
- Black
- Grey



T11KU01  
T11KU03  
T11KU08

### WITH HANDLE

3 positions



T11MR01

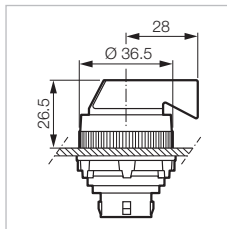

**MAINTAINED POSITIONS - 45°**

- Red
- Black
- Grey

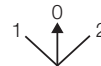

T11MR01  
T11MR03  
T11MR08

**SPRING RETURN FROM RIGHT TO 0 - 45°**

- Red
- Black
- Grey



T11MT01  
T11MT03  
T11MT08

**SPRING RETURN TO 0 - 45°**

- Red
- Black
- Grey



T11MU01  
T11MU03  
T11MU08

**MAINTAINED POSITIONS - 90°**

- Red
- Black
- Grey



T11MW01  
T11MW03  
T11MW08

# Operator Heads: $\varnothing$ 30mm

## ▶ SELECTOR SWITCHES - NON-ILLUMINATED



Technical Info (p. 154)

WITH KEY

2 positions

Chrome Bezel  
Part Number



T11LA00

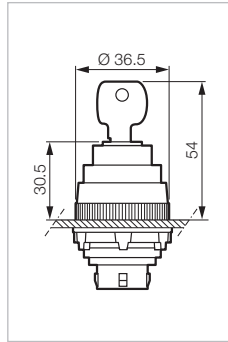

KEY FREE IN POSITION:

Supplied with 2 keys profile n° 455

**MAINTAINED POSITIONS - 45°**

● Black 0 **T11LA00**

**SPRING RETURN - 45°**

● Black 0 **T11LB00**

**MAINTAINED POSITIONS - 45°**

● Black 0 **T11LC00**

**SPRING RETURN - 45°**

● Black 0 **T11LD00**

**MAINTAINED POSITIONS - 90°**

● Black 0 - 1 **T11LG00**

**MAINTAINED POSITIONS - 90°**

● Black 0 **T11LF00**

FOR KEY PROFILE N° 1424A ADD SUFFIX "A" TO END OF PART NUMBERS (IE. T11LA00A)

WITH KEY

3 positions



T11NA00

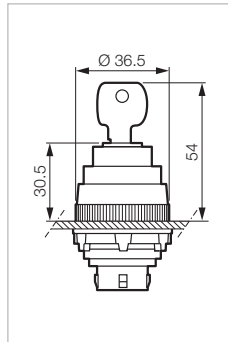

KEY FREE IN POSITION:

Supplied with 2 keys profile n° 455

**STAY-PUT POSITIONS - 45°**

● Black 0 **T11NA00**

**SPRING RETURN FROM RIGHT TO 0 - 45°**

● Black 0 **T11NC00**

**Spring return to 0 - 45°**

● Black 0 **T11ND00**

**STAY-PUT POSITIONS - 90°**

● Black 1 - 0 - 2 **T11NK00**

FOR KEY PROFILE N° 1424A ADD SUFFIX "A" TO END OF PART NUMBERS (IE. T11NA00A)

# Complete units: Part Numbering System

► SELECTOR SWITCHES - NON-ILLUMINATED

 Technical Info (p. 154)

WITH KEY

2 positions

Chrome Bezel  
Part Number



T11GM00

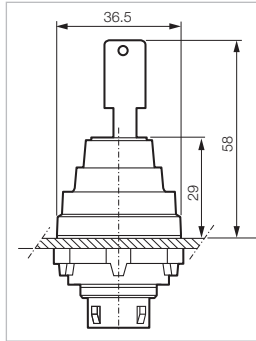

Supplied with 2 keys profile n° 455

LOCKABLE POSITION	KEY FREE IN:	
<b>MAINTAINED</b>		
In bottom position	Top and bottom position	<b>T11GM00</b>
<b>MANUAL LOCKING</b>		
In top position	Top and bottom position	<b>T11GF00</b>
In top position	Bottom position	<b>T11GJ00</b>
In bottom position	Top and bottom position	<b>T11GG00</b>
In bottom position	Bottom position	<b>T11GK00</b>
In top and bottom position	Top and bottom position	<b>T11GH00</b>
In top and bottom position	Bottom position	<b>T11GL00</b>

# Operator Heads: $\varnothing$ 30mm

## ► MECHANICAL ACTUATOR MOMENTARY - NON-ILLUMINATED

 Technical Info (p.154)

### ADJUSTABLE MECHANICAL ACTUATOR - FLUSH

Chrome Bezel  
Part Number

Black Bezel  
Part Number

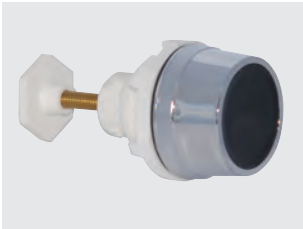

T11HA03

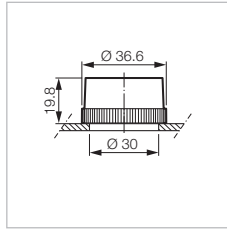

To be used without electrical block  
Stroke 12 mm  
Adjustable: 27 mm min to 47 mm max / front side of panel

- Red
- Green
- Black
- Yellow
- White
- Blue

T11HA01  
T11HA02  
T11HA03  
T11HA04  
T11HA05  
T11HA06

T12HA01  
T12HA02  
T12HA03  
T12HA04  
T12HA05  
T12HA06

### ADJUSTABLE MECHANICAL ACTUATOR - FLUSH WITH SHROUD

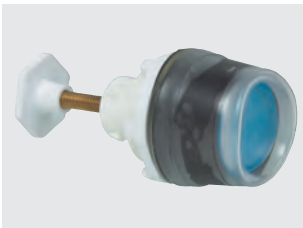

T12HG06

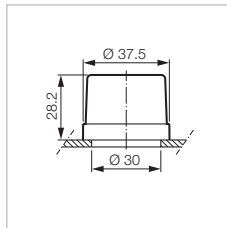

To be used without electrical block  
Stroke 12 mm  
Adjustable: 27 mm min to 47 mm max / front side of panel

- Red
- Green
- Black
- Yellow
- White
- Blue

T11HG01  
T11HG02  
T11HG03  
T11HG04  
T11HG05  
T11HG06

T12HG01  
T12HG02  
T12HG03  
T12HG04  
T12HG05  
T12HG06

### ADJUSTABLE MECHANICAL ACTUATOR - PROJECTING



T12HB05

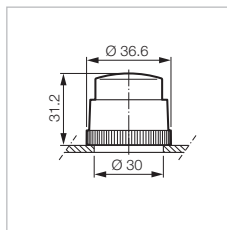

To be used without electrical block  
Stroke 12 mm  
Adjustable: 27 mm min to 47 mm max / front side of panel

- Red
- Green
- Black
- Yellow
- White
- Blue

T11HB01  
T11HB02  
T11HB03  
T11HB04  
T11HB05  
T11HB06

T12HB01  
T12HB02  
T12HB03  
T12HB04  
T12HB05  
T12HB06

### ADJUSTABLE MECHANICAL ACTUATOR - PROJECTING



907150RED

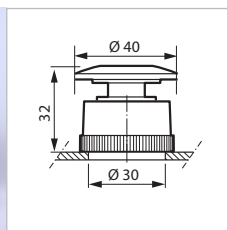

To be used without electrical block  
Stroke 8 mm  
Adjustable: 27 mm min to 47 mm max / front side of panel

- Red

907150RED

# Operator Heads: $\phi$ 30mm

## ► SPRING RETURN - ILLUMINATED

 Technical Info (p. 154)

### FLUSH

Chrome Bezel  
Part Number

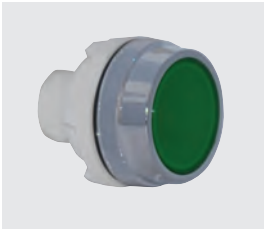

T11AH20

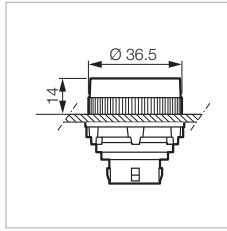

- Red
- Green
- Clear
- Yellow
- White
- Blue

- T11AH10
- T11AH20
- T11AH30
- T11AH40
- T11AH50
- T11AH60

### FLUSH WITH DEEP COLLAR



T15AH40

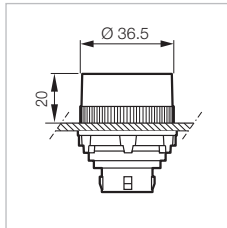

- Red
- Green
- Clear
- Yellow
- White
- Blue

- T15AH10
- T15AH20
- T15AH30
- T15AH40
- T15AH50
- T15AH60

### FLUSH WITH SHROUD



T11AP40

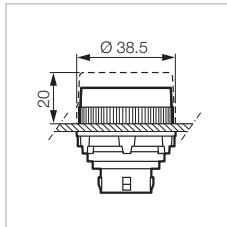

- Red
- Green
- Clear
- Yellow
- White
- Blue

- T11AP10
- T11AP20
- T11AP30
- T11AP40
- T11AP50
- T11AP60

### PROJECTING



T11AK10

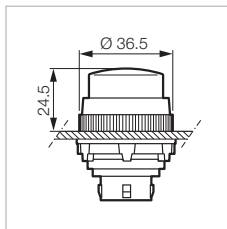

- Red
- Green
- Clear
- Yellow
- White

- T11AK10
- T11AK20
- T11AK30
- T11AK40
- T11AK50

# Operator Heads: $\varnothing$ 30mm

## ► SPRING RETURN - ILLUMINATED



Technical Info (p. 154)

### $\varnothing$ 40 MUSHROOM

Chrome Bezel  
Part Number



T11AM10

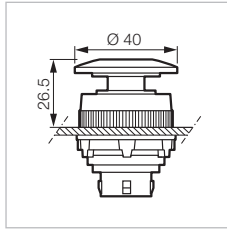

- Red
- Green
- Yellow
- White

- T11AM10
- T11AM20
- T11AM40
- T11AM50

## ► MAINTAINED - ILLUMINATED

### PROJECTING



T11CK20

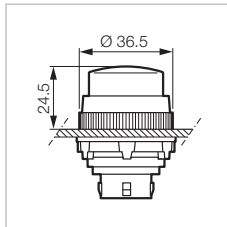

- Red
- Green
- Clear
- Yellow
- White

- T11CK10
- T11CK20
- T11CK30
- T11CK40
- T11CK50

# Operator Heads: $\varnothing$ 30mm

## ▶ SELECTOR SWITCHES - ILLUMINATED

 Technical Info (p. 154)

### WITH HANDLE

2 positions

Chrome Bezel  
Part Number



T11KG10

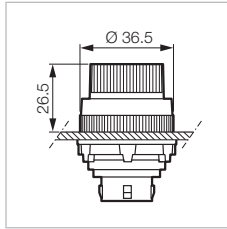

#### MAINTAINED POSITIONS - 45°

- Red
- Green
- White



T11KG10  
T11KG20  
T11KG50

#### MAINTAINED POSITIONS - 45°

- Red
- Green
- White



T11KJ10  
T11KJ20  
T11KJ50

#### SPRING RETURN - 45°

- Red
- Green
- White



T11KK10  
T11KK20  
T11KK50

#### MAINTAINED POSITIONS - 90°

- Red
- Green
- White



T11KM10  
T11KM20  
T11KM50

### WITH HANDLE

3 positions



T11ME20

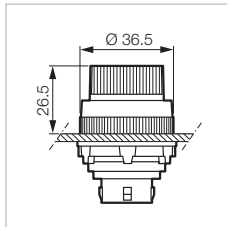

#### MAINTAINED POSITIONS - 45°

- Red
- Green
- White

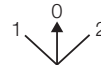

T11ME10  
T11ME20  
T11ME50

#### SPRING RETURN FROM RIGHT TO 0 - 45°

- Red
- Green
- White



T11MG10  
T11MG20  
T11MG50

#### SPRING RETURN TO 0 - 45°

- Red
- Green
- White



T11MH10  
T11MH20  
T11MH50

#### MAINTAINED POSITIONS - 90°

- Red
- Green
- White



T11MJ10  
T11MJ20  
T11MJ50

# Operator Heads: $\phi$ 30mm

## ▶ PILOT LIGHTS - HEAD ONLY

 Technical Info (p. 154)

### WITH RIBBED LENS

Part Number



T10SA10

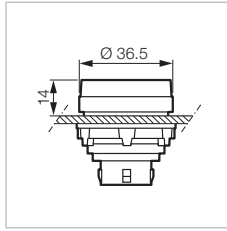

For use with a clip and LED block (p. 58 to 70)

- Red
- Green
- Clear
- Yellow
- White
- Blue

- T10SA10
- T10SA20
- T10SA30
- T10SA40
- T10SA50
- T10SA60

### WITH SMOOTH LENS



T10SB50

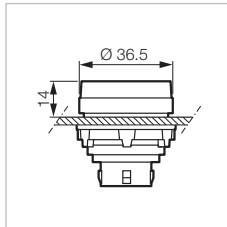

For use with a clip and LED block (p. 58 to 70)

- Red
- Green
- Clear
- Yellow
- White
- Blue

- T10SB10
- T10SB20
- T10SB30
- T10SB40
- T10SB50
- T10SB60

### WITH RIBBED LENS AND METAL COLLAR



T15SA40

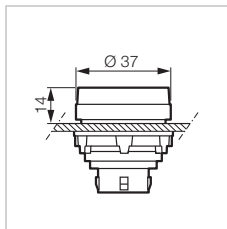

For use with a clip and LED block (p. 58 to 70)

- Red
- Green
- Clear
- Yellow
- White
- Blue

- T15SA10
- T15SA20
- T15SA30
- T15SA40
- T15SA50
- T15SA60

### WITH SMOOTH LENS AND METAL COLLAR



T15SB20

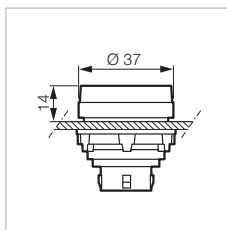

For use with a clip and LED block (p. 58 to 70)

- Red
- Green
- Clear
- Yellow
- White
- Blue

- T15SB10
- T15SB20
- T15SB30
- T15SB40
- T15SB50
- T15SB60



## Accessories ø 30

### ▶ LEGEND PLATES - EMERGENCY STOP

#### PLASTIC LEGEND PLATES

Part Number



UWE80300

Plastic - Yellow with black engraving

**60mm diameter**

Blank  
EMERGENCY STOP

UWE60  
UWE60300

**70mm diameter**

Blank  
EMERGENCY STOP

UWE70  
UWE70300

**80mm diameter**

Blank  
EMERGENCY STOP

UWE80  
UWE80300

**NOTE:**

Custom diameters and engravings available please contact us for details.

#### METAL LEGEND PLATES



UE00300

Metal - Yellow with black lettering

**80mm diameter**

EMERGENCY STOP

UE00300

## Accessories ø 30

### ► COMPLETE LEGEND PLATES (FRAME + INSERT)

#### Standard model - 40 x 54 mm

Part Number



UP39

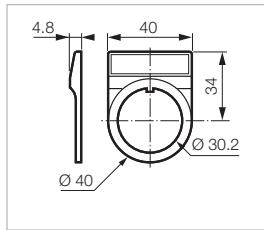

Round shape  
Black frame and legend plate unassembled  
2 lines maximum, 18 characters per line

#### WITHOUT ENGRAVING

- Red
- Black
- Alu

UP31  
UP33  
UP39

#### WITH TEXT OR SYMBOL (see p. 82 to 85)

Code to be added at the end of the part number.  
For custom text or symbol please contact us.

- Red - white engraving
- Black - white engraving
- Alu - black engraving

UP31□□□□  
UP33□□□□  
UP39□□□□

#### PROTECTIVE MASK FOR LEGEND PLATE (PAPER OR OTHER ...)

- Transparent

UP37

#### Large model - 50 x 54 mm



UG39

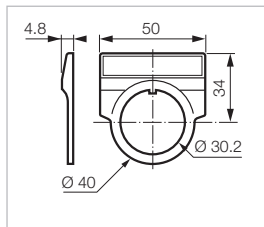

Round shape  
Black frame and legend plate unassembled  
2 lines maximum, 24 characters per line

#### WITHOUT ENGRAVING

- Red
- Black
- Alu

UG31  
UG33  
UG39

#### WITH TEXT OR SYMBOL (see p. 82 to 85)

Code to be added at the end of the part number.  
For custom text or symbol please contact us.

- Red - white engraving
- Black - white engraving
- Alu - black engraving

UG31□□□□  
UG33□□□□  
UG39□□□□



#### PROTECTIVE MASK FOR LEGEND PLATE (PAPER OR OTHER ...)

- Transparent

UG37

## Accessories ø 30

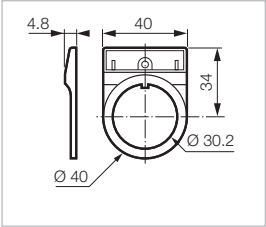
### ▶ LEGEND PLATES - FRAMES ONLY

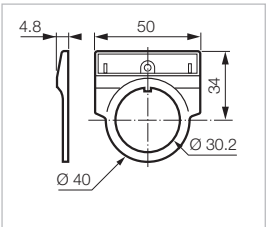
		Standard model	Part Number
		● Black	UP3
		Large model	
		● Black	UG3

### ▶ LEGEND PLATES - INSERTS ONLY

#### TO BE ENGRAVED

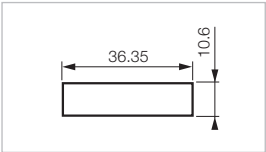
		Standard model	
		2 lines maximum 18 characters per line For use with standard model legend plate frames	
		<b>WITHOUT ENGRAVING</b>	
		● Red	IB1
		● Black	IB3
		● Alu	IB9
		<b>WITH TEXT OR SYMBOL</b> (see p. 82 to 85) Code to be added at the end of the part number. For custom text or symbol please contact us.	
		● Red - white engraving	IB1□□□
		● Black - white engraving	IB3□□□
		● Alu - black engraving	IB9□□□
		<b>PROTECTIVE MASK FOR LEGEND PLATE (PAPER OR OTHER ...)</b>	
		○ Transparent	IB7

## Accessories ø 30

### ▶ LEGEND PLATES - INSERTS ONLY

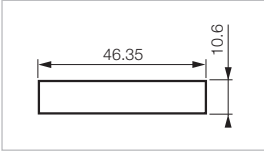
TO BE ENGRAVED	Large model	Part Number
 <p>IC3</p>	 <p>2 lines maximum 18 characters per line For use with standard model legend plate frames</p> <p><b>WITHOUT ENGRAVING</b></p> <ul style="list-style-type: none"> <li>● Red</li> <li>● Black</li> <li>● Alu</li> </ul> <p><b>WITH TEXT OR SYMBOL</b> (see p. 82 to 85) Code to be added at the end of the part number. For custom text or symbol please contact us.</p> <ul style="list-style-type: none"> <li>● Red - white engraving</li> <li>● Black - white engraving</li> <li>● Alu - black engraving</li> </ul> <p><b>PROTECTIVE MASK FOR LEGEND PLATE (PAPER OR OTHER ...)</b></p> <ul style="list-style-type: none"> <li>○ Transparent</li> </ul>	<p>IC1 IC3 IC9</p> <p>IC1□□□ IC3□□□ IC9□□□</p> <p>IC7</p>

### ▶ BUTTON PLATES

#### FOR ILLUMINATED FLUSH BUTTONS

 <p>UE02</p>	<p>2 lines maximum, 10 characters per line To be inserted under the button</p> <p><b>Without engraving</b></p> <ul style="list-style-type: none"> <li>○ Transparent</li> </ul> <p><b>WITH TEXT OR SYMBOL</b> (see p. 82 to 85) Code to be added at the end of the part number. For custom text or symbol please contact us.</p> <ul style="list-style-type: none"> <li>○ Transparent (black engraving)</li> </ul>	<p>UE02</p> <p>UE02□□□</p>
---	---	----------------------------

#### FOR PILOT LIGHTS

 <p>UE10</p>	<p>2 lines maximum, 12 characters per line To be inserted under Smooth lens Pilot Light lens</p> <p><b>Without engraving</b></p> <ul style="list-style-type: none"> <li>○ Transparent</li> </ul> <p><b>WITH TEXT OR SYMBOL</b> (see p. 82 to 85) Code to be added at the end of the part number. For custom text or symbol please contact us.</p> <ul style="list-style-type: none"> <li>○ Transparent (black engraving)</li> </ul>	<p>UE10</p> <p>UE10□□□</p>
---	---	----------------------------

## Accessories ø 30

### ► MISCELLANEOUS

#### SHROUD FOR FLUSH BUTTONS

Part Number

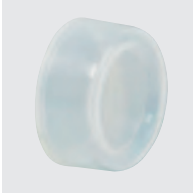

○ Transparent

UA0228

UA0228

#### SHROUD FOR ADJUSTABLE MECHANICAL BUTTONS

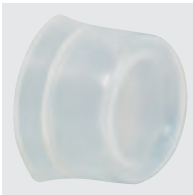

○ Transparent

UA0219

UA0219

#### STANDARD BEZEL



Height 13 mm

Brilliant chrome plastic  
Black plastic  
Grey plastic  
Matt chrome plastic bezel  
Matt chrome brass

UA0011  
UA0012  
UA0013  
UA0016  
UA0014

UA0011

#### DEEP BEZEL

For flush push-buttons only



Height 20 mm

Brilliant chrome brass

UA0202

UA0202

#### BEZEL FOR MECHANICAL ACTUATOR



Height 20 mm

Brilliant chrome plastic  
Black plastic  
Grey plastic  
Brilliant chrome brass

UA0111  
UA0112  
UA0113  
UA0114

UA0112

## Accessories $\phi$ 30

### ► MISCELLANEOUS

#### FIXING TOOL

Part Number



Fixing tool  $\phi$  22/ $\phi$  30

**WA0210**

WA0210

#### BLANKING PLUG



● Grey

**UA0215**

UA0215

#### ANTI-ROTATION RING



Anti-rotation ring

**UA0209**

UA0209

#### LOCKING NUT

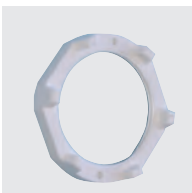

Plastic locking nut for 30mm operators

**0908005V**

0908005V

#### GUARD

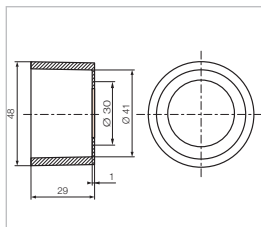
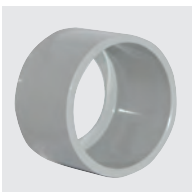

For spring return button and spring return mushroom head  
(max.  $\phi$  40)

**UA0225**

UA0225

# Control Stations $\varnothing$ 30

## ► CONTROL STATIONS - NON-ILLUMINATED



 Technical Info (p.154)

### SPRING RETURN - FLUSH

Part Number





TBPA301-101

				Legend Text	
● Green	NO		START	TBPA301-101	
● Red	NC		STOP	TBPA301-104	

### MUSHROOM HEAD $\varnothing$ 40 - SPRING RETURN



TBPA301-201

				Legend Text	
● Green	NO		START	TBPA301-204	
● Red	NC		STOP	TBPA301-201	

### SELECTOR SWITCH - WITH HANDLE



TBPA301-401

				Marking	
		2 Maintained positions - 90°			
● Black	NO		OFF ON	TBPA301-401	

### SELECTOR SWITCH - WITH KEY



TBPA301-402

				Marking	
		Supplied with 2 keys profile n° 455			
		2 Maintained positions - 90° Key free in position 0-1			
● Black	NO		OFF ON	TBPA301-402	

# Control Stations ø 30

## ▶ CONTROL STATIONS - NON-ILLUMINATED

 Technical Info (p.154)

### MUSHROOM HEAD ø 40 - MAINTAINED

Part Number



TBPA301-301

**Push-turn to reset**

● Red NC



EMERGENCY STOP

TBPA301-301

**Push-Pull to reset**

● Red NC



EMERGENCY STOP

TBPA301-311

**Push-Key to reset**

● Red NC



EMERGENCY STOP

TBPA301-321

Supplied with 2 keys profile n° 455

### SPRING RETURN - FLUSH



TBPA302-001

● Green NO

● Red NC

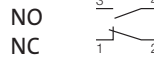

**Marking**

START  
STOP

TBPA302-001

● Black NO

● Black NO

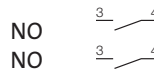

UP  
DOWN

TBPA302-002

### SPRING RETURN - FLUSH



TBPA303-001

● Green NO

● Red NC

● Green NO

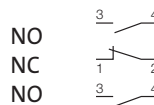

**Marking**

UP  
STOP  
DOWN

TBPA303-001



## Control Stations $\varnothing$ 30

### ► PRE-DRILLED POLYCARBONATE ENCLOSURES



BPA302

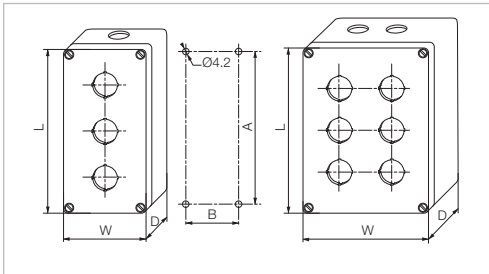

Number of Holes	Cable Gland	Dimensions					Part Number
		L	W	D	A	B	
1	1 x PG13-GY	82	80	55	70	50	<b>BPA301</b>
2	1 x PG13-GY	120	80	55	108	50	<b>BPA302</b>
3	1 x PG13-GY	160	80	55	148	50	<b>BPA303</b>
1	1 x PG16-GY	82	80	85	70	50	<b>BPP301</b>
2	1 x PG16-GY	120	80	85	108	50	<b>BPP302</b>
3	1 x PG16-GY	160	80	85	148	50	<b>BPP303</b>
4	2 x PG16-GY	122	120	85	110	90	<b>BPP304</b>
6	2 x PG16-GY	200	120	75	188	90	<b>BPA306</b>
8	2 x PG16-GY	200	120	75	188	90	<b>BPA308</b>
10	2 x PG16-GY	240	120	100	288	90	<b>BPP310</b>

### ► EMPTY POLYCARBONATE ENCLOSURES



BNT208



BNT251

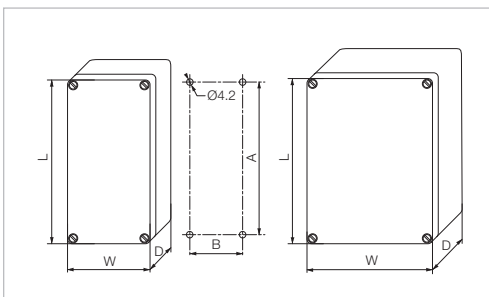

L	W	D	Dimensions (mm)		Part Number
			A	B	
65	50	35	53	38	<b>BNT206</b>
82	80	55	70	50	<b>BNT210</b>
82	80	85	70	50	<b>BNT225</b>
120	80	55	108	50	<b>BNT215</b>
120	80	85	108	50	<b>BNT226</b>
122	120	55	110	90	<b>BNT217</b>
122	120	85	110	90	<b>BNT227</b>
160	80	55	148	50	<b>BNT220</b>
160	80	85	148	50	<b>BNT231</b>
200	120	75	188	90	<b>BNT237</b>
200	150	75	188	119	<b>BNT223</b>
240	120	100	228	90	<b>BNT242</b>
240	160	120	228	130	<b>BNT243</b>
250	160	90	238	130	<b>BNT240</b>

### CABLE GLANDS



PG16-GY

	Size	Cable Thickness	Part Number
● Grey	PG11	3mm - 7mm	<b>PG11-GY</b>
● Grey	PG13.5	6mm - 12mm	<b>PG13-GY</b>
● Grey	PG16	10mm - 14mm	<b>PG16-GY</b>
● Grey	PG21	13mm - 18mm	<b>PG21-GY</b>
● Grey	PG29	18mm - 25mm	<b>PG29-GY</b>

# Technical Specifications

## NON-ILLUMINATED

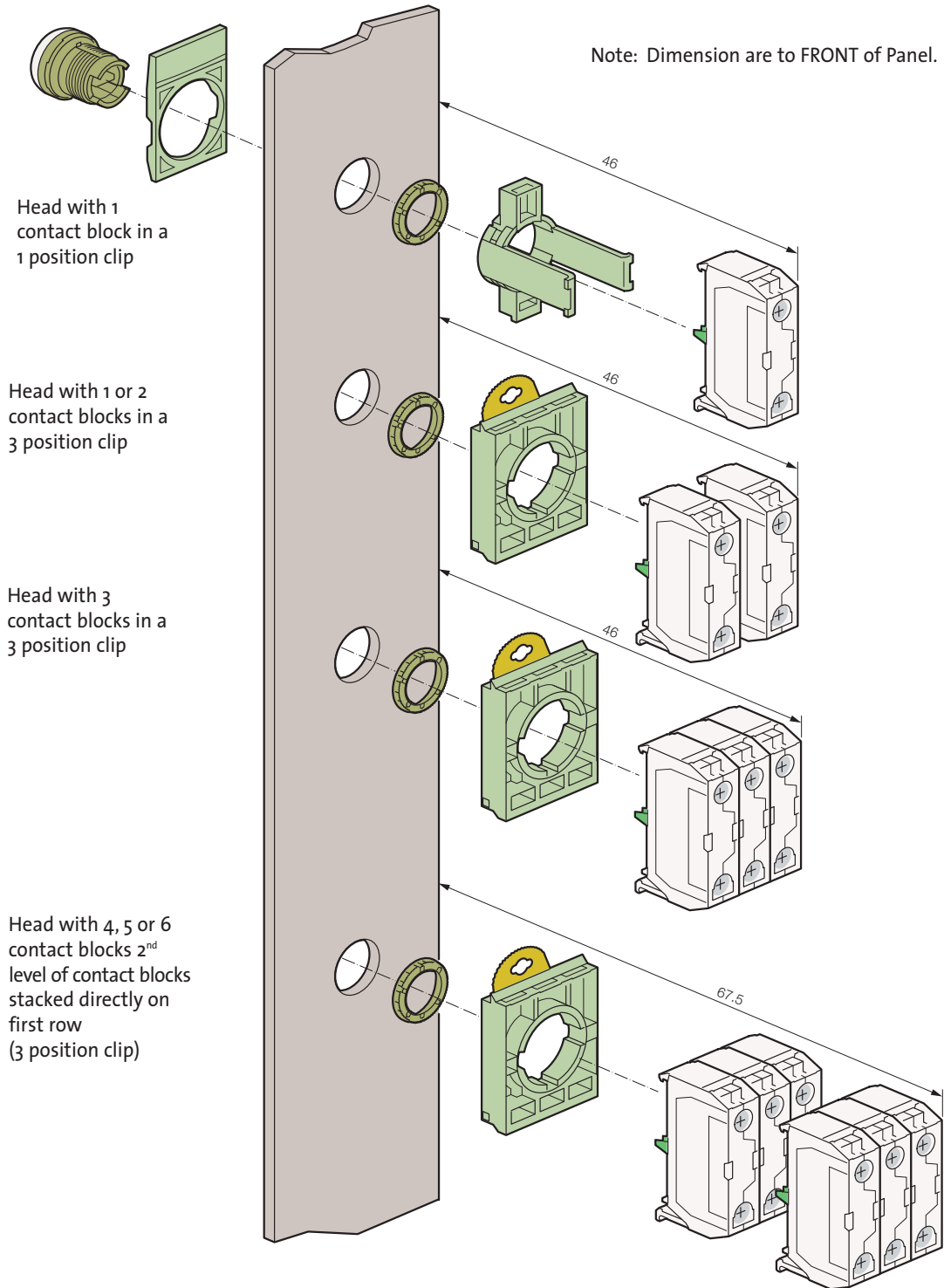

# Technical Specifications

## ILLUMINATED

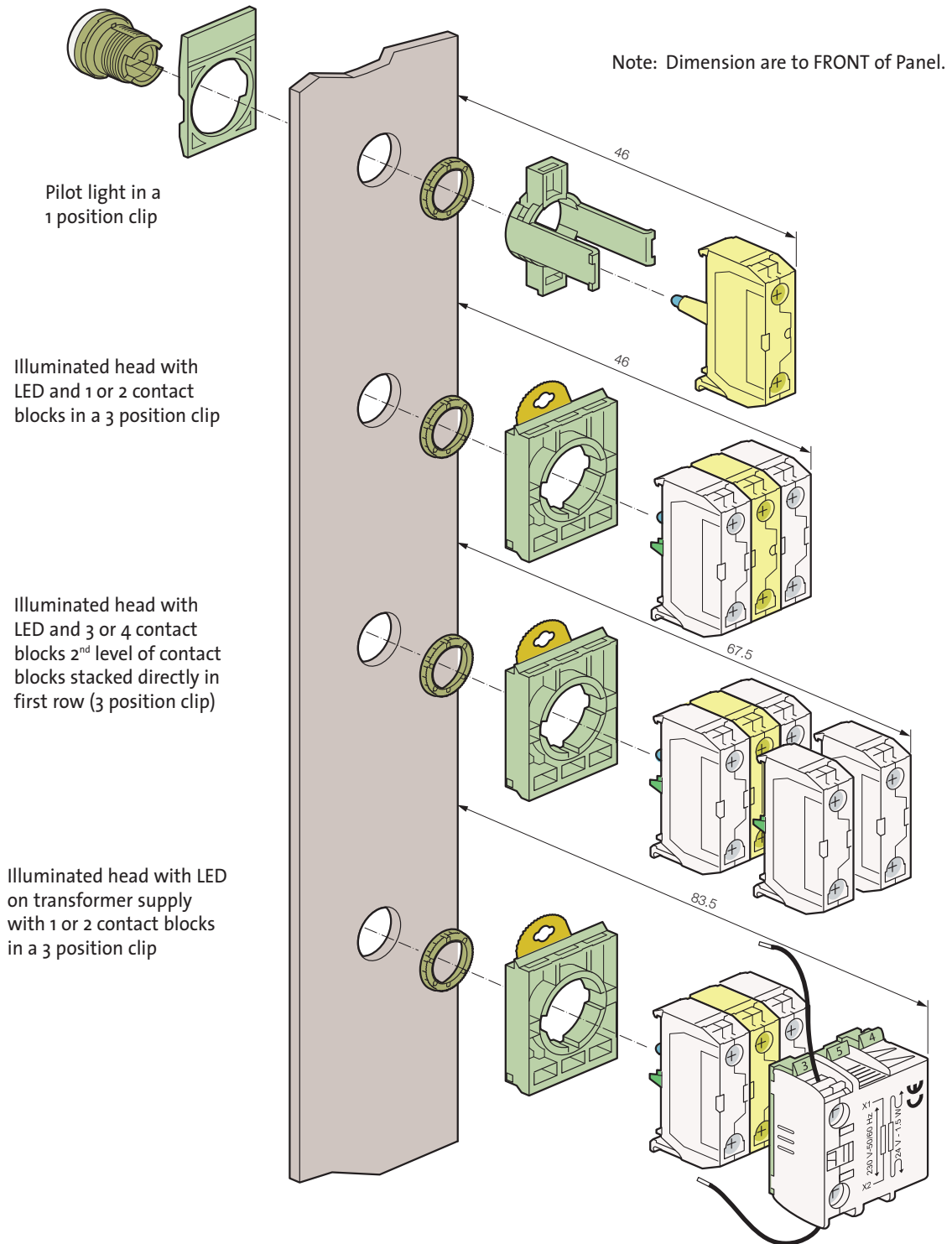

 Illuminated blocks

# Technical Specifications

## ▶ GENERAL

Characteristics	Data	Standards
▶ Storage temperature for illuminated or non illuminated button	- 40°C to + 70°C	
▶ Operating temperature	Non illuminated buttons: - 25°C to + 70°C Illuminated buttons: - 25°C to + 60°C	
▶ Degree of protection	IP 65 for standard heads IP 67 for shrouded heads Type 4, 4X, 12, and 13	IEC 60947-1 NEMA standard
▶ Mechanical life	Spring return push button: 3 x 10 <sup>6</sup> operating cycles	IEC 60947-5-1

The contact blocks and LED modules used for the Ø 30mm heads are the same as for Ø 22mm heads (p. 57 to 75).  
Their characteristics are described on <None>. 108 to 111.

## ▶ PANEL CUT-OUT Ø 30mm

### DRILLING

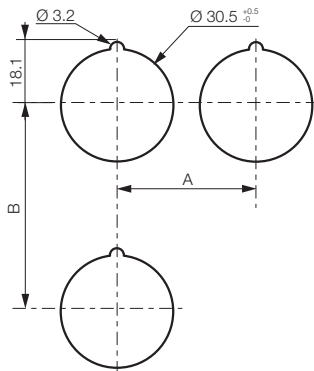

For heads equipped with electrical blocks with screw terminals

#### Minimum interval (mm)

A	> 40	For mushroom head Ø40
	> 50	For selector switch with Long handle
	> 70	For mushroom head Ø70
B	> 50	For double touch
	> 50	For legend plates
	> 70	For mushroom head Ø70

### MECHANICAL OPERATION

For 3 position selector switches

**Handle position**  
(view from front of panel)



**Contacts block actuation**  
(clip position)

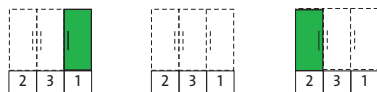

Non operated block



Operated block



# Disconnect Switches

A modular and flexible range



Contact gap  
**7 mm**

**Reversible  
terminal feature**

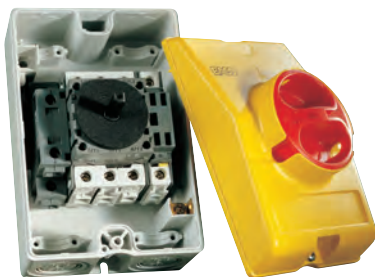

## ► IN ENCLOSURE

---

- Degree of protection: up to IP 66
- For 25A to 100A size switches
- Cable entries with pre-formed knockouts
- Tamper-proof cover with padlockable handle
- Recessed area for optional plate
- A wide choice of associated contact blocks and enclosures available

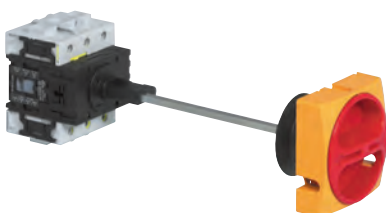

## ► WITH CLUTCH DRIVE

---

- Metal shafts can be cut to length required
- With or without door interlock system
- Short or long metal shafts available

# 25A / 32A

## ▶ DOOR/PANEL MOUNTING

 Technical Info (p. 196)

### PADLOCKABLE PRESENTATION



0172001



0174101

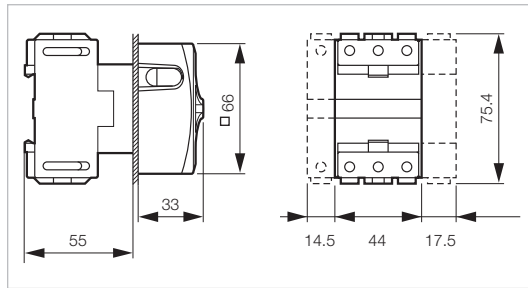

Yellow/Red Handle  
Part Number

Grey Handle  
Part Number

#### 25 A

- 3P
- 3P + NC/NO
- 4P neutral on left
- 4P + NC/NO

- 0172001
- 0172011
- 0172021
- 0172031

- 0174001
- 0174011
- 0174021
- 0174031

#### 32 A

- 3P
- 3P+NC/NO
- 4P neutral on left
- 4P + NC/NO

- 0172101
- 0172111
- 0172121
- 0172131

- 0174101
- 0174111
- 0174121
- 0174131

STANDARD VERSIONS IP40 RATED.

TO ORDER WITH IP65 GASKETS ADD -1 TO PART NUMBERS ABOVE.  
IE. 0172001-1

### COMPONENTS AND ACCESSORIES

Part Number



0172000

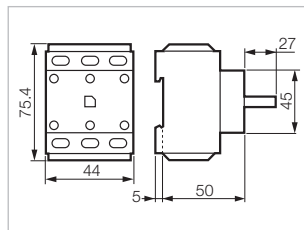

#### 3-pole switch body without handle

- 25 A
- 32 A

- 0172000
- 0172100

#### Additional pole

- 25 A
- 32 A

- 0172075
- 0172175

#### Neutral pole

- 25 A
- 32 A

- 0172065
- 0172165

#### Junction block

Ground or Neutral

0172185

#### Auxiliary contact - 10A

NC/NO

0172179

#### IP65 Seal Kit

0172267

#### Replacement Handle

- 66 - Yellow/Red
- 66 - Grey

- 0172601
- 0174601



0172065

0172185

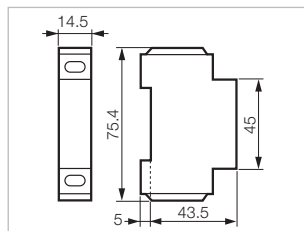

# 25A / 32A

## ▶ DOOR/PANEL MOUNTING

 Technical Info (p.196)

### NON- PADLOCKABLE PRESENTATION

Yellow/Red Handle  
Part Number

Grey Handle  
Part Number



0172002



0174102

#### 25 A

- 3P
- 3P + NC/NO
- 4P neutral on left
- 4P + NC/NO

- 0172002
- 0172012
- 0172022
- 0172032

- 0174002
- 0174012
- 0174022
- 0174032

#### 32 A

- 3P
- 3P + NC/NO
- 4P neutral on left
- 4P + NC/NO

- 0172102
- 0172112
- 0172122
- 0172132

- 0174102
- 0174112
- 0174122
- 0174132

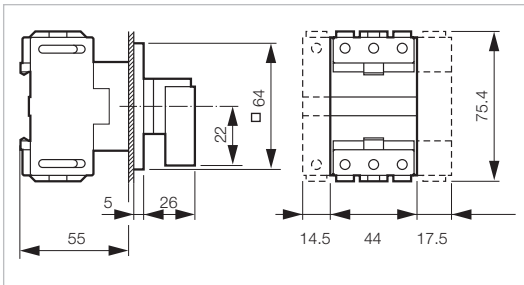

STANDARD VERSIONS IP40 RATED.

TO ORDER WITH IP65 GASKETS ADD -1 TO PART NUMBERS ABOVE.  
IE. 0172002-1

### COMPONENTS AND ACCESSORIES

Part Number



0172179

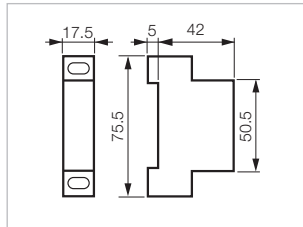

#### 3-pole switch body without handle

- 25 A
- 32 A

- 0172000
- 0172100

#### Additional pole

- 25 A
- 32 A

- 0172075
- 0172175

#### Neutral pole

- 25 A
- 32 A

- 0172065
- 0172165

#### Junction block

Ground or Neutral

0172185

#### Auxiliary contact - 10A

NC/NO

0172179

#### IP65 Seal Kit

0172267

#### Replacement Handle, Plate, and Frame

- 64 - Yellow/Red
- 64 - Grey

- 0172602
- 0174602

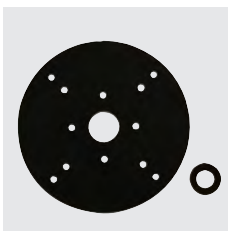

0172267

# 25A / 32A

## ▶ DOOR/PANEL MOUNTING

 Technical Info (p.196)

### PADLOCKABLE PRESENTATION Ø 22 SINGLE-HOLE MOUNTING

Yellow/Red Handle  
Part Number



0172003

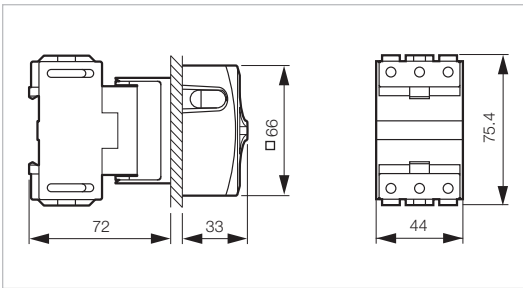

#### 25 A

3P	0172003
3P + NC/NO	0172013
4P neutral on left	0172023
4P + NC/NO	0172033

#### 32 A

3P	0172103
3P+NC/NO	0172113
4P neutral on left	0172123
4P + NC/NO	0172133

STANDARD VERSIONS IP65 RATED.

### COMPONENTS AND ACCESSORIES

Part Number



0172000

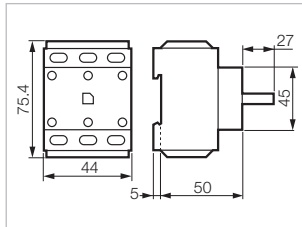

#### 3-pole switch body without handle

25 A	0172000
32 A	0172100

#### Additional pole

25 A	0172075
32 A	0172175

#### Neutral pole

25 A	0172065
32 A	0172165

#### Junction block Ground or Neutral

0172185

#### Auxiliary contact - 10A

NC/NO	0172179
-------	---------

#### Replacement Handle

□ 66 - Ø 22 single-hole-mounting - Yellow/Red	0172603
---	---------



0172065 0172185

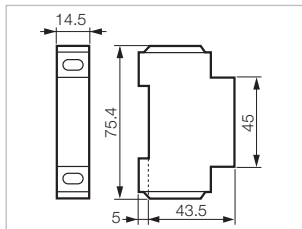



# 25A / 32A

## ▶ DOOR/PANEL MOUNTING

 Technical Info (p.196)

### NON-PADLOCKABLE PRESENTATION Ø 22 SINGLE-HOLE MOUNTING

Yellow/Red Handle  
Part Number



0172004

#### 25 A

3P	<b>0172004</b>
3P+NC/NO	<b>0172014</b>
4P neutral on left	<b>0172024</b>

#### 32 A

3P	<b>0172104</b>
3P+NC/NO	<b>0172114</b>
4P neutral on left	<b>0172124</b>

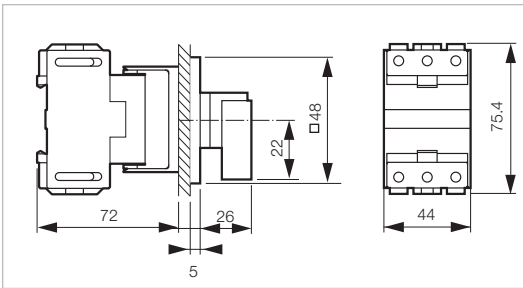

STANDARD VERSIONS IP65 RATED.

### COMPONENTS AND ACCESSORIES

Part Number



0172179

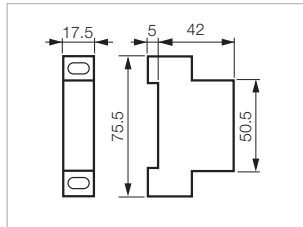

#### 3-pole switch body without handle

25 A	<b>0172000</b>
32 A	<b>0172100</b>

#### Additional pole

25 A	<b>0172075</b>
32 A	<b>0172175</b>

#### Neutral pole

25 A	<b>0172065</b>
32 A	<b>0172165</b>

#### Junction block

Ground or Neutral	<b>0172185</b>
-------------------	----------------

#### Auxiliary contact - 10A

NC/NO	<b>0172179</b>
-------	----------------

#### Replacement Handle, Plate, and Frame

<input type="checkbox"/> 48 - Ø 22 single-hole-mounting - Yellow/Red	<b>0172604</b>
--	----------------

# 25A / 32A

## ► DIN-RAIL IN-PANEL MOUNTING

 Technical Info (p.196)

### PADLOCKABLE PRESENTATION

Grey Handle  
Part Number



0174005

#### 25 A

3P  
3P + NC/NO  
4P neutral on left  
4P + NC/NO

0174005  
0174015  
0174025  
0174035

#### 32 A

3P  
3P+NC/NO  
4P neutral on left  
4P + NC/NO

0174105  
0174115  
0174125  
0174135

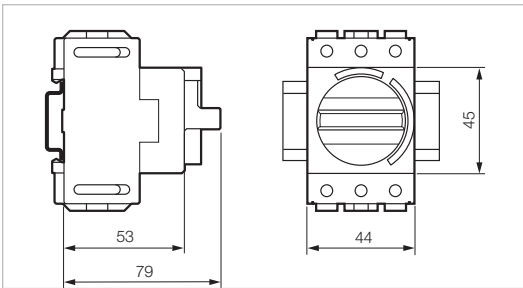

### COMPONENTS AND ACCESSORIES

Part Number



0172000

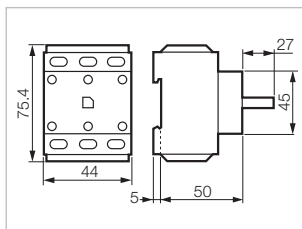

#### 3-pole switch body without handle

25 A  
32 A

0172000  
0172100

#### Additional pole

25 A  
32 A

0172075  
0172175

#### Neutral pole

25 A  
32 A

0172065  
0172165



0172065

0172185

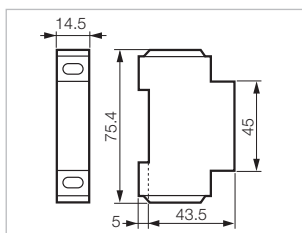

#### Junction block Ground or Neutral

0172185

#### Auxiliary contact - 10A

NC/NO

0172179

# 25A / 32A

## ▶ DOOR INTERLOCK MOUNTING - NO METAL SHAFT EXTENSION



Technical Info (p.196)

### PADLOCKABLE PRESENTATION

Yellow/Red Handle  
Part Number

Grey Handle  
Part Number



0165009NS

#### 25 A

3P  
3P + NC/NO  
4P neutral on left  
4P + NC/NO

0165009NS  
0165019NS  
0165029NS  
0165039NS

0168009NS  
0168019NS  
0168029NS  
0168039NS



0168109NS

#### 32 A

3P  
3P + NC/NO  
4P neutral on left  
4P + NC/NO

0165109NS  
0165119NS  
0165129NS  
0165139NS

0168109NS  
0168119NS  
0168129NS  
0168139NS

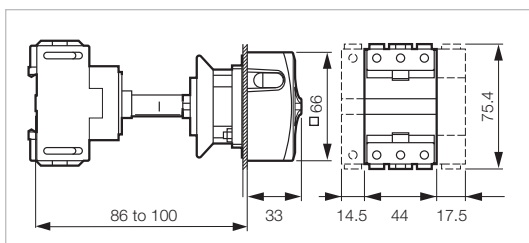

STANDARD VERSIONS IP40 RATED.

TO ORDER WITH IP65 GASKETS ADD -1 TO PART NUMBERS ABOVE.  
IE. 0165009NS-1

### COMPONENTS AND ACCESSORIES

Part Number



0172179

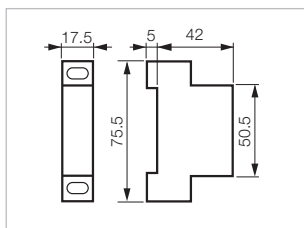

#### 3-pole switch body without handle

25 A  
32 A

0172000  
0172100

#### Additional pole

25 A  
32 A

0172075  
0172175

#### Neutral pole

25 A  
32 A

0172065  
0172165

#### Junction block

Ground or Neutral

0172185

#### Auxiliary contact - 10A

NC/NO

0172179

#### IP65 Seal Kit

0174259

#### Replacement Handle

66 - Yellow/Red  
 66 - Grey

0172601  
0174601



0174259

## 25A / 32A

### ▶ DOOR INTERLOCK MOUNTING - SHORT METAL SHAFT EXTENSION



Technical Info (p.196)

#### PADLOCKABLE PRESENTATION

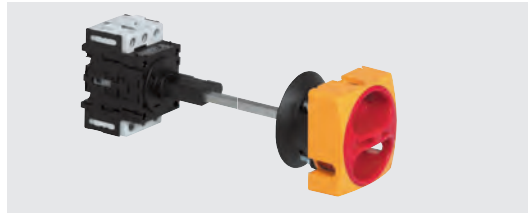

0165009SS

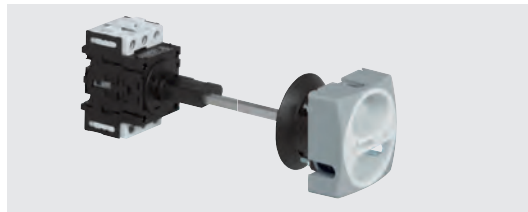

0168109SS

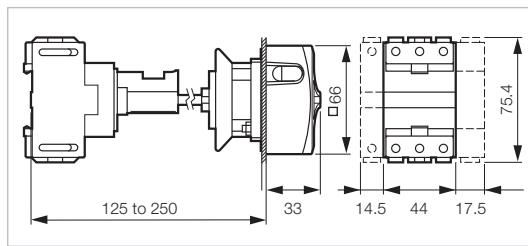

#### 25 A

- 3P
- 3P + NC/NO
- 4P neutral on left
- 4P + NC/NO

- 0165009SS
- 0165019SS
- 0165029SS
- 0165039SS

- 0168009SS
- 0168019SS
- 0168029SS
- 0168039SS

#### 32 A

- 3P
- 3P + NC/NO
- 4P neutral on left
- 4P + NC/NO

- 0165109SS
- 0165119SS
- 0165129SS
- 0165139SS

- 0168109SS
- 0168119SS
- 0168129SS
- 0168139SS

STANDARD VERSIONS IP40 RATED.

TO ORDER WITH IP65 GASKETS ADD -1 TO PART NUMBERS ABOVE.  
IE. 0165009SS-1

#### COMPONENTS AND ACCESSORIES



0172000

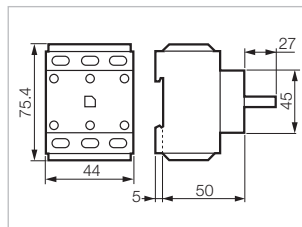

#### 3-pole switch body without handle

- 25 A
- 32 A

- 0172000
- 0172100

#### Additional pole

- 25 A
- 32 A

- 0172075
- 0172175

#### Neutral pole

- 25 A
- 32 A

- 0172065
- 0172165

#### Junction block Ground or Neutral

- 0172185

#### Auxiliary contact - 10A

- NC/NO

- 0172179

#### IP65 Seal Kit

- 0174259

#### Replacement Handle

- 66 - Yellow/Red
- 66 - Grey

- 0172601
- 0174601



0172065 0172185

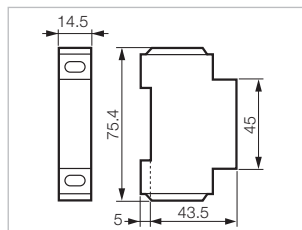

25A / 32A

▶ DOOR INTERLOCK MOUNTING - LONG METAL SHAFT EXTENSION



PADLOCKABLE PRESENTATION

Yellow/Red Handle  
Part Number

Grey Handle  
Part Number

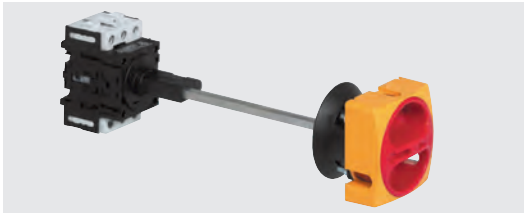

0165009LS

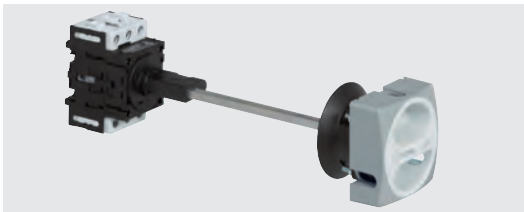

0168109LS

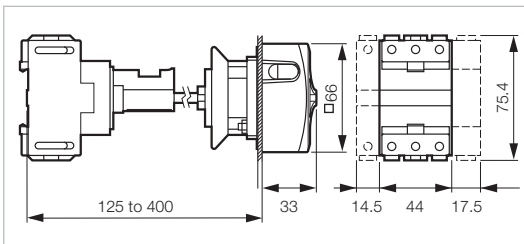

25 A

- 3P
- 3P + NC/NO
- 4P neutral on left
- 4P + NC/NO

- 0165009LS
- 0165019LS
- 0165029LS
- 0165039LS

- 0168009LS
- 0168019LS
- 0168029LS
- 0168039LS

32 A

- 3P
- 3P + NC/NO
- 4P neutral on left
- 4P + NC/NO

- 0165109LS
- 0165119LS
- 0165129LS
- 0165139LS

- 0168109LS
- 0168119LS
- 0168129LS
- 0168139LS

STANDARD VERSIONS IP40 RATED.

TO ORDER WITH IP65 GASKETS ADD -1 TO PART NUMBERS ABOVE.  
IE. 0165009LS-1

COMPONENTS AND ACCESSORIES

Part Number



0172179

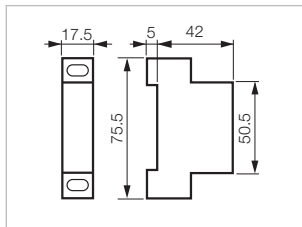

3-pole switch body without handle

- 25 A
- 32 A

- 0172000
- 0172100

Additional pole

- 25 A
- 32 A

- 0172075
- 0172175

Neutral pole

- 25 A
- 32 A

- 0172065
- 0172165

Junction block

Ground or Neutral

- 0172185

Auxiliary contact - 10A

NC/NO

- 0172179

IP65 Seal Kit

- 0174259

Replacement Handle

- 66 - Yellow/Red
- 66 - Grey

- 0172601
- 0174601



0174259

# 25A / 32A

## ► ENCLOSURES

 Technical Info (p.196)

### PADLOCKABLE PRESENTATION

Yellow/Red Handle  
Part Number

Grey Handle  
Part Number



0172061



0174161

#### 25 A

- 3P
- 3P + NC/NO
- 4P neutral on left
- 4P + NC/NO

- 0172061
- 0172071
- 0172081
- 0172091

- 0174061
- 0174071
- 0174081
- 0174091

#### 32 A

- 3P
- 3P+NC/NO
- 4P neutral on left
- 4P + NC/NO

- 0172161
- 0172171
- 0172181
- 0172191

- 0174161
- 0174171
- 0174181
- 0174191

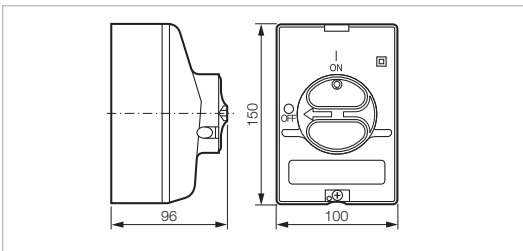

Cable entries: 6 x PG16 and 4 x M25

STANDARD VERSIONS IP66 RATED.

### PADLOCKABLE PRESENTATION

Yellow/Red Handle  
Part Number

Grey Handle  
Part Number



0172009



0174109

#### 25 A

- 6P
- 6P + NC/NO

- 0172009
- 0172029

- 0174009
- 0174029

#### 32 A

- 6P
- 6P+NC/NO

- 0172109
- 0172129

- 0174109
- 0174129

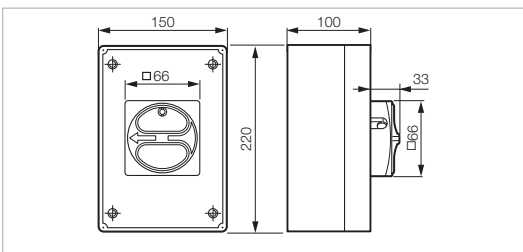

Cable entries: 4 x PG21

STANDARD VERSIONS IP40 RATED.

TO ORDER WITH IP65 GASKETS ADD -6 TO PART NUMBERS ABOVE.  
IE. 0172009-6

### CABLE GLANDS

Part Number



PG16-GY

- PG16
- PG21

- Cable Range 10mm - 14mm
- Cable Range 13mm - 18mm

- PG16-GY
- PG21-GY

# 25A / 32A

## ENCLOSURES

 Technical Info (p.196)

### NON- PADLOCKABLE PRESENTATION



0172062

0174162

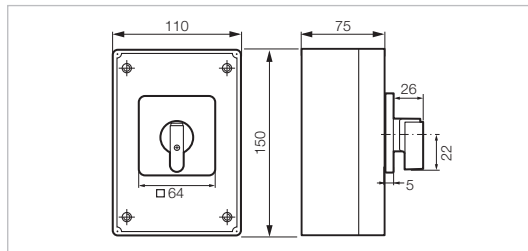

Cable entries: 4 x PG16

#### 25 A

- 3P
- 3P + NC/NO
- 4P neutral on left
- 4P + NC/NO

Yellow/Red Handle  
Part Number

- 0172062
- 0172072
- 0172082
- 0172092

Grey Handle  
Part Number

- 0174062
- 0174072
- 0174082
- 0174092

#### 32 A

- 3P
- 3P+NC/NO
- 4P neutral on left
- 4P + NC/NO

- 0172162
- 0172172
- 0172182
- 0172192

- 0174162
- 0174172
- 0174182
- 0174192

STANDARD VERSIONS IP40 RATED.

TO ORDER WITH IP65 GASKETS ADD -6 TO PART NUMBERS ABOVE.

IE. 0172062-6

### NON-PADLOCKABLE PRESENTATION



0172019

0174119

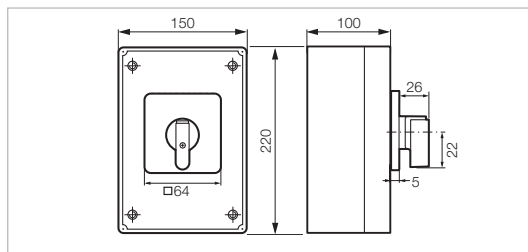

Cable entries: 4 x PG21

#### 25 A

- 6P
- 6P + NC/NO

Yellow/Red Handle  
Part Number

- 0172019
- 0172039

Grey Handle  
Part Number

- 0174019
- 0174039

#### 32 A

- 6P
- 6P+NC/NO

- 0172119
- 0172139

- 0174119
- 0174139

STANDARD VERSIONS IP40 RATED.

TO ORDER WITH IP65 GASKETS ADD -6 TO PART NUMBERS ABOVE.

IE. 0172019-6

### CABLE GLANDS



PG16-GY

- PG16
- PG21

- Cable Range 10mm - 14mm
- Cable Range 13mm - 18mm

Part Number

- PG16-GY
- PG21-GY

25A / 32A

► BLOCKS

 Technical Info (p.196)

Part Number



0172000

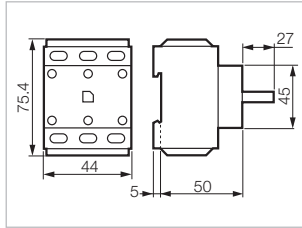

**3-pole switch body without handle**

25 A  
32 A

0172000  
0172100



0172065 0172185

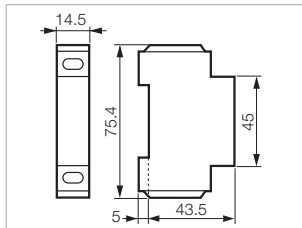

**Additional pole**  
(for use in enclosure only)

25 A  
32 A

0172075  
0172175

**Neutral pole**

25 A  
32 A

0172065  
0172165

**Junction block**  
Ground or Neutral

0172185



0172179

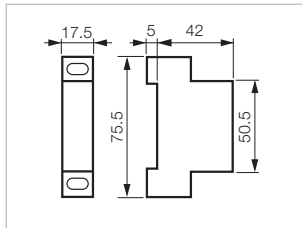

**Auxiliary contact - 10A**

NC/NO

0172179

1 pole early break

0172195



0172195

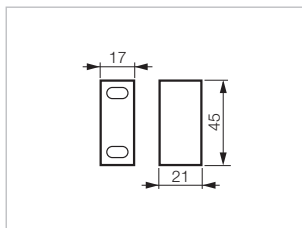



# 25A / 32A

## ▶ HANDLES

 Technical Info (p.196)

Part Number



0172601

### Padlockable presentation

Padlock with  $\varnothing 6$  to 8 mm

- 66 - Yellow/Red
- 66 - Grey
- 66 -  $\varnothing 22$  single-hole-mounting - Yellow/Red

**0172601**  
**0174601**  
**0172603**

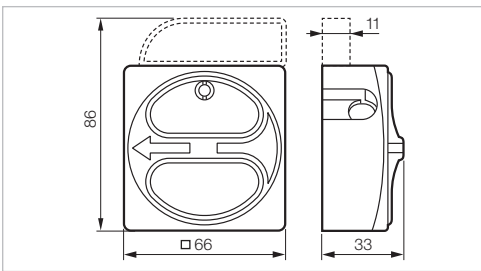

0172602

### Dim. Ref. 0172602

- A:  64
- B: 80

### Dim. ref. 0172604

- A:  48
- B: 65

### With plate, frame and handle

- 64 - Yellow/Red
- 48 -  $\varnothing 22$  single-hole-mounting - Yellow/Red

**0172602**

**0172604**

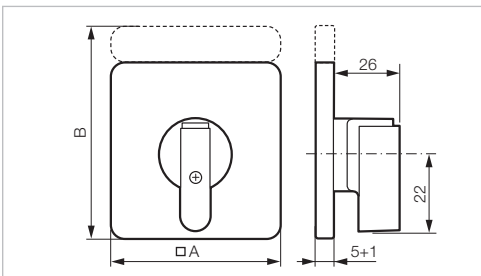

25A / 32A

▶ EMPTY ENCLOSURES

 Technical Info (p.196)

PADLOCKABLE PRESENTATION

Part Number



0172399

Dimensions 150 x 100 x 96 mm  
 Supplied with padlockable handle,  
 weatherproof seal and relay terminal  
 For 3 and 4-pole switches with and without NC/NO  
 Cable entries: 4 x PG16/M25

IP66-IK7

Grey base - yellow cover - red handle  
 Grey base - grey cover - grey handle

0172399  
 0174399

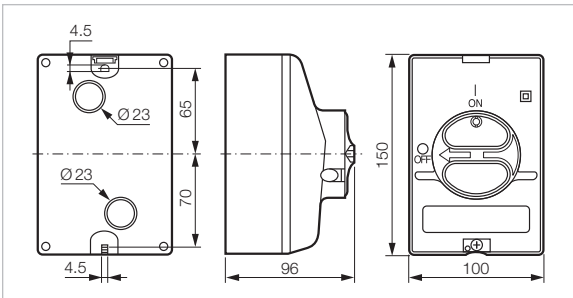

WITHOUT HANDLE



0172549

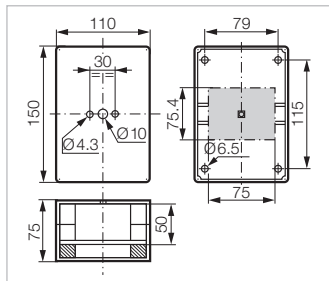

Grey - Up to 4 poles + auxiliary contact  
 150 x 110 x 75 mm  
 Cable entries: 4 x PG16

0172549



0172559

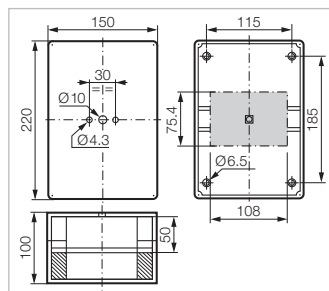

Grey - Up to 6 poles + auxiliary contact  
 220 x 150 x 100 mm  
 Cable entries: 4 x PG21

0172559

▶ ACCESSORIES

 Technical Info (p. 196)

Part Number



0172167



0174569



0172649

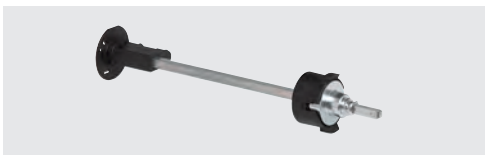

0174189



0174179



0174249

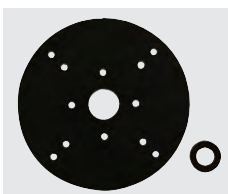

0172267



0174259



PG16-GY



STM25

**Terminal covers**

- For 3-pole body switch 0172167
- For additional pole, neutral pole or junction block 0172177
- For auxiliary contact NC/NO (pair) 0172189
- For early break auxiliary contact 0172199

**Connection terminal kit**

- Terminal connection for ground or neutral 0174449

**Self-adhesive plates (for enclosures)**

- Blank 0174599
- Engraved MAIN SWITCH 0174569

**Duty labels**

- Blank 0172629
- Engraved MAIN SWITCH 0172649

**Kit for clutch drive presentation**

- Short shaft without door interlock 0174189
- Long shaft without door interlock 0174199
- Without shaft and without door interlock 0174179

**Kit for door interlock**

0174249

**IP 65 seal kits**

**For front mounting switches and enclosures**

- Padlockable  66 or plate and frame  64 or  72 0172267

**For rear mounting switches with clutch drive**

- Padlockable  66 or plate and frame  64 or  72 0174259

**Cable Glands**

- PG16 Cable Range 10mm - 14mm PG16-GY
- PG21 Cable Range 13mm - 18mm PG21-GY

**Stepped Gland**

- M25 Cable Range 5mm - 21mm STM25

50A / 63A

▶ DOOR/PANEL MOUNTING

 Technical Info (p.196)

PADLOCKABLE PRESENTATION



0172201



0174201

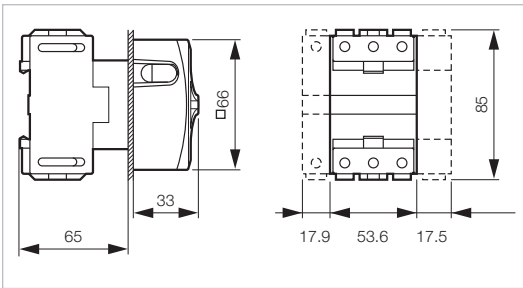

50 A

- 3P
- 3P + NC/NO
- 4P neutral on left
- 4P + NC/NO

Yellow/Red Handle  
Part Number

Grey Handle  
Part Number

- 0172201
- 0172211
- 0172221
- 0172231

- 0174201
- 0174211
- 0174221
- 0174231

63 A

- 3P
- 3P+NC/NO
- 4P neutral on left
- 4P + NC/NO

- 0172301
- 0172311
- 0172321
- 0172331

- 0174301
- 0174311
- 0174321
- 0174331

STANDARD VERSIONS IP40 RATED.

TO ORDER WITH IP65 GASKETS ADD -1 TO PART NUMBERS ABOVE.  
IE. 0172201-1

COMPONENTS AND ACCESSORIES

Part Number



0172300

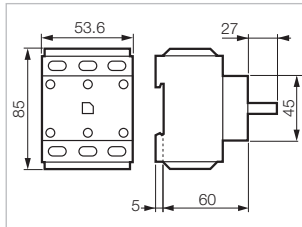

3-pole switch body without handle

- 50 A
- 63 A

- 0172200
- 0172300

Additional pole

- 50 A
- 63 A

- 0172275
- 0172375

Neutral pole

- 50 A
- 63 A

- 0172265
- 0172365

Junction block  
Ground or Neutral

0172385

Auxiliary contact - 10A

NC/NO

0172179

IP65 Seal Kit

0172267

Replacement Handle

- 66 - Yellow/Red
- 66 - Grey

- 0172601
- 0174601



0172375

0172385

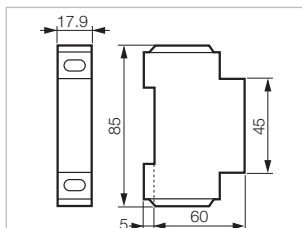

50A / 63A

▶ DOOR/PANEL MOUNTING

 Technical Info (p.196)

NON- PADLOCKABLE PRESENTATION

Yellow/Red Handle  
Part Number

Grey Handle  
Part Number



0172202



0174202

50 A

- 3P
- 3P + NC/NO
- 4P neutral on left
- 4P + NC/NO

- 0172202
- 0172212
- 0172222
- 0172232

- 0174202
- 0174212
- 0174222
- 0174232

63 A

- 3P
- 3P + NC/NO
- 4P neutral on left
- 4P + NC/NO

- 0172302
- 0172312
- 0172322
- 0172332

- 0174302
- 0174312
- 0174322
- 0174332

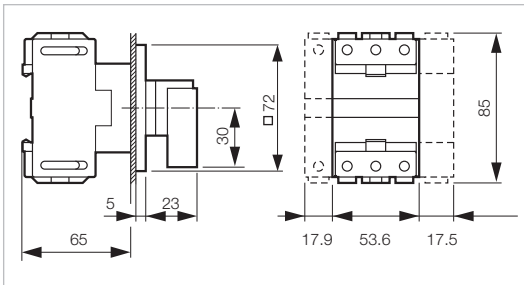

STANDARD VERSIONS IP40 RATED.

TO ORDER WITH IP65 GASKETS ADD -1 TO PART NUMBERS ABOVE.  
IE. 0172002-1

COMPONENTS AND ACCESSORIES

Part Number



0172179

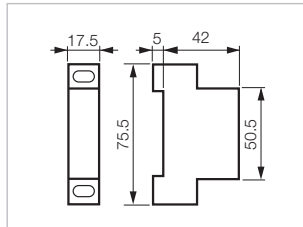

3-pole switch body without handle

- 50 A
- 63 A

- 0172200
- 0172300

Additional pole

- 50 A
- 63 A

- 0172275
- 0172375

Neutral pole

- 50 A
- 63 A

- 0172265
- 0172365

Junction block

Ground or Neutral

0172385

Auxiliary contact - 10A

NC/NO

0172179

IP65 Seal Kit

0172267

Replacement Handle

- 72 - Yellow/Red
- 72 - Grey

- 0172612
- 0174612



0172395

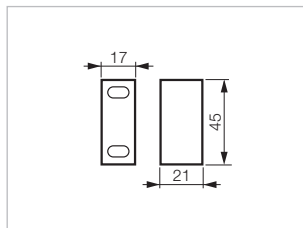

# 50 A / 63A

## ► DIN-RAIL IN-PANEL MOUNTING

 Technical Info (p.196)

### PADLOCKABLE PRESENTATION

Grey Handle  
Part Number



0174205

#### 50 A

- 3P
- 3P + NC/NO
- 4P neutral on left
- 4P + NC/NO

- 0174205
- 0174215
- 0174225
- 0174235

#### 63 A

- 3P
- 3P+NC/NO
- 4P neutral on left
- 4P + NC/NO

- 0174305
- 0174315
- 0174325
- 0174335

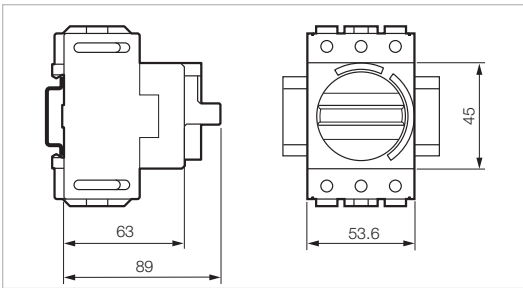

### COMPONENTS AND ACCESSORIES

Part Number



0172300

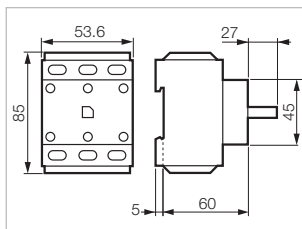

#### 3-pole switch body without handle

- 50 A
- 63 A

- 0172200
- 0172300

#### Additional pole

- 50 A
- 63 A

- 0172275
- 0172375

#### Neutral pole

- 50 A
- 63 A

- 0172265
- 0172365

#### Junction block Ground or Neutral

- 0172385

#### Auxiliary contact - 10A

- NC/NO

- 0172179



0172375

0172385

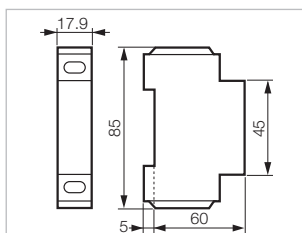

50A / 63A

▶ DOOR INTERLOCK MOUNTING - NO METAL SHAFT EXTENSION



PADLOCKABLE PRESENTATION

Yellow/Red Handle  
Part Number

Grey Handle  
Part Number



0165209NS

50 A

3P  
3P + NC/NO  
4P neutral on left  
4P + NC/NO

0165209NS  
0165219NS  
0165229NS  
0165239NS

0168209NS  
0168219NS  
0168229NS  
0168239NS



0168209NS

63 A

3P  
3P + NC/NO  
4P neutral on left  
4P + NC/NO

0165309NS  
0165319NS  
0165329NS  
0165339NS

0168309NS  
0168319NS  
0168329NS  
0168339NS

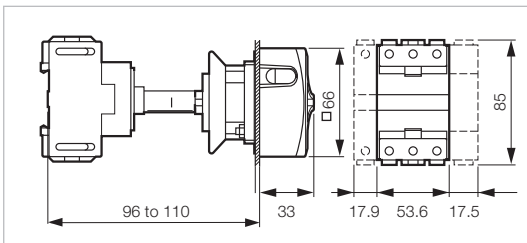

STANDARD VERSIONS IP40 RATED.

TO ORDER WITH IP65 GASKETS ADD -1 TO PART NUMBERS ABOVE.  
IE. 0165209NS-1

COMPONENTS AND ACCESSORIES

Part Number



0172179

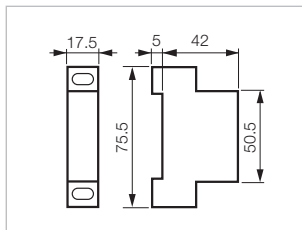

3-pole switch body without handle

50 A  
63 A

0172200  
0172300

Additional pole

50 A  
63 A

0172275  
0172375

Neutral pole

50 A  
63 A

0172265  
0172365

Junction block

Ground or Neutral

0172385

Auxiliary contact - 10A

NC/NO

0172179

IP65 Seal Kit

0174259

Replacement Handle, Plate, and Frame

- 66 - Yellow/Red
- 66 - Grey

0172601  
0174601



0172395

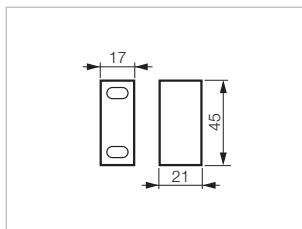

50A / 63A

▶ DOOR INTERLOCK MOUNTING - SHORT METAL SHAFT EXTENSION



PADLOCKABLE PRESENTATION

Yellow/Red Handle  
Part Number

Grey Handle  
Part Number

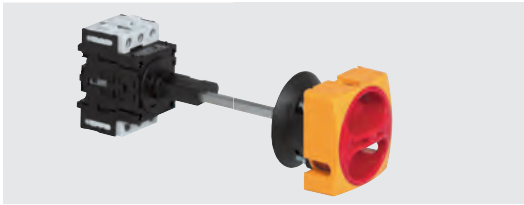

0165209SS

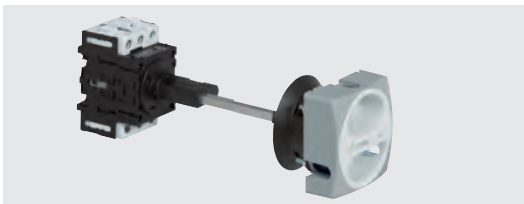

0168209SS

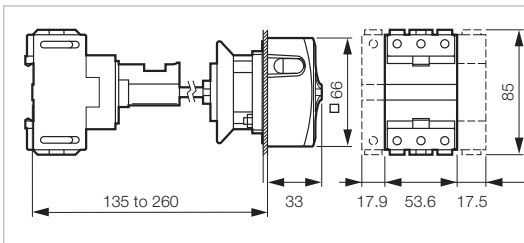

50 A

- 3P
- 3P + NC/NO
- 4P neutral on left
- 4P + NC/NO

- 0165209SS
- 0165219SS
- 0165229SS
- 0165239SS

- 0168209SS
- 0168219SS
- 0168229SS
- 0168239SS

63 A

- 3P
- 3P + NC/NO
- 4P neutral on left
- 4P + NC/NO

- 0165309SS
- 0165319SS
- 0165329SS
- 0165339SS

- 0168309SS
- 0168319SS
- 0168329SS
- 0168339SS

STANDARD VERSIONS IP40 RATED.

TO ORDER WITH IP65 GASKETS ADD -1 TO PART NUMBERS ABOVE.  
IE. 0165209SS-1

COMPONENTS AND ACCESSORIES

Part Number



0172300

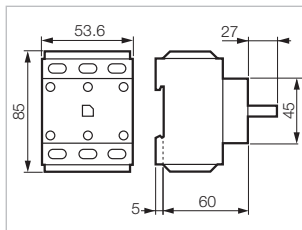

3-pole switch body without handle

- 50 A
- 63 A

- 0172200
- 0172300

Additional pole

- 50 A
- 63 A

- 0172275
- 0172375

Neutral pole

- 50 A
- 63 A

- 0172265
- 0172365

Junction block  
Ground or Neutral

- 0172385

Auxiliary contact - 10A

- NC/NO

- 0172179

IP65 Seal Kit

- 0174259

Replacement Handle

- 66 - Yellow/Red
- 66 - Grey

- 0172601
- 0174601



0172375

0172385

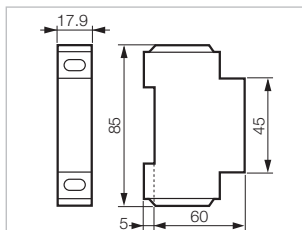



50A / 63A

▶ DOOR INTERLOCK MOUNTING - LONG METAL SHAFT EXTENSION



PADLOCKABLE PRESENTATION

Yellow/Red Handle  
Part Number

Grey Handle  
Part Number

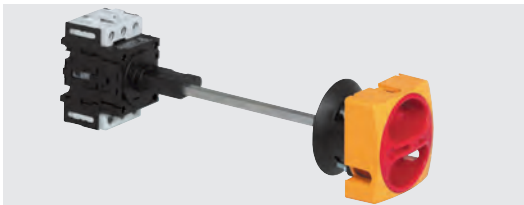

0165209LS

50 A

- 3P
- 3P + NC/NO
- 4P neutral on left
- 4P + NC/NO

- 0165209LS
- 0165219LS
- 0165229LS
- 0165239LS

- 0168209LS
- 0168219LS
- 0168229LS
- 0168239LS

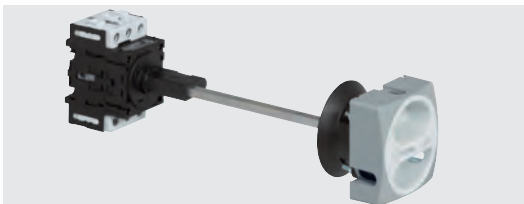

0168209LS

63 A

- 3P
- 3P + NC/NO
- 4P neutral on left
- 4P + NC/NO

- 0165309LS
- 0165319LS
- 0165329LS
- 0165339LS

- 0168309LS
- 0168319LS
- 0168329LS
- 0168339LS

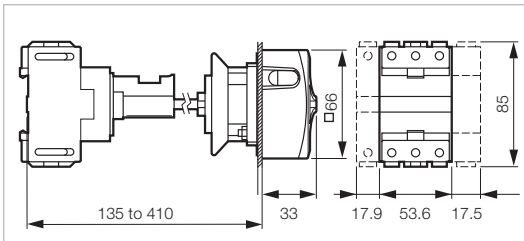

STANDARD VERSIONS IP40 RATED.

TO ORDER WITH IP65 GASKETS ADD -1 TO PART NUMBERS ABOVE.  
IE. 0165209LS-1

COMPONENTS AND ACCESSORIES

Part Number



0172179

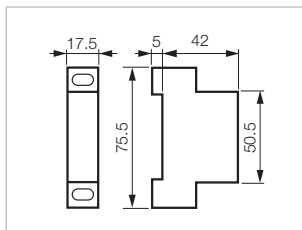

3-pole switch body without handle

- 50 A
- 63 A

- 0172200
- 0172300

Additional pole

- 50 A
- 63 A

- 0172275
- 0172375

Neutral pole

- 50 A
- 63 A

- 0172265
- 0172365

Junction block

Ground or Neutral

- 0172385

Auxiliary contact - 10A

NC/NO

- 0172179

IP65 Seal Kit

- 0174259

Replacement Handle

- 66 - Yellow/Red
- 66 - Grey

- 0172601
- 0174601



0172395

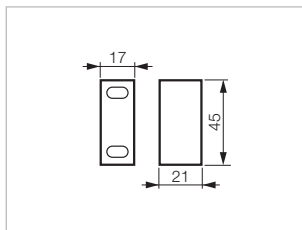

# 50A / 63A

## ENCLOSURES

 Technical Info (p. 196)

### PADLOCKABLE PRESENTATION

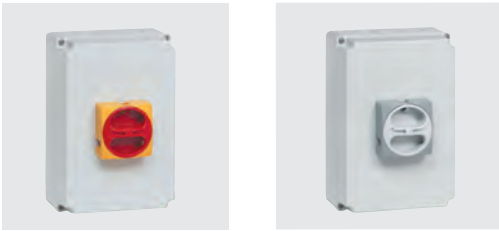

0172261

0174261

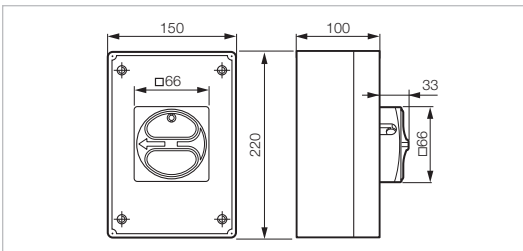

Cable entries: 4 x PG21

#### 50 A

- 3P
- 3P + NC/NO
- 4P neutral on left
- 4P + NC/NO

Yellow/Red Handle  
Part Number

- 0172261
- 0172271
- 0172281
- 0172291

Grey Handle  
Part Number

- 0174261
- 0174271
- 0174281
- 0174291

#### 63 A

- 3P
- 3P+NC/NO
- 4P neutral on left
- 4P + NC/NO

- 0172361
- 0172371
- 0172381
- 0172391

- 0174361
- 0174371
- 0174381
- 0174391

STANDARD VERSIONS IP40 RATED.

TO ORDER WITH IP65 GASKETS ADD -6 TO PART NUMBERS ABOVE.  
IE. 0172261-6

### PADLOCKABLE PRESENTATION



0172209

0174209

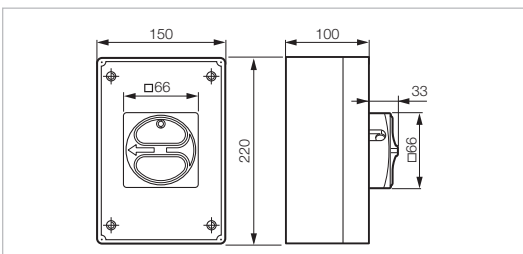

Cable entries: 4 x PG29

#### 50 A

- 6P
- 6P + NC/NO

Yellow/Red Handle  
Part Number

- 0172209
- 0172229

Grey Handle  
Part Number

- 0174209
- 0174229

#### 63 A

- 6P
- 6P+NC/NO

- 0172309
- 0172329

- 0174309
- 0174329

STANDARD VERSIONS IP40 RATED.

TO ORDER WITH IP65 GASKETS ADD -6 TO PART NUMBERS ABOVE.  
IE. 0172209-6

### CABLE GLANDS



PG21-GY

- PG21
- PG29

- Cable Range 13mm - 18mm
- Cable Range 18mm - 25mm

Part Number

- PG21-GY
- PG29-GY

# 50A / 63A

## ENCLOSURES

 Technical Info (p.196)

### NON- PADLOCKABLE PRESENTATION



0172262

0174262

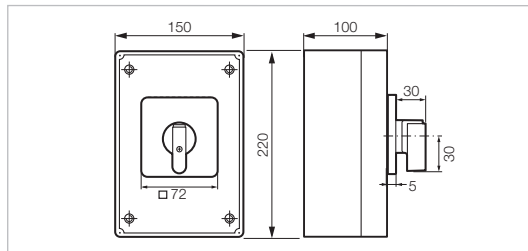

Cable entries: 4 x PG21

#### 50 A

- 3P
- 3P + NC/NO
- 4P neutral on left
- 4P + NC/NO

Yellow/Red Handle  
Part Number

- 0172262
- 0172272
- 0172282
- 0172292

Grey Handle  
Part Number

- 0174262
- 0174272
- 0174282
- 0174292

#### 63 A

- 3P
- 3P+NC/NO
- 4P neutral on left
- 4P + NC/NO

- 0172362
- 0172372
- 0172382
- 0172392

- 0174362
- 0174372
- 0174382
- 0174392

**STANDARD VERSIONS IP40 RATED.  
TO ORDER WITH IP65 GASKETS ADD -6 TO PART NUMBERS ABOVE.  
IE. 0172262-6**

### NON- PADLOCKABLE PRESENTATION



0172219

0174219

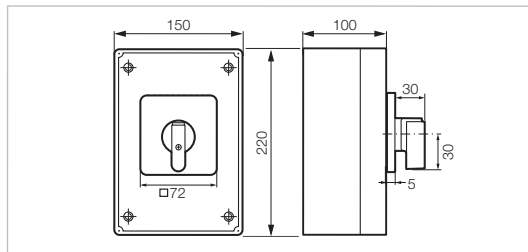

Cable entries: 4 x PG29

#### 50 A

- 6P
- 6P + NC/NO

Yellow/Red Handle  
Part Number

- 0172219
- 0172239

Grey Handle  
Part Number

- 0174219
- 0174239

#### 63 A

- 6P
- 6P+NC/NO

- 0172319
- 0172339

- 0174319
- 0174339

**STANDARD VERSIONS IP40 RATED.  
TO ORDER WITH IP65 GASKETS ADD -6 TO PART NUMBERS ABOVE.  
IE. 0172219-6**

### CABLE GLANDS



PG21-GY

- PG21
- PG29

- Cable Range 13mm - 18mm
- Cable Range 18mm - 25mm

Part Number

- PG21-GY
- PG29-GY

50A / 63A

► BLOCKS

 Technical Info (p.196)

Part Number



0172300

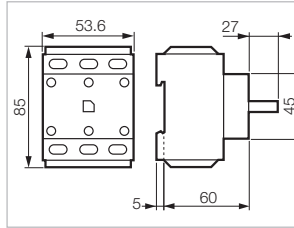

**3-pole body switch without presentation**

50 A  
63 A

**0172200**  
**0172300**



0172375

0172385

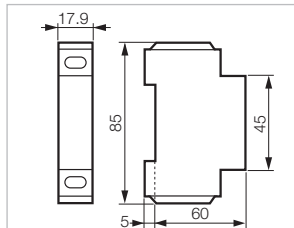

**Additional pole**  
(for use in enclosure only)

50 A  
63 A

**0172275**  
**0172375**

**Neutral pole**

50 A  
63 A

**0172265**  
**0172365**

**Junction block**

Ground or Neutral

**0172385**



0172179

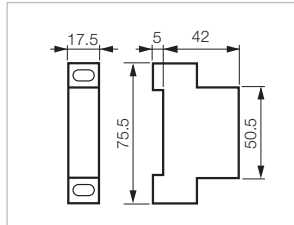

**Auxiliary contact - 10A**

NC/NO

1 pole early break

**0172179**

**0172395**



0172395

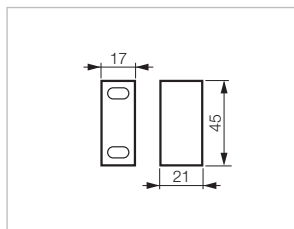

50A / 63A

► HANDLES

 Technical Info (p.196)

Part Number



0172601

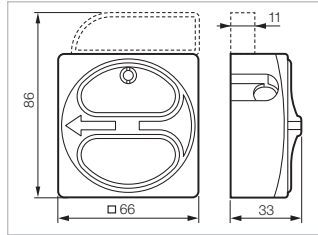

**Padlockable presentation**  
Padlock:  $\varnothing$  6 to 8 mm

- 66 - Yellow/Red
- 66 - Grey

**0172601**  
**0174601**



0172612

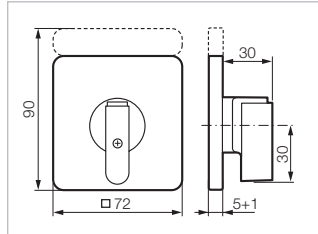

**With plate, frame and handle**

- 72 - Yellow/Red
- 72 - Grey

**0172612**  
**0174612**

► EMPTY ENCLOSURES

WITHOUT HANDLE



0172569

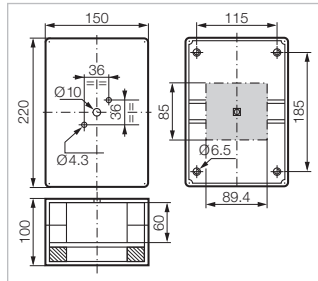

Grey - Up to 4 poles + auxiliary contact  
220 x 150 x 100 mm  
Cable entries: 4 x PG21

**0172569**



0172579

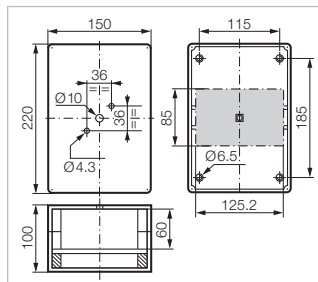







Grey - Up to 6 poles + auxiliary contact  
220 x 150 x 100 mm  
Cable entries: 4 x PG29

**0172579**

50A / 63A

▶ ACCESSORIES

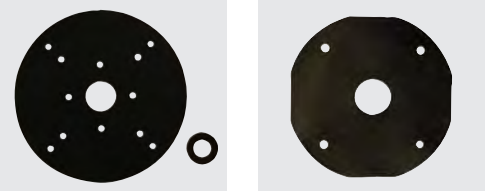
 Technical Info (p. 196)

		Part Number
		
0172367	<b>Terminal covers</b>	
	For 3-pole switch	<b>0172367</b>
	For additional pole, neutral pole or junction block	<b>0172377</b>
	For NC/NO auxiliary contact (pair)	<b>0172189</b>
	For early break auxiliary contact	<b>0172199</b>
		
0172649	<b>Duty labels</b>	
	Blank	<b>0172629</b>
	Engraved INTER PRINCIPAL	<b>0172639</b>
	Engraved MAIN SWITCH	<b>0172649</b>
		
0174189	<b>Kit for clutch drive presentation</b>	
	Short shaft without door interlock	<b>0174189</b>
	Long shaft without door interlock	<b>0174199</b>
	Without shaft and without door interlock	<b>0174179</b>
		
0174179	<b>kit for door interlock</b>	<b>0174249</b>
0174249		
	<b>IP 65 seal kit</b>	
	<b>For front mounting switches and enclosures</b>	
	Padlockable <input type="checkbox"/> 66 or plate and frame <input type="checkbox"/> 64 or <input type="checkbox"/> 72	<b>0172267</b>
	<b>For rear mounting with clutch drive</b>	
	Padlockable <input type="checkbox"/> 66 or plate and frame <input type="checkbox"/> 64 or <input type="checkbox"/> 72	<b>0174259</b>
		
0172267	<b>Cable Glands</b>	
0174259	PG21 Cable Range 13mm - 18mm	<b>PG21-GY</b>
	PG29 Cable Range 18mm - 25mm	<b>PG29-GY</b>
		
PG21-GY		

# 80A / 100A

## ▶ DOOR/PANEL MOUNTING

 Technical Info (p. 196)

### PADLOCKABLE PRESENTATION



0172401



0174501

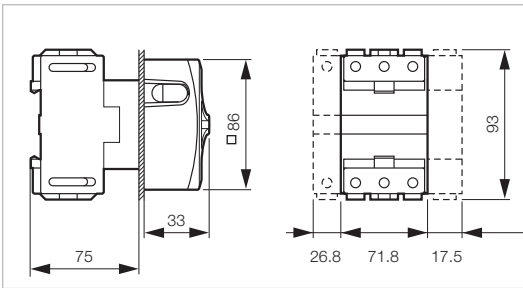

#### 80 A

- 3P
- 3P + NC/NO
- 4P neutral on left
- 4P + NC/NO

Yellow/Red Handle  
Part Number

Grey Handle  
Part Number

- 0172401
- 0172411
- 0172421
- 0172431

- 0174401
- 0174411
- 0174421
- 0174431

#### 100 A

- 3P
- 3P+NC/NO
- 4P neutral on left
- 4P + NC/NO

- 0172501
- 0172511
- 0172521
- 0172531

- 0174501
- 0174511
- 0174521
- 0174531

**STANDARD VERSIONS IP40 RATED.**  
**TO ORDER WITH IP65 GASKETS ADD -1 TO PART NUMBERS ABOVE.**  
**IE. 0172401-1**

### COMPONENTS AND ACCESSORIES

Part Number



0172400

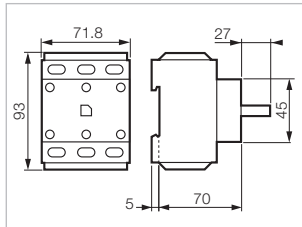

#### 3-pole switch body without handle

- 80 A
- 100 A

- 0172400
- 0172500

#### Additional pole

- 80 A
- 100 A

- 0172475
- 0172575

#### Neutral pole

- 80 A
- 100 A

- 0172465
- 0172565

#### Junction block Ground or Neutral

- 0172585

#### Auxiliary contact - 10A

- NC/NO

- 0172179

#### IP65 Seal Kit

- 0172277

#### Replacement Handle

- 86 - Yellow/Red
- 86 - Grey

- 0172621
- 0174621



0172475

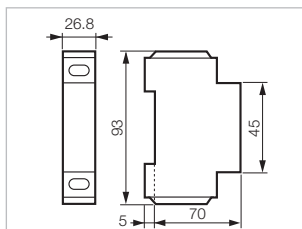

# 80A / 100A

## ▶ DOOR/PANEL MOUNTING

 Technical Info (p. 196)

### NON- PADLOCKABLE PRESENTATION



0172402



0174502

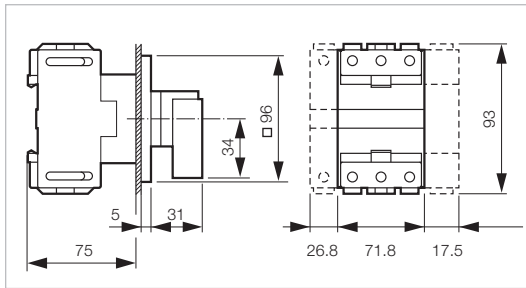

#### 80 A

	Yellow/Red Handle Part Number	Grey Handle Part Number
3P	0172402	0174402
3P + NC/NO	0172412	0174412
4P neutral on left	0172422	0174422
4P + NC/NO	0172432	0174432

#### 100 A

3P	0172502	0174502
3P + NC/NO	0172512	0174512
4P neutral on left	0172522	0174522
4P + NC/NO	0172532	0174532

**STANDARD VERSIONS IP40 RATED.**  
**TO ORDER WITH IP65 GASKETS ADD -1 TO PART NUMBERS ABOVE.**  
**IE. 0172402-1**

### COMPONENTS AND ACCESSORIES



0172400

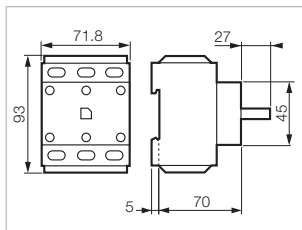

#### 3-pole switch body without handle

80 A	0172400
100 A	0172500

#### Additional pole

80 A	0172475
100 A	0172575

#### Neutral pole

80 A	0172465
100 A	0172565

#### Junction block Ground or Neutral

0172585

#### Auxiliary contact - 10A

NC/NO	0172179
-------	---------

#### IP65 Seal Kit

0172277

#### Replacement Handle

<input type="checkbox"/> g6 - Yellow/Red	0172622
<input type="checkbox"/> g6 - Grey	0174622



0172475

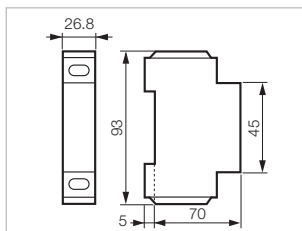



# 80A / 100A

## ► DIN-RAIL IN-PANEL MOUNTING



Technical Info (p. 196)

### PADLOCKABLE PRESENTATION

Grey Handle  
Part Number



0174405

#### 80 A

3P  
3P + NC/NO  
4P neutral on left  
4P + NC/NO

0174405  
0174415  
0174425  
0174435

#### 100 A

3P  
3P+NC/NO  
4P neutral on left  
4P + NC/NO

0174505  
0174515  
0174525  
0174535

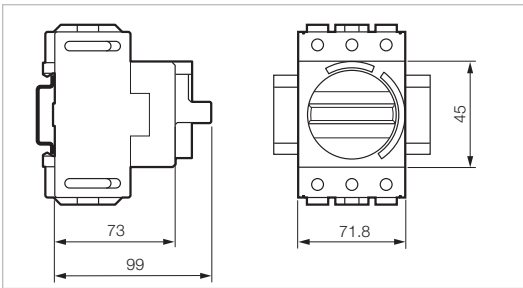

### COMPONENTS AND ACCESSORIES

Part Number



0172179

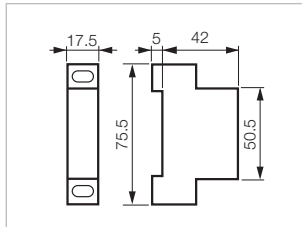

#### 3-pole switch body without handle

80 A  
100 A

0172400  
0172500

#### Additional pole

80 A  
100 A

0172475  
0172575

#### Neutral pole

80 A  
100 A

0172465  
0172565

#### Junction block

Ground or Neutral

0172585

#### Auxiliary contact - 10A

NC/NO

0172179

# 80A / 100A

## ▶ DOOR INTERLOCK MOUNTING - NO METAL SHAFT EXTENSION

 Technical Info (p.196)

### PADLOCKABLE PRESENTATION

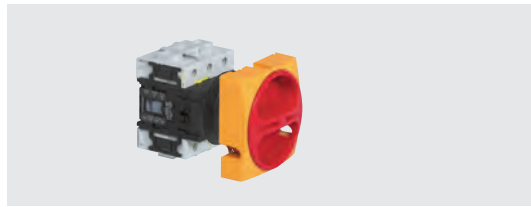

0165409NS

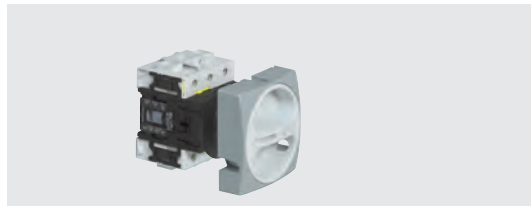

0168509NS

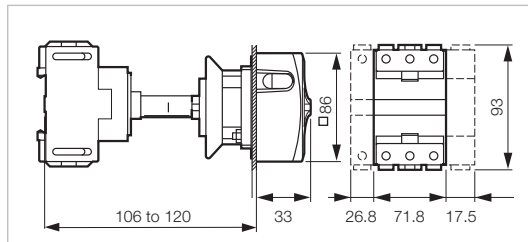

#### 80 A

- 3P
- 3P + NC/NO
- 4P neutral on left
- 4P + NC/NO

- 0165409NS
- 0165419NS
- 0165429NS
- 0165439NS

- 0168409NS
- 0168419NS
- 0168429NS
- 0168439NS

#### 100 A

- 3P
- 3P + NC/NO
- 4P neutral on left
- 4P + NC/NO

- 0165509NS
- 0165519NS
- 0165529NS
- 0165539NS

- 0168509NS
- 0168519NS
- 0168529NS
- 0168539NS

**STANDARD VERSIONS IP40 RATED.**  
**TO ORDER WITH IP65 GASKETS ADD -1 TO PART NUMBERS ABOVE.**  
**IE. 0165409NS-1**

### COMPONENTS AND ACCESSORIES



0172400

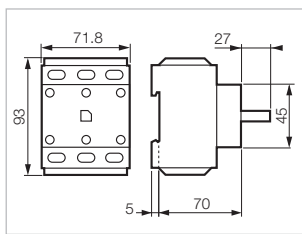

#### 3-pole switch body without handle

- 80 A
- 100 A

- 0172400
- 0172500

#### Additional pole

- 80 A
- 100 A

- 0172475
- 0172575

#### Neutral pole

- 80 A
- 100 A

- 0172465
- 0172565

#### Junction block Ground or Neutral

- 0172585

#### Auxiliary contact - 10A

- NC/NO

- 0172179

#### IP65 Seal Kit

- 0174269

#### Replacement Handle

- 86 - Yellow/Red
- 86 - Grey

- 0172621
- 0174621



0172475

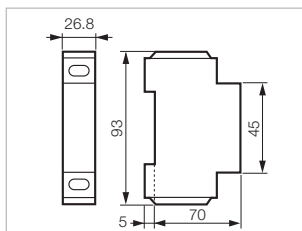

80A / 100A

▶ DOOR INTERLOCK MOUNTING - SHORT METAL SHAFT EXTENSION



PADLOCKABLE PRESENTATION

Yellow/Red Handle  
Part Number

Grey Handle  
Part Number

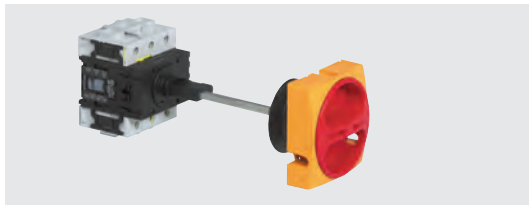

0165409SS

80 A

- 3P
- 3P + NC/NO
- 4P neutral on left
- 4P + NC/NO

- 0165409SS
- 0165419SS
- 0165429SS
- 0165439SS

- 0168409SS
- 0168419SS
- 0168429SS
- 0168439SS

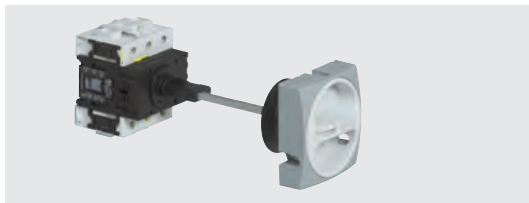

0168509SS

100 A

- 3P
- 3P + NC/NO
- 4P neutral on left
- 4P + NC/NO

- 0165509SS
- 0165519SS
- 0165529SS
- 0165539SS

- 0168509SS
- 0168519SS
- 0168529SS
- 0168539SS

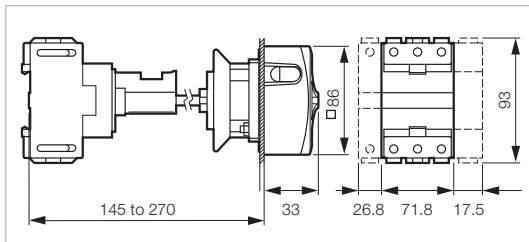

STANDARD VERSIONS IP40 RATED.

TO ORDER WITH IP65 GASKETS ADD -1 TO PART NUMBERS ABOVE.  
IE. 0165409SS-1

COMPONENTS AND ACCESSORIES

Part Number



0172179

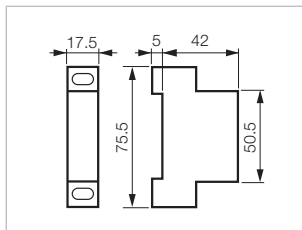

3-pole switch body without handle

- 80 A
- 100 A

- 0172400
- 0172500

Additional pole

- 80 A
- 100 A

- 0172475
- 0172575

Neutral pole

- 80 A
- 100 A

- 0172465
- 0172565

Junction block

Ground or Neutral

- 0172585

Auxiliary contact - 10A

NC/NO

- 0172179

IP65 Seal Kit

- 0174269

Replacement Handle

- 86 - Yellow/Red
- 86 - Grey

- 0172621
- 0174621

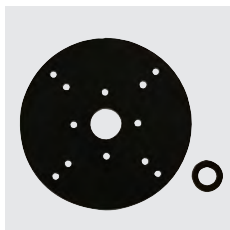

0174269

80A / 100A

▶ DOOR INTERLOCK MOUNTING - LONG METAL SHAFT EXTENSION



Technical Info (p.196)

PADLOCKABLE PRESENTATION

Yellow/Red Handle  
Part Number

Grey Handle  
Part Number

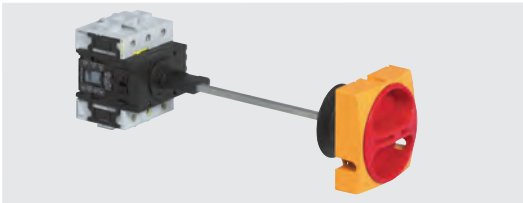

0165409LS

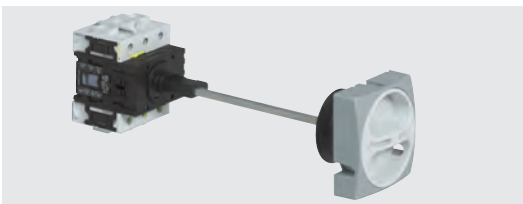

0168509LS

80 A

- 3P
- 3P + NC/NO
- 4P neutral on left
- 4P + NC/NO

- 0165409LS
- 0165419LS
- 0165429LS
- 0165439LS

- 0168409LS
- 0168419LS
- 0168429LS
- 0168439LS

100 A

- 3P
- 3P + NC/NO
- 4P neutral on left
- 4P + NC/NO

- 0165509LS
- 0165519LS
- 0165529LS
- 0165539LS

- 0168509LS
- 0168519LS
- 0168529LS
- 0168539LS

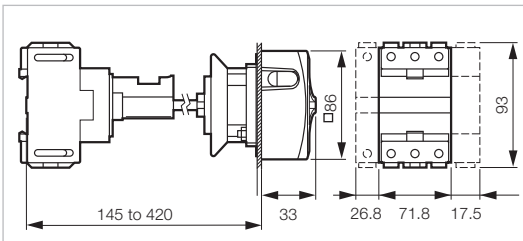

STANDARD VERSIONS IP40 RATED.

TO ORDER WITH IP65 GASKETS ADD -1 TO PART NUMBERS ABOVE.  
IE. 0165409LS-1

COMPONENTS AND ACCESSORIES

Part Number



0172400

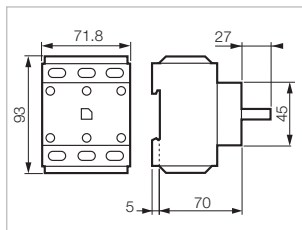

3-pole switch body without handle

- 80 A
- 100 A

- 0172400
- 0172500

Additional pole

- 80 A
- 100 A

- 0172475
- 0172575

Neutral pole

- 80 A
- 100 A

- 0172465
- 0172565

Junction block  
Ground or Neutral

- 0172585

Auxiliary contact

- NC/NO

- 0172179

IP65 Seal Kit

- 0174269

Replacement Handle

- 86 - Yellow/Red
- 86 - Grey

- 0172621
- 0174621



0172475

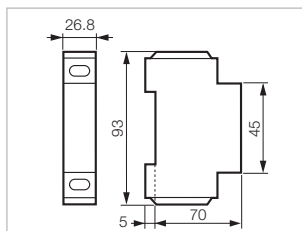

## 80A / 100A

### ► ENCLOSURES



Technical Info (p.196)

#### PADLOCKABLE PRESENTATION



0172461

0174561

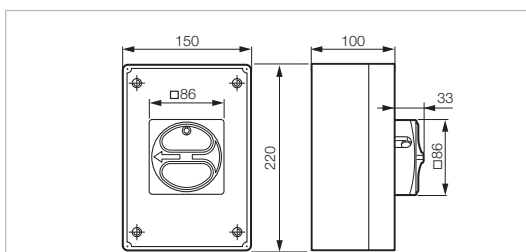

Cable entries: 4 x PG29

#### 80 A

3P  
3P + NC/NO  
4P neutral on left  
4P + NC/NO

Yellow/Red Handle  
Part Number

0172461  
0172471  
0172481  
0172491

Grey Handle  
Part Number

0174461  
0174471  
0174481  
0174491

#### 100 A

3P  
3P+NC/NO  
4P neutral on left  
4P + NC/NO

0172561  
0172571  
0172581  
0172591

0174561  
0174571  
0174581  
0174591

STANDARD VERSIONS IP40 RATED.

TO ORDER WITH IP65 GASKETS ADD -6 TO PART NUMBERS ABOVE.

IE. 0172461-6

#### PADLOCKABLE PRESENTATION



0172409

0174509

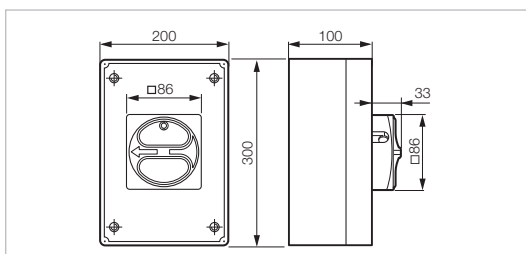

Cable entries: 4 x PG29 and 4 x PG21

#### 80 A

6P  
6P + NC/NO

Yellow/Red Handle  
Part Number

0172409  
0172429

Grey Handle  
Part Number

0174409  
0174429

#### 100 A

6P  
6P+NC/NO

0172509  
0172529

0174509  
0174529

STANDARD VERSIONS IP40 RATED.

TO ORDER WITH IP65 GASKETS ADD -6 TO PART NUMBERS ABOVE.

IE. 0172409-6

#### CABLE GLANDS

Part Number



PG21-GY

PG21  
PG29

Cable Range 13mm - 18mm  
Cable Range 18mm - 25mm

PG21-GY  
PG29-GY

# 80A / 100A

## ENCLOSURES

 Technical Info (p.196)

### NON- PADLOCKABLE PRESENTATION



0172462

0174562

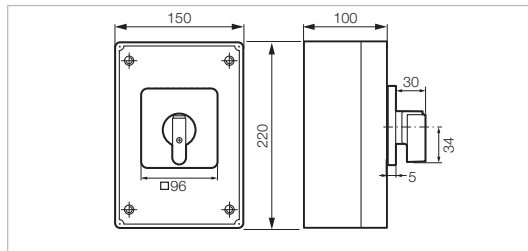

Cable entries: 4 x PG29

#### 80 A

	Yellow/Red Handle Part Number	Grey Handle Part Number
3P	0172462	0174462
3P + NC/NO	0172472	0174472
4P neutral on left	0172482	0174482
4P + NC/NO	0172492	0174492

#### 100 A

3P	0172562	0174562
3P+NC/NO	0172572	0174572
4P neutral on left	0172582	0174582
4P + NC/NO	0172592	0174592

STANDARD VERSIONS IP40 RATED.

TO ORDER WITH IP65 GASKETS ADD -6 TO PART NUMBERS ABOVE.

IE. 0172462-6

### NON- PADLOCKABLE PRESENTATION



0172419

0174519

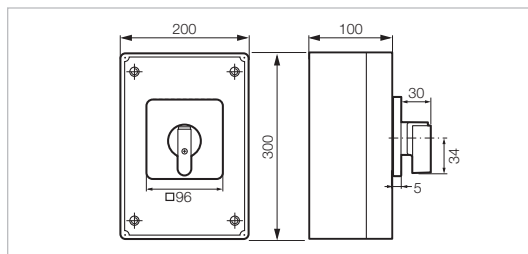

Cable entries: 4 x PG29 and 4 x PG21

#### 80 A

6P	0172419	0174419
6P + NC/NO	0172439	0174439

#### 100 A

6P	0172519	0174519
6P+NC/NO	0172539	0174539

STANDARD VERSIONS IP40 RATED.

TO ORDER WITH IP65 GASKETS ADD -6 TO PART NUMBERS ABOVE.

IE. 0172419-6

### CABLE GLANDS



PG21-GY

		Part Number
PG21	Cable Range 13mm - 18mm	PG21-GY
PG29	Cable Range 18mm - 25mm	PG29-GY

80A / 100A

► BLOCKS

 Technical Info (p.196)

Part Number

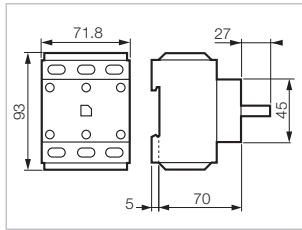

**3-pole body switch without presentation**

80 A  
100 A

**0172400**  
**0172500**

0172400



**Additional pole**  
(for use in enclosure only)

80 A  
100 A

**0172475**  
**0172575**

0172475

0172465

**Neutral pole**

80 A  
100 A

**0172465**  
**0172565**

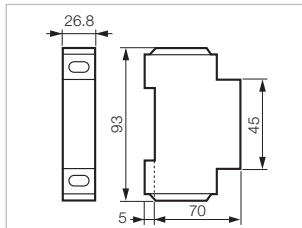

**Junction block**  
Ground or Neutral

**0172585**

0172585

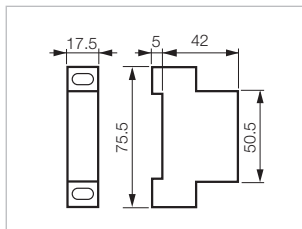

**Auxiliary contact - 10A**

NC/NO

**0172179**

1 pole early break

**0172595**

0172179

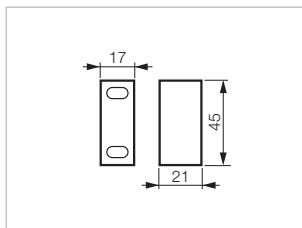

0172595

# 80A / 100A

## ▶ HANDLES

 Technical Info (p.196)

Part Number



0172621

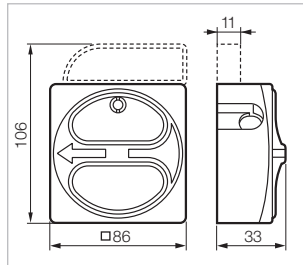

### Padlockable presentation

Padlock:  $\varnothing$  6 to 8 mm

- 86 - Yellow/Red
- 86 - Grey

**0172621**  
**0174621**



0172622

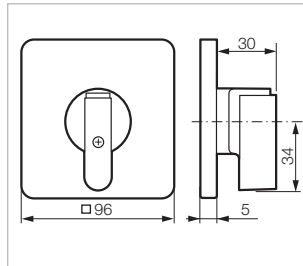

### With plate, frame and handle

- 96 - Yellow/Red
- 96 - Grey

**0172622**  
**0174622**

## ▶ EMPTY ENCLOSURES

### WITHOUT HANDLE



0172589

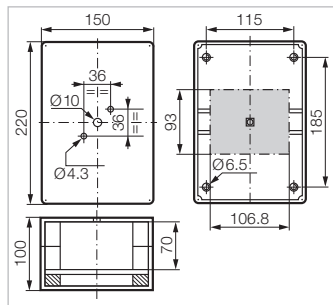

Grey - Up to 3 poles + auxiliary contact  
220 x 150 x 100 mm  
Cable entries: 4 x PG29

**0172589**



0172599

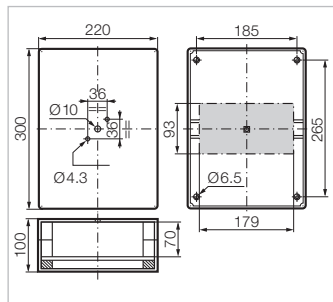

Grey - Up to 6 poles + auxiliary contact  
300 x 200 x 100 mm  
Cable entries: 4 x PG29 and 4 x PG21







**0172599**

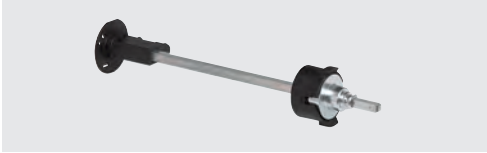

80A / 100A

▶ ACCESSORIES

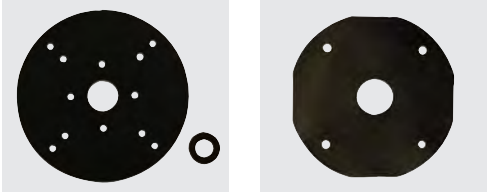
 Technical Info (p. 196)

		Part Number
 0172567	<b>Terminal covers</b>	
	For 3-pole body switch	<b>0172567</b>
	For additional pole, neutral pole or junction block	<b>0172577</b>
	For NC/NO auxiliary contact (pair)	<b>0172189</b>
	For early break auxiliary contact	<b>0172199</b>
 0172649	<b>Duty labels</b>	
	Blank	<b>0172629</b>
	Engraved MAIN SWITCH	<b>0172649</b>
 0174189	<b>Kit for clutch drive presentation</b>	
	Short shaft without door interlock	<b>0174189</b>
	Long shaft without door interlock	<b>0174199</b>
	Without shaft and without door interlock	<b>0174179</b>
 0174179      0174249	<b>Kit for door interlock</b>	
		<b>0174249</b>
 0172277      0174269	<b>IP 65 seal kit</b>	
	<b>For front mounting switches and enclosures</b>	
	Padlockable <input type="checkbox"/> 86 or plate and frame <input type="checkbox"/> 96	<b>0172277</b>
	<b>For rear mounting with clutch drive</b>	
	Padlockable <input type="checkbox"/> 86 or plate and frame <input type="checkbox"/> 96	<b>0174269</b>
 PG21-GY	<b>Cable Glands</b>	
	PG21	Cable Range 13mm - 18mm
	PG29	Cable Range 18mm - 25mm
		<b>PG21-GY</b>
		<b>PG29-GY</b>

# Enclosure Selection Guide

## ► 25A / 32A



Example: switch disconnecter 32 A  
Enclosed 4 poles,  
padlockable presentation

Enclosure 150 x 100 x 96 mm

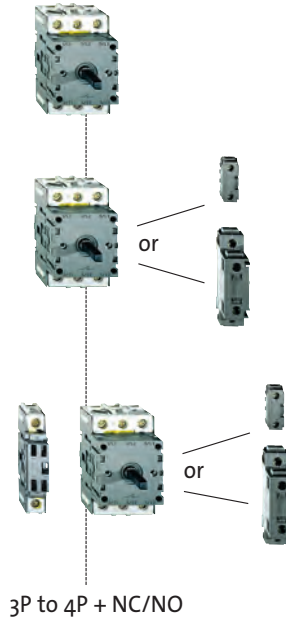

Enclosure 220 x 150 x 100 mm

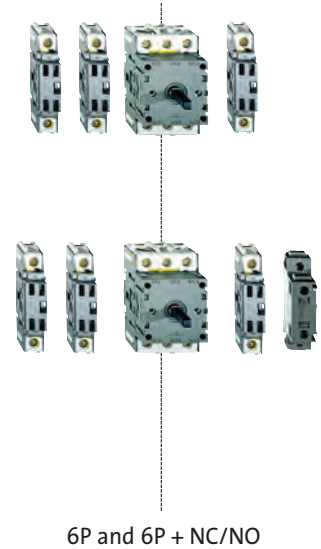

## ► 50A / 63A



Example: switch disconnecter 50 A  
Enclosed 6 poles,  
Plate, frame and handle presentation

Enclosure 220 x 150 x 100mm

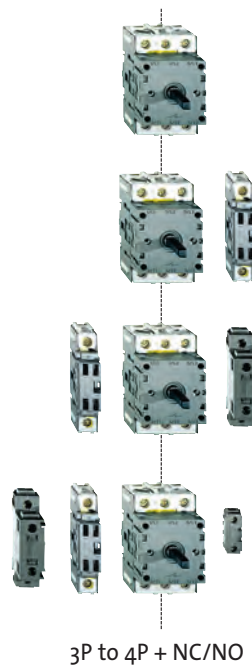

Enclosure 220 x 150 x 100 mm

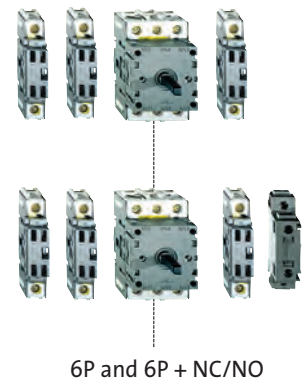

# Enclosure Selection Guide

▶ 80A / 100A

Enclosure 220 x 150 x 100 mm

Enclosure 300 x 220 x 100 mm



Example: switch disconnector 100 A  
Enclosed 4 poles,  
padlockable presentation

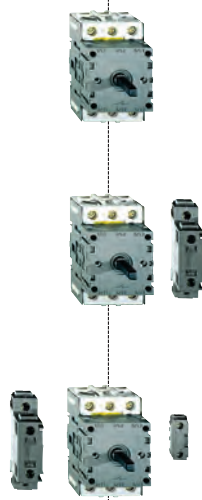

3P and 3P + NC/NO

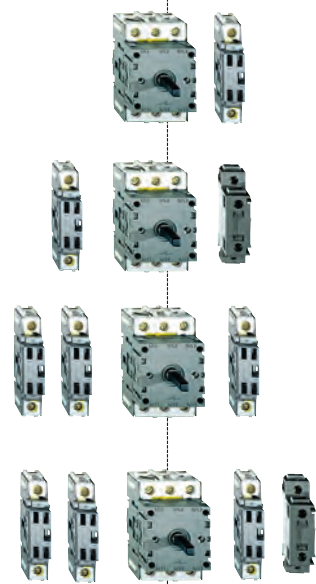

4P and 6P + NC/NO

## LEGEND



basic 3-pole block



additional pole  
additional neutral pole  
junction block



Auxiliary contact NC/NO



early break auxiliary contact

# Technical Specifications

## ▶ GENERAL

Characteristics	25 A	32 A	50 A	63 A	80 A	100 A
<b>UL/cUL</b> - suitable as motor disconnect						
▶ Rated voltage (V)	600	600	600	600	600	600
▶ General Use Current (A)	25	32	50	63	80	100
▶ Motor Ratings (hp)						
1 x 120 V	0.75	1	1.5	3	3	5
1 x 240 V	1.5	2	3	5	10	10
1 x 277 V	2	3	5	7.5	10	15
3 x 120 V	1.5	2	3	5	7.5	10
3 x 240 V	3	5	7.5	10	20	25
3 x 480 V	7.5	10	15	20	40	50
3 x 600 V	7.5	10	15	20	40	50
▶ Auxiliary Blocks						
NO/NC	A600					
Early Make	B300					
Early Break	B300					
▶ Wire Guage (AWG)						
3-Pole Body, Additional Pole, Late Break Neutral, Junction Block	8 - 14	8 - 14	4 - 14	4 - 14	1 - 14	1 - 14
Auxiliary Contacts	14 - 18	14 - 18	14 - 18	14 - 18	14 - 18	14 - 18
▶ Short Circuit Rating						
Fuse Type K5 (A)	5000	5000	5000	5000	5000	10000
Fuse Size (A)	40	40	80	80	125	125
Rated break capacity	330	330	800	800	800	800

# Technical Specifications

## ▶ GENERAL

Characteristics	25 A	32 A	50 A	63 A	80 A	100 A
<b>IEC</b>						
▶ Rated insulation voltage $U_i$ (V)	690	690	690	690	690	690
▶ Conventional free air thermal current $I_{th}$ Uninterrupted rated current $I_u$ (A)	25	32	50	63	80	100
▶ Conventional enclosed thermal current $I_{the}$ (A)	20	25	40	50	63	80
▶ Rated impulse withstand voltage (overvoltage category III - pollution degree 3 $U_{imp}$ (kV)	6	6	6	6	6	6
▶ Rated operating current $I_e$ (A) AC - 21 A/22 A Conform to IEC 60947-3	25	32	50	63	80	100
▶ Rated operating power (kW)						
AC 23 A						
3 x 230 V	5.5	5.5	15	15	18.5	22
3 x 400 V	7.5	11	18.5	22	30	37
3 x 500 V	7.5	11	22	30	37	45
3 x 690 V	7.5	11	18.5	22	22	30
AC 3						
3 x 230 V	4	4	7.5	11	15	18.5
3 x 400 V	5.5	7.5	15	18.5	22	30
3 x 500 V	5.5	7.5	15	22	30	37
3 x 690 V	5.5	7.5	15	18.5	18.5	22
▶ Make - break characteristics ( $I_{eff}/400$ V)						
Rated make capacity	710	710	1270	1270	1970	1970
Rated break capacity	330	330	800	800	800	800
▶ Short circuit characteristics						
Rated short term withstand current $I_{cW}$ ( $I_{eff}/400$ V/1 s)	350	430	500	760	1100	1500
Rated short circuit make capacity $I_{cm}$ (kA peak/400 V)	1	1	1.8	1.8	2.8	2.8
Short circuit current (kA $I_{eff}/400$ V)	10	10	10	10	10	10
with fuse gI/gG (A)	25	32	50	63	80	100

# Technical Specifications

## ▶ GENERAL

Characteristics	25 A	32 A	50 A	63 A	80 A	100 A
▶ Mechanical life AC 20 (million)	0.1	0.1	0.04	0.04	0.04	0.04
▶ Connections						
Stranded wire + (min/max) cap (mm <sup>2</sup> )	0.75/6	0.75/6	1.5/16	1.5/16	2.5/35	2.5/35
Solid wire (mm <sup>2</sup> )	10	10	25	25	50	50
▶ Operating and Storage temperature	-30°C to +70 °C , -22°F to +158°F					
▶ Protection rating	rear of panel: IPxxB front of panel IP 40 in standard version (IP 65 on request)					
▶ Conformity to standards	IEC 60697-3 -EN 60 947-3, UL508, CSA22.2, CB Certificate					
▶ Climatic resistance Tropical atmosphere according to	IEC 60068-2-30 Cyclic damp heat					

## ▶ AUXILIARY CONTACTS

Characteristics	25 A	32 A	50 A	63 A	80 A	100 A
▶ Rated insulation voltage Ui (V)	400	400	400	400	400	400
▶ Conventional free air thermal current I <sub>th</sub>						
Continuous rated current I <sub>u</sub> (A)	10	10	10	10	10	10
▶ Rated operating current I <sub>e</sub> (A)						
AC 15						
230 V	6	6	6	6	6	6
400 V	4	4	4	4	4	4
▶ PROTECTION AGAINST SHORT CIRCUIT BY FUSE GG (A)	10	10	10	10	10	10
▶ Max. connection stranded wire (mm <sup>2</sup> )	2 x 2.5	2 x 2.5	2 x 2.5	2 x 2.5	2 x 2.5	2 x 2.5

# Technical Specifications

## ► ENCLOSURES

Characteristics	150x100x96	220x150x100	220x150x100	220x150x100	220x150x100	300x200x100
► Rating	25 and 32 A 3P to 4P +NC/NO	25 and 32 A 6P and 6P +NC/NO	50 and 63 A 3P to 4P +NC/NO	50 and 63 A 6P and 6P +NC/NO	80 and 100 A 3P and 3P +NC/NO	80 and 100 A 4P to 6P +NC/NO
► Cable inputs	2 x 2 PG 16 OR 2 x 2 M25	2 x 2 PG 21	2 x 2 PG 21	2 x 2 PG 29	2 x 2 PG 29	2 x 2 PG 21 2 x 2 PG 29
► Ø knockouts (mm)	PG 16: 22.5 ISO M25: 25	28.5	28.5	37.5	37.5	37.5 and 28.5
► No. of knockouts (top and bottom)	2	2	2	2	2	4
► Panel mount	by 2 screws	by 4 screws	by 4 screws	by 4 screws	by 4 screws	by 4 screws
► Base/cover assembly	by 1 screws self-tapping stainless steel	by 4 screws self-tapping stainless steel	by 4 screws self-tapping stainless steel	by 4 screws self-tapping stainless steel	by 4 screws self-tapping stainless steel	by 6 screws self-tapping stainless steel
► Switch/base assembly	on 35 mm DIN rail (this rail is notched for positioning the switch)					
► Handles mounting	screwing on shaft pre-pierced cover					
► Insulation	Class II installed (provided that the correct insulation plugs are used with the enclosure)					
► Impact withstand	IKo7					
► Flameproof	650°C					
► Protection rating	IP 66		IP 4o (IP 65 upon request)			

► Contact operating diagram

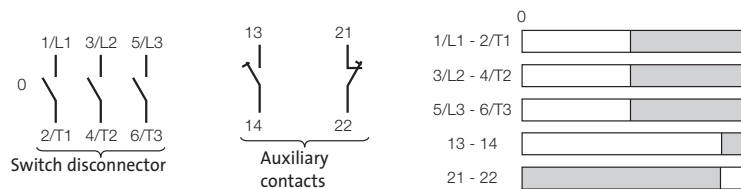

► Switch padlocking

In general: up to 3 padlocks  $\varnothing$  4 to 8 mm  
 Switch with 1 auxiliary contact NC/NO: up to 3 padlocks  $\varnothing$  6 to 8 mm  
 Modular presentation: 1 padlock  $\varnothing$  6 to 8 mm

# Technical Specifications

## ► MOUNTING - PANEL DRILLING

### Panel/Door Handle Mounting

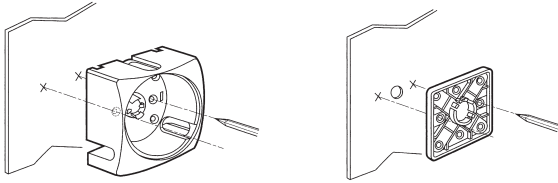

25A/32A

50A/63A/80A/100A

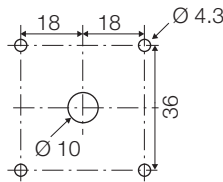
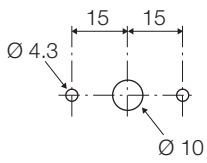

### Ø22 Single Hole Mounting

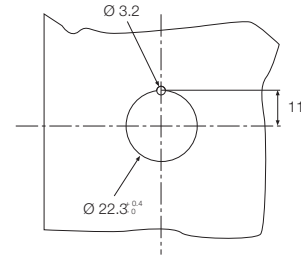

### Door Interlock System

#### Short or Long Metal Shaft Version

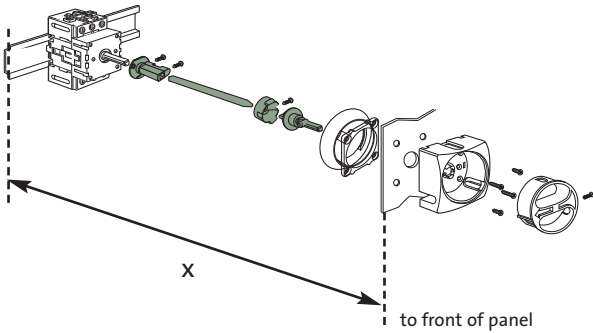

#### No Metal Shaft Version

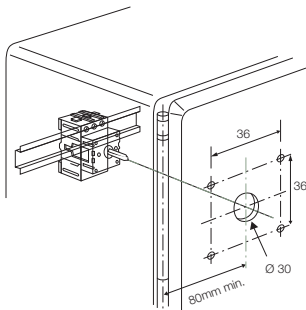
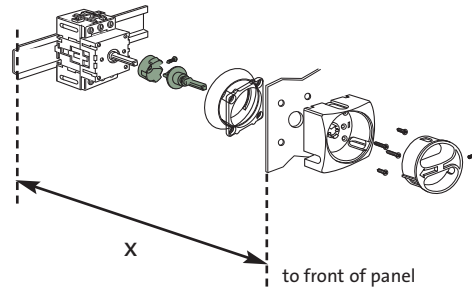

Minimum Distance to Hinge

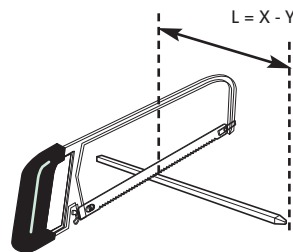

	X			Y
	without shaft	with short shaft	with long shaft	
25A / 32A	86 - 100 mm	125 - 250 mm	125 - 400 mm	92 mm
50A / 63A	96 - 110 mm	135 - 260 mm	135 - 410 mm	102 mm
80A / 100A	106 - 120 mm	145 - 270 mm	145 - 420 mm	112 mm



# PR ONE CAM SWITCH SERIES

A selection of standard switch functions pre-configured for fast and reliable solutions to be achieved quickly



PR12-ONE



PR21-ONE



PR26-ONE

## ► Design and Functions

- Manually operated control switches
- 45° switching angle- Forced opened contacts
- Finger protected (degree of protection up to IP 20)
- Short-circuit rated
- Terminal screws in open position

- Switching capacity Ie (A) : 12 A, 20 A and 25 A - UL508
- Switching capacity Ie (A) : 16 A, 25 A and 32 A - AC21
- Front presentation : aluminum plate with black handle with index
- Laser marking on legend plate-Front degree of protection IP 40
- 2-screw panel mount - interval 30 mm



## ► Applications

- On-Off Switches
- Changeover Switches
- Multi-step Selector Switches
- Instrument Switches

# PR ONE CAM SWITCHES

 Technical Info (p. 205)

## ▶ ON/OFF SWITCHES

From 1 to 3 poles, each pole being a path for the current, the circuit being open at starting position 0 and closed in position 1

### ON/OFF SWITCHES

Part Number



227603

No. of contacts	0	1	
1-2		X	1P
3-4		X	2P
5-6		X	3P

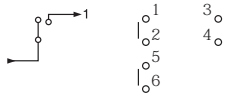

**12 A**  
 1 Pole - 1 Contact  
 2 Poles - 2 Contacts  
 3 Poles - 3 Contacts



**227600**  
**227601**  
**227602**

**20 A**  
 1 Pole - 1 Contact  
 2 Poles - 2 Contacts  
 3 Poles - 3 Contacts



**227603**  
**227604**  
**227605**

**25 A**  
 1 Pole - 1 Contact  
 3 Poles - 3 Contacts



**227606**  
**227608**

## ▶ CHANGE-OVER SWITCHES WITH “OFF” POSITION

From 1 to 3 poles, each pole having two current paths, open at starting position 0, one path closes on position 1, the other on position 2

### CHANGE-OVER SWITCHES

Part Number



227609

No. contacts	1	0	2	
1-2	X			1P
3-4			X	
5-6	X			
7-8			X	2P
9-10	X			
11-12			X	3P

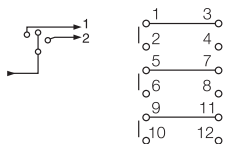

**12 A**  
 1 Pole - 2 Contacts  
 2 Poles - 4 Contacts  
 3 Poles - 6 Contacts



**227609**  
**227610**  
**227611**

**20 A**  
 1 Pole - 2 Contacts  
 2 Poles - 4 Contacts  
 3 Poles - 6 Contacts



**227612**  
**227613**  
**227614**

**25 A**  
 1 Pole - 2 Contacts  
 2 Poles - 4 Contacts  
 3 Poles - 6 Contacts



**227615**  
**227616**  
**227617**

# PR ONE CAM SWITCHES

 Technical Info (p. 205)

## ▶ SELECTOR SWITCHES

2 to 5 way switches, each pole being from 2 to 5 paths, respectively, for the current, the starting position is at 0

### 2-WAY SWITCHES WITH OFF

Part Number



227630

No. of contacts	0	1	2	
1-2		X		1P
3-4			X	
5-6		X		2P
7-8			X	
9-10		X		3P
11-12			X	

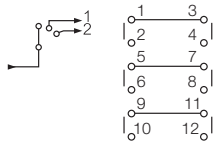

**12 A**  
 1 Pole - 2 Contacts  
 2 Poles - 4 Contacts  
 3 Poles - 6 Contacts



**227618**  
**227619**  
**227620**

**20 A**  
 1 Pole - 2 Contacts  
 2 Poles - 4 Contacts  
 3 Poles - 6 Contacts



**227624**  
**227625**  
**227626**

**25 A**  
 1 Pole - 2 Contacts  
 2 Poles - 4 Contacts  
 3 Poles - 6 Contacts



**227630**  
**227631**  
**227632**

### 3-WAY SWITCHES WITH OFF

Part Number



227621

No. of contacts	0	1	2	3	
1-2		X			1P
3-4			X		
7-8				X	

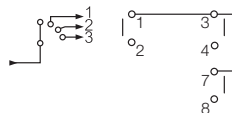

**12 A**  
 1 Pole - 3 Contacts



**227621**

**20 A**  
 1 Pole - 3 Contacts



**227627**

### 4-WAY SWITCH WITH OFF

Part Number



227622

No. of contacts	0	1	2	3	4	
1-2		X				1P
3-4			X			
5-6				X		
7-8					X	

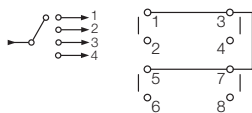

**12 A**  
 1 Pole - 4 Contacts



**227622**

# PR ONE CAM SWITCHES

 Technical Info (p. 205)

## ▶ SELECTOR SWITCHES (CONTINUED)

### 5-WAY SWITCHES WITH OFF

Part Number



227623

No. of contacts	Positions				
	0	1	2	3	4
1 - 2		X			
3 - 4			X		
5 - 6				X	
7 - 8					X
9 - 10					X

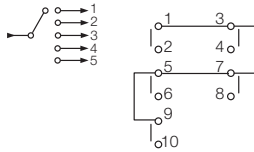

**12 A**  
1 Pole - 5 Contacts



**227623**

**20 A**  
1 Pole - 5 Contacts



**227629**

## ▶ INSTRUMENT SWITCHES

For voltmeters wired into 3-phase networks with neutral.

For ammeters wired with 3 CT's connected into the corresponding circuits. The CT's can be mounted in series with common point.

### VOLTMETER SWITCH, WITH NEUTRAL

Part Number



227636

No. of contacts	L3	L2	L1	0	L1	L2	L3
	L1	L3	L2	0	N	N	N
1 - 2	X		X		X		
3 - 4					X	X	X
5 - 6		X				X	
7 - 8			X				
9 - 10							X
11 - 12	X	X					

**12 A**  
6 Contacts



**227636**

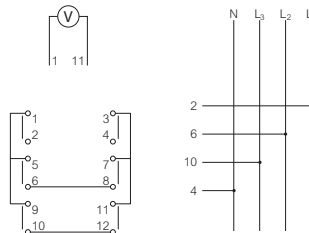

### AMMETER SWITCH, 3 CTS WITH COMMON POINT

Part Number



227637

No. OF CONTACTS	0	L1	L2	L3
	1 - 2	X	X	
3 - 4	X	X		
5 - 6			X	X
7 - 8			X	X
9 - 10	X		X	X
11 - 12			X	X

**12 A**  
6 Contacts



**227637**

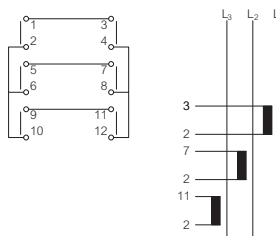

## PR ONE CAM SWITCHES

### ► Technical Specifications

Electrical Characteristics - UL/CSA		PR12-ONE	PR21-ONE	PR26-ONE
► <b>UL/CSA</b> GENERAL USE (600 V)		12 A	20 A	25 A
1 PHASE	110/120 VAC	0.5 HP	1.5 HP	2 HP
3 PHASE	220/240 VAC	3 HP	5 HP	7.5 HP
	440/480 VAC	5 HP	10 HP	15 HP
	550/600 VAC	3 HP	15 HP	20 HP
UL 508 RECOGNIZED		YES	YES	YES
CSA CERTIFIED		YES	YES	YES
► <b>Maximum wire size (AWG)</b>				
	- rigid	10	8/10 <sup>(1)</sup>	8
	- flexible	14	12	8
(1): terminals with jumpers				
Electrical Characteristics - IEC		PR12-ONE	PR21-ONE	PR26-ONE
► <b>Thermal current AC-20 Ith I<sub>c</sub>(A)</b>		20	32	40
► <b>Rated operating current AC-21 A I<sub>e</sub>(A)</b> Switching of resistive loads including moderate overloads		16	25	32
► <b>Rated operating current AC-15 A I<sub>e</sub>(A)</b> Control of electromagnetic loads		6	10	12
► <b>Performance in AC 23 (kW)</b> Switching of motors or other highly inductive loads				
	- 3 x 230 V	4	7.5	11
	- 3 x 400 V	7.5	11	11
► <b>Performance in AC 3 (kW)</b> Control of squirrel-cage motors starting and switching off motors while running				
	- 3 x 230 V	3	4	5.5
	- 3 x 400 V	4	7.5	11
► <b>Rated insulation voltage U<sub>i</sub> (V)</b>		690	690	690
► <b>Rated short time withstand current I<sub>cw</sub> (A) for 1 sec</b>		300	420	800
► <b>Maximum wire size (mm<sup>2</sup> rigid/flexible)</b>		4/2.5	6/4	6/6
► <b>Mechanical durability (number of operations)</b>		800,000 (max. rate 150 per hour)		
► <b>Operating temperature limits</b>		- 20°C to + 70°C (- 4°F to + 158°F)		
► <b>Degree of protection</b>		Front IP40, Rear IP20		

# PR ONE CAM SWITCHES

## ► DIMENSIONS

### PR12-ONE (12A)

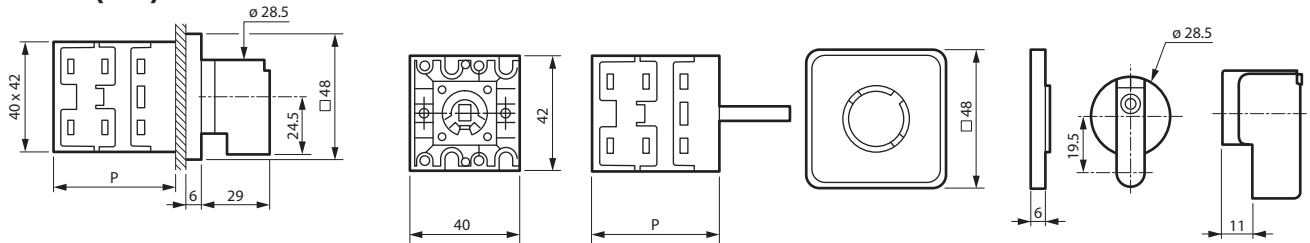

Dimensions in mm  
 \*P: 36 (1-2 contacts)  
 46 (3-4 contacts)  
 56 (5-6 contacts)

### PR21-ONE (20A)

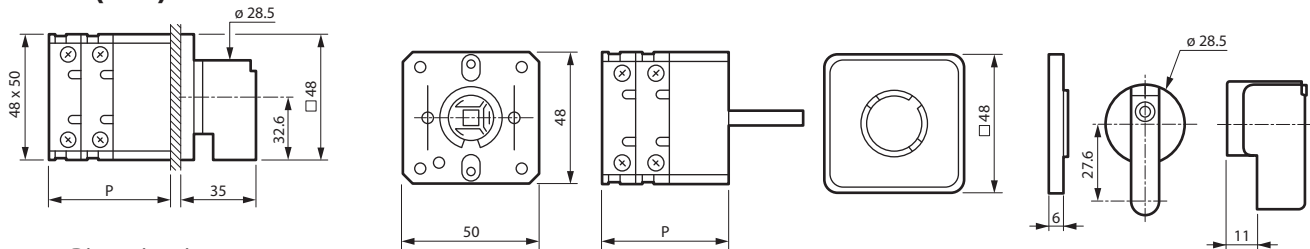

Dimensions in mm  
 \*P: 33 (1-2 contacts)  
 45 (3-4 contacts)  
 57 (5-6 contacts)

### PR26-ONE (25A)

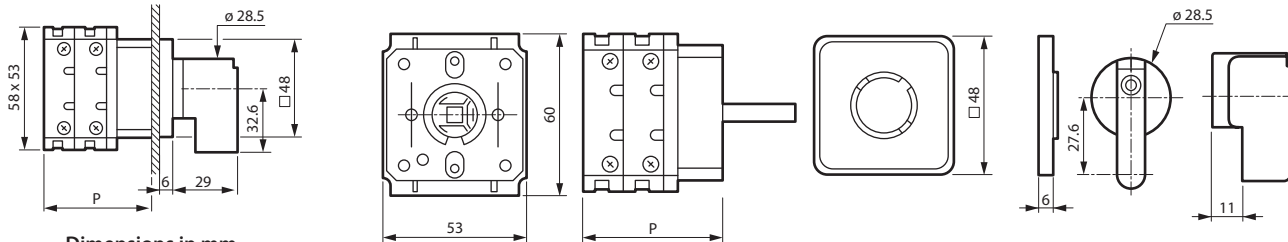

Dimensions in mm  
 \*P: 36 (1-2 contacts)  
 51 (3-4 contacts)  
 66 (5-6 contacts)

## ► PANEL CUT-OUT

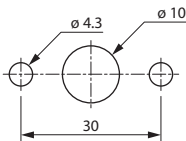

# Protection, flexibility and safety

Cam switches from 10 to 63 A

---

► STANDARD SOLUTIONS P. 208 - 233

---

The expertise of a specialist like Baco allows us to offer custom solutions, even the most specific.



**Choice of electrical configuration**  
from 1 to 24 contacts



**Metal shaft**  
can withstand more than  
1 million operations

**Customized  
engravings**

► ADVANTAGES

---

- Conform to European and international standards: IEC, UL and CSA, and CCC
- A metal shaft capable of withstanding more than 1 million operations
- More than 50,000 different electrical diagrams available
- Many specific functions and special markings

# MINI CAM SWITCHES

▶  $\phi 16/22$ mm SINGLE HOLE MOUNTING

 Technical Info (p. 209)

GENERAL USE RATING 12A

IP65 standard



223501













223511



223525



223528

Function	General use rating - amps	Number of poles	Number of contacts	Positions	Part Number
ON/OFF	10	1	1		<b>223501</b>
	10	2	2		<b>223502</b>
	10	3	3		<b>223503</b>
	10	4	4		<b>223504</b>
CHANGEOVER WITHOUT "OFF"	10	1	2		
	10	2	4	<b>223512</b>	
	10	3	6	<b>223513</b>	
	10	4	8	<b>223514</b>	
CHANGEOVER WITH "OFF"	10	1	2		<b>223505</b>
	10	2	4		<b>223506</b>
	10	3	6		<b>223507</b>
	10	4	8		<b>223508</b>
THREE WAY WITHOUT "OFF"	10	1	3		<b>223515</b>
	10	2	6		<b>223516</b>
	10	3	9		<b>223517</b>
THREE WAY WITH "OFF"	10	1	3		<b>223521</b>
	10	2	6		<b>223522</b>
	10	3	9		<b>223523</b>
FOUR WAY WITHOUT "OFF"	10	1	4		<b>223525</b>
	10	2	8		<b>223526</b>
AMMETER - 3 CTs WITH COMMON POINT Contact Configuration - 8151	10		6		<b>223529</b>
VOLTMETER - WITHOUT NEUTRAL Contact Configuration - 8351	10		4		<b>223527</b>
VOLTMETER - WITH NEUTRAL Contact Configuration - 8357	10		6		<b>223528</b>



# MINI CAM SWITCHES

## ▶ TECHNICAL SPECIFICATIONS

Characteristics	Data
▶ Thermal current I <sub>th</sub>	10 A
▶ Rated operating current I <sub>e</sub>	
- in AC 21	10 A
- in AC 15	2.5 A
▶ Motor performance in AC-3	
- 3 x 230 V	1.8 kW
- 3 x 400 V	2.2 kW
▶ Motor performance in AC-23	
- 1 x 230 V	0.75 kW
- 1 x 400 V	1.1 kW
- 3 x 230 V	1.8 kW
- 3 x 400 V	3 kW
▶ Rated insulation voltage U <sub>i</sub> (V)	500 V
▶ Rated operating current in DC-1	
L/R < 1ms	
- 24 V DC	10 A
- 40 V DC	6 A
- 60 V DC	2.5 A
- 110 V DC	0.7 A
- 220 V DC	0.3 A

Characteristics	Data
▶ Rated conditional short-circuit current	3 kA
▶ Max. fuse rating	10 A
▶ Degree of protection	IP 65 IP 2x at the rear of the panel
▶ Wire size (flexible and rigid)	2 x 1.5 mm <sup>2</sup> max. 1 x 0.5 mm <sup>2</sup> min.
▶ Operating temperature	- 20°C to + 50°C
▶ Standards	IEC/EN 60947-1 IEC/EN 60947-3 CSA 22.2 UL 508

### Dimensions

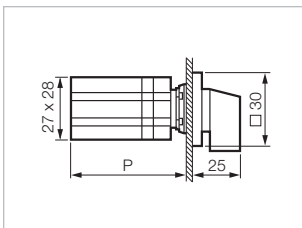

**Dimensions in mm**  
 \*P: 46 (1-2 CONTACTS)  
 58 (3-4 CONTACTS)  
 70 (5-6 CONTACTS)  
 82 (7-8 CONTACTS)  
 94 (9-10 CONTACTS)

**Panel Thickness**  
 1 to 5.5mm

### Mounting

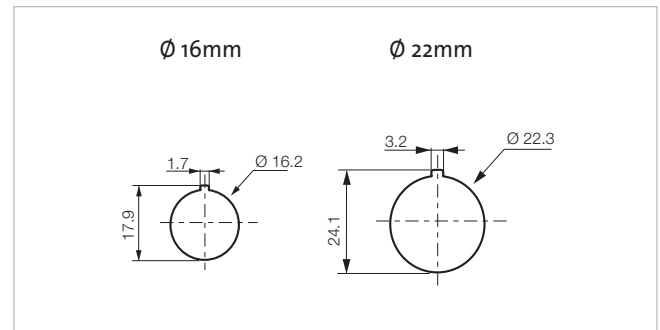

# CAM SWITCHES

## ► SINGLE HOLE MOUNTING $\phi 22\text{mm}$

 Technical Info (p. 234)

### GENERAL USE RATING 12A

IP40 standard - IP65 available upon request



HANDLE WITH LEGEND





HANDLE



LEVER



KEY

Switch Series	Operator	Number of poles	Number of contacts	Positions	Designation	Part Number
PR12	HANDLE/LEGEND	1	1		PR12 1101 A4 E N48MD50	<b>NB01AX80</b>
PR12	HANDLE/LEGEND	2	2		PR12 1102 A4 E N48MD50	<b>NB02AX80</b>
PR12	HANDLE/LEGEND	3	3		PR12 1103 A4 E N48MD50	<b>NB03AX80</b>
PR12	HANDLE/LEGEND	4	4		PR12 1104 A4 E N48MD50	<b>NB04AX80</b>
PR12	HANDLE	1	1		PR12 1101 A4 E C21RA03	<b>NB01AC113</b>
PR12	HANDLE	2	2		PR12 1102 A4 E C21RA03	<b>NB02AC113</b>
PR12	HANDLE	3	3		PR12 1103 A4 E C21RA03	<b>NB03AC113</b>
PR12	HANDLE	4	4		PR12 1104 A4 E C21RA03	<b>NB04AC113</b>
PR12	LEVER	1	1		PR12 1101 A4 E C21RB03	<b>NB01AC123</b>
PR12	LEVER	2	2		PR12 1102 A4 E C21RB03	<b>NB02AC123</b>
PR12	LEVER	3	3		PR12 1103 A4 E C21RB03	<b>NB03AC123</b>
PR12	LEVER	4	4		PR12 1104 A4 E C21RB03	<b>NB04AC123</b>
PR12	KEY	1	1	Key Removable in both positions	PR12 1101 A4 E C21RC00	<b>NB01AC1C1</b>
PR12	KEY	2	2		PR12 1102 A4 E C21RC00	<b>NB02AC1C1</b>
PR12	KEY	3	3		PR12 1103 A4 E C21RC00	<b>NB03AC1C1</b>
PR12	KEY	4	4		PR12 1104 A4 E C21RC00	<b>NB04AC1C1</b>
PR12	HANDLE/LEGEND	1	2		PR12 2251 D4 E N48MD50	<b>NC51DX80</b>
PR12	HANDLE/LEGEND	2	4		PR12 2252 D4 E N48MD50	<b>NC52DX80</b>
PR12	HANDLE/LEGEND	3	6		PR12 2253 D4 E N48MD50	<b>NC53DX80</b>
PR12	HANDLE/LEGEND	4	8		PR12 2254 D4 E N48MD50	<b>NC54DX80</b>
PR12	HANDLE	1	2		PR12 2251 D4 E C21RA03	<b>NC51DC113</b>
PR12	HANDLE	2	4		PR12 2252 D4 E C21RA03	<b>NC52DC113</b>
PR12	HANDLE	3	6		PR12 2253 D4 E C21RA03	<b>NC53DC113</b>
PR12	HANDLE	4	8		PR12 2254 D4 E C21RA03	<b>NC54DC113</b>
PR12	LEVER	1	2		PR12 2251 D4 E C21RB03	<b>NC51DC123</b>
PR12	LEVER	2	4		PR12 2252 D4 E C21RB03	<b>NC52DC123</b>
PR12	LEVER	3	6		PR12 2253 D4 E C21RB03	<b>NC53DC123</b>
PR12	LEVER	4	8		PR12 2254 D4 E C21RB03	<b>NC54DC123</b>

# CAM SWITCHES

## ► SINGLE HOLE MOUNTING $\phi 22\text{mm}$

 Technical Info (p. 234)

### GENERAL USE RATING 12A

IP40 standard - IP65 available upon request



HANDLE WITH LEGEND





HANDLE



LEVER



KEY

Switch Series	Operator	Number of poles	Number of contacts	Positions	Designation	Part Number
PR12	HANDLE/LEGEND	1	2		PR12 2201 C8 E N48MD50	<b>NC01GX80</b>
PR12	HANDLE/LEGEND	2	4		PR12 2202 C8 E N48MD50	<b>NC02GX80</b>
PR12	HANDLE/LEGEND	3	6		PR12 2203 C8 E N48MD50	<b>NC03GX80</b>
PR12	HANDLE/LEGEND	4	8		PR12 2204 C8 E N48MD50	<b>NC04GX80</b>
PR12	HANDLE	1	2		PR12 2201 C8 E C21RA03	<b>NC01GC113</b>
PR12	HANDLE	2	4		PR12 2202 C8 E C21RA03	<b>NC02GC113</b>
PR12	HANDLE	3	6		PR12 2203 C8 E C21RA03	<b>NC03GC113</b>
PR12	HANDLE	4	8		PR12 2204 C8 E C21RA03	<b>NC04GC113</b>
PR12	LEVER	1	2		PR12 2201 C8 E C21RB03	<b>NC01GC123</b>
PR12	LEVER	2	4		PR12 2202 C8 E C21RB03	<b>NC02GC123</b>
PR12	LEVER	3	6		PR12 2203 C8 E C21RB03	<b>NC03GC123</b>
PR12	LEVER	4	8		PR12 2204 C8 E C21RB03	<b>NC04GC123</b>
PR12	KEY	1	2	Key Removable in position '0' only	PR12 2201 C8 E C21RC00	<b>NC01GC1C1</b>
PR12	KEY	2	4		PR12 2202 C8 E C21RC00	<b>NC02GC1C1</b>
PR12	KEY	3	6		PR12 2203 C8 E C21RC00	<b>NC03GC1C1</b>
PR12	KEY	4	8		PR12 2204 C8 E C21RC00	<b>NC04GC1C1</b>
PR12	HANDLE/LEGEND	1	3		PR12 2301 A4 E N48MD50	<b>ND01AX80</b>
PR12	HANDLE/LEGEND	2	6		PR12 2302 A4 E N48MD50	<b>ND02AX80</b>
PR12	HANDLE/LEGEND	3	9		PR12 2303 A4 E N48MD50	<b>ND03AX80</b>
PR12	HANDLE/LEGEND	4	12		PR12 2304 A4 E N48MD50	<b>ND04AX80</b>
PR12	HANDLE	1	3		PR12 2301 A4 E C21RA03	<b>ND01AC113</b>
PR12	HANDLE	2	6		PR12 2302 A4 E C21RA03	<b>ND02AC113</b>
PR12	HANDLE	3	9		PR12 2303 A4 E C21RA03	<b>ND03AC113</b>
PR12	HANDLE	4	12		PR12 2304 A4 E C21RA03	<b>ND04AC113</b>
PR12	LEVER	1	3		PR12 2301 A4 E C21RB03	<b>ND01AC123</b>
PR12	LEVER	2	6		PR12 2302 A4 E C21RB03	<b>ND02AC123</b>
PR12	LEVER	3	9		PR12 2303 A4 E C21RB03	<b>ND03AC123</b>
PR12	LEVER	4	12		PR12 2304 A4 E C21RB03	<b>ND04AC123</b>
PR12	KEY	1	3	Key Removable in all positions	PR12 2301 A4 E C21RC00	<b>ND01AC1C1</b>
PR12	KEY	2	6		PR12 2302 A4 E C21RC00	<b>ND02AC1C1</b>
PR12	KEY	3	9		PR12 2303 A4 E C21RC00	<b>ND03AC1C1</b>
PR12	KEY	4	12		PR12 2304 A4 E C21RC00	<b>ND04AC1C1</b>

# CAM SWITCHES

## ▶ ON/OFF SWITCHES

 Technical Info (p. 234)

### PANEL MOUNTING - TWO FIXING SCREWS

IP40 standard - IP65 available upon request

#### Contact Configuration

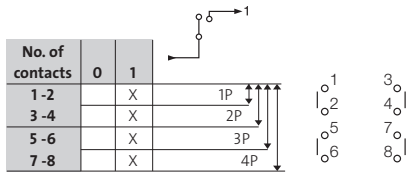

NB02AQ1









SB04AQ1



ZB04AQ7



HB03AQ7

Switch Series	General use rating - amps	Number of poles	Number of contacts	Positions	Designation	Part Number
PR12	12	1	1		PR12 1101 A4 E Q48PN50	<b>NB01AQ1</b>
PR12	12	2	2		PR12 1102 A4 E Q48PN50	<b>NB02AQ1</b>
PR12	12	3	3		PR12 1103 A4 E Q48PN50	<b>NB03AQ1</b>
PR12	12	4	4		PR12 1104 A4 E Q48PN50	<b>NB04AQ1</b>
PR17	16	1	1		PR17 1101 A4 E Q48PN50	<b>SB01AQ1</b>
PR17	16	2	2		PR17 1102 A4 E Q48PN50	<b>SB02AQ1</b>
PR17	16	3	3		PR17 1103 A4 E Q48PN50	<b>SB03AQ1</b>
PR17	16	4	4		PR17 1104 A4 E Q48PN50	<b>SB04AQ1</b>
PR21	20	1	1		PR21 1101 A4 E Q48PN50	<b>TB01AQ1</b>
PR21	20	2	2		PR21 1102 A4 E Q48PN50	<b>TB02AQ1</b>
PR21	20	3	3		PR21 1103 A4 E Q48PN50	<b>TB03AQ1</b>
PR21	20	4	4		PR21 1104 A4 E Q48PN50	<b>TB04AQ1</b>
PR26	25	1	1		PR26 1101 A4 E Q72MN50	<b>ZB01AQ7</b>
PR26	25	2	2		PR26 1102 A4 E Q72MN50	<b>ZB02AQ7</b>
PR26	25	3	3		PR26 1103 A4 E Q72MN50	<b>ZB03AQ7</b>
PR26	25	4	4		PR26 1104 A4 E Q72MN50	<b>ZB04AQ7</b>
PR40	50	1	1		PR40 1101 A4 E Q72MN60	<b>HB01AQ7</b>
PR40	50	2	2		PR40 1102 A4 E Q72MN60	<b>HB02AQ7</b>
PR40	50	3	3		PR40 1103 A4 E Q72MN60	<b>HB03AQ7</b>
PR40	50	4	4		PR40 1104 A4 E Q72MN60	<b>HB04AQ7</b>
PR63	63	1	1		PR63 1101 A4 E Q72MN60	<b>IB01AQ7</b>
PR63	63	2	2		PR63 1102 A4 E Q72MN60	<b>IB02AQ7</b>
PR63	63	3	3		PR63 1103 A4 E Q72MN60	<b>IB03AQ7</b>
PR63	63	4	4		PR63 1104 A4 E Q72MN60	<b>IB04AQ7</b>

# CAM SWITCHES

## ▶ ON/OFF SWITCHES

 Technical Info (p. 234)

### IN ENCLOSURE

IP40 standard - IP65 available upon request

Contact Configuration

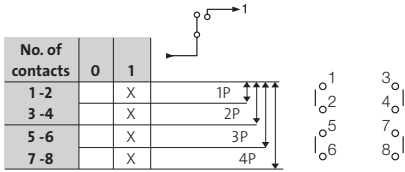

NB04AXQ



























TB01AXQ



ZB02AXQ



IB02AAQ

Switch Series	General use rating - amps	Number of poles	Number of contacts	Positions	Designation	Part Number
PR12	12	1	1		PR12 1101 A4 BCQ3	<b>NB01AXQ</b>
PR12	12	2	2		PR12 1102 A4 BCQ3	<b>NB02AXQ</b>
PR12	12	3	3		PR12 1103 A4 BCQ3	<b>NB03AXQ</b>
PR12	12	4	4		PR12 1104 A4 BCQ3	<b>NB04AXQ</b>
PR17	16	1	1		PR17 1101 A4 BCQ3	<b>SB01AXQ</b>
PR17	16	2	2		PR17 1102 A4 BCQ3	<b>SB02AXQ</b>
PR17	16	3	3		PR17 1103 A4 BCQ3	<b>SB03AXQ</b>
PR17	16	4	4		PR17 1104 A4 BCQ3	<b>SB04AXQ</b>
PR21	20	1	1		PR21 1101 A4 BCQ3	<b>TB01AXQ</b>
PR21	20	2	2		PR21 1102 A4 BCQ3	<b>TB02AXQ</b>
PR21	20	3	3		PR21 1103 A4 BCQ3	<b>TB03AXQ</b>
PR21	20	4	4		PR21 1104 A4 BCQ3	<b>TB04AXQ</b>
PR26	25	1	1		PR26 1101 A4 BCQ3	<b>ZB01AXQ</b>
PR26	25	2	2		PR26 1102 A4 BCQ3	<b>ZB02AXQ</b>
PR26	25	3	3		PR26 1103 A4 BCQ3	<b>ZB03AXQ</b>
PR26	25	4	4		PR26 1104 A4 BCQ3	<b>ZB04AXQ</b>
PR40	50	1	1		PR40 1101 A4 BCF Q72MN60	<b>HB01AAQ</b>
PR40	50	2	2		PR40 1102 A4 BCF Q72MN60	<b>HB02AAQ</b>
PR40	50	3	3		PR40 1103 A4 BCF Q72MN60	<b>HB03ABQ</b>
PR40	50	4	4		PR40 1104 A4 BCF Q72MN60	<b>HB04ABQ</b>
PR63	63	1	1		PR63 1101 A4 BCF Q72MN60	<b>IB01AAQ</b>
PR63	63	2	2		PR63 1102 A4 BCF Q72MN60	<b>IB02AAQ</b>
PR63	63	3	3		PR63 1103 A4 BCF Q72MN60	<b>IB03ABQ</b>
PR63	63	4	4		PR63 1104 A4 BCF Q72MN60	<b>IB04ABQ</b>

# CAM SWITCHES

## ▶ ON/OFF “MAIN SWITCHES”

 Technical Info (p. 234)

### PANEL MOUNTING - TWO FIXING SCREWS

IP65 standard - IP40 available upon request

#### Contact Configuration - 1103GN

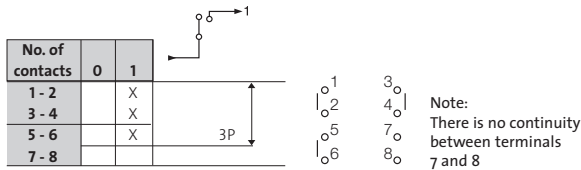

NS3EV493-IP65



TS3EV493-IP65



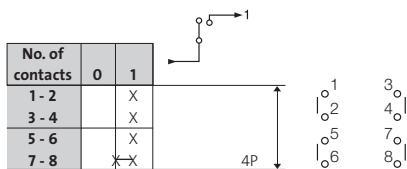









#### Contact Configuration - 1104GN



ZS3EV733-IP65



IS3EV733-IP65

Switch Series	General use rating - amps	Number of poles	Number of contacts	Positions	Designation	Part Number
PR12	12	3	3		PR12 1103 GN E J483PND51	<b>NS3EV493-IP65</b>
PR12	12	4	4		PR12 1104 GN E J483PND51	<b>NS4EV493-IP65</b>
PR17	16	3	3		PR17 1103 GN E J483PND51	<b>SS3EV493-IP65</b>
PR17	16	4	4		PR17 1104 GN E J483PND51	<b>SS4EV493-IP65</b>
PR21	20	3	3		PR21 1103 GN E J483PND51	<b>TS3EV493-IP65</b>
PR21	20	4	4		PR21 1104 GN E J483PND51	<b>TS4EV493-IP65</b>
PR26	25	3	3		PR26 1103 GN E J723MND51	<b>ZS3EV733-IP65</b>
PR26	25	4	4		PR26 1104 GN E J723MND51	<b>ZS4EV733-IP65</b>
PR40	50	3	3		PR40 1103 GN E J723MND61	<b>HS3EV733-IP65</b>
PR40	50	4	4		PR40 1104 GN E J723MND61	<b>HS4EV733-IP65</b>
PR63	63	3	3		PR63 1103 GN E J723MND61	<b>IS3EV733-IP65</b>
PR63	63	4	4		PR63 1104 GN E J723MND61	<b>IS4EV733-IP65</b>

# CAM SWITCHES

## ► ON/OFF “MAIN SWITCHES”

 Technical Info (p. 234)

### IN ENCLOSURE

IP65 standard - IP40 available upon request

#### Contact Configuration - 1103GN

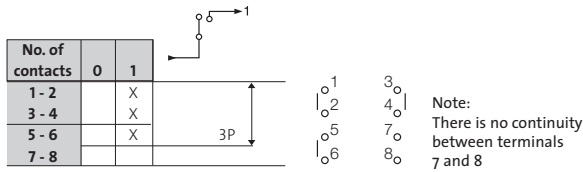

NS3XV483-IP65



SS3XV483-IP65



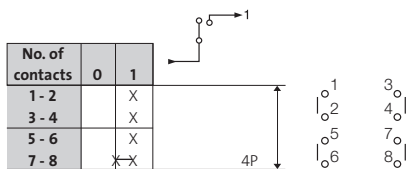









#### Contact Configuration - 1104GN



ZS3XV483-IP65



HS3BV733-IP65

Switch Series	General use rating - amps	Number of poles	Number of contacts	Positions	Designation	Part Number
PR12	12	3	3		PR12 1103 GN BC J48PND51	<b>NS3XV483-IP65</b>
PR12	12	4	4		PR12 1104 GN BC J48PND51	<b>NS4XV483-IP65</b>
PR17	16	3	3		PR17 1103 GN BC J48PND51	<b>SS3XV483-IP65</b>
PR17	16	4	4		PR17 1104 GN BC J48PND51	<b>SS4XV483-IP65</b>
PR21	20	3	3		PR21 1103 GN BC J48PND51	<b>TS3XV483-IP65</b>
PR21	20	4	4		PR21 1104 GN BC J48PND51	<b>TS4XV483-IP65</b>
PR26	25	3	3		PR26 1103 GN BC J48PND51	<b>ZS3XV483-IP65</b>
PR26	25	4	4		PR26 1104 GN BC J48PND51	<b>ZS4XV483-IP65</b>
PR40	50	3	3		PR40 1103 GN BCF J723MND61	<b>HS3BV733-IP65</b>
PR40	50	4	4		PR40 1104 GN BCF J723MND61	<b>HS4BV733-IP65</b>
PR63	63	3	3		PR63 1103 GN BCF J723MND61	<b>IS3BV733-IP65</b>
PR63	63	4	4		PR63 1104 GN BCF J723MND61	<b>IS4BV733-IP65</b>

# CAM SWITCHES

## ► CHANGEOVER SWITCHES - WITHOUT OFF

 Technical Info (p. 234)

### PANEL MOUNTING - TWO FIXING SCREWS

IP40 standard - IP65 available upon request

#### Contact Configuration

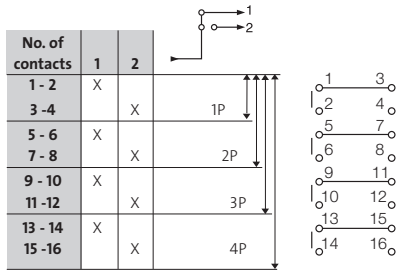

NC53DQ1









TC51DQ1



ZC52DQ7



HC52DQ7

Switch Series	General use rating - amps	Number of poles	Number of contacts	Positions	Designation	Part Number
PR12	12	1	2		PR12 2251 D4 E Q48PN50	<b>NC51DQ1</b>
PR12	12	2	4		PR12 2252 D4 E Q48PN50	<b>NC52DQ1</b>
PR12	12	3	6		PR12 2253 D4 E Q48PN50	<b>NC53DQ1</b>
PR12	12	4	8		PR12 2254 D4 E Q48PN50	<b>NC54DQ1</b>
PR17	16	1	2		PR17 2251 D4 E Q48PN50	<b>SC51DQ1</b>
PR17	16	2	4		PR17 2252 D4 E Q48PN50	<b>SC52DQ1</b>
PR17	16	3	6		PR17 2253 D4 E Q48PN50	<b>SC53DQ1</b>
PR17	16	4	8		PR17 2254 D4 E Q48PN50	<b>SC54DQ1</b>
PR21	20	1	2		PR21 2251 D4 E Q48PN50	<b>TC51DQ1</b>
PR21	20	2	4		PR21 2252 D4 E Q48PN50	<b>TC52DQ1</b>
PR21	20	3	6		PR21 2253 D4 E Q48PN50	<b>TC53DQ1</b>
PR21	20	4	8		PR21 2254 D4 E Q48PN50	<b>TC54DQ1</b>
PR26	25	1	2		PR26 2251 D4 E Q72MN50	<b>ZC51DQ7</b>
PR26	25	2	4		PR26 2252 D4 E Q72MN50	<b>ZC52DQ7</b>
PR26	25	3	6		PR26 2253 D4 E Q72MN50	<b>ZC53DQ7</b>
PR26	25	4	8		PR26 2254 D4 E Q72MN50	<b>ZC54DQ7</b>
PR40	50	1	2		PR40 2251 D4 E Q72MN60	<b>HC51DQ7</b>
PR40	50	2	4		PR40 2252 D4 E Q72MN60	<b>HC52DQ7</b>
PR40	50	3	6		PR40 2253 D4 E Q72MN60	<b>HC53DQ7</b>
PR40	50	4	8		PR40 2254 D4 E Q72MN60	<b>HC54DQ7</b>
PR63	63	1	2		PR63 2251 D4 E Q72MN60	<b>IC51DQ7</b>
PR63	63	2	4		PR63 2252 D4 E Q72MN60	<b>IC52DQ7</b>
PR63	63	3	6		PR63 2253 D4 E Q72MN60	<b>IC53DQ7</b>
PR63	63	4	8		PR63 2254 D4 E Q72MN60	<b>IC54DQ7</b>



# CAM SWITCHES

## ► CHANGEOVER SWITCHES - WITHOUT OFF

 Technical Info (p. 234)

### IN ENCLOSURE

IP40 standard - IP65 available upon request

Contact Configuration

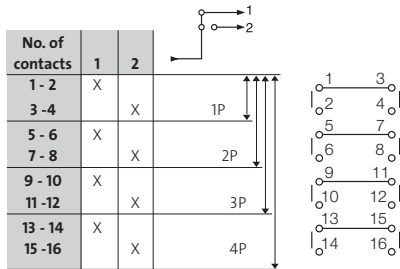

NC51DXQ









SC53DXQ



ZC52DXQ



IC52DBQ

Switch Series	General use rating - amps	Number of poles	Number of contacts	Positions	Designation	Part Number
PR12	12	1	2		PR12 2251 D4 BCQ3	<b>NC51DXQ</b>
PR12	12	2	4		PR12 2252 D4 BCQ3	<b>NC52DXQ</b>
PR12	12	3	6		PR12 2253 D4 BCQ3	<b>NC53DXQ</b>
PR12	12	4	8		PR12 2254 D4 BCQ3	<b>NC54DXQ</b>
PR17	16	1	2		PR17 2251 D4 BCQ3	<b>SC51DXQ</b>
PR17	16	2	4		PR17 2252 D4 BCQ3	<b>SC52DXQ</b>
PR17	16	3	6		PR17 2253 D4 BCQ3	<b>SC53DXQ</b>
PR17	16	4	8		PR17 2254 D4 BCQ3	<b>SC54DXQ</b>
PR21	20	1	2		PR21 2251 D4 BCQ3	<b>TC51DXQ</b>
PR21	20	2	4		PR21 2252 D4 BCQ3	<b>TC52DXQ</b>
PR21	20	3	6		PR21 2253 D4 BCQ3	<b>TC53DXQ</b>
PR21	20	4	8		PR21 2254 D4 BCQ3	<b>TC54DXQ</b>
PR26	25	1	2		PR26 2251 D4 BCQ3	<b>ZC51DXQ</b>
PR26	25	2	4		PR26 2252 D4 BCQ3	<b>ZC52DXQ</b>
PR26	25	3	6		PR26 2253 D4 BCQ3	<b>ZC53DXQ</b>
PR26	25	4	8		PR26 2254 D4 BCQ3	<b>ZC54DXQ</b>
PR40	50	1	2		PR40 2251 D4 BCF Q72MN60	<b>HC51DAQ</b>
PR40	50	2	4		PR40 2252 D4 BCF Q72MN60	<b>HC52DBQ</b>
PR40	50	3	6		PR40 2253 D4 BCF Q72MN60	<b>HC53DCQ</b>
PR40	50	4	8		PR40 2254 D4 BCF Q72MN60	<b>HC54DDQ</b>
PR63	63	1	2		PR63 2251 D4 BCF Q72MN60	<b>IC51DAQ</b>
PR63	63	2	4		PR63 2252 D4 BCF Q72MN60	<b>IC52DBQ</b>
PR63	63	3	6		PR63 2253 D4 BCF Q72MN60	<b>IC53DCQ</b>
PR63	63	4	8		PR63 2254 D4 BCF Q72MN60	<b>IC54DDQ</b>

# CAM SWITCHES

## ▶ CHANGEOVER SWITCHES - WITH OFF

 Technical Info (p. 234)

### PANEL MOUNTING - TWO FIXING SCREWS

IP40 standard - IP65 available upon request

#### Contact Configuration

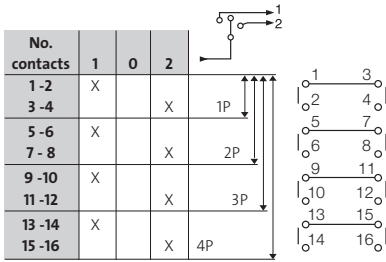

NC02GQ1



























SC04GQ1



ZC02GQ7



HC03GQ7

Switch Series	General use rating - amps	Number of poles	Number of contacts	Positions	Designation	Part Number
PR12	12	1	2		PR12 2201 C8 E Q48PN50	<b>NC01GQ1</b>
PR12	12	2	4		PR12 2202 C8 E Q48PN50	<b>NC02GQ1</b>
PR12	12	3	6		PR12 2203 C8 E Q48PN50	<b>NC03GQ1</b>
PR12	12	4	8		PR12 2204 C8 E Q48PN50	<b>NC04GQ1</b>
PR17	16	1	2		PR17 2201 C8 E Q48PN50	<b>SC01GQ1</b>
PR17	16	2	4		PR17 2202 C8 E Q48PN50	<b>SC02GQ1</b>
PR17	16	3	6		PR17 2203 C8 E Q48PN50	<b>SC03GQ1</b>
PR17	16	4	8		PR17 2204 C8 E Q48PN50	<b>SC04GQ1</b>
PR21	20	1	2		PR21 2201 C8 E Q48PN50	<b>TC01GQ1</b>
PR21	20	2	4		PR21 2202 C8 E Q48PN50	<b>TC02GQ1</b>
PR21	20	3	6		PR21 2203 C8 E Q48PN50	<b>TC03GQ1</b>
PR21	20	4	8		PR21 2204 C8 E Q48PN50	<b>TC04GQ1</b>
PR26	25	1	2		PR26 2201 C8 E Q72MN50	<b>ZC01GQ7</b>
PR26	25	2	4		PR26 2202 C8 E Q72MN50	<b>ZC02GQ7</b>
PR26	25	3	6		PR26 2203 C8 E Q72MN50	<b>ZC03GQ7</b>
PR26	25	4	8		PR26 2204 C8 E Q72MN50	<b>ZC04GQ7</b>
PR40	50	1	2		PR40 2201 C8 E Q72MN60	<b>HC01GQ7</b>
PR40	50	2	4		PR40 2202 C8 E Q72MN60	<b>HC02GQ7</b>
PR40	50	3	6		PR40 2203 C8 E Q72MN60	<b>HC03GQ7</b>
PR40	50	4	8		PR40 2204 C8 E Q72MN60	<b>HC04GQ7</b>
PR63	63	1	2		PR63 2201 C8 E Q72MN60	<b>IC01GQ7</b>
PR63	63	2	4		PR63 2202 C8 E Q72MN60	<b>IC02GQ7</b>
PR63	63	3	6		PR63 2203 C8 E Q72MN60	<b>IC03GQ7</b>
PR63	63	4	8		PR63 2204 C8 E Q72MN60	<b>IC04GQ7</b>

# CAM SWITCHES

## ► CHANGEOVER SWITCHES - WITH OFF

 Technical Info (p. 234)

### IN ENCLOSURE

IP40 standard - IP65 available upon request

#### Contact Configuration

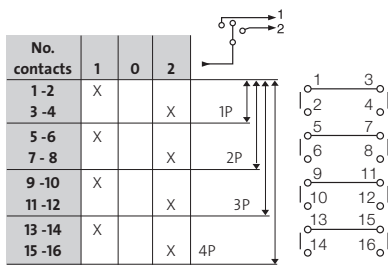

NC02GXQ









TC03GXQ



ZC04GXQ



IC02GBQ

Switch Series	General use rating - amps	Number of poles	Number of contacts	Positions	Designation	Part Number
PR12	12	1	2		PR12 2201 C8 BCQ3	<b>NC01GXQ</b>
PR12	12	2	4		PR12 2202 C8 BCQ3	<b>NC02GXQ</b>
PR12	12	3	6		PR12 2203 C8 BCQ3	<b>NC03GXQ</b>
PR12	12	4	8		PR12 2204 C8 BCQ3	<b>NC04GXQ</b>
PR17	16	1	2		PR17 2201 C8 BCQ3	<b>SC01GXQ</b>
PR17	16	2	4		PR17 2202 C8 BCQ3	<b>SC02GXQ</b>
PR17	16	3	6		PR17 2203 C8 BCQ3	<b>SC03GXQ</b>
PR17	16	4	8		PR17 2204 C8 BCQ3	<b>SC04GXQ</b>
PR21	20	1	2		PR21 2201 C8 BCQ3	<b>TC01GXQ</b>
PR21	20	2	4		PR21 2202 C8 BCQ3	<b>TC02GXQ</b>
PR21	20	3	6		PR21 2203 C8 BCQ3	<b>TC03GXQ</b>
PR21	20	4	8		PR21 2204 C8 BCQ3	<b>TC04GXQ</b>
PR26	25	1	2		PR26 2201 C8 BCQ3	<b>ZC01GXQ</b>
PR26	25	2	4		PR26 2202 C8 BCQ3	<b>ZC02GXQ</b>
PR26	25	3	6		PR26 2203 C8 BCQ3	<b>ZC03GXQ</b>
PR26	25	4	8		PR26 2204 C8 BCQ3	<b>ZC04GXQ</b>
PR40	50	1	2		PR40 2201 C8 BCF Q72MN60	<b>HC01GAQ</b>
PR40	50	2	4		PR40 2202 C8 BCF Q72MN60	<b>HC02GBQ</b>
PR40	50	3	6		PR40 2203 C8 BCF Q72MN60	<b>HC03GCQ</b>
PR40	50	4	8		PR40 2204 C8 BCF Q72MN60	<b>HC04GDQ</b>
PR63	63	1	2		PR63 2201 C8 BCF Q72MN60	<b>IC01GAQ</b>
PR63	63	2	4		PR63 2202 C8 BCF Q72MN60	<b>IC02GBQ</b>
PR63	63	3	6		PR63 2203 C8 BCF Q72MN60	<b>IC03GCQ</b>
PR63	63	4	8		PR63 2204 C8 BCF Q72MN60	<b>IC04GDQ</b>

# CAM SWITCHES

## ▶ THREE WAY SWITCHES - WITH OFF

 Technical Info (p. 234)

### PANEL MOUNTING - TWO FIXING SCREWS

IP40 standard - IP65 available upon request

#### Contact Configuration

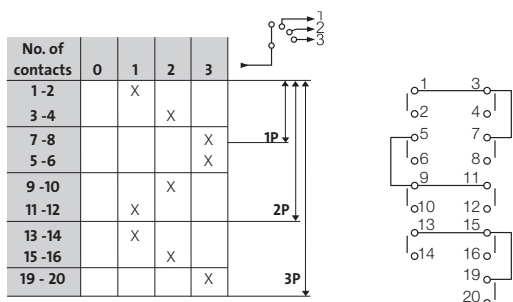

ND03AQ1



















SD03AQ1



ZD02AQ7



HD02AQ7

Switch Series	General use rating - amps	Number of poles	Number of contacts	Positions	Designation	Part Number
PR12	12	1	3		PR12 2301 A4 E Q48PN50	<b>ND01AQ1</b>
PR12	12	2	6		PR12 2302 A4 E Q48PN50	<b>ND02AQ1</b>
PR12	12	3	9		PR12 2303 A4 E Q48PN50	<b>ND03AQ1</b>
PR17	16	1	3		PR17 2301 A4 E Q48PN50	<b>SD01AQ1</b>
PR17	16	2	6		PR17 2302 A4 E Q48PN50	<b>SD02AQ1</b>
PR17	16	3	9		PR17 2303 A4 E Q48PN50	<b>SD03AQ1</b>
PR21	20	1	3		PR21 2301 A4 E Q48PN50	<b>TD01AQ1</b>
PR21	20	2	6		PR21 2302 A4 E Q48PN50	<b>TD02AQ1</b>
PR21	20	3	9		PR21 2303 A4 E Q48PN50	<b>TD03AQ1</b>
PR26	25	1	3		PR26 2301 A4 E Q72MN50	<b>ZD01AQ7</b>
PR26	25	2	6		PR26 2302 A4 E Q72MN50	<b>ZD02AQ7</b>
PR26	25	3	9		PR26 2303 A4 E Q72MN50	<b>ZD03AQ7</b>
PR40	50	1	3		PR40 2301 A4 E Q72MN60	<b>HD01AQ7</b>
PR40	50	2	6		PR40 2302 A4 E Q72MN60	<b>HD02AQ7</b>
PR40	50	3	9		PR40 2303 A4 E Q72MN60	<b>HD03AQ7</b>
PR63	63	1	3		PR63 2301 A4 E Q72MN60	<b>ID01AQ7</b>
PR63	63	2	6		PR63 2302 A4 E Q72MN60	<b>ID02AQ7</b>
PR63	63	3	9		PR63 2303 A4 E Q72MN60	<b>ID03AQ7</b>

# CAM SWITCHES

## ▶ THREE WAY SWITCHES - WITH OFF

 Technical Info (p. 234)

### IN ENCLOSURE

IP40 standard - IP65 available upon request

#### Contact Configuration

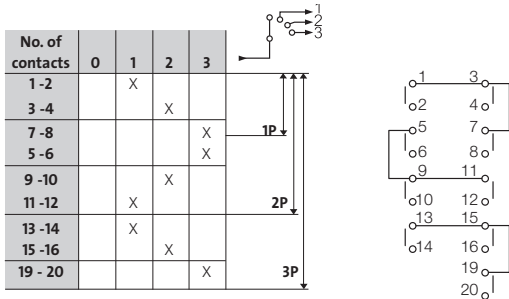

ND02AXQ









TD01AXQ



ZD01AXQ



HD01ABQ

Switch Series	General use rating - amps	Number of poles	Number of contacts	Positions	Designation	Part Number
PR12	12	1	3		PR12 2301 A4 BCQ3	<b>ND01AXQ</b>
PR12	12	2	6		PR12 2302 A4 BCQ3	<b>ND02AXQ</b>
PR12	12	3	9		PR12 2303 A4 BCQ3	<b>ND03AXQ</b>
PR17	16	1	3		PR17 2301 A4 BCQ3	<b>SD01AXQ</b>
PR17	16	2	6		PR17 2302 A4 BCQ3	<b>SD02AXQ</b>
PR17	16	3	9		PR17 2303 A4 BCQ3	<b>SD03AXQ</b>
PR21	20	1	3		PR21 2301 A4 BCQ3	<b>TD01AXQ</b>
PR21	20	2	6		PR21 2302 A4 BCQ3	<b>TD02AXQ</b>
PR21	20	3	9		PR21 2303 A4 BCQ3	<b>TD03AXQ</b>
PR26	25	1	3		PR26 2301 A4 BCQ3	<b>ZD01AXQ</b>
PR26	25	2	6		PR26 2302 A4 BCQ3	<b>ZD02AXQ</b>
PR40	50	1	3		PR40 2301 A4 BCF Q72MN60	<b>HD01ABQ</b>
PR40	50	2	6		PR40 2302 A4 BCF Q72MN60	<b>HD02ACQ</b>
PR63	63	1	3		PR63 2301 A4 BCF Q72MN60	<b>ID01ABQ</b>
PR63	63	2	6		PR63 2302 A4 BCF Q72MN60	<b>ID02ACQ</b>

# CAM SWITCHES

## ▶ 3 PHASE MOTOR SWITCH, FORWARD/OFF/REVERSE

 Technical Info (p. 234)

PANEL MOUNTING - TWO FIXING SCREWS

IP40 standard - IP65 available upon request

Contact Configuration - 9151

No. of contacts	REV	0	FWD
1-2	X		
3-4			X
5-6			X
7-8	X		
9-10	X		X

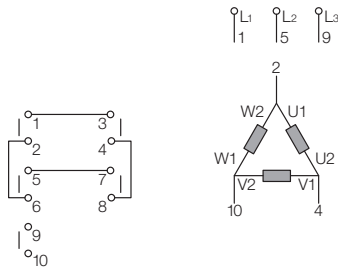

NZ11GQ1









TZ11GQ1



ZZ11GQ7



IZ11GQ7

Switch Series	General use rating - amps	Number of contacts	Positions	Designation	Part Number
PR12	12	5		PR12 9151 C8 E Q48PN50	<b>NZ11GQ1</b>
PR17	16	5		PR17 9151 C8 E Q48PN50	<b>SZ11GQ1</b>
PR21	20	5		PR21 9151 C8 E Q48PN50	<b>TZ11GQ1</b>
PR26	25	5		PR26 9151 C8 E Q72MN50	<b>ZZ11GQ7</b>
PR40	50	5		PR40 9151 C8 E Q72MN60	<b>HZ11GQ7</b>
PR63	63	5		PR63 9151 C8 E Q72MN60	<b>IZ11GQ7</b>

# CAM SWITCHES

## ▶ 3 PHASE MOTOR SWITCH, FORWARD/OFF/REVERSE

 Technical Info (p. 234)

### IN ENCLOSURE

IP40 standard - IP65 available upon request

Contact Configuration - 9151

No. of contacts	REV	0	FWD
1-2	X		X
3-4			X
5-6			X
7-8	X		
9-10	X		X

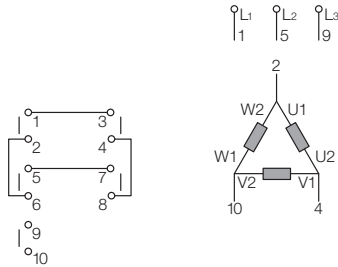

NZ11GXQ





SZ11GXQ



ZZ11GXQ



HZ11GCQ

Switch Series	General use rating - amps	Number of contacts	Positions	Designation	Part Number
PR12	12	5		PR12 9151 C8 BCQ3	<b>NZ11GXQ</b>
PR17	16	5		PR17 9151 C8 BCQ3	<b>SZ11GXQ</b>
PR21	20	5		PR21 9151 C8 BCQ3	<b>TZ11GXQ</b>
PR26	25	5		PR26 9151 C8 BCQ3	<b>ZZ11GXQ</b>
PR40	50	5		PR40 9151 C8 BCF Q72MN60	<b>HZ11GCQ</b>
PR63	63	5		PR63 9151 C8 BCF Q72MN60	<b>IZ11GCQ</b>

# CAM SWITCHES

## ► 1 SPEED STARTER, FORWARD/OFF/REVERSE - 3 PHASE MOTOR

 Technical Info (p. 234)

PANEL MOUNTING - TWO FIXING SCREWS

IP40 standard - IP65 available upon request

Contact Configuration - 9153

No. of contacts	REV			FWD	
	Δ	Y	0	Y	Δ
1 - 2				X	X
3 - 4	X	X			
5 - 6	X	X			
7 - 8				X	X
9 - 10	X				X
11 - 12	X				X
13 - 14		X	X		
15 - 16		X	X		
17 - 18	X			X	X
19 - 20	X	X		X	X

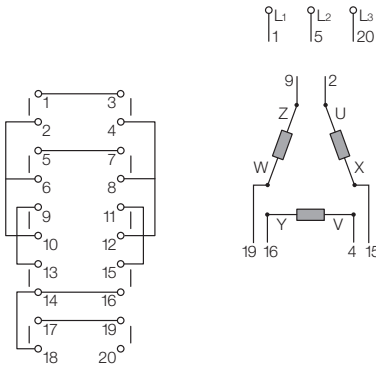

NZ13GQ1









TZ13GQ1



ZZ13GQ7



IZ13GQ7

Switch Series	General use rating - amps	Number of contacts	Positions	Designation	Part Number
PR12	12	10		PR12 9153 C8 E Q48PN50	<b>NZ13GQ1</b>
PR17	16	10		PR17 9153 C8 E Q48PN50	<b>SZ13GQ1</b>
PR21	20	10		PR21 9153 C8 E Q48PN50	<b>TZ13GQ1</b>
PR26	25	10		PR26 9153 C8 E Q72MN50	<b>ZZ13GQ7</b>
PR40	50	10		PR40 9153 C8 E Q72MN60	<b>HZ13GQ7</b>
PR63	63	10		PR63 9153 C8 E Q72MN60	<b>IZ13GQ7</b>



## CAM SWITCHES

### ▶ 1 SPEED STARTER, FORWARD/OFF/REVERSE - 3 PHASE MOTOR

 Technical Info (p. 234)

#### IN ENCLOSURE

IP40 standard - IP65 available upon request

Contact Configuration - 9153

No. of contacts	REV			FWD	
	Δ	Y	0	Y	Δ
1 - 2				X	X
3 - 4	X	X			
5 - 6	X	X			
7 - 8				X	X
9 - 10	X				X
11 - 12	X				X
13 - 14		X		X	
15 - 16		X		X	
17 - 18	X				X
19 - 20	X	X		X	X

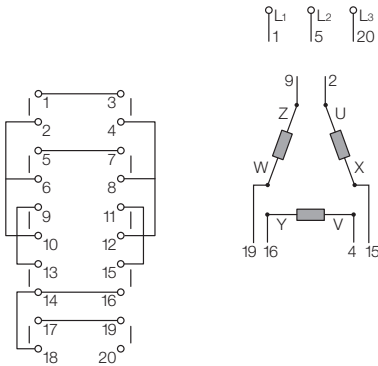



NZ13GXQ



SZ13GXQ



TZ13GXQ

Switch Series	General use rating - amps	Number of contacts	Positions	Designation	Part Number
PR12	12	10		PR12 9153 C8 BCQ3	NZ13GXQ
PR17	16	10		PR17 9153 C8 BCQ3	SZ13GXQ
PR21	20	10		PR21 9153 C8 BCQ3	TZ13GXQ

# CAM SWITCHES

## ► 1 SPEED STARTER, 1WAY - 3 PHASE MOTOR

 Technical Info (p. 234)

PANEL MOUNTING - TWO FIXING SCREWS

IP40 standard - IP65 available upon request

Contact Configuration - 9551

No. of contacts	0	Y	Δ
1 - 2		X	X
3 - 4			X
5 - 6	X	X	
7 - 8	X	X	
9 - 10			X
11 - 12			X
13 - 14		X	X
15 - 16		X	X

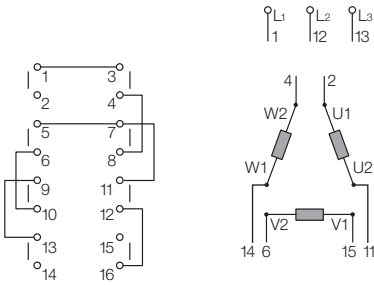

NZ51BQ1









TZ51BQ1



ZZ51BQ7



HZ51BQ7

Switch Series	General use rating - amps	Number of contacts	Positions	Designation	Part Number
PR12	12	8		PR12 9551 B4 E Q48PN50	<b>NZ51BQ1</b>
PR17	16	8		PR17 9551 B4 E Q48PN50	<b>SZ51BQ1</b>
PR21	20	8		PR21 9551 B4 E Q48PN50	<b>TZ51BQ1</b>
PR26	25	8		PR26 9551 B4 E Q72MN50	<b>ZZ51BQ7</b>
PR40	50	8		PR40 9551 B4 E Q72MN60	<b>HZ51BQ7</b>
PR63	63	8		PR63 9551 B4 E Q72MN60	<b>IZ51BQ7</b>

# CAM SWITCHES

## ► 1 SPEED STARTER, 1WAY - 3 PHASE MOTOR

 Technical Info (p. 234)

### IN ENCLOSURE

IP40 standard - IP65 available upon request

Contact Configuration - 9551

No. of contacts	0	Y	Δ
1 - 2		X	X
3 - 4			X
5 - 6	X	X	
7 - 8	X	X	
9 - 10			X
11 - 12			X
13 - 14		X	X
15 - 16		X	X

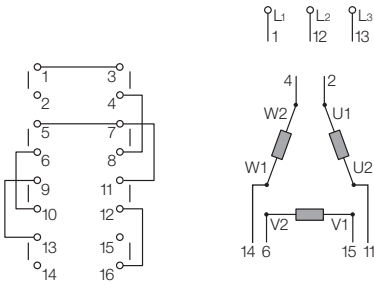

NZ51BXQ









SZ51BXQ



ZZ51BXQ



HZ51BDQ

Switch Series	General use rating - amps	Number of contacts	Positions	Designation	Part Number
PR12	12	8		PR12 9551 B4 BCQ3	<b>NZ51BXQ</b>
PR17	16	8		PR17 9551 B4 BCQ3	<b>SZ51BXQ</b>
PR21	20	8		PR21 9551 B4 BCQ3	<b>TZ51BXQ</b>
PR26	25	8		PR26 9551 B4 BCQ3	<b>ZZ51BXQ</b>
PR40	50	8		PR40 9551 B4 BCF Q72MN60	<b>HZ51BDQ</b>
PR63	63	8		PR63 9551 B4 BCF Q72MN60	<b>IZ51BDQ</b>

# CAM SWITCHES

## ► 2 SPEEDS, 1 WAY - 3 PHASE DALHANDER MOTOR

 Technical Info (p. 234)

### PANEL MOUNTING - TWO FIXING SCREWS

IP40 standard - IP65 available upon request

#### Contact Configuration - 9552

No. of contacts	LS	O	HS
1 - 2	X		
3 - 4			X
5 - 6			X
7 - 8	X		
9 - 10			X
11 - 12			X
13 - 14	X		
15 - 16			X

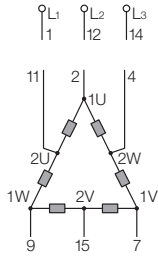
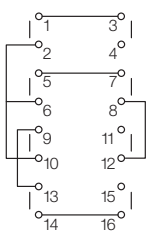

NZ52CQ1



SZ52BQ1





ZZ52BQ7



HZ52BQ7

No. of contacts	O	LS	HS
1 - 2		X	
3 - 4			X
5 - 6			X
7 - 8		X	
9 - 10			X
11 - 12			X
13 - 14		X	
15 - 16			X

Switch Series	General use rating - amps	Number of contacts	Positions	Designation	Part Number
PR12	12	8		PR12 9552 B4 E Q48PN50	<b>NZ52BQ1</b>
PR17	16	8		PR17 9552 B4 E Q48PN50	<b>SZ52BQ1</b>
PR21	20	8		PR21 9552 B4 E Q48PN50	<b>TZ52BQ1</b>
PR26	25	8		PR26 9552 B4 E Q72MN50	<b>ZZ52BQ7</b>
PR40	50	8		PR40 9552 B4 E Q72MN60	<b>HZ52BQ7</b>
PR63	63	8		PR63 9552 B4 E Q72MN60	<b>IZ52BQ7</b>

PR12	12	8		PR12 9552 C4 E Q48PN50	<b>NZ52CQ1</b>
PR17	16	8		PR17 9552 C4 E Q48PN50	<b>SZ52CQ1</b>
PR21	20	8		PR21 9552 C4 E Q48PN50	<b>TZ52CQ1</b>
PR26	25	8		PR26 9552 C4 E Q72MN50	<b>ZZ52CQ7</b>
PR40	50	8		PR40 9552 C4 E Q72MN60	<b>HZ52CQ7</b>
PR63	63	8		PR63 9552 C4 E Q72MN60	<b>IZ52CQ7</b>

# CAM SWITCHES

## ► 2 SPEEDS, 1 WAY - 3 PHASE DALHANDER MOTOR

 Technical Info (p. 234)

### IN ENCLOSURE

IP40 standard - IP65 available upon request

#### Contact Configuration - 9552

No. of contacts	LS	O	HS
1 - 2	X		
3 - 4			X
5 - 6			X
7 - 8	X		
9 - 10			X
11 - 12			X
13 - 14	X		
15 - 16			X

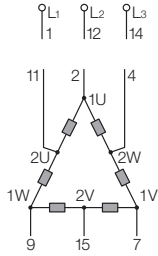
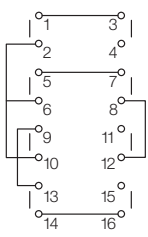

NZ52CXQ



TZ52BXQ





ZZ52BXQ



HZ52BDQ

No. of contacts	O	LS	HS
1 - 2		X	
3 - 4			X
5 - 6			X
7 - 8		X	
9 - 10			X
11 - 12			X
13 - 14		X	
15 - 16			X

Switch Series	General use rating - amps	Number of contacts	Positions	Designation	Part Number
PR12	12	8		PR12 9552 B4 BCQ3	<b>NZ52BXQ</b>
PR17	16	8		PR17 9552 B4 BCQ3	<b>SZ52BXQ</b>
PR21	20	8		PR21 9552 B4 BCQ3	<b>TZ52BXQ</b>
PR26	25	8		PR26 9552 B4 BCQ3	<b>ZZ52BXQ</b>
PR40	50	8		PR40 9552 B4 BCF Q72MN60	<b>HZ52BDQ</b>
PR63	63	8		PR63 9552 B4 BCF Q72MN60	<b>IZ52BDQ</b>

PR12	12	8		PR12 9552 C4 BCQ3	<b>NZ52CXQ</b>
PR17	16	8		PR17 9552 C4 BCQ3	<b>SZ52CXQ</b>
PR21	20	8		PR21 9552 C4 BCQ3	<b>TZ52CXQ</b>
PR26	25	8		PR26 9552 C4 BCQ3	<b>ZZ52CXQ</b>
PR40	50	8		PR40 9552 C4 BCF Q72MN60	<b>HZ52CDQ</b>
PR63	63	8		PR63 9552 C4 BCF Q72MN60	<b>IZ52CDQ</b>

# CAM SWITCHES

## ▶ AMMETER SWITCHES

 Technical Info (p. 234)

### 3 CURRENT TRANSFORMERS WITH COMMON POINT

IP40 standard - IP65 available upon request

Contact Configuration - 8151

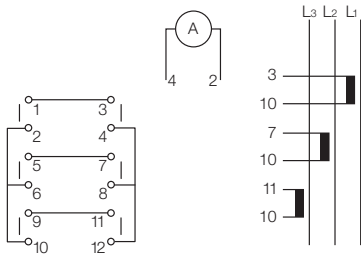

No. of CONTACTS	0	L1	L2	L3
1 - 2	X	X		
3 - 4	X	X		
5 - 6		X	X	
7 - 8		X	X	
9 - 10	X		X	X
11 - 12			X	X



NY11AQ1



NY11AX80

Switch Series	General use rating - amps	Mounting	Number of contacts	Positions	Designation	Part Number
PR12	12	TWO FIXING SCREWS	6		PR12 8151 A4 E Q48PN50	<b>NY11AQ1</b>
PR12	12	Ø22MM SINGLE HOLE	6		PR12 8151 A4 E N48MD50	<b>NY11AX80</b>

### WITHOUT CURRENT TRANSFORMER

IP40 standard - IP65 available upon request

Contact Configuration - 8164

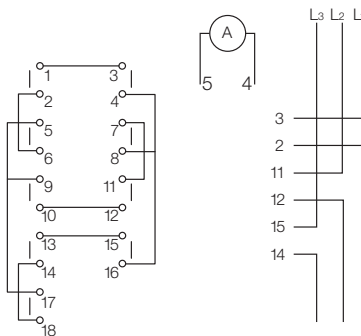

No. of contacts	0	L1	L2	L3
1 - 2	X	X		
3 - 4	X	X		
5 - 6		X	X	
7 - 8		X	X	
9 - 10		X	X	
11 - 12		X	X	
13 - 14	X		X	X
15 - 16			X	X
17 - 18			X	X



NY14AQ1



NY14AX80

Switch Series	General use rating - amps	Mounting	Number of contacts	Positions	Designation	Part Number
PR12	12	TWO FIXING SCREWS	9		PR12 8164 A4 E Q48PN50	<b>NY14AQ1</b>
PR12	12	Ø22MM SINGLE HOLE	9		PR12 8164 A4 E N48MD50	<b>NY14AX80</b>

# CAM SWITCHES

## ▶ AMMETER SWITCHES

 Technical Info (p. 234)

### WITHOUT COMMON POINT

IP40 standard - IP65 available upon request

Contact Configuration - 8157

No. OF CONTACTS	0	L1	L2	L3
1 - 2	X	X		
3 - 4	X	X		
5 - 6	X	X		
7 - 8		X	X	
9 - 10		X	X	
11 - 12		X	X	
13 - 14			X	X
15 - 16	X		X	X
19 - 20			X	X

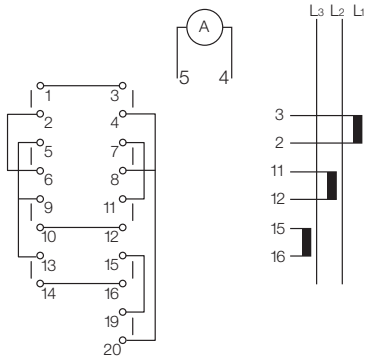

NY17AQ1



NY17AX80

Switch Series	General use rating - amps	Mounting	Number of contacts	Positions	Designation	Part Number
PR12	12	TWO FIXING SCREWS	9		PR12 8157 A4 E Q48PN50	<b>NY17AQ1</b>
PR12	12	Ø22MM SINGLE HOLE	9		PR12 8157 A4 E N48MD50	<b>NY17AX80</b>

# CAM SWITCHES

## VOLTMETER SWITCHES

 Technical Info (p. 234)

### WITHOUT NEUTRAL

IP40 standard - IP65 available upon request

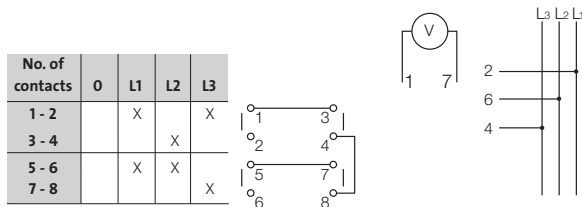

Contact Configuration - 8351



NY31AQ1



NY31AX80

Switch Series	General use rating - amps	Mounting	Number of contacts	Positions	Designation	Part Number
PR12	12	TWO FIXING SCREWS	4		PR12 8351 A4 E Q48PN50	<b>NY31AQ1</b>
PR12	12	Ø22MM SINGLE HOLE	4		PR12 8351 A4 E N48MD50	<b>NY31AX80</b>

### WITH NEUTRAL

IP40 standard - IP65 available upon request

Contact Configuration - 8357

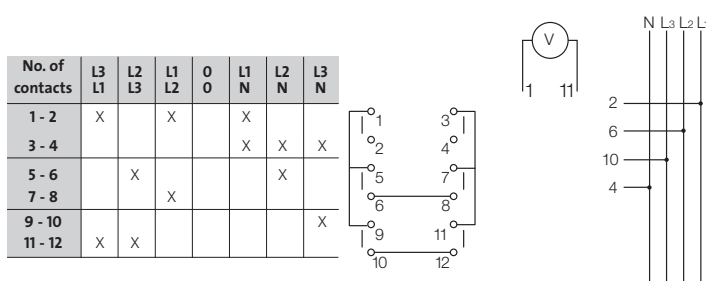



NY37GQ1



NY37GX80



NDF03

Switch Series	General use rating - amps	Mounting	Number of contacts	Positions	Designation	Part Number
PR12	12	TWO FIXING SCREWS	6		PR12 8357 C8 E Q48PN50	<b>NY37GQ1</b>
PR12	12	Ø22MM SINGLE HOLE	6		PR12 8357 C8 E N48MD50	<b>NY37GX80</b>
PR12	12	DIN-RAIL	6		PR12 8357 C8 E DF	<b>NDF03</b>



# CAM SWITCHES

## ▶ BINARY CODE SWITCHES

 Technical Info (p. 234)

### 0 TO 11

IP40 standard - IP65 available upon request

Contact Configuration - 6501

No. of contacts	Positions											
	0	1	2	3	4	5	6	7	8	9	10	11
1 - 2		X		X		X		X		X		X
3 - 4			X	X			X	X			X	X
5 - 6					X			X				
7 - 8									X			X

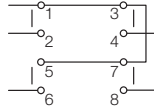

NR51UQ1

Switch Series	General use rating - amps	Mounting	Number of contacts	Positions	Designation	Part Number
PR12	12	TWO FIXING SCREWS	4		PR12 6501 A1 E Q48PN50	<b>NR51UQ1</b>

### 1 TO 12

IP40 standard - IP65 available upon request

Contact Configuration - 6501

No. of contacts	Positions											
	1	2	3	4	5	6	7	8	9	10	11	12
1 - 2	X		X		X		X		X		X	
3 - 4		X	X			X	X			X	X	
5 - 6				X			X					
7 - 8								X				X

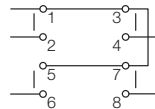

NR52UQ1

Switch Series	General use rating - amps	Mounting	Number of contacts	Positions	Designation	Part Number
PR12	12	TWO FIXING SCREWS	4		PR12 6502 A1 E Q48PN50	<b>NR52UQ1</b>

## CAM SWITCHES

### ▶ TECHNICAL SPECIFICATIONS

UL/CSA Characteristics	PR 12	PR 17	PR 21	PR 26	PR 40	PR 63	PR 125	PR 160
<b>▶ UL/CSA</b>								
1 PHASE 110/120 VAC	0.5 HP	1 HP	1.5 HP	2 HP	3 HP	5 HP	N/A	N/A
3 PHASE 110/120 VAC 220/240 VAC 440/480 VAC 550/600 VAC	1 HP	2 HP	3 HP	3 HP	7.5 HP	10 HP	N/A	N/A
	3 HP	5 HP	5 HP	7.5 HP	15 HP	20 HP	N/A	N/A
	5 HP	7.5 HP	10 HP	15 HP	30 HP	40 HP	N/A	N/A
	3 HP	10 HP	15 HP	20 HP	30 HP	40 HP	N/A	N/A
GENERAL USE (600 V) (MOTOR CONTROLLER)	12 A	16A	20 A	25 A	50 A	63 A	N/A	N/A
UL 508 RECOGNIZED	YES	YES	YES	YES	YES	YES	No	No
CSA CERTIFIED	YES	YES	YES	YES	YES	YES	No	No
<b>IEC Characteristics</b>								
<b>▶ For thermal current AC-20 Ith I<sub>c</sub>(A)</b> (IEC 60 947-3)	20	25	32	40	63	80	200	250
<b>▶ Rated operating current for AC-21 A I<sub>e</sub>(A)</b> (IEC 60 947-3)								
Switching of resistive loads including moderate overloads	16	20	25	32	50	80	160	200
<b>▶ Rated operating current for AC-15 A I<sub>e</sub>(A) at 230V AC</b> (IEC 60 947-3)								
Control of electromagnetic loads	6	8	10	12	-	-	-	-
<b>▶ Performance in AC 23 (kW)</b> (IEC 60 947-3)								
Switching of motors or other highly inductive loads								
- 3 x 230 V	4	5.5	7.5	11	15	18.5	-	-
- 3 x 400 V	7.5	11	11	11	22	25	-	-
- 3 x 500 V	5.5	11	11	11	25	25	-	-
- 3 x 690 V	4	10	10	11	18.5	22	-	-
<b>▶ Performance in AC 3</b> (IEC 60 947-3)								
Control of squirrel-cage motors starting and switching off motors while running - In kW								
- 3 x 230 V	3	4	4	5.5	11	15	-	-
- 3 x 400 V	4	7.5	7.5	11	18.5	22	-	-
- 3 x 500 V	5.5	7.5	7.5	11	18.5	22	-	-
- 3 x 690 V	3	7.5	7.5	11	18.5	22	-	-

# CAM SWITCHES

## ► TECHNICAL SPECIFICATIONS

IEC Characteristics	PR 12	PR 17	PR 21	PR 26	PR 40	PR 63	PR 125	PR 160
<b>► Performance in AC 3 - cont.</b>								
- In HP (for reference)								
- 3 x 230 V	4	5.5	5.5	7.5	15	20	-	-
- 3 x 400 V	5.5	10	10	15	25	30	-	-
- 3 x 500 V	7.5	10	10	15	25	30	-	-
- 3 x 690 V	4	10	10	15	25	30	-	-
<b>► Rated insulation voltage <math>U_i</math> (V)</b>								
- Max. rated voltage $U_e(v)$ IEC	690	690	690	690	690	690	690	690
- CSA (Canada)	600	600	600	600	600	600	600	600
- UL (USA)	600	600	600	600	600	600	600	600
<b>► Rated short time withstand current <math>I_{cw}</math> (A) for 1 sec</b>								
	300	400	420	800	1000	1000	2000	2400
<b>► Maximum wire size (mm<sup>2</sup>)</b>								
- rigid	4	6/4 <sup>(1)</sup>	6/4 <sup>(1)</sup>	6	16	16	∅ 8 screw for eyelet	
- flexible	2.5	4	4	6	16	16	∅ 8 screw for eyelet	
<b>► Maximum wire size (AWG)</b>								
- rigid	10	8/10 <sup>(1)</sup>	8/10 <sup>(1)</sup>	8	6	6		
- flexible	14	12	12	8	6	6		
(1): These values correspond to terminals with jumpers								
<b>► Mechanical durability</b> 1,250,000 operations, maximum rate 150 operations per hour								
<b>► Operating temperature limits</b> - 20°C to + 70°C - 4°F to + 158°F (beyond these limits consult us)								
<b>► Rated operating current in DC-1 low inductive loads (&lt; 1 ms)</b>								
Rated operating current $I_e$ (A) 24 V DC	16	20	25	32	50	80	-	-
$I_e$ (A): rated current for breaking 1 contact. For higher voltages you must use a reduction coefficient K in the following graph								

PR 12 PR 17 PR 21 PR 26 PR 40 PR 63 PR 125 PR 160

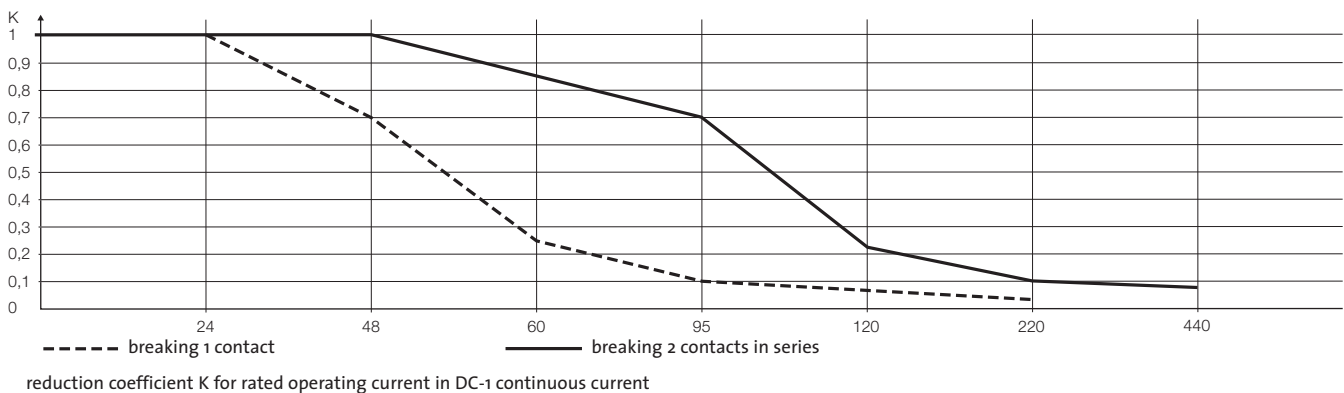

# CAM SWITCHES

## ► MOUNTING

### 2 SCREWS - 30 OR 50 MM INTERVAL

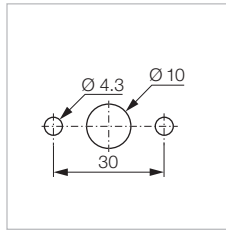

PR 12  
PR 17  
PR 21  
PR 26

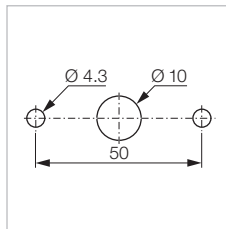

PR 40  
PR 63

### SINGLE HOLE MOUNTING Ø 22

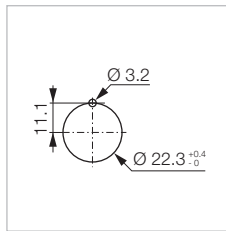

For PR12 only

- 48 legend plate with handle
- HANDLE
- LEVER
- KEY

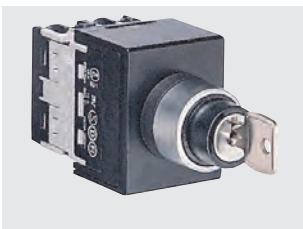

# CAM SWITCHES

## ► DIMENSIONS

### 2 SCREW FRONT MOUNTING (E)

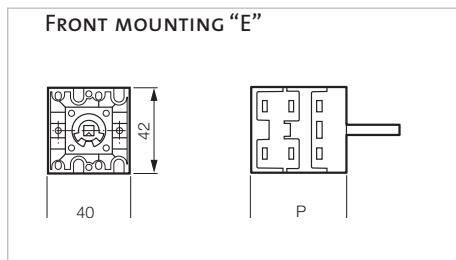

PR 12	No. of contacts	P*
	1-2	36
	3-4	46
	5-6	56
	7-8	66
	9-10	76
	11-12	86

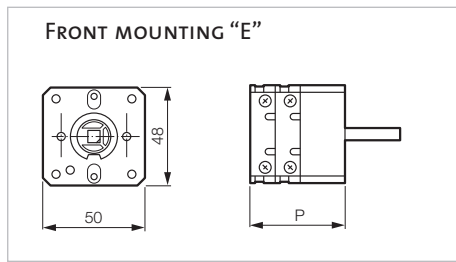

PR 17/21	No. of contacts	P*
	1-2	33
	3-4	45
	5-6	57
	7-8	69
	9-10	81
	11-12	93

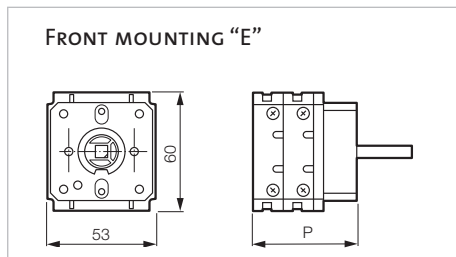

PR 26	No. of contacts	P*
	1-2	36
	3-4	51
	5-6	66
	7-8	81
	9-10	96
	11-12	111

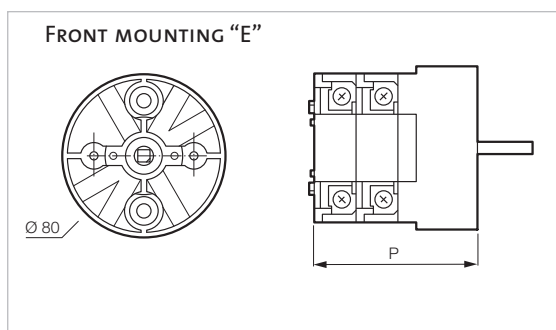

PR 40/63	No. of contacts	P*
	1-2	60
	3-4	80
	5-6	100
	7-8	120
	9-10	140
	11-12	160

# CAM SWITCHES

## ► DIMENSIONS

### SINGLE HOLE MOUNTING Ø 22

FRONT MOUNTING "E N48MD50"

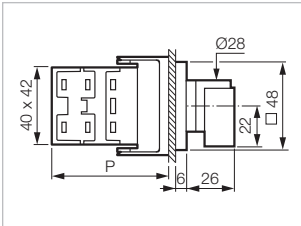

**WITH HANDLE AND LEGEND PLATE**

No. of contacts	P*
1-2	51
3-4	61
5-6	71
7-8	81
9-10	91
11-12	101

FRONT MOUNTING "E C21RA03"

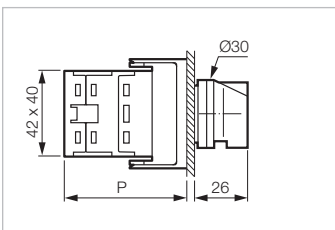

**WITH HANDLE OR LEVER**

No. of contacts	P*
1-2	51
3-4	61
5-6	71
7-8	81
9-10	91
11-12	101

FRONT MOUNTING "E C21RC00"

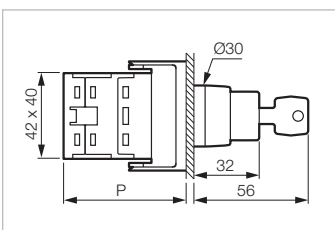

**WITH KEY**

No. of contacts	P*
1-2	51
3-4	61
5-6	71
7-8	81
9-10	91
11-12	101

## CAM SWITCHES

### ► DIMENSIONS

#### ENCLOSURES

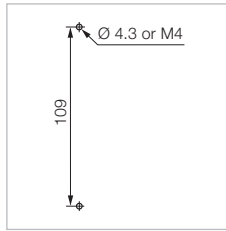
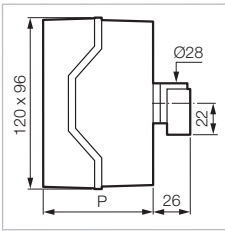

PR 12	No. of contacts	P*
	1-6	77
	7-10	101

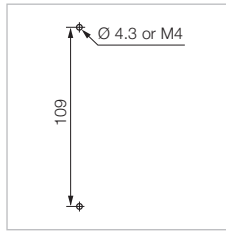
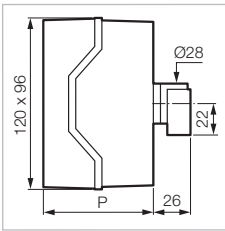

PR 17/21	No. of contacts	P*
	1-6	77
	7-10	101

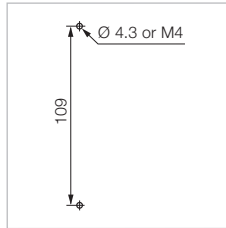
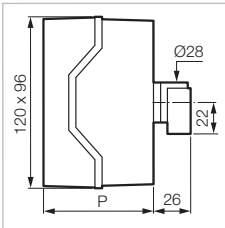

PR 26	No. of contacts	P*
	1-4	77
	5-8	101

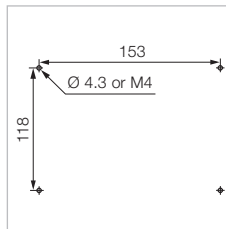
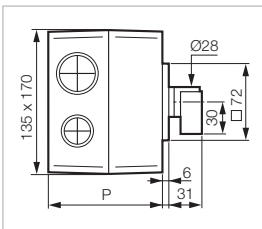

PR 40/63	No. of contacts	P*
	1-4	107
	5-8	145

# CAM SWITCHES - CUSTOM REQUEST FORM

## ▶ APPLICATION

- Load switching
  - resistive  inductive
- Rated voltage ..... AC/DC
- Rated current ..... A
- Control of motors
  - Starting/Switching off a running motor
- Reverse direction of rotation
- Motor rating ..... A/CV/kW/HP

## ▶ DIAGRAM

(Fill in the grid below using the appropriate symbols)

- Closed contact
- Closed contact, 2 positions without cut-off
- Overlapping: second contact closes before first contact opens (not possible with 30° switching angle)
- Impulse contact, closes momentarily when switching from one position to next
- Spring return

Contact Nos.	Position No.												Terminals connection + links	
	1	2	3	4	5	6	7	8	9	10	11	12		
1-2													0 1	3 0
3-4													0 2	4 0
5-6													0 5	7 0
7-8													0 6	8 0
9-10													0 9	11 0
11-12													0 10	12 0
13-14													0 13	15 0
15-16													0 14	16 0
17-18													0 17	19 0
19-20													0 18	20 0
21-22													0 21	23 0
23-24													0 22	24 0
25-26													0 25	27 0
27-28													0 26	28 0
29-30													0 29	31 0
31-32													0 30	32 0
33-34													0 33	35 0
35-36													0 34	36 0
37-38													0 37	39 0
39-40													0 38	40 0
41-42													0 41	43 0
43-44													0 42	44 0
45-46													0 45	47 0
47-48													0 46	48 0

## ▶ MOUNTING

- Front  One-hole
- Rear  DIN rail
- Enclosure

## ▶ STANDARD PRESENTATION

- Handle:  small  medium  large
- Lever:  small  large
- Color:  grey  black  red
- Selector switch style handle
- With key
  - Choice of key:  455  1424 A
  - other.....

## ▶ LEGEND PLATE AND ENGRAVING

Choice of legend plate size (mm):  
 48  64  72  96

Choice of legend plate color:  
 Alu  Black  Red  Yellow

- Engraving: (use opposite box to specify your engravings)
  - linear
  - polygonal
- Duty label (2 x 13 characters) :

## ▶ MARKING OF POSITIONS

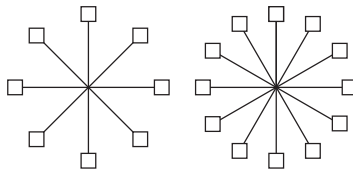

## ▶ SWITCHING ANGLE

- 90°  60°  45°  30°
- (indicate positions in boxes)

Blocking-off between ..... and ..... position  Tropicalized version  
 One-way rotation:  right  left

## YOUR DETAILS

Company:.....

.....

.....

Name and surname:.....

.....

Address:.....

.....

E-mail :.....

Tel:.....

Fax: .....

## COMMENTS

## YOUR ENGRAVINGS

## ▶ PADLOCKABLE PRESENTATION

Color:  yellow/red  grey  
 Size:  48  72  96

## ▶ OPTIONS

- Foolproof handle
- IP rating:  IP 40 (standard)  IP 55  IP 65
- Terminal covers
- Tropicalized version



# Comparison of IEC IP and UL/NEMA TYPE Ratings

NEMA 250 and UL 50 specify requirements and test for the degree of protection against entry as well as environmental conditions such as falling dirt, ice, corrosion, oil and coolants whereas IEC 60529 does not have such requirements. Different rating requirements make comparison difficult and disagreements are common.

The IEC designation consists of the letters IP followed by two numerals. The first number indicates the degree and solid foreign objects entering the enclosure. The second number indicates the degree of protection provided by the enclosure with respect to the harmful ingress of water.

CAUTION IS NECESSARY WHEN ATTEMPTING TO EQUATE IEC AND UL/NEMA ENCLOSURE RATINGS BECAUSE AN EXACT EQUIVALENCE IS NOT POSSIBLE.

IP First Character	"TYPE" RATED ENCLOSURES														IP Second Character		
	1	2	3	3R	3S	4	4X	5	6	6P	12	12K	13				
IP0_																	IP_0
IP1_																	IP_1
IP2_																	IP_2
IP3_																	IP_3
IP4_																	IP_4
IP5_																	IP_5
IP6_																	IP_6
																	IP_7
																	IP_8
	A	B	A	B	A	B	A	B	A	B	A	B	A	B	A	B	

A = IP First Character

B = IP Second Character

A shaded block in the 'A' column indicates that the enclosure TYPE exceeds the requirements for the respective IEC 60529 IP first character designation. The IP first character designation is the protection against access to hazardous parts and solid foreign material.

A shaded block in the 'B' column indicates that the enclosure TYPE exceeds the requirements for the respective IEC 60529 IP second character designation. The IP second character designation is the protection against the ingress of water.

## UL/NEMA Type Ratings

### Type 4X

For indoor or outdoor use. To provide protection against windblown rain and dust, splashing or hose directed water, and external formation of ice. Corrosion resistant.

### Type 12

For indoor use. To provide protection against dust, falling dirt, dripping non-corrosive liquids, lint, fibers, external condensation of non-corrosive liquids and light splashing water.

### Type 13

For indoor use primarily to provide a degree of protection against dust, spraying of water, oil and non-corrosive coolant.

## IEC IP Ratings

### IP65

Protected from total dust ingresses. Protected from low pressure water jets.

### IP66

Protected from total dust ingresses. Protected from high pressure water jets.

### IP67

Protected from total dust ingresses. Protected from immersion between 15 centimeters and 1 meter depth.

### IP69K

Protected from total dust ingresses. Protected from high temperature, high pressure water jets.



**Pushbuttons**



**Disconnects**



**Cam Switches**



**BACO<sup>®</sup>**  
**CONTROLS**

www.bacocontrols.com  
8431 Loop Rd  
Baldwinsville, NY 13027  
Tel: 315.635.2500  
Fax: 800.356.3981