

HD 15 Male

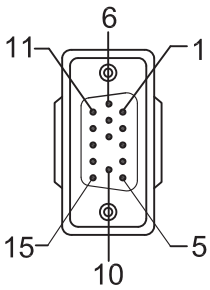

P1

2,000MM±50MM

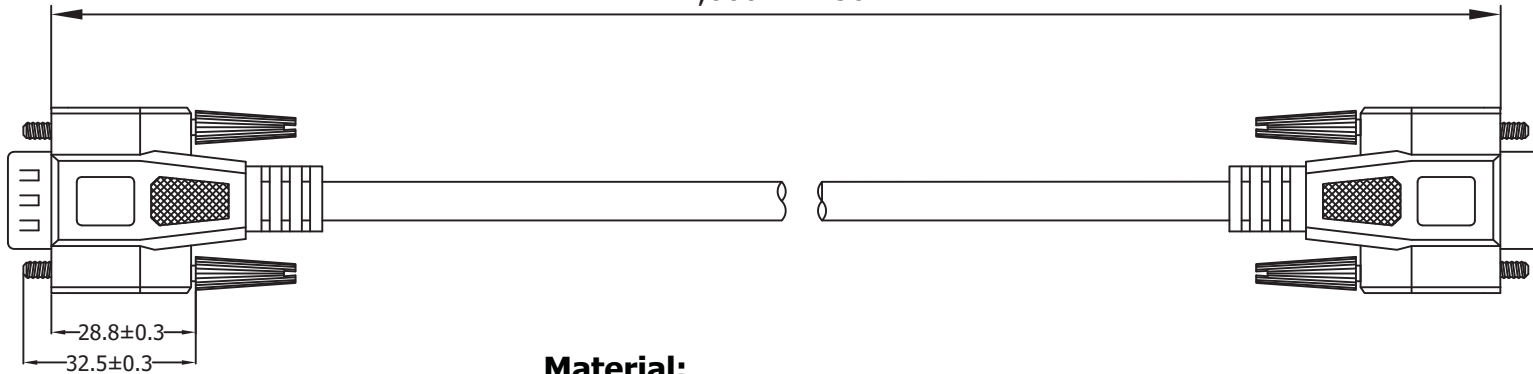

HD 15 Female

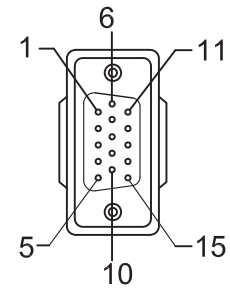

P2

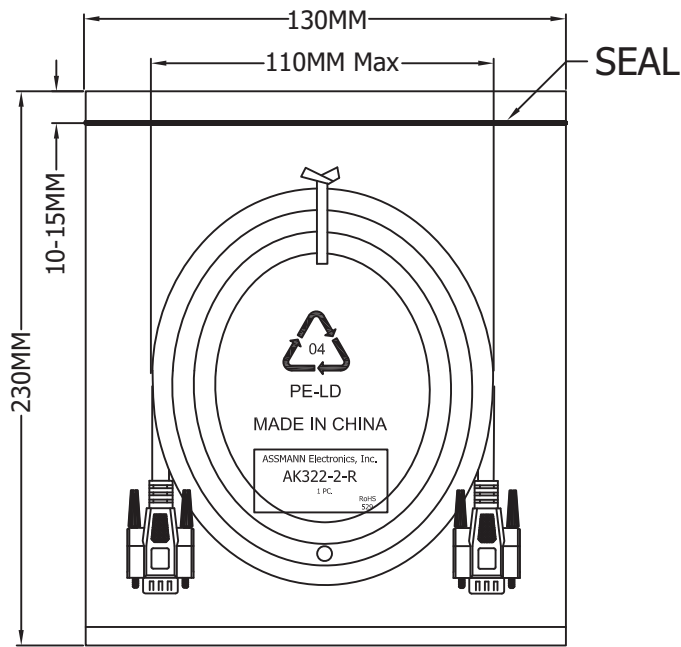

1PCS / PE Bag

Material:

- Cable: NOUL 28AWG(7/0.12TC)*14C+AL/MY+D.W(7/0.12 TC)
 - OD Ø6.0±0.15MM
 - Outer Jacket Color: Beige(IV-29)
- P1 Connector: HDD15P Male Solder Type
 - Pin G/F
 - Insulation Color: Blue
 - Shell Plate Nickel
- P1 Connector: HDD15P Female Solder Type
 - Pin G/F
 - Insulation Color: Blue
 - Shell Plate Nickel
- Inner Jacket: Clear LDPE
- Outer Jacket: Beige, 40P PVC
- Screw: #4-40UNC
 - Length: 47MM
 - Nickel Plated
- Copper Foil: Double Sided Conductive Copper Foil, 18µ" W25MM*L55MM

Electrical:

- 100% Test, (Open, Short, Miss Wire)
- Contact Resistance: 3Ω Max.
- Insulation Resistance: 5MΩ Min.
- Hi-Pot: 300V DC/10ms

PIN Assignment

P1		P2
1	WHITE	1
2	GREY	2
3	YELLOW	3
4	PINK	4
5	ORANGE	5
6	RED	6
7	BROWN	7
8	GREEN	8
10	BLUE	10
11	PURPLE	11
12	LIGHT GREEN	12
13	LIGHT BLUE	13
14	BLACK	14
15	WHITE/BLACK	15
Shell	DRAIN	Shell

Ⓜ = Assmann logo



ITEM NO.

AK322-2-R

TITLE VGA Monitor Extension Cable - 2 Meters
HD D-Sub 15pin Female <=> HD D-Sub 15pin Male

ASSMANN
Electronics, Inc.

1840 W. Drake Drive, Suite 101 • Tempe, AZ 85283
Toll Free: 1-877-277-6266 • Email: info@usa-assmann.com

THIS DRAWING IS UNPUBLISHED
©Copyright 2010 by Assmann Electronic Components
All International Rights Reserved