





















General Catalog  
**Timers, Counters, Hour Meters**







# Table of Contents

<b>General Information Timers</b>	
Timers Chart Overview	4
Timers Selector Chart	5
Timer-Related Terminology	8
On-Delay Timer Basic Circuit	10
General Application Guidelines	11
<b>Digital Timers</b>	
LT4H	14
LT4H-W	20
LT4H Series Cautions for use	25
QM4H	28
<b>Analog Timers</b>	
S1DXM-A/M	32
PM4H-A/S/M	38
PM4H-SD/SDM	44
PM4H-F	46
PM4H-W	50
PM5S - A/S/M	55
Installing DIN Size Timer	62
<b>Options and Accessories Timers</b>	<b>63</b>
<b>General Information Counters and Hour Meters</b>	
Counters Selector Chart	69
Counter-Related Terminology	70
Precautions in using the Counter	71
<b>Counters</b>	
LC2H DIN Half	73
LC2H Preset	81
Precautions in using the LC2H Series	87
LC4H	90
LC4H-S	97
LC4H-W	106
Precautions in using the LC4H Series	114
Installing DIN Size Counter (Common)	117
<b>Hour Meters LCD</b>	
Hour Meters Selector Chart	118
LH2H DIN Half Size HM	120
LH2H Preset Type	128
Precautions in using the LH2H Series	133
<b>Hour Meters, electromechanical</b>	
TH13/TH23	137
TH14/TH24	139
TH40	141
TH50	143
TH63/TH64	145
TH8	147
Precautions in using the Hour Meters	149
<b>Options and Accessories for Counters and Hour Meters</b>	<b>150</b>
<b>Applications / Power Supplies / International Standards</b>	<b>153</b>







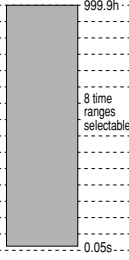
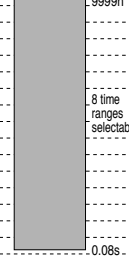
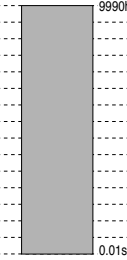
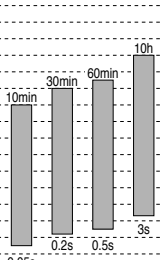
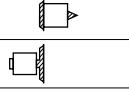
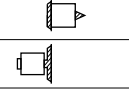
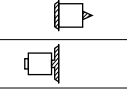
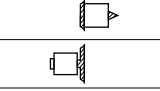
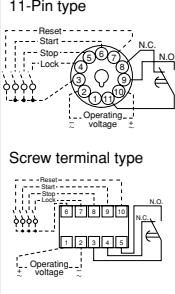
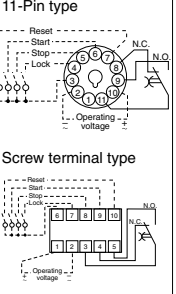
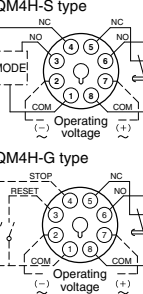
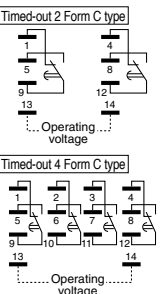





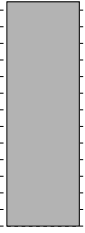

# TIMERS CHART OVERVIEW

		Multiple operation	ON-delay	OFF-delay	Twin	Flicker	One-shot	Star delta	Integration
Multi-range analog timer (CR oscillation)	Digital quartz timers	 LT4H LT4H-W	 LT4H QM4H	 LT4H (Signal)	 LT4H-W	 LT4H	 LT4H		 LT4H
	Surface mount/Flush mount	 PM4H-A PM5S-A	 S1DX PM4H-S PM4H-M PM5S-S S1DXM-A/M	 PM4H-A (Signal) PM4H-F PM5S-A (Signal) PM5S-M (Signal)	 PM4H-W	 PM4H-A PM5S-A PM5S-M S1DX S1DXM-M	 PM4H-A PM5S-A PM5S-M S1DX S1DXM-M		 PM4H-SD/SDM
	Relay terminal socket		 S1DXM-A/M			 S1DXM-M	 S1DXM-M		
	PC board mount		 S1DX						

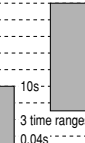
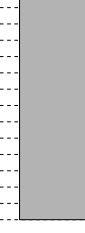





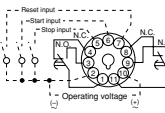
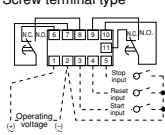
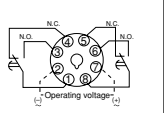
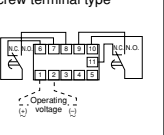
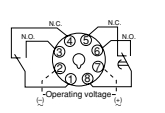
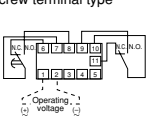
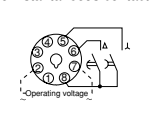
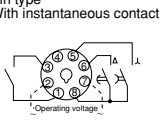
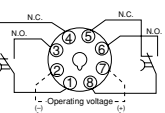
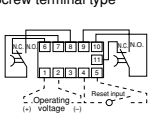
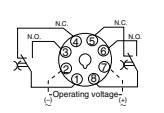
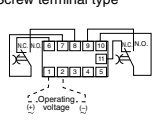

# TIMERS SELECTOR CHART

Model/Product Name					
Operation mode		Power ON delay (1) Power ON delay (2) Signal ON delay Signal OFF delay Pulse One-shot Pulse ON-delay Signal Flicker Totalizing ON-delay	ON-start flicker OFF-start flicker Delay one-shot	Power ON-delay	Power ON-delay Power flicker Power One-shot
Major uses		Quartz oscillation counting timer Suitable for super-high accurate, digital setting			CR oscillation counting timer For highly accurate time setting
Time range					
Features		Bright and easy-to-read display Simple operation Short body	Bright and easy-to-read display Simple operation Wide time setting range	Possible to set and change the time with front digit switches easily during the power off. Furthermore single unit has a time range of 0.01s to 9990hrs!!	With a large transparent dial. This timer can be attached both on the DIN rails and panel.
Control output (resistive)	Current	(Relay output type) 7A 5A 3A	(Relay output type) 5A (Transistor output type) 100mA	5A	7A 2 Form C type 5A 4 Form C type
	Voltage	250 V AC 30 V DC	250 V AC 30 V DC	250 V AC	250 V AC
Mounting method					
Mounting parts		Terminal block, cap, panel cover, rubber gasket, mounting frame	Terminal block, cap, panel cover, rubber gasket, mounting frame	Terminal block, cap, panel cover, rubber gasket, mounting frame	Terminal block, cap block, mounting frame, fitting sockets, protective cover
Rated operating voltage		100 to 240 V AC 24 V AC 12 to 24 V DC (other models)	100 to 240 V AC 24 V AC 12 to 24 V DC (other models)	100 to 240 V AC/DC 12 to 48 V AC/DC (other models)	100 to 120 V AC 200 to 220 V AC 12 V DC, 24 V DC (other models)
Arrangement		(Relay output type) Timed-out 1 Form C (Transistor output type) Timed-out 1 Form A	(Relay output type) Timed-out 1 Form C (Transistor output type) Timed-out 1 Form A	T.D. mode: Time delay 2C INST. mode: Time delay 1C and instantaneous 1C (Use MODE switch on front)	Timed-out 2 Form C Timed-out 4 Form C
Time accuracy	Operation time fluctuation	$\pm(0.005\% + 50 \text{ ms})$	$\pm(0.005\% + 80 \text{ ms})$	$\pm(0.01\% + 0.05 \text{ s})$	$\pm 1\%$
	Temperature error	in case of power on start	in case of power on start	in case of power on start	$\pm 5\%$
	Voltage error	$\pm(0.005\% + 20 \text{ ms})$	$\pm(0.005\% + 20 \text{ ms})$	$\pm 0.005\% \pm 0.03 \text{ s}$ (G type only)	$\pm 1\%$
	Setting error	in case of reset or input signal start	in case of reset or input signal start		$\pm 10\%$
Min. power off time		500 ms	500 ms	100 ms	100 ms
Life (Min. operation)	Mechanical	$2 \times 10^7$	$2 \times 10^7$	$2 \times 10^7$	$10^7$
	Electrical	$10^5$	$10^5$	$10^5$	$2 \times 10^5$
Terminal layouts and Wiring diagrams					
Available standards		UL/c-UL, CE	UL/c-UL, CE	UL/c-UL, CE	UL/c-UL, CE

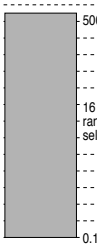
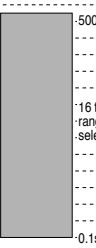
# TIMERS SELECTOR CHART

Model/Product Name							
Operation mode		Pulse ON-delay Pulse Flicker Pulse ON-Flicker Differential ON/OFF-delay (1)(2) Signal OFF-delay Pulse One-shot Pulse One-cycle	Power ON-delay	Power ON-delay Power Flicker Power ON-flicker Power One-shot Power One-cycle (with instantaneous contact)	Star-Delta	Power OFF-delay	Power OFF-start cyclic
Major uses		For time control for short or long time	For time control for short or long time	For self holding circuit	For SD motor start-up	For all uses of power OFF-delay	For repetitive ON/OFF operation
Time range							
Features		16 time ranges are selectable. 1s to 500h (Max. range) is controlled. 8 operation modes available.	16 time ranges are selectable. 1s to 500h (Max. range) is controlled in one unit.	16 time ranges are selectable. 1s to 500h (Max. range) is controlled in one unit. 5 operation modes (with instantaneous contact) available.	4 time ranges are selectable. 2s to 100s (Max. range) is controlled in one unit. 5 time ranges selectable for the $\Delta$ - $\Delta$ switching times.	Multiple time ranges are selectable. Power-OFF delay of max. 10 min. is controlled.	16 time ranges are selectable. 1s to 500h (Max. range) is controlled in one unit.
Control output (resistive)	Current	7A 5A 3A	5A	5A	5A	3A	5A
	Voltage	250 V AC	250 V AC	250 V AC	250 V AC	250 V AC	250 V AC
Mounting method							
Mounting parts		Terminal block, cap, panel cover, rubber gasket, mounting frame	Terminal block, cap, panel cover, rubber gasket, mounting frame	Terminal block, cap, panel cover, rubber gasket, mounting frame	Terminal block, cap, panel cover, rubber gasket, mounting frame	Terminal block, cap, panel cover, rubber gasket, mounting frame	Terminal block, cap, panel cover, rubber gasket, mounting frame
Rated operating voltage		100 to 240 V AC, 48 to 125V DC, 24 V AC/DC, 12 V DC (other models)	100 to 240 V AC, 48 to 125V DC, 24 V AC/DC, 12 V DC (other models)	100 to 240 V AC, 48 to 125V DC, 24 V AC/DC, 12 V DC (other models)	100 to 240 V AC, 24 V AC (other models)	100 to 120 V AC, 200 to 240 V AC, 12 V DC, 24 V DC, 24 V AC (other models)	100 to 240 V AC, 48 to 125V DC, 24 V AC/DC, 12 V DC (other models)
Arrangement		Timed-out 2 Form C	Timed-out 2 Form C	Timed-out 1 Form C Instantaneous 1 Form C	$\Delta$ side: Timed-out 1 Form A $\Delta$ side: Timed-out 1 Form A Instantaneous: 1 Form A	Timed-out 2 Form C Timed-out 1 Form C [F8R type]	Timed-out 2 Form C
Time accuracy	Operation time fluctuation	$\pm 0.3\%$	$\pm 0.3\%$	$\pm 0.3\%$	$\pm 0.3\%$	$\pm 0.3\%$	$\pm 0.3\%$
	Temperature error	$\pm 2\%$	$\pm 2\%$	$\pm 2\%$	$\pm 2\%$	$\pm 2\%$	$\pm 2\%$
	Voltage error	$\pm 0.5\%$	$\pm 0.5\%$	$\pm 0.5\%$	$\pm 0.5\%$	$\pm 0.5\%$	$\pm 0.5\%$
	Setting error	$\pm 5\%$	$\pm 5\%$	$\pm 5\%$	$\pm 5\%$	$\pm 5\%$	$\pm 5\%$
Min. power off time		100 ms	100 ms	100 ms	500 ms	—	300 ms
Life (Min. operation)	Mechanical	$2 \times 10^7$	$2 \times 10^7$	$2 \times 10^7$	$2 \times 10^7$	$10^7$	$2 \times 10^7$
	Electrical	$10^5$	$10^5$	$10^5$	$10^5$	$10^5$	$10^5$
Terminal layouts and wiring diagrams		<p>Pin type</p>  <p>Screw terminal type</p> 	<p>Pin type</p>  <p>Screw terminal type</p> 	<p>Pin type</p>  <p>Screw terminal type</p> 	<p>Pin type No instantaneous contact</p>  <p>Pin type With instantaneous contact</p> 	<p>Pin type</p>  <p>Screw terminal type</p> 	<p>Pin type</p>  <p>Screw terminal type</p> 
Available standards		UL/CSA, CE, LLOYD	UL/CSA, CE, LLOYD	UL/CSA, CE, LLOYD	UL/CSA, CE, LLOYD	UL/CSA, CE, LLOYD	UL/CSA, CE, LLOYD

# TIMERS SELECTOR CHART

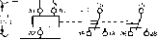
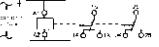
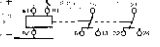
Model/Product Name		 <b>PM5S-A</b> Multi-range analog timer	 <b>PM5S-S</b> Multi-range analog timer	 <b>PM5S-M</b> Multi-range analog timer
Operation mode		Pulse ON-delay Pulse Flicker Pulse ON-Flicker Signal OFF-delay Pulse One-shot Pulse One-cycle	Power ON-delay	Pulse ON-delay Pulse Flicker Pulse ON-flicker Signal OFF-delay Pulse One-shot Pulse One-cycle (with instantaneous contact)
Major uses		For time control for short or long time	For time control for short or long time	For self holding circuit
Time range		 16 time ranges selectable.		 16 time ranges selectable.
Features		16 time ranges are selectable. 1s to 500h (Max. range) is controlled. 6 operation modes available.	16 time ranges are selectable. 1s to 500h (Max. range) is controlled in one unit.	16 time ranges are selectable. 1s to 500h (Max. range) is controlled in one unit. 6 operation modes (with instantaneous contact) available.
Control output (resistive)	Current	 5A	 5A	 5A
	Voltage	250 V AC	250 V AC	250 V AC
Mounting method				
Mounting parts		Terminal block, cap, panel cover, rubber gasket, mounting frame	Terminal block, cap, panel cover, rubber gasket, mounting frame	Terminal block, cap, panel cover, rubber gasket, mounting frame
Rated operating voltage		24 to 240V AC/DC	24 to 240V AC/DC	24 to 240V AC/DC
Arrangement		Timed-out 2 Form C	Timed-out 2 Form C	Timed-out 1 Form C Instantaneous 1 Form C
Time accuracy	Operation time fluctuation	±0.3%	±0.3%	±0.3%
	Temperature error	±2%	±2%	±2%
	Voltage error	±0.5%	±0.5%	±0.5%
	Setting error	±10%	±10%	±10%
Min. power off time		100 ms	100 ms	100 ms
Life (Min. operation)	Mechanical	2 × 10 <sup>7</sup>	2 × 10 <sup>7</sup>	2 × 10 <sup>7</sup>
	Electrical (resistive)	10 <sup>5</sup>	10 <sup>5</sup>	10 <sup>5</sup>
Wiring diagrams				
Available standards		UL/C-UL	UL/C-UL	UL/C-UL

# TIMER-RELATED TERMINOLOGY

## • What is a timer?

The timer is a relay having such an output (with or without contact) which electrically closes (turns ON) or opens (turns OFF) the circuit after a preset time elapses when electrical or mechanical input is given.

## • On-delay Operation (Time delay operation)

The on-delay operation is an operation to give output when preset time expires after a predetermined input is given to the power supply circuit or input circuit. On-delay operation includes power supply on-delay operation and signal on-delay operation.

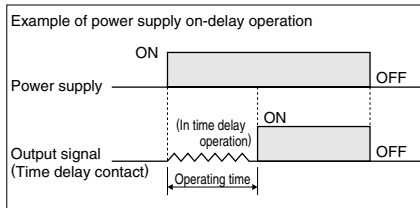

## • Off-delay Operation (Time delay resetting)

The off-delay operation is an operation to turn OFF output when preset time expires after a predetermined input is given to the power supply circuit or input circuit, and at the same time output signal is given and predetermined input is turned OFF. Off-delay operation includes power supply off-delay operation and signal off-delay operation.

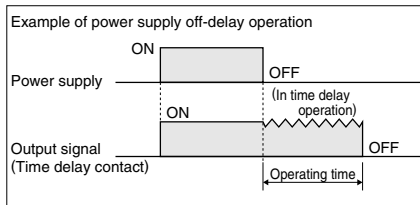

## • Flicker Operation

The flicker operation is an operation to repeat output ON/OFF action according to preset ON time and OFF time while a predetermined input is given to the power supply circuit or input circuit. Flicker operation includes OFF-start flicker operation and ON-start flicker operation.

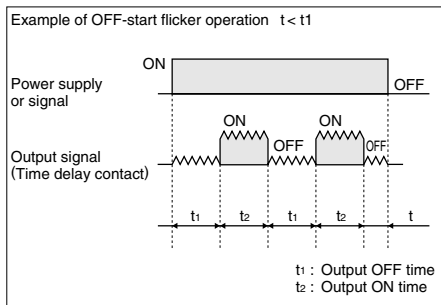

## • Star (∧) /Delta (Δ) Operation

This operation controls the time in the star connection used for star-delta starting which is conducted for starting a cage induction motor and the time for switching the star connection over to delta connection.

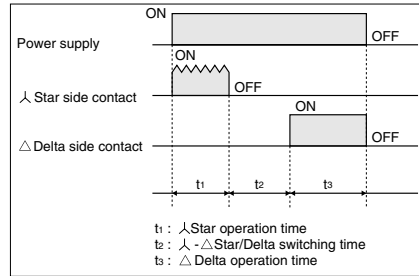

## • Preset Time

The preset time is the control time set by setting time-variable timer.

## • Operating Time

The operating time means the time which elapses between the addition of predetermined input to the power supply circuit and input circuit and the completion of operation for preset time.

## • Hold Time

It means the time which elapses between the completion of operation for preset time and the start of resetting.

## • Pause Time

It means the time elapses between the start of operation for preset time and the addition of input required again for the power supply circuit or input circuit. Timer does not perform normal function unless this pause time is set longer than the timer reset time.

## • Resetting

It means that the operation returns to the state before starting while the timer is in operation for preset time or after it completes the operation for preset time. Resetting during the operation for preset time is referred to as halfway resetting.

## • Reset Time

It means the time elapses between shut-off of input to the power supply circuit or input of reset signal and the completion of resetting.

Timer resetting function shares the reset of contact, reset of mechanical parts such as pointer etc., reset of parts in internal circuit such as capacitor etc., and the value at which all of these parts complete their resetting operation is regarded as reset time. If timer is used for a pause time shorter than specified reset time, the operation time expires earlier than preset, unexpected instantaneous operation takes place or the operation is failed, thus making it impos-

sible to expect the normal operation.

Therefore, be sure to set the timer pause time longer than the specified reset time.

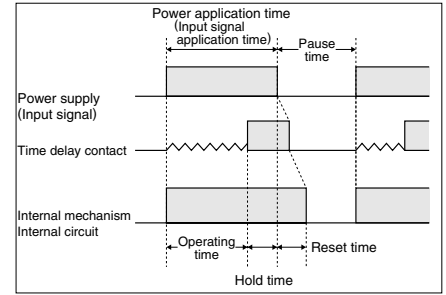

## • Minimum Power Application Time

It means the minimum time during which power must be supplied in order to operate timer normally, in the case of power supply off-delay timer.

## • Fluctuation of Operating Time

It means the irregularity in operating time caused when timer is set at specified time and the operation is repeated under the same conditions. It is also referred to as repetitive error.

## • Voltage Error

It means the difference between the operating time at the rated voltage and that within the allowable voltage range.

## • Temperature Error

It means the difference between the operating time at the temperature of  $20 \pm 2^\circ\text{C}$  and that within the allowable temperature range.

## • Set Error

It means the difference between the set time and the time which actually elapses. It is also referred to as setting error.

The set error of an analog timer is the rate to the full-scale value. If the set error is  $\pm 5\%$ , it becomes equivalent to an error of maximum  $\pm 5$  hours on the assumption that 100 hours is set in the range of 100 hours. The error produced when 10 hours is set is also equivalent to an error of maximum  $\pm 5$  hours. As far as the set error is concerned, digital timer is by far exact. Select a digital timer for the case when accuracy is required.

When using an analog type multi-range timer for setting of long time, the setting procedure stated as follows minimizes the error. For example, if you want to set 8 hours in the range of 10 hours, first set the pointer to such a graduation where the actual operating time should become as close to 8 seconds as possible in the range of 10 seconds. Then, reset the range to 10 hours, leaving the pointer set at the graduation as it is.



# TIMER-RELATED TERMINOLOGY

## • Pause Time Error

It means the difference between the operating time to a fixed pause time and the operating time to a pause time that varies. The pause time characteristics are the main characteristics of CR timer (timer exploiting charge and discharge of capacitor C and resistance R).

If the oscillation count timer (timer which comprises an oscillation circuit composed of CR and quartz and is operated by a counting circuit inside IC or micro-computer which counts the reference signal) is used, the pause time error becomes almost negligible owing to its principles of operation. Accordingly, the description about these characteristics may be omitted for the oscillation count timer.

## • Equation for Each Error and Measurement Conditions

The operation time shall be measured, in principle, for retention time of 0.5 second and halt time of 1 second.

The measurement shall be repeated five times except for the initial test. The equation for each error and the measurement conditions are shown in the table below:

Item	Equation	Measurement conditions			
		Set value Ts (Note 1)	Supply voltage	Ambient temperature	
(1) Fluctuation in operation time	$\pm \frac{1}{2} \times \frac{T_{max.} - T_{min.}}{TMs} \times 100 (\%)$	Full-scale value	Rated voltage	20±2°C 68±36°F (Note 2)	
(2) Voltage error	$\frac{TMx_1 - TM}{TMs} \times 100 (\%)$		Fluctuation range of allowable voltage of power supply (Note 3)		
(3) Temperature error	$\frac{TMx_2 - TM}{TMs} \times 100 (\%)$		Rated voltage	-10 to 50°C +14 to 122°F (Note 4)	
(4) Set error	$\frac{TM - Ts}{TMs} \times 100 (\%)$			1/3 or more of full-scale value	20±2°C 68±36°F (Note 2)
(5) Pause time error	$\frac{TMx_3 - TM}{TMs} \times 100 (\%)$			Full-scale value	

Note 1: For digital timers, the set value Ts shall be optional.

Note 2: If no question arises from evaluation results, 13-35°C is acceptable.

Note 3: The measurement may be performed in other specified voltage ranges.

Note 4: The measurement may be performed in other specified temperature ranges.

TM: Average of measured values for operation time

Ts: Set value

TMs: Full-scale value. For digital timers, any arbitrary scale-value may be used.

Tmax: Maximum of measured values for operation time

Tmin: Minimum of measured values for operation time

TMx<sub>1</sub>: Average of operation time at such voltage as maximizes deviation from TM in allowable voltage range.

TMx<sub>2</sub>: Average of operation time at such temperature as maximizes deviation from TM in allowable temperature range.

TMx<sub>3</sub>: Average of operation time at such pause time (in the range from the specified reset time to 1 hour) as maximizes deviation from TM.

## • Functional Vibration Resistance

Means such a vibration as occurs in the range where the contact closed with that vibration during the use of the timer remains closed for the specified time (3 or 1 msec.) minimum.

## • Destructive Vibration Resistance

Means such a vibration as occurs in the range where no part is damage with that vibration during the transportation or use of the timer and the operation characteristics are maintained.

## • Functional Shock Resistance

Means such a shock as occurs in the range where the contact closed with that shock during the use of the timer remains closed for the specified time (1 ms) minimum.

## • Destructive Shock Resistance

Means such a shock as occurs in the range where no part is damaged with that shock during the transportation or use of the timer and the operation characteristics are maintained.

## • Mechanical life

Means the durability that is achieved when the control output is performed in the no-load state.

## • Electrical life

Means the durability that is achieved when the specified voltage and current loads are individually applied to the control output while being turned ON and OFF. Generally, the life of the timer is represented by the number of times the control output is performed. When a load is connected to the control output, the term of „electrical life“ is used. When no load is connected to the control output, the term of „mechanical life“ is used. The electrical life is shorter than the mechanical life, and becomes longer as the load decreases. The life of the timer is made longer by connecting a relay or a similar part rather than directly switching a large load with the control output.

## • Rated power consumption

Means the power that is consumed when the rated operation voltage is applied to the power circuit.

(Rated power consumption = rated voltage × current consumption)

## • Rated control capacity

Means the reference value that is used to determine the performance of the switching part of the load. This value is represented by the combination of voltage and current.

## • Contact resistance

Means the combined resistance that consists of the contact resistance between contacts, and the conductor resistance of pins and contact springs.

## • Insulation resistance

Means the resistance between a contact or a conductive pin like the pin to which the operation voltage is applied, and a dead pin or a non-conductive metallic part like the time case, the base, or a retaining screw; or the resistance between contacts.

## • Withstand voltage

Means the limit value that does not cause breakdown when high voltage is applied for one minute to the same location as measured for insulation resistance. The detectable leak current is normally 10 mA. In special cases, however, it may be 1mA or 3 mA.

## • Withstand surge voltage

Means the limit value that shows the durability against momentary abnormal voltage resulting from lightning or switching a conductive load. The surge waveform is represented by the standard impulsive voltage waveform at ±(1.2x50) μs or ±(1x40) μs.

# ON-DELAY TIMER BASIC CIRCUIT

(Symbols)

	Self-resetting switch		Relay NO contact
	Holding switch		Relay NC contact
	Relay		Timer delay NO contact
	Timer		Timer delay NC contact
	Load		Timer instantaneous NO contact
	Timer in work		Timer instantaneous NC contact

## 1. Delay Operation (Instantaneous input)

When control switch A is pressed, timer T starts immediately and after t-time elapses, load L is turned ON. When B is pressed, timer T is reset and load L is turned OFF.

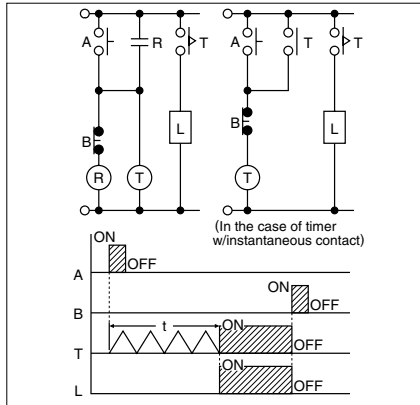

## 2. Delay Operation (Continuous input)

When switch A is pressed, after t-time elapsed, the timer contact closes and load L is turned ON. When switch A is opened, the timer is reset and the load is turned OFF.

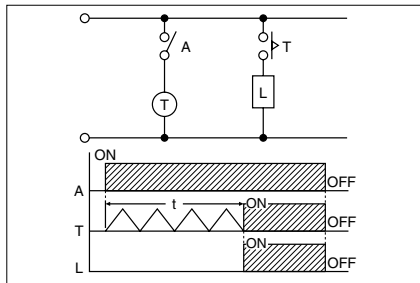

## 3. Fixed Time Operation (Instantaneous input)

When control switch A is pressed, load L is immediately turned ON, and after t-time elapses, load L is turned OFF.

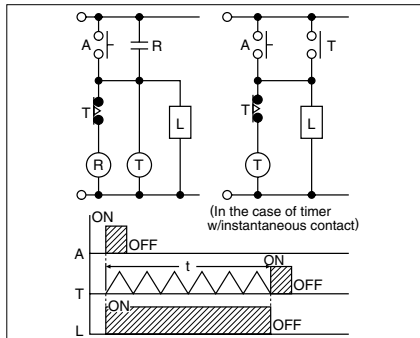

## 4. Fixed Time Operation (Continuous input)

When switch A is closed, load L is turned ON and after t-time elapses, the load is turned OFF. When switch A is opened, timer T is reset and load L is turned OFF.

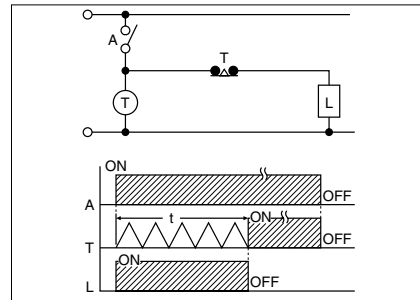

## 5. Delay Reset Operation

When contact A is reversed, load L is immediately turned ON. When contact A is returned to normal state, load L is turned OFF after t-time elapses.

This circuit is used when the power supply is kept ON at all times or used for off-delay-like application.

However, it can not be used as off-delay timer at the time of power failure.

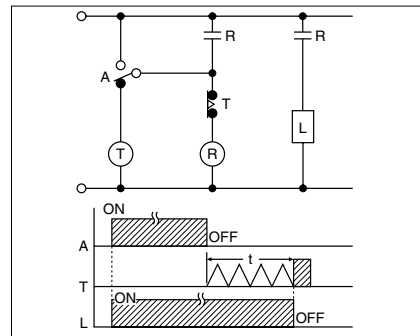

## 6. Fixed Time Operation after Delay Time is Set (Instantaneous input)

When control switch A is pressed, load L is turned ON after t1-time elapses, and load L is turned OFF after t2-time elapses. This circuit is used for the case of instantaneous input (one pulse).

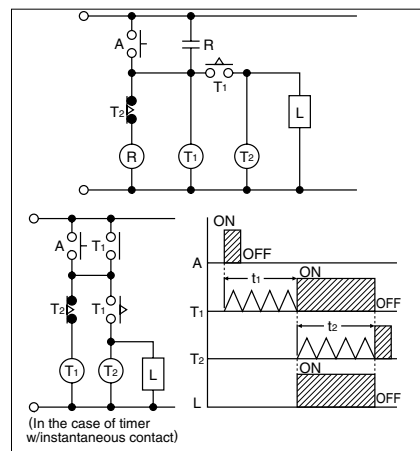

## 7. Fixed Time Operation after Delay Time is Set (Continuous input)

When switch A is pressed, load L is turned ON after t1-time elapses and load L is turned OFF after t2-time elapses.

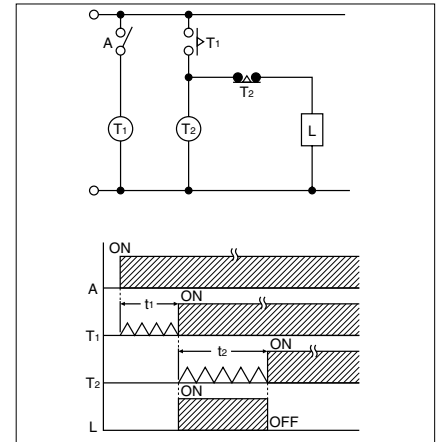

## 8. Repetitive Operation

When switch A is pressed, load L is turned ON after t1-time elapses and load L is turned OFF after t2-time elapses, and thereafter the t1 and t2 operations are repeated. This repetitive operation stops when switch A is turned OFF.

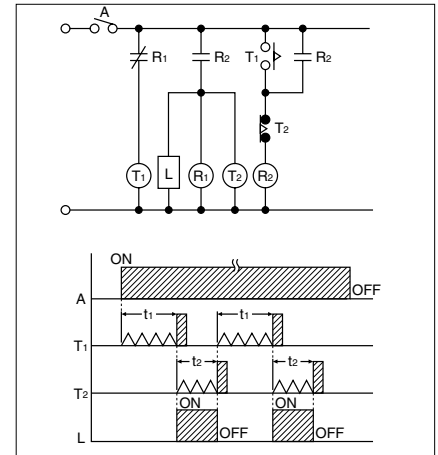

# GENERAL APPLICATION GUIDELINES

## Cautions for circuits

### 1. Protective circuit for timer contact

In the circuit that switches an inductive load, a contact failure may occur at a contact point due to surge or inrush current resulting from that switching. Therefore, it is recommended that the following protective circuit be used to protect the contact point.

Circuit	CR circuit (r: resistor c: capacitor)		Diode circuit	Varistor circuit
Application	AC DC	(see note.) Available	Available Available	Not available Available
Features/Notes	<p>If the load is a relay or solenoid, the release time lengthens. Effective when connected to both contacts if the power supply voltage is 24 or 48 V and the voltage across the load is 100 to 200 V.</p> <p>If the load is a timer, leakage current flows through the CR circuit causing faulty operation. Note: If used with AC voltage, be sure the impedance of the load is sufficiently smaller than that of the c and r.</p>		<p>The diode connected in parallel causes the energy stored in the coil to flow to the coil in the form of current and dissipates it as joule heat at the resistance component of the inductive load. This circuit further delays the release time compared to the CR circuit. (2 to 5 times the release time listed in the catalog)</p>	<p>Using the rated voltage characteristics of the varistor, this circuit prevents excessively high voltages from being applied across the contacts. This circuit also slightly delays the release time.</p>
Device Selection	<p>As a guide in selecting r and c, c: 0.5 to 1 <math>\mu</math>F per 1 A contact current r: 0.5 to 1 <math>\Omega</math> per 1 V contact voltage Values vary depending on the properties of the load and variations in timer characteristics. Capacitor c acts to suppress the discharge the moment the contacts open. Resistor r acts to limit the current when the power is turned on the next time. Test to confirm. Use a capacitor with a breakdown voltage of 200 to 300 V. Use AC type capacitors (non-polarized) for AC circuits.</p>		<p>Use a diode with a reverse breakdown voltage at least 10 times the circuit voltage and a forward current at least as large as the load current. In electronic circuits where the circuit voltages reverse breakdown voltage of about 2 to 3 times the power supply voltage.</p>	—

### 2. Type of Load and Inrush Current

The type of load and its inrush current characteristics, together with the switching frequency are important factors which cause contact welding. Particularly for loads with inrush currents, measure the steady state current and inrush current and use a relay or magnet switch which provides an ample margin of safety. The table below shows the relationship between typical loads and their inrush currents.

Type of load	Inrush current
Resistive load	Steady state current
Solenoid load	10 to 20 times the steady state current
Motor load	5 to 10 times the steady state current
Incandescent lamp load	10 to 15 times the steady state current
Mercury lamp load	1 to 3 times the steady state current
Sodium vapor lamp load	1 to 3 times the steady state current
Capacitive load	20 to 40 times the steady state current
Transformer load	5 to 15 times the steady state current

When you want large load and long life of the timer, do not control the load direct with a timer. When the timer is designed to use a relay or a magnet switch, you can acquire the longer life of the timer.

### 3. Connection of input

The PM4H and LT4H series use power supply without a transformer (power and input terminals are not insulated). In connecting various kinds of input signals, therefore, use a power transformer in which the primary side is separated from the ungrounded secondary side as shown in Fig. A, for the power supply for a sensor and other input devices so that short-circuiting can be prevented.

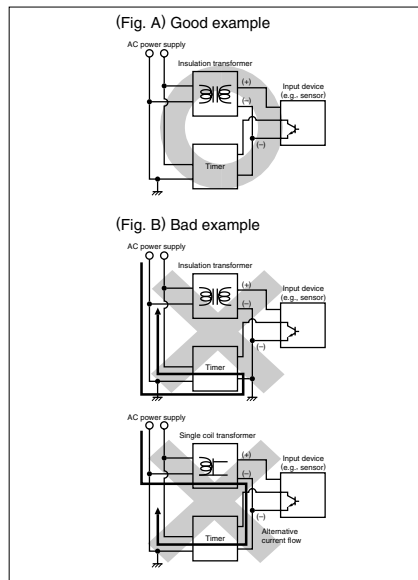

Do not use a single coil transformer (e.g., Sly-Duck). Otherwise, the internal circuit of the timer will be short-circuited as shown in Fig. B resulting in breakdown.

### 4. Long Continuous Current Flow

Long continuous current flow through the timer (approx. one month or longer) cause generation of heat internally, which degrade the electronic parts. Use the timer in combination with a relay and avoid long continuous current flow through the timer.

### (1) When using contact output

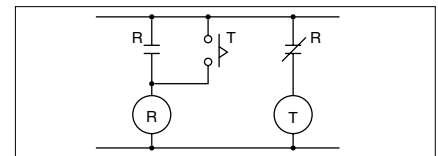

### (2) When using non-contact output

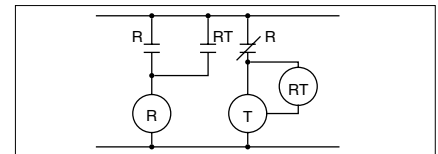

### 5. Leakage current

1) For connecting and disconnecting operating voltage to the timer, a circuit should be used, which will prevent the flow of leakage current. For example, a circuit for contact protection as shown in Fig. A. will permit leakage current flow through R and C, causing erroneous operation of the timer. Instead, the circuit shown in Fig. B should be used.

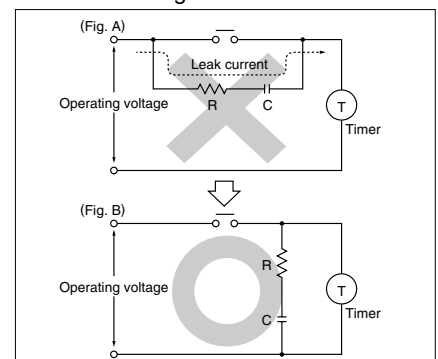

# GENERAL APPLICATION GUIDELINES

2) If the timer is directly switched with a non-contact element, leak current may flow into the timer and cause it to malfunction.

## 6. Power off time

If the operation voltage for the timer is turned ON after the limit time operation is completed or before the limit time is reached, the Power off time longer than the timer restoration time must be secured.

## 7. Suicide circuit

If the timer is restored immediately after the specified time is reached, the circuit must be configured so that the restoration time of the timer can be secured sufficiently.

If the power circuit for the timer is turned OFF with the timer contact, a suicide

circuit may be configured (Fig. A). In order to settle the problem with this potential suicide circuit, the circuit must be designed so that the timer is turned OFF after the self-retention circuit is completely released (Fig. B).

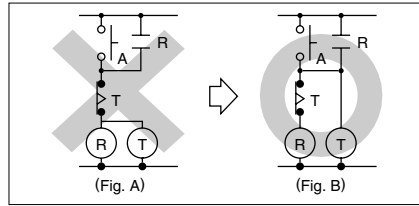

## 8. Electrical life

The electrical life varies depending on the load type, the switching phase, and the ambient atmosphere. In particular,

the following cases require careful attention:

(1) If an AC load is switched in synchronized phases:

Locking or welding is liable to occur due to contact transposition. Check this with the actual system.

(2) If a load is switched very frequently: If a load which generates arcs when a contact is switched is turned ON and OFF very frequently, nitrogen and oxygen in air are combined due to arc energy and then  $\text{HNO}_3$  is produced. This may corrode metallic materials.

The effective countermeasures include:

1. Using an arc-extinguishing circuit;
2. Decreasing the switching frequency; and
3. Decreasing the humidity in the ambient atmosphere.

## Cautions for use (common for all models)

### 1. Pin connections

Correctly connect the pins while seeing the terminal layout/wiring diagram. In particular, the DC type, which has polarities, does not operate with the polarities connected reverse. Any incorrect connection can cause abnormal heating or ignition.

### 2. Connection to operation power supply

1) Supply voltage must be applied at a time through a switch, a relay, and other parts. If the voltage is applied gradually, the specified time may be reached regardless of its value or the power supply may not be reset.

2) The operation voltage for the DC type must be at the specified ripple percentage or less. The average voltage must fall within the allowable operation voltage range.

Rectification type	Ripple percentage
Single-phase, full-wave	Approx. 48%
Three-phase, full-wave	Approx. 4%
Three-phase, half-wave	Approx. 17%

Note: Refer to the ripple percentage of each timer.

3) Make sure that no induced voltage and residual voltage are applied between the power pins on the timer after the power switch is turned OFF.

(If the power line is wired in parallel with the high-voltage and motor lines, induced voltage may be produced between the power pins.)

### 3. Control output

1) The load for the control output must be used within the load capacity specified in the rated control capacity. If it is used exceeding the rated value, the life is greatly shortened.

2) The following connection might result in short circuit between the heteropolar contacts in the timer.

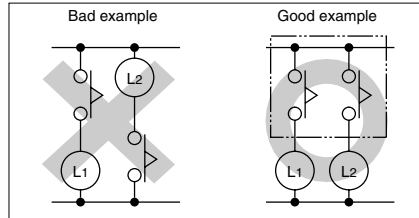

### 4. Installing the timer

1) To install the timer, use the dedicated pin bracket or socket (cap). Avoid connecting the pins on the timer by directly soldering them.

2) In order to maintain the characteristics, do not remove the timer cover (case).

### 5. Superimposed surge of power supply

For the superimposed surge of power supply, the standard waveform ( $\pm 1.2 \times 50 \mu\text{s}$  or  $\pm 1 \times 40 \mu\text{s}$ ) is taken as the standard value for surge-proof voltage. (The positive and negative voltages are applied each three or five times between the power pins.)

For the standard values for the PM4H, LT4H and S1DX type timers, see the respective items in „Cautions for use.“

#### • Single-pole, full-wave voltage for surge waveform [ $\pm(1.2 \times 50) \mu\text{s}$ ]

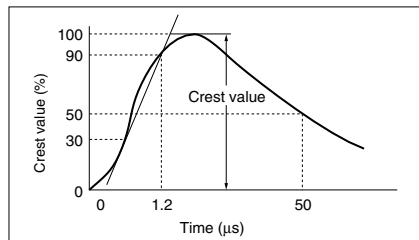

#### • Single-pole, full-wave voltage for surge waveform [ $\pm(1 \times 40) \mu\text{s}$ ]

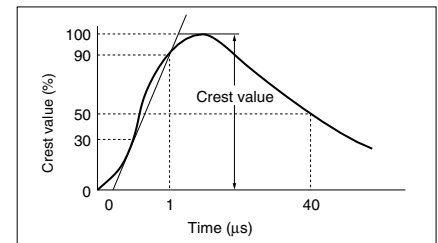

#### • PMH [ $\pm(1 \times 40) \mu\text{s}$ ]

Voltage type	Surge voltage
AC type (Except for 24V AC)	4,000V
12V DC, 24V DC, 24V AC	500V
48V DC	1,000V
100 to 110V DC	2,000V

If external surge occurs exceeding the specified value, the internal circuit may break down. In this case, use a surge absorption element. The typical surge absorption elements include a varistor, a capacitor, and a diode. If a surge absorption element is used, use an oscilloscope to see whether or not the foreign surge exceeding the specified value appears.

### 6. Changing the set time

Do not change the set time when the limit time operation is in progress. However, this is possible only with the motor-driven type timer if the set time is shorter than the remaining time. For changing the set time on the digital timer (LT4H series), see the relevant item in „Cautions for use.“

# GENERAL APPLICATION GUIDELINES

## 7. Operating environment

1) Use the timer within the ambient temperature range from  $-10^{\circ}\text{C}$  to  $+50^{\circ}\text{C}$  ( $+14^{\circ}\text{F}$  to  $+122^{\circ}\text{F}$  ( $+55^{\circ}\text{C}$   $+131^{\circ}\text{F}$  for the LT4H series) and at ambient humidity of 85% RH maximum.

2) Avoid using the timer in a location where inflammable or corrosive gas is generated, the timer is exposed to much dust and other foreign matter water or oil is splashed on the timer or vibrations or shocks are given to the timer.

3) The timer cover (case), the knobs, and the dials are made of polycarbonated resin. Therefore, prevent the timer from being exposed to organic solvents such as methyl alcohol, benzine, and thinner, strong acid substances such as caustic

soda, and ammonia and avoid using the timer in atmosphere containing any of those substances.

4) If the timer is used where noises are emitted frequently, separate the input signal elements (such as a sensor), the wiring for the input signal line, and the timer as far as possible from the noise source and the high power line containing noises.

## 8. Checking the actual load

In order to increase the reliability in the actual use, check the quality of the timer in the actual usage.

## 9. Others

1) If the timer is used exceeding the ratings (operation voltage and control capacity), the contact life, or any other

specified limit, abnormal heat, smoke, or ignition may occur.

2) If any malfunction of the timer is likely to affect human life and properties, give allowance to the rated values and performance values. In addition, take appropriate safety measures such as a duplex circuit from the viewpoint of product liabilities.

**Panasonic**  
ideas for life

**DIN 48 SIZE  
DIGITAL TIMER**

**LT4H**

UL File No.: E122222  
C-UL File No.: E122222

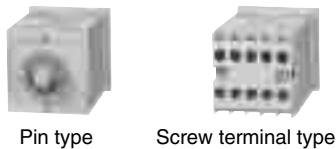
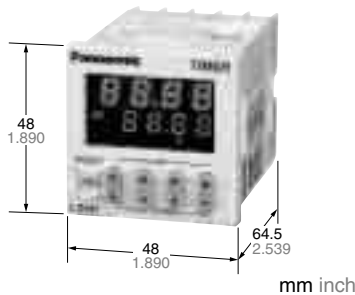

## Features

- Bright and Easy-to-Read Display**  
 A brand new bright 2-color back light LCD display. The easy-to-read screen in any location makes checking and setting procedures a cinch.
- Simple Operation**  
 Seesaw buttons make operating the unit even easier than before.
- Short Body of only 64.5 mm 2.539 inch (screw terminal type) or 70.1 mm 2.760 inch (pin type)**  
 With a short body, it is easy to install in even narrow control panels.
- Conforms to IP66's Weather Resistant Standards**  
 The water-proof panel keeps out water and dirt for reliable operation even in poor environments.

- Screw terminal (M3.5) and Pin Types are Both Standard Options**  
 The two terminal types are standard options to support either front panel installation or embedded installation.
- Changeable Panel Cover**  
 Also offers a black panel cover to meet your design considerations.
- Compliant with UL, c-UL and CE.**

## Product types

Time range	Operating mode	Output	Operating voltage	Power down insurance	Terminal type	Part number		
9.999 s (0.001 s~) 99.99 s (0.01 s~) 999.9 s (0.1 s~) 9999 s (1 s~) 99 min 59 s (1 s~) 999.9 min (0.1 min~) 99 h 59 min (1 min~) 999.9 h (0.1 h~)	Power ON delay (1) Power ON delay (2) Signal ON delay Signal OFF delay Pulse One-shot Pulse ON-delay Signal Flicker Totalizing ON-delay (8 modes)	Relay (1 c)	100 to 240 V AC	Available	8 pins	LT4H8-AC240V		
						11 pins	LT4H-AC240V	
						Screw terminal	LT4H-AC240VS	
						24 V AC	8 pins	LT4H8-AC24V
							11 pins	LT4H-AC24V
						Screw terminal	LT4H-AC24VS	
					12 to 24 V DC	8 pins	LT4H8-DC24V	
						11 pins	LT4H-DC24V	
					Screw terminal	LT4H-DC24VS		
					Transistor (1 a)	100 to 240 V AC	8 pins	LT4HT8-AC240V
							11 pins	LT4HT-AC240V
						Screw terminal	LT4HT-AC240VS	
		24 V AC	8 pins	LT4HT8-AC24V				
			11 pins	LT4HT-AC24V				
		Screw terminal	LT4HT-AC24VS					
		12 to 24 V DC	8 pins	LT4HT8-DC24V				
			11 pins	LT4HT-DC24V				
			Screw terminal	LT4HT-DC24VS				

\* A rubber gasket (ATC18002) and a mounting frame (AT8-DA4) are included.

## Part names

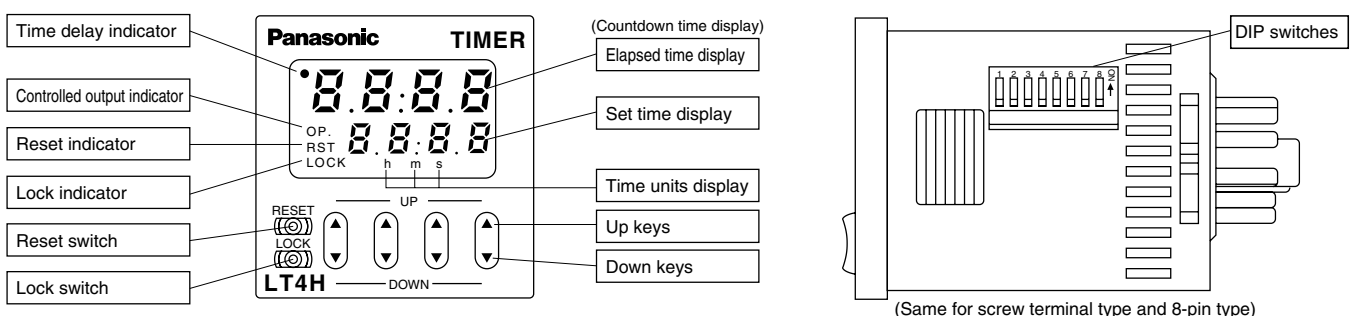

## Specifications

Item		Type	Relay output type		Transistor output type	
			AC type AC/DC type	DC type	AC type AC/DC type	DC type
Rating	Rated operating voltage		100 to 240 V AC, 24 V AC, 24 V AC/DC	12 to 24 V DC	100 to 240 V AC, 24 V AC, 24 V AC/DC	12 to 24 V DC
	Rated frequency		50/60 Hz common	—	50/60 Hz common	—
	Rated power consumption		Max. 10 V A	Max. 3 W	Max. 10 V A	Max. 3 W
	Rated control capacity		5 A, 250 V AC (resistive load)		100 mA, 30 V DC	
	Time range		9.999 s, 99.99 s, 999.9 s, 9999 s, 99 min 59 s, 999.9 min, 99 h 59 min, 999.9 h (selected by DIP switch)			
	Time counting direction		Addition (UP)/Subtraction (DOWN) (2 directions selectable by DIP switch)			
	Operation mode		A (Power ON delay 1), A2 (Power ON delay 2), B (Signal ON delay), C (Signal OFF delay), D (Pulse one-shot), E (Pulse ON delay), F (Signal Flicker), G (Totalizing ON delay) (selectable by DIP switch)			
	Start/Reset/Stop input		Min. input signal width: 1 ms, 20 ms (2 directions by selected by DIP switch) (The 8-pin type does not have a stop input.)			
	Lock input		Min. input signal width: 20 ms (The 8-pin type does not have a lock input.)			
	Input signal		Open collector input Input impedance: Max. 1 kΩ; Residual voltage: Max. 2 V Open impedance: 100kΩ or less, Max. energized voltage: 40V DC			
	Indication		7-segment LCD (LT4H, LT4H-L common), Elapsed value (backlight red LED), Setting value (backlight yellow LED)			
Power failure memory method		EEP-ROM (Min. 10 <sup>5</sup> overwriting)				
Time accuracy (max.)	Operating time fluctuation		± (0.005 % + 50 ms) in case of power on start		[ Operating voltage: 85 to 110% Temperature: -10 to +55°C +14 to +131°F Min. input signal width: 1ms ]	
	Temperature error		± (0.005 % + 20 ms) in case of input signal start			
	Voltage error					
	Setting error					
Contact	Contact arrangement		Timed-out 1 Form C		Timed-out 1 Form A (Open collector)	
	Contact resistance (Initial value)		100 mΩ (at 1 A 6 V DC)		—	
	Contact material		Ag alloy/Au flash		—	
Life	Mechanical (contact)		Min. 2x10 <sup>6</sup> ope. (Except for switch operation parts)		—	
	Electrical (contact)		1.0x10 <sup>6</sup> ope. (At rated control voltage)		Min. 10 <sup>6</sup> ope. (At rated control voltage)	
Electrical	Allowable operating voltage range		85 to 110 % of rated operating voltage			
	Breakdown voltage (Initial value)		2,000 Vrms for 1 min: Between live and dead metal parts (11-pin) 2,000 Vrms for 1 min: Between input and output 1,000 Vrms for 1 min: Between contacts		2,000 Vrms for 1 min: Between live and dead metal parts (Pin type) 2,000 Vrms for 1 min: Between input and output	
	Insulation resistance (Initial value)		Min. 100 MΩ: Between live and dead metal parts Between input and output (At 500V DC) Between contacts		Min. 100 MΩ: Between live and dead metal parts Between input and output (At 500V DC)	
	Operating voltage reset time		Max. 0.5 s			
	Temperature rise		Max. 65° C (under the flow of nominal operating current at nominal voltage)		—	
Mechanical	Vibration resistance	Functional	10 to 55 Hz: 1 cycle/min single amplitude of 0.35 mm .014 inch (10 min on 3 axes)			
		Destructive	10 to 55 Hz: 1 cycle/min single amplitude of 0.75 mm .030 inch (1 h on 3 axes)			
	Shock resistance	Functional	Min. 98 m 321.522 ft./s <sup>2</sup> (4 times on 3 axes)			
		Destructive	Min. 294 m 964.567 ft./s <sup>2</sup> (5 times on 3 axes)			
Operating conditions	Ambient temperature		-10° C to 55° C +14° F to +131° F			
	Ambient humidity		Max. 85 % RH (non-condensing)			
	Air pressure		860 to 1,060 h Pa			
	Ripple rate		—	20 % or less	—	20 % or less
Connection		8-pin/11-pin/screw terminal				
Protective construction		IP66 (front panel with rubber gasket)				

## Applicable standard

Safety standard	EN61812-1	Pollution Degree 2/Overvoltage Category II
EMC	(EM)EN61000-6-4	EN55011 Group1 ClassA
	Radiation interference electric field strength	EN55011 Group1 ClassA
	Noise terminal voltage	
	(EMS)EN61000-6-2	EN61000-4-2 4 kV contact 8 kV air
	Static discharge immunity	EN61000-4-3 10 V/m AM modulation (80 MHz to 1 GHz) 10 V/m pulse modulation (895 MHz to 905 MHz)
	RF electromagnetic field immunity	EN61000-4-4 2 kV (power supply line) 1 kV (signal line)
	EFT/B immunity	EN61000-4-5 1 kV (power line)
	Surge immunity	EN61000-4-6 10 V/m AM modulation (0.15 MHz to 80 MHz)
	Conductivity noise immunity	EN61000-4-8 30 A/m (50 Hz)
	Power frequency magnetic field immunity	EN61000-4-11 10 ms, 30% (rated voltage) 100 ms, 60% (rated voltage) 1,000 ms, 60% (rated voltage) 5,000 ms, 95% (rated voltage)
Voltage dip/Instantaneous stop/Voltage fluctuation immunity		

# LT4H

## Dimensions

### • LT4H digital timer

(units: mm inch)  
Tolerance:  $\pm 1.0 \pm .039$

#### Screw terminal type (Flush mount)

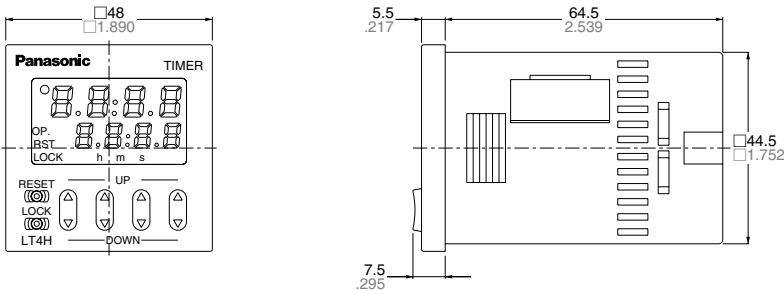

#### Pin type (Flush mount/Surface mount)

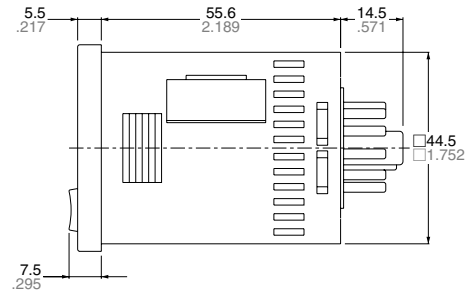

### • Dimensions for embedded installation (with adapter installed)

#### Screw terminal type

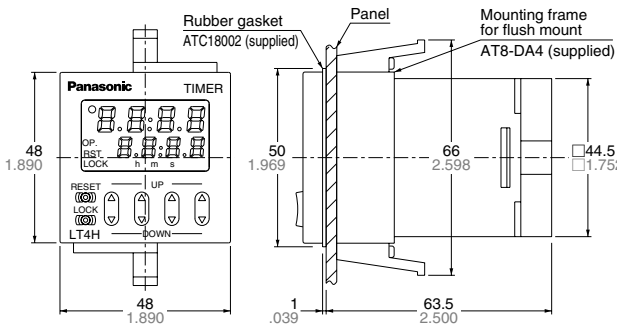

#### Pin type

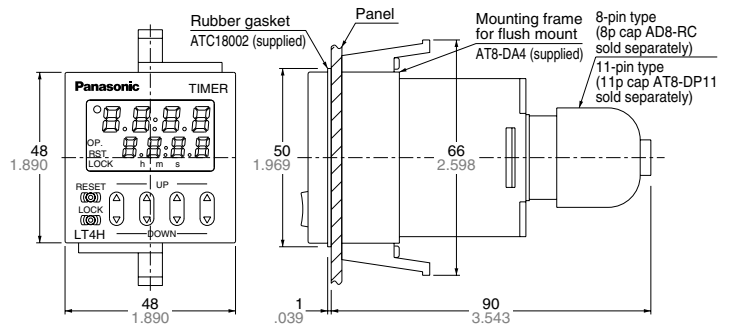

### • Dimensions for front panel installations

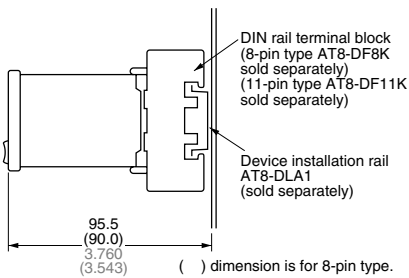

### • Installation panel cut-out dimensions

The standard panel cut-out dimensions are shown below. Use the mounting frame (AT8-DA4) and rubber gasket (ATC18002).

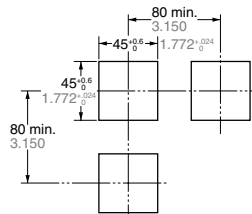

### • For connected installations

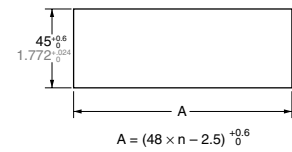

Note) 1: The installation panel thickness should be between 1 and 5 mm (.039 and .197 inch).  
2: For connected installations, the waterproofing ability between the unit and installation panel is lost.

## Terminal layouts and wiring diagrams

### • 8-pin type

#### Relay output type

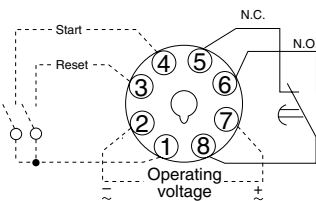

#### Transistor output type

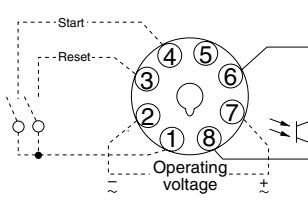

### • 11-pin type

#### Relay output type

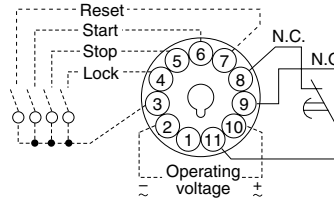

#### Transistor output type

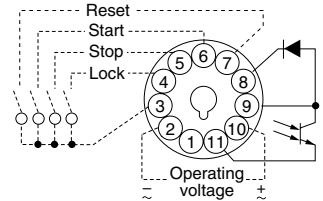

### • Screw terminal type

#### Relay output type

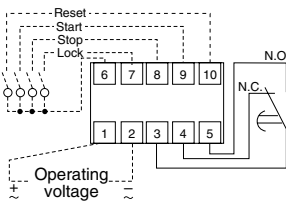

#### Transistor output type

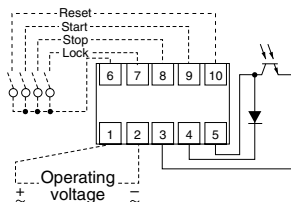

Note) For connecting the output leads of the transistor output type, refer to 5) Transistor output on page 26.



## Setting the operation mode, time range and time

### Setting procedure 1) Setting the operation mode and time range

Set the operation mode and time range with the DIP switches on the side of the LT4H timer.

#### DIP switches

Item	DIP switch		
	OFF	ON	
1	Refer to table 1		
2			
3			
*4	Minimum input reset, start, and stop signal width	20 ms	1 ms
5	Time delay direction	Addition	Subtraction
6	Refer to table 2		
7			
8			

\* The 8-pin type does not have the stop input, so that the dip switch can be changed over between reset and start inputs. The signal range of the lock input is fixed (minimum 20 ms).

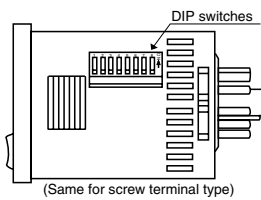

Table 1: Setting the operation mode

DIP switch No.			Operation mode
1	2	3	
ON	ON	ON	A: Power on delay 1
OFF	OFF	OFF	A2: Power on delay 2
ON	OFF	OFF	B: Signal on delay
OFF	ON	OFF	C: Signal off delay
ON	ON	OFF	D: Pulse One shot
OFF	OFF	ON	E: Pulse On delay
ON	OFF	ON	F: Signal Flicker
OFF	ON	ON	G: Totalizing On delay

Table 2: Setting the time range

DIP switch No.			Time range
6	7	8	
ON	ON	ON	0.001 s to 9.999 s
OFF	OFF	OFF	0.01 s to 99.99 s
ON	OFF	OFF	0.1 s to 999.9 s
OFF	ON	OFF	1 s to 9999 s
ON	ON	OFF	0 min 01 s to 99 min 59 s
OFF	OFF	ON	0.1 min to 999.9 min
ON	OFF	ON	0 h 01 min to 99 h 59 min
OFF	ON	ON	0.1 h to 999.9 h

Notes: 1) Set the DIP switches before installing the timer.  
2) When the DIP SW setting is changed, turn off the power once.  
3) The DIP switches are set as ON before shipping.

### Setting procedure 2) Setting the time

Set the set time with the keys (UP and DOWN keys) on the front of the LT4H timer.

#### Front display section

- ① Elapsed time display
- ② Set time display
- ③ Time delay indicator
- ④ Controlled output indicator
- ⑤ Reset indicator
- ⑥ Lock indicator
- ⑦ Time units display

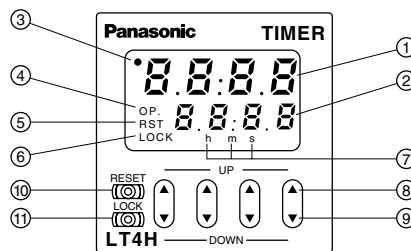

- ⑧ UP keys  
Changes the corresponding digit of the set time in the addition direction (upwards)
- ⑨ DOWN keys  
Changes the corresponding digit of the set time in the subtraction direction (downwards)
- ⑩ RESET switch  
Resets the elapsed time and the output
- ⑪ LOCK switch  
Locks the operation of all keys on the unit

#### • Changing the set time

**1. It is possible to change the set time with the up and down keys even during time delay with the timer. However, be aware of the following points.**

1) If the set time is changed to less than the elapsed time with the time delay set to the addition direction, time delay will continue until the elapsed time reaches full scale, returns to zero, and then reaches the new set time. If the set time

is changed to a time above the elapsed time, the time delay will continue until the elapsed time reaches the new set time.  
2) If the time delay is set to the subtraction direction, time delay will continue until "0" regardless of the new set time.  
**2. If the set time is changed to "0," the unit will operate differently depending on the operation mode.**

1) If the operation mode is set to A (power on delay 1) or A2 (power on

delay 2), the output will turn on when the power supply is turned on. However, the output will be off while reset is being input.

2) In the other modes, the output turns on when the start is input. When the operation mode is C (signal off delay), D (Pulse one shot), or F (Signal flicker), only when the start input is on does the output turn on. Also, when the reset is being input, the output is off.

#### • Power failure memory

**The EEPROM is used for power failure memory. It has a life of Min. 10<sup>5</sup> over-writings. The EEPROM is overwriting with the following timing.**

Output mode	Overwrite timing
Power ON delay (2) A2	When power is OFF
Addition G	Change of preset value or start, reset input When power is OFF after being ON
Other modes	When power is OFF after changing preset value

\* Be aware that the contents of EEPROM for all modes will be overwritten when power is turned OFF during input to external lock terminals ④ to ③ and ⑦ to ⑥. Such an action does not exist by doing lock operation from the front.

## Operation mode

T: Set time t<sub>1</sub>, t<sub>2</sub>, t<sub>3</sub>, t<sub>a</sub><T

Operation type	Explanation	Time chart						
Power on delay (1) (A)	<ul style="list-style-type: none"> <li>Set the operation mode section of the DIP switches (no.'s 1, 2, and 3) on the side of the timer as shown.                             <table border="1" style="margin-left: 20px;"> <tr> <td>1</td> <td>2</td> <td>3</td> </tr> <tr> <td>ON</td> <td>ON</td> <td>ON</td> </tr> </table> </li> <li>Clears elapsed time value and starts time delay at power ON.</li> <li>After timer completion, stops at the display of the set value (addition), or stops at "0" (subtraction).</li> <li>Ignores start input.</li> <li>Stops delay time operation at stop ON. Restarts delay time operation at stop OFF.</li> </ul>	1	2	3	ON	ON	ON	
1	2	3						
ON	ON	ON						
Power on delay (2) (A2)	<ul style="list-style-type: none"> <li>Set the operation mode section of the DIP switches (no.'s 1, 2, and 3) on the side of the timer as shown.                             <table border="1" style="margin-left: 20px;"> <tr> <td>1</td> <td>2</td> <td>3</td> </tr> <tr> <td>OFF</td> <td>OFF</td> <td>OFF</td> </tr> </table> </li> <li>Elapsed time value does not clear at power ON. (power outage countermeasure function)</li> <li>The output remains ON even after the power is cut and restarted.</li> <li>After timer completion, stops at the display of the set value (addition), or stops at "0" (subtraction).</li> <li>Ignores start input.</li> <li>Stops delay time operation at stop ON. Restarts delay time operation at stop OFF.</li> </ul>	1	2	3	OFF	OFF	OFF	
1	2	3						
OFF	OFF	OFF						
Signal on delay (B)	<ul style="list-style-type: none"> <li>Set the operation mode section of the DIP switches (no.'s 1, 2, and 3) on the side of the timer as shown.                             <table border="1" style="margin-left: 20px;"> <tr> <td>1</td> <td>2</td> <td>3</td> </tr> <tr> <td>ON</td> <td>OFF</td> <td>OFF</td> </tr> </table> </li> <li>Clears elapsed time value at power ON.</li> <li>Time delay starts at start ON and elapsed time value or output resets at start OFF.</li> <li>Instantaneous time delay start at reset OFF and power ON while start is ON.</li> <li>Stops delay time operation at stop ON. Restarts delay time operation at stop OFF.</li> <li>In order to have the time delay start at power ON or reset at power OFF, short out the start input beforehand.</li> </ul>	1	2	3	ON	OFF	OFF	
1	2	3						
ON	OFF	OFF						
Signal off delay (C)	<ul style="list-style-type: none"> <li>Set the operation mode section of the DIP switches (no.'s 1, 2, and 3) on the side of the timer as shown.                             <table border="1" style="margin-left: 20px;"> <tr> <td>1</td> <td>2</td> <td>3</td> </tr> <tr> <td>OFF</td> <td>ON</td> <td>OFF</td> </tr> </table> </li> <li>Clears elapsed time value at power ON.</li> <li>Output control ON at start ON and time delay start at start OFF.</li> <li>Elapsed time value clears when start goes ON again during time delay.</li> <li>Stops delay time operation at stop ON. Restarts delay time operation at stop OFF.</li> </ul>	1	2	3	OFF	ON	OFF	
1	2	3						
OFF	ON	OFF						

Notes: 1) Each signal input (start, reset, stop, and lock) is applied by shorting their input terminal to the common terminal (terminal ① for the 8-pin type, terminal ③ for the 11-pin type, and terminal for the screw terminal type).  
 2) The 8-pin type does not have a stop input or lock input.

Operation type	Explanation	Time chart						
Pulse One-shot (D)	<ul style="list-style-type: none"> <li>Set the operation mode section of the DIP switches (no.'s 1, 2, and 3) on the side of the timer as shown.                             <table border="1" style="margin-left: 20px;"> <tr> <td>1</td> <td>2</td> <td>3</td> </tr> <tr> <td>ON</td> <td>ON</td> <td>OFF</td> </tr> </table> </li> <li>Clears elapsed time value at power ON.</li> <li>Time delay starts and output control ON at start ON.</li> <li>Turns output control OFF and clears elapsed time value at time-up.</li> <li>Ignores start input during time delay.</li> <li>Stops delay time operation at stop ON. Restarts delay time operation at stop OFF.</li> <li>In order to have the time delay start at power ON or reset at power OFF, short out the start input beforehand.</li> </ul>	1	2	3	ON	ON	OFF	
1	2	3						
ON	ON	OFF						
Pulse On delay (E)	<ul style="list-style-type: none"> <li>Set the operation mode section of the DIP switches (no.'s 1, 2, and 3) on the side of the timer as shown.                             <table border="1" style="margin-left: 20px;"> <tr> <td>1</td> <td>2</td> <td>3</td> </tr> <tr> <td>OFF</td> <td>OFF</td> <td>ON</td> </tr> </table> </li> <li>Clears elapsed time value at power ON.</li> <li>Time delay starts at start ON.</li> <li>Ignores start input during time delay.</li> <li>Stops delay time operation at stop ON. Restarts delay time operation at stop OFF.</li> <li>In order to have the time delay start at power ON or reset at power OFF, short out the start input beforehand.</li> </ul>	1	2	3	OFF	OFF	ON	
1	2	3						
OFF	OFF	ON						
Signal Flicker (F)	<ul style="list-style-type: none"> <li>Set the operation mode section of the DIP switches (no.'s 1, 2, and 3) on the side of the timer as shown.                             <table border="1" style="margin-left: 20px;"> <tr> <td>1</td> <td>2</td> <td>3</td> </tr> <tr> <td>ON</td> <td>OFF</td> <td>ON</td> </tr> </table> </li> <li>Clears elapsed time value at power ON.</li> <li>Time delay starts at start ON.</li> <li>Ignores start input during time delay.</li> <li>Output control reverses, elapsed time value clears, and timer delay starts at timer completion.</li> <li>Stops delay time operation at stop ON. Restarts delay time operation at stop OFF.</li> <li>In order to have the time delay start at power ON or reset at power OFF, short out the start input beforehand.</li> </ul>	1	2	3	ON	OFF	ON	
1	2	3						
ON	OFF	ON						
Totalizing On delay (G)	<ul style="list-style-type: none"> <li>Set the operation mode section of the DIP switches (no.'s 1, 2, and 3) on the side of the timer as shown.                             <table border="1" style="margin-left: 20px;"> <tr> <td>1</td> <td>2</td> <td>3</td> </tr> <tr> <td>OFF</td> <td>ON</td> <td>ON</td> </tr> </table> </li> <li>Elapsed time value does not clear at power ON. (power outage countermeasure function)</li> <li>The output remains ON even after the power is off and restarted.</li> <li>Stops delay time operation at stop ON. Restarts delay time operation at stop OFF.</li> </ul>	1	2	3	OFF	ON	ON	
1	2	3						
OFF	ON	ON						

Notes: 1) Each signal input (start, reset, stop, and lock) is applied by shorting their input terminal to the common terminal (terminal ① for the 8-pin type, terminal ③ for the 11-pin type, and terminal ⑥ for the screw terminal type).  
 2) The 8-pin type does not have a stop input or lock input.

**Panasonic**  
ideas for life

**DIN 48 SIZE  
DIGITAL TIMER**

**LT4H-W**

UL File No.: E122222  
C-UL File No.: E122222

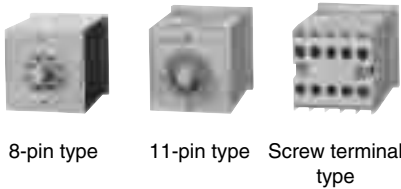
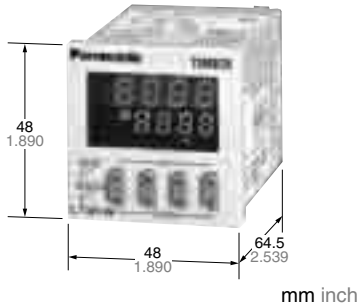

## Features

- Wide time range**  
 The operation time range covers from 0.01 sec. to 9999 hours.  
 The individual setting can be performed on each of 1 and 2 timers.  
 99.99s 99min59s 99h59min  
 999.9s 999.9min 999.9h  
 9999s 9999h
- Bright and Easy-to-Read Display**  
 A brand new bright 2-color back light LCD display. The easy-to-read screen in any location makes checking and setting procedures a cinch.
- Simple Operation**  
 Seesaw buttons make operating the unit even easier than before.
- Short Body of only 64.5 mm 2.539 inch (screw terminal type) or 70.1 mm 2.760 inch (pin type)**  
 With a short body, it is easy to install in even narrow control panels.

- Conforms to IP66's Weather Resistant Standards**  
 The water-proof panel keeps out water and dirt for reliable operation even in poor environments.
- Screw terminal (M3.5) and Pin Types are Both Standard Options**  
 The two terminal types are standard options to support either front panel installation or embedded installation.
- Changeable Panel Cover**  
 Also offers a black panel cover to meet your design considerations.
- Compliant with UL, c-UL and CE.**

## Product types

Time range	Operating mode	Output	Operating voltage	Power down insurance	Terminal type	Part number
99.99s 999.9s 9999s 99min59s 999.9min 99h59min 999.9h 9999h	Pulse input: • Delayed one shot • OFF-start flicker • ON-start flicker  Integrating input: • Delayed one shot • OFF-start flicker • ON-start flicker	Relay (1 c)	100 to 240 V AC	Available	8 pins	LT4HW8-AC240V
			24 V AC		11 pins	LT4HW-AC240V
					Screw terminal	LT4HW-AC240VS
		12 to 24 V DC	8 pins		LT4HW8-AC24V	
			11 pins		LT4HW-AC24V	
			Screw terminal		LT4HW-AC24VS	
	Transistor (1 a)	100 to 240 V AC	8 pins		LT4HWT8-AC240V	
			11 pins		LT4HWT-AC240V	
			Screw terminal		LT4HWT-AC240VS	
		24 V AC	8 pins		LT4HWT8-AC24V	
			11 pins		LT4HWT-AC24V	
			Screw terminal		LT4HWT-AC24VS	
12 to 24 V DC	8 pins	LT4HWT8-DC24V				
	11 pins	LT4HWT-DC24V				
	Screw terminal	LT4HWT-DC24VS				

\* A rubber gasket (ATC18002) and a mounting frame (AT8-DA4) are included.

## Part names

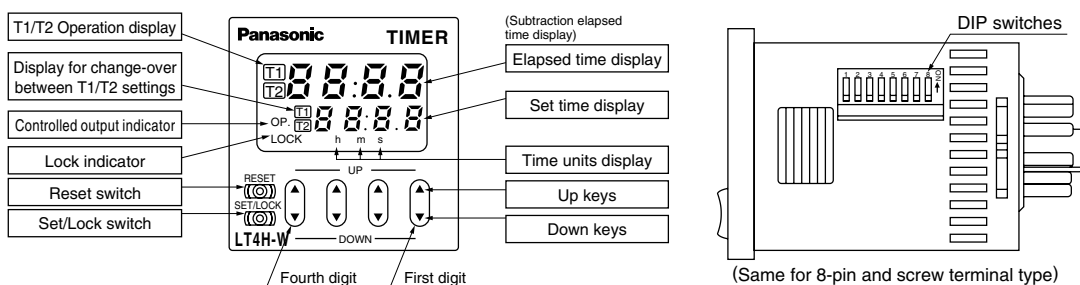

## Specifications

Item	Type	Relay output type		Transistor output type	
		AC type	DC type	AC type	DC type
Rating	Rated operating voltage	100 to 240 V AC, 24 V AC	12 to 24 V DC	100 to 240V AC, 24V AC	12 to 24 V DC
	Rated frequency	50/60 Hz common	—	50/60 Hz common	—
	Rated power consumption	Max. 10 V A	Max. 3 W	Max. 10 V A	Max. 3 W
	Rated control capacity	5 A, 250 V AC		100 mA, 30 V DC	
	Time range	99.99s, 999.9s, 9999s, 99min59s, 999.9min, 99h59min, 999.9h, 9999h (selected by DIP switch)			
	Time counting direction	Addition (UP)/Subtraction (DOWN) (2 directions selectable by DIP switch)			
	Operation mode	Pulse input: Delayed one shot, OFF-start flicker or ON-start flicker Integrating input: Delayed one shot, OFF-start flicker or ON-start flicker			
	Start/Reset/Stop input	Min. input signal width: 1 ms, 20 ms (2 directions by selected by DIP switch) (The 8 pin type does not have a stop input.)			
	Lock input	Min. input signal width: 20 ms (The 8-pin type does not have a lock input.)			
	Input signal	Open collector input Input impedance: Max. 1 kΩ; Residual voltage: Max. 2V Open impedance: 100 kΩ or less, Max. energized voltage: 40 V DC			
	Indication	7-segment LCD, Elapsed value (backlight red LED), Setting value (backlight yellow LED)			
Power failure memory method	EEP-ROM (Min. 10· overwriting)				
Time accuracy (max.)	Operating time fluctuation	± (0.005% + 50 ms) in case of power on start ± (0.005% + 20 ms) in case of input signal start		[ Operating voltage: 85% to 110% Temperature: -10°C to +55°C +14°F to +131°F Min. input signal width: 1ms ]	
	Temperature error				
	Voltage error				
	Setting error				
Contact	Contact arrangement	Timed-out 1 Form C	Timed-out 1 Form A (Open collector)		
	Contact resistance (Initial value)	100 mΩ (at 1 A 6 V DC)	—		
	Contact material	Ag alloy/Au flash	—		
Life	Mechanical (contact)	Min. 2x10 <sup>7</sup> ope. (Except for switch operation parts)		—	
	Electrical (contact)	Min. 10 <sup>7</sup> ope. (At rated control voltage)		Min. 10 <sup>7</sup> ope. (At rated control voltage)	
Electrical	Allowable operating voltage range	85 to 110 % of rated operating voltage			
	Breakdown voltage (Initial value)	2,000 Vrms for 1 min: Between live and dead metal parts (11-pin type only) 2,000 Vrms for 1 min: Between input and output 1,000 Vrms for 1 min: Between contacts		2,000 Vrms for 1 min: Between live and dead metal parts (Pin type only) 2,000 Vrms for 1 min: Between input and output	
	Insulation resistance (Initial value)	Min. 100 MΩ:	Between live and dead metal parts Between input and output (At 500V DC) Between contacts	Min. 100 MΩ: Between live and dead metal parts Between input and output (At 500V DC)	
	Operating voltage reset time	Max. 0.5 s			
	Temperature rise	Max 65° C (under the flow of nominal operating current at nominal voltage)		—	
Mechanical	Vibration resistance	Functional	10 to 55 Hz: 1 cycle/ min single amplitude of 0.35 mm .014 inch (10 min on 3 axes)		
		Destructive	10 to 55 Hz: 1 cycle/ min single amplitude of 0.75 mm .030 inch (1 h on 3 axes)		
	Shock resistance	Functional	Min. 98 m 321.522 ft./s (4 times on 3 axes)		
		Destructive	Min. 294 m 964.567 ft./s (5 times on 3 axes)		
Operating conditions	Ambient temperature	-10° C to 55° C +14° F to +131° F			
	Ambient humidity	Max. 85 % RH (non-condensing)			
	Air pressure	860 to 1,060 h Pa			
	Ripple rate	—	20 % or less	—	20 % or less
Connection	8-pin/11-pin/screw terminal				
Protective construction	IP66 (front panel with rubber gasket)				

## Applicable standard

Safety standard	EN61812-1	Pollution Degree 2/Overvoltage Category II
EMC	(EMI)EN61000-6-4 Radiation interference electric field strength	EN55011 Group1 ClassA EN55011 Group1 ClassA
	Noise terminal voltage (EMS)EN61000-6-2 Static discharge immunity	EN61000-4-2 4 kV contact 8 kV air
	RF electromagnetic field immunity	EN61000-4-3 10 V/m AM modulation (80 MHz to 1 GHz) 10 V/m pulse modulation (895 MHz to 905 MHz)
	EFT/B immunity	EN61000-4-4 2 kV (power supply line) 1 kV (signal line)
	Surge immunity	EN61000-4-5 1 kV (power line)
	Conductivity noise immunity	EN61000-4-6 10 V/m AM modulation (0.15 MHz to 80 MHz)
	Power frequency magnetic field immunity	EN61000-4-8 30 A/m (50 Hz)
	Voltage dip/Instantaneous stop/Voltage fluctuation immunity	EN61000-4-11 10 ms, 30% (rated voltage) 100 ms, 60% (rated voltage) 1,000 ms, 60% (rated voltage) 5,000 ms, 95% (rated voltage)

# LT4H-W

## Dimensions

(units: mm inch)

Tolerance: ±1.0 ±.039

### • LT4H-W digital timer

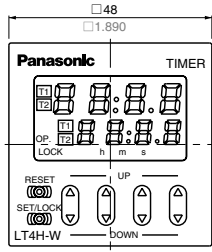

Screw terminal type  
(Flush mount)

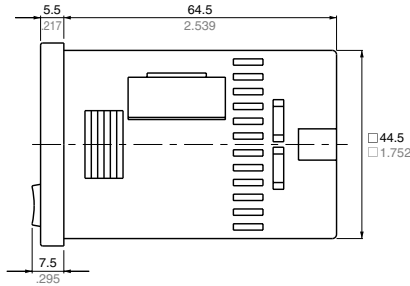

Pin type  
(Flush mount/Surface mount)

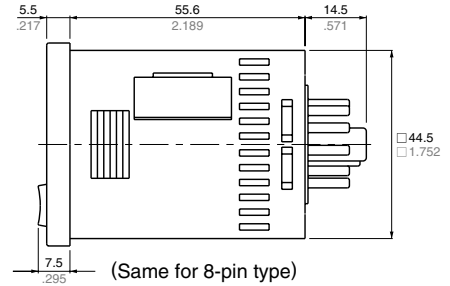

### • Dimensions for flush mount (with adapter installed)

Screw terminal type

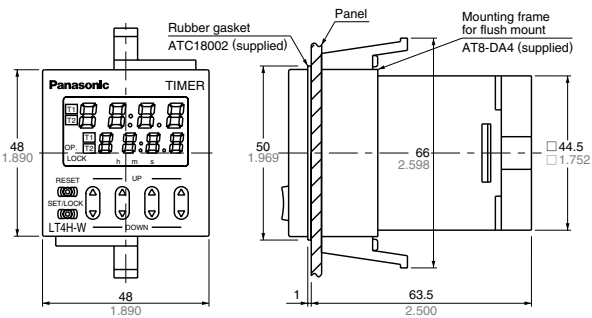

Pin type

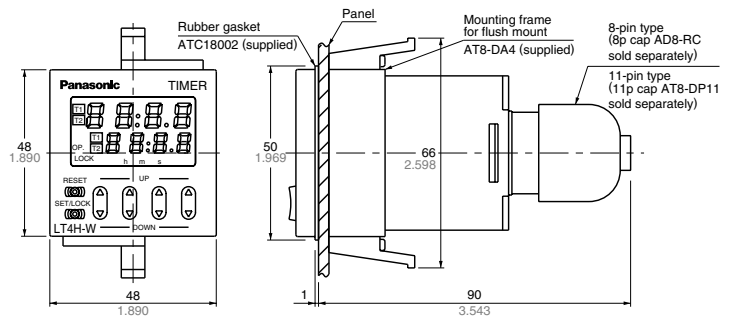

### • Dimensions for front panel installations

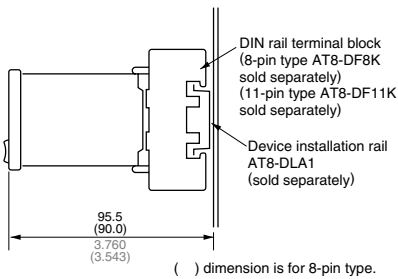

### • Installation panel cut-out dimensions

The standard panel cut-out dimensions are shown below. Use the mounting frame (AT8-DA4) and rubber gasket (ATC18002).

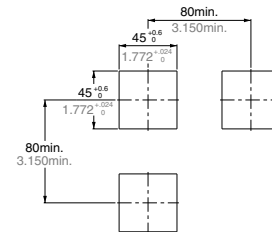

### • For connected installations

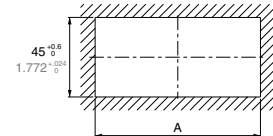

When n timers are continuously installed, the dimension (A) is calculated according to the following formula (n: the number of the timers to be installed):

$$A = (48 \times n - 2.5) \pm 0.09 \quad A = (1.890 \times n - .098) \pm 0.04$$

Note) 1: The installation panel thickness should be between 1 and 5 mm (.039 and .197 inch).

2: For connected installations, the waterproofing ability between the unit and installation panel is lost.

## Terminal layouts and wiring diagrams

### • 8-Pin type

Relay output type

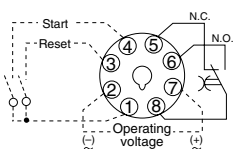

Transistor output type

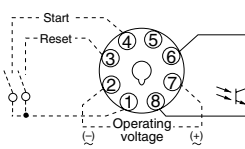

### • 11-Pin type

Relay output type

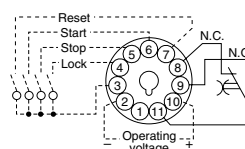

Transistor output type

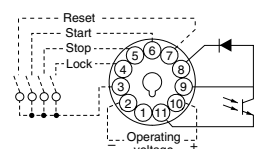

### • Screw terminal type

Relay output type

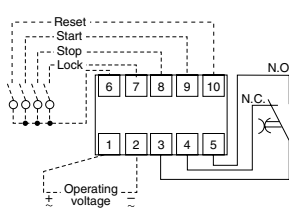

Transistor output type

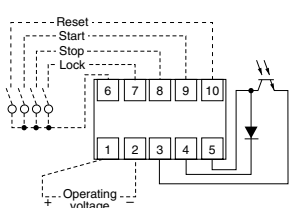

Note) For connecting the output leads of the transistor output type, refer to 5) Transistor output on page 26.

## Setting the operation mode and time range

### Setting procedure 1) Setting the time range (Timer T<sub>1</sub>/Timer T<sub>2</sub>)

Set the time range with the DIP switches on the side of the LT4H-W timer.

Item	DIP switch		
	OFF	ON	
1	Refer to table 1		
2			
3			
*4	Minimum input reset, start, and stop signal width	20 ms	1 ms
5	Time delay direction	Addition	Subtraction
6	Refer to table 2		
7			
8			

\* The 8-pin type does not have the stop input, so that the dip switch can be changed over between reset and start inputs. The signal range of the lock input is fixed (minimum 20 ms).

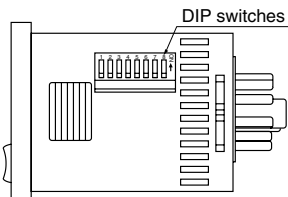

(same for screw terminal type and 8-pin type.)

Table 1: Setting the time range (Timer T<sub>1</sub>)

DIP switch No.			Time range
1	2	3	
ON	ON	ON	0.01 s to 99.99 s
OFF	OFF	OFF	0.1 s to 999.9 s
ON	OFF	OFF	1 s to 9999 s
OFF	ON	OFF	0 min 01 s to 99 min 59 s
ON	ON	OFF	0.1 min to 999.9 min
OFF	OFF	ON	0 h 01 min to 99 h 59 min
ON	OFF	ON	0.1 h to 999.9 h
OFF	ON	ON	1 h to 9999 h

Table 2: Setting the time range (Timer T<sub>2</sub>)

DIP switch No.			Time range
6	7	8	
ON	ON	ON	0.01 s to 99.99 s
OFF	OFF	OFF	0.1 s to 999.9 s
ON	OFF	OFF	1 s to 9999 s
OFF	ON	OFF	0 min 01 s to 99 min 59 s
ON	ON	OFF	0.1 min to 999.9 min
OFF	OFF	ON	0 h 01 min to 99 h 59 min
ON	OFF	ON	0.1 h to 999.9 h
OFF	ON	ON	1 h to 9999 h

Notes: 1) Set the DIP switches before installing the timer.  
2) When the DIP SW setting is changed, turn off the power once.  
3) The DIP switches are set as ON before shipping.

### Setting procedure 2) Setting the operation mode

Set the operation mode with the keys on the front of the LT4H-W timer.

- ① Elapsed time display
- ② Set time display
- ③ T<sub>1</sub>/T<sub>2</sub> operation indicator
- ④ T<sub>1</sub>/T<sub>2</sub> setting value selectable indicator
- ⑤ Controlled output indicator
- ⑥ Lock indicator
- ⑦ Time units display

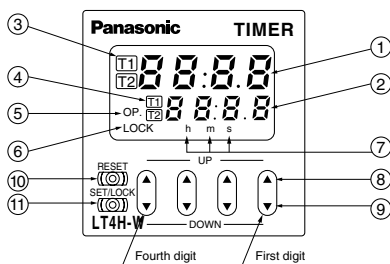

- ⑧ UP keys  
Changes the corresponding digit of the set time in the addition direction (upwards)
- ⑨ DOWN keys  
Changes the corresponding digit of the set time in the subtraction direction (downwards)
- ⑩ RESET switch  
Resets the elapsed time and the output
- ⑪ SET/LOCK switch  
Changes over the display between T<sub>1</sub>/T<sub>2</sub> settings, sets the operation mode, checks the operation mode and locks the operation of each key (such as up, down or reset key).

#### 1) Setting or changing the operation mode

- (1) When the UP or DOWN key at the first digit is pressed with the SET/LOCK switch pressed, the mode is changed over to the setting mode.
- (2) Now release the SET/LOCK switch.
- (3) The operation mode in the setting mode is changed over sequentially in the left or right direction by pressing the UP or DOWN key at the first digit, respectively.

Ex: Setting operation mode display (PULSE-A example)

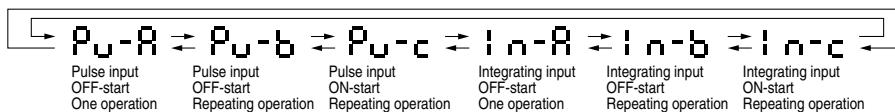
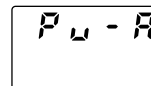

(4) The operational mode displayed at present is set by pressing the RESET switch, and the display returns to the normal condition.

#### 2) Setting (changing) the time

- (1) Pressing the SET/LOCK key switches the set value display between T<sub>1</sub> and T<sub>2</sub>. Display the timer (T<sub>1</sub> or T<sub>2</sub>) which is to be set (or changed).
- (2) After displaying the timer (T<sub>1</sub> or T<sub>2</sub>) which is to be set, press the UP or DOWN key to change the time.

##### • Checking the operation mode

When the UP or DOWN key at the second digit is pressed with the SET/LOCK switch pressed, the operational mode can be checked. The display returns to the normal condition after indicating the operational mode for about two seconds. (While the display indicates the operational mode for about two seconds, the other indicators continue to operate normally.)

##### • Setting the lock

When the UP or DOWN key at the fourth digit is pressed with the SET/LOCK switch pressed, all keys on the unit are locked. The timer does not accept any of UP, DOWN and RESET keys.

To release the lock setting, press the UP or DOWN key at the fourth digit again with the set/lock switch pressed.

\* Operational mode, adding and subtracting and minimum input signal range cannot be set at T<sub>1</sub> and T<sub>2</sub>, respectively.

##### • Changing over the T<sub>1</sub>/T<sub>2</sub> setting display

The T<sub>1</sub>/T<sub>2</sub> setting display is changed over by pressing the SET/LOCK switch. (This operation gives no effect on the other operations. The set time and elapsed time (residual time) at T<sub>1</sub> are linked with those at T<sub>2</sub>.)

##### • Changing the set time

- 1) It is possible to change the set time with the UP and DOWN keys even during time delay with the timer. However, be aware of the following points.
  - (1) If the set time is changed to less than the elapsed time with the time delay set to the addition direction, time delay will continue until the elapsed time reaches full scale, returns to zero, and then reaches the new set time. If the set time is changed to a time above the elapsed time, the time delay will continue until the elapsed time reaches the new set time.
  - (2) If the time delay is set to the subtraction direction, time delay will continue until "0" regardless of the new set time.
- 2) When the set times at T<sub>1</sub> and T<sub>2</sub> are set to 0, the output becomes ON only while the start input is carried out. However, while the reset input is carried out, the output becomes OFF.

## Operation Mode

	PULSE : Pulse input	INTEGRATION : Integrating input
<b>PULSE</b> Delayed one shot <b>A</b>	<p style="text-align: center;"><b>PULSE A</b> OFF-start/1 operation <math>t_1 &lt; T_1, t_2 &lt; T_2</math></p> <p> <ul style="list-style-type: none"> <li>• Elapsed value cleared when power is turned on.</li> <li>• Time limit start initiated when start input goes on; start input ignored if time limit interval is in progress.</li> <li>• Elapsed value cleared when one operation has been completed.</li> </ul> </p>	<p style="text-align: center;"><b>INTEGRATION A</b> OFF-start/1 operation <math>t_1 &lt; T_1, t_2 &lt; T_2</math></p> <p> <ul style="list-style-type: none"> <li>• Elapsed value not cleared when power is turned on (power failure backup function).</li> <li>• When power is turned back on, same status is maintained for output as that previous to power going off.</li> <li>• Elapsed value cleared when one operation has been completed.</li> </ul> </p>
OFF-start flicker <b>B</b>	<p style="text-align: center;"><b>PULSE B</b> OFF-start/repeating operation <math>t_1 &lt; T_1, t_2 &lt; T_2</math></p> <p> <ul style="list-style-type: none"> <li>• Elapsed value cleared when power is turned on.</li> <li>• Time limit start initiated when start input goes on; start input ignored if time limit interval is in progress.</li> </ul> </p>	<p style="text-align: center;"><b>INTEGRATION B</b> OFF-start/repeating operation <math>t_1 &lt; T_1, t_2 &lt; T_2</math></p> <p> <ul style="list-style-type: none"> <li>• Elapsed value not cleared when power is turned on (power failure backup function).</li> <li>• When power is turned back on, same status is maintained for output as that previous to power going off.</li> </ul> </p>
ON-start flicker <b>C</b>	<p style="text-align: center;">ON-start/repeating operation <math>t_1 &lt; T_1, t_2 &lt; T_2</math></p> <p> <ul style="list-style-type: none"> <li>• Elapsed value cleared when power is turned on.</li> <li>• Time limit start initiated when start input goes on; start input ignored if time limit interval is in progress.</li> </ul> </p>	<p style="text-align: center;">ON-start/repeating operation <math>t_1 &lt; T_1, t_2 &lt; T_2</math></p> <p> <ul style="list-style-type: none"> <li>• Elapsed value not cleared when power is turned on (power failure backup function).</li> <li>• When power is turned back on, same status is maintained for output as that previous to power going off.</li> </ul> </p>
Remarks and notes	<ul style="list-style-type: none"> <li>• The pulse input mode starts the operation by starting the start input.</li> <li>• When using the unit by starting it with the power on, short-circuit the start terminal (8-pin: ① to ④, 11-pin: ③ to ⑥ and screw terminal: [6] to [9]).</li> </ul>	<ul style="list-style-type: none"> <li>• The integrating input mode is operated by the integrated time of the start input. In other word, the timer operates only when the start input is performed.</li> <li>• When the elapsed value is cleared by the reset input, the output is reset.</li> <li>• When using the unit by starting it with the power on, short-circuit the start terminal (8-pin: ① to ④, 11-pin: ③ to ⑥ and screw terminal: [6] to [9]).</li> </ul>
	<ul style="list-style-type: none"> <li>• Each signal input such as start, reset, stop and lock inputs is applied by short-circuiting its input terminal and common terminal (8-pin type: terminal ①, 11-pin type: terminal ③ and screw terminal: terminal [6]) respectively.</li> <li>• The 8-pin type does not have a stop input or lock input.</li> </ul>	



# LT4H SERIES CAUTIONS FOR USE

## 1. Terminal wiring

1) When wiring the terminals, refer to the terminal layout and wiring diagrams and be sure to perform the wiring properly without errors.

2) When using the instrument with an flush mounting, the screw-down terminal type is recommended. For the pin type, use either the rear terminal block (AT78041) or the 8P cap (AD8-RC) for the 8-pin type, and the rear terminal block (AT78051) or the 11P cap (AT8-DP11) for the 11-pin type. Avoid soldering directly to the round pins on the unit. When using the instrument with a front panel installation, use the DIN rail terminal block (AT8-DF8K) for the 8-pin type and the DIN rail terminal block (AT8-DF11K) for the 11-pin type.

3) After turning the unit off, make sure that any resulting induced voltage or residual voltage is not applied to power supply terminals ② through ⑦ (8-pin type) ② through ⑩ (11-pin type) or ① and ② (screw terminal type). (If the power supply wire is wired parallel to the high voltage wire or power wire, an induced voltage may be generated between the power supply terminals.)  
4) Have the power supply voltage pass through a switch or relay so that it is applied at one time. If the power supply is applied gradually, the counting may malfunction regardless of the settings, the power supply reset may not function, or other such unpredictable occurrence may result.

## 2. Input connections

The power circuit has no transformer (power and input terminals are not insulated). When an input signal is fed to two or more timers at once, do not arrange the power circuit in an independent way. If the timer is powered on and off independently as shown in Fig. A, the timer's internal circuitry may get damaged. Be careful never to allow such circuitry. (Figs. A, B and C show the circuitry for the 11-pin type.)

(Fig. A)  
Input contact point or transistor

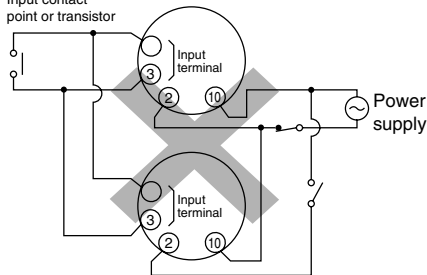

If independent power circuitry must be used, keep the input contacts or transistors separate from each other, as shown in Fig. B.

(Fig. B)

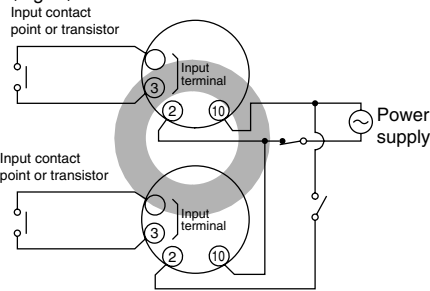

When power circuitry is not independent, one input signal can be fed to two or more counters at once, as shown in Fig. C.

(Fig. C)

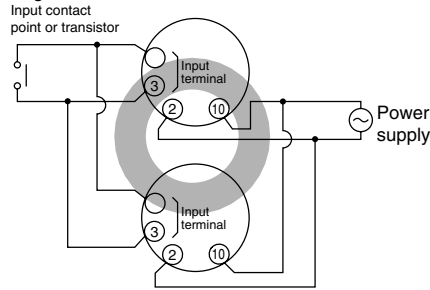

## 3. Input and output

### 1) Signal input type

#### (1) Contact point input

Use highly reliable metal plated contacts. Since the contact point's bounce time leads directly to error in the timer operations, use contacts with as short a bounce time as possible. Also, select a minimum input signal width of 20 ms.

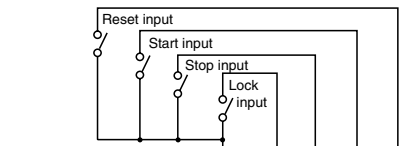

8-pin type	①	—	—	④	③
11-pin type	③	④	⑤	⑥	⑦
Screw terminal type	⑥	⑦	⑧	⑨	⑩

#### (2) Non-contact point input

Connect with an open collector. Use transistors whose characteristics satisfy the criteria given below.

$V_{CE0} = 20 \text{ V min.}$

$I_C = 20 \text{ mA min.}$

$I_{CBO} = 6\mu\text{A max.}$

Also, use transistors with a residual voltage of less than 2 V when the transistor is on.

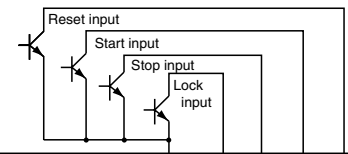

8-pin type	①	—	—	④	③
11-pin type	③	④	⑤	⑥	⑦
Screw terminal type	⑥	⑦	⑧	⑨	⑩

\* The short-circuit impedance should be less than 1 k $\Omega$ .

[When the impedance is 0  $\Omega$ , the current coming from the start input and stop input terminals is approximately 12 mA, and from the reset input and lock input terminals is approximately 1.5 mA.]

Also, the open-circuit impedance should be more than 100 k $\Omega$ .

\* As shown in the diagram below, from a non-contact point circuit (proximity switches, photoelectric switches, etc.) with a power supply voltage of between 12 and 40 V, the signal can be input without using an open collector transistor. In the case of the diagram below, when the non-contact point transistor Q switches from off to on (when the signal voltage goes from high to low), the signal is input.

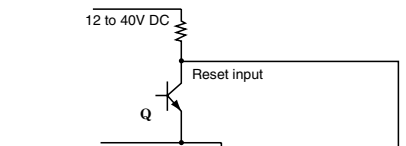

8-pin type	①	—	—	④	③
11-pin type	③	④	⑤	⑥	⑦
Screw terminal type	⑥	⑦	⑧	⑨	⑩

(The above example is for reset input)

2) The input mode and output mode change depending on the DIP switch settings. Therefore, before making any connections, be sure to confirm the operation mode and operation conditions currently set.

3) The LT4H series use power supply without a transformer (power and input terminals are not insulated). In connecting various kinds of input signals, therefore, use a power transformer in which the primary side is separated from the ungrounded secondary side as shown in Fig. A, for the power supply for a sensor and other input devices so that short-circuiting can be prevented.

# LT4H SERIES CAUTIONS FOR USE

Once the wiring to be used is completely installed and prior to installing this timer, confirm that there is complete insulation between the wires connected to the power terminals (2 each) and the wires connected to each input terminal. If the power and input lines are not insulated, a short-circuit may occur inside the timer and result in internal damage. In addition, when moving your equipment to a new installation location, confirm that there is no difference in environmental conditions as compared to the previous location.

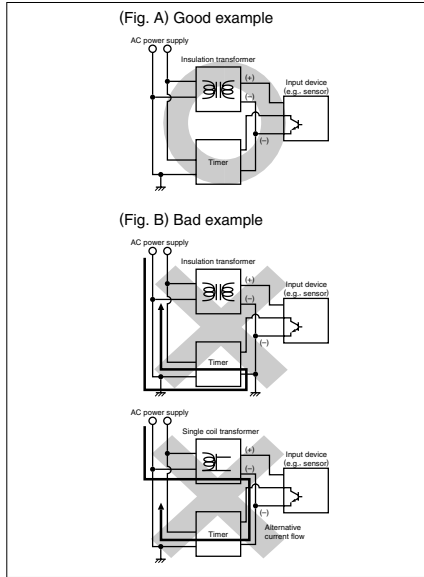

4) The input signal is applied by the shorting of each input terminal with the common terminal (terminal ① for 8-pin types, terminal ③ for 11-pin types and terminal ⑥ for screw terminal types). **N e v e r** connect other terminals or voltages higher than 40V DC, because it may destroy the internal circuitry.

5) Transistor output

(1) Since the transistor output is insulated from the internal circuitry by a photocoupler, it can be used as an NPN

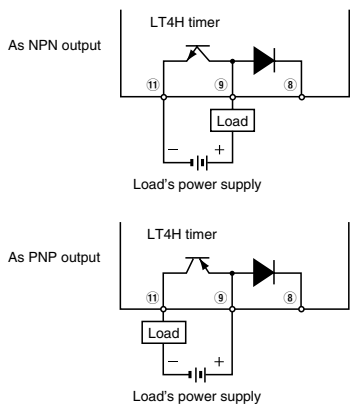

Note: With the 8-pin type, there is no diode between points ⑧ and ⑨.

output or PNP (equal value) output. (The above example is 11-pin type)

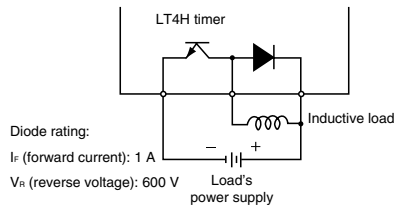

- (2) Use the diode connected to the output transistor's collector for absorbing the reverse voltage from induced loads.
- 6) When wiring, use shielded wires or metallic wire tubes, and keep the wire lengths as short as possible.
- 7) For the load of the controlled output, make sure that it is lower than the rated control capacity.

4. Operation of LT4H digital timer

1) Turning on and off the power supply while operating in A2\* (Power on delay 2) or G (Totalizing On delay) will result in a timer error to be generated due to the characteristics of the internal circuitry. Therefore, use the start input or stop input.

\* Not related to the start input.

2) When controlling the timer by turning on the power supply, use only A (Power on delay 1) or A2 (Power on delay 2). Use of other modes in this situation will result in timer errors. When using the other modes, control the timer with the start input or stop input.

5. Operation mode and time range setting

The operation mode and time range can be set with the DIP switches on the side of the timer. Make the DIP switch settings before installing the timer on the panel.

The operation mode of LT4H-W series can be set with the keys and switches on the front of the timer.

6. Conditions of usage

- 1) Avoid locations subject to flammable or corrosive gases, excessive dust, oil, vibrations, or excessive shocks.
- 2) Since the cover of the timer is made of polycarbonate resin, avoid contact with or use in environments containing methyl alcohol, benzene, thinners, and other organic solvents; and ammonia, caustic sodas, and other alkaline substances.
- 3) If power supply surges exceed the values given below, the internal circuits may

Operating voltage	Surge voltage (peak value)
AC type	6,000V
DC type 24V AC type	1,000V

• Surge wave form

[± (1.2x50) μs uni-polar full wave voltage]

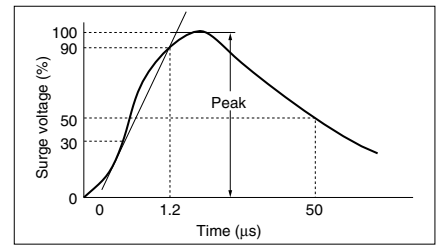

become damaged. Be sure to use surge absorbing element to prevent this from happening.

4) Regarding external noise, the values below are considered the noise-resistant voltages. If voltages rise above these

	Power supply terminals		Input terminals
	AC type	DC type 24V AC type	
Noise voltage	1,500V	1,000V	600V

values, malfunctions or damage to the internal circuitry may result, so take the necessary precautions.

Noise wave form (noise simulator)

Rise time: 1 ns

Pulse width: 1 μs, 50 ns

Polarity: ±

Cycle: 100 cycles/second

5) When connecting the operating power supply, make sure that no leakage current enters the timer. For example, when performing contact protection, if set up like that of fig. A, leaking current will

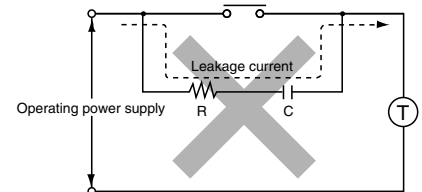

(Fig. A)

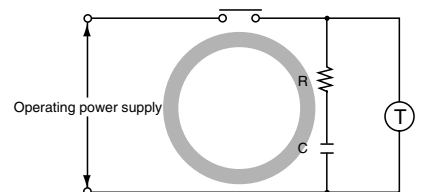

(Fig. B)

pass through C and R, enter the unit, and cause incorrect operation. The fig. B shows the correct setup.

6) Long periods of continuous operation in the time-up completed condition (one month or more) will result in the weakening of the internal electrical components from the generated heat and, therefore, should be avoided. If you do plan to use

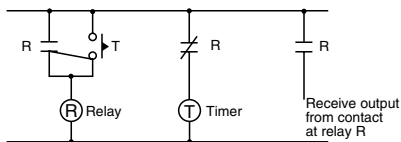

the unit for such continuous operation, use in conjunction with a relay as shown in the circuit in the diagram below.

### 7. Acquisition of CE marking

Please abide by the conditions below when using in applications that comply with EN61812-1.

- 1) Overvoltage category III, pollution level 2
- 2) This timer employs a power supply without a transformer, so the power and input signal terminals are not insulated.
  - (1) When a sensor is connected to the input circuit, install double insulation on the sensor side.
  - (2) In the case of contact input, use dual-insulated relays, etc.
  - 3) The load connected to the output contact should have basic insulation.

This timer is protected with basic insulation and can be double-insulated to meet EN/IEC requirements by using basic insulation on the load.

- 4) Please use a power supply that is protected by an overcurrent protection device which complies with the EN/IEC standard (example: 250 V 1 A fuse, etc.).
- 5) You must use a terminal socket or socket for the installation. Do not touch the terminals or other parts of the timer when it is powered. When installing or un-installing, make sure that no voltage is being applied to any of the terminals.
- 6) Do not use this timer as a safety circuit. For example when using a timer in a heater circuit, etc., provide a protection circuit on the machine side.

## 7. Self-diagnosis function

If a malfunction occurs, one of the following displays will appear.

Display	Contents	Output condition	Restoration procedure	Preset values after restoration
Err - 00	Malfunctioning CPU.	OFF	Enter reset input, RESET key, or restart unit.	The values at start-up before the CPU malfunction occurred.
Err - 01	Malfunctioning memory. See note.			0

Note: Includes the possibility that the EEPROM's life has expired.

# QM4H

**Panasonic**  
ideas for life

**DIN 48 SIZE  
DIGITAL TIMER**

**QM4H**

Digital  
Timers



S Type  
(with MODE switch)

G Type

## Features

- Possible to set and change the time and the time range even when the power is off.
- Furthermore single unit has a time range of 0.01 s to 9990hrs.
- Selectable 8 different time ranges with front digit switches.
- [QM4H-S Type]  
It can select the mode with MODE switch.  
T.D. MODE: Time delay 2C (2 Form C)  
INST. MODE: Time delay 1C (1 Form C)  
Instantaneous 1C (1 Form C)
- [QM4H-G Type]  
Reset and stop signal input enable to external control.
- Compliant with UL/c-UL and CE.

## Product types

Product name	Time delay direction	Time range	Operating mode	Contact arrangement	Operating voltage	Part number
S Type QM4H digital timer	Addition	0.01s/0.1s/1s/0.1min/ 1min/0.1h/1h/10h (8 time ranges)	Power ON delay	T.D. mode: Time delay 2C INST. mode: Time delay 1C and Instantaneous 1C (Use MODE switch on front)	12 to 48 V AC/DC	QM4HS-U2C-48V
G Type QM4H digital timer			Power ON delay (with reset and stop terminals)	Time delay 1C	12 to 48 V AC/DC	QM4HG-U1C-48V
					100 to 240 V AC/DC	QM4HS-U2C-240V
					100 to 240 V AC/DC	QM4HG-U1C-240V

Note: Time delay directional subtraction types are also available by order

## Part names

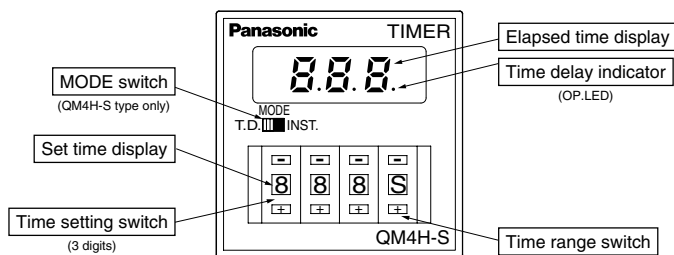

## Time range settings

Time range switch								
Operating time range	0.01s to 9.99s	0.1s to 99.9s	1s to 999s	0.1min. to 99.9min	1min. to 999min	0.1h to 99.9h	1h to 999h	10h to 9990h

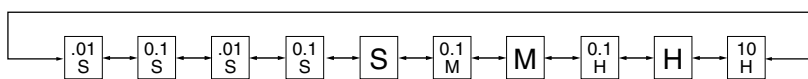

Note that there are two settings with the same range.

## Changing the time setting

• It is possible to use the up and down keys to change the time setting even during timer delay.

However, attention should be paid to the following.

- 1) When the time setting is shorter than the elapsed time, and timer delay is set in the plus direction, the time setting will return to "0" after the timer delay reaches full-scale, timer delay will be performed up to the changed time setting, and time up will be reached.
- 2) When timer delay is set in the minus direction, timer delay will be performed up to "0" regardless of the time, even if the time setting is shorter than the elapsed time, and time up will be reached.

## Specifications

Item		Type	QM4H-S	QM4H-G		
Rating	Rated operating voltage		12 to 48 V AC/DC and 100 to 240 V AC/DC			
	Rated power consumption	12 to 48 V AC/DC	During time delay	12 V DC, 48 V DC: Max. 1.5W 12 V AC, 48 V AC: Max. 3.0 VA	During time delay	12 V DC, 48 V DC: Max. 1.0W 12 V AC, 48 V AC: Max. 2.0 VA
			After time delay	12 V DC, 48 V DC: Max. 2.5W 12 V AC, 48 V AC: Max. 5.0 VA	After time delay	12 V DC, 48 V DC: Max. 1.5W 12 V AC, 48 V AC: Max. 3.5 VA
		100 to 240 V AC/DC	During time delay	100 V DC, 240 V DC: Max. 1.5W 100 V AC, 240 V AC: Max. 3.0 VA	During time delay	100 V DC, 240 V DC: Max. 1.0W 100 V AC, 240 V AC: Max. 2.5 VA
			After time delay	100 V DC, 240 V DC: Max. 2.0W 100 V AC, 240 V AC: Max. 4.0 VA	After time delay	100 V DC, 240 V DC: Max. 1.8W 100 V AC, 240 V AC: Max. 3.2 VA
	Rated frequency		50/60 Hz common (at AC)			
	Rated control capacity		5 A, 250V AC (resistive load)			
	Time range		0.01s to 9990h, Selection of 8 range: 0.01s/0.1s/1s/0.1min/1min/0.1h/1h/10h			
	Operation mode		Power ON delay	Power ON delay (with reset and stop terminals)		
	Min. input signal width		—	20ms (Reset and Stop inputs)*4		
Time accuracy*1	Operating time fluctuation		±(0.01%+0.05s) in case of power on start			
	Temperature error		±(0.005%+0.03s) in case of input reset start*2			
	Setting error		{ Operating voltage: 85 to 110% V Temperature: -10 to +55°C +14 to 131°F (20°C 68°F) Stopped time: 0.1 sec to 1 hour }			
	Voltage error					
Contact	Contact arrangement		T.D. mode: Time delay 2C INST. mode: Time delay 1C and Instantaneous 1C (Use MODE switch on front)	Time delay 1C		
	Contact material		Silver alloy			
Life*3	Mechanical (contact)		Min. 10 <sup>7</sup>			
	Electrical (contact)		Min. 10 <sup>5</sup> (at rated control vltage)			
Electrical	Allowable operating voltage range		85 to 110% of rated operating voltage			
	Breakdown voltage (Initial value)		Between live and dead metal parts, between input and output, between contact sets, between contacts Min. 100 MΩ (at 500 V DC megger)			
	Insulation resistance (Initial value)		Between live and dead metal parts: 2, 000 Vrms for 1 min Between input and output: 2, 000 Vrms for 1 min Between contact sets: 2, 000 Vrms for 1 min Between contacts: 1, 000 Vrms for 1 min			
	Reset time		Max. 0.1s			
Mechanical	Vibration resistance	Functional	10 to 55 Hz: 1 cycle/min. single amplitude of 0.25 mm .010 inch (10 min on 3 axes)			
		Destructive	10 to 55 Hz: 1 cycle/min. single amplitude of 0.375 mm .015 inch (1h on 3 axes)			
	Shock resistance	Functional	98 m/s <sup>2</sup> (4 times on 3 axes)			
		Destructive	980 m/s <sup>2</sup> (5 times on 3 axes)			
Operating conditions	Ambient temperature		-10°C to 55°C +14°F to +131°F			
	Ambient humidity		Min. 35 to 85% RH (non-condensing)			
	Air pressure		860 to 1060 hPa			
Others	Mass (Weight)		Approx. 130 g 4.59 oz	Approx. 120 g 4.23 oz		
	Available standards		UL, c-UL, CE			
	Operating display		LED (red), During time delay: blinking, After time delay: OFF			

Notes: 1. Unspecified measuring conditions are rated operating voltage (in case of DC type, ripple rate of 5% or less), ambient temp. 20°C 68°F, and stop time 1 second.

2. Reset start applies to QM4H-G type.

3. Excluding switches

4. Note that if the QM4H-G type is set to zero "0" and a STOP signal is input, output will begin when the power is turned on.

5. The protective structure on the AQM4801 is IP50, and IP64 for the AQM4803.

# QM4H

## Applicable standard

Safety standard	EN61010-1	Pollution Degree 2/Overvoltage Category II
EMC	(EMI)EN61000-6-4 Radiation interference electric field strength Noise terminal voltage (EMS)EN61000-6-2 Static discharge immunity	EN55011 Group1 ClassA EN55011 Group1 ClassA
	RF electromagnetic field immunity	EN61000-4-2 4 kV contact 8 kV air EN61000-4-3 10 V/m AM modulation (80 MHz to 1 GHz) 10 V/m pulse modulation (895 MHz to 905 MHz)
EMC	EFT/B immunity	EN61000-4-4 2 kV (power supply line)
	Surge immunity	EN61000-4-5 1 kV (power line)
	Conductivity noise immunity	EN61000-4-6 10 V/m AM modulation (0.15 MHz to 80 MHz)
	Power frequency magnetic field immunity	EN61000-4-8 30 A/m (50 Hz)
	Voltage dip/Instantaneous stop/Voltage fluctuation immunity	EN61000-4-11 10 ms, 30% (rated voltage) 100 ms, 60% (rated voltage) 1,000 ms, 60% (rated voltage) 5,000 ms, 95% (rated voltage)

## Dimensions

(units: mm inch)

Tolerance: ±1.0 ±.039

### • S Type

### • G Type

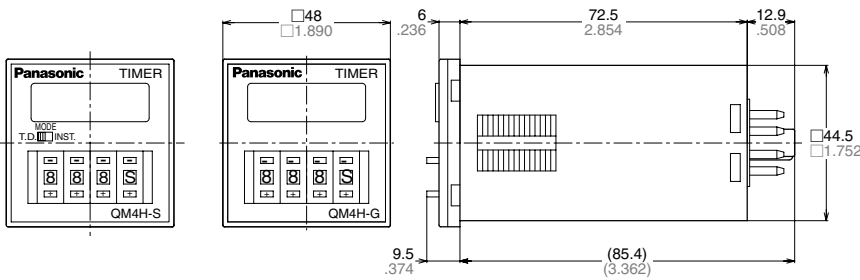

### Terminal layouts and Wiring diagrams

#### • QM4H-S Type

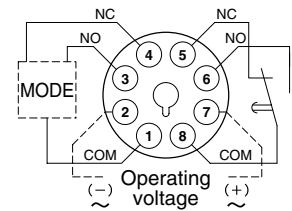

MODE

TD mode: Time delay 2C



INST mode:  
Time delay 1C and  
Instantaneous 1C

\*Use MODE switch on front

#### Notes:

1. Operating voltage signs in parentheses ( ) indicate the polarity of the DC type.

2. is a time delay contact.

is an instantaneous contact.

### Panel cut-out dimensions

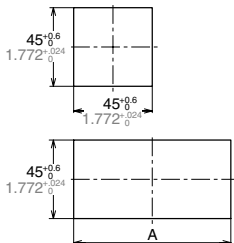

Dimensions A when n products are installed continuously:

$$A = (48 * n - 2.5 + 0.6) \quad A = (1.890 * n - .098 + 0.024)$$

### Panel Mounting Diagram

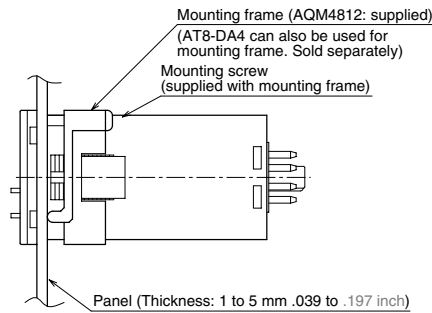

#### • QM4H-G Type

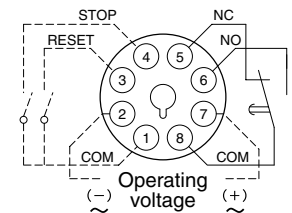

## Operation mode

### • QM4H-S Type

#### 1) T.D. mode

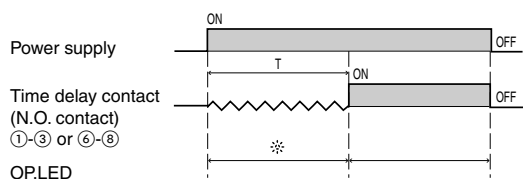

#### 2) INST. mode

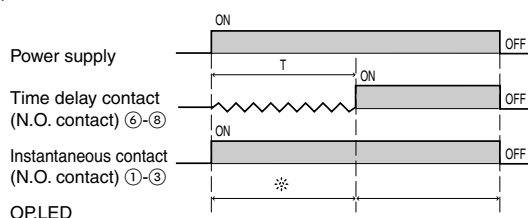

### • QM4H-G Type

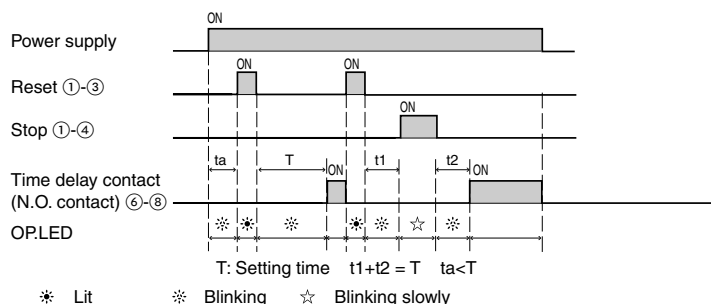

T: Setting time  $t_1+t_2 = T$   $t_a < T$

\* Lit    \*\* Blinking    ☆ Blinking slowly

\* Set the reset inputs ① to ③ and stop inputs ① to ④ to 20 ms or higher.

\* When shorting a signal, please set the inter-terminal resistance to 1 kΩ or less, and the inter-terminal residual voltage to 2 V or less. When releasing, please set the inter-terminal resistance to 100 kΩ or greater.

## Precautions in using the QM4H

1. Avoid locations subject to flammable or corrosive gases, excessive dust, oil, vibrations, or excessive shocks.
2. Since the main-unit is made of polycarbonate resin, avoid contact with or use in environments containing methyl alcohol, benzene, thinners, and other organic solvents; and ammonia, caustic sodas, and other alkaline substances.
3. Power supply superimposed surge protector

Although a surge protector will withstand standard-waveform voltage with the values in the next table, anything above this will destroy the internal circuit. You should therefore use a surge absorber.

12 to 48 V AC/DC	100 to 240 V AC/DC
1,000 V	6,000 V

- Surge waveform  
[±(1.2×50) μs uni-polar full wave voltage]

4. In order to maintain the characteristics, do not remove the timer case.
5. When installing the panel, use the supplied AQM4812 main-unit mounting frame. Note that the ATA4811 is also available for sale separately.
6. If you change the operating voltage, be sure not to allow leak current into the timer.

7. Avoid leaving the unit powered continuously. Leaving the unit powered up with output set to ON continuously for a long period of time (about 1 month or more) will wear out the electronic components. If you will be keeping it powered continuously, combine with a relay to create the circuit shown below:

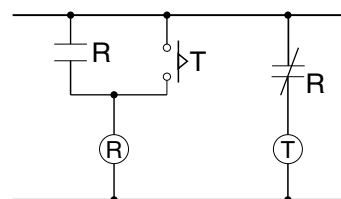

## Compliance with the CE marking

• When using in applications to which EN61010-1/IEC61010-1 applies, abide by the following conditions.

- 1) Ambient conditions
  - Overvoltage category II, pollution level 2
  - Indoor use
  - Acceptable temperature and humidity range: -10 to +55°C, 30 to 85%RH (with no condensation at 20°C)
  - Under 2000 m elevation

2) Use the unit in a location that matches the following conditions.

- There is minimal dust and no corrosive gas.
- There is no combustible or explosive gas.
- There is no mechanical vibration or impacts.
- There is no exposure to direct sunlight.
- Located away from large-volume electromagnetic switches and power lines with large electrical currents.

3) Connect a breaker that conforms to EN60947-1 or EN60947-3 to the voltage input section.

4) Applied voltage should be protected with an overcurrent protection device (example: T 1A, 250 V AC time lag fuse) that conforms to the EN/IEC standards.

# S1DXM-A/M

	<b>MULTI-RANGE ANALOG TIMER</b>	<b>S1DXM-A/M</b>
---	-------------------------------------	------------------

UL File No.: E122222  
C-UL File No.: E122222



## FEATURES



- **Multiple functions built in**  
The operation mode and time range can be switched by using the MODE and RANGE switches on the front panel.
- **Part number consolidation**
  - 1) The lineup consists of 64 easy-to-choose models.
  - 2) An operation mode fixed type (S1DXM-A) and 4-operation mode switching type (S1DXM-M) are available.
- **Cadmium-free contacts used**  
To eliminate environmentally harmful chemical substances, relays with cadmium-free contacts are used.

- **Economically priced**
  - 1) Prices set to lower costs.
  - 2) Further cost reduction when used with HJ Relay terminal socket.
- **CE marking supported**  
UL and C-UL approved.

## Product types

### 1. S1DXM-A multi-range timer

No MODE switch, Operation mode (fixed): Power ON-delay

Operating voltage	Time range	Timed-out 2 Form C	Timed-out 4 Form C
		Part number	Part number
12V DC	0.05 s to 10 min	S1DXM-A2C10M-DC12V	S1DXM-A4C10M-DC12V
	0.2 s to 30 min	S1DXM-A2C30M-DC12V	S1DXM-A4C30M-DC12V
	0.5 s to 60 min	S1DXM-A2C60M-DC12V	S1DXM-A4C60M-DC12V
	0.05 min to 10 hr	S1DXM-A2C10H-DC12V	S1DXM-A4C10H-DC12V
24V DC	0.05 s to 10 min	S1DXM-A2C10M-DC24V	S1DXM-A4C10M-DC24V
	0.2 s to 30 min	S1DXM-A2C30M-DC24V	S1DXM-A4C30M-DC24V
	0.5 s to 60 min	S1DXM-A2C60M-DC24V	S1DXM-A4C60M-DC24V
	0.05 min to 10 hr	S1DXM-A2C10H-DC24V	S1DXM-A4C10H-DC24V
24V AC	0.05 s to 10 min	S1DXM-A2C10M-AC24V	S1DXM-A4C10M-AC24V
	0.2 s to 30 min	S1DXM-A2C30M-AC24V	S1DXM-A4C30M-AC24V
	0.5 s to 60 min	S1DXM-A2C60M-AC24V	S1DXM-A4C60M-AC24V
	0.05 min to 10 hr	S1DXM-A2C10H-AC24V	S1DXM-A4C10H-AC24V
100 to 120V AC	0.05 s to 10 min	S1DXM-A2C10M-AC120V	S1DXM-A4C10M-AC120V
	0.2 s to 30 min	S1DXM-A2C30M-AC120V	S1DXM-A4C30M-AC120V
	0.5 s to 60 min	S1DXM-A2C60M-AC120V	S1DXM-A4C60M-AC120V
	0.05 min to 10 hr	S1DXM-A2C10H-AC120V	S1DXM-A4C10H-AC120V
200 to 220V AC	0.05 s to 10 min	S1DXM-A2C10M-AC220V	S1DXM-A4C10M-AC220V
	0.2 s to 30 min	S1DXM-A2C30M-AC220V	S1DXM-A4C30M-AC220V
	0.5 s to 60 min	S1DXM-A2C60M-AC220V	S1DXM-A4C60M-AC220V
	0.05 min to 10 hr	S1DXM-A2C10H-AC220V	S1DXM-A4C10H-AC220V
220 to 240V AC	0.05 s to 10 min	S1DXM-A2C10M-AC240V	S1DXM-A4C10M-AC240V
	0.2 s to 30 min	S1DXM-A2C30M-AC240V	S1DXM-A4C30M-AC240V
	0.5 s to 60 min	S1DXM-A2C60M-AC240V	S1DXM-A4C60M-AC240V
	0.05 min to 10 hr	S1DXM-A2C10H-AC240V	S1DXM-A4C10H-AC240V



# S1DXM-A/M

## 2. S1DXM-M multi-range timer

With MODE switch, Operation mode (switchable): Power ON-delay, Power Flicker ON start, Power Flicker OFF start, Power One-shot

Operating voltage	Time range	Timed-out 2 Form C	Timed-out 4 Form C
		Part number	Part number
12V DC	0.05 s to 10 min	S1DXM-M2C10M-DC12V	S1DXM-M4C10M-DC12V
	0.2 s to 30 min	S1DXM-M2C30M-DC12V	S1DXM-M4C30M-DC12V
	0.5 s to 60 min	S1DXM-M2C60M-DC12V	S1DXM-M4C60M-DC12V
	0.05 min to 10 hr	S1DXM-M2C10H-DC12V	S1DXM-M4C10H-DC12V
24V DC	0.05 s to 10 min	S1DXM-M2C10M-DC24V	S1DXM-M4C10M-DC24V
	0.2 s to 30 min	S1DXM-M2C30M-DC24V	S1DXM-M4C30M-DC24V
	0.5 s to 60 min	S1DXM-M2C60M-DC24V	S1DXM-M4C60M-DC24V
	0.05 min to 10 hr	S1DXM-M2C10H-DC24V	S1DXM-M4C10H-DC24V
24V AC	0.05 s to 10 min	S1DXM-M2C10M-AC24V	S1DXM-M4C10M-AC24V
	0.2 s to 30 min	S1DXM-M2C30M-AC24V	S1DXM-M4C30M-AC24V
	0.5 s to 60 min	S1DXM-M2C60M-AC24V	S1DXM-M4C60M-AC24V
	0.05 min to 10 hr	S1DXM-M2C10H-AC24V	S1DXM-M4C10H-AC24V
100 to 120V AC	0.05 s to 10 min	S1DXM-M2C10M-AC120V	S1DXM-M4C10M-AC120V
	0.2 s to 30 min	S1DXM-M2C30M-AC120V	S1DXM-M4C30M-AC120V
	0.5 s to 60 min	S1DXM-M2C60M-AC120V	S1DXM-M4C60M-AC120V
	0.05 min to 10 hr	S1DXM-M2C10H-AC120V	S1DXM-M4C10H-AC120V
200 to 220V AC	0.05 s to 10 min	S1DXM-M2C10M-AC220V	S1DXM-M4C10M-AC220V
	0.2 s to 30 min	S1DXM-M2C30M-AC220V	S1DXM-M4C30M-AC220V
	0.5 s to 60 min	S1DXM-M2C60M-AC220V	S1DXM-M4C60M-AC220V
	0.05 min to 10 hr	S1DXM-M2C10H-AC220V	S1DXM-M4C10H-AC220V
220 to 240V AC	0.05 s to 10 min	S1DXM-M2C10M-AC240V	S1DXM-M4C10M-AC240V
	0.2 s to 30 min	S1DXM-M2C30M-AC240V	S1DXM-M4C30M-AC240V
	0.5 s to 60 min	S1DXM-M2C60M-AC240V	S1DXM-M4C60M-AC240V
	0.05 min to 10 hr	S1DXM-M2C10H-AC240V	S1DXM-M4C10H-AC240V

## Part names

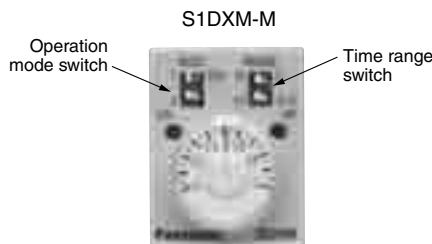
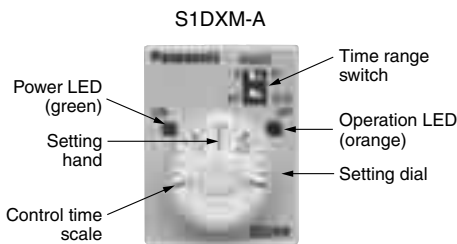

- [RANGE] Time range switch  
(4 different time ranges can be switched.)  
10M type: 1 s/10 s/1 min/10 min  
30M type: 3 s/30 s/3 min/30 min  
60M type: 6 s/60 s/6 min/60 min  
10H type: 1 min/10 min/1 hr/10 hr
- [MODE] Operation mode switch  
(4 different operation modes can be switched.)  
Power ON-delay  
Power Flicker OFF start  
Power Flicker ON start  
Power One-shot

## Operation mode and time range setting

Operation mode	Operation mode switch
Power ON-delay	1  ON
	2  ON
Power Flicker OFF start	1  ON
	2  ON
Power Flicker ON start	1  ON
	2  ON
Power One-shot	1  ON
	2  ON

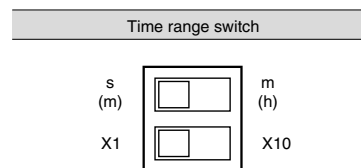

The time setting can be switched among 4 ranges each for 4 types for an interval between 0.05 seconds and 10 hours.

- Notes:
1. The product is factory shipped with all settings on the OFF side (left).
  2. Do not operate the switches with a sharp-edged object such as a knife blade.
  3. The power must be turned off when setting the time range or operation mode. Operating the switches with the power on is a cause of breakdown and malfunction.
  4. Use a force of under 5 N to operate the DIP switches when setting the time range and operation mode.

# S1DXM-A/M

## Operation mode

### 1. S1DXM-A multi-range timer

#### Power ON-delay operation

• When power is turned on, the output contact operates after the set time. The output contact remains on until the power is turned off.

Time chart

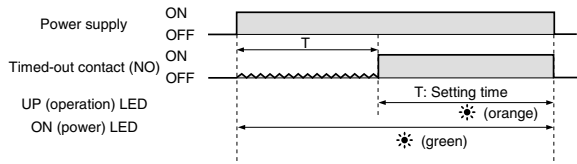

### 2. S1DXM-M multi-range timer

#### Power ON-delay operation

[MODE] switch 1: OFF, switch 2: OFF

• When power is turned on, the output contact operates after the set time. The output contact remains on until the power is turned off.

Time chart

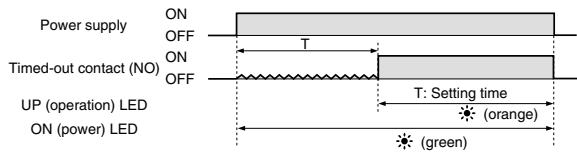

#### Power Flicker OFF start operation

[MODE] switch 1: OFF, switch 2: ON

• When the power is turned on, the output contacts repeatedly operate at the set time. The output contact begins from the off state.

Time chart

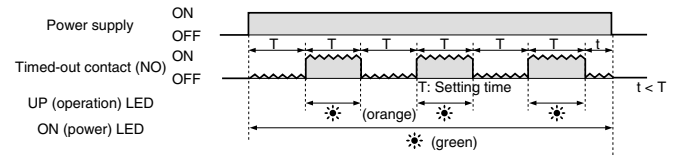

#### Power Flicker ON start operation

[MODE] switch 1: ON, switch 2: OFF

• When power is turned on, the output contact operates repeatedly at the set time. The output contact outputs at the same time power turns on.

Time chart

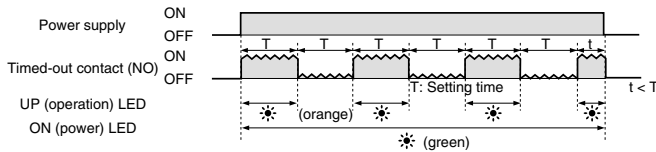

#### Power One-shot operation

[MODE] switch 1: ON, switch 2: ON

When power is turned on, the output contact performs the on operation at the same time power turns on, only for the set time.

Time chart

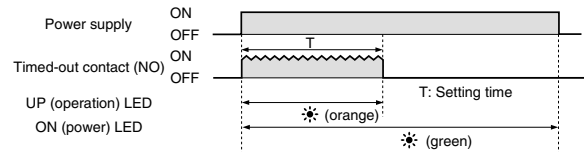

## Time range setting

Type	Time scale	Time unit	Min. scale	Max. scale	Setting range					
S1DXM-A	10M type	s	0.05	1	0.05 to 1s	0.5 to 10s	0.05 to 1m	0.5 to 10m		
	30M type	s	0.2	3	0.2 to 3s	2 to 30s	0.2 to 3m	2 to 30m		
	60M type	s	0.5	6	0.5 to 6s	5 to 60s	0.5 to 6m	5 to 60m		
	10H type	m	0.05	1	0.05 to 1m	0.5 to 10m	0.05 to 1h	0.5 to 10h		
S1DXM-M	10M type	s	0.05	1	0.05 to 1s	0.5 to 10s	0.05 to 1m	0.5 to 10m		
	30M type	s	0.2	3	0.2 to 3s	2 to 30s	0.2 to 3m	2 to 30m		
	60M type	s	0.5	6	0.5 to 6s	5 to 60s	0.5 to 6m	5 to 60m		
	10H type	m	0.05	1	0.05 to 1m	0.5 to 10m	0.05 to 1h	0.5 to 10h		

Note: The time setting range is the combination of the time scale (X1 or X10) on the dial and the time unit (s, m, or h).  
Example: When dial reads 1, time scale is X1 and time units is seconds, then it is 1 second.

## Ordering information

Ex. S1DXM- A 2C 30M — DC24V

Operation mode	Control output arrangement	Time range	Operating voltage*
A M	2C: Timed-out 2 Form C 4C: Timed-out 4 Form C	10M: 0.05 s to 10 min 30M: 0.2 s to 30 min 60M: 0.5 s to 60 min 10H: 0.05 min to 10 hr	DC12V: 12 V DC DC24V: 24 V DC AC24V: 24 V AC AC120V: 100 to 120 V AC AC220V: 200 to 220 V AC AC240V: 220 to 240 V AC

\* For other operating voltage types, please consult us.

# S1DXM-A/M

## Specifications

Item		Specifications						
Rating	Rated operating voltage	24VAC	100 to 120VAC	200 to 220VAC	220 to 240VAC	12VDC	24VDC	
	Rated frequency	50/60Hz common				—		
	Rated power consumption		Max. 3 VA (at 24 VAC)	Max. 3 VA (at 100 VAC)	Max. 3 VA (at 200 VAC)	Max. 3 VA (at 220 VAC)	Max. 2 W (at 12 VDC)	Max. 2 W (at 24 VDC)
		During time delay	Approx. 3mA	Approx. 3mA	Approx. 3mA	Approx. 3mA	Approx. 5mA	Approx. 3mA
		After time delay	Approx. 80mA	Approx. 20mA	Approx. 13mA	Approx. 13mA	Approx. 70mA	Approx. 40mA
	Rated control capacity	Timed -out 2 Form C: 7A 250V AC (resistive load) Timed -out 4 Form C: 5A 250V AC (resistive load)						
Operation mode	S1DXM-A Power on delay operation fixed (Power display: ON/green; Operation display (when output is on): UP/orange) S1DXM-M 4 switchable operations: Power ON-delay/Power Flicker OFF start/Power Flicker ON start/Power One-shot (Power display: ON/green; Operation display (when output is on): UP/orange)							
Time accuracy*1	Operating time fluctuation & Power off time change error	Max. ±1 %, (power off time change at the range of 0.1 s to 1 h), 1 s range: Max. ±1 % and 10 ms*2						
	Voltage error	Max. ±1 % (at the operating voltage changes between -20 to +10%), 1 s range: Max. ±1 % and 10 ms*2						
	Temperature error	Max. ±5% (at 20°C ambient temp. at the range of -10 to +50°C +14 to +122°F)						
	Setting error	Max. ±10%, 1 s range: Max. ±10% and 20 ms						
Contact	Contact arrangement	Timed-out 2 Form C, Timed-out 4 Form C						
	Contact resistance (Initial value)	Max. 100mΩ (at 1A, 6V DC)						
	Contact material	Timed-out 2 Form C type: Silver alloy, Au plating Timed-out 4 Form C type: Silver alloy, Au plating						
Life	Mechanical (constant)	Min. 10 <sup>7</sup>						
	Electrical (constant)	2×10 <sup>5</sup> (at rated control capacity)						
Mechanical	Vibration resistance	Functional	10 to 55Hz: 1 cycle/min double amplitude of 0.25mm (10min on 3 axes)					
		Destructive	10 to 55Hz: 1 cycle/min double amplitude of 0.375mm (1h on 3 axes)					
	Shock resistance	Functional	Min. 98m/s <sup>2</sup> (4 times on 3 axes)					
		Destructive	Min. 980m/s <sup>2</sup> (5 times on 3 axes)					
Electrical	Allowable operating voltage range	80 to 110% of rated operating voltage						
	Reset time	Max. 0.1s						
	Insulation resistance (Initial value)	Between live and dead metal parts, between input and output, between contact sets, between contacts Min. 100 MΩ (at 500 V DC megger)						
	Breakdown voltage (Initial value)	Between live and dead metal parts: 2,000 Vrms for 1 min Between input and output: 2,000 Vrms for 1 min Between contact sets: 2,000 Vrms for 1 min Between contacts: 1,000 Vrms for 1 min						
	Max. temperature rise	70°C 158°F						
Operating conditions	Ambient temperature	-10 to 50°C +14 to 122°F						
	Ambient humidity	35 to 85% RH (non-condensing)						
	Air pressure	860 to 1060 hPa						
	Ripple rate	DC type only, transmission wave rectification (ripple rate: approx. 48%)*3						
	Mass (Weight)	Approx. 45 g						
	Protective construction	IEC standard: IP40 (IP50 when using ADX18008 protective cover)						

Notes: \*1. Unspecified measuring conditions are rated operating voltage (in case of DC type, ripple rate of 5% or less), ambient temp. 20°C 68°F, and power off time 1 second.

\*2. Power one-shot 1 s range: +2% and 10 ms

\*3. When using with a transmission wave rectification, vibration resistance and shock resistance properties worsen compared to when using a stabilized power supply.

# S1DXM-A/M

## Dimensions

mm inch

### 1. S1DXM-A

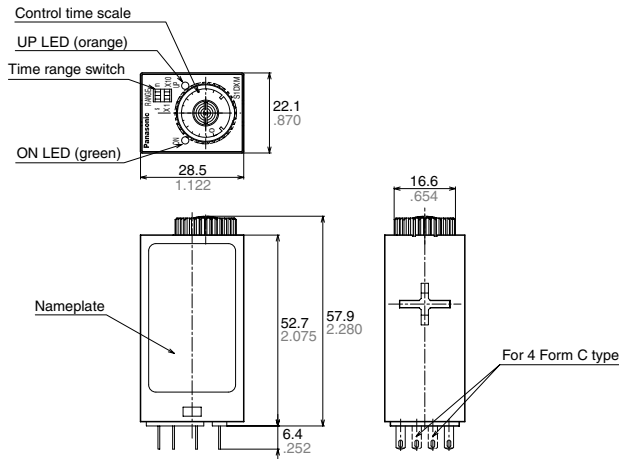

Tolerance:  $\pm 0.5 \pm 0.020$

### Terminal layouts and Wiring diagram Timed-out 2 Form C type

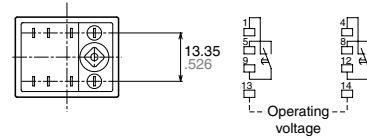

### Timed-out 4 Form C type

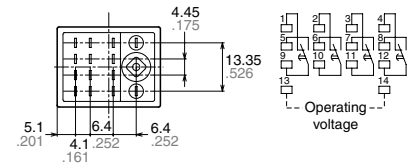

\* For the DC operating type, terminal 14 is "+" and terminal 13 is "-".

### 2. S1DXM-M

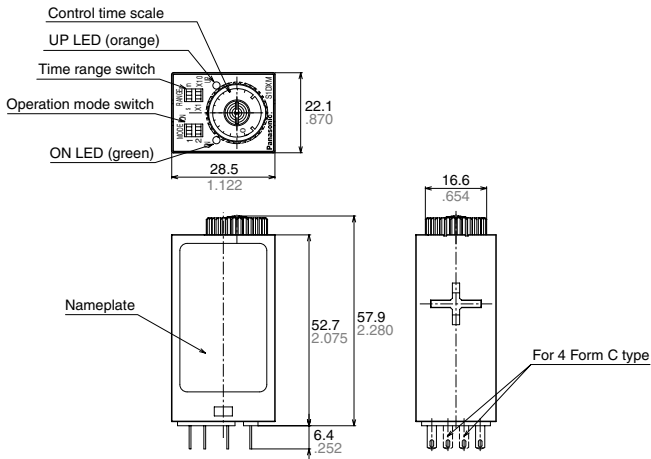

Tolerance:  $\pm 0.5 \pm 0.020$

### Terminal layouts and wiring diagram Timed-out 2 Form C type

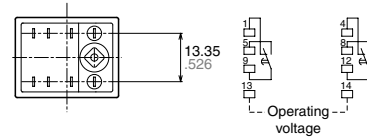

### Timed-out 4 Form C type

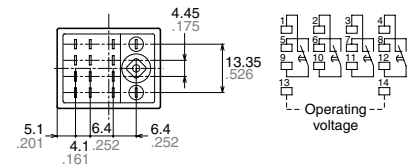

\* For the DC operating type, terminal 14 is "+" and terminal 13 is "-".

## Applicable standard

Safety standard	EN61812-1	Pollution Degree 2/Overvoltage Category II (2 Form C type); Pollution Degree 1/Overvoltage Category II (4 Form C type)
EMC	(EMI)EN61000-6-4 Radiation interference electric field strength Noise terminal voltage (EMS)EN61000-6-2 Static discharge immunity RF electromagnetic field immunity EFT/B immunity Surge immunity Conductivity noise immunity Power frequency magnetic field immunity Voltage dip/Instantaneous stop/Voltage fluctuation immunity	EN55011 Group1 ClassA EN55011 Group1 ClassA EN61000-4-2 4 kV contact 8 kV air EN61000-4-3 10 V/m AM modulation (80 MHz to 1 GHz) 10 V/m pulse modulation (895 MHz to 905 MHz) EN61000-4-4 2 kV (power supply line) 1 kV (signal line) EN61000-4-5 1 kV (power line) EN61000-4-6 10 V/m AM modulation (0.15 MHz to 80 MHz) EN61000-4-8 30 A/m (50 Hz) EN61000-4-11 10 ms, 30% (rated voltage) 100 ms, 60% (rated voltage) 1,000 ms, 60% (rated voltage) 5,000 ms, 95% (rated voltage)

## Precautions during usage

### 1. Reset periods

After unscheduled operations have been completed, or if the timer operation power supply has been turned off at any time during operation, a reset period of at least 0.1 seconds should be allowed before resuming operation.

### 2. External surge protection

External surge protection may be required if the following values are exceeded. Otherwise, the internal circuit will be damaged. The typical surge absorption elements include a varistor, a capacitor, and a diode. If a surge absorption element is used, use an oscilloscope to see whether or not the foreign surge exceeding the specified value appears.

#### • Single-pole, full-wave voltage for surge waveform [ $\pm(1.2 \times 50) \mu\text{s}$ ]

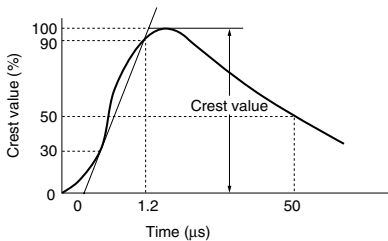

Operation voltage	Surge voltage
100 to 120V AC, 200 to 220V AC	4,000V
12V DC, 24V DC	1,000V

Since the main body cover and knob are made of polycarbonate resin, prevent contact with organic solvents such as methyl alcohol, benzene and thinner, or strong alkali materials such as ammonia and caustic soda.

### 3. Terminal wiring

Make sure that terminals are wired carefully and correctly, referring to the terminal layout and wiring diagrams. Particularly, since the DC type has polarity, do not operate it with reverse polarity.

### 4. Assembly

1) When installing, use a terminal socket or socket intended for the HC/HJ relay. For adjacent installations, be sure to first verify the installation conditions of the terminal sockets or sockets you will be using.

2) Use the separately-sold dedicated socket leaf holding clip to secure terminal sockets and sockets to the timer unit. The conditions of use for dedicated socket leaf holding clip will differ depending on the terminal socket or socket you will be using. Therefore, please test under actual conditions before putting into operation.

3) If terminals are to be soldered directly, please hand solder with a 30 to 60 W solder iron with a tip temperature of 300°C for no more than 3 seconds. Automatic soldering should be avoided.

4) A flux-tight construction is not used with this timer, so be careful that flux or cleaning fluid does not get inside the case.

5) To assure that characteristics are maintained, do not remove the case.

### 5. Long Continuous Current Flow

Long continuous current flow through the timer cause generation of heat internally, which degrade the electronic parts. Use the timer in combination with a relay and avoid long continuous current flow through the timer. (Refer to the circuit diagram below when using a safety circuit for continuous operation.)

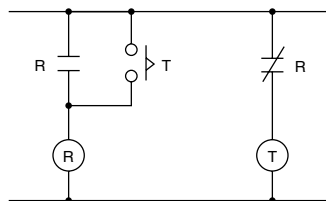

### 6. Phase synchronization using AC load

If the turning on of the timer output relay is synchronized to the AC power supply phase, there may be times when the service life is shortened because of electrical factors, or when a locking phenomenon (defective relay return) occurs because of contact point welding or a shift in the contact relay. Check the operation using the actual timer.

### 7. Acquisition of CE marking

Please abide by the conditions below when using in applications that comply with EN61812-1.

- 1) Overvoltage category II, pollution level 2 (2 Form C type)  
Overvoltage category II, pollution level 1 (4 Form C type)
- 2) The load connected to the output contact should have basic insulation. This timer is protected with basic insulation and can be double-insulated to meet EN/IEC requirements by using basic insulation on the load.
- 3) Please use a power supply that is protected by an overcurrent protection device which complies with the EN/IEC standard (example: 250 V 1 A fuse, etc.).
- 4) You must use a terminal socket or socket for the installation. Do not touch the terminals or other parts of the timer when it is powered. When installing or uninstalling, make sure that no voltage is being applied to any of the terminals.

5) Do not use this timer as a safety circuit. For example when using a timer in a heater circuit, etc., provide a protection circuit on the machine side.

### 8. Others

1) When setting the time, the dial should be kept within the range indicated on the dial face. The "0" marking on the dial indicates the minimum time during which the control time can be varied (it does not indicate 0 seconds).

2) Do not rotate the knob past the stopper.

3) Turn off the power before changing the DIP switch settings. Changing the DIP switch with the power on can cause breakdown.

4) When connecting the operating power supply, make sure that no leakage current enters the timer. For example, when performing contact protection, if set up like that of fig. A, leaking current will pass through C and R, enter the timer, and cause incorrect operation. The fig. B shows the correct setup.

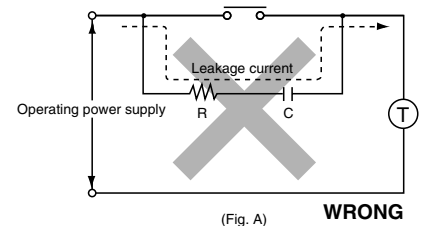

(Fig. A)

WRONG

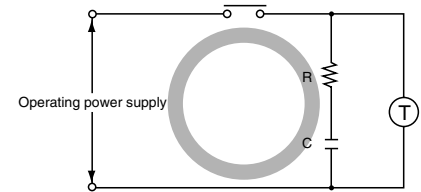

(Fig. B)

CORRECT

When a contact switch having an operation indicating lamp (lamp equipped limit switch, etc.) is used to apply power to the timer, a resistor having a value equal to or greater than the value below shall be connected in series with the lamp.

100 to 120V AC operating type:

Min. 33kΩ

200 to 220V AC operating type:

Min. 82kΩ

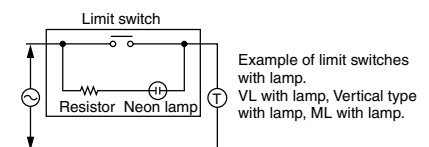

# PM4H-A/S/M

**Panasonic**  
ideas for life

**DIN48 SIZE  
MULTI-RANGE  
ANALOG TIMER**

**PM4H-A  
PM4H-S  
PM4H-M**

Analog  
Timers

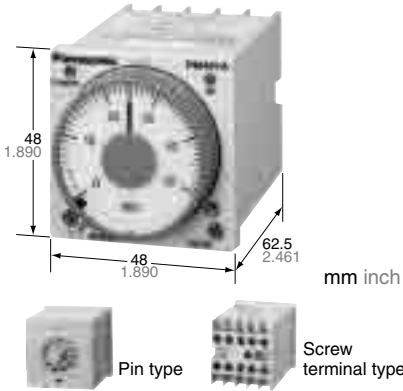

UL File No.: E122222  
CSA File No.: LR39291



## Features

- 100-240V AC free-voltage input, 48-125V DC type available
- Short body — 62.5mm 2.461 inch (screw terminal type)
- Front panel of IP65 type is protected against water-splash and dust
- Built-in Screw terminals  
Screw terminal type is used for easy wiring and reducing additional cost for accessories.
- 0 setting instantaneous output operation
- Multiple time ranges — 1 s to 500 h (Max.)
- 8 different operation modes: (PM4H-A)
- Compliant with UL/CSA, CE and LLOYD

## Product types

Type	Operation mode	Contact arrangement	Time range	Protective construction	Rated operating voltage	Terminal type	Part number	
PM4H-A	8 operation modes • Pulse ON-delay • Pulse Flicker • Pulse ON-flicker • Differential ON/OFF-delay (1) (2) • Signal OFF-delay • Pulse One-shot • Pulse One-cycle	Relay Timed-out 2 Form C		IP65	100 to 240V AC	11 pins	PM4HA-H-AC240VW	
						Screw terminal	PM4HA-H-AC240VSW	
					48 to 125V DC	11 pins	PM4HA-H-DC125VW	
						Screw terminal	PM4HA-H-DC125VSW	
					24V AC/DC	11 pins	PM4HA-H-24VW	
						Screw terminal	PM4HA-H-24VSW	
					12V DC	11 pins	PM4HA-H-DC12VW	
						Screw terminal	PM4HA-H-DC12VSW	
					IP50	100 to 240V AC	11 pins	PM4HA-H-AC240V
						Screw terminal	PM4HA-H-AC240VS	
48 to 125V DC	11 pins	PM4HA-H-DC125V						
Screw terminal	PM4HA-H-DC125VS							
PM4H-S	Power ON-delay	Relay Timed-out 2 Form C	16 selectable ranges 1s to 500h	IP65	100 to 240V AC	8 pins	PM4HS-H-AC240VW	
						Screw terminal	PM4HS-H-AC240VSW	
					48 to 125V DC	8 pins	PM4HS-H-DC125VW	
						Screw terminal	PM4HS-H-DC125VSW	
					24V AC/DC	8 pins	PM4HS-H-24VW	
						Screw terminal	PM4HS-H-24VSW	
					12V DC	8 pins	PM4HS-H-DC12VW	
						Screw terminal	PM4HS-H-DC12VSW	
					IP50	100 to 240V AC	8 pins	PM4HS-H-AC240V
						Screw terminal	PM4HS-H-AC240VS	
48 to 125V DC	8 pins	PM4HS-H-DC125V						
Screw terminal	PM4HS-H-DC125VS							
PM4H-M	5 operation modes (With instantaneous contact) • Power ON-delay • Power Flicker • Power ON-flicker • Power One-shot • Power One-cycle	Relay Timed-out 1 Form C Instantaneous 1 Form C		IP65	100 to 240V AC	8 pins	PM4HM-H-AC240VW	
						Screw terminal	PM4HM-H-AC240VSW	
					48 to 125V DC	8 pins	PM4HM-H-DC125VW	
						Screw terminal	PM4HM-H-DC125VSW	
					24V AC/DC	8 pins	PM4HM-H-24VW	
						Screw terminal	PM4HM-H-24VSW	
					12V DC	8 pins	PM4HM-H-DC12VW	
						Screw terminal	PM4HM-H-DC12VSW	
					IP50	100 to 240V AC	8 pins	PM4HM-H-AC240V
						Screw terminal	PM4HM-H-AC240VS	
48 to 125V DC	8 pins	PM4HM-H-DC125V						
Screw terminal	PM4HM-H-DC125VS							
24V AC/DC	8 pins	PM4HM-H-24V						
	Screw terminal	PM4HM-H-24VS						
12V DC	8 pins	PM4HM-H-DC12V						
	Screw terminal	PM4HM-H-DC12VS						

If you use this timer under harsh environment, please order above sealed type (IP65 type). IP65 type — Protection dust and water jet spray on the front face.

# PM4H-A/S/M

## Time range

Scale	Time unit					
	sec	min	hrs	10h		
1	Control time range	0.1s to 1s	0.1 min to 1 min	0.1h to 1h	1.0h to 10h	
5		0.5s to 5s	0.5 min to 5 min	0.5h to 5h	5h to 50h	
10		1.0s to 10s	1.0 min to 10 min	1.0h to 10h	10h to 100h	
50		5s to 50s	5 min to 50 min	5h to 50h	50h to 500h	

PM4H-A/PM4H-S/PM4H-M  
All types of PM4H timer have multi-time range.  
16 time ranges are selectable.  
1s to 500h (Max. range) is controlled.

Note: 0 setting is for instantaneous output operation.

## Specifications

Item	Type	PM4H-A	PM4H-S	PM4H-M
Rating	Rated operating voltage	100 to 240V AC, 48 to 125V DC, 12V DC, 24V AC/DC		
	Rated frequency	50/60Hz common (AC operating type)		
	Rated power consumption	Approx. 10VA (100 to 240V AC) Approx. 2.5VA (24V AC) Approx. 1.5W (12V DC, 24V DC, 48 to 125V DC)		
	Rated control capacity	5A 250V AC (resistive load)		
	Operating mode	Pulse ON-delay Pulse Flicker Pulse ON-Flicker Differential ON/OFF-delay (1) (2) Signal OFF-delay Pulse One-shot Pulse One-cycle	Power ON-delay	Power ON-delay Power Flicker Power ON-flicker Power One-shot Power One-cycle (with instantaneous contact)
	Time range	1s to 500h (Max.) 16 time ranges switchable		
Time accuracy Note:1)	Operating time fluctuation	±0.3% (power off time change at the range of 0.1s to 1h)		
	Setting error	±5% (Full-scale value)		
	Voltage error	±0.5% (at the operating voltage changes between 85 to 110%)		
	Temperature error	±2% (at 20°C ambient temp. at the range of -10 to +50°C +14 to +122°F)		
Contact	Contact arrangement	Timed-out 2 Form C		Timed-out 1 Form C Instantaneous 1 Form C
	Contact resistance (Initial value)	Max. 100mΩ (at 1A 6V DC)		
	Contact material	Silver alloy		Au flash on Silver alloy
Life	Mechanical (contact)	2×10 <sup>7</sup>		
	Electrical (contact)	10 <sup>5</sup> (at rated control capacity)		
Electrical function	Allowable operating voltage range	85 to 110% of rated operating voltage (at 20°C coil temp.)		
	Insulation resistance (Initial value)	Min. 100MΩ	Between live and dead metal parts Between input and output Between contacts of different poles Between contacts of same pole	(At 500V DC)
	Breakdown voltage (Initial value)	2,000Vrms for 1 min Between live and dead metal parts 2,000Vrms for 1 min Between input and output 2,000Vrms for 1 min Between contacts of different poles 1,000Vrms for 1 min Between contacts of same pole		
	Min. power off time	100ms		
	Max. temperature rise	55°C 131°F		65°C 149°F
	Mechanical function	Vibration resistance	Functional	10 to 55Hz: 1 cycle/min double amplitude of 0.25mm (10min on 3 axes)
Destructive			10 to 55Hz: 1 cycle/min double amplitude of 0.375mm (1h on 3 axes)	
Shock resistance		Functional	Min. 98m/s <sup>2</sup> (4 times on 3 axes)	
		Destructive	Min. 980m/s <sup>2</sup> (5 times on 3 axes)	
Operating condition	Ambient temperature	-10 to +50°C +14 to +122°F		
	Ambient humidity	30 to 85%RH (at 20°C 68°F, non-condensing)		
	Atmospheric pressure	860 to 1,060hPa		
	Ripple factor (DC type)	20%		
Others	Protective construction	IP65 on front panel (using rubber gasket ATC18002) <only for IP65 type>		
	Weight	100g 3.527 oz (Pin type) 110g 3.880 oz (Screw terminal type)		

Note: 1) Unless otherwise specified, the measurement conditions at the maximum scale time standard are specified to be the rated operating voltage (within 5% ripple factor for DC), 20°C 68°F ambient temperature, and 1s power off time.  
2) For the 1s range, the tolerance for each specification becomes ±10ms.

# PM4H-A/S/M

## Terminal layouts and wiring diagrams

### PM4H-A

Pin type

- Timed-out 2 Form C

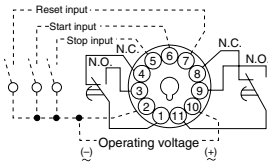

Screw terminal type

- Timed-out 2 Form C

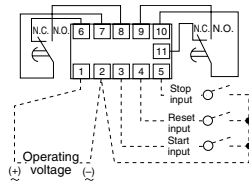

### PM4H-S

Pin type

- Timed-out 2 Form C

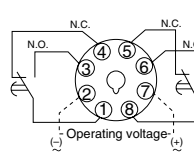

Screw terminal type

- Timed-out 2 Form C

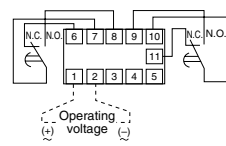

### PM4H-M

Pin type

- Timed-out 1 Form C
- Instantaneous 1 Form C

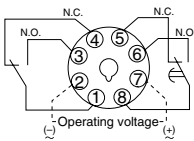

Screw terminal type

- Timed-out 1 Form C
- Instantaneous 1 Form C

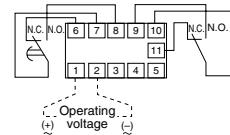

### 1) DC Type

Type	Pin	Screw terminal
PM4H-A	Connect the terminal ② to negative (-), and the terminal ⑩ to positive (+).	Connect the terminal ② to negative (-), and the terminal ⑩ to positive (+).
PM4H-S	Connect the terminal ② to negative (-), and the terminal ⑦ to positive (+).	
PM4H-M		

### 2) Contact



3) Voltage should not be applied to the various inputs (reset, start, and stop) of the PM4H-A multi-range timer. These inputs should be input without voltage.

## Part names

### PM4H-S



Time range selector  
16 time settings selectable  
(1 s to 500 h)  
1s 5s 10s 50s  
1min 5min 10min 50min  
1h 5h 10h 50h  
10h 50h 100h 500h

### PM4H-A

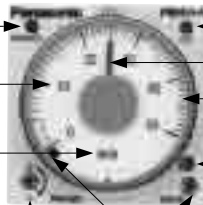

Power indicator LED  
Time indicator window  
Time unit indicator  
Output indicator LED  
Hand  
Set dial  
Operation mode indicator

Instantaneous output area  
When the hand is in this area,  
instantaneous operation starts.

### PM4H-M



Operation mode selector  
Selectable from  
5 operation modes  
ON : Power ON-delay  
FL : Power flicker  
FO : Power ON-flicker  
OS : Power One-shot  
OC : Power One-cycle

Operation mode selector  
Selectable from 8 operation modes  
ON : Pulse ON-delay  
FL : Pulse Flicker  
FO : Pulse ON-flicker  
OF1 : Differential ON/OFF-delay (1)  
SF : Signal OFF-delay  
OS : Pulse One-shot  
OF2 : Differential ON/OFF-delay (2)  
OC : Pulse One-cycle



# PM4H-A/S/M

## Dimensions

mm inch  
Tolerance:  $\pm 0.5 \pm .020$

### • PM4H-□

Screw terminal type  
(Flush mount)

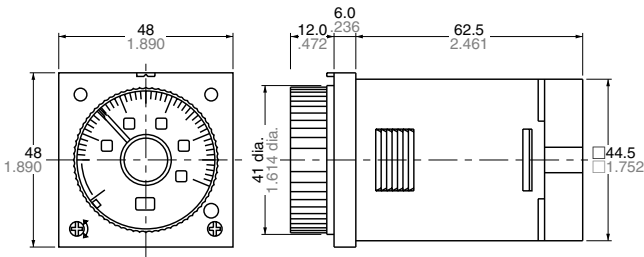

Pin type  
(Flush mount/Surface mount)

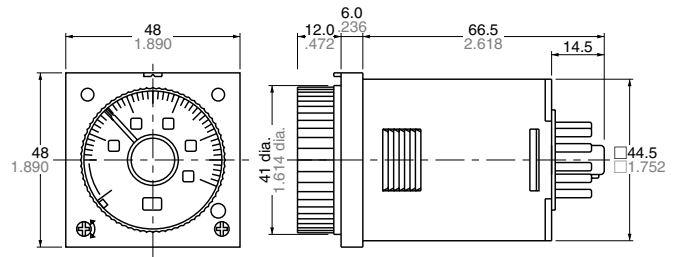

### • Panel mount dimensions (with mounting frame)

Screw terminal type

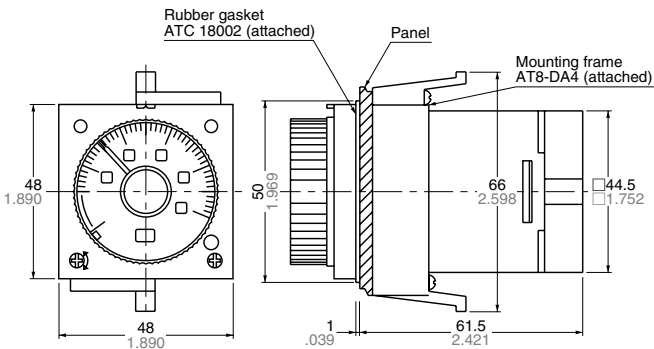

Pin type

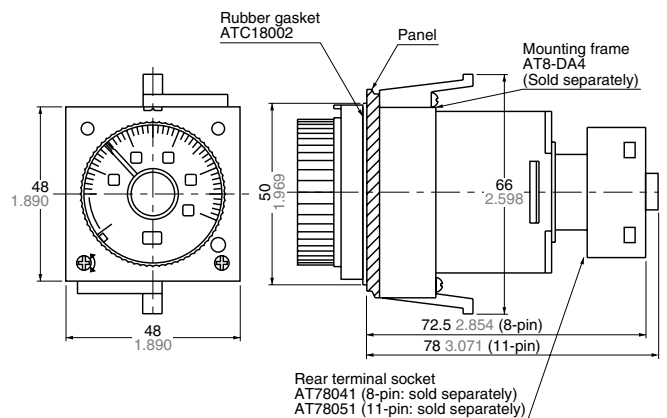

### • Surface mount dimensions

Pin type

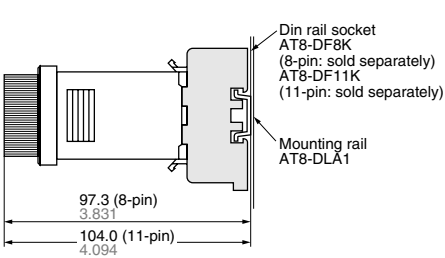

### • Panel cut out dimensions

Standard cut out dimensions are shown below.  
Use mounting frame (AT8-DA4) and rubber gasket (ATC18002).

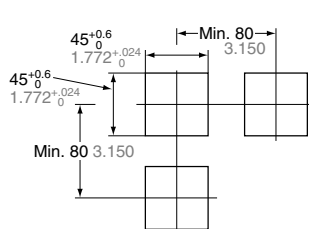

### • Adjacent mounting

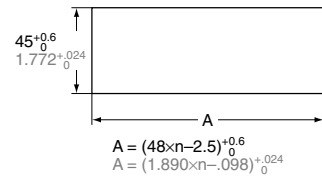









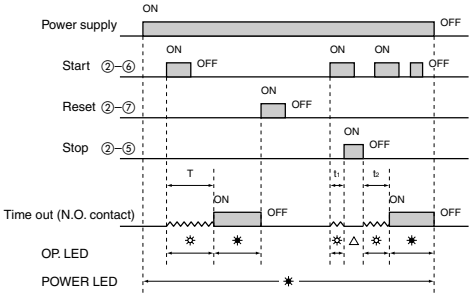

Note)  
1. The proper thickness of mounting panel is between 1 to 5mm.  
2. Adjacent mount is less water-resistant.

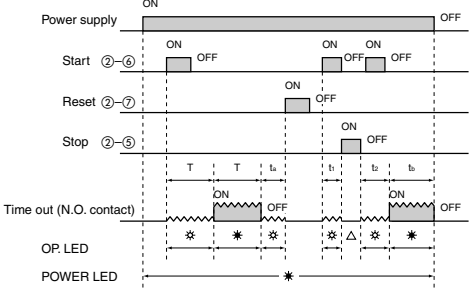
# PM4H-A/S/M

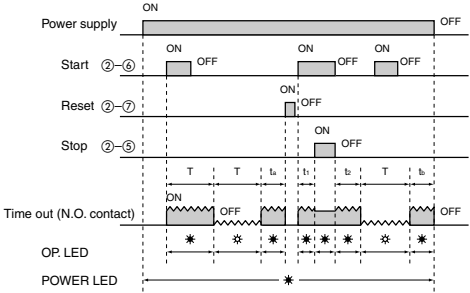
## Operation mode PM4H-A

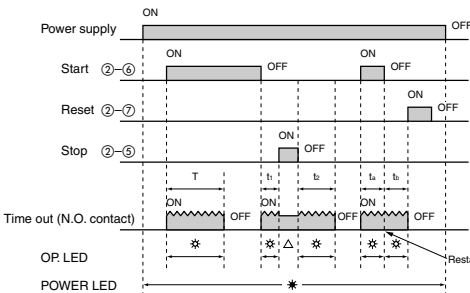
(\* LED lighting \* LED flickering)  
T: Setting time  $t_1, t_2, t_a, t_b < T$   $t_1+t_2=T$

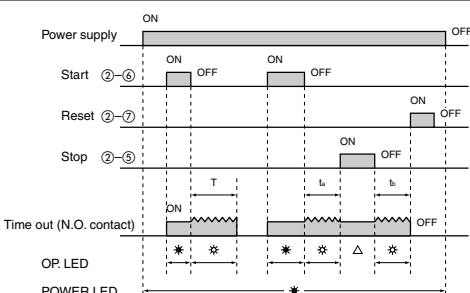
Operation type	Explanation	Time chart
<b>Pulse ON-delay</b> 	<ul style="list-style-type: none"> <li>If using a time-limit start when the power is turned on, and a reset when the power is turned off, pins ② to ⑥ (screw-tightening pins ② and ③) should be shorted ahead of time.</li> <li>Turn the operation mode selector switch to the  position.</li> <li>If pins ② to ⑥ (screw-tightening pins ② and ③) are shorted (the start input is turned on) with the power supply on, the output will go on after the set time has elapsed.</li> <li>If the power supply is turned off, or pins ② to ⑦ (screw-tightening pins ② to ④) are shorted (the reset input is turned on), a reset is carried out.</li> <li>Note) During time-limited operation, the time-limited operation is stopped while the pins ② to ⑤ (screw-tightening pins ② to ⑤) are being shorted (the stop input is on). When the pins are released, time-limited operation resumes.</li> </ul>	 <p>△Note: * LED lighting or No LED lighting</p>
<b>Pulse Flicker</b> 	<ul style="list-style-type: none"> <li>If using a time-limit start when the power is turned on, and a reset when the power is turned off, pins ② to ⑥ (screw-tightening pins ② and ③) should be shorted ahead of time.</li> <li>Turn the operation mode selector switch to the  position.</li> <li>When pins ② to ⑥ (screw-tightening pins ② and ③) are shorted (the start input is turned on) with the power supply on, the limited time interval begins, and the output goes on after the set time has elapsed. After the output has gone on, it goes off when the set time has elapsed, and this process is subsequently repeated.</li> <li>If the power supply is turned off, or pins ② to ⑦ (screw-tightening pins ② to ④) are shorted (the reset input is turned on), a reset is carried out.</li> <li>Note) During time-limited operation, the time-limited operation is stopped while the pins ② to ⑤ (screw-tightening pins ② to ⑤) are being shorted (the stop input is on). When the pins are released, time-limited operation resumes.</li> </ul>	 <p>△Note: * LED lighting or No LED lighting</p>
<b>Pulse ON-flicker</b> 	<ul style="list-style-type: none"> <li>If using a time-limit start when the power is turned on, and a reset when the power is turned off, pins ② to ⑥ (screw-tightening pins ② and ③) should be shorted ahead of time.</li> <li>Turn the operation mode selector switch to the  position.</li> <li>When pins ② to ⑥ (screw-tightening pins ② and ③) are shorted (the start input is turned on) with the power supply on, the output goes on, and after the set time has elapsed, it goes off. This process is subsequently repeated.</li> <li>If the power supply is turned off, or pins ② to ⑦ (screw-tightening pins ② to ④) are shorted (the reset input is turned on), a reset is carried out.</li> <li>Note) During time-limited operation, the time-limited operation is stopped while the pins ② to ⑤ (screw-tightening pins ② to ⑤) are being shorted (the stop input is on). When the pins are released, time-limited operation resumes.</li> </ul>	 <p>△Note: * LED lighting or No LED lighting</p>
<b>Differential ON/OFF-delay (1)</b> 	<ul style="list-style-type: none"> <li>Turn the operation mode selector switch to the  position.</li> <li>When pins ② to ⑥ (screw-tightening pins ② and ③) are shorted (the start input is turned on) with the power supply on, the output goes on, and after the set time has elapsed, it goes off.</li> <li>Also, when pins ② to ⑥ are released (the start input goes off), the output goes on, and after the set time has elapsed, it goes off.</li> <li>If the status of pins ② to ⑥ (screw-tightening pins ② and ③) changes during the time-limit interval (the start input goes from on to off, or from off to on), the time-limit interval is restarted from the point at which the change took place.</li> <li>If the power supply is turned off, or pins ② to ⑦ (screw-tightening pins ② to ④) are shorted (the reset input is turned on), a reset is carried out.</li> <li>Note) During time-limited operation, the time-limited operation is stopped while the pins ② to ⑤ (screw-tightening pins ② to ⑤) are being shorted (the stop input is on). When the pins are released, time-limited operation resumes.</li> </ul>	 <p>△Note: * LED lighting or No LED lighting</p>
<b>Signal OFF-delay</b> 	<ul style="list-style-type: none"> <li>Turn the operation mode selector switch to the  position.</li> <li>When pins ② to ⑥ (screw-tightening pins ② and ③) are shorted (the start input is turned on) with the power supply on, the output goes on, and when pins ② to ⑥ (screw-tightening pins ② and ③) are released (the start input is turned off), the time limit interval begins. After the set time has elapsed, the output goes off. If start input is entered at any point during the time limit interval, the time limit interval is reset.</li> <li>Note) During time-limited operation, the time-limited operation is stopped while the pins ② to ⑤ (screw-tightening pins ② to ⑤) are being shorted (the stop input is on). When the pins are released, time-limited operation resumes.</li> </ul>	 <p>△Note: * LED lighting or No LED lighting</p>

Note: Keep 0.1s or more for power off time.  
Keep 0.05s or more for start, stop, reset input time.

# PM4H-A/S/M

Operation type	Explanation	Time chart
<b>Pulse One-shot</b> (OS)	<ul style="list-style-type: none"> <li>If using a time-limit start when the power is turned on, and a reset when the power is turned off, pins ② to ⑥ (screw-tightening pins ② and ③) should be shorted ahead of time.</li> <li>Turn the operation mode selector switch to the (OS) position.</li> </ul> When pins ② to ⑥ (screw-tightening pins ② and ③) are shorted (the start input is turned on) with the power supply on, the output goes on for the set time limit interval. If the power supply is turned off, or pins ② to ⑦ (screw-tightening pins ② to ④) are shorted (the reset input is turned on), a reset is carried out. (Note) During time-limited operation, the time-limited operation is stopped while the pins ② to ⑤ (screw-tightening pins ② to ⑤) are being shorted (the stop input is on). When the pins are released, time-limited operation resumes.	<p>△Note: * LED lighting or No LED lighting</p>
<b>Differential ON/OFF-delay (2)</b> (OF2)	<ul style="list-style-type: none"> <li>Turn the operation mode selector switch to the (OF2) position.</li> </ul> When pins ② to ⑥ (screw-tightening pins ② and ③) are shorted (the start input is turned on) with the power supply on, the time limit interval begins, and after the set time interval has elapsed, the output goes on. Also, when pins ② to ⑥ are released (the start input goes off), the time limit interval begins, and after it has elapsed, the output goes off. If the status of pins ② to ⑥ (screw-tightening pins ② and ③) changes during the time-limit interval (the start input goes from on to off, or from off to on), the time limit interval is restarted from the point at which the change took place. If the power supply is turned off, or pins ② to ⑦ (screw-tightening pins ② to ④) are shorted (the reset input is turned on), a reset is carried out. (Note) During time-limited operation, the time-limited operation is stopped while the pins ② to ⑤ (screw-tightening pins ② to ⑤) are being shorted (the stop input is on). When the pins are released, time-limited operation resumes.	<p>△Note: * LED lighting or No LED lighting</p>
<b>Pulse One-cycle</b> (OC)	<ul style="list-style-type: none"> <li>If using a time-limit start when the power is turned on, and a reset when the power is turned off, pins ② to ④ (screw-tightening pins ② and ③) should be shorted ahead of time.</li> <li>Turn the operation mode selector switch to the (OC) position.</li> </ul> When pins ② to ④ (screw-tightening pins ② and ③) are shorted (the start input is turned on) with the power supply on, the output goes on after the set time limit interval has elapsed. After it has gone on, it goes off after one pulse (approximately 0.8 seconds). If the power supply is turned off, or pins ② to ⑦ (screw-tightening pins ② to ④) are shorted (the reset input is turned on), a reset is carried out. (Note) During time-limited operation, the time-limited operation is stopped while the pins ② to ⑤ (screw-tightening pins ② to ⑤) are being shorted (the stop input is on). When the pins are released, time-limited operation resumes.	<p>One pulse time (t): Approx. 0.8s                      △Note: * LED lighting or No LED lighting</p>

Note: Keep 0.1s or more for power off time.  
 Keep 0.05s or more for start, stop, reset input time.

(\* LED lighting \* LED flickering)  
 T: Setting time

## PM4H-S

Operation type	Explanation	Time chart
<b>Power ON-delay</b>	Time limit contact relay When the power supply is turned on, the output goes on after the set time interval has elapsed. When the power supply is turned off, a reset is carried out.	

## PM4H-M

Operation type	Explanation	Time chart
<b>Power ON-delay</b> (ON) <b>Power Flicker</b> (FL) <b>Power ON-flicker</b> (FO) <b>Power One-shot</b> (OS) <b>Power One-cycle</b> (OC)	Turn the operation mode selector switch to display the various operations. When the power supply is turned on, the time limit interval begins, and operation is carried out. When the power supply is turned off, a reset is carried out.	

Note: Keep 0.1s or more for power off time. PM4H-M timers do not have each input which is start, reset and stop.

# PM4H-SD/SDM

**Panasonic**  
ideas for life

**DIN48 SIZE ANALOG  
STAR (∩)-DELTA (Δ)  
TIMERS**

**PM4H  
-SD/SDM**

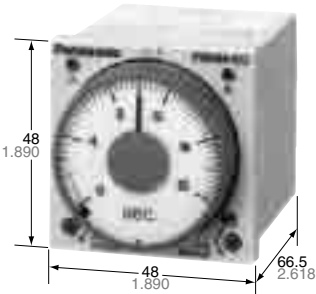

mm inch

UL File No.: E122222  
CSA File No.: LR39291



## Features

- Select four types of time ranges between 0.2 s and 100 s on a single unit.
- Select between five types of time ranges between 0.04 s and 0.7 s for the ∩-Δ switching times.
- There is a ∩-Δ switching indicator so you can check the operation at a glance.
- The AC free power supply and shorter body make it easier to use.
- Compliant with UL, CSA, CE and LLOYD.

## Specifications

Item	Type	PM4H-SD/SDM
Rating	Rated operating voltage	100 to 240V AC, 24V AC
	Rated frequency	50/60Hz common
	Rated power consumption	Approx. 6VA (100 to 240V AC), Approx. 1.4VA (24V AC)
	Rated control capacity	5A 250V AC (resistive load)
	Operation mode	∩-Δ star-delta switching (Power ON-delay)
Time accuracy Note:1)	∩ operation control time range	2s to 100s, 4 time ranges switchable
	∩-Δ switching time	0.04, 0.1, 0.3, 0.5, 0.7s (5 time range selectable)
	Operation time fluctuation	±0.3% (power off time change at the range of 0.5s to 1h)
	Setting error	±5% (Full-scale value)
Contact	Voltage error	±0.5% (at the operating voltage changes between 85 to 110%)
	Temperature error	±2% (at 20°C ambient temp. at the range of -10 to +50°C +14 to +122°F)
	Temperature error	±2% (at 20°C ambient temp. at the range of -10 to +50°C +14 to +122°F)
Life	Contact arrangement	Star (∩) side: Timed-out 1 Form A, Delta (Δ) side: Timed-out 1 Form A Instantaneous: 1 Form A (Instantaneous for PM4H-SDM type only)
	Contact resistance (Initial value)	Max. 100mΩ (at 1A 6V DC)
	Contact material	Au flash on Silver alloy
Electrical function	Mechanical (contact)	2×10 <sup>7</sup>
	Electrical (contact)	10 <sup>5</sup> (at rated control capacity)
	Allowable operating voltage range	85 to 110% of rated operating voltage (at 20°C coil temp.)
	Insulation resistance (Initial value)	Min. 100MΩ Between live and dead metal parts Between input and output Between contacts of different poles (*3) (At 500V DC) Between contacts of same pole
Mechanical function	Breakdown voltage (Initial value)	2,000Vrms for 1 min Between live and dead metal parts 2,000Vrms for 1 min Between input and output 2,000Vrms for 1 min Between contacts of different poles (*3) 1,000Vrms for 1 min Between contacts of same pole
	Min. power off time	500ms
	Max. temperature rise	65°C 131°F
Operating condition	Vibration resistance	10 to 55Hz: 1 cycle/min double amplitude of 0.25mm (10min on 3 axes) 10 to 55Hz: 1 cycle/min double amplitude of 0.375mm (1h on 3 axes)
	Shock resistance	Min. 294m/s <sup>2</sup> (4 times on 3 axes) Min. 980m/s <sup>2</sup> (5 times on 3 axes)
Others	Ambient temperature	-10 to +50°C +14 to +122°F
	Ambient humidity	Max. 85%RH (non-condensing)
	Atmospheric pressure	860 to 1,060hPa
Others	Protective construction	IP65 on front panel (using rubber gasket ATC18002) <only for IP65 type>
	Weight	100g 3.527 oz (Pin type), 110g 3.880 oz (Screw terminal type)

- Notes:
- 1) Unless otherwise specified, the measurement conditions at the maximum scale time standard are specified to be the rated operating voltage, 20°C 68°F ambient temperature, and 1s power off time.
  - 2) For the 2s range, the tolerance for each specification becomes ±10ms.
  - 3) Between contacts of different poles for PM4H-SDM type only.

# PM4H-SD/SDM

## Time range

Time range unit	Operating (s)	△-Δ switching time (s)
2	0.2 to 2	0.04
10	1 to 10	0.1
20	2 to 20	0.3
100	10 to 100	0.5
		0.7

## Product types

Type	Operation mode	Contact arrangement	Time range	Protective construction	Rated operating voltage	Terminal type	Part number	
PM4H-SD Star (∧)-Delta (Δ) switching	Star (∧)-Delta (Δ) switching	Relay Timed-out ∧ side: 1 Form A Δ side: 1 Form A	4 selectable ranges over 2s to 100s (∧-Δ switching time: 0.04, 0.1, 0.3, 0.5, 0.7s)	IP65	100 to 240V AC	8 pins	PM4HSD-S-AC240VW	
						Screw terminal	PM4HSD-S-AC240VSW	
24V AC		8 pins			PM4HSD-S-AC24VW			
		Screw terminal			PM4HSD-S-AC24VSW			
PM4H-SDM Star (∧)-Delta (Δ) switching (Instantaneous contact)		Relay Timed-out ∧ side: 1 Form A Δ side: 1 Form A Instantaneous: 1 Form A			IP65	100 to 240V AC	8 pins	PM4HSDM-S-AC240VW
							Screw terminal	PM4HSDM-S-AC240VSW
24V AC		8 pins		PM4HSDM-S-AC24VW				
		Screw terminal		PM4HSDM-S-AC24VSW				
PM4H-SD Star (∧)-Delta (Δ) switching		Relay Timed-out ∧ side: 1 Form A Δ side: 1 Form A		IP50	100 to 240V AC	8 pins	PM4HSD-S-AC240V	
						Screw terminal	PM4HSD-S-AC240VS	
24V AC		8 pins			PM4HSD-S-AC24V			
		Screw terminal			PM4HSD-S-AC24VS			
PM4H-SDM Star (∧)-Delta (Δ) switching (Instantaneous contact)		Relay Timed-out ∧ side: 1 Form A Δ side: 1 Form A Instantaneous: 1 Form A			IP50	100 to 240V AC	8 pins	PM4HSDM-S-AC240V
							Screw terminal	PM4HSDM-S-AC240VS
24V AC		8 pins		PM4HSDM-S-AC24V				
		Screw terminal		PM4HSDM-S-AC24VS				

## Terminal layouts and wiring diagrams

### Pin type

- No instantaneous contact
- With instantaneous contact

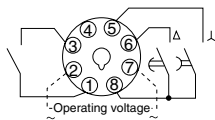
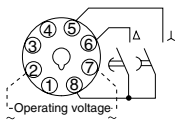

- ⑤-⑧: ∧ side time-delay contact
- ⑥-⑧: Δ side time-delay contact
- ①-③: Instantaneous contact (PM4H-SDM type)

### Screw terminal type

- No instantaneous contact
- With instantaneous contact

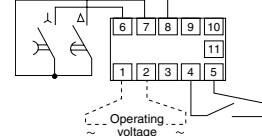
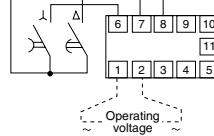

- ⑥-⑦: ∧ side time-delay contact
- ⑧-⑦: Δ side time-delay contact
- ④-⑤: Instantaneous contact (PM4H-SDM type)

## Dimensions

mm inch

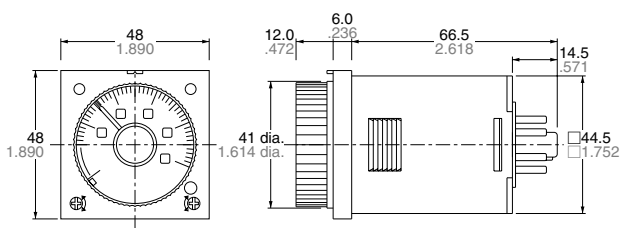

## Operation

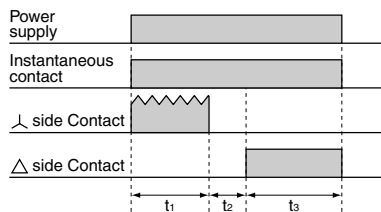

- t<sub>1</sub>: ∧ operation time (∧ indicator LED lights)
- t<sub>2</sub>: ∧-Δ switching time
- t<sub>3</sub>: Δ operation time (Δ indicator LED lights)

# PM4H-F

**Panasonic**  
ideas for life

**DIN48 SIZE ANALOG  
MULTI-RANGE POWER  
OFF-DELAY TIMERS**

**PM4H-F**

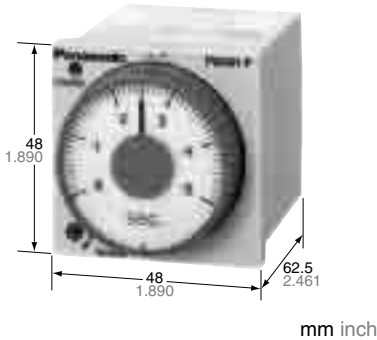

UL File No.: E122222  
CSA File No.: LR39291



## Features

- Switch operation times between three types of time ranges of 1 s to 10 s and 1 min to 10 min.
- Instantaneous reset available.
- The shorter body makes it easier to use.
- Compliant with UL, CSA, CE and LLOYD.

Analog  
Timers

## Specifications

Item	Type	PM4H-F8	PM4H-F8R	PM4H-F11R
Rating	Rated operating voltage	100 to 120V AC, 200 to 240V AC, 24V AC, 12V DC, 24V DC		
	Rated frequency	50/60Hz common (AC operating type)		
	Rated power consumption	Approx. 1.6VA (100 to 120V AC, 200 to 240V AC), Approx. 2.3VA (24V AC) Approx. 1.1W (12V DC, 24V DC)		
	Rated control capacity	3A 250V AC (resistive load)		
	Operation mode	Power OFF-delay		Power OFF-delay (with reset)
Time accuracy *1	Time range	1s to 10s: 3 range switchable 1 min to 10 min: 3 range selectable		
	Operation time fluctuation	±0.3%		
	Setting error	±5% (Full-scale value)		
	Voltage error	±0.5% (at the operating voltage changes between 85 to 110%)		
	Temperature error	±2% (at 20°C ambient temp. at the range of -10 to +50°C +14 to +122°F)		
Contact	Contact arrangement	Timed-out 2 Form C	Timed-out 1 Form C	Timed-out 2 Form C
	Contact resistance (Initial value)	Max. 100mΩ (at 1A 6V DC)		
	Contact material	Au flash on Silver alloy		
Life	Mechanical (contact)	10 <sup>7</sup>		
	Electrical (contact)	10 <sup>5</sup> (at rated control capacity)		
Electrical function	Allowable operating voltage range	85 to 110% of rated operating voltage (at 20°C coil temp.), 90 to 110% (DC Type)		
	Insulation resistance (Initial value)	Min. 100MΩ	Between live and dead metal parts Between input and output Between contacts of different poles (*3) Between contacts of same pole	(At 500V DC)
	Breakdown voltage (Initial value)	1,500Vrms for 1 min Between live and dead metal parts 1,500Vrms for 1 min Between input and output 1,000Vrms for 1 min Between contacts of different pole (*3) 750Vrms for 1 min Between contacts of same pole		
	Min. power supply width	s range type: 100ms min range type: 2s		
	Min. reset time	50ms		
	Max. temperature rise	55°C 131°F		
Mechanical function	Vibration resistance	Functional	10 to 55Hz: 1 cycle/min double amplitude of 0.25mm (10min on 3 axes)	
		Destructive	10 to 55Hz: 1 cycle/min double amplitude of 0.375mm (1hr on 3 axes)	
	Shock resistance	Functional	Min. 98m/s <sup>2</sup> (4 times on 3 axes)	
		Destructive	Min. 980m/s <sup>2</sup> (5 times on 3 axes)	
Operating condition	Ambient temperature	-10 to +50°C +14 to +122°F		
	Ambient humidity	30 to 85%RH (non-condensing)		
	Atmospheric pressure	860 to 1,060hPa		
	Ripple factor (DC type)	20%		
Others	Protective construction	IP65 on front panel (using rubber gasket ATC18002) <only for IP65 type>		
	Weight	100g 3.527 oz (Pin type), 110g 3.880 oz (Screw terminal type)		

- \*Notes:
- 1) Unless otherwise specified, the measurement conditions at the maximum scale time standard are specified to be the rated operating voltage (within 5% ripple factor for DC), 20°C 68°F ambient temperature.
  - 2) For the 1s range, the tolerance for each specification becomes ±10ms. When the power goes on, inrush current (0.3A) flows. Cautions should be taken. The minimum power supplying time after forced reset input is 2s or more.
  - 3) Between contacts of different pools for PM4H-F8, PM4H-F11R types only.

# PM4H-F

## Time range

Time range	Time range unit	s range type	min range type
1		0.04s to 1s	0.04 min to 1 min
5		0.2s to 5s	0.2 min to 5 min
10		0.4s to 10s	0.4 min to 10 min

## Product types

Type	Operation mode	Contact arrangement	Time range	Protective construction	Rated operating voltage	Terminal type	Part number		
PM4H-F8	Power OFF-delay (without reset)	Relay Timed-out 2 Form C	3 selectable time ranges over 1s to 10s	IP65	100 to 120V AC	8 pins	PM4HF8-S-AC120VW		
					200 to 240V AC	8 pins	PM4HF8-S-AC240VW		
					24V AC	8 pins	PM4HF8-S-AC24VW		
					12V DC	8 pins	PM4HF8-S-DC12VW		
					24V DC	8 pins	PM4HF8-S-DC24VW		
					100 to 120V AC	8 pins	PM4HF8-M-AC120VW		
					200 to 240V AC	8 pins	PM4HF8-M-AC240VW		
					24V AC	8 pins	PM4HF8-M-AC24VW		
			3 selectable time ranges over 1 min to 10 min	IP65	12V DC	8 pins	PM4HF8-M-DC12VW		
					24V DC	8 pins	PM4HF8-M-DC24VW		
					3 selectable time ranges over 1s to 10s	IP50	100 to 120V AC	8 pins	PM4HF8-S-AC120V
							200 to 240V AC	8 pins	PM4HF8-S-AC240V
							24V AC	8 pins	PM4HF8-S-AC24V
							12V DC	8 pins	PM4HF8-S-DC12V
					3 selectable time ranges over 1 min to 10 min	IP50	24V DC	8 pins	PM4HF8-S-DC24V
							100 to 120V AC	8 pins	PM4HF8-M-AC120V
200 to 240V AC	8 pins	PM4HF8-M-AC240V							
24V AC	8 pins	PM4HF8-M-AC24V							
3 selectable time ranges over 1 min to 10 min	IP50	12V DC	8 pins	PM4HF8-M-DC12V					
		24V DC	8 pins	PM4HF8-M-DC24V					
		3 selectable time ranges over 1s to 10s	IP65	100 to 120V AC	8 pins	PM4HF8R-S-AC120VW			
				200 to 240V AC	8 pins	PM4HF8R-S-AC240VW			
				24V AC	8 pins	PM4HF8R-S-AC24VW			
				12V DC	8 pins	PM4HF8R-S-DC12VW			
		3 selectable time ranges over 1 min to 10 min	IP65	24V DC	8 pins	PM4HF8R-S-DC24VW			
				100 to 120V AC	8 pins	PM4HF8R-M-AC120VW			
200 to 240V AC	8 pins			PM4HF8R-M-AC240VW					
24V AC	8 pins			PM4HF8R-M-AC24VW					
3 selectable time ranges over 1 min to 10 min	IP65	12V DC	8 pins	PM4HF8R-M-DC12VW					
		24V DC	8 pins	PM4HF8R-M-DC24VW					
		3 selectable time ranges over 1s to 10s	IP50	100 to 120V AC	8 pins	PM4HF8R-S-AC120V			
				200 to 240V AC	8 pins	PM4HF8R-S-AC240V			
				24V AC	8 pins	PM4HF8R-S-AC24V			
				12V DC	8 pins	PM4HF8R-S-DC12V			
		3 selectable time ranges over 1 min to 10 min	IP50	24V DC	8 pins	PM4HF8R-S-DC24V			
				100 to 120V AC	8 pins	PM4HF8R-M-AC120V			
200 to 240V AC	8 pins			PM4HF8R-M-AC240V					
24V AC	8 pins			PM4HF8R-M-AC24V					
3 selectable time ranges over 1 min to 10 min	IP50	12V DC	8 pins	PM4HF8R-M-DC12V					
		24V DC	8 pins	PM4HF8R-M-DC24V					

# PM4H-F

Type	Operation mode	Contact arrangement	Time range	Protective construction	Rated operating voltage	Terminal type	Part number
PM4H-F11R	Power OFF-delay (with instantaneous reset)	Relay Timed-out 2 Form C	3 selectable time ranges over 1s to 10s	IP65	100 to 120V AC	11 pins	PM4HF11R-S-AC120VW
						Screw terminal	PM4HF11R-S-AC120VSW
					200 to 240V AC	11 pins	PM4HF11R-S-AC240VW
						Screw terminal	PM4HF11R-S-AC240VSW
					24V AC	11 pins	PM4HF11R-S-AC24VW
						Screw terminal	PM4HF11R-S-AC24VSW
				12V DC	11 pins	PM4HF11R-S-DC12VW	
					Screw terminal	PM4HF11R-S-DC12VSW	
				24V DC	11 pins	PM4HF11R-S-DC24VW	
					Screw terminal	PM4HF11R-S-DC24VSW	
				IP50	100 to 120V AC	11 pins	PM4HF11R-S-AC120V
						Screw terminal	PM4HF11R-S-AC120VS
			200 to 240V AC		11 pins	PM4HF11R-S-AC240V	
					Screw terminal	PM4HF11R-S-AC240VS	
			24V AC		11 pins	PM4HF11R-S-AC24V	
					Screw terminal	PM4HF11R-S-AC24VS	
			12V DC	11 pins	PM4HF11R-S-DC12V		
				Screw terminal	PM4HF11R-S-DC12VS		
			24V DC	11 pins	PM4HF11R-S-DC24V		
				Screw terminal	PM4HF11R-S-DC24VS		
			3 selectable time ranges over 1 min to 10 min	IP65	100 to 120V AC	11 pins	PM4HF11R-M-AC120VW
						Screw terminal	PM4HF11R-M-AC120VSW
					200 to 240V AC	11 pins	PM4HF11R-M-AC240VW
						Screw terminal	PM4HF11R-M-AC240VSW
24V AC	11 pins	PM4HF11R-M-AC24VW					
	Screw terminal	PM4HF11R-M-AC24VSW					
12V DC	11 pins	PM4HF11R-M-DC12VW					
	Screw terminal	PM4HF11R-M-DC12VSW					
24V DC	11 pins	PM4HF11R-M-DC24VW					
	Screw terminal	PM4HF11R-M-DC24VSW					
IP50	100 to 120V AC	11 pins		PM4HF11R-M-AC120V			
		Screw terminal		PM4HF11R-M-AC120VS			
	200 to 240V AC	11 pins	PM4HF11R-M-AC240V				
		Screw terminal	PM4HF11R-M-AC240VS				
	24V AC	11 pins	PM4HF11R-M-AC24V				
		Screw terminal	PM4HF11R-M-AC24VS				
12V DC	11 pins	PM4HF11R-M-DC12V					
	Screw terminal	PM4HF11R-M-DC12VS					
24V DC	11 pins	PM4HF11R-M-DC24V					
	Screw terminal	PM4HF11R-M-DC24VS					

## Dimensions

mm inch

Toletance:  $\pm 0.5 \pm 0.20$

### • Screw terminal type (Flush mount)

### • Pin type (Flush mount/surface mount)

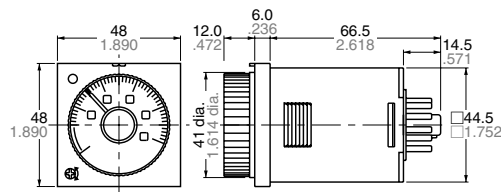
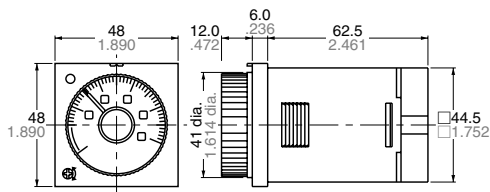



# PM4H-F

## Terminal layouts and wiring diagrams

- **PM4H-F8 (without reset input)**  
Pin type  
Time-out 2 Form C

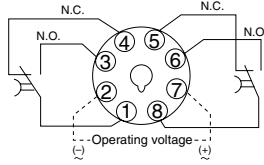

Screw-tightening pin type  
The PM4H-F11R should be used for the time-limit 2C.

- **PM4H-F8R (with reset input)**  
Pin type  
Time-out 1 Form C, with reset input

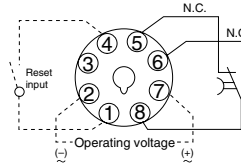

Screw-tightening pin type  
The PM4H-F11R should be used for the time-limit 1C and to connect reset input.

- **PM4H-F11R (with reset input)**  
Pin type  
Time-out 2 Form C, with reset input

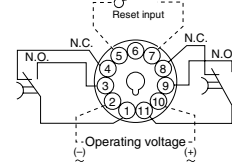

Screw terminal type  
Time-out 2 Form C, with reset input

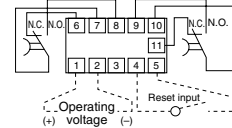

## PM4H-F (with reset) input conditions

### 1. Contact input (pin type example)

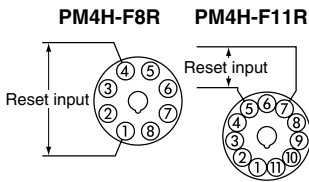

Use a contact with good contact reliability for the input. Contact bounce can lead to erroneous operation of the timer, so use a contact with short bounce time. Make the resistance between terminals for a short circuit less than 1k-ohms. Make the resistance between terminals for an open circuit greater than 100k-ohms.

### 2. Non-contact input (pin type example)

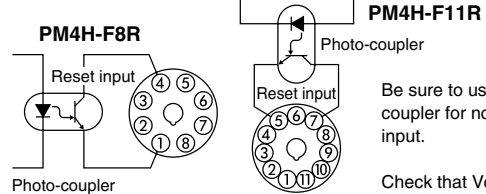

Be sure to use a photo-coupler for non-contact input.

Check that  $V_{ce} = 0.6V$  Max. when ON.

## Operation

- **PM4H-F8 (without reset input)**

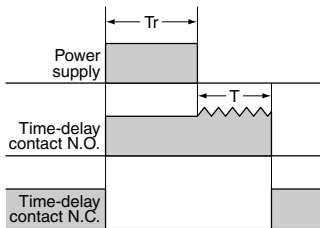

- **PM4H-F8R/F11R (with reset input)**

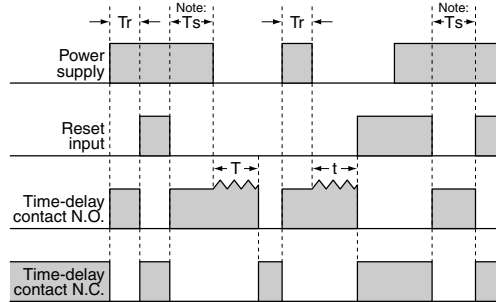

Note:  $t < T$ : Time setting  
Tr: Minimum power supply application time  
Ts: Min. 2s (Time to restart operation after reset input is set to OFF: both second type and minute type)

**Panasonic**  
ideas for life

**DIN48 SIZE**  
**ANALOG MULTI-RANGE**  
**CYCLIC TWIN TIMERS**

**PM4H-W**

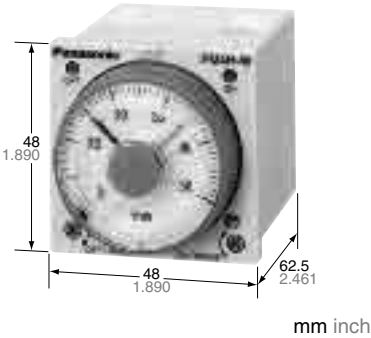

UL File No.: E122222  
CSA File No.: LR39291



## Features

- A single twin timer unit that repeats (variable) ON/OFF.
- Multiple ranges with a 0.1 s to 500 h time specification on a single unit.
- The output ON/OFF operation is indicated by red and green LED's. It's easy to check the operation at a glance.
- The AC free power supply and shorter body make it easier to use.
- A new screw terminal type has been added to the conventional pin type. Wiring can be done easily with a screwdriver.
- Compliant with UL, CSA, CE and LLOYD.

## Specifications

Item	Type	PM4H-W	
Rating	Rated operating voltage	100 to 240V AC, 48 to 125V DC, 12V DC, 24V AC/DC	
	Rated frequency	50/60Hz common (AC operating type)	
	Rated power consumption	Approx. 10VA (100 to 240V AC) Approx. 2.5VA (24V AC) Approx. 1.5W (12V DC, 24V DC, 48 to 125V DC)	
	Rated control capacity	5A 250V AC (resistive load)	
	Operation mode	Cyclic (OFF-start/Twin operation)	
Time accuracy Note:1)	Time range	1s to 500h 16 time ranges switchable (T <sub>1</sub> , T <sub>2</sub> time setting individually)	
	Operation time fluctuation	±0.3% (power off time change at the range of 0.3s to 1h)	
	Setting error	±5% (Full-scale value)	
	Voltage error	±0.5% (at the operating voltage changes between 85 to 110%)	
Contact	Temperature error	±2% (at 20°C ambient temp. at the range of -10 to +50°C +14 to 122°F)	
	Contact arrangement	Timed-out 2 Form C	
	Contact resistance (Initial value)	Max. 100mΩ (at 1A 6V DC)	
Life	Contact material	Silver alloy	
	Mechanical (contact)	2×10 <sup>7</sup>	
Electrical function	Electrical (contact)	10 <sup>5</sup> (at rated control capacity)	
	Allowable operating voltage range	85 to 110% of rated operating voltage (at 20°C coil temp.)	
	Insulation resistance (Initial value)	Min. 100MΩ (At 500V DC) Between live and dead metal parts Between input and output Between contacts of different poles Between contacts of same pole	
	Breakdown voltage (Initial value)	2,000Vrms for 1 min Between live and metal parts 2,000Vrms for 1 min Between input and output 2,000Vrms for 1 min Between contacts of different poles 1,000Vrms for 1 min Between contacts of same pole	
	Min. power off time	300ms	
Mechanical function	Max. temperature rise	55°C 131°F	
	Vibration resistance	Functional	10 to 55Hz: 1 cycle/min double amplitude of 0.25mm (10min on 3 axes)
		Destructive	10 to 55Hz: 1 cycle/min double amplitude of 0.375mm (1h on 3 axes)
	Shock resistance	Functional	Min. 98m/s <sup>2</sup> (4 times on 3 axes)
Destructive		Min. 980m/s <sup>2</sup> (5 times on 3 axes)	
Operating condition	Ambient temperature	-10 to +50°C +14 to +122°F	
	Ambient humidity	30 to 85%RH (non-condensing)	
	Atmospheric pressure	860 to 1,060hPa	
	Ripple factor (DC type)	20%	
Others	Protective construction	IP65 on front panel (using rubber gasket ATC18002) <only for IP65 type>	
	Weight	120g 4.233 oz (Pin type), 130g 4.586 oz (Screw terminal type)	

- Notes:
- 1) Unless otherwise specified, the measurement conditions at the maximum scale time standard are specified to be the rated operating voltage (within 5% ripple factor for DC), 20°C 68°F ambient temperature, and 1s power off time.
  - 2) For the 1s range, the tolerance for each specification becomes ±10ms.
  - 3) As internal components may become worn when using continuous conduction, the product should be replaced periodically.

# PM4H-W

## Time range

All types of PM4H-W timer have multi-time range.  
16 time ranges are selectable.  
1s to 500h (Max. range) is controlled.

Time unit		sec	min	hrs	10h
Scale					
1	Control time range	0.1s to 1s	0.1 min to 1 min	0.1h to 1h	1.0h to 10h
5		0.5s to 5s	0.5 min to 5 min	0.5h to 5h	5h to 50h
10		1.0s to 10s	1.0 min to 10 min	1.0h to 10h	10h to 100h
50		5s to 50s	5 min to 50 min	5h to 50h	50h to 500h

## Product types

Type	Operating mode	Contact arrangement	Time range	Protective structure	Rated Operating voltage	Terminal type	Part number	
PM4H-W Twin timer	Cyclic (OFF-start, Twin)	Relay Timed-out 2 Form C	16 selectable ranges (1s to 500h)	IP65	100 to 240V AC	8 pins	PM4HW-H-AC240VW	
						Screw terminal	PM4HW-H-AC240VSW	
						48 to 125V DC	8 pins	PM4HW-H-DC125VW
							Screw terminal	PM4HW-H-DC125VSW
					24V AC/DC	8 pins	PM4HW-H-24VW	
						Screw terminal	PM4HW-H-24VSW	
					12V DC	8 pins	PM4HW-H-DC12VW	
						Screw terminal	PM4HW-H-DC12VSW	
						100 to 240V AC	8 pins	PM4HW-H-AC240V
							Screw terminal	PM4HW-H-AC240VSW
					48 to 125V DC	8 pins	PM4HW-H-DC125V	
						Screw terminal	PM4HW-H-DC125VSW	
24V AC/DC	8 pins	PM4HW-H-24V						
	Screw terminal	PM4HW-H-24VSW						
12V DC	8 pins	PM4HW-H-DC12V						
	Screw terminal	PM4HW-H-DC12VSW						

## Terminal layouts and wiring diagrams

### Pin Type

Cyclic timed-out relay contact: 2C

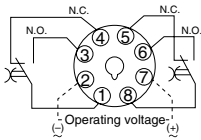

### Screw terminal type

Cyclic timed-out relay contact: 2C

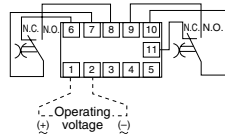

## Dimensions

• Screw terminal type: M3.5

• Pin type

mm inch  
Tolerance:  $\pm 0.5 \pm 0.020$

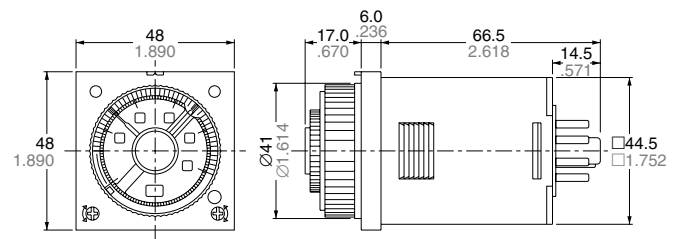
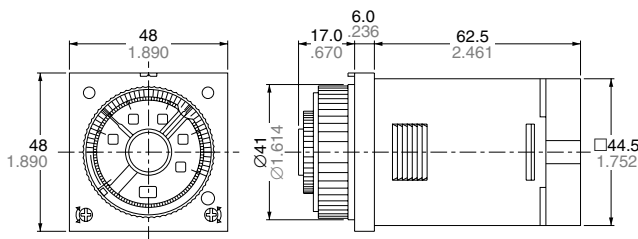

## Operation

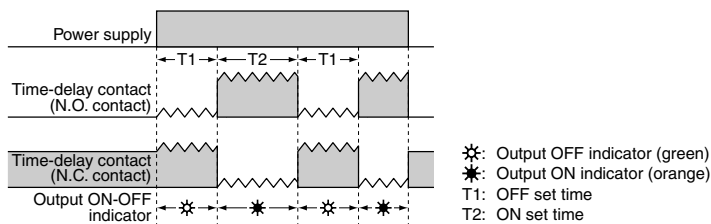

# PM4H SERIES MODES AND TIME SETTING

## 1. Operation method

### 1) Operation mode setting

#### [PM4H-A type]

8 operation modes are selectable with operation mode selector.

Turn the operation mode selector with screw driver.

Operation mode is shown up through the window above the mode selector. The marks are (ON), (L), (FO), (FI), (SF), (OS), (FZ), (OC).

Turn the mode selector to the mark until you can check by clicking sound.

Confirm the mode selector position if it is correct.

If the position is not stable, the timer might mis-operate.

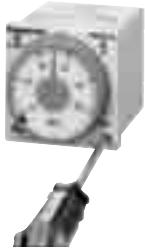

### 2) Time range setting

#### [PM4H series common]

16 time ranges are selectable between 1s to 500h.

Turn the time range selector with the screw driver.

Clockwise turning increases the time range, and Counter-clockwise turning decrease the time range.

Confirm the range selector position if it is correct.

If the position is not stable, the timer might mis-operate.

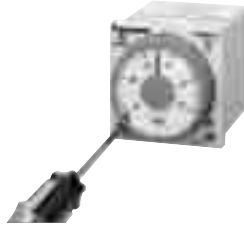

### 3) Time setting [common]

To set the time, turn the set dial to a desired time within the range.

Instantaneous output will be on when the dial is set to "0".

When the instantaneous output is used, the dial should be set under "0" range. (Instantaneous output area)

When power supply is on, the time range, setting time and operation mode cannot be changed.

Turn off the power supply or a reset signal is applied to set the new operation mode.

If the position is not stable, the timer might mis-operate.

If the position is not stable, the timer might mis-operate.

## 2. How to use "Set ring" [PM4H series common]

### 1) Fixed time setting

Set the desired time and put 2 set rings together.

Insert the rings into stopper to fix the time.

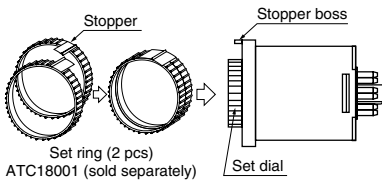

### 2) Time range setting

Example: Time range 20s to 30s.

#### ① Shorter time value setting

Set the dial to 20s.

Place the stop ring at the right side of stopper.

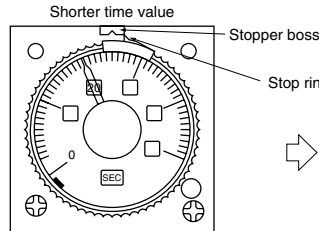

#### ② Longer time value setting

Set the dial to 30s.

Place the stop ring at the left side of stopper.

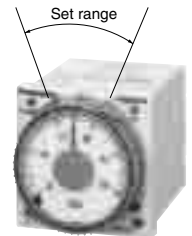
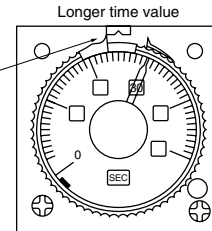

Note) The stoppers for the lower limit setting set ring and the upper limit setting set ring face the opposite directions.

## Applicable standard (PM4H series common)

Safety standard	EN61812-1	Pollution Degree 2/Overvoltage Category III
EMC	(EMI)EN61000-6-4 Radiation interference electric field strength	EN55011 Group1 ClassA EN55011 Group1 ClassA
	Noise terminal voltage (EMS)EN61000-6-2 Static discharge immunity	EN61000-4-2 4 kV contact 8 kV air
	RF electromagnetic field immunity	EN61000-4-3 10 V/m AM modulation (80 MHz to 1 GHz) 10 V/m pulse modulation (895 MHz to 905 MHz)
	EFT/B immunity	EN61000-4-4 2 kV (power supply line) 1 kV (signal line)
	Surge immunity	EN61000-4-5 1 kV (power line)
	Conductivity noise immunity	EN61000-4-6 10 V/m AM modulation (0.15 MHz to 80 MHz)
	Power frequency magnetic field immunity	EN61000-4-8 30 A/m (50 Hz)
Voltage dip/Instantaneous stop/Voltage fluctuation immunity	EN61000-4-11 10 ms, 30% (rated voltage) 100 ms, 60% (rated voltage) 1,000 ms, 60% (rated voltage) 5,000 ms, 95% (rated voltage)	

# PRECAUTIONS IN USING THE PM4H SERIES

## 1. Input connections (PM4H-A type)

1) Be sure not to use terminal ⑩ as the common terminal of the input signal as shown in Fig. A. Otherwise, the internal circuit of the timer may be damaged. Use terminal ② as the common terminal as shown in Fig. B.

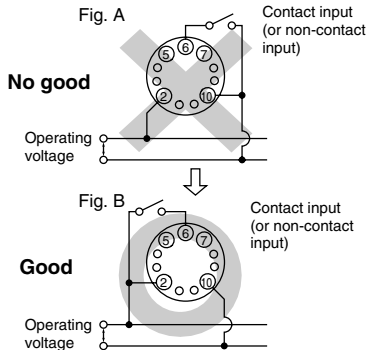

If the circuit is connected as in Fig. C, the internal circuits must be broken. Be sure to connect the circuit as in Fig. D.

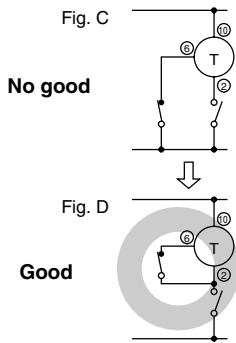

2) When one input signal is simultaneously applied to more than one timer, be sure to avoid the wiring shown in Fig. E. Otherwise, the short-circuit current will flow and cause damage. Be sure to align the polarity of the power supply as shown in Fig. F.

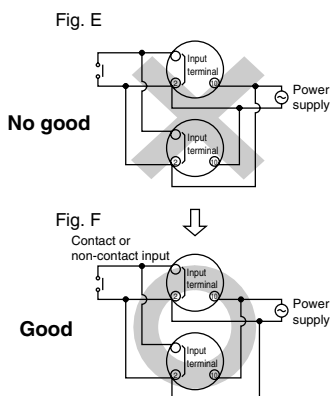

3) Terminal ②-⑥ (screw terminal ②-③) should be connected as the start input. Connect terminals ②-⑦ (screw terminal ②-④) for reset signal input. Connect terminals ②-⑤ (screw terminal ②-⑤) for stop signal input. Be sure not to connect with other terminals and apply excessive voltage. The internal circuit will be damaged.

4) The input wiring other than the power supply circuit should avoid these conditions, high-voltage wiring and parallel wiring with power wire. Wire in short with using the shielding wire or metal wiring tube.

5) For start, reset and stop input, use gold-plated contact with high reliability. Since contact bouncing causes errors in the start, use an input contact less bounce time.

6) Keep the minimum signal input time over 0.05 s.

## 2. Input signal conditions (PM4H-A type)

1) Connection of contact input (Pin type example)

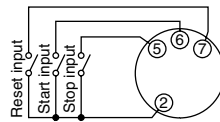

Use gold-plated contacts with high-reliability. The bounce time at the contacts causes errors in the timer operation time. Accordingly, use start input contact whose bounce time is short. The resistance when shorted should be less than 1k $\Omega$ , and when open resistance should be more than 100k $\Omega$ .

For the screw terminal type, connect the terminal ② to the each input signal.

2) Connection of non-contact input (Pin type example) (open-collector)

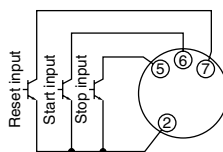

Apply the open-collector connection. The characteristics of the transistor used must be  $V_{CE0}=10V$  or more,  $I_C=10mA$  or more, and  $I_{CBO}=6\mu A$  or less. Additionally, the input impedance must be 1k $\Omega$  or less, and the residual voltage must be 0.6V or less.

For the screw terminal type, connect the terminal ② to the each input signal.

3) Connection of non-contact input (Pin type example) (voltage input)

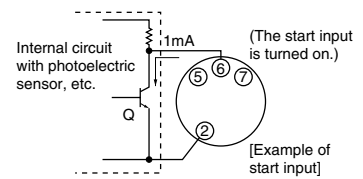

Even if the open collector is not used, input is also possible from the non-contact circuit of 6 to 30V DC. In this case, the start input is turned on when the signal is turned from H to L.

The residual voltage must be 0.6V or less when Q is on. On the AC type, an insulated transformer is required as the power supply for the photoelectric sensor, etc. (power supply for the input devices).

Note: Keep the minimum input signal time of each signal to 0.05s or more.

## 3. Checking the contacts before use (PM4H-F only)

When the power ON time is less than the minimum power application time, the contacts may remain in an ON state, so the state of the contacts should be checked before use. When the contacts are in an ON state, activating them once will return them to their normal state (the OFF state after time-out). (Be aware that relay characteristics may result in the contacts being in that same ON state if exposed to excessive vibration and impact during transport.)

## 4. Time setting

To set the time, turn the set dial to a desired time within the range.

Instantaneous output will be on when the dial is set to "0".

When the instantaneous output is used, the dial should be set under "0" range. (Instantaneous output area)

Note) When power supply is on, the time range, setting time and operation mode cannot be changed.

Turn off the power supply or a reset signal is applied to set the new operation mode.

If the position is not stable, the timer might mis-operate.

# PRECAUTIONS IN USING THE PM4H SERIES

## 5. Superimposed surge of power supply (PM4H series common)

For the superimposed surge of power supply, the standard waveform is taken as the standard value for surge-proof voltage.

If external surge occurs exceeding the specified value, the internal circuit may break down. In this case, use a surge

Operation voltage	Surge voltage
100 to 240V AC 100 to 120V AC 200 to 240V AC 48 to 125V DC	4,000V
12V DC, 24V DC 24V AC/DC	500V

absorption element.

The positive and negative voltages are applied each five times between the power pins.

The typical surge absorption elements include a varistor, a capacitor, and a diode. If a surge absorption element is used, use an oscilloscope to see whether or not the foreign surge exceeding the specified value appears.

## 6. Acquisition of CE marking

Please abide by the conditions below when using in applications that comply with EN61812-1.

- 1) Overvoltage category III, pollution level 2
- 2) This timer employs a power supply without a transformer, so the power and input signal terminals are not insulated. (PM4H-A only)
  - (1) When a sensor is connected to the input circuit, install double insulation on the sensor side.
  - (2) In the case of contact input, use dual-insulated relays, etc.
  - 3) The load connected to the output contact should have basic insulation. This timer is protected with basic insulation and can be double-insulated to meet EN/IEC requirements by using basic insulation on the load.
  - 4) Please use a power supply that is protected by an overcurrent protection device which complies with the EN/IEC standard (example: 250 V 1 A fuse, etc.).

- 5) You must use a terminal socket or socket for the installation. Do not touch the terminals or other parts of the timer when it is powered. When installing or un-installing, make sure that no voltage is being applied to any of the terminals.
- 6) Do not use this timer as a safety circuit. For example when using a timer in a heater circuit, etc., provide a protection circuit on the machine side.

**Panasonic**  
ideas for life

**DIN 24 SIZE  
MULTI-RANGE  
ANALOG TIMER**

**PM5S-A  
PM5S-S  
PM5S-M**

C-UL File No.: E59504 (Vol. 3)

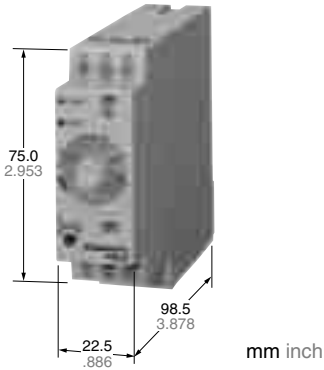

### Features

- 24-240V AC/DC free-voltage input
- Built-in Screw terminals
- 6 different operation modes: (PM5S-A)
- Multiple time ranges — 1 s to 500 h (Max.)
- Slim body — DIN 22.5 mm .886 inch
- 0 setting instantaneous output operation.
- UL/C-UL/CE approval.

Analog  
Timers

## Product types

Type	Operation mode	Contact arrangement	Time range	Protective construction	Rated operating voltage	Part number
PM5S-A	6 operation modes • Pulse ON-delay • Pulse Flicker • Pulse ON-flicker • Signal OFF-delay • Pulse One-shot • Pulse One-cycle	Relay Timed-out 2 Form C	16 selectable ranges 1s to 500h	IP40	24 to 240V AC/DC	PM5S-A-24-240V
PM5S-S	Power ON-delay	Relay Timed-out 2 Form C				PM5S-S-24-240V
PM5S-M	6 operation modes (With instantaneous contact) • Pulse ON-delay • Pulse Flicker • Pulse ON-flicker • Signal OFF-delay • Pulse One-shot • Pulse One-cycle	Relay Timed-out 1 Form C Instantaneous 1 Form C				PM5S-M-24-240V

Note: PM5S-M timer will be released soon.

## Time range

Scale	Time unit	Control time range			
		sec	min	hrs	10h
1	Control time range	0.1s to 1s	0.1 min to 1 min	0.1h to 1h	1.0h to 10h
5		0.5s to 5s	0.5 min to 5 min	0.5h to 5h	5h to 50h
10		1.0s to 10s	1.0 min to 10 min	1.0h to 10h	10h to 100h
50		5s to 50s	5 min to 50 min	5h to 50h	50h to 500h

Note: 0 setting is for instantaneous output operation.

PM5S-A/PM5S-S/PM5S-M  
All types of PM5S timer have multi-time range.  
16 time ranges are selectable.  
1s to 500h (Max. range) is controlled.

# PM5S-A/S/M

## Specifications

Analog Timers

Item	Type	PM5S-A	PM5S-S	PM5S-M
Rating	Rated operating voltage	24 to 240V AC/DC		
	Rated frequency	50/60Hz common		
	Rated power consumption	2.6 VA (AC), 1.4 W (DC)		
	Rated control capacity	5A 250V AC (resistive load)		
	Operating mode	Pulse ON-delay Pulse Flicker Pulse ON-Flicker Signal OFF-delay Pulse One-shot Pulse One-cycle	Power ON-delay	Pulse ON-delay Pulse Flicker Pulse ON-flicker Signal OFF-delay Pulse One-shot Pulse One-cycle (with instantaneous contact)
Time accuracy Note:1)	Time range	1s to 500h (Max.) 16 time ranges switchable		
	Operating time fluctuation	±0.3% (power off time change at the range of 0.1s to 1h)		
	Setting error	±10% (Full-scale value)		
	Voltage error	±0.5% (at the operating voltage changes between 85 to 110%)		
	Temperature error	±2% (at 20°C ambient temp. at the range of -10 to +55°C +14 to +131°F)		
Contact	Contact arrangement	Timed-out 2 Form C	Timed-out 1 Form C Instantaneous 1 Form C	
	Contact resistance (Initial value)	Max. 100mΩ (at 1A 6V DC)		
	Contact material	Silver alloy	Au flash on Silver alloy	
Life	Mechanical (contact)	2×10 <sup>7</sup>	1×10 <sup>7</sup>	
	Electrical (contact)	10 <sup>5</sup> (at rated control capacity)		
Electrical function	Allowable operating voltage range	85 to 110% of rated operating voltage (at 20°C coil temp.)		
	Insulation resistance (Initial value)	Min. 100MΩ	Between live and dead metal parts Between input and output Between contacts of different poles Between contacts of same pole	(At 500V DC)
	Breakdown voltage (Initial value)	2,000Vrms for 1 min Between live and dead metal parts 2,000Vrms for 1 min Between input and output 2,000Vrms for 1 min Between contacts of different poles 1,000Vrms for 1 min Between contacts of same pole		
	Min. power off time	100ms		
	Max. temperature rise	55°C 131°F	65°C 149°F	
Mechanical function	Shock resistance	Functional	Min. 98m/s <sup>2</sup> (4 times on 3 axes)	
		Destructive	Min. 980m/s <sup>2</sup> (5 times on 3 axes)	
	Vibration resistance	Functional	10 to 55Hz: 1 cycle/min Single amplitude of 0.35mm (10min on 3 axes)	
		Destructive	10 to 55Hz: 1 cycle/min Single amplitude of 0.75mm (1h on 3 axes)	
Operating condition	Ambient temperature	-10 to +55°C +14 to +131°F		
	Ambient humidity	Max. 85%RH (non-condensing)		
	Atmospheric pressure	860 to 1,060hPa		
	Ripple factor (DC)	20%		
Others	Protective construction	IP40		
	Weight	120g 4.233 oz		

Note: 1) Unless otherwise specified, the measurement conditions at the maximum scale time standard are specified to be the rated operating voltage (within 5% ripple factor for DC), 20°C 68°F ambient temperature, and 1s power off time.  
2) For the 1s range, the tolerance for each specification becomes ±10ms.

## Terminal layouts and wiring diagrams

### PM5S-A

- Timed-out 2 Form C

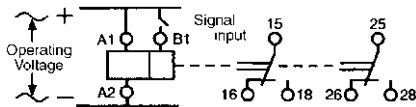

### PM5S-S

- Timed-out 2 Form C

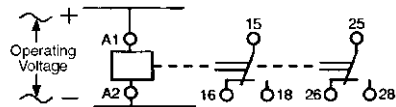

### PM5S-M

- Timed-out 1 Form C
- Instantaneous 1 Form C

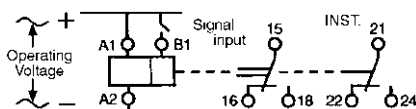

### Contact

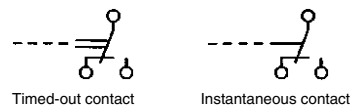



# PM5S-A/S/M

## Mode selection PM5S-A/M type

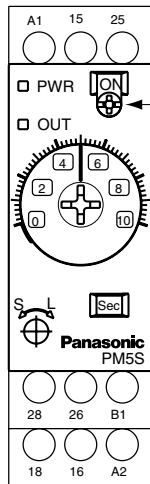

- Operation mode indicator  
Selectable from 8 operation modes
- ON: ON-delay
  - FL: Flicker
  - FO: ON-flicker
  - SF: Signal OFF-delay
  - OS: Pulse One-shot
  - OC: Pulse One-cycle

The 6 operation modes of PM5S-A and PM5S-M can be selected by the operation mode selector switch. In the next pages the different modes will be explained.

## Dimensions PM5S-□

mm inch

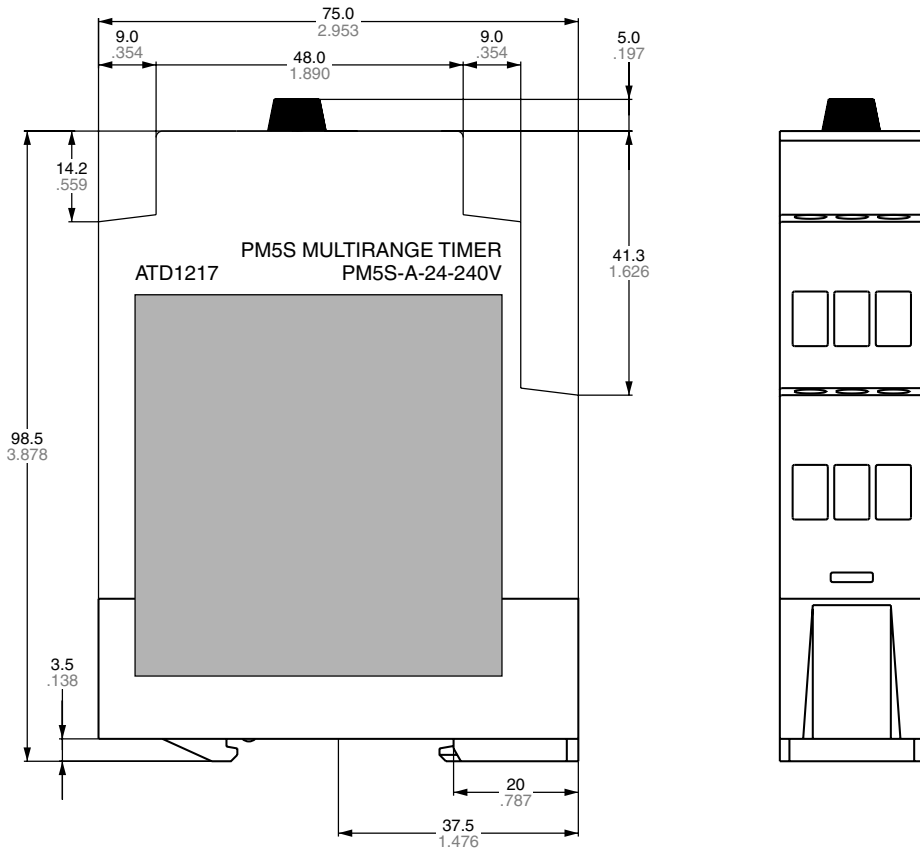
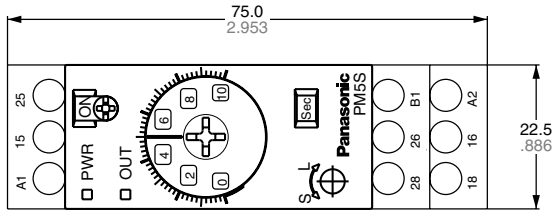







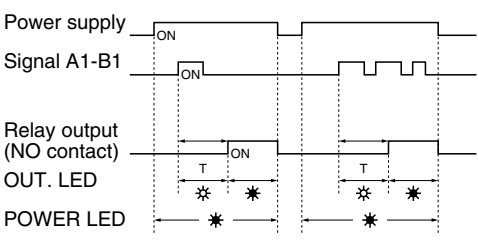

# PM5S-A/S/M

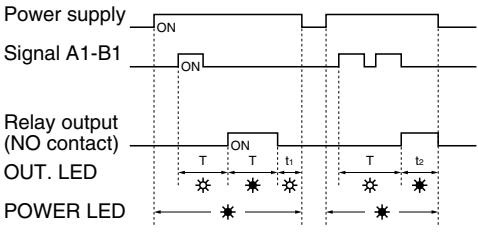
## Operation mode

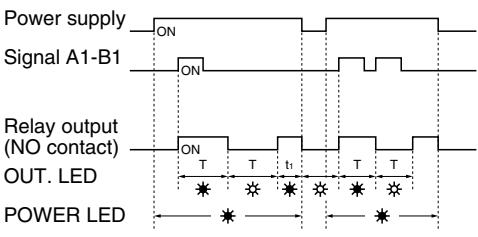

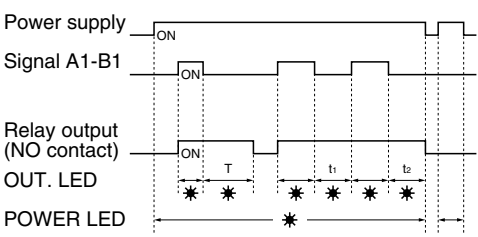
### PM5S-A/M

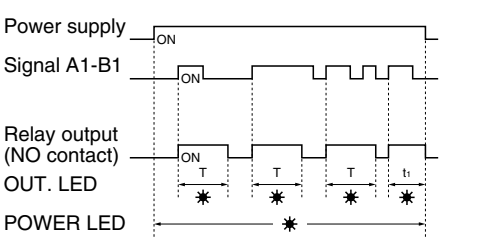
(\* LED lighting \* LED flickering)  
T: Setting time  $t_1, t_2 < T$

Operation type	Operation	Time chart
<b>ON-delay</b> 	Turn the operation selector to <b>ON</b> . Timing operation starts when terminals A1 – B1 are connected while power is on. Control output is turned on after the set time regardless of duration of operation signal	
<b>Flicker</b> 	Turn the operation selector to <b>FL</b> . Timing operation starts when terminals A1 – B1 are connected while power is on. Control output repeatedly turn OFF and ON regardless of operation signal input time.	
<b>ON-flicker</b> 	Turn the operation selector to <b>FO</b> . Timing operation starts when terminals A1 – B1 are connected while power is on. Control output repeatedly turns ON and OFF regardless of operation signal input time.	
<b>Signal OFF-delay</b> 	Turn the operation selector to <b>SF</b> . Timing operation starts when terminals A1 – B1 are opened while power is on. Control output is turned off after the set time. If the signal input turns OFF during timing operation, the timing operation starts at that point again.	
<b>One-shot</b> 	Turn the operation selector to <b>OS</b> . Timing operation starts when terminals A1 – B1 are connected while power is ON. Control output continues ON state while timing operation.	

Note: Keep 0.1s or more for power off time.  
Keep 0.05s or more for signal, input time.

# PM5S-A/S/M

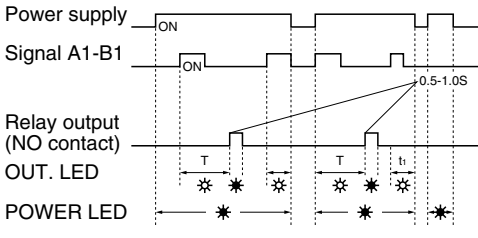
Operation type	Operation	Time chart
<b>One-cycle</b> 	Turn the operation selector to  . Timing operation starts when terminals A1 – B1 are connected while power is ON. Control output is turned on after the set time, the pulse is 0.5 to 1.0 s.	

Note: Keep 0.1s or more for power off time.  
 Keep 0.05s or more for signal, input time.





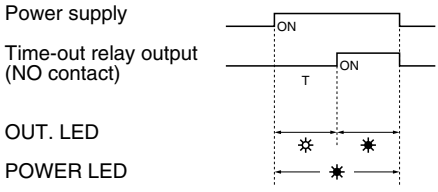

(\* LED lighting \* LED flickering)  
 T: Setting time

## PM5S-S

Operation type	Operation	Time chart
<b>Power ON-delay</b>	When power is applied continuously, the time cycle begins. The output contacts change state after the time delay is completed.	

## Modes and time setting

### 1) Operation mode setting [PM5S-A]

6 operation modes are selectable with operation mode selector.  
 Turn the operation mode selector with screw driver.  
 Operation mode is shown up through the window above the mode selector. The marks are , , , , , . Turn the mode selector to the mark until you can check by clicking sound.  
 Confirm the mode selector position if it is correct.  
 If the position is not stable, the timer might mis-operate.

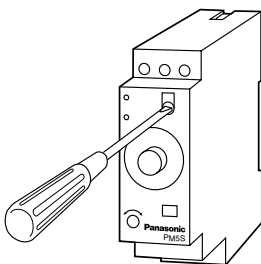

### 2) Time setting [common]

16 time ranges are selectable between 1s to 500h.  
 Turn the time range selector with the screw driver.  
 Clockwise turning increases the time range, and Counter-clockwise turning decrease the time range.  
 Confirm the range selector position if it is correct.

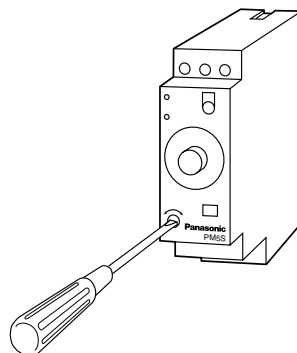

### 3) Time setting [common]

To set the time, turn the set dial to a desired time within the range.  
 Instantaneous output will be on when the dial is set to "0".  
 When the instantaneous output is used, the dial should be set under "0" range. (Instantaneous output area)  
 When power supply is on, the time range, setting time and operation mode cannot be changed.  
 Turn off the power supply is applied to set the new operation mode.  
 To set the time in the range, turn the dial to a desired time scale. Do not turn the dial beyond the stopper.

#### • Cautions for Time setting/Operating mode setting

- 1) Time chart
  - T shots setting time, t1 and t2 means the time in setting time. (t1, t2<T)
  - When the output relay is turned on, No contact is closed and NC contact is opened.
  - LED indication \* shows "Turn ON"
- 2) Timing operation starts when power is applied to terminals A1 – B1  
 Input signal time should be taken over 0.05 sec.  
 Short-circuited condition: Max. 1kΩ  
 Open-circuited condition: Min. 100kΩ

# PM5S-A/S/M

## Input connections

The inputs of the PM5S-A/M are voltage (voltage imposition or open) inputs.

No-contact input

(Connection to PNP output sensor.)

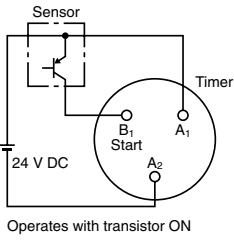

Contact input

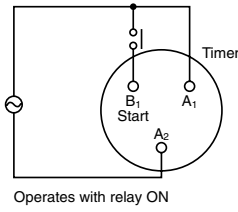

## Voltage Input Signal Levels

No-contact input	1. Transistor ON Residual voltage: 1 V max. (Voltage between terminals B <sub>1</sub> and A <sub>2</sub> must be more than the rated "H-level" voltage (20.4 V DC min.).)
	2. Transistor OFF Leakage current: 0.01 mA max. (Voltage between terminals B <sub>1</sub> and A <sub>2</sub> must be less than the rated "L-level" voltage (2.5 V DC max.).)
Contact input	Use contacts that can adequately switch 0.1 mA at each voltage to be imposed. (When the contacts are ON or OFF, voltage between terminals B <sub>1</sub> and A <sub>2</sub> must be within the following ranges: When contacts are ON: 20.4 to 264 V AC/DC When contacts are OFF: 0 to 2.5 V AC/DC)

## Mounting and dismounting

The PM5S should be mounted as horizontally as possible. When mounting the PM5S on a socket mounting track, hook portion (A) of the Timer to an edge of the track first, and then depress the Timer in the direction of (B).

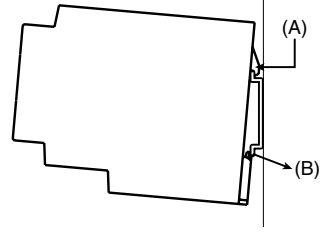

When dismounting the PM5S pull out portion (C) with a flat-blade screwdriver and remove the Timer from the mounting track.

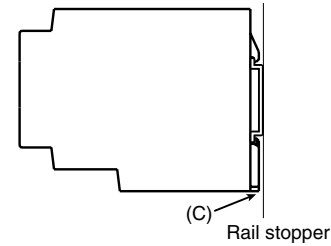

## Cautions for use

### Cautions

1) Prevent using the timer in such places where flammable or corrosive gas is generated, a lot of dust exists, oil is splashed or considerable shock and vibration occur.

2) Since the body cover is consisted of polycarbonate resin, prevent from contact with organic solvents such as methyl alcohol, benzine and thinner, or strong alkali materials such as ammonia and caustic soda.

## Power supplies

The PM5S Series is provided with a transformerless power supply system. An electric shock may be received if the input terminal or the output type selector switch is touched while power is being supplied. Use the bar terminal for wiring the PM5S. Using a stranded-wire terminal may cause a short-circuit due to a stray wire entering into the Timer.

For the power supply of the input device, use a single-phase or double-phase insulated power transformer. The second-phase side must not be grounded.

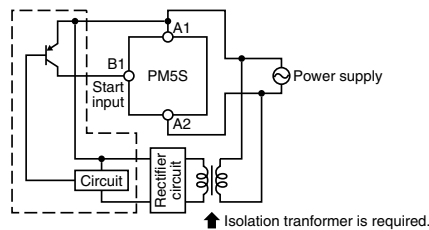

• Input and Power supply circuit (PM5S-A/M)

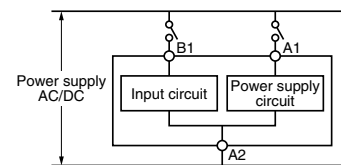

• Since input circuit and power supply circuit is independent, it is possible to switch ON and OFF for input circuit regardless power ON and OFF. Note that the contact of input circuit is given same voltage as power voltage.

## Terminal connections

- Refer to the terminal layout and wiring diagram and securely connect the terminals accordingly.
- Do not allow control output to exceed rated control capacity.

1. When one input signal is simultaneously applied to more than one timer, be sure to avoid the wiring shown in Fig. A. Otherwise, the short-circuit current will flow and cause damage. Be sure to align the polarity of the power supply as shown in Fig. B.

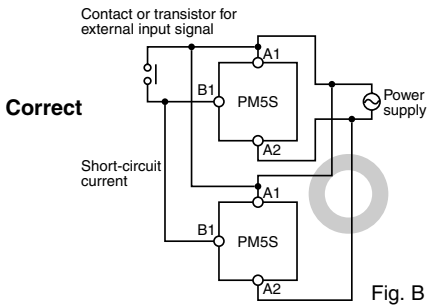
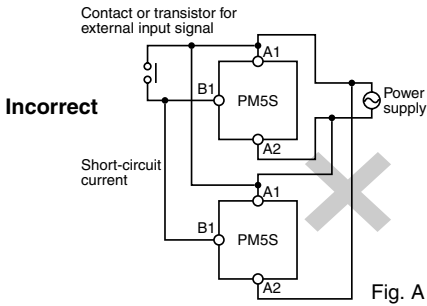

The PM5S series is provided with a transformer less power supply system.

2. External surge protection may be required if the following values are exceeded. Otherwise, the internal circuit will be damaged.

Operating voltage	24 to 240 V AC
Surge voltage	4,000 V

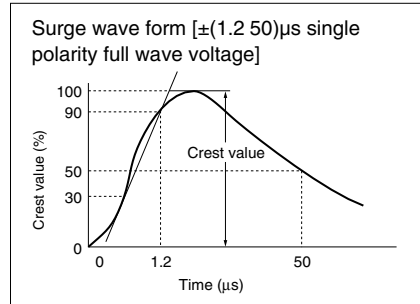

3. For connecting and disconnecting operating voltage to the timer, a circuit should be used to prevent the flow of leakage current. For example, a circuit for contact protection as shown in Fig. C will permit leakage current to flow through R and C, causing erroneous operation of the timer. Instead, the circuit shown in Fig. D should be used.

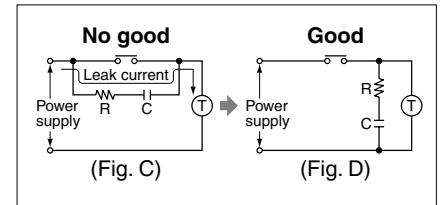

4. In order to maintain the characteristics of the timer, long continuous current flow through the timer, causing generation of heat internally should be avoided because of the degradation it can cause. For such long continuous operation, the circuit shown below should be used.

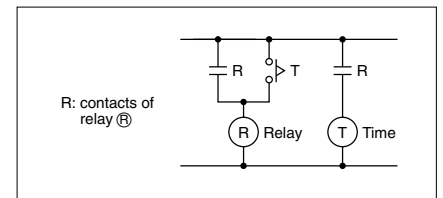

# INSTALLING DIN SIZE TIMER

## Installations

### 1. Surface mount

1) For the timers of PM4H and LT4H series, use the pin type timer. With the PM4S and QM4H series, only pin-type timers are available.

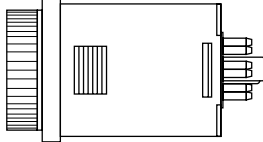

- 2) Put the terminal socket on the board directly or put it on the DIN rail (Fig. 1).
- 3) Insert the timer into the terminal socket and fix it with clip (Fig. 2)
- 4) On DIN rail mounting, mount the timer on the DIN rail tightly to get the proper dimension (Fig. 3).

(Fig. 1)

(Fig. 2)

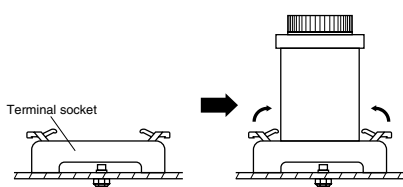

(Fig. 3)

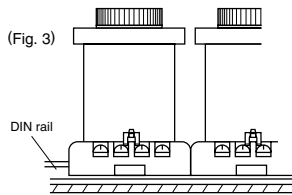

5) 8-pin type should be connected with terminal socket (AT8-DF8K). 11-pin type should be connected with terminal socket (AT8-DF11K).

6) DIN rail (AT8-DLA1) is also available (1 m).

### 2. Flush mount

1) For the timers of PM4H and LT4H series, it is recommended to use the built-in screw terminal type for flush mount. (Mounting frame and rubber gasket are provided when timer is shipped.)

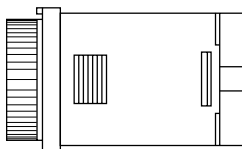

If the pin type is used, the mounting frame (AT8-DA4) and rubber gasket (ATC18002 for surface waterproofing) that are available at extra costs are necessary. If the pin connection socket is the 8-pin type, use the 8P cap (AD8-RC); or if it is the 11-pin type, use the 11P cap (AT8-DP11).

2) How to mount the timer  
From the panel front, pass the timer through the square hole. Fit the mounting frame from the rear, and then push it in so that the clearance between the mounting frame and the panel surface is minimized. In addition, lock the mounting frame with a screw.

#### • Screw terminal type

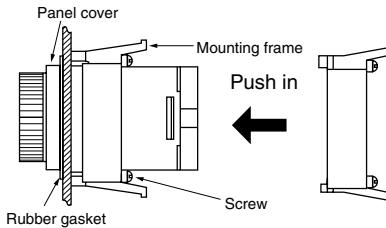

#### • Pin type

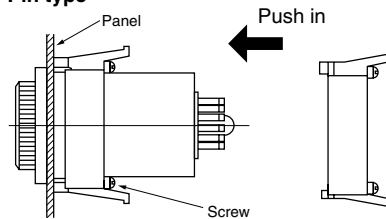

3) Caution in mounting the timer

#### • PM4H, and LT4H series

Ⓐ If the PM4H and the LT4H series are used as the waterproof types, tighten the reinforcing screws on the mounting frames so that the timers, the rubber gaskets, and the panel surfaces are tightly contacted with each other. (Tighten the two screws with uniform force and make sure that there is no rattling. If the screws are tightened too excessively, the mounting frame may come off.)

Ⓑ If the timer is installed with the panel cover and the rubber gasket removed, the waterproofing characteristic is lost.

4) Installation  
Loosen the screws on the mounting frame, spread the edge of frame and remove it.

4) Installation

Loosen the screws on the mounting frame, spread the edge of frame and remove it.

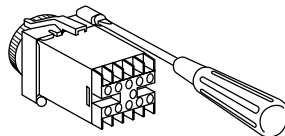

Pull the mounting frame backward while spreading out its hooks with your thumbs and index fingers.

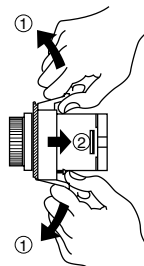

5) Correctly connect the pins while seeing the pin connection diagram.

Tighten the terminal screws with a torque of 0.8 N-cm or less. The screws are M3.5. (screw-tightened terminal type)

6) If the pin type is used, the rear terminal block (ATC78041) or the 8P cap (AD8-RC) is necessary to connect the pins. For the 11-pin type, use the rear terminal block (ATC78051) or the 11P cap (AT8-DP11) and avoid directly soldering the round pins on the timer.

7) Panel cutout dimensions

The standard panel cutout dimensions are shown in the left figure (Panel thickness: 1 to mm .039 to .197 inch)

8) Although the timers can be mounted adjacent to each other in this case, it is recommended to arrange the mounting holes as shown in the right figure to facilitate attaching and detaching the mounting frame.

9) Adjacent mounting  
Although the timers can be mounted adjacent to each other, remember that the panel surface of PM4H or LT4H series timer will lose its waterproof-resistant effect. (Panel thickness: 1 to 5 mm .039 to .197 inch)

$$A = (48 \times n - 2.5) \pm 0.6 \text{ (mm)}$$

When lining up the timers horizontally, set the frames in such a position so the formed spring areas are at the top and bottom. When lining up the timers vertically, set the frames in such a position so the formed spring areas are at the right and left.

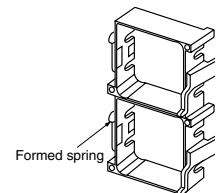
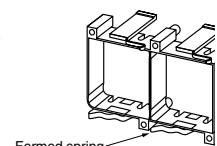
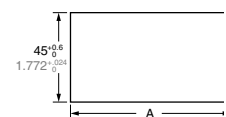
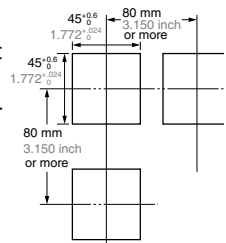



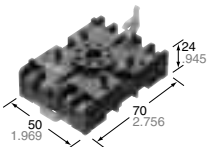
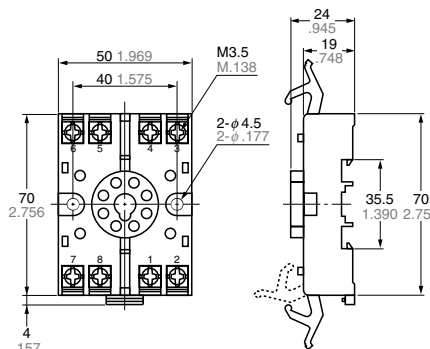
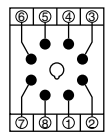
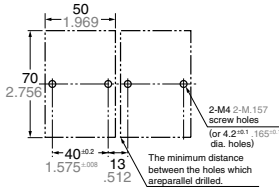
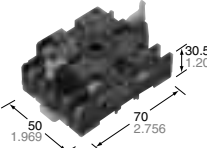
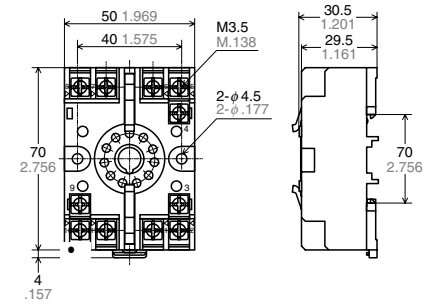
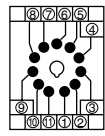
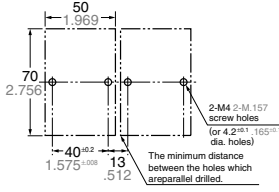

# DIN SIZE TIMERS COMMON OPTIONS

## Terminal sockets (Unit: mm inch, Tolerance: $\pm 1 \pm .039$ )

Type	Appearance	Dimensions	Terminal wiring (Top view)	Mounting hole dimensions
PM4H-S PM4H-M PM4H-SD PM4H-F8 PM4H-F8R PM4H-W LT4H LT4H-W QM4H (8-pin type)	<ul style="list-style-type: none"> <li>• DIN rail socket (8-pin)</li> </ul>  <p>ATC180031</p>		 <p>Note: Terminal No. on the main body are identical to those on the terminal socket.</p>	
PM4H-A PM4H-F11R LT4H LT4H-W (11-pin type)	<ul style="list-style-type: none"> <li>• DIN rail socket (11-pin)</li> </ul>  <p>ATC180041</p>		 <p>Note: Terminal No. on the main body are identical to those on the terminal socket.</p>	

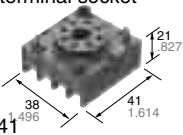
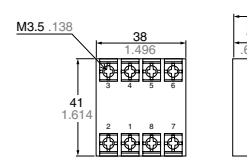
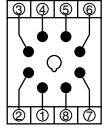
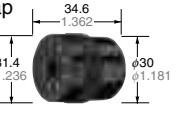
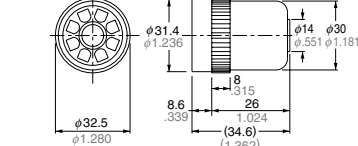
Note: The socket's numbering system matches that of the timer terminals.

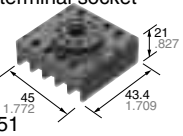
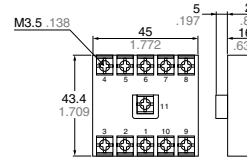
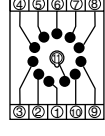
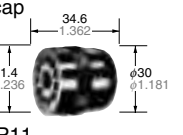
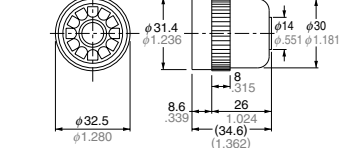
## Sockets (Unit: mm inch, Tolerance: $\pm 1 \pm .039$ )

Type	Appearance	Dimensions	Terminal wiring (Top view)	Mounting hole dimensions
PM4H-S PM4H-M PM4H-SD PM4H-F8 PM4H-F8R PM4H-W LT4H LT4H-W (8-pin type) QM4H	<ul style="list-style-type: none"> <li>• Rear terminal socket</li> </ul>  <p>AT78041</p>			—
PM4H-W LT4H LT4H-W (8-pin type) QM4H	<ul style="list-style-type: none"> <li>• 8P cap</li> </ul>  <p>AD8-RC</p>			—
PM4H-A PM4H-F11R LT4H LT4H-W (11-pin type)	<ul style="list-style-type: none"> <li>• Rear terminal socket</li> </ul>  <p>AT78051</p>			—
PM4H-W LT4H LT4H-W (11-pin type)	<ul style="list-style-type: none"> <li>• 11P cap</li> </ul>  <p>AT8-DP11</p>			—

Note: The terminal socket's numbering system matches that of the timer terminals.

# DIN SIZE TIMERS COMMON OPTIONS

## • Rubber gasket

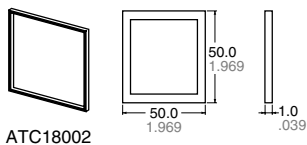

Applicable for PM4H series and LT4H series

The rubber gasket is enclosed in the PM4H (screw terminal type) and the LT4H series.

## • Mounting frame

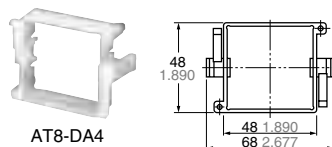

Applicable for PM4H series LT4H series and QM4H series

## • Mounting rails (Applicable for DIN and IEC standards)



AT8-DLA1  
Length: 1 m  
aluminum

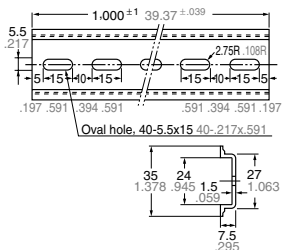

## • Fastening plate



ATA4806

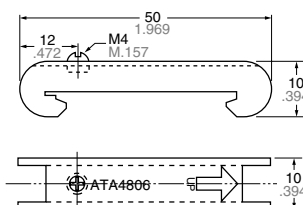

For holding DIN rails

## • Protective cover for DIN 48 size: LT4H, QM4H series

Flexible type

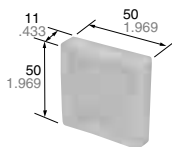

AQM4803

## • Protective cover for DIN 48 size: QM4H series

Hard type

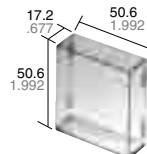

AQM4801

## Accessories

### PM4H series

#### • Panel cover (Black)

PM4H-A



ATC18011

PM4H-S



ATC18012

PM4H-M



ATC18013

PM4H-W



ATC18014

PM4H-SD



ATC18015

PM4H-F



ATC18016

### LT4H series

#### • Panel cover (Black)

LT4H



ATL58011

LT4H-W



ATL68011

The black panel cover is also available so that you can change the appearance of the panel by changing the panel cover. The color of the standard panel cover is ash gray.

## • Set ring

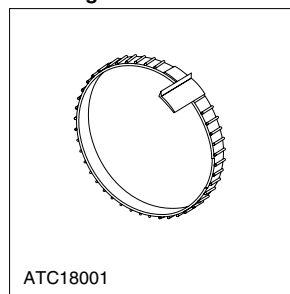

ATC18001

When you control the fixed time range, the setting rings (a set of 2 pcs.) make it easy to do the time setting and keep the time range all the time. (Excluding PM4H-W)



# S1DXM-A/M/S1DX COMMON OPTIONS

## Accessories Note: Accessories are the same as those for the S1DX timer.

- Mounting frame



ADX18002 (Titanium-gray)  
ADX18006 (Gray)  
ADX18007 (Black)

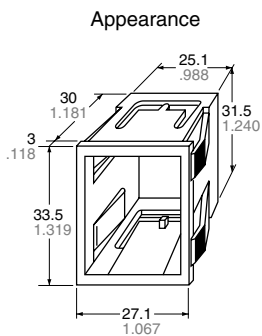

### Panel cutout dimensions

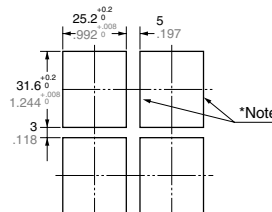

Board thickness 1 to 3 mm  
Note: Make sure the holes area stays as right angles.

- Protective cover

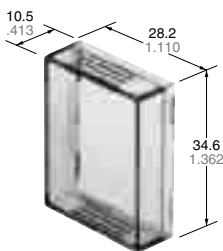

ADX18008

- Cap block

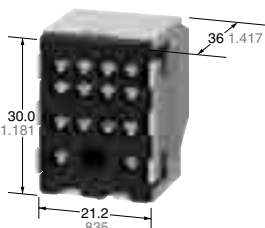

ADX18011

- Cap



ADX18004

- Socket

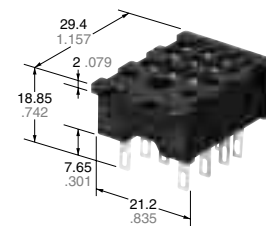

ADX18003

## Terminal socket

- HC2 slim DIN terminal socket

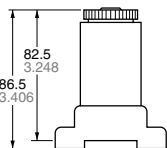

HC2-SFD-S

- HC2 DIN high terminal socket

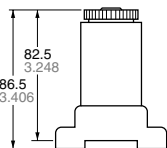

HC2-SFD-K

- HC4 DIN high terminal socket

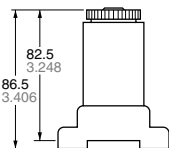

HC4-SFD-K

- HC4 socket

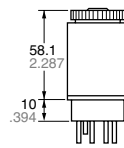

HC4-SS-K

- HJ2 terminal socket

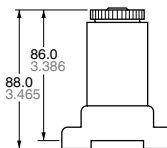

HJ2-SFD/HJ2-SFD-S

- HJ4 terminal socket

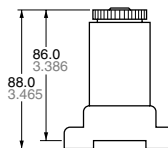

HJ4-SFD/HJ4-SFD-S

## Socket leaf holding clip

18012		AD68002	
Figure	Dimensions	Figure	Dimensions
(2 pieces per set)		(2 pieces per set)	

## Socket line holding clip for S1DXM-A/M

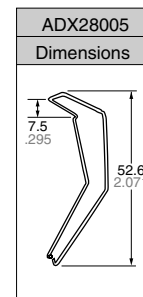







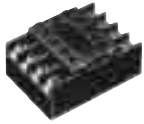
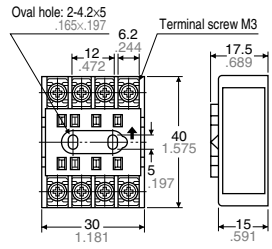

Terminal socket	Type	Application			
		ADX18001	ADX18012	AD68002	ADX28005
For HC relay	HC2-SFD-S	—	—	○	○
	HC2-SFD-K	○	—	△	○
	HC4-SFD-K	○	—	△	○
For HJ relay	HJ2-SFD	—	○	—	—
	HJ2-SFD-S	—	○	—	—
	HJ4-SFD	—	△	—	—
	HJ4-SFD-S	—	△	—	—

Note: The triangles indicate that removal will be slightly difficult when installed laterally in succession.

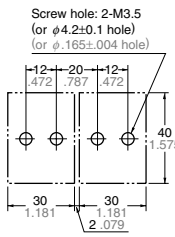
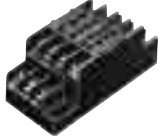
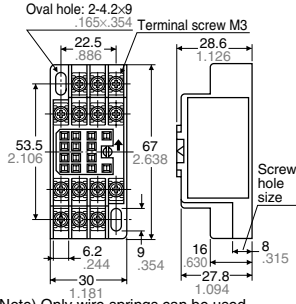
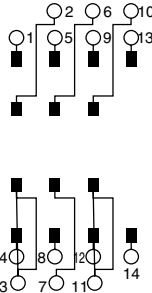
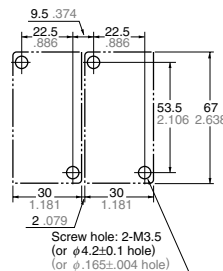
# S1DX TIMER OPTIONS

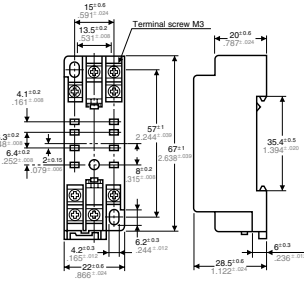
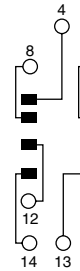
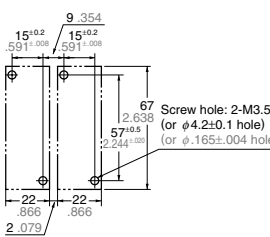

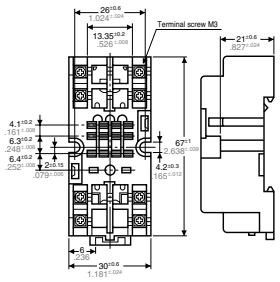
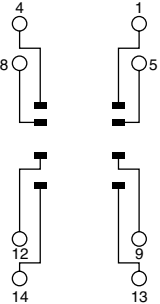
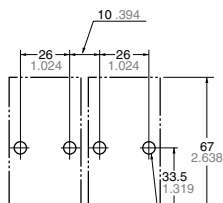

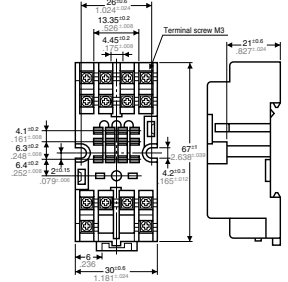
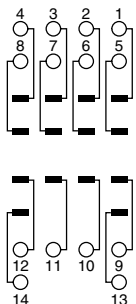
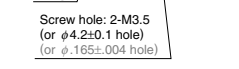

## HC relay terminal sockets

Options and Accessories Timers

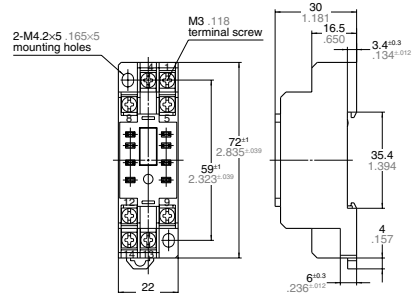
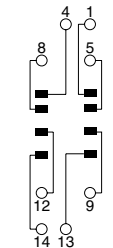
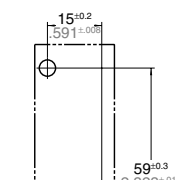
	Name/Part No.	Dimensions	Terminal layout	Mounting hole dimensions	Applicable timers	
					S1DX(2c) S1DXM(2c)	S1DX(4c) S1DXM(4c)
For general rails	<ul style="list-style-type: none"> <li>Terminal socket, HC 2-pin</li> </ul>  <p>HC2-SF-K</p>	 <p>Note) Only wire springs can be used. (Plate springs cannot be used.)</p>		 <p>Drilling size of panel holes for installing the terminal sockets parallel</p>	Available	Not available
	<ul style="list-style-type: none"> <li>High terminal socket, HC 1-, 2- and 4-pin</li> </ul>  <p>HC4-HSF-K</p>	 <p>Note) Only wire springs can be used. (Plate springs cannot be used.)</p>		 <p>Drilling size of panel holes for installing the terminal sockets parallel</p>	Available	Available
For DIN rails	<ul style="list-style-type: none"> <li>Slim DIN terminal socket, HC2</li> </ul>  <p>HC2-SFD-S</p>			 <p>Drilling size of panel holes for installing the terminal sockets parallel</p>	Available	Not available
	<ul style="list-style-type: none"> <li>DIN high terminal socket, HC2</li> </ul>  <p>HC2-SFD-K</p>				Available	Not available
	<ul style="list-style-type: none"> <li>DIN high terminal socket, HC4</li> </ul>  <p>HC4-SFD-K</p>			 <p>Drilling size of panel holes for installing the terminal sockets parallel</p>	Available	Available

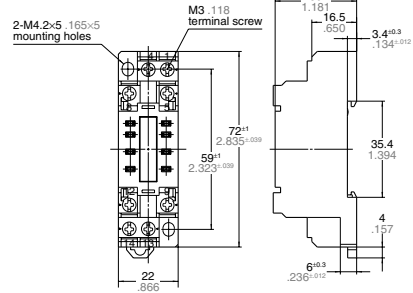
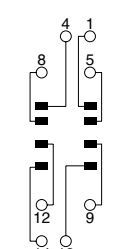
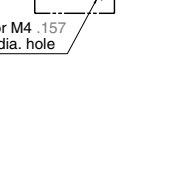
# S1DXM-A/M/S1DX COMMON OPTIONS

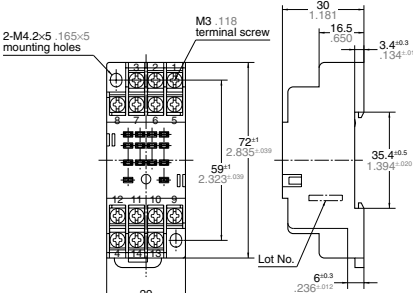
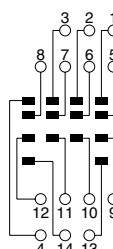
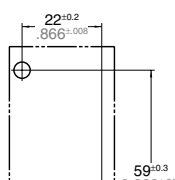

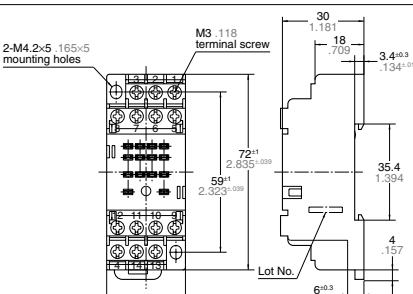
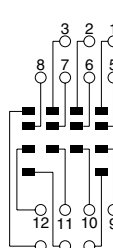
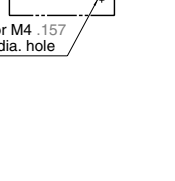
## HJ relay terminal sockets

Name/Part No.	Dimensions	Terminal layout	Mounting hole dimensions	Applicable timers	
				S1DX(2c) S1DXM(2c)	S1DX(4c) S1DXM(4c)
<ul style="list-style-type: none"> <li>HJ2 terminal socket</li> </ul>  <p>HJ2-SFD</p>				Available	Not available
<ul style="list-style-type: none"> <li>HJ2 terminal socket (Finger protect type)</li> </ul>  <p>HJ2-SFD-S</p>			 <p>2-M3 .118 or M4 .157 or 4.5 .177 dia. hole</p>	Available	Not available
<ul style="list-style-type: none"> <li>HJ4 terminal socket</li> </ul>  <p>HJ4-SFD</p>				Available	Available
<ul style="list-style-type: none"> <li>HJ4 terminal socket (Finger protect type)</li> </ul>  <p>HJ4-SFD-S</p>			 <p>2-M3 .118 or M4 .157 or 4.5 .177 dia. hole</p>	Available	Available

Options and Accessories Timers



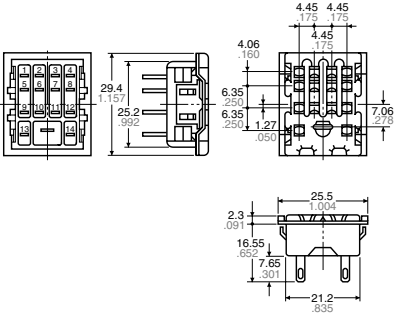
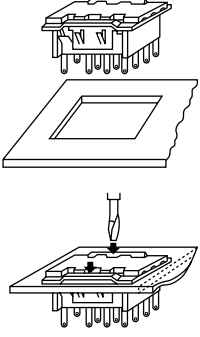

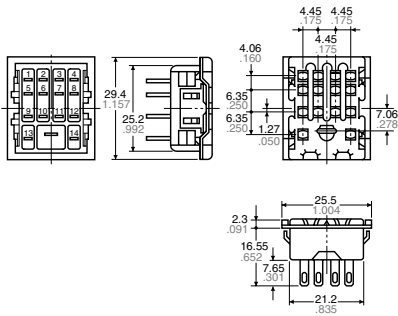
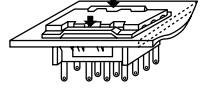
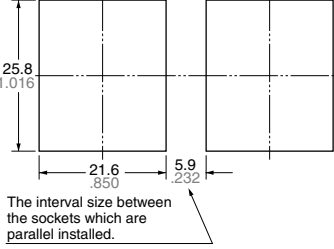









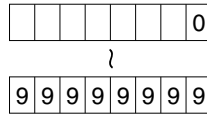
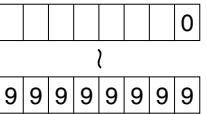
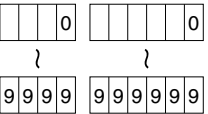
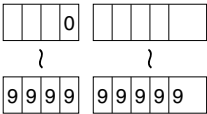
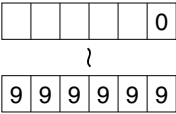

# S1DXM-A/M/S1DX COMMON OPTIONS

## Sockets

Name/Order No.	Dimensions	Mounting hole dimensions	Applicable timers	
			S1DX(2c) S1DXM(2c)	S1DX(4c) S1DXM(4c)
<ul style="list-style-type: none"> <li>Socket, HC 2-pin</li> </ul>  <p>HC2-SS-K</p>	<ul style="list-style-type: none"> <li>The difference between the HC2 and HC4 sockets is only the number of the pins. Their appearances and sizes are the same.</li> </ul> 	<ul style="list-style-type: none"> <li>The thickness of applicable chassis plates ranges from 1.0 to 2.0 mm.</li> <li>To install the socket easily, insert the socket top surface into the drilled holes and press the two points on the socket indicated by arrows as shown in the fig. below.</li> </ul> 	Available	Not available
<ul style="list-style-type: none"> <li>Socket, HC 4-pin</li> </ul>  <p>HC4-SS-K</p>	<p>General tolerance: <math>\pm 0.5</math></p> 	  <p>The interval size between the sockets which are parallel installed.</p> <p>Dimensional tolerance of machining: <math>\pm 0.1 \pm .004</math></p>	Available	Available

- Sockets for PC board
  - HC2 – Socket for PC board: AP3825K
  - HC4 – Socket for PC board: AP3845K

# COUNTERS SELECTOR CHART

		Electronic counters				
Appearance	 Flush mounting type  PC board mounting type AEL3	 AEL3	 4-digit display  6-digit display	 4-digit display  6-digit display		
Name of product	<b>LC2H Counter</b>	<b>LC2H Counter</b>	<b>LC4H Counter</b>	<b>LC4H-S Counter</b>	<b>LC4H-W Counter</b>	
Type	Total counter	Preset counter	Preset counter	Preset counter	Preset counter	
Input mode/Input method	UP type	UP, DOWN type	UP, DOWN, and DIR (multi-mode)/DIP switch	UP, DOWN, and DIR (multi-mode)/DIP switch	UP, DOWN, and DIR (multi-mode) 2 modes selectable/DIP switch	
Features	8.7 mm tall 8-digit display Bright 2-color back light	8.7 mm tall 8-digit display Preset function equipped in half size Display has backlight for instant recognition	Bright and easy-to-read display Simple operation Short body Conforms to IP66's weather resistant standards	Bright and easy-to-read display Simple operation Pre-scale function Built-in power supply for high-capacity sensor (100 to 240 V AC type) Conforms to IP66's weather resistant standards	Bright and easy-to-read display Simple operation Upper and lower limit settings are available. Conforms to IP66's weather resistant standards	
Rated operating voltage	Flush mounting type: Unnecessary (Built-in battery) PC board mounting type: 3 V DC (Battery in externally installed)	24 V DC	100 to 240 V AC 24 V AC, 12 to 24 V DC	100 to 240 V AC	100 to 240 V AC 24 V AC 12 to 24 V DC	
Number of digits (counter capacity)	8-digit 	8-digit 	4-digit 6-digit 	4-digit 6-digit 	6-digit 	
Counter/Indication	Zero-suppress function (LCD)	Zero-suppress function (LCD)	7-segment LCD Counter value (backlight red LED) Setting value (backlight yellow LED)	7-segment LCD Counter value (backlight red LED) Setting value (backlight yellow LED)	7-segment LCD Counter value (backlight red LED) Setting value (backlight yellow LED)	
Counting speed	Flush mounting type: 2kHz/30Hz (Changeable by a switch) PC board mounting type: 2kHz/30Hz (Different type)	30Hz/5kHz switchable	30Hz/5kHz	30Hz/5kHz	30Hz/5kHz	
Input	Counting (signal) input and reset input • Input by short-circuiting or opening contacts • Open collector input • Voltage input	Counting (signal) input and reset input • Input by short-circuiting or opening contacts • Open collector input	2-input (multi-mode) and reset input • Input by short-circuiting or opening contacts. • Open collector input	2-input (multi-mode) and reset input • Input by short-circuiting or opening contacts. • Open collector input	2-input (multi-mode) and reset input • Input by short-circuiting or opening contacts. • Open collector input	
Reset (Reset input specifications conform to those of counting input)	• Front reset button and external reset input terminal • External reset dip terminal	• Manual reset with and external terminal and front reset key • Manual reset types inside one-short output models	• Manual reset with and external terminal and front reset key • Manual reset types inside one-short output models	• Manual reset with and external terminal and front reset key • Manual reset types inside one-short output models	• Manual reset with and external terminal and front reset key • Manual reset types inside one-short output models	
Preset	—	• Counter number setting with key switches	• Operation mode setting with dip switches • Counter number setting with key switches	• Operation mode setting with dip switches • Counter number setting with key switches	• Output mode setting with dip switches • Counter number setting with key switches	
Control output	—		 or 	 or 	 or 	
Power supply output	—	—	—	External power supply 12 V DC 100 mA max. (AC type only)	—	
Options	Flush mounting type (No need for easy installation type) Mounting frame, rubber gasket	Mounting frame, rubber gasket	11 P plug-in (terminal block, socket) 8 P plug-in (terminal block, socket)	11 P plug-in (terminal block, socket)	11 P plug-in (terminal block, socket)	
Available standards	UL/C-UL	UL/C-UL	UL/C-UL	UL/C-UL	UL/C-UL	

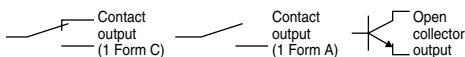

# COUNTER-RELATED TERMINOLOGY

## Types of Counters

### 1. Electro Preset Counter

The counter is equipped with semi-conductor counting circuitry. When the counter counts up to a preset number, its output circuit sends a signal.

### 2. Electro Magnetic Counter

A magnet is magnetized and demagnetized to drive the dial and count up numbers.

## Rating

### 1. Rated Operating Voltage

The voltage is applied to start the counter.

## Countings

### 1. Pulse

This is a voltage or current signal sent at intermittent time intervals.

### 2. Count

Pulses are used to count up and down.

### 3. Miss-count

This happens if the number of pulses does not correspond to the number of counts.

### 4. Hertz

This unit of counting speed is used to give the number of counts per one second.

### 5. Make Ratio

This is the ratio of ON time ( $T_a$ ) to OFF time ( $T_b$ ).

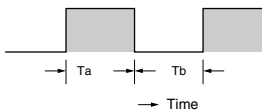

### 6. Maximum Counting Speed

Suppose that the counter is operated with an input pulse of a make ratio of 1. The highest counting speed is the peak of a range in which the output circuit can send signals without mis-counting. The speed is expressed in units of Hz (cps: counts per a second).

### 7. Over Count

Counting continues beyond a preset number.

### 8. Recount

When counting is up, the counter display resets to zero and counting restarts.

### 9. Down Count

Numbers are counted down one by one from a preset number.

### 10. Up Count

Numbers are counted up one by one from zero.

### 11. Up/Down Count

Numbers are counted up or down depending on input conditions.

### 12. Rejection (gate) Input

This signal is used to keep the counter from counting.

## Outputs

### 1. Count Up

When a preset number is reached, the output circuit sends a signal.

### 2. Retained Output

The output is held until a reset signal is sent.

### 3. One Shot Output

This output has a specified width of time.

## Resettings

### 1. Reset

The counting process, display and output sections are all brought back to the initial status.

### 2. Power off Reset

The operating voltage is turned off to reset the counter.

### 3. Manual Reset

The counter is manually reset.

### 4. Remote Reset

A signal is sent from a remote point to the reset terminal so as to reset the counter.

### 5. Automatic Reset

When counting is up, internal circuitry is activated to automatically reset the counter.

### 6. Reset Signal Width

This is the time during which the power is off so as to reset the counter or during which an external (manual) reset signal is sent.

### 7. Reset time

This is the time from the moment a reset signal is sent to the instant the counter is ready to start counting again.

## OTHERS

### 1. Function of Memorizing Condition

Counting data up until the operating voltage is turned off can be stored in memory. When the power is reactivated, the data can be reproduced.

### 2. Anti-surge

The strength against power voltage surge is determined by applying a single-pole full-wave voltage (several hundred to several thousand volt wave for  $\pm(1.2 \times 50) \mu\text{s}$ ) across the control power terminals.

Surge waveform

[Single-pole full-wave voltage for  $\pm(1.2 \times 50) \mu\text{s}$ ]

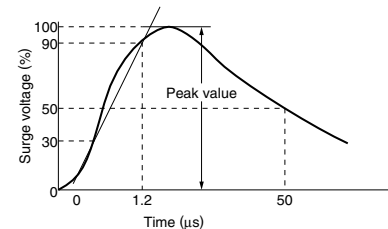

### 3. Noise Immunity

This is the strength against external noise. Relay noise tests, noise simulator tests, etc. are conducted.

# PRECAUTIONS IN USING THE COUNTER

## Cautions for circuits

### 1. Protective circuit for counter contact

In the circuit that switches an inductive load, a contact failure may occur at a contact point due to surge or inrush current resulting from that switching. Therefore, it is recommended that the following protective circuit be used to protect the contact point.

Circuit	CR circuit (r: resistor c: capacitor)		Diode circuit	Varistor circuit
Application	AC DC	(see note.) Available	Available Not available	Available
Features/Others	<p>If the load is a relay or solenoid, the release time lengthens. Effective when connected to both contacts if the power supply voltage is 24 or 48 V and the voltage across the load is 100 to 200 V.</p> <p>If the load is a timer, leakage current flows through the CR circuit causing faulty operation. Note: If used with AC voltage, be sure the impedance of the load is sufficiently smaller than that of the CR circuit.</p>		<p>The diode connected in parallel causes the energy stored in the coil to flow to the coil in the form of current and dissipates it as joule heat at the resistance component of the inductive load. This circuit further delays the release time compared to the CR circuit. (2 to 5 times the release time listed in the catalog)</p>	<p>Using the rated voltage characteristics of the varistor, this circuit prevents excessively high voltages from being applied across the contacts. This circuit also slightly delays the release time.</p>
Device Selection	<p>As a guide in selecting r and c, c: 0.5 to 1 <math>\mu</math>F per 1 A contact current r: 0.5 to 1 <math>\Omega</math> per 1 V contact voltage Values vary depending on the properties of the load and variations in counter characteristics. Capacitor c acts to suppress the discharge the moment the contacts open. Resistor r acts to limit the current when the power is turned on the next time. Test to confirm. Use a capacitor with a breakdown voltage of 200 to 300 V. Use AC type capacitors (non-polarized) for AC circuits.</p>		<p>Use a diode with a reverse breakdown voltage at least 10 times the circuit voltage and a forward current at least as large as the load current. In electronic circuits where the circuit voltages reverse breakdown voltage of about 2 to 3 times the power supply voltage.</p>	—

### 2. Type of Load and Inrush Current

The type of load and its inrush current characteristics, together with the switching frequency, are important factors which cause contact welding. Particularly for loads with inrush currents, measure the steady state current and inrush current and use a relay or magnet switch which provides an ample margin of safety. The table below shows the relationship between typical loads and their inrush currents.

Type of load	Inrush current
Resistive load	Steady state current
Solenoid load	10 to 20 times the steady state current
Motor load	5 to 10 times the steady state current
Incandescent lamp load	10 to 15 times the steady state current
Mercury lamp load	1 to 3 times the steady state current
Sodium vapor lamp load	1 to 3 times the steady state current
Capacitive load	20 to 40 times the steady state current
Transformer load	5 to 15 times the steady state current

When you want large load and long life of the counter, do not control the load direct with a counter. When the counter is designed to use a relay or a magnet switch, you can acquire the longer life of the counter.

### 3. Connection of input (Except for LC4H-S/AC type)

The LC4H series use power supply without a transformer (power and input terminals are not insulated). In connecting various kinds of input signals, therefore, use a power transformer in which the primary side is separated from the ungrounded secondary side as shown in Fig. A, for the power supply for a sensor and other input devices so that short-circuiting can be prevented. Do not use a single coil transformer (e.g., Sly-Duck). Otherwise, the internal circuit of the counter will be short-circuited as shown in Fig. B resulting in breakdown.

(Fig. A) Good

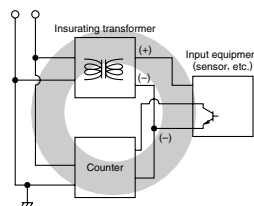

(Fig. B) No good

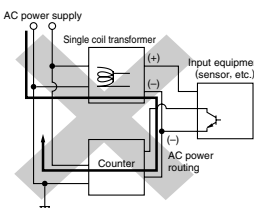
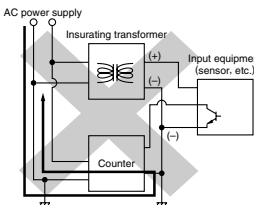

### 5. Leakage current

1) For connecting operating voltage to the counter, a circuit should be used, which will prevent the flow of leakage current. For example, a circuit for contact protection as shown in Fig. A. will permit leakage current flow through R and C, causing erroneous operation of the counter. Instead, the circuit shown in Fig. B should be used.

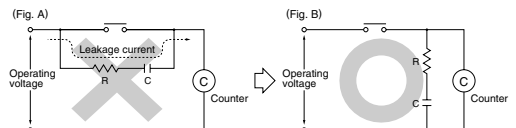

2) If the counter is directly switched with a non-contact element, leak current may flow into the counter and cause it to malfunction.

### 4. Long Continuous Current Flow

Avoid keeping the counter on for a long period of time (over one month). Otherwise heat is generated and accumulated inside the counter, which may deteriorate its electronic parts. If the counter must be kept on for a long period of time, a relay is added. See the circuit diagram below.

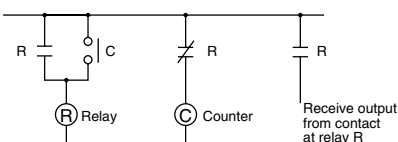

# PRECAUTIONS IN USING THE COUNTER

## Cautions for use (common for all models)

### 1. Terminal connections

Correctly connect the pins while seeing the terminal layout/wiring diagram. In particular, the DC type, which has polarities, does not operate with the polarities connected reverse. Any incorrect connection can cause abnormal heating or ignition.

### 2. Connection to operating voltage

1) Apply the entire supply voltage through a switch, relay or other contact.  
2) The operating voltage for the DC type must be at the specified ripple percentage or less. The average voltage must fall within the allowable operating voltage range.

Rectification type	Ripple percentage
Single-phase, full-wave	Approx. 48%
Three-phase, full-wave	Approx. 4%
Three-phase, half-wave	Approx. 17%

3) Make sure that no induced voltage and residual voltage are applied between the power terminals on the counter after the power switch is turned OFF. (If the power line is wired in parallel with the high-voltage and motor lines, induced voltage may be produced between the power pins.)

### 3. Control output

1) Keep the load capacity below the counter's rated control capacity. If used above the rating, the counter's service life may shorten. With the transistor output type counters, transistors may be damaged.

### 4. Installing the counter

1) To install the counter, use the dedicated pin bracket or socket (cap). Avoid connecting the pins on the counter by directly soldering them.  
2) In order to maintain the characteristics, do not remove the counter cover (case).

### 5. Superimposed surge of power supply

For the superimposed surge of power supply, the standard waveform ( $\pm 1.2 \times 50 \mu\text{s}$  or  $\pm 1 \times 40 \mu\text{s}$ ) is taken as the standard value for surge-proof voltage. (The positive and negative voltages are applied each three or five times between the power pins.)

For the standard values for the LC4H type counters, see the respective items in „Cautions for use.“

#### • Single-pole, full-wave voltage for surge waveform [ $\pm(1.2 \times 50) \mu\text{s}$ ]

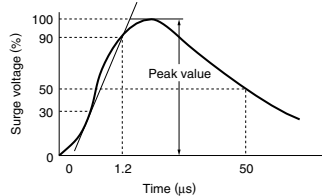

If external surge occurs exceeding the specified value, the internal circuit may break down. In this case, use a surge absorption element. The typical surge absorption elements include a varistor, a capacitor, and a diode. If a surge absorption element is used, use an oscilloscope to see whether or not the foreign surge exceeding the specified value appears.

### 6. Signal input

The counter's signal input comes in two ways. One is by opening and closing the input terminal. The other is by applying a specified H-level or L-level voltage to the input terminal.

For an input sensor's residual voltage, input impedance, input voltage level and other signal input conditions, see the ratings for each type of product.

### 7. Operating environment

1) For the ambient operating temperature and humidity, see the ratings for each type of product.

2) Avoid using the counter in a location where inflammable or corrosive gas is generated, the counter is exposed to much dust and other foreign matter; water or oil is splashed on the counter; or vibrations or shocks are given to the counter.

3) The counter cover (case), the knobs, and the dials are made of polycarbonated resin. Therefore, prevent the counter from being exposed to organic solvents such as methyl alcohol, benzine, and thinner, strong acid substances such as caustic soda, and ammonia and avoid using the counter in atmosphere containing any of those substances.

4) If the counter is used where noises are emitted frequently, separate the input signal elements (such as a sensor), the wiring for the input signal line, and the counter as far as possible from the noise source and the high power line containing noises.

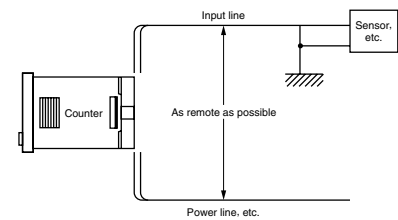

### 8. Checking the actual load

In order to increase the reliability in the actual use, check the quality of the counter in the actual usage.

### 9. Others

1) If the counter is used exceeding the ratings (operating voltage and control capacity), the contact life, or any other specified limit, abnormal heat, smoke, or ignition may occur.

2) The LC2H series counter, incorporates a lithium battery. Never disassemble the lithium battery or throw it into fire because this may affect humans and facilities. The lithium battery must be disposed of as an incombustible like other used batteries.

3) If any malfunction of the counter is likely to affect human life and properties, give allowance to the rated values and performance values. In addition, take appropriate safety measures such as a duplex circuit from the viewpoint of product liabilities.



**Panasonic**  
ideas for life

**DIN HALF SIZE  
LCD COUNTER**

**LC2H**



Panel mounting type  
One-touch installation type



Panel mounting type  
Installation frame type



PC board mounting type

## Features

- **8.7 mm .343 inch Character Height (previously 7 mm)**  
Easy-to-read character height increased from 7 mm to 8.7 mm .276 inch to .343 inch.



- **Plenty of Digits**



- **Counting Speed Switchable between 2 kHz and 30 Hz**
- **Panel Mounting Type Features**
- **Installation Methods**

Comes with very easy one-touch installation type and also installation frame type that uses the bracket on the timer/counter. Choose a method that suits the application.

- **Battery Replacement Easy on Environment**

To replace battery simply remove body for the one-touch installation type, and remove battery lid for the installation frame type.

- **Screw Terminals Designed for Safety**

Built in finger protection.

- **Panel Covers Replacable**

(Standard color is ash gray.)

Change the panel design by replacing with a black panel cover.

- **Conforms to IP66 Protective Construction (Only installation frame type.) (Front panel surface)**

- **Input Methods**

- 1) Non-voltage input method
- 2) Voltage input method
- 3) Free voltage input method

- **Backlight Type Added to Series and Now 2-color Switchable (green/red)**

Easy viewing even in dark places and switchable between green and red (Voltage input type).

- **Compliant with UL, c-UL and CE.**

## Product chart

Type		Standard type			Backlight type
		Non-voltage input type	Voltage input type (4.5 to 30 V DC)	Free voltage input type (24 to 240 V AC/DC)	Voltage input type (4.5 to 30 V DC)
Installation type	One-touch installation type	○	○	○	○
	Installation frame type	○	○	○	○
PC board mounting type		○	—	—	—

## Product types

### 1. Panel mounting type

1) One-touch installation type

① Standard type

No. digits	Counting speed	Front reset	Input method	Part No.
8 digits	2 kHz/30 Hz switchable	Yes	Non-voltage input type	LC2H-FE-2KK
			Voltage input type (4.5 to 30 V DC)	LC2H-FE-DL-2KK
	30 Hz		Free voltage input type (24 to 240 V AC/DC)	LC2H-FE-FV-30

Note) Please ask us about types without front resetting.

② Backlight type

No. digits	Counting speed	Front reset	Input method	Part No.
8 digits	2 kHz/30 Hz switchable	Yes	Voltage input type (4.5 to 30 V DC)	LC2H-FE-DL-2KK-B

# LC2H

## 2) Installation frame type

### ① Standard type

No. digits	Counting speed	Front reset	Input method	Part No.
8 digits	2 kHz/30 Hz switchable	Yes	Non-voltage input type	LC2H-F-2KK
			Voltage input type (4.5 to 30 V DC)	LC2H-F-DL-2KK
	30 Hz		Free voltage input type (24 to 240 V AC/DC)	LC2H-F-FV-30

Note) Please ask us about types without front resetting.

### ② Backlight type

No. digits	Counting speed	Front reset	Input method	Part No.
8 digits	2 kHz/30 Hz switchable	Yes	Voltage input type (4.5 to 30 V DC)	LC2H-F-DL-2KK-B

## 2. PC board mounting type

No. digits	Counting speed	Front reset	Input method	Part No.
8 digits	2 kHz	No	Non-voltage input type	LC2H-C-2K-N
	30 Hz			LC2H-C-30-N

## Specifications

### 1. Panel mounting type

Item	Type	Standard type		Backlight type	Standard type
		Non-voltage input	Voltage input		Free voltage type
No. digits		8 digits			
External power supply		Not required (built-in battery)			
Max. counting speed		2 kHz/30 Hz (Switchable by switch)			30 Hz (Note 2)
Count input	Min. input signal width (ON: OFF = 1:1)	0.25 ms/16.7 ms (Switchable by switch)			16.7 ms
	Input method (signal)	Non-voltage input using contacts or open collector connection	High level: 4.5 to 30 V DC Low level: 0 to 2 V DC		High level: 24 to 240 V AC/DC Low level: 0 to 2.4 V AC/DC
	Input impedance	When shorted: Max. 10 kΩ When open: Max. 750 kΩ	Approx. 4.7 kΩ		—
	Residual voltage	Max. 0.5 V	—		—
Reset input	Min. input signal width	200 ms			
	Input method (signal)	Non-voltage input using contacts or open collector connection	High level: 4.5 to 30 V DC Low level: 0 to 2 V DC		Non-voltage input using contacts or open collector connection
	Input impedance	When shorted: Max. 10 kΩ When open: Max. 750 kΩ	Approx. 4.7 kΩ		When shorted: Max. 10 kΩ When open: Max. 750 kΩ
	Residual voltage	Max 0.5 V	—		Max. 0.5 V
Display method		7-segment LCD	7-segment LCD With green/red backlight	7-segment LCD	
Breakdown voltage (initial)		Between charged and uncharged parts: 1,000 V AC for 1 minute.			Between charged and uncharged parts: 2,000 V AC for 1 minute.
Insulation resistance (initial)		Min. 100 MΩ (measured at 500 V DC) Measurement location same as for break down voltage.			
Backlight power		—	24 V DC (±10%)		—
Protective construction (Note 3)		IEC Standard IP66 (only panel front: when using rubber gasket)			
Accessories (Note 3)		Rubber gasket, mounting bracket			
Battery life		7 years (at 25°C 77°F) Note 1			6 years (at 25°C 77°F)

Notes) 1. The value given for battery life is calculated based on continuous operation (count input signal ON/OFF = 1:1), therefore, this value is not guaranteed.

Also, battery life is decreased 30% when operation is continuous with 2 kHz count inputting in 2 kHz mode.

2. Operation is at 25 Hz when using 24 V AC.

3. Only for installation frame type.

# LC2H

## 2. PC board mounting type

Item		Type	PC board mounting type
Input method			Non DC voltage input
No. digits			8 digits
Rated operation voltage			3 V DC
Allowable operation voltage range			2.7 to 3.3 V DC
Current consumption			Max. 30 $\mu$ A (max. 250 $\mu$ A during reset input)
Max. counting speed			2 kHz
Count input	Min. input signal width (ON: OFF = 1:1)		0.25 ms
	Input method		Non-voltage input using contacts or open collector connection
	Input impedance		When shorted: Max. 10 k $\Omega$ When open: Max. 750 k $\Omega$
	Residual voltage		Max. 0.5 V
Reset input	Min. input signal width		10 ms
	Input method		Non-voltage input using contacts or open collector connection
	Input impedance		When shorted: Max. 10 k $\Omega$ When open: Max. 750 k $\Omega$
	Residual power		Max. 0.5 V
Break down voltage (initial)			Between charged and uncharged parts: 1,000 V AC for 1 minute.
Insulation resistance (initial)			Min. 100 M $\Omega$ (measured at 500 V DC) Measurement location same as for break down voltage.

## 3. Common

Item		Type	Panel mounting/PC board mounting types
Vibration resistance	Functional		10 to 55 Hz (1 cycle/min.), single amplitude: 0.15 mm .006 inch (10 min. on 3 axes)
	Destructive		10 to 55 Hz (1 cycle/min.), single amplitude: 0.375 mm .015 inch (1 hr. on 3 axes)
Shock resistance	Functional		Min. 98 m/s <sup>2</sup> (4 times on 3 axes)
	Destructive		Min. 294 m/s <sup>2</sup> (5 times on 3 axes)
Operation temperature			-10 to +55°C +14 to +131°F (without frost or dew)
Storage temperature			-25 to +65°C -13 to +149°F (without frost or dew)
Ambient humidity			35 to 85% RH (non-condensing)

## Applicable standard

Safety standard	EN61010-1	Pollution Degree 2/Overvoltage Category III
EMC	(EM)EN61000-6-4 Radiation interference electric field strength	EN55011 Group1 ClassA
	Noise terminal voltage	EN55011 Group1 ClassA
	(EMS)EN61000-6-2 Static discharge immunity	EN61000-4-2 4 kV contact 8 kV air
	RF electromagnetic field immunity	EN61000-4-3 10 V/m AM modulation (80 MHz to 1 GHz) 10 V/m pulse modulation (895 MHz to 905 MHz)
	EFT/B immunity	EN61000-4-4 2 kV (power supply line)
	Conductivity noise immunity Power frequency magnetic field immunity	EN61000-4-6 10 V/m AM modulation (0.15 MHz to 80 MHz) EN61000-4-8 30 A/m (50 Hz)

# LC2H

## Part names

### 1. Front reset button

This button resets the count value. It does not work when the lock switch is ON. Be aware that battery life will decrease if this switch is used frequently.

### 2. Lock switch (Refer to chart on right.)

Disable the front reset button.

Note) Turn ON at the LCD side (reset disabled) and OFF at the terminal block side (reset enabled).

### 3. Count speed switch (Refer to chart on right.)

Use this switch to switch the count speed between 30 Hz and 2 kHz. (On the non-voltage and voltage input types, 30 Hz is on the LCD side and 2 kHz is on the terminal block side. Fixed at 30 Hz for free voltage input type.)

Note) You must press the front reset button when you change the count speed switch setting. Confirm, however, that the Lock Switch is OFF (front switches operable).

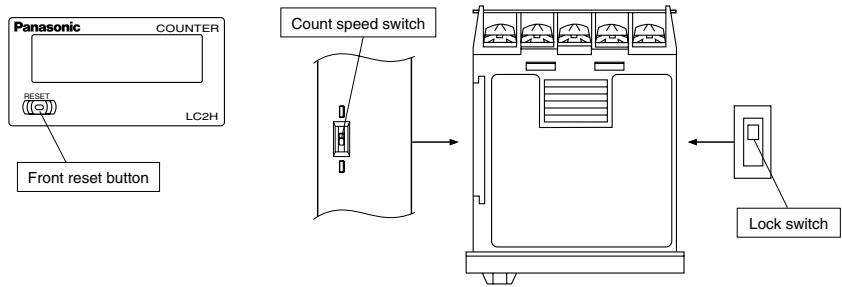

	Non-voltage input/voltage input	Free voltage input
Lock switch (Unit display 1)	(Terminal block side) ↔ (LCD side)	OFF* ↔ ON
Count speed switch (Unit display 2)	(Terminal block side) ↔ (LCD side)	— (Fixed at 30 Hz)

Notes) 1. \*Default setting when shipped.  
2. Make the switch setting before installing to panel.

## Dimensions

### 1. Panel mounting type

#### • External dimensions

#### 1) One-touch installation type

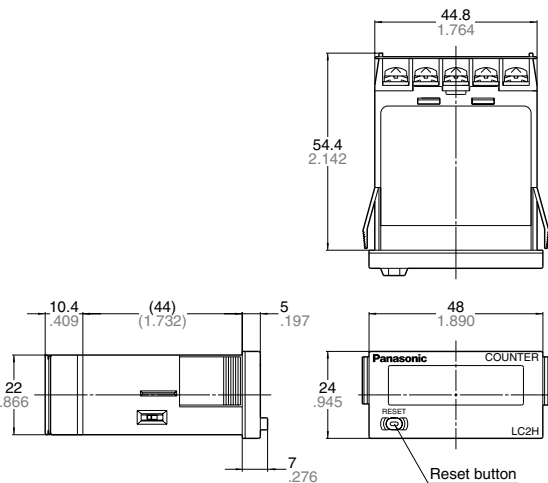

mm inch

General tolerance: ±1.0 ±.039

#### • Panel installation diagram

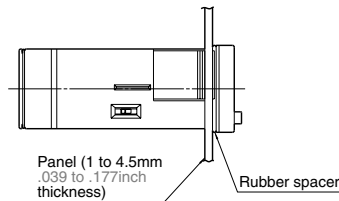

Note) When installing to a 4.5 mm .177 inch thick panel, remove the rubber spacer first.

When installing the one-touch installation type model, make sure that the installation spring does not pinch the rubber gasket.

To prevent the installation spring from pinching the rubber gasket:

1. Set the rubber gasket on both ends of the installation spring (left and right).
2. Confirm that the installation spring is not pinching the rubber gasket, and then insert and fix the installation spring in place from the rear of the timer unit.

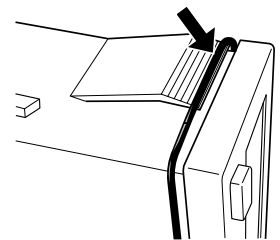

# LC2H

## 2) Installation frame type

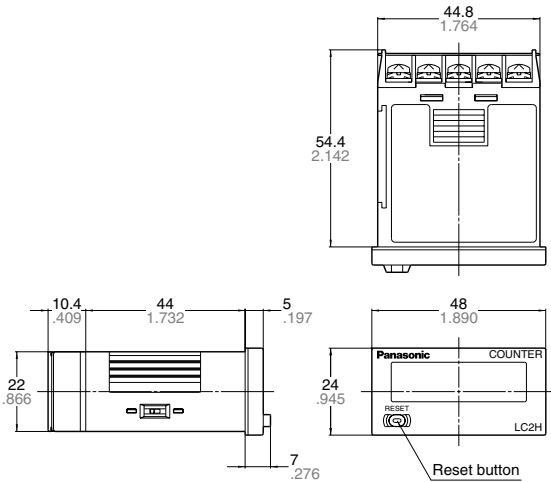

## • Panel mounting diagram

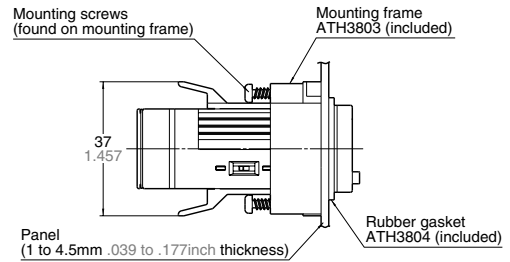

## • Panel cut-out dimensions

The standard panel cut-out is shown below. Use the mounting frame (ATH3803) and the rubber packing (ATH3804). (Only installation frame type.)

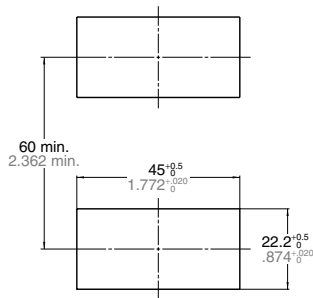

## • For connected installation (sealed installation) (Only installation frame type.)

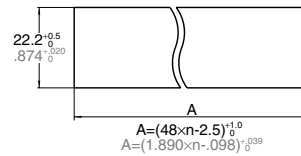

Notes) 1. Suitable installation panel thickness is 1 to 4.5 mm .039 to .177 inch.  
2. Waterproofing will be lost when installing repeatedly (sealed installation)

## • Terminal layout and wiring diagrams

### 1) Standard type

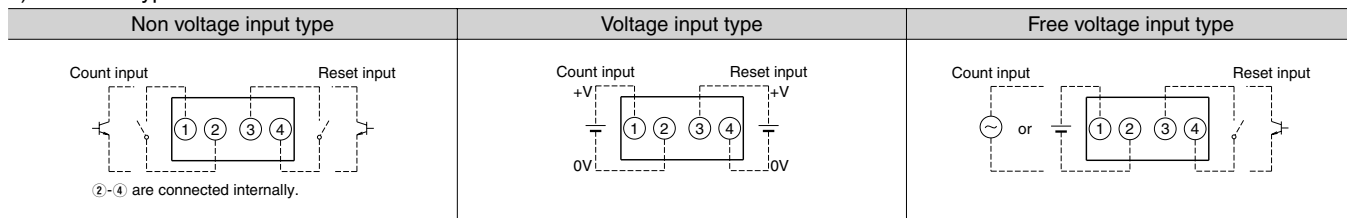

### 2) Backlight type

#### Voltage input type

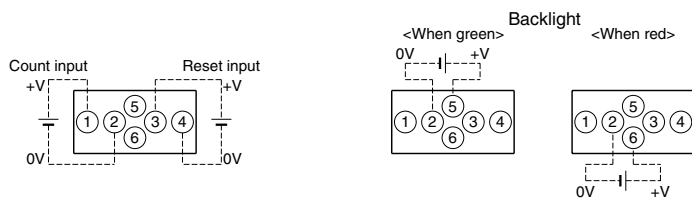

# LC2H

## 2. PC board mounting type

### • External dimensions

General tolerance:  $\pm 1.0 \pm 0.039$  mm incl

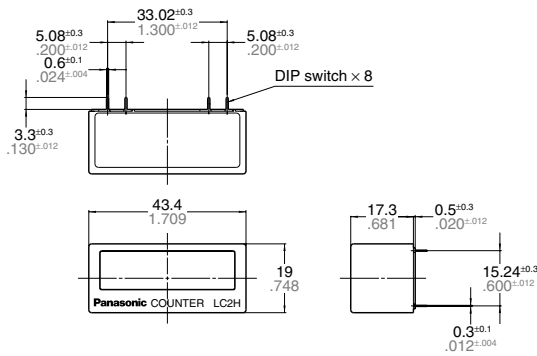

### PC board pattern (BOTTOM VIEW)

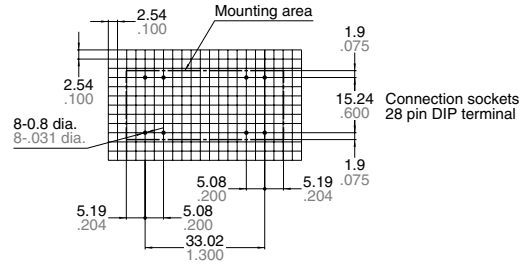

General tolerance:  $\pm 0.1 \pm 0.004$

### • Terminal layout and wiring diagrams

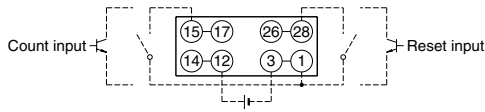

①-③, ⑫-⑭, ⑮-⑰ and ⑳-㉔ are connected internally.  
An external power supply is required.

Note: The AXS212811K is recommended as a compatible connection socket.

## Input method

### 1. Standard type

Non-voltage input type			
Panel mounting type		PC board mounting type	
Contact input	Transistor input NPN transistor	Contact input	Transistor input NPN transistor

Notes 1. When using contact input, since current flow is small from terminals ① and ③ on the panel mounting type and terminals ⑮ to ⑰ and ⑳ to ㉔ on the PC board mounting type, please use relays and switches with high contact reliability.

2. When using transistor input, use the following as a guide for which transistors (Tr) to use for inputting. (Collector withstand voltage  $\geq 50$  V, leakage current  $< 1 \mu\text{A}$ )

Voltage input type			Free voltage input type
Contact input	Transistor input		
	NPN transistor	PNP transistor	

Notes 1. ② and ④. (The input and reset circuits are functionally insulated.)

2. When using transistor (Tr) input, use the right as a guide. (Collector withstand voltage  $\geq 50$  V, leakage current  $< 1 \mu\text{A}$ )

3. Be aware that the application of voltage that exceeds the voltage range of the H level to the count input terminal, and the application of voltage to the reset input terminal, can cause damage to the internal elements.

## 2. Backlight type

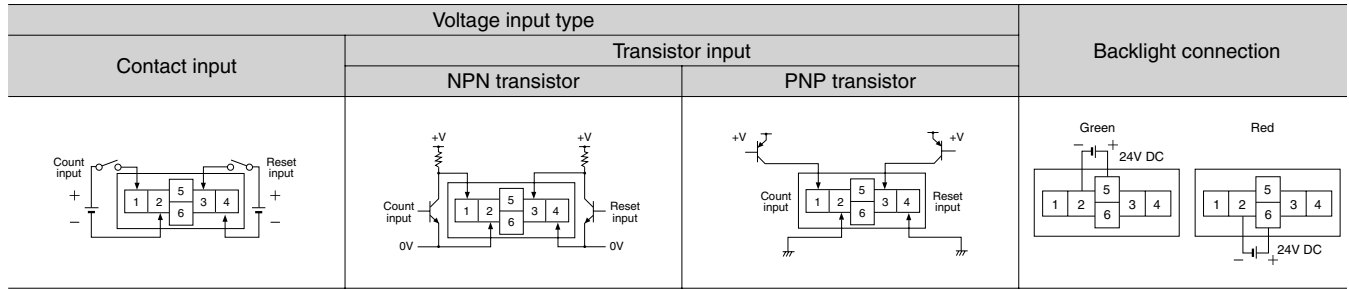

Notes) 1. Do not reverse the polarities when connecting the DC voltage for the backlight.

2. ② and ④. (The input and reset circuits are functionally insulated.)

3. When using transistor (Tr) input, use the right as a guide. (Collector withstand voltage  $\geq 50$  V, leakage current  $< 1 \mu\text{A}$ )

4. Be aware that the application of voltage that exceeds the voltage range of the H level to the count input terminal, and the application of voltage to the reset input terminal, can cause damage to the internal elements.

## Explanation of operation

1. Counting takes place when the count input signal is ON.

2. Counting resumes again when the count value reaches 99999999 (full scale value) and then returns to "0" with a new count input.

3. No measurement takes place when a reset is input.

1) When reset is ON, resetting takes place and the count becomes "0".

2) Press the front reset button when you want to reset manually (only panel installation type).

Note) Be aware that battery life will decrease if the count input or reset input are left ON.

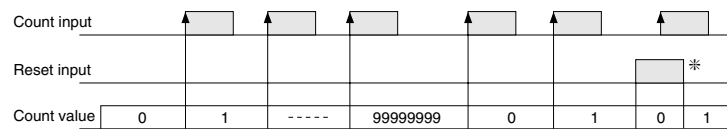

Note) \*Count becomes "1" when the reset input is turned OFF while the count signal is being input.

## Cautions for use

### 1. Non-voltage input type

#### For both panel mounting and PC board mounting types

1) Never apply voltage to the non-voltage input type. This will damage the internal elements. Also, since there is a possibility of erroneous operation, do not connect in parallel the inputs of a non-voltage input type and another counter from a single input signal.

2) Since the current flow is very small from the count input and reset input terminals (① and ③ on the panel mounting type and terminals ⑮ to ⑰ and ⑳ to ㉓ on the PC board mounting type) please use relays and switches with high contact reliability.

3) When inputting with an open collector of a transistor, use a transistor for small signals in which ICBO is 1 μA or less and always input with no voltage.

4) When wiring, try to keep all the input lines to the count and reset inputs as short as possible and avoid running them together with high voltage and power transmission lines or in a power conduit. Also, malfunctions might occur if the floating capacitance of these wires exceeds 500 pF (10 m 32.808 ft. for parallel wires of 2 mm<sup>2</sup>). When using 2 kHz mode, use with a wiring floating capacitance of 120 pF (3 m 9.843 ft. for parallel wires of 2 mm<sup>2</sup>). In particular, when using shielded wiring, be careful of the capacitance between wires.

#### PC board mounting type

1) For external power supply use manganese dioxide or lithium batteries (CR type: 3V).

2) Always reset after external power is applied and confirm that the display reads "0".

3) Make the wiring from the battery to the counter unit as short as absolutely possible. Also, be careful of polarity.

4) Calculate battery life with the following formula.

$$t = A/I$$

t: battery life [h]

I: LC2H current consumption [mA]

A: battery capacity until minimum operation voltage is reached [mAh]

5) Hand solder to the lead terminal. Do not dip solder. With the tip of the soldering iron at 300°C 572°F perform soldering within 3 seconds (for 30 to 60 W soldering iron).

### 2. Voltage input type

1) Be aware that applying more than 30 V DC to count input terminals ① and ②, and reset input terminals ③ and ④ will cause damage to the internal elements.

2) For external resetting use H level (application of 4.5 to 30 V DC) between reset terminals ③ and ④ of the rear terminals. In this case, connect + to terminal ③ and – to terminal ④. This is the valid polarity; therefore, the counter will not work if reversed.

3) When wiring, try to keep all the input lines to the count and reset inputs as short as possible and avoid running them together with high voltage and power transmission lines or in a power conduit. Also, malfunctions might occur if the floating capacitance of these wires exceeds 500 pF (10 m 32.808 ft. for parallel wires of 2 mm<sup>2</sup>).

### 3. Free voltage input type

1) Use count input terminals ① and ② for free voltage input and reset terminals ③ and ④ for non-voltage input.

2) Be aware that the application of voltage that exceeds the voltage range of the H level to the count input terminal, and the application of voltage to the reset input terminal, can cause damage to the internal elements.

3) Since the current flow is very small from reset input terminal ③, please use relays and switches with high contact reliability.

4) When inputting a reset with an open collector of a transistor, use a transistor for small signals in which ICBO is 1 μA or less and always input with no voltage.

5) To reset externally, short reset input terminals ③ and ④ on the rear.

6) Input uses a high impedance circuit; therefore, erroneous operation may occur if the influence of induction voltage is present. If you plan to use wiring for the input signal that is 10 m or longer (wire capacitance 120 pF/m at normal temperature), we recommend the use of a CR filter or the connection of a bleeder resistor.

### 4. How to reset multiple panel mounting type counters all at once (input is the same for count)

#### Non-voltage input type

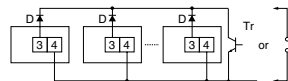

Notes) 1. Use the following as a guide for choosing transistors used for input (Tr).

Leakage current < 1 μA

2. Use as small a diode (D) as possible in the forward voltage so that the voltage between terminals 3 and 4 during reset input meets the standard value (0.5 V).

( At IF = 20 μA, forward voltage 0.1 and higher.)

### Voltage input type

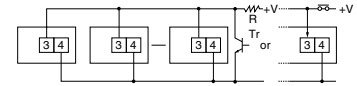

Note) Make sure that H (reset ON) level is at least 4.5 V.

### 5. Backlight luminance

To prevent varying luminance among backlights when using multiple Backlight types, please use the same backlight power supply.

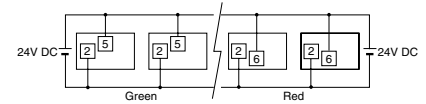

### 6. Environment for use

1) Ambient conditions

- Overvoltage category II, pollution level 2
- Indoor use

• Acceptable temperature and humidity range: –10 to +55°C, 35 to 85%RH (with no condensation at 20°C)

- Under 2000 m elevation

2) Use the main unit in a location that matches the following conditions.

- There is minimal dust and no corrosive gas.
- There is no combustible or explosive gas.
- There is no mechanical vibration or impacts.
- There is no exposure to direct sunlight.
- Located away from large-volume electromagnetic switches and power lines with large electrical currents.

3) Connect a breaker that conforms to EN60947-1 or EN60947-3 to the voltage input section.

4) Applied voltage should be protected with an overcurrent protection device (example: T 1A, 250 V AC time lag fuse) that conforms to the EN/IEC standards. (Free voltage input type)



**Panasonic**  
ideas for life

**PRESET  
COUNTERS**

**LC2H**



### Features

- Preset function equipped in half size (24 × 48 mm 0.945 × 1.890 inch).
- Display has backlight for instant recognition.

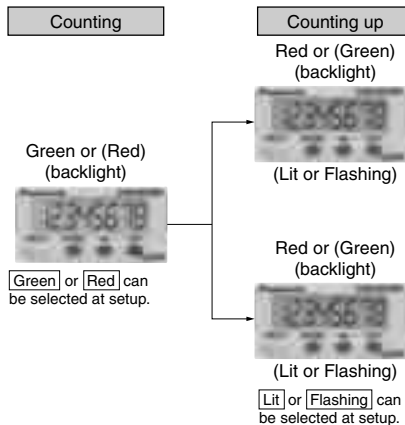

- **8.7 mm 0.343 inch Character Height (previously 7 mm 0.276 inch)**  
Easy-to read character height increased from 7 mm to 8.7 mm 0.276 inch to 0.343 inch.



- **Plenty of Digits**



- **Counting Speed Switchable between 30 Hz and 5 kHz**
- **Conforms to IP66 Protective Construction (Front panel surface)**  
Weatherproofing supported by using optional mounting frame and rubber gasket
- **Includes reassuring lock mode and lock switch to prevent erroneous operation.**
- **Screw terminals are constructed to protect fingers to ensure safety.**
- **Compliant with UL, c-UL and CE.**

### Product types

No. digits	Counting speed	Output mode	Output	Operating voltage	Part No.
8 digits	30 Hz/5 kHz switchable	<ul style="list-style-type: none"> <li>• Maintain output/hold count</li> <li>• Maintain output/over count</li> <li>• One shot/over count</li> <li>• One shot/recount</li> </ul>	Transistor (1a)	24 V DC	LC2HP-FEW-B-DC24V
Options		Mounting frame		Use for waterproofing (front panel surface)	ATH3803
		Rubber gasket			ATH3804

Note: Mounting frame and rubber gasket are not included.

## Specifications

Item		Descriptions
Rating	Rated operating voltage	24 V DC
	Rated power consumption	Max. 1.5 W
	Rated control capacity	100 mA 30 V DC
	Input mode	Addition/Subtraction (selectable by front switch)
	Max. counting speed	30 Hz/5 kHz (selectable by slide switch on side)
	Counting input	Min. input signal width: 16.7 ms at 30 Hz/0.1 ms at 5 kHz, ON time : OFF time = 1 : 1
	Reset input	Min. input signal width: Min. 30 ms
	Input signal	<ul style="list-style-type: none"> <li>• Non-voltage input using contacts or open-collector connection</li> <li>• Input impedance; when shorted: Max. 1 kΩ, when open: Min. 100 kΩ</li> <li>• Residual voltage: Max. 2 V</li> </ul>
	Output mode	<ul style="list-style-type: none"> <li>• Maintain output/hold count</li> <li>• Maintain output/over count</li> <li>• One shot/over count</li> <li>• One shot/recount</li> </ul> (Selectable by front switch)
	Display method	7-segment LCD (Switch between red and green for backlight, and between lit and flashing for count up.)
	Digit	-9999999 to 99999999 (-7 digits to +8 digits) (0 to 99999999 for preset value)
	Memory	EER-ROM (Overwriting times: 10 <sup>5</sup> operations or more)
	Contact arrangement	
Electrical life (contact)		10 <sup>7</sup> operations (at rated control voltage)
Electrical	Allowable operating voltage range	85 to 110% of rated operating voltage
	Break down voltage (Initial value)	Between input and output: 1,500 V AC, for 1 min.
	Insulation resistance (Initial value)	Between input and output: 100 MΩ (at 500 V DC)
Mechanical	Functional vibration resistance	10 to 55 Hz (1 cycle/min), Single amplitude: 0.15 mm (10 min. on 3 axes)
	Destructive vibration resistance	10 to 55 Hz (1 cycle/min), Single amplitude: 0.375 mm (1 hr. on 3 axes)
	Functional shock resistance	Min. 98 m/s <sup>2</sup> (4 times on 3 axes)
	Destructive shock resistance	Min. 294 m/s <sup>2</sup> (5 times on 3 axes)
Operating conditions	Operation temperature	-10 to 55°C +14 to +131°F (without frost or dew)
	Storage temperature	-25 to +65°C -13 to +149°F (without frost or dew)
	Ambient humidity	30 to 85% RH (at 25°C 77°F, non-condensing)
Protective construction		IP66 (front panel with mounting bracket and rubber gasket)

\* The factory default preset value is set to 1000000.

## Applicable standard

EMC	(EMI)EN61000-6-4 Radiation interference electric field strength Noise terminal voltage (EMS)EN61000-6-2 Static discharge immunity	EN55011 Group1 ClassA EN55011 Group1 ClassA
	RF electromagnetic field immunity	EN61000-4-2 4 kV contact 8 kV air
	EFT/B immunity	EN61000-4-3 10 V/m AM modulation (80 MHz to 1 GHz) 10 V/m pulse modulation (895 MHz to 905 MHz)
	Conductivity noise immunity	EN61000-4-4 2 kV (power supply line) 1 kV (signal line)
	Power frequency magnetic field immunity	EN61000-4-6 10 V/m AM modulation (0.15 MHz to 80 MHz) EN61000-4-8 30 A/m (50 Hz)

# LC2H

## Part names

### 1. Front reset key

This key resets the count value. It does not work when the lock switch is ON.

### 2. Mode key

Use to switch between each mode.

### 3. Setting key

Used to set digits of preset values or set each mode.

### 4. Set key

Use to set preset values or to switch between modes.

### 5. Lock switch

Disable the operation of the front panel reset key and the mode key. With the lock switch on, **LocL** is displayed for about two seconds when the reset key or mode switch is operated.

### 6. Count speed switch

Use this switch to switch the count speed between 30 Hz and 5 kHz.

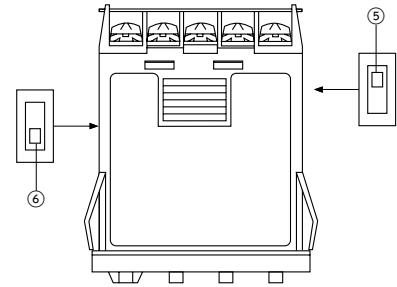
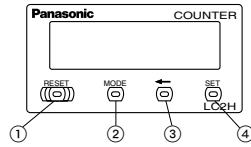

※: Default setting when shipped.

⑤	Lock switch (unit display 1)	(Terminal block side) ↑ (LCD side)	 OFF※ ↑ ON
⑥	Count speed switch (unit display 2)	(Terminal block side) ↑ (LCD side)	 5kHz ↑ 30Hz※

Notes: 1. Make the switch setting before installing to panel.

2. Please turn the power off if you change the setting of the count speed switch when the power is on. The setting will become valid when the power is turned back on.

## Dimensions

### • External dimensions

mm inch

General tolerance: ±1.0 ±.039

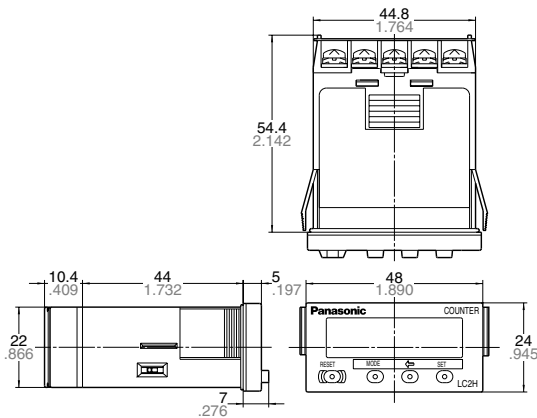

When installing the one-touch installation type model, make sure that the installation spring does not pinch the rubber gasket.

To prevent the installation spring from pinching the rubber gasket:

1. Set the rubber gasket on both ends of the installation spring (left and right).
2. Confirm that the installation spring is not pinching the rubber gasket, and then insert and fix the installation spring in place from the rear of the timer unit.

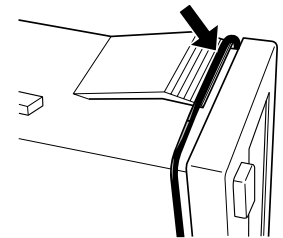

### • Panel cut out dimensions

The standard panel cut out is shown below.

Use the mounting bracket (ATH3803) and the rubber gasket (ATH3804).  
(Only installation frame type)

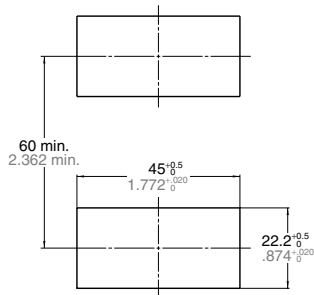

### • When installing repeatedly (sealed installation) (Only installation frame type)

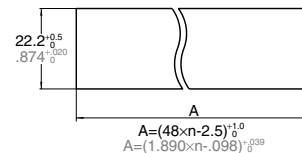

- Notes: 1. Suitable installation panel thickness is 1 to 4.5 mm 0.39 to 0.177 inch.
2. Waterproofing will be lost when installing repeatedly (sealed installation).

## How to set

### 1. Preset value setting mode

This is the mode for setting preset values.



1) Pressing the MODE key takes you to the preset value setting mode.



2) Pressing the setting key moves the flashing digit left by one. Following the highest digit it returns to the lowest digit and each time the digit setting key is pressed it moves one to the left.

3) Pressing the set key increases the value by one. (After 9 it returns to 0 and then changes to 1, 2, 3, etc.)

4) Pressing the front panel reset key sets the displayed preset value and returns you to the regular operation mode.

5) In the preset value setting mode if you do not operate the digit setting key or the set key for ten seconds or more you will be returned to regular operation. In this case the preset value will not change.

### 2. Lock mode

This mode prohibits everything except the preset value setting mode.



1) Pressing the set key while holding down the mode key takes you to the lock mode.

2) The display reads “Un-Lock” after entering the lock mode (initial setting).

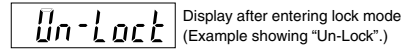

3) Pressing the setting key changes the display between “ Lock” and “Un-lock”.

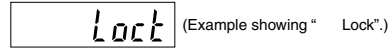

4) Pressing the front panel reset key sets the content displayed and returns you to regular operation mode.

Note: You will not be returned to regular operation mode if you do not press the front panel reset key.

5) When the lock mode display reads “ Lock”, you will not be able to move to the backlight setting mode, the input setting mode, or the output setting mode.

### 3. Backlight setting mode

This is the mode for setting the backlight during count up.



1) Pressing the SET key two times while holding down the MODE key takes you to the backlight setting mode.

2) The display in the backlight setting mode reads “ LEd”



3) The LED backlight will be red (initial setting).

4) The backlight changes from flashing green to flashing red to lit green and to lit red with each press of the setting key.

5) Pressing the front panel reset key sets the current backlight color and returns you to regular operation mode.

Note: You will not be returned to regular operation mode if you do not press the front panel reset key.

### 4. Input setting mode

This is the mode for setting addition or subtraction.



1) Pressing the SET key three times while holding down the MODE key takes you to the input setting mode.

2) The display after entering the input setting mode reads “ UP” (initial setting).

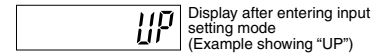

3) Pressing the setting key changes the display to “dn” (subtraction) and pressing it again changes it to “UP” (addition). The display alternates between “dn” and “UP”

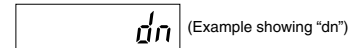

4) Pressing the front panel reset key sets the content displayed and returns you to regular operation mode.

Note: You will not be returned to regular operation mode if you do not press the front panel reset key.

## 5. Output setting mode

This sets the operation mode.

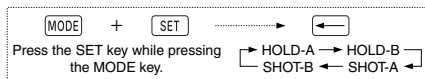

1) Pressing the SET key four times while holding down the MODE key takes you to the output setting mode.

2) The display reads "HoLd-A" (initial setting) after entering the output setting mode.



3) Pressing the setting key causes the display to change as follows:

HOLD-B (Output maintain/over count I)

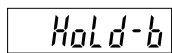

SHOT-A (One shot/over count)



SHOT-B (One shot/recount I)

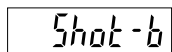

HOLD-A (Output maintain/hold count)

4) Pressing the front panel reset key sets the display content and returns you to regular operation mode.

Note: You will not be returned to regular operation mode if you do not press the front panel reset key.

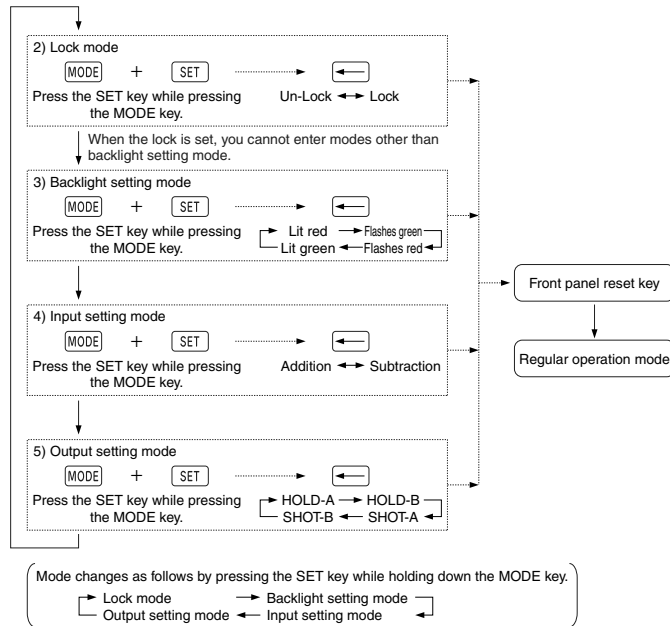

Please be aware that after doing a front panel reset key and returning to regular operation mode, the preset values, count value and output will be as shown in this table.

	Preset value	Count value	Output change
Lock mode	×	×	×
Backlight setting mode	×	×	×
Input setting mode	×	Addition: "0" Subtraction: "Preset value"	ON→OFF
Output setting mode	×	Addition: "0" Subtraction: "Preset value"	ON→OFF

Note: "x" sign: No change

## Changing the preset value

1. It is possible to change the preset value even during counting. However, be aware of the following points.

1) If the preset value is changed to less than the count value with counting set to the addition direction, counting will continue until it reaches full scale, returns to zero, and then reaches the new preset value. If the preset value is changed to a value above the count value, counting will continue until the count value reaches the new preset value.

2) Suppose that the counter is preset to count down. Whether a preset count down value is smaller or larger than the count value, the counter counts down to "0 (zero)".

2. If the preset value is changed to "0", the counter will not complete count-up. It starts counting up when the counting value comes to "0 (zero)" again.

1) Addition (up-count) input when counting is set to the addition direction, counting will continue until full scale is reached, return to zero, and then complete count-up.

2) Subtraction (down-count) input when counting is set to the subtraction direction, counting will continue until full scale "-9999999" is reached, and then the display will change to " . . . . . ".

## Compliance with the CE marking

• EMC Directive (89/336/EEC)

The LC2H Preset Counter conforms to the EMC Directive as a simple counter.

Applicable standards: EN61000-6-4, EN61000-6-2

## Operation mode

Output mode	Operation	Example when input mode is either addition or Subject:ubtraction																						
Output maintain/ hold count <b>HOLD-A</b>	Output control is maintained after count-up completion and until resetting. During that time, the count display does not change from that at count-up completion.	<p>Output: OFF → ON</p> <p>Counting able/unable: ← Able → Unable</p> <table border="1"> <tr> <td>0</td><td>1</td><td>2</td><td>3</td><td>4</td><td>⋯</td><td>n-1</td><td>n</td> </tr> <tr> <td>n</td><td>n-1</td><td>n-2</td><td>n-3</td><td>n-4</td><td>⋯</td><td>1</td><td>0</td> </tr> </table> <p>n: Preset value</p>	0	1	2	3	4	⋯	n-1	n	n	n-1	n-2	n-3	n-4	⋯	1	0						
0	1	2	3	4	⋯	n-1	n																	
n	n-1	n-2	n-3	n-4	⋯	1	0																	
Output maintain/ over count I <b>HOLD-B</b>	Output control is maintained after count-up completion and until resetting. However, counting is possible despite completion of count-up.	<p>Output: OFF → ON</p> <p>Counting able/unable: ← Able →</p> <table border="1"> <tr> <td>0</td><td>1</td><td>2</td><td>3</td><td>⋯</td><td>n-2</td><td>n-1</td><td>n</td><td>n+1</td><td>n+2</td><td>n+3</td> </tr> <tr> <td>n</td><td>n-1</td><td>n-2</td><td>n-3</td><td>⋯</td><td>2</td><td>1</td><td>0</td><td>-1</td><td>-2</td><td>-3</td> </tr> </table> <p>n: Preset value</p>	0	1	2	3	⋯	n-2	n-1	n	n+1	n+2	n+3	n	n-1	n-2	n-3	⋯	2	1	0	-1	-2	-3
0	1	2	3	⋯	n-2	n-1	n	n+1	n+2	n+3														
n	n-1	n-2	n-3	⋯	2	1	0	-1	-2	-3														
One shot/ over count <b>SHOT-A</b>	Output control is maintained after count-up completion for a fixed time (approx. 1 sec.). Counting is possible despite completion of count-up.	<p>Output: OFF → ON (One shot pulse width: approx. 1 sec.) → OFF</p> <p>Counting able/unable: ← Able →</p> <table border="1"> <tr> <td>0</td><td>1</td><td>2</td><td>3</td><td>⋯</td><td>n-2</td><td>n-1</td><td>n</td><td>n+1</td><td>n+2</td><td>n+3</td> </tr> <tr> <td>n</td><td>n-1</td><td>n-2</td><td>n-3</td><td>⋯</td><td>2</td><td>1</td><td>0</td><td>-1</td><td>-2</td><td>-3</td> </tr> </table> <p>n: Preset value</p>	0	1	2	3	⋯	n-2	n-1	n	n+1	n+2	n+3	n	n-1	n-2	n-3	⋯	2	1	0	-1	-2	-3
0	1	2	3	⋯	n-2	n-1	n	n+1	n+2	n+3														
n	n-1	n-2	n-3	⋯	2	1	0	-1	-2	-3														
One shot/ recount I <b>SHOT-B</b>	Output control is maintained after count-up completion for a fixed time (approx. 1 sec.). Counting is possible despite completion of count-up. However, reset occurs simultaneous with completion of count-up. While output is being maintained, restarting of the count is not possible.	<p>Output: OFF → ON (One shot pulse width: approx. 1 sec.) → OFF</p> <p>Counting able/unable: ← Able →</p> <table border="1"> <tr> <td>0</td><td>1</td><td>2</td><td>3</td><td>⋯</td><td>n-1</td><td>0</td><td>1</td><td>2</td><td>3</td><td>4</td> </tr> <tr> <td>n</td><td>n-1</td><td>n-2</td><td>n-3</td><td>⋯</td><td>1</td><td>n</td><td>n-1</td><td>n-2</td><td>n-3</td><td>n-4</td> </tr> </table> <p>n: Preset value</p>	0	1	2	3	⋯	n-1	0	1	2	3	4	n	n-1	n-2	n-3	⋯	1	n	n-1	n-2	n-3	n-4
0	1	2	3	⋯	n-1	0	1	2	3	4														
n	n-1	n-2	n-3	⋯	1	n	n-1	n-2	n-3	n-4														

# PRECAUTIONS IN USING THE LC2H SERIES

## Cautions for use

### 1. Input and output connection

#### 1) Input connection

##### (1) Contact input

Use highly reliable metal plated contacts. Since the contact's bounce time leads directly to error in the count value, use contacts with as short a bounce time as possible. In general, select input to have a maximum counting speed of 30 Hz.

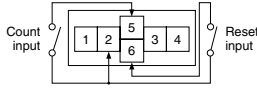

##### (2) Non-contact input (Transistor input)

Connect with an open collector. Use transistors whose characteristics satisfy the criteria given below.

VCEO = Min. 20 V

IC = Min. 20 mA

ICBO = Max. 6  $\mu$ A

Also, use transistors with a residual voltage of less than 2 V when the transistor is on.

\* The short-circuit impedance should be less than 1 k $\Omega$ .

(When the impedance is 0  $\Omega$ , the current coming from the count input terminal is approximately 5 mA and from the reset input terminal is approximately 1.5 mA.)

Also, the open-circuit impedance should be more than 100 k $\Omega$ .

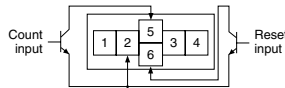

#### (3) Input wiring

When wiring, use shielded wires or metallic wire tubes, and keep the wire lengths as short as possible.

#### 2) Output connection

Since the transistor output of counter is insulated from the internal circuitry by a photo-coupler, it can be used as an NPN output or PNP (equal value) output.

##### As NPN output

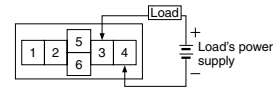

##### As PNP output

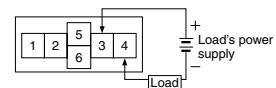

### 2. Self-diagnosis function

If a malfunction occurs, one of the following displays will appear.

Display	Contents	Output condition	Restoration procedure	Preset values after restoration
Err-00	Malfunctioning CPU	OFF	Enter front reset key or restart counter	The preset value at start-up before the CPU malfunction occurred.
Err-01	Malfunctioning memory*			0

\* Includes the possibility that the EEPROM's life has expired.

### 3. Terminal connection

1) When wiring the terminals, refer to the terminal layout and wiring diagrams and be sure to perform the wiring properly without errors.

An external power supply is required in order to run the main unit.

Power should be applied between terminals (1) and (2). Terminal (1) acts as the positive connection and terminal (2) as the negative.

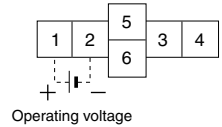

2) After turning the counter off, make sure that any resulting induced voltage or residual voltage is not applied to power supply terminals (1) through (2). (If the power supply wire is wired parallel to the high voltage wire or power wire, an induced voltage may be generated at the power supply terminal.)

3) Have the power supply voltage pass through a switch or relay so that it is applied at one time.

# PRECAUTIONS IN USING THE LC2H SERIES

## Cautions for use

### 1. Insulation sheet

Before using a panel mounting type, please pull and remove the insulation sheet from the side of the product in the direction of the arrow.

In consideration that the product might be stored for long periods without being used, an insulation sheet is inserted before shipping. Remove the insulation sheet and press the front reset button.

### • LC2H total counter (one-touch installation type)

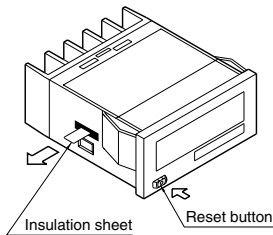

### • LC2H total counter (installation frame type)

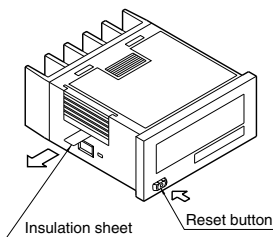

### 2. Waterproof construction

#### • LC2H total counter (installation frame type)

The operation part of the panel installation type (installation frame type) is constructed to prevent water from entering the unit and a rubber gasket is provided to prevent water from entering the gap between the unit and the panel cutout.

There must be sufficient pressure applied to the rubber gasket to prevent water from entering.

Be sure to use the mounting reinforcement screws when installing the mounting frame (ATH3803).

Note: The one-touch installation type is not waterproof.

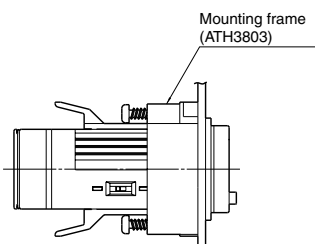

### • LC2H preset counter

1) The front plate will not be waterproof when this product is installed on a panel. To make the front plate waterproof, please install the following.

When using the waterproof type (IP66: panel front only), install the counter to the front plate with mounting frame ATH3803 (sold separately) and rubber gasket ATH3804 (sold separately). Be sure to tighten using mounting screws.

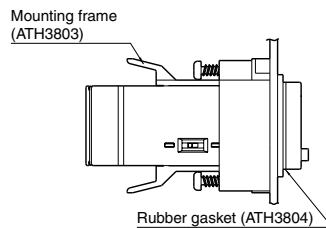

When installing the mounting frame and rubber gasket please remove the pre-attached o-ring.

### 2) Panel installation order

- (1) Remove o-ring.
- (2) Place rubber gasket.
- (3) Insert counter into panel.
- (4) Insert mounting frame from the rear.
- (5) Secure with mounting screws (two locations)

### 3. Do not use in the following environments

- 1) In places where the temperature changes drastically.
- 2) In places where humidity is high and there is the possibility of dew. (When dew forms the display may vanish and other display errors may occur.)

### 4. Conditions of use

- 1) Do not use on places where there is flammable or corrosive gas, lots of dust, presence of oil, or where the unit might be subject to strong vibrations or shocks.
- 2) Since the cover is made of polycarbonate resin, do not use in places where the unit might come into contact with or be exposed to environments that contain organic solvents such as methyl alcohol, benzene and thinner, or strong alkali substances such as ammonia and caustic soda.

### 5. Cautions regarding battery replacement

- 1) Remove wiring before replacing the battery. You may be electrocuted if you come into contact to a part where high voltage is applied.
- 2) Make sure you are not carrying a static electric charge when replacing the battery.
- 3) Battery replacement procedure  
For LC2H total counter (one-touch installation type)
  - (1) Remove the up/down hook of the case using a tool.
  - (2) Pull the unit away from the case.
  - (3) Remove the battery from the side of the unit. Do not touch the display or other parts.
  - (4) Before inserting wipe clean the surface of the new battery.
  - (5) Insert the new battery with the “+” and “-” sides in the proper position.
  - (6) After replacing the battery, return the unit to the case. Verify that the hook of the case has properly engaged.
  - (7) Before using, press the reset button on the front.

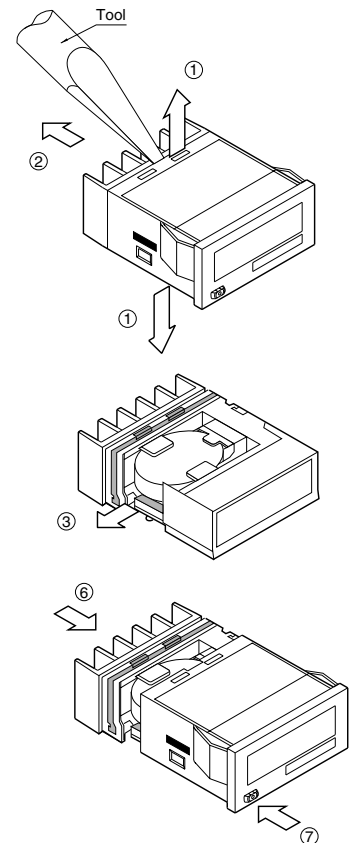



# PRECAUTIONS IN USING THE LC2H SERIES

For LC2H total counter  
(installation frame type)

- (1) Remove the battery cover from the case.
- (2) Remove the battery from the side of the case. The battery will come loose if you put the battery side face down and lightly shake the unit.
- (3) Before inserting wipe clean the surface of the new battery.
- (4) Insert the new battery with the “+” and “-” sides in the proper position.
- (5) After replacing the battery, return the battery cover to the case. Verify that the hook of the battery cover is properly engaged.
- (6) Before using press the reset button on the front.

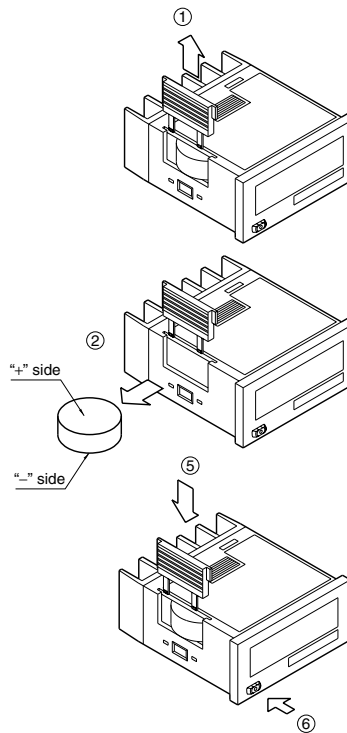

## 6. Terminal connection

Tighten the terminal screws with a torque of 0.8 N·cm or less.

**Panasonic**  
ideas for life

## DIN 48 SIZE LCD ELECTRONIC COUNTER

# LC4H

UL File No.: E122222  
C-UL File No.: E122222

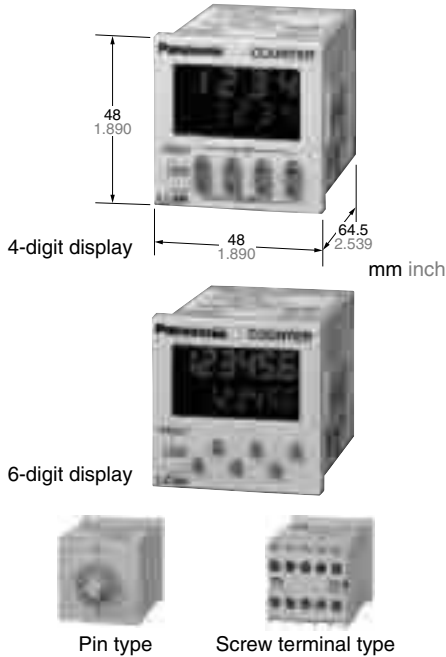

### Features

- **Bright and Easy-to-Read Display**  
A brand new bright 2-color backlight LCD display. The easy-to-read screen in any location makes checking and setting procedures a cinch.
- **Simple Operation**  
Seesaw buttons make operating the unit even easier than before.
- **Short Body of only 64.5 mm 2.539 inch (screw type) or 70.1 mm 2.760 inch (pin type)**  
With a short body, it easily installs in even narrow control panels.
- **Conforms to IP66's Weather Resistant Standards**  
The water-proof panel keeps out water and dirt for reliable operation even in poor environments.

- **Screw terminal and Pin Type are Both Standard Options**  
The two terminal types are standard options to support either front panel installation or embedded installation.
- **Changeable Panel Cover**  
Also offers a black panel cover to meet your design considerations.
- **4-digit or 6-digit display**  
Two sizes of displays are offered for you to choose the one that suits your needs.
- **Compliant with UL, c-UL and CE.**

## Product types

Digit	Count speed	Output mode	Output	Operating voltage	Power down insurance	Terminal type	Part number
4	30 Hz (cps)/ 5 KHz (Kcps) switchable	<ul style="list-style-type: none"> <li>• Maintain output/hold count</li> <li>• Maintain output/over count I</li> <li>• Maintain output/over count II</li> <li>• One shot/over count</li> <li>• One shot/recount I</li> <li>• One shot/recount II</li> <li>• One shot/hold count (7 modes)</li> </ul>	Relay (1c)	100 to 240 V AC	Available	8 pins	LC4H8-R4-AC240V
				24 V AC		11 pins	LC4H-R4-AC240V
				12 to 24 V DC		Screw terminal	LC4H-R4-AC240VS
				100 to 240 V AC		8 pins	LC4H8-R4-AC24V
				24 V AC		11 pins	LC4H-R4-AC24V
				12 to 24 V DC		Screw terminal	LC4H-R4-AC24VS
			Transistor (1a)	100 to 240 V AC		8 pins	LC4H8-R4-DC24V
				24 V AC		11 pins	LC4H-R4-DC24V
				12 to 24 V DC		Screw terminal	LC4H-R4-DC24VS
				100 to 240 V AC		8 pins	LC4H8-T4-AC240V
				24 V AC		11 pins	LC4H-T4-AC240V
				12 to 24 V DC		Screw terminal	LC4H-T4-AC240VS
6			Relay (1c)	100 to 240 V AC	Available	8 pins	LC4H8-R6-AC240V
				24 V AC		11 pins	LC4H-R6-AC240V
				12 to 24 V DC		Screw terminal	LC4H-R6-AC240VS
				100 to 240 V AC		8 pins	LC4H8-R6-AC24V
				24 V AC		11 pins	LC4H-R6-AC24V
				12 to 24 V DC		Screw terminal	LC4H-R6-AC24VS
			Transistor (1a)	100 to 240 V AC		8 pins	LC4H8-R6-DC24V
				24 V AC		11 pins	LC4H-R6-DC24V
				12 to 24 V DC		Screw terminal	LC4H-R6-DC24VS
				100 to 240 V AC		8 pins	LC4H8-T6-AC240V
				24 V AC		11 pins	LC4H-T6-AC240V
				12 to 24 V DC		Screw terminal	LC4H-T6-AC240VS
	8 pins	LC4H8-T6-AC24V					
	11 pins	LC4H-T6-AC24V					
	Screw terminal	LC4H-T6-AC24VS					
	8 pins	LC4H8-T6-DC24V					
	11 pins	LC4H-T6-DC24V					
	Screw terminal	LC4H-T6-DC24VS					

\* A rubber gasket (ATC18002) and a mounting frame (AT8-DA4) are included.

# LC4H

## Part names

### • 4-digit display type

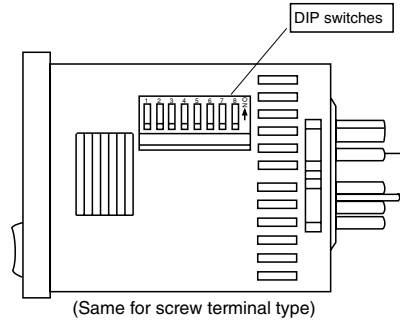
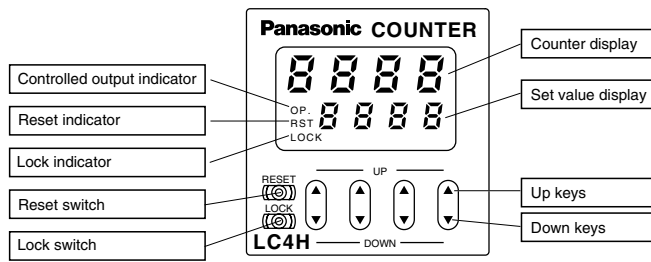

### • 6-digit display type

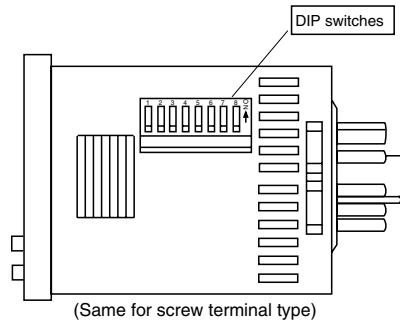
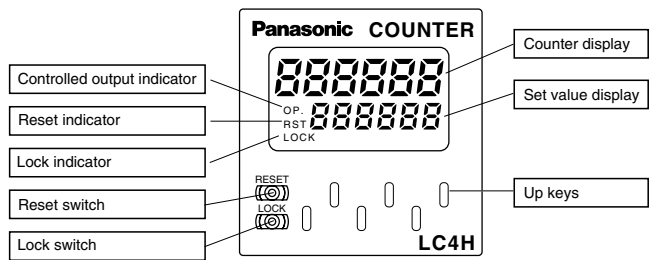

## Specifications

Item	Relay output type		Transistor output type	
	AC type	DC type	AC type	DC type
Rated operating voltage	100 to 240 V AC, 24 V AC	12 to 24 V DC	100 to 240 V AC, 24 V AC	12 to 24 V DC
Rated frequency	50/60 Hz common		50/60 Hz common	
Rated power consumption	Max. 10 V A	Max. 3 W	Max. 10 V A	Max. 3 W
Rated control capacity	5 A 250 V AC (resistive load)		100 mA 30 V DC	
Input mode	Addition (UP)/Subtraction (DOWN)/Direction (DIR)/Individuality (IND)/Phase (PHASE) 5 modes selectable by DIP switch			
Max. counting speed	30 Hz/5 kHz (selectable by DIP switch)			
Counting input (Input 1, 2)	Min. input signal width: 16.7 ms at 30 Hz/0.1 ms at 5 kHz, ON time: OFF time = 1:1			
Reset input	Min. input signal width: 1 ms, 20 ms (selected by DIP switch)			
Lock input	Min. input signal width: 20 ms			
Input signal	Contact or Open collector input/Input impedance: 1 kΩ or less, Input residual voltage: 2 V or less, Open impedance: 100 kΩ or more, Max. energized voltage: 40 V DC			
Output mode	HOLD-A/HOLD-B/HOLD-C/SHOT-A/SHOT-B/SHOT-C/SHOT-D (7 modes selectable by DIP switch)			
One shot output time	Approx. 1 s			
Indication	7-segment LCD, Counter value (backlight red LED), Setting value (backlight yellow LED)			
Digit	4-digit display type -999 to 9999 (-3 digits to +4 digits) (0 to 9999 for setting) 6-digit display type -99999 to 999999 (-5 digits to 6 digits) (0 to 999999 for setting)			
Memory	EEP-ROM (Overwriting times: 10 <sup>5</sup> ope. or more)			
Contact	1 Form C		1 Form A (Open collector)	
Initial contact resistance	100 mΩ (at 1 A 6 V DC)		—	
Contact material	Ag alloy/Au flush		—	
Life	Mechanical (contact) 2x10 <sup>6</sup> ope. (Except for switch operation parts)		—	
Electrical (contact)	10 <sup>6</sup> ope. (At rated control voltage)		10 <sup>6</sup> ope. (At rated control voltage)	
Allowable operating voltage range	85 to 110 % of rated operating voltage			
Break down voltage (Initial value)	Between live and dead metal parts: 2,000 Vrms for 1 min (11-pin type) Between input and output: 2,000 Vrms for 1 min Between open contacts: 1,000 Vrms for 1 min		Between live and dead metal parts: 2,000 Vrms for 1 min (11-pin type) Between input and output: 2,000 V AC for 1 min	
Insulation resistance (At 500 V DC) (Initial value)	Between live and dead metal parts: Min. 100 MΩ (11-pin type) Between input and output: Min. 100 MΩ Between open contact: Min. 100 MΩ		Between live and dead metal parts: Min. 100 MΩ (11-pin type) Between input and output: Min. 100 MΩ	
Temperature rise	Max. 65° C (under the flow of nominal operating current at nominal voltage)			
Mechanical	Vibration resistance	Functional	10 to 55 Hz (1 cycle/min), single amplitude: 0.35 mm (10 min on 3 axes)	
		Destructive	10 to 55 Hz (1 cycle/min), single amplitude: 0.75 mm (1 h on 3 axes)	
	Shock resistance	Functional	Min. 98 m 321.522 ft./s <sup>2</sup> (4 times on 3 axes)	
		Destructive	Min. 294 m 964.567 ft./s <sup>2</sup> (5 times on 3 axes)	
Operating conditions	Ambient temperature	-10° C to 55° C +14° F to +131° F		
	Ambient humidity	Max. 85 % RH (non-condensing)		
	Air pressure	860 to 1,060 h Pa		
	Ripple rate	—	20 % or less	—
Connection	8-pin/11-pin/screw terminal			
Protective construction	IP66 (front panel with a rubber gasket)			

# LC4H

## Applicable standard

Safety standard	EN61812-1	Pollution Degree 2/Overtoltage Category II
EMC	(EM)EN61000-6-4 Radiation interference electric field strength Noise terminal voltage (EMS)EN61000-6-2 Static discharge immunity	EN55011 Group1 ClassA EN55011 Group1 ClassA
	RF electromagnetic field immunity EFT/B immunity Surge immunity Conductivity noise immunity Power frequency magnetic field immunity Voltage dip/Instantaneous stop/Voltage fluctuation immunity	EN61000-4-2 4 kV contact 8 kV air EN61000-4-3 10 V/m AM modulation (80 MHz to 1 GHz) 10 V/m pulse modulation (895 MHz to 905 MHz) EN61000-4-4 2 kV (power supply line) 1 kV (signal line) EN61000-4-5 1 kV (power line) EN61000-4-6 10 V/m AM modulation (0.15 MHz to 80 MHz) EN61000-4-8 30 A/m (50 Hz) EN61000-4-11 10 ms, 30% (rated voltage) 100 ms, 60% (rated voltage) 1,000 ms, 60% (rated voltage) 5,000 ms, 95% (rated voltage)

## Dimensions

mm inch

General tolerance:  $\pm 1.0 \pm 0.039$

### • 4-digit display type

Screw terminal type: M3.5  
(Flush mount)

Pin type  
(Flush mount/Surface mount)

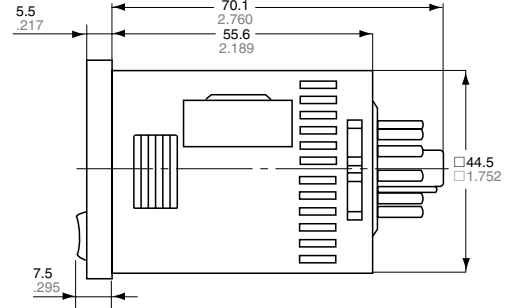
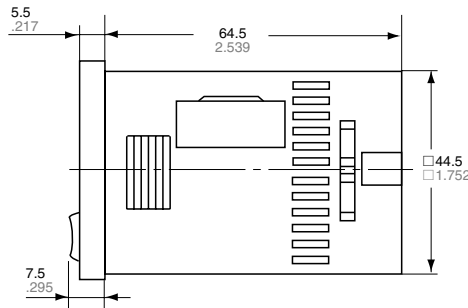
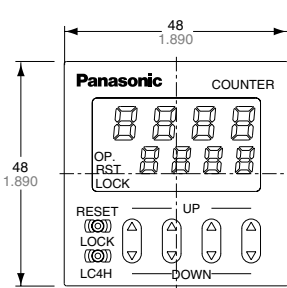

### • 6-digit display type

Screw terminal type: M3.5  
(Flush mount)

Pin type  
(Flush mount/Surface mount)

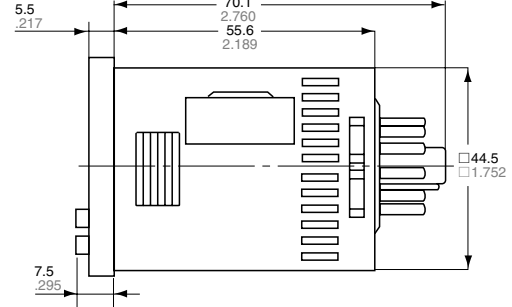
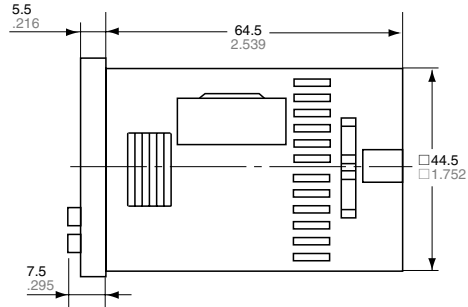
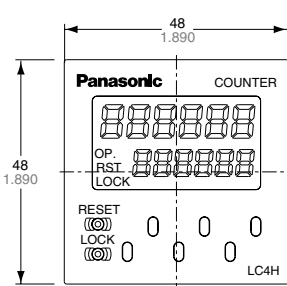

# LC4H

## • Dimensions for flush mounting (with adapter installed)

Screw terminal type: M3.5

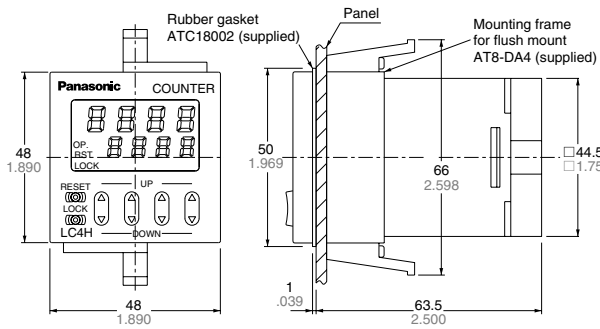

Pin type

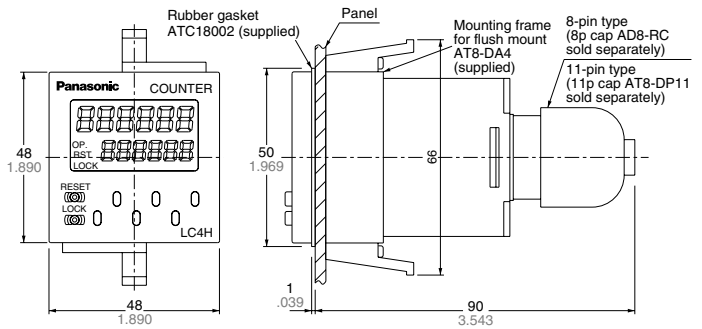

## • Dimensions for front panel installations

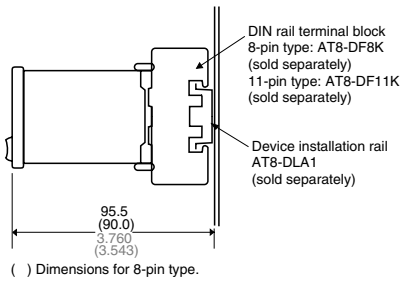

( ) Dimensions for 8-pin type.

## • Installation panel cut-out dimensions

The standard panel cut-out dimensions are shown below. Use the mounting frame (AT8-DA4) and rubber gasket (ATC18002).

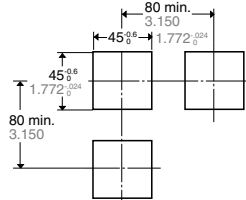

## • For connected installations

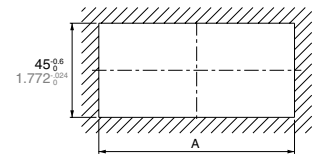

$$A = (48 \times n - 2.5) \pm 0.6$$

Note 1: The installation panel thickness should be between 1 and 5 mm .039 and .197 inch.

Note 2: For connected installations, the waterproofing ability between the unit and installation panel is lost.

## Terminal layouts and wiring diagrams

### • 8-pin type

Relay output type

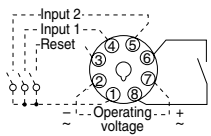

Transistor output type

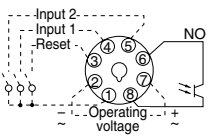

### • 11-pin type

Relay output type

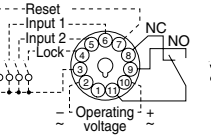

Transistor output type

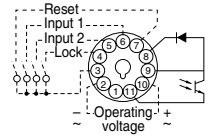

### • Screw terminal type

Relay output type

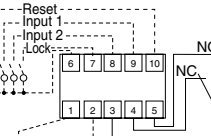

Transistor output type

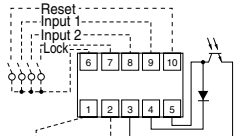

Note) For connecting the output leads of the transistor output type, refer to 5) Transistor output on page 115.

## Setting the operation mode and set value

### Setting procedure 1) Setting the operation mode (input mode and output mode)

Set the input and output modes with the DIP switches on the side of the counter.

#### DIP switches

	Item	DIP switch	
		OFF	ON
1	Output mode	Refer to table 1	
2			
3			
4	Minimum reset input signal width	20 ms	1 ms
5	Maximum counter speed	30 Hz	5 kHz
6	Input mode	Refer to table 2	
7			
8			

Table 1: Setting the output mode

DIP switch No.			Output mode
1	2	3	
ON	ON	ON	SHOT-A
OFF	OFF	OFF	SHOT-B
ON	OFF	OFF	SHOT-C
OFF	ON	OFF	SHOT-D
ON	ON	OFF	HOLD-A
OFF	OFF	ON	HOLD-B
ON	OFF	ON	HOLD-C
OFF	ON	ON	— (See note 1)

Table 2: Setting the input mode

DIP switch No.			Input mode
6	7	8	
ON	ON	ON	Addition input
OFF	OFF	OFF	Subtraction input
ON	OFF	OFF	Directive input
OFF	ON	OFF	Independent input
ON	ON	OFF	Phase input
OFF	OFF	ON	— (See note 1)
ON	OFF	ON	— (See note 1)
OFF	ON	ON	— (See note 1)

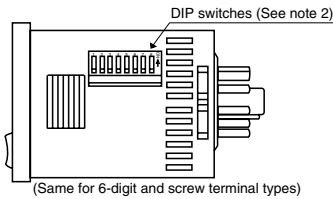

- Notes: 1) The counter and set value displays will display DIP Err.  
 2) Set the DIP switches before installing the counter on the panel.  
 3) When the DIP SW setting is changed, turn off the power once.  
 4) The DIP switches are set as ON before shipping.

### Setting procedure 2) Setting the set value

Set the set value with the UP and DOWN keys on the front of the counter.

#### Front display section

##### • 4-digit display type

- ① Counter display
  - ② Set value display
  - ③ Controlled output indicator
  - ④ Reset indicator
  - ⑤ Lock indicator
  - ⑥ UP keys
- Changes the corresponding digit of the set value in the addition direction (upwards).

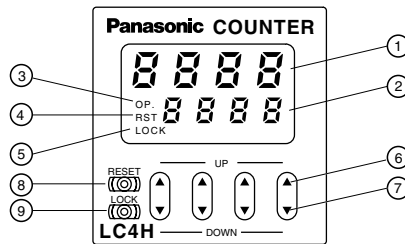

##### • 6-digit display type

- ① Counter display
- ② Set value display
- ③ Controlled output indicator
- ④ Reset indicator
- ⑤ Lock indicator

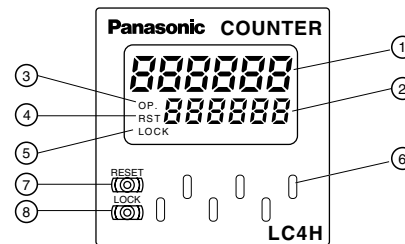

- ⑦ DOWN keys
- Changes the corresponding digit of the set value in the subtraction direction (downwards).
- ⑧ RESET switch
- Resets the counting value and the output.
- ⑨ LOCK switch
- Locks the operation of all keys on the counter.

- ⑥ UP keys
- Changes the corresponding digit of the set value in the addition direction (upwards).
- ⑦ RESET switch
- Resets the counting value and the output.
- ⑧ LOCK switch
- Locks the operation of all keys on the counter.

#### • Changing the set value

**1. It is possible to change the set value with the up and down keys (4-digit type only) even during counting. However, be aware of the following points.**

1) If the set value is changed to less than the count value with counting set to the addition direction, counting will continue until it reaches full scale (9999 with the 4-digit type and 999999 with the 6-digit type), returns to zero, and then reaches the new set value. If the set value is changed to a value above the count value, counting will continue until the count value reaches the new set value.

2) Suppose that the counter is preset to count down. Whether a preset count-down value is smaller or larger than the count value, the counter counts down to "0(Zero)".

**2. If the set value is changed to "0," the unit will not complete count-up. It starts counting up when the counting value comes to "0 (Zero)" again.**

1) Up-count (addition) input when counting is set to the addition direction, counting will continue until full scale is reached (9999 with the 4-digit type and 999999 with the 6-digit type), return to zero, and then complete count-up.

2) Down-count (subtraction) input when counting is set to the subtraction direction, counting will continue until full scale is reached (-999 with the 4-digit type and -999999 with the 6-digit type), and then the display will change to with the 4-digit type and with the 6-digit type. The counting value does not become "0" and so the counter does not count up.

3) For directive, independent, and phase input, when the counting value increases or decreases from the value „0“ and then returns back to the value „0,“ count-up is completed.

## Operation modes

### 1. Input mode

For the input mode, you can choose one of the following five modes

- Addition UP
- Subtraction DOWN
- Directive DIR
- Independent IND
- Phase PHASE

Input mode	Operation	*Minimum input signal width 30 Hz: 16.7 ms; 5 kHz: 0.1 ms
Addition <span style="border: 1px solid black; padding: 2px;">UP</span>	IN1 or IN2 works as an input block (gate) for the other input.	<p>• Example where IN1 is the count counting and IN2 is the input block (gate).</p>
Subtraction <span style="border: 1px solid black; padding: 2px;">DOWN</span>		<p>• Example where IN2 is the counting input and IN1 is the input block (gate).</p>
Directive <span style="border: 1px solid black; padding: 2px;">DIR</span>	IN1 is the counting input and IN2 is the addition or subtraction directive input. IN2 adds at L level and subtracts at H level.	
Independent <span style="border: 1px solid black; padding: 2px;">IND</span>	IN1 is addition input and IN2 is subtraction input.	
Phase <span style="border: 1px solid black; padding: 2px;">PHASE</span>	Addition when the IN1 phase advances beyond IN2, and subtraction when the IN2 phase advances beyond IN1.	

## 2. Output mode

For the output mode, you can choose one of the following seven modes

- Maintain output/hold count HOLD-A
- Maintain output/over count I HOLD-B
- Maintain output/over count II HOLD-C
- One shot/over count SHOT-A
- One shot/recount I SHOT-B
- One shot/recount II SHOT-C
- One shot/hold count SHOT-D

Output mode	Operation	(Example when input mode is either addition or subtraction)
Maintain output Hold count <span style="border: 1px solid black; padding: 2px;">HOLD-A</span>	Output control is maintained after count-up completion and until resetting. During that time, the count display does not change from that at count-up completion.	<p>* n: Set value</p>
Maintain output Over count I <span style="border: 1px solid black; padding: 2px;">HOLD-B</span>	Output control is maintained after count-up completion and until resetting. However, counting is possible despite completion of count-up.	<p>* n: Set value</p>
Maintain output Over count II <span style="border: 1px solid black; padding: 2px;">HOLD-C</span>	Output control is maintained after count-up completion and until the next signal enters. However, counting is possible despite completion of count-up.	<p>* n: Set value</p>
One shot Over count <span style="border: 1px solid black; padding: 2px;">SHOT-A</span>	Output control is maintained after count-up completion for a fixed time (approx. 1 sec). Counting is possible despite completion of count-up.	<p>* n: Set value</p>
One shot Recount I <span style="border: 1px solid black; padding: 2px;">SHOT-B</span>	Output control is maintained after count-up completion for a fixed time (approx. 1 sec). Counting is possible despite completion of count-up. However, reset occurs simultaneous with completion of count-up. While output is being maintained, restarting of the count is not possible	<p>* n: Set value</p>
One shot Recount II <span style="border: 1px solid black; padding: 2px;">SHOT-C</span>	Output control is maintained after count-up completion for a fixed time (approx. 1 sec). Counting is possible despite completion of count-up. However, reset occurs simultaneous with output OFF.	<p>* n: Set value</p>
One shot Hold count <span style="border: 1px solid black; padding: 2px;">SHOT-D</span>	Output control is maintained after count-up completion for a fixed time (approx. 1 sec). During that time, the count display does not change from that at count-up completion. Reset occurs simultaneous with output OFF.	<p>* n: Set value</p>



**Panasonic**  
ideas for life

**DIN 48 SIZE  
LCD ELECTRONIC  
COUNTER**

**LC4H-S**



4-digit type



6-digit type



11 pin type



Screw terminal type

UL File No.: E122222  
C-UL File No.: E122222



## Features

- **Bright and Easy-to-Read Display**  
A brand new bright 2-color backlight LCD display. The easy-to-read screen in any location makes checking and setting procedures a cinch.
- **Easy to use, simple operation, simple settings**
- Operation modes (input/output modes) can be set easily, using DIP switches on the side panel.
- Values can be set easily, using key switches on the front panel.
- **Pre-scaling function provided**  
A pre-scaling function enables conversion of lengths and volumes to any desired values, and displays the results.
- **Built-in power supply for high-capacitance sensor**  
An internal power supply drives a 12 VDC, 100 mA high-capacitance sensor. (AC power supply types only)  
Photoelectric switches, proximity switches and encoders can be directly connected.
- **Dual-path AC sensor can be connected.**
- **Basic insulation between the power supply and the input terminal (only for the sensor type model with power supply)**  
There is no need for caution when connecting between terminals.
- **Conforms to IP66's Weather Resistant Standards**  
The water-proof panel keeps out water and dirt for reliable operation even in poor environments.
- **4-digit or 6-digit display**  
Two sizes of displays are offered for you to choose the one that suits your needs.
- **Screw terminal and Pin Type are Both Standard Options**  
The two terminal types are standard options to support either front panel installation or embedded installation.
- **Compliant with UL, c-UL and CE.**

## Product types

Digit	Count speed	Output	Operation voltage	Power down insurane	Additional function	Terminal	P/N
4	30 Hz (cps) 5 kHz (kcps) switchable	Relay	100-240 V AC with 12V DC power supply	Available	Scale Factor	11 Pin	LC4H-PS-R4-AC240V
					Scale Factor	Screw	LC4H-PS-R4-AC240VS
					Scale Factor / Voltage Signal Input	11 Pin	LC4H-PSV-R4-AC240V
					Scale Factor / Voltage Signal Input	Screw	LC4H-PSV-R4-AC240VS
					Scale Factor	11 Pin	LC4H-S-R4-24V
					Scale Factor	Screw	LC4H-S-R4-24VS
		Transistor	12-24 V DC / 24 V AC		Scale Factor / Voltage Signal Input	11 Pin	LC4H-SV-R4-24V
					Scale Factor / Voltage Signal Input	Screw	LC4H-SV-R4-24VS
					Scale Factor	11 Pin	LC4H-S-T4-24V
					Scale Factor	Screw	LC4H-S-T4-24VS
					Scale Factor / Voltage Signal Input	11 Pin	LC4H-SV-T4-24V
					Scale Factor / Voltage Signal Input	Screw	LC4H-SV-T4-24VS
6		Relay	100-240 V AC with 12V DC power supply	Scale Factor	11 Pin	LC4H-PS-R6-AC240V	
				Scale Factor	Screw	LC4H-PS-R6-AC240VS	
				Scale Factor / Voltage Signal Input	11 Pin	LC4H-PSV-R6-AC240V	
				Scale Factor / Voltage Signal Input	Screw	LC4H-PSV-R6-AC240VS	
				Scale Factor	11 Pin	LC4H-S-R6-24V	
				Scale Factor	Screw	LC4H-S-R6-24VS	
		Transistor	12-24 V DC / 24 V AC	Scale Factor / Voltage Signal Input	11 Pin	LC4H-SV-R6-24V	
				Scale Factor / Voltage Signal Input	Screw	LC4H-SV-R6-24VS	
				Scale Factor	11 Pin	LC4H-S-T6-24V	
				Scale Factor	Screw	LC4H-S-T6-24VS	
				Scale Factor / Voltage Signal Input	11 Pin	LC4H-SV-T6-24V	
				Scale Factor / Voltage Signal Input	Screw	LC4H-SV-T6-24VS	

# LC4H-S

## Part names

### • 4-digit display type

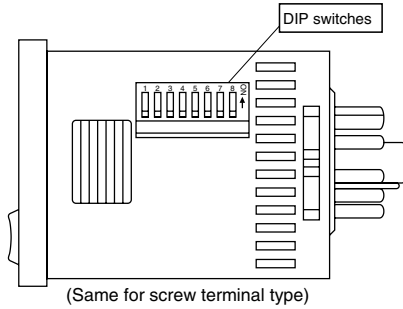
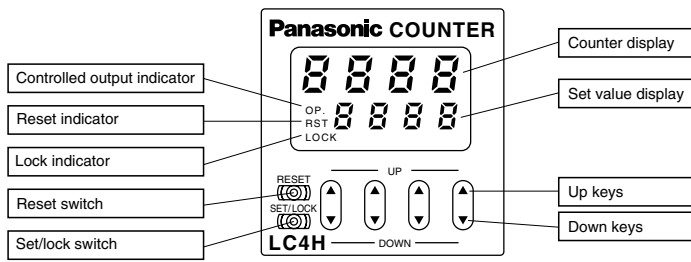

### • 6-digit display type

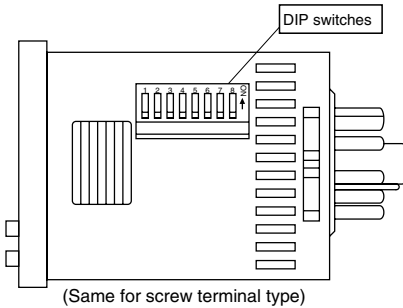
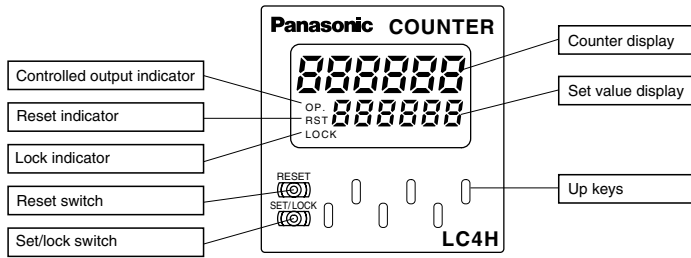

## Specifications

Item	Relay output type		Transistor output type
	AC type	DC/AC type	DC/AC type
Rated operating voltage	100 to 240 V	12 to 24 V DC/24 V AC	12 to 24 V DC/24 V AC
Rated frequency	50/60 Hz common		
Rated power consumption	Max. 10 V A	Max. 3 W	
Rated control capacity	5 A 250 V AC (resistive load)		100 mA, 30 V DC
Input mode	Addition (UP)/Subtraction (DOWN)/Direction (DIR)/Individuality (IND)/Phase (PHASE) 5 modes selectable by DIP switches		
Max. counting speed	30 Hz, 5 kHz (selectable by DIP switches)		
Counting input (input 1, input 2)	16.7 ms at 30 Hz/0.1 ms at 5 kHz ON time: OFF time = 1:1		
Reset input	Min. input signal width: 1 ms, 20 ms (selected by DIP switches)		
Lock input	Min. input signal width: 20 ms		
Input signal	Contact, Open collector input/DC two-wire system sensor Input impedance: 1 kΩ or less, Input residual voltage: 2 V or less, Open impedance: 100 kΩ or less, Max. energized voltage: 40 V DC		
Output mode	HOLD-A, HOLD-B, HOLD-C, SHOT-A, SHOT-B, SHOT-C, SHOT-D, 7 modes selectable by DIP switches		
One shot output time	1 s, 0.5s, 0.2s, 0.1s, 0.05, 0.01s		
Indication	7-segment LCD, Counter value (backlight red LED), Setting value (backlight yellow LED)		
Digit	4-digit display type -999 to 9999 (0 to 9999 for setting) 6-digit display type -99999 to 999999 (0 to 999999 for setting)		
Decimal point	Can be set to three digits		
Pre-scaling	0.001 to 9.999 (4-digit type), 0.001 to 99.999 (6-digit type)		
Memory	EEP-ROM (Overwriting times: 10 <sup>5</sup> ope. or more)		
Power for sensor	12 V DC (±10%) 100 mA Max.	—	
Contact	Contact arrangement		1 Form C
	Initial contact resistance		100 mΩ (at 1 A 6 V DC)
	Contact material		Ag alloy/Au flush
Life	Mechanical (contact)		2x10 <sup>5</sup> ope. (Except for switch operation parts)
	Electrical (contact)		10 <sup>5</sup> ope. (At rated control voltage)
Electrical	Operating voltage range		85 to 264 V AC
	Initial withstand voltage		10.8 to 26.4 V DC, 20.4 to 26.4 V AC
	Initial insulation resistance (At 500 V DC)		Between live and dead metal parts: 2,000 Vrms for 1 min (pin type) Between input and output: 2,000 Vrms for 1 min
	Temperature rise		Between live and dead metal parts: Min. 100 MΩ (pin type) Between input and output: Min. 100 MΩ
Mechanical	Vibration resistance		Max. 65° C (under the flow of nominal operating current at nominal voltage)
	Functional	10 to 55 Hz (1 cycle/min), single amplitude: 0.35 mm (10 min on 3 axes)	
	Destructive	10 to 55 Hz (1 cycle/min), single amplitude: 0.75 mm (1 h on 3 axes)	
	Shock resistance	Functional	
	Destructive	Min. 98 m/s <sup>2</sup> (4 times on 3 axes) Min. 294 m/s <sup>2</sup> (5 times on 3 axes)	
Operating conditions	Ambient temperature		-10° C to 55° C +14° F to +131° F
	Ambient humidity		Max. 85 % RH (non-condensing)
	Air pressure		860 to 1,060 h Pa
Connection	11-pin/screw terminal		
Protective construction	IP66 (front panel with a rubber gasket)		

# LC4H-S

## Applicable standard

Safety standard	EN61812-1	Pollution Degree 2/Overvoltage Category II
EMC	(EM)EN61000-6-4 Radiation interference electric field strength Noise terminal voltage (EMS)EN61000-6-2 Static discharge immunity  RF electromagnetic field immunity  EFT/B immunity  Surge immunity Conductivity noise immunity Power frequency magnetic field immunity Voltage dip/Instantaneous stop/Voltage fluctuation immunity	EN55011 Group1 ClassA EN55011 Group1 ClassA  EN61000-4-2 4 kV contact 8 kV air EN61000-4-3 10 V/m AM modulation (80 MHz to 1 GHz) 10 V/m pulse modulation (895 MHz to 905 MHz) EN61000-4-4 2 kV (power supply line) 1 kV (signal line) EN61000-4-5 1 kV (power line) EN61000-4-6 10 V/m AM modulation (0.15 MHz to 80 MHz) EN61000-4-8 30 A/m (50 Hz) EN61000-4-11 10 ms, 30% (rated voltage) 100 ms, 60% (rated voltage) 1,000 ms, 60% (rated voltage) 5,000 ms, 95% (rated voltage)

## Dimensions

mm inch  
General tolerance:  $\pm 1.0 \pm .039$

Pin type (Flush mount/Surface mount)

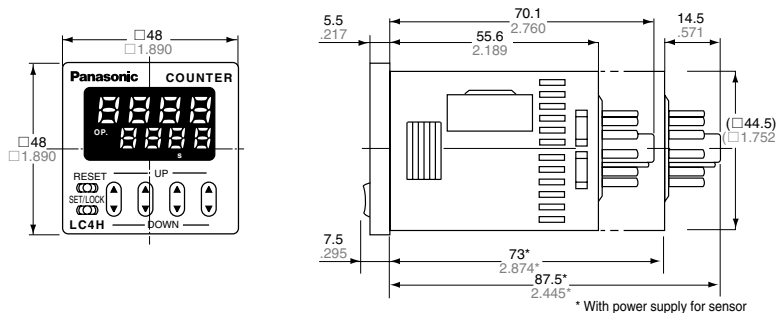

Screw terminal type: M3.5 (Flush mount)

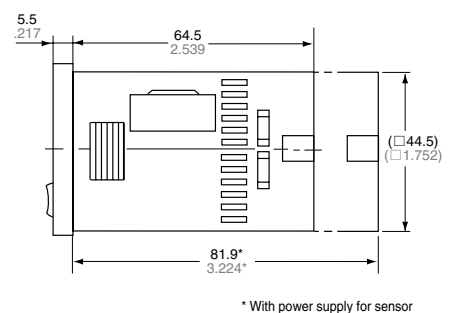

(\* 6-digit display type has the same dimensions.)

### • Dimensions for flush mounting (with adapter installed)

Screw terminal type

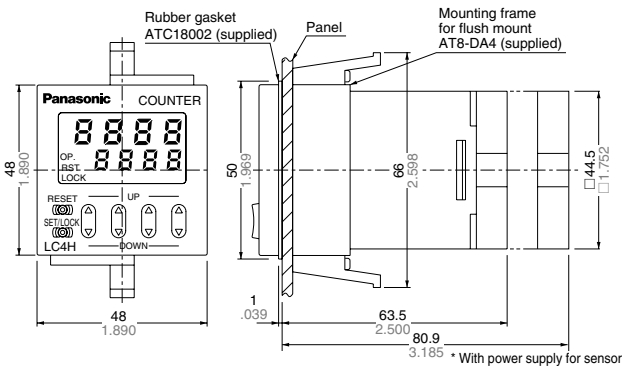

Pin type

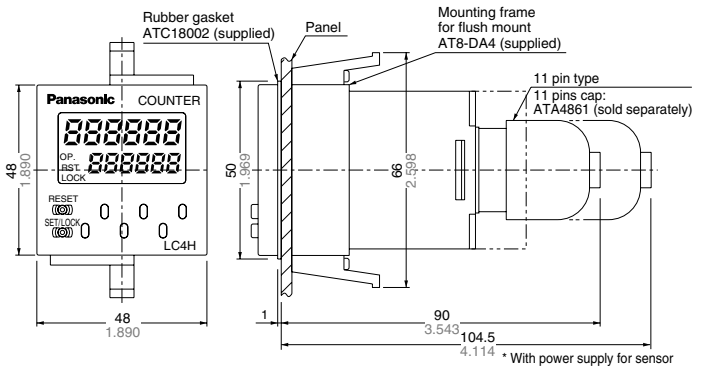

### • Dimensions for front panel installations

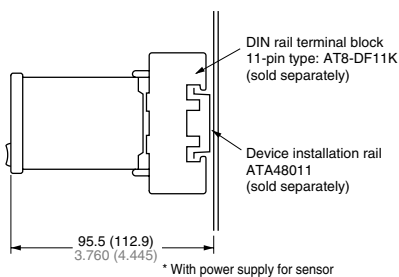

### • Installation panel cut-out dimensions

The standard panel cut-out dimensions are shown below. Use the mounting frame (AT8-DA4) and rubber gasket (ATC18002).

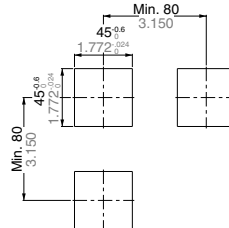

### • For connected installations

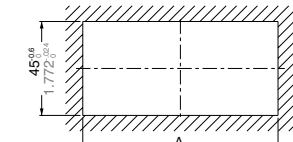

When n units are attached in a continuous series, the dimension of (A) is:

$$A = (48 \times n - 2.5) \pm 0.6$$

Note 1: The installation panel thickness should be between 1 and 5 mm .039 and .197 inch.

Note 2: For connected installations, the waterproofing ability between the unit and installation panel is lost.

## Terminal layouts and wiring diagrams

### • Pin type

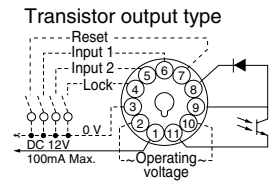
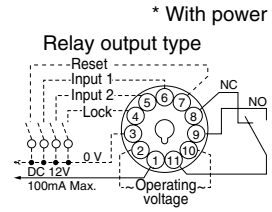
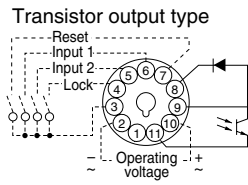
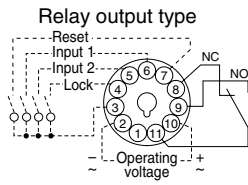

### • Screw terminal type

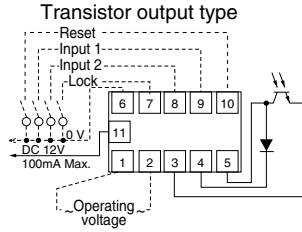
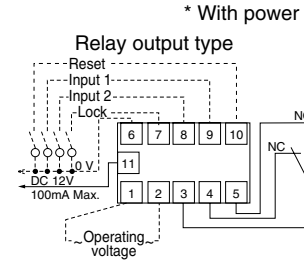
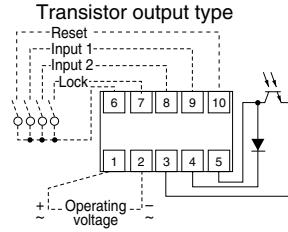
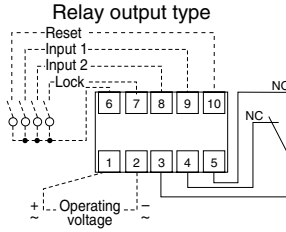

Note) For connecting the output leads of the transistor output type, refer to 5) Transistor output on page 115.

## Setting the operation mode and counter

### Setting procedure 1) Setting the operation mode (input mode and output mode)

Set the input and output modes with the DIP switches on the side of the counter.

#### DIP switches

	Item	DIP switch	
		OFF	ON
1	Output mode	Refer to table 1	
2			
3			
4	Minimum reset input signal width	20 ms	1 ms
5	Maximum counter setting	30 Hz	5 kHz
6	Input mode	Refer to table 2	
7			
8			

Table 1: Setting the output mode

DIP switch No.			Output mode
1	2	3	
ON	ON	ON	SHOT-A
OFF	OFF	OFF	SHOT-B
ON	OFF	OFF	SHOT-C
OFF	ON	OFF	SHOT-D
ON	ON	OFF	HOLD-A
OFF	OFF	ON	HOLD-B
ON	OFF	ON	HOLD-C
OFF	ON	ON	— (See note 1)

Table 2: Setting the input mode

DIP switch No.			Input mode
6	7	8	
ON	ON	ON	Addition input
OFF	OFF	OFF	Subtraction input
ON	OFF	OFF	Directive input
OFF	ON	OFF	Independent input
ON	ON	OFF	Phase input
OFF	OFF	ON	— (See note 1)
ON	OFF	ON	— (See note 1)
OFF	ON	ON	— (See note 1)

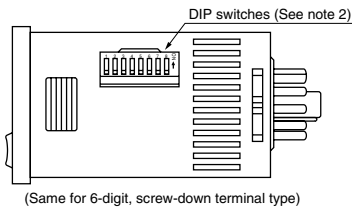

Notes: 1) The counter and set value displays will display DIP Err.  
 2) Set the DIP switches before installing the counter on the panel.  
 3) When the DIP SW setting is changed, turn off the power once.  
 4) The DIP switches are set as ON before shipping.

### Setting procedure 2) Setting the set value

Set the set value with the UP and DOWN keys on the front of the counter.

#### Front display section

##### • 4-digit display type

- ① Counter display
  - ② Set value display
  - ③ Controlled output indicator
  - ④ Reset indicator
  - ⑤ Lock indicator
  - ⑥ UP keys
- Changes the corresponding digit of the set value in the addition direction (upwards)

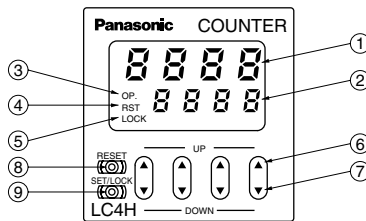

- ⑦ DOWN keys  
Changes the corresponding digit of the set value in the subtraction direction (downwards)
- ⑧ RESET switch  
Resets the counting value and the output
- ⑨ SET/LOCK switch  
This is used to handle pre-scaling values, one-shot times, decimal point position settings, and key lock operations (to disable Up key, Down key, and Reset key operations).

##### • 6-digit display type

- ① Counter display
- ② Set value display
- ③ Controlled output indicator
- ④ Reset indicator
- ⑤ Lock indicator

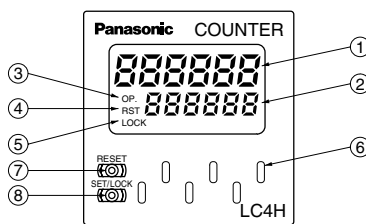

- ⑥ UP keys  
Changes the corresponding digit of the set value in the addition direction (upwards)
- ⑦ RESET switch  
Resets the counting value and the output
- ⑧ SET/LOCK switch  
This is used to handle pre-scaling values, one-shot times, decimal point position settings, and key lock operations (to disable Up key, Down key, and Reset key operations).

### Setting procedure 3) Setting the input mode

The input mode is set using the key switch in the [Display] section on the front of the counter.

#### • Decimal point position setting mode

- ① Holding down the [SET/LOCK] key, press the key for the second digit to access the decimal point position setting mode.

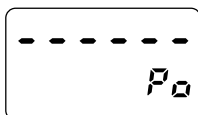

Example) 6-digit type  
 Decimal point position setting mode display  
 (Example shows default value displayed)

- ② When the setting mode has been accessed, release the [SET/LOCK] key.

- ③ The decimal point is set using the [UP] and [DOWN] keys to specify the 2nd, 3rd, and 4th digits (this applies only to 4-digit models). (The 1st digit is set using the [UP] key or [DOWN] key in settings where there is no decimal point (this applies only to 4-digit models).)

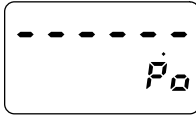

Example) 6-digit type  
Example shows 2nd digit displayed using [UP] key

- ④ Press the [RESET] key to set the displayed decimal point position and return to normal operation.

### • Setting the pre-scaling value

- ① Holding down the [SET/LOCK] key, press the key for the first digit to access the pre-scaling value setting mode.

Example) 4-digit type



Example) 6-digit type



Pre-scaling value setting mode displayed  
(Example shows default values displayed)

- ② When the setting mode has been accessed, release the [SET/LOCK] key.
- ③ Use the [UP] or [DOWN] key to set the pre-scaling value (this applies only to 4-digit models).  
Select either: 0.001 to 9.999 (4-digit) or 0.001 to 99.999 (6-digit)
- ④ Press the [RESET] key to set the displayed pre-scaling value and return to normal operation.

### • Setting the one-shot output time

- ① Holding down the [SET/LOCK] key, press the key for the third digit to access the one-shot output time setting mode.

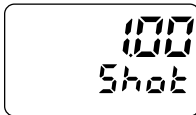

Example) 6-digit type  
One-shot output time setting mode displayed  
(Example shows default value displayed)

- ② When the setting mode has been accessed, release the [SET/LOCK] key.
- ③ Each time the 1st-digit [UP] key is pressed, the one-shot output time changes in the following sequence, moving to the right:

→ 1 s → 0.5 s → 0.2 s → 0.1 s → 0.05 s → 0.01 s →

(With a 4-digit type, the [DOWN] key can also be used to move to the left.)

- ④ Press the [RESET] key to set the displayed one-shot output time and return to normal operation.

## Changing the set value

**1. It is possible to change the set value with the up and down keys (4-digit type only) even during counting. However, be aware of the following points.**

1) If the set value is changed to less than the count value with counting set to the addition direction, counting will continue until it reaches full scale (9999 with the 4-digit type and 999999 with the 6-digit type), returns to zero, and then reaches the new set value. If the set value is changed to a value above the count value, counting will continue until the count value reaches the new set value.

2) Suppose that the counter is preset to count down. Whether a preset count-down value is smaller or larger than the count value, the counter counts down to "0 (zero)".

**2. If the set value is changed to "0," the unit will not complete count-up. It starts counting up when the counting value comes to "0 (zero)" again.**

1) Up-count (addition) input  
When counting is set to the addition direction, counting will continue until full scale is reached (9999 with the 4-digit type and 999999 with the 6-digit type), return to zero, and then complete count-up.

2) Down-count (subtraction) input  
When counting is set to the subtraction direction, counting will continue until full scale is reached (-999 with the 4-digit type and -99999 with the 6-digit type), and then the display will change to - - - - with the 4-digit type and - - - - - with the 6-digit type.

The counting value does not become "0 (zero)" and so the counter does not count up.

3) Directive, independent, and phase inputs  
The counting value is counted up or down to any number other than "0" once. When it comes to "0 (zero)" again, the counter starts counting up.

## Cautions for use

For more information regarding the cautions for use of LC4H series counter, refer to page 114 "PRECAUTIONS IN USING THE LC4H SERIES".

## Operation mode

### 1. Input mode

For the input mode, you can choose one of the following five modes

- Addition UP
- Subtraction DOWN
- Directive DIR
- Independent IND
- Phase PHASE

Input mode	Operation	*Minimum input signal width 30 Hz: 16.7 ms; 5 kHz: 0.1 ms
Addition <span style="border: 1px solid black; padding: 2px;">UP</span>	IN1 or IN2 works as an input block (gate) for the other input.	<p>• Example where IN1 is the counting input and IN2 is the input block (gate).</p> <p>Counting (addition) 0 1 2 3 --- n-3 n-2 n-1 n</p> <p>Counting (subtraction) n n-1 n-2 n-3 --- 3 2 1 0</p> <p><math>\Delta</math> Reset <span style="float: right;"><math>\Delta</math> Count-up completed</span></p>
Subtraction <span style="border: 1px solid black; padding: 2px;">DOWN</span>		<p>• Example where IN2 is the counting input and IN1 is the input block (gate).</p> <p>Counting (addition) 0 1 2 3 4 --- n-1 n</p> <p>Counting (subtraction) n n-1 n-2 n-3 n-4 --- 1 0</p> <p><math>\Delta</math> Reset <span style="float: right;"><math>\Delta</math> Count-up completed</span></p>
Directive <span style="border: 1px solid black; padding: 2px;">DIR</span>	IN1 is the counting input and IN2 is the addition or subtraction directive input. IN2 adds at L level and subtracts at H level.	<p>Counting 0 1 2 3 4 3 2 1 0 1 2 3 4</p> <p><math>\Delta</math> Reset</p>
Independent <span style="border: 1px solid black; padding: 2px;">IND</span>	IN1 is addition input and IN2 is subtraction input.	<p>Counting 0 1 2 3 4 3 2 1 2 1 2 3</p> <p><math>\Delta</math> Reset</p>
Phase <span style="border: 1px solid black; padding: 2px;">PHASE</span>	Addition when the IN1 phase advances beyond IN2, and subtraction when the IN2 phase advances beyond IN1.	<p>Counting 0 1 2 3 2 1 0</p> <p><math>\Delta</math> Reset</p>

\* "A" must be more than the minimum input signal width.

\* "A" must be more than the minimum input signal width.

\* IN1 and IN2 are completely independent, so there is no restriction on signal timing.

\* "B" must be more than the minimum input signal width.

# LC4H-S

## 2. Output mode

For the output mode, you can choose one of the following seven modes

- Maintain output/hold count HOLD-A
- Maintain output/over count I HOLD-B
- Maintain output/over count II HOLD-C
- One shot/over count SHOT-A
- One shot/recount I SHOT-B
- One shot/recount II SHOT-C
- One shot/hold count SHOT-D

Output mode	Operation	(Example when input mode is either addition or subtraction)
Maintain output Hold count <span style="border: 1px solid black; padding: 2px;">HOLD-A</span>	Output control is maintained after count-up completion and until resetting. During that time, the count display does not change from that at count-up completion.	<p>* n: Set value</p>
Maintain output Over count I <span style="border: 1px solid black; padding: 2px;">HOLD-B</span>	Output control is maintained after count-up completion and until resetting. However, counting is possible despite completion of count-up.	<p>* n: Set value</p>
Maintain output Over count II <span style="border: 1px solid black; padding: 2px;">HOLD-C</span>	Output control is maintained after count-up completion and until the next signal enters. However, counting is possible despite completion of count-up.	<p>* n: Set value</p>
One shot Over count <span style="border: 1px solid black; padding: 2px;">SHOT-A</span>	Output control is maintained after count-up completion for one shot output time. Counting is possible despite completion of count-up.	<p>* n: Set value</p>
One shot Recount I <span style="border: 1px solid black; padding: 2px;">SHOT-B</span>	Output control is maintained after count-up completion for one shot output time. Counting is possible despite completion of count-up. However, reset occurs simultaneous with completion of count-up. While output is being maintained, restarting of the count is not possible	<p>* n: Set value</p>
One shot Recount II <span style="border: 1px solid black; padding: 2px;">SHOT-C</span>	Output control is maintained after count-up completion for one shot output time. Counting is possible despite completion of count-up. However, reset occurs simultaneous with output OFF.	<p>* n: Set value</p>
One shot Hold count <span style="border: 1px solid black; padding: 2px;">SHOT-D</span>	Output control is maintained after count-up completion for one shot output time. During that time, the count display does not change from that at count-up completion. Reset occurs simultaneous with output OFF.	<p>* n: Set value</p>



## Input connections

### • Signal input type

#### 1) Open collector

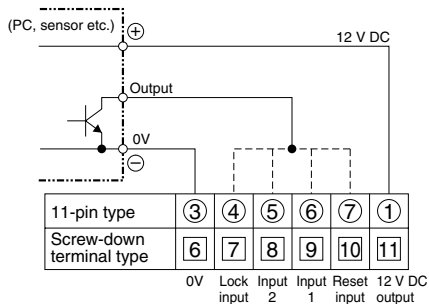

#### 2) For voltage output

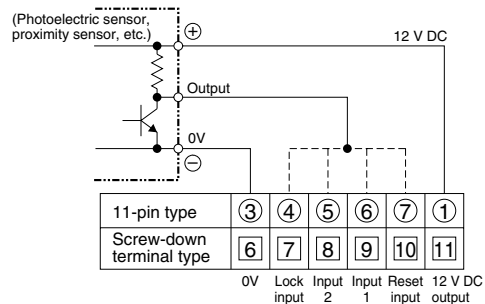

#### 3) Contact input

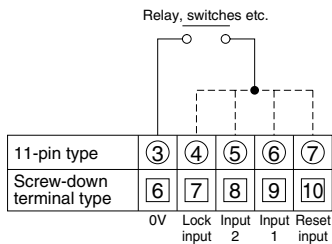

#### 4) For a rotary encoder

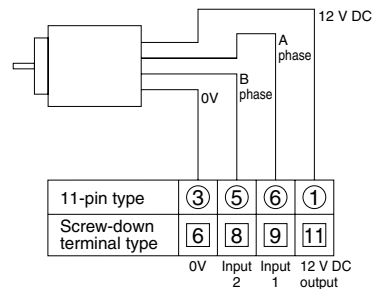

#### Input 1, input 2, and reset input specifications

- Impedance during short-circuit: 1 k $\Omega$  max.  
(At 0  $\Omega$ , the outflow current is approximately 12 mA.)
- Residual voltage during short-circuit: 2 V max.
- Impedance when released: 100 k $\Omega$  min.
- Max. applied voltage: 40 VDC max.

#### Lock input specifications

- Impedance during short-circuit: 1 k $\Omega$  max.  
(At 0  $\Omega$ , the outflow current is approximately 1.5 mA.)
- Residual voltage during short-circuit: 2 V max.
- Impedance when released: 100 k $\Omega$  min.
- Max. applied voltage: 40 DVC max.
- The contact relay should be one which can open/close 5 V, 1.5 mA.

\* There is no 12 V DC with 12 - 24 V DC/24 V AC types.

#### 5) For a dual-line sensor

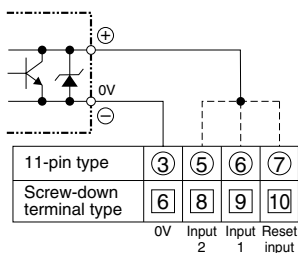

#### Dual-line sensor specifications

- Leakage current: 1.5 mA max.
- Breaker capacitance: 5 mA min.
- Residual voltage: 3.0 V max.
- Usable voltage: Runs on 10 VDC

\* If a dual-line sensor is connected to a 12 - 24 VDC/24 VAC type, 24 VDC (21.6 to 26.4 VDC) and 24 VAC (21.6 to 26.4 VAC) should be applied to the power supply voltage of the counter.

## What is the prescale function?

The prescale function converts the count into an actual value (amount) and displays it.

Example

For a device that outputs 500 pulses when 1 m has been fed:

1. Set decimal position to the last 3rd place.
2. Set the prescale value to 0.002 (1/500).

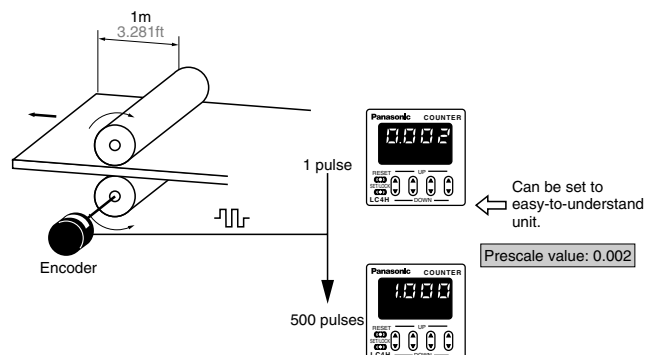

**Panasonic**  
ideas for life

**DIN 48 SIZE  
LCD ELECTRONIC  
COUNTER**

**LC4H-W**

UL File No.: E122222  
C-UL File No.: E122222

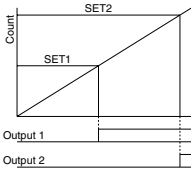

## Features

- **Two-stage presetting (upper and lower limits)**  

- **Bright and Easy-to-Read Display**  
A brand new bright 2-color backlight LCD display. The easy-to-read screen in any location makes checking and setting procedures a cinch.
- **Simple Operation**  
Seesaw buttons make operating the unit even easier than before.
- **Short Body of only 64.5 mm 2.539 inch (screw type) or 70.1 mm 2.760 inch (pin type)**  
With a short body, it easily installs in even narrow control panels.

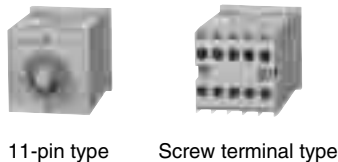
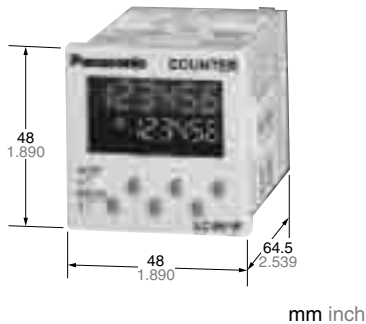
- **Conforms to IP66's Weather Resistant Standards**  
The water-proof panel keeps out water and dirt for reliable operation even in poor environments.
- **Screw terminal and Pin Type are Both Standard Options**  
The two terminal types are standard options to support either front panel installation or embedded installation.
- **Changeable Panel Cover**  
Also offers a black panel cover to meet your design considerations.
- **Compliant with UL, c-UL and CE.**



11-pin type      Screw terminal type

## Product types

Digit	Count speed	Output mode		Output	Operating voltage	Power down insurance	Terminal type	Part number	
		Output 1	Output 2						
6	30 Hz (cps)/ 5 KHz (Kcps) switchable	<ul style="list-style-type: none"> <li>• Maintain output/over count I</li> <li>• Maintain output/over count II</li> <li>• Maintain output/over count III</li> <li>• One shot/over count (4 modes)</li> </ul>	<ul style="list-style-type: none"> <li>• Maintain output/hold count</li> <li>• Maintain output/over count I</li> <li>• Maintain output/over count II</li> <li>• Maintain output/over count III</li> <li>• One shot/over count</li> <li>• One shot/recount I</li> <li>• One shot/recount II</li> <li>• One shot/hold count (8 modes)</li> </ul>	Relay (1a+1a)	100 to 240 V AC	Available	11 pins	LC4H-W-R6-AC240V	
					24V AC		Screw terminal	LC4H-W-R6-AC240VS	
					12 to 24 V DC		11 pins	LC4H-W-R6-AC24V	
							Screw terminal	LC4H-W-R6-AC24VS	
					Transistor (1a+1a)		100 to 240 V AC	11 pins	LC4H-W-R6-DC24V
							24V AC	Screw terminal	LC4H-W-R6-DC24VS
				12 to 24 V DC			11 pins	LC4H-W-T6-AC240V	
							Screw terminal	LC4H-W-T6-AC240VS	
				11 pins			LC4H-W-T6-AC24V		
				Screw terminal			LC4H-W-T6-AC24VS		
				11 pins	LC4H-W-T6-DC24V				
				Screw terminal	LC4H-W-T6-DC24VS				

\* A rubber gasket (ATC18002) and a mounting frame (AT8-DA4) are included.

## Part names

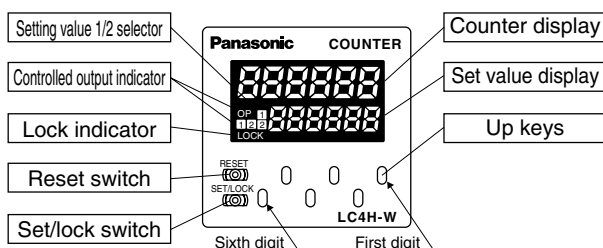

: Used to set the corresponding digits for the count-up mode.

: Used to reset counting and its output.

**SET/LOCK key** : Used to select between the Setting 1 display and Setting 2 display and to lock the keys (UP and RESET keys not responsive to touch). Used also to set and confirm the input mode.

## Specifications

Item		Relay output type		Transistor output type	
		AC type	DC type	AC type	DC type
Rating	Rated operating voltage	100 to 240 V AC 24 V AC	12 to 24 V DC	100 to 240 V AC 24 V AC	12 to 24 V DC
	Rated frequency	50/60 Hz common	—	50/60 Hz common	—
	Rated power consumption	Max. 10 V A	Max. 3 W	Max. 10 V A	Max. 3 W
	Rated control capacity	3 A, 250 V AC (resistive load)		100 mA, 30 V DC	
	Input mode	Addition (UP)/Subtraction (DOWN)/Direction (DIR)/Individuality (IND)/Phase (PHASE) (5 modes selectable by DIP switch)			
	Counting speed	30 Hz(cps)/5 KHz(cps) (selectable by DIP switch)			
	Counting input (Input 1, 2)	Min. input signal width: 16.7 ms at 30 Hz(cps)/0.1 ms at 5 KHz(cps) ON time: OFF time = 1:1			
	Reset input	Min. input signal width: 1 ms, 20 ms (selected by DIP switch)			
	Input signal	Contact or Open collector input/Input impedance: 1 kΩ or less, Input residual voltage: 2 V or less, Open impedance: 100 kΩ or more, Max. energized voltage: 40 V DC			
	Output mode	Output 1. HOLD-B, C, D SHOT-A (4 modes) Output 2. HOLD-A, B, C SHOT-A, B, C, D (8 modes) (selectable by DIP switch)			
	One shot output time	Approx. 1 s			
	Indication	7-segment LCD, Counter value (backlight red LED), Setting value (backlight yellow LED)			
	Digit	-99999 to 999999 (-5 digits to 6 digits) (0 to 999999 for setting)			
	Memory	EEP-ROM (Overwriting times: 10 <sup>5</sup> ope. or more)			
Contact	Contact arrangement	1 Form A + 1 Form A		1 Form A + 1 Form A (Open collector)	
	Contact resistance (Initial value)	100 mΩ (at 1 A 6 V DC)		—	
	Contact material	Ag alloy/Au flush		—	
Life	Mechanical (contact)	Min. 2x10 <sup>6</sup> ope.		—	
	Electrical (contact)	Min. 10 <sup>6</sup> ope. (At rated control voltage)		Min. 10 <sup>6</sup> ope. (At rated control voltage)	
Electrical	Allowable operating voltage range	85 to 110 % of rated operating voltage			
	Break down voltage (Initial value)	Between live and dead metal parts: 2,000 Vrms for 1 min (pin type) Between input and output: 2,000 Vrms for 1 min Between open contacts: 1,000 Vrms for 1 min		Between live and dead metal parts: 2,000 Vrms for 1 min Between input and output: 2,000 V AC for 1 min	
	Insulation resistance (At 500 V DC) (Initial value)	Between live and dead metal parts: Min. 100 MΩ (pin type) Between input and output: Min. 100 MΩ Between open contact: Min. 100 MΩ		Between live and dead metal parts: Min. 100 MΩ (pin type) Between input and output: Min. 100 MΩ	
	Temperature rise	Max. 65°C (under the flow of nominal operating current at nominal voltage)		—	
Mechanical	Vibration resistance	Functional	10 to 55 Hz (1 cycle/min), single amplitude: 0.35 mm (10 min on 3 axes)		
		Destructive	10 to 55 Hz (1 cycle/min), single amplitude: 0.75 mm (1 h on 3 axes)		
	Shock resistance	Functional	Min. 98 m/s <sup>2</sup> (4 times on 3 axes)		
		Destructive	Min. 294 m/s <sup>2</sup> (5 times on 3 axes)		
Operating conditions	Ambient temperature	-10°C to 55°C +14°F to +131°F			
	Ambient humidity	Max. 85 % RH (non-condensing)			
	Air pressure	860 to 1,060 h Pa			
	Ripple rate	—	20 % or less	—	20 % or less
Connection	11-pin/screw terminal				
Protective construction	IP66 (front panel with a rubber gasket)				

## Applicable standard

Safety standard	EN61812-1	Pollution Degree 2/Overvoltage Category II
EMC	(EMI)EN61000-6-4 Radiation interference electric field strength Noise terminal voltage (EMS)EN61000-6-2 Static discharge immunity	EN55011 Group1 ClassA EN55011 Group1 ClassA
	RF electromagnetic field immunity	EN61000-4-2 4 kV contact 8 kV air
	EFT/B immunity	EN61000-4-3 10 V/m AM modulation (80 MHz to 1 GHz) 10 V/m pulse modulation (895 MHz to 905 MHz)
	Surge immunity	EN61000-4-4 2 kV (power supply line) 1 kV (signal line)
	Conductivity noise immunity	EN61000-4-5 1 kV (power line)
	Power frequency magnetic field immunity	EN61000-4-6 10 V/m AM modulation (0.15 MHz to 80 MHz)
	Voltage dip/Instantaneous stop/Voltage fluctuation immunity	EN61000-4-8 30 A/m (50 Hz) EN61000-4-11 10 ms, 30% (rated voltage) 100 ms, 60% (rated voltage) 1,000 ms, 60% (rated voltage) 5,000 ms, 95% (rated voltage)

# LC4H-W

## Dimensions

### • LC4H-W electrical counter

mm inch  
General tolerance:  $\pm 1.0 \pm .039$

#### Screw terminal type (Flush mount): M3.5

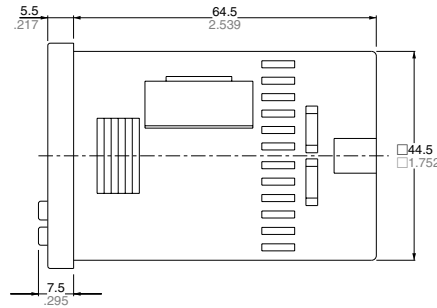
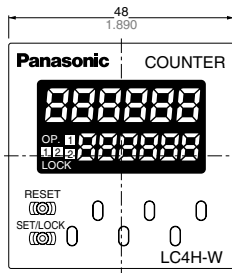

#### Pin type (Flush mount/Surface mount)

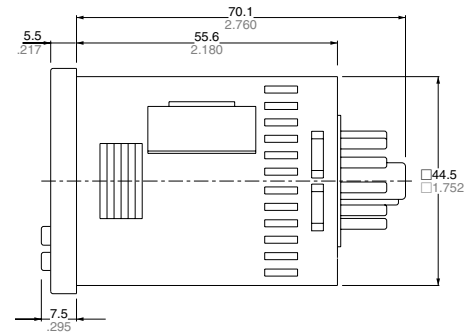

### • Dimensions for flush mounting (with adapter installed)

#### Screw terminal type

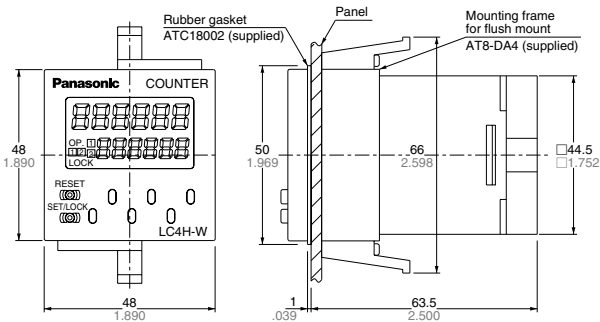

#### Pin type

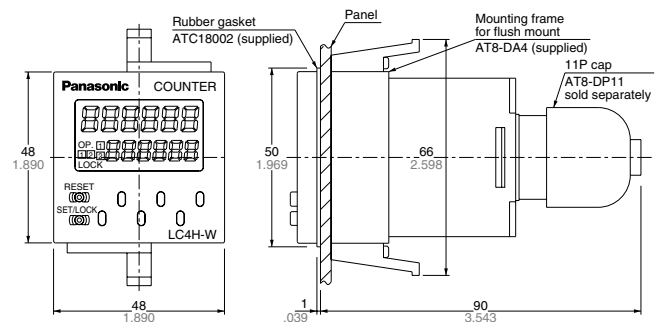

### • Dimensions for front panel installations

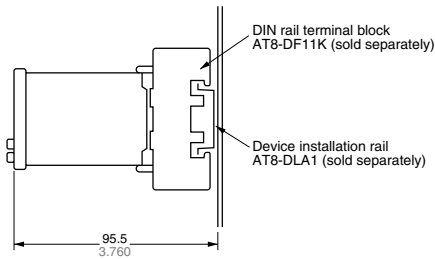

### • Installation panel cut-out dimensions

The standard panel cut-out dimensions are shown below. Use the mounting frame (AT8-DA4) and rubber gasket (ATC18002).

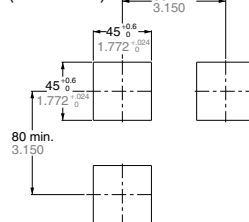

### • For connected installations

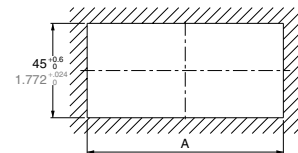

When n units are attached in a continuous series, the dimension of (A) is:  
 $A = (48 \times n - 2.5) \pm 0.6$   
Note 1): The installation panel thickness should be between 1 and 5 mm (.039 and .197 inch).  
Note 2): For connected installations, the waterproofing ability between the unit and installation panel is lost.

## Terminal layouts and wiring diagrams

### • Pin type

#### Relay output type

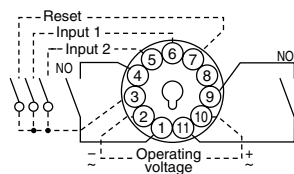

#### Transistor output type

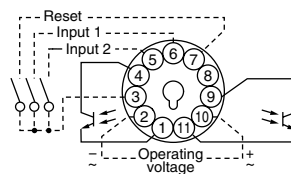

### • Screw terminal type

#### Relay output type

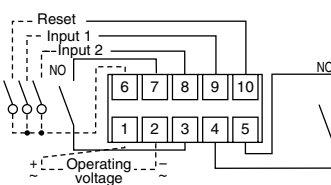

#### Transistor output type

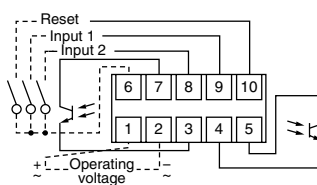

Note) For connecting the output leads of the transistor output type, refer to 5) Transistor output on page 115.

## Setting the operation mode and counter

### Setting procedure 1) Setting the output mode (output 1, 2)

Set the output 1 and output 2 with the DIP switches on the side of the counter.

The minimum input signal width and maximum counting speed for the reset are set at the same time.

#### DIP switches

Item	OFF	ON
1	Refer to table 1	
2	Output mode Output 1	
3	Minimum reset input signal width	
4	20ms	1ms
5	Maximum counter setting	
6	30Hz	
7	5kHz	
8	Refer to table 2	
6	Output mode Output 2	
7	Output mode Output 2	
8	Output mode Output 2	

Table 1

DIP switch No.			Output mode (Output 1)
1	2	3	
ON	ON	ON	— (See note 1)
OFF	OFF	OFF	HOLD-B
ON	OFF	OFF	HOLD-C
OFF	ON	OFF	HOLD-D
ON	ON	OFF	SHOT-A
OFF	OFF	ON	— (See note 1)
ON	OFF	ON	— (See note 1)
OFF	ON	ON	— (See note 1)

Table 2

DIP switch No.			Output mode (Output 2)
6	7	8	
ON	ON	ON	HOLD-A
OFF	OFF	OFF	HOLD-B
ON	OFF	OFF	HOLD-C
OFF	ON	OFF	HOLD-D
ON	ON	OFF	SHOT-A
OFF	OFF	ON	SHOT-B
ON	OFF	ON	SHOT-C
OFF	ON	ON	SHOT-D

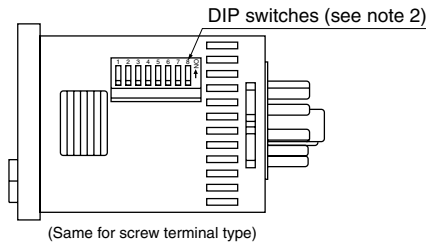

- Notes: 1) The counter and set value displays will display DIP Err.  
 2) Set the DIP switches before installing the counter on the panel.  
 3) When the DIP SW setting is changed, turn off the power once.  
 4) The DIP switches are set as ON before shipping.

### Setting procedure 2) Setting the set value

Set the set value with the UP keys on the front of the counter.

- ① Counter display
- ② Set value display
- ③ Controlled output indicator
- ④ Setting 1/2 selection display (\*Note)
- ⑤ Lock indicator

\*Note:  
 Pressing the [SET/LOCK] key switches the display between the set value 1 and 2 displays.  
 Display either set value [1] or [2], and set the value.

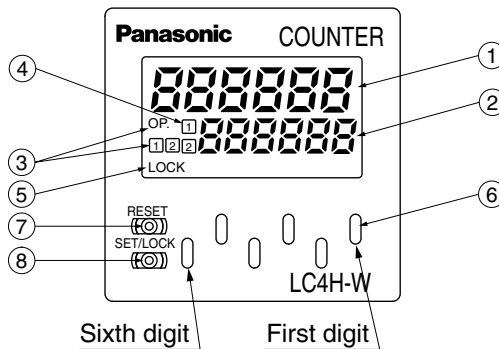

- ⑥ UP keys  
 [Changes the corresponding digit of the set value in the addition direction (upwards)]
- ⑦ RESET switch  
 Resets the counting value and the output
- ⑧ SET/LOCK switch  
 Used to select between the Setting 1 display and Setting 2 display, to set and confirm the input mode, and to lock the keys (UP and RESET keys not responsive to touch).

### Procedure 3) Setting the input mode

Set the input mode using the key and switch in the front display section on the counter front.

- (1) Hold down the SET/LOCK key and press the UP key for the first digit. The setting mode is accessed.
- (2) Now release the SET/LOCK key.
- (3) Press the UP key for the first digit and the input position changes counterclockwise.

Example)  
 Input mode displayed (UP: addition mode)

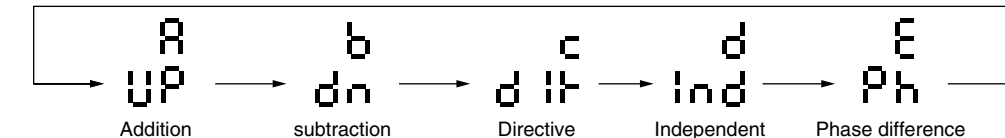
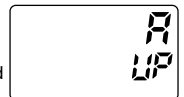

- (4) Press the RESET key and the input mode being displayed is set. The display then goes back to normal.

#### • Checking the input mode

Hold down the SET/LOCK key and press the UP key for the second digit. The input mode is displayed for about 2 seconds and then the display goes back to normal. (During these 2 seconds, all operations other than the display are being performed.)

#### • Locking the keys

Hold down the SET/LOCK key and press the UP key for the sixth digit. The keys will lock. This means that the UP and RESET keys do not respond to touch. To unlock the keys, hold down the SET/LOCK key and press the UP key for the sixth digit again.

\* The input mode, maximum counting speed and minimum reset signal width cannot be preset independently for Setting 1 and Setting 2.

#### • Selecting the Setting 1 or Setting 2 display

Press the SET/LOCK key and the display changes between Setting 1 and Setting 2. (This operation does not affect overall operation.)

#### • Changing the setting

1. While the counter is working, the UP key can be used to change the setting. Keep the following points in mind, however.

- 1) Suppose that a preset count-up value is smaller than the displayed count value. The counter counts up to the full scale mark (999999), goes back to "0", and counts up again to the preset number. When the preset count-up value is larger than the displayed count value, the counter counts up to the preset value.
- 2) Suppose that the counter is preset to count down. Whether a preset count-down value is smaller or larger than the count value, the counter counts down to "0".

2. When the preset value is "0", the counter does not start in the count-up mode. It starts counting up when the count value comes to "0" again.

- 1) Up-count input  
 The counter counts up to the full scale mark (999999), goes back to "0" and starts counting up again.
- 2) Down-count input  
 The counter counts down to the full scale mark (-99999) and the display reads - - - - -. The count value does not become "0" and so the counter does not count up.
- 3) Direction input, individual input, and phase input  
 The preset value is counted up or down to any number other than "0" once. When it comes to "0" again, the counter starts counting up.

## Operation modes

### 1. Input mode

① For the input mode, you can choose one of the following five modes.

- Addition UP
- Subtraction DOWN
- Directive DIR
- Independent IND
- Phase PHASE

② After the counter has been reset, setting 2 is displayed in the count-down mode. „0“ appears instead in all other modes.

Input mode	Operation	*Minimum input signal width 30 Hz: 16.7 ms; 5 kHz: 0.1 ms
Addition <span style="border: 1px solid black; padding: 2px;">UP</span>	IN1 or IN2 works as an input block (gate) for the other input.	<p>• Example where IN1 is the counting input and IN2 is the input block (gate).</p> <p>• Example where IN2 is the counting input and IN1 is the input block (gate).</p> <p>* "A" must be more than the minimum input signal width.      *n: Set value 2</p>
Subtraction <span style="border: 1px solid black; padding: 2px;">DOWN</span>	IN1 is the counting input and IN2 is the addition or subtraction directive input. IN2 adds at L level and subtracts at H level.	<p>* "A" must be more than the minimum input signal width.      *n: Set value 2</p>
Directive <span style="border: 1px solid black; padding: 2px;">DIR</span>	IN1 is addition input and IN2 is subtraction input.	<p>* IN1 and IN2 are completely independent, so there is no restriction on signal timing.</p>
Independent <span style="border: 1px solid black; padding: 2px;">IND</span>	Addition when the IN1 phase advances beyond IN2, and subtraction when the IN2 phase advances beyond IN1.	<p>* "B" must be more than the minimum input signal width.</p>
Phase <span style="border: 1px solid black; padding: 2px;">PHASE</span>		

# LC4H-W

## 2. Output mode

For the set value 1, you can choose one of the following four modes.

- Maintain output/over count I HOLD-B
- Maintain output/over count II HOLD-C
- Maintain output/over count III HOLD-D
- One shot/over count SHOT-A

For the set value 2, you can choose one of the following eight modes.

- Maintain output/hold count HOLD-A
- Maintain output/over count I HOLD-B
- Maintain output/over count II HOLD-C
- Maintain output/over count III HOLD-D
- One shot/over count SHOT-A
- One shot/recount I SHOT-B
- One shot/recount II SHOT-C
- One shot/hold count SHOT-D

### • Output mode for set value 1

Output mode	Operation	(Example when input mode is either addition or subtraction)
Maintain output Over count I <span style="border: 1px solid black; padding: 2px;">HOLD-B</span>	Output control is maintained after count-up completion and until resetting. However, counting is possible despite completion of count-up.	<p>* n: Set value 1</p>
Maintain output Over count II <span style="border: 1px solid black; padding: 2px;">HOLD-C</span>	Output control is maintained after count-up completion and until the next signal enters. However, counting is possible despite completion of count-up.	<p>* n: Set value 1</p>
Maintain output Over count III <span style="border: 1px solid black; padding: 2px;">HOLD-D</span>	If the count value is greater than or equal to the preset value when counting up, the control output is held. The count operation is possible anyway.	<p>* n: Set value 1</p>
One shot Over count <span style="border: 1px solid black; padding: 2px;">SHOT-A</span>	Output control is maintained after count-up completion for a fixed time (approx. 1 sec). Counting is possible despite completion of count-up.	<p>* n: Set value 1</p>

# LC4H-W

• Output mode for set value 2

Output mode	Operation	(Example when input mode is either addition or subtraction)
Maintain output Hold count HOLD-A	Output control is maintained after count-up completion and until resetting. During that time, the count display does not change from that at count-up completion.	<p>* n: Set value 2</p>
Maintain output Over count I HOLD-B	Output control is maintained after count-up completion and until resetting. However, counting is possible despite completion of count-up.	<p>* n: Set value 2</p>
Maintain output Over count II HOLD-C	Output control is maintained after count-up completion and until the next signal enters. However, counting is possible despite completion of count-up.	<p>* n: Set value 2</p>
Maintain output Over count III HOLD-D	If the count value is greater than or equal to the preset value when counting up, the counter starts counting up again. The count operation is possible anyway.	<p>* n: Set value 2</p>
One shot Over count SHOT-A	Output control is maintained after count-up completion for a fixed time (approx. 1 sec). Counting is possible despite completion of count-up.	<p>* n: Set value 2</p>
One shot Recount I SHOT-B	Output control is maintained after count-up completion for a fixed time (approx. 1 sec). Counting is possible despite completion of count-up. However, reset occurs simultaneous with completion of count-up. While output is being maintained, restarting of the count is not possible.	<p>* n: Set value 2</p>



Output mode	Operation	(Example when input mode is either addition or subtraction)
One shot Recount II SHOT-C	Output control is maintained after count-up completion for a fixed time (approx. 1 sec). Counting is possible despite completion of count-up. However, reset occurs simultaneous with output OFF.	<p>* n: Set value 2</p>
One shot Hold count SHOT-D	Output control is maintained after count-up completion for a fixed time (approx. 1 sec). During that time, the count display does not change from that at count-up completion. Reset occurs simultaneous with output OFF.	<p>* n: Set value 2</p>

		Output mode for set value 1			
		HOLD-C	HOLD-D	HOLD-B	SHOT-A
Output mode for set value 2	SHOT-A	As usual (this combination unchanged)		As usual (this combination unchanged)	
	SHOT-B				
	SHOT-C SHOT-D				

Note) When control output 1 is on, the output mode of setting 2 (SHOT-A, B, C, D) is also on and output 1 changes as shown in the above table.

### 3. Count-up

(1) In control output 1, when the count value is equal to the preset value 1, it is counted. (However, if the output mode of the preset value 1 is HOLD-D, it is counted when the count value is greater than or equal to the preset value 1, regardless of the input mode.)

(2) In control output 2, when the count value is equal to 0 in the count-down input mode, it is counted. In the other modes, when the count value is equal to the preset value 2, it is counted. (However, if the output mode of the preset value 2 is HOLD-D, it is counted when the count value is greater than or equal to the preset value 2, regardless of the input mode.)

(3) It is not counted even when the counting conditions are satisfied right after resetting. It can be counted from when the count value changes.

# PRECAUTIONS IN USING THE LC4H SERIES

## Precautions during usage

### 1. Terminal wiring

1) When wiring the terminals, refer to the terminal layout and wiring diagrams and be sure to perform the wiring properly without errors.

2) When using the instrument with a flush mounting, the screw-down terminal type is recommended. For the pin type, use either the rear terminal block (AT78041) or the 8P cap (AD8-RC) for the 8-pin type, and the rear terminal block (AT78051) or the 11P cap (AT8-DP11) for the 11-pin type. Avoid soldering directly to the round pins on the unit. When using the instrument with a front panel installation, use the DIN rail terminal block (AT8-DF8K) for the 8-pin type and the DIN rail terminal block (AT8-DF11K) for the 11-pin type.

3) After turning the counter off, make sure that any resulting induced voltage or residual voltage is not applied to power supply terminals ② through ⑦ (8-pin type), ② through ⑩ (11-pin type) ① or ② and (screw terminal type). (If the power supply wire is wired parallel to the high voltage wire or power wire, an induced voltage may be generated between the power supply terminals.)

4) Have the power supply voltage pass through a switch or relay so that it is applied at one time. If the power supply is applied gradually, the counting may malfunction regardless of the settings, the power supply reset may not function, or other such unpredictable occurrence may result.

### 2. Input connections (except LC4H-S/AC type)

The power circuit has no transformer without a transformer (power and input terminals are not insulated). When an input signal is fed to two or more counters at once, do not arrange the power circuit in an independent way. If the counter is powered on and off independently as shown in Fig. A, the counter's internal circuitry may get damaged. Be careful never to allow such circuitry. (Figs. A, B and C show the circuitry for the 11-pin type.)

(Fig. A)

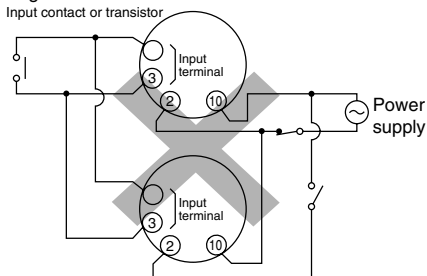

If independent power circuitry must be used, keep the input contacts or transistors separate from each other, as shown in Fig. B.

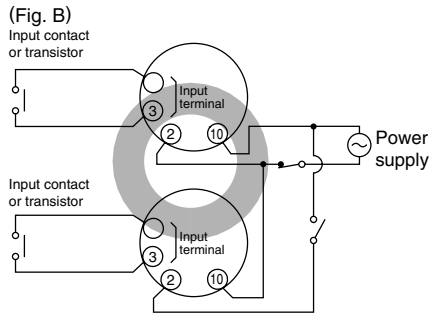

When power circuitry is not independent, one input signal can be fed to two or more counters at once, as shown in Fig. C.

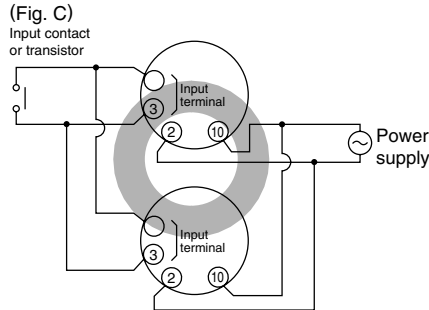

### 3. Input and output

#### 1) Signal input type

##### (1) Contact point input

Use highly reliable metal plated contacts. Since the contact point's bounce time leads directly to error in the count value, use contacts with as short a bounce time as possible. In general, select Input 1 and Input 2 to have a maximum counting speed of 30 Hz and to be reset with a minimum input signal width of 20 ms.

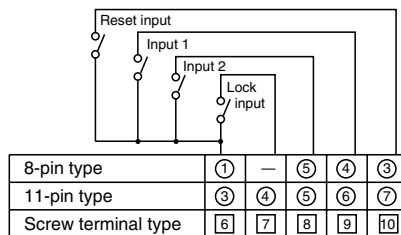

Note: The LC4H-W does not have the lock input ⑦④.

##### (2) Non-contact point input

Connect with an open collector. Use transistors whose characteristics satisfy the criteria given below.

$V_{CE0} = 20 \text{ V min.}$

$I_C = 20 \text{ mA min.}$

$I_{CBO} = 6\mu\text{A max.}$

Also, use transistors with a residual voltage of less than 2 V when the transistor is on.

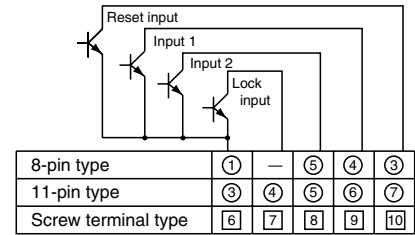

Note: The LC4H-W does not have the lock input ⑦④.

\* The short-circuit impedance should be less than 1 k $\Omega$ .

[When the impedance is 0  $\Omega$ , the current coming from the input 1 and input 2 terminals is approximately 12 mA, and from the reset input and lock input terminals is approximately 1.5 mA.]

Also, the open-circuit impedance should be more than 100 k $\Omega$ .

\* As shown in the diagram below, from a non-contact point circuit (proximity switches, photoelectric switches, etc.) with a power supply voltage of between 12 and 40 V, the signal can be input without using an open collector transistor. In the case of the diagram below, when the non-contact point transistor Q switches from off to on (when the signal voltage goes from high to low), the signal is input.

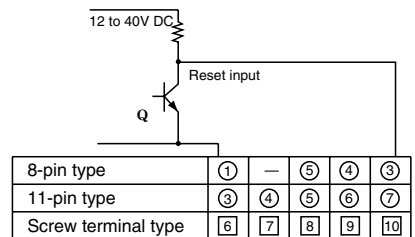

(The above example is for reset input)

2) The input mode and output mode change depending on the DIP switch settings. Therefore, before making any connections, be sure to confirm the operation mode and operation conditions currently set.

# PRECAUTIONS IN USING THE LC4H SERIES

3) The LC4H series use power supply without a transformer (power and input terminals are not insulated). In connecting various kinds of input signals, therefore, use a power transformer in which the primary side is separated from the ungrounded secondary side as shown in Fig. A, for the power supply for a sensor and other input devices so that short-circuiting can be prevented.

Once the wiring to be used is completely installed and prior to installing this counter, confirm that there is complete insulation between the wires connected to the power terminals (2 each) and the wires connected to each input terminal. If the power and input lines are not insulated, a short-circuit may occur inside the counter and result in internal damage. In addition, when moving your equipment to a new installation location, confirm that there is no difference in environmental conditions as compared to the previous location.

(except LC4H-S/AC type)

(Fig. A) Good example

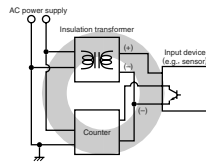

(Fig. B) Bad example

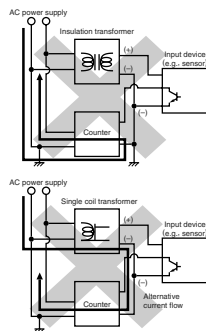

4) The input signal is applied by the shorting of each input terminal with the common terminal (terminal ① for 8-pin type, terminal ③ for 11-pin type and terminal ⑥ for screw terminal types). Never connect other terminals or voltages higher than 40 V DC, because it may destroy the internal circuitry.

5) Transistor output

(1) Since the transistor output is insulated from the internal circuitry by a photocoupler, it can be used as an NPN output or PNP (equal value) output. (The above example is 11-pin type)

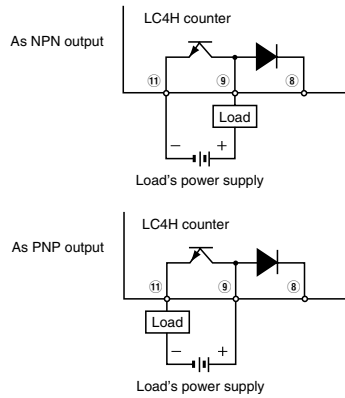

Note: With the LC4H 8-pin type and the LC4H-W, there is no diode between points ⑧ and ⑨.

(2) Use the diode connected to the output transistor's collector for absorbing the reverse voltage from induced loads. (LC4H only)

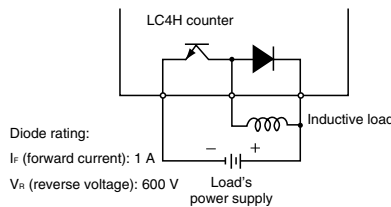

Diode rating:

$I_f$  (forward current): 1 A

$V_R$  (reverse voltage): 600 V

6) When wiring, use shielded wires or metallic wire tubes, and keep the wire lengths as short as possible.

## 4. Output mode setting

The output mode can be set with the DIP switches on the side of the counter. Make the DIP switch settings before installing the counter on the panel.

## 5. Conditions of usage

- 1) Avoid locations subject to flammable or corrosive gases, excessive dust, oil, vibrations, or excessive shocks.
- 2) Since the cover of the unit is made of polycarbonate resin, avoid contact with or use in environments containing methyl alcohol, benzene, thinners, and other organic solvents; and ammonia, caustic sodas, and other alkaline substances.
- 3) If power supply surges exceed the values given below, the internal circuits may become damaged. Be sure to use surge absorbing element to prevent this from happening.
- 4) Regarding external noise, the values

Operating voltage	Surge voltage (peak value)
AC type	6,000V
DC type 24V AC type	1,000V

## • Surge wave form

[ $\pm (1.2 \times 50)$  ms uni-polar full wave voltage]

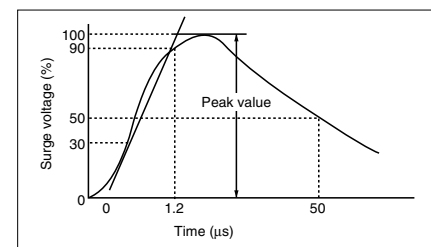

below are considered the noise-resistant voltages. If voltages rise above these values, malfunctions or damage to the internal circuitry may result, so take the necessary precautions.

Noise wave form (noise simulator)

	Power supply terminals		Input terminals
	AC type	DC type 24V AC type	
Noise voltage	1,500V	1,000V	600V

Rise time: 1 ns

Pulse width: 1  $\mu$ s, 50 ns

Polarity:  $\pm$

Cycle: 100 cycles/second

5) When connecting the operation power supply, make sure that no leakage current enters the counter. For example, when performing contact protection, if set up like that of diagram A, leaking current will pass through C and R, enter the unit, and cause incorrect operation.

Diagram B shows the correct setup.

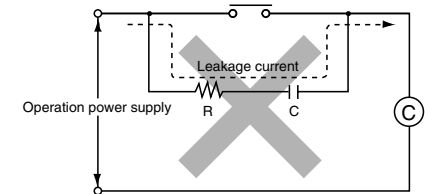

(Fig. A)

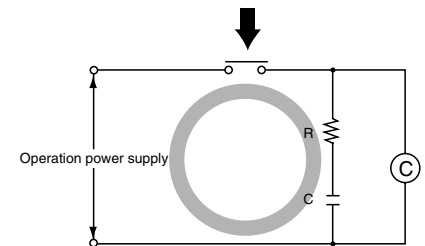

(Fig. B)

6) Long periods of continuous operation in the count-up completed condition (one month or more) will result in the weakening of the internal electrical components from the generated heat and, therefore, should be avoided. If you do plan to use the unit for such continuous operation, use in conjunction with a relay as shown in the circuit in the diagram below.

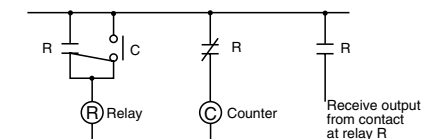

# PRECAUTIONS IN USING THE LC4H SERIES

## 6. Self-diagnosis function

If a malfunction occurs, one of the following displays will appear.

Display	Contents	Output condition	Restoration procedure	Preset values after restoration
<pre> - - - - - - - - - - - - - - - -           </pre>	Minimum value went below -999 or -99999. See note 1.	No change	Enter reset or RESET key.	No change
<pre> d i P E T t           </pre>	Incorrect DIP switch setting.		Restart unit (correct DIP switch settings)	
<pre> E t t - 0 0           </pre>	Malfunctioning CPU.	OFF	Enter reset, RESET key, or restart unit.	The values at start-up before the CPU malfunction occurred.
<pre> E t t - 0 1           </pre>	Malfunctioning memory. See note 2.			0

Note 1: When the counter value goes below the minimum value during any of the subtraction, directive, independent, or phase input modes.

Note 2: Includes the possibility that the EEPROM's life has expired.

## 7. Compliance with the CE marking

When using in applications to which EN61812-1 applies, abide by the following conditions.

- Overvoltage category II, pollution level 2  
(for sensor type model with power supply)
- 1. Connections between the power supply and input/output have basic insulation. Use a device with basic insulation to connect to the I/O terminals.  
(for sensor type model without power supply)
- 1) This counter employs a power supply without a transformer, so the power and input signal terminals are not insulated.

- (1) When a sensor is connected to the input circuit, install double insulation on the sensor side.
- (2) In the case of contact input, use dual-insulated relays, etc.
  - The load connected to the output contact should have basic insulation. This counter is protected with basic insulation and can be double-insulated to meet EN/IEC requirements by using basic insulation on the load.
  - Applied voltage should be protected with an overcurrent protection device (example: 250 V 1A fuse, etc.) that conforms to the EN/IEC standards.

- 2) You must use a terminal block or socket for installing the pin-type counter. Do not touch the terminal section or other parts of the timer unit while an electric current is applied. Before installation or removal, confirm that there is no voltage being applied to any of the terminals.
- 3) Do not use this timer with a safety circuit. For example, when using a timer in a heater circuit, etc., provide a protection circuit on the machine side.

# INSTALLING DIN SIZE COUNTER (COMMON)

## Installation methods

### 1. Surface mount

1) For the counters of LC4H series, use the pin type counter.

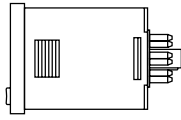

- 2) Put the terminal socket on the board directly or put it on the DIN rail (Fig. 1).
- 3) Insert the counter into the terminal socket and fix it with clip (Fig. 2)
- 4) On DIN rail mounting, mount the counter on the DIN rail tightly to get the proper dimension (Fig. 3).

(Fig. 1)

(Fig. 2)

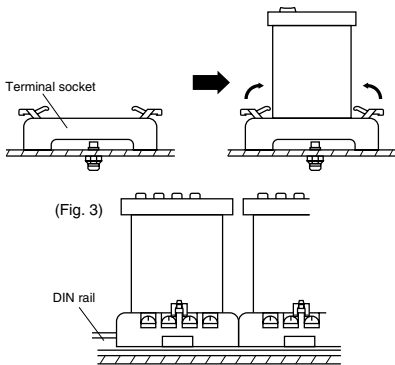

- 5) 8-pin type should be connected with terminal socket AT8-DF8K. 11-pin type should be connected with terminal socket AT8-DF11K.
- 6) DIN rail (AT8-DLA1) is also available (1 m).

### 2. Flush mount

1) For the counters of LC4H series, it is recommended to use the built-in screw terminal type for flush mount. (Mounting frame and rubber gasket are provided when counter is shipped.)

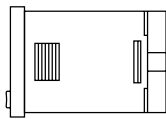

2) How to mount the counter  
From the panel front, pass the counter through the square hole. Fit the mounting frame from the rear, and then push it in so that the clearance between the mounting frame and the panel surface is minimized. In addition, lock the mounting frame with a screw.

#### • LC4H series

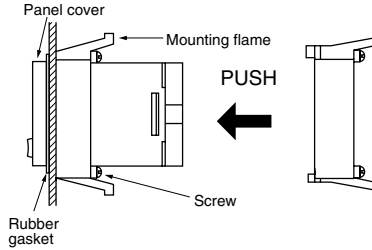

3) Caution in mounting the counter

#### • LC4H series

- (a) If the LC4H series are used as the waterproof types (IEC IP66), tighten the reinforcing screws on the mounting frames so that the counters, the rubber gaskets, and the panel surfaces are tightly contacted with each other. (Tighten the two screws with uniform force and make sure that there is no rattling. If the screws are tightened too excessively, the mounting frame may come off.)
  - (b) If the counter is installed with the panel cover and the rubber gasket removed, the waterproofing characteristic is lost.
- 4) Removal  
Loosen the screws on the mounting frame, spread the edge of frame and remove it.

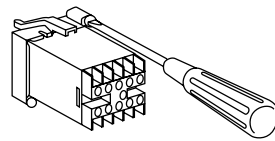

Pull the mounting frame backward while spreading out its hooks with your thumbs and index fingers.

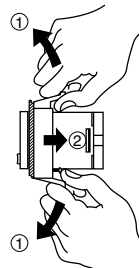

- 5) Correctly connect the terminals while seeing the terminal layout and wiring diagram.
- 6) If the pin type is used, the rear pin-bracket (AT8-RR) or the 8P cap (AD8-RC) is necessary to connect the pins. For the 11-pin type, use the 11P cap (AT8-DP11) and avoid directly soldering the round pins on the counter.
- 7) Panel cutout dimensions

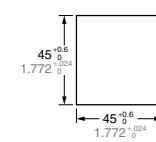

The standard panel cutout dimensions are shown in the left figure. (Panel thickness: 1 to 5 mm .039 to .197 inch)

- 8) Although the counters can be mounted adjacent to each other in this case, it is recommended to arrange the mounting holes as shown in the figure to facilitate attaching and detaching the mounting frame.

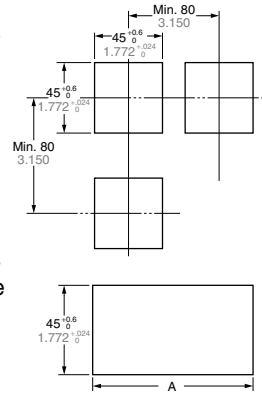





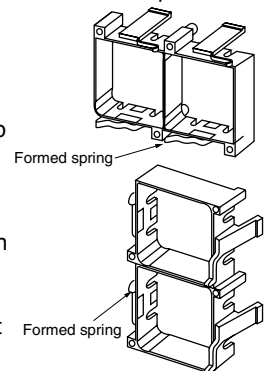



- 9) Adjacent mounting  
Although the counters can be mounted adjacent to each other, remember that the panel surface of LC4H series counter will lose its water-resistant effect. (Panel thickness: 1 to 5 mm .039 to .197 inch)

$A = (48 \times n - 2.5) +0.6$   
When lining up the counters horizontally, set the frames in such a position so the formed spring areas are at the top and bottom. When lining up the counters vertically, set the frames in such a position as the formed spring areas are at the right and left.



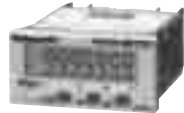

# HOUR METERS SELECTOR CHART

Types		DIN 48 × 48 size Hour Meters				
Name of product		TH14 Hour Meters	TH24 Hour Meters	TH40 Hour Meters	TH50 Hour Meters	TH70 Hour Meters
Appearance						
		TH14 series	TH24 series	TH40 series	TH50 series	TH70 series
Counting range		0 to 99999.9 hours	0 to 9999.9 hours	Reset side 0 to 9999.9 hours Without reset side 0 to 99999.9 hours	0 to 9999.9 min	0 to 99999.9 hours
Features		For controlling total integrated hours	With zero reset function For controlling measured integrated hours	Composite function for total accumulated hours monitoring and measuring each zero reset	Zero reset for minute unit time monitoring	For monitoring accumulated hours on DC line
Driving method		AC motor	AC motor	AC motor	AC motor	DC quartz motor
Counting direction		Addition (UP)	Addition (UP)	Addition (UP)	Addition (UP)	Addition (UP)
Power	Voltage	12 V AC, 24 V AC, 48 V AC, 100 V AC, 110 V AC, 115 to 120 V AC, 200 V AC, 220 V AC, 240 V AC	12 V AC, 24 V AC, 48 V AC, 100 V AC, 110 V AC, 115 to 120 V AC, 200 V AC, 220 V AC, 240 V AC	12 V AC, 24 V AC, 48 V AC, 100 V AC, 110 V AC, 115 to 120 V AC, 200 V AC, 220 V AC, 240 V AC	12 V AC, 24 V AC, 48 V AC, 100 V AC, 110 V AC, 115 to 120 V AC, 200 V AC, 220 V AC, 240 V AC	12 V DC, 24 V DC
	Frequency	50/60Hz (common)	50/60Hz (common)	50/60Hz (common)	50/60Hz (common)	—
Counting integral/ Counting max. speed		Synchronizing with power supply frequency	Synchronizing with power supply frequency	Synchronizing with power supply frequency	Synchronizing with power supply frequency	According to quartz oscillation frequency
Min. counting unit		0.1 h	0.1 h	0.1 h	0.1 min	0.1 h
Reset input		—	Manual reset	Manual reset	Manual reset	—
Max. power consumption		Approx. 1.5 W	Approx. 1.5 W	Approx. 1.5 W	Approx. 1.5 W	Approx. 1.5 W
Weight		145 g 5.115 oz	150 g 5.291 oz	160 g 5.644 oz	150 g 5.291 oz	170 g 5.997 oz
Remarks		—	The TH50 series displays time in minute.	—	—	The unit with a reset function is also available. (Manufacturing after receiving an order)
<p>The TH14, 24, 40, 50, 63, and 64 series have numbers at the end of the part number that indicate the voltage required as follows: 1:100 V, 2:200 V, 3:12 V, 4:24 V, 5:48 V, 6:110 V, 7:115 to 120 V, 8:220 V, 9:240 V, Ex.) The part number of the TH24 series with 220 V is TH248. When "S" is specified at the end of the part number, a silver panel is equipped at the front.</p>						

Types		DIN 24 × 48 size Hour Meters		DIN 24 × 48 size Hour Meters	
Name of product		TH63 Hour Meters	TH64 Hour Meters	LH2H Hour Meters	LH2H Preset Hour Meters
Appearance					
	Front section of part number	TH63 series	TH64 series	Panel mounting type PC board mounting type	ATH3
Counting range		0 to 99999.9 hours	0 to 9999.9 hours	Flush mounting type: 0 to 99999.9 hours/0 to 3999 days 23.9 hours (selectable) 0 to 999 hours 59 min 59 sec/0 to 9999 hours 59.9 min (selectable) PC board mounting type: 0 to 99999.9 hours/9999 hours 59.9 min (different type)	0 to 99999.9 hours/ 0 to 3999 days 23.9 hours (selectable) 0 to 999 hours 59 min 59 sec/ 0 to 9999 hours 59.9 min (selectable)
Features		For controlling total integrated hours	With zero reset function For controlling measured integrated hours	Big 7-digit display, 8.7 mm tall display Bright, 2-color back light (voltage input type) Plenty of input methods • Non-voltage input, Voltage input, free voltage input	Preset function equipped in half size
Driving method		AC motor	AC motor	Quartz oscillation type	Quartz oscillation type
Counting direction		Addition (UP)	Addition (UP)	Addition (UP)	Addition or subtraction
Power	Voltage	12 V AC, 24 V AC, 48 V AC, 100 V AC, 110 V AC, 115 to 120 V AC, 200 V AC, 220 V AC, 240 V AC	12 V AC, 24 V AC, 48 V AC, 100 V AC, 110 V AC, 115 to 120 V AC, 200 V AC, 220 V AC, 240 V AC	Flush mounting type: Unnecessary (Built-in battery) PC board mounting type: 3 V DC (Battery is externally installed.)	24 V DC
	Frequency	50/60Hz (common)	50/60Hz (common)	—	—
Counting integral/ Counting max. speed		Synchronizing with power supply frequency	Synchronizing with power supply frequency	±100 ppm (25°C)	±0.01% ±50 ms in case of power on start ±0.01% ±30 ms in case of input signal start
Min. counting unit		0.1 h	0.1 h	0.1 h, 0.1 min, 1 s	0.1 h, 0.1 min, 1 s
Reset input		—	Manual reset	Push button and external reset input terminal	Push button and external reset input terminal
Max. power consumption		Approx. 1.5 W	Approx. 1.5 W	—	Max. 1.5 W
Weight		80 g 2.822 oz	90 g 3.174 oz	Flush mounting type: 55 g 1.940 oz PC board mounting type: 15 g .529 oz	50 g 1.764 oz
Remarks		The numbers at the end of the part number indicate voltage. (See the remarks above.)		—	—

# HOUR METERS SELECTOR CHART

Types		DIN 52 × 52 size Hour Meters		TH Hour Meter: Round type
Name of product		TH13 Hour Meter	TH23 Hour Meter	DC Hour Meter
Appearance				
		TH13 series	TH23 series	TH8 series
Counting range		0 to 99999.9 hours	0 to 9999.9 hours	0 to 9999.9 hours
Features		For controlling total integrated hours	With zero reset function For controlling measured integrated hours	Driven on DC power
Driving method		AC motor	AC motor	Ceramic oscillation + AC motor
Counting direction		Addition (UP)	Addition (UP)	Addition (UP)
Power	Voltage	100 V AC, 200 V AC, 110 V AC, 115 to 120 V AC, 220 V AC, 240 V AC	100 V AC, 200 V AC, 110 V AC, 115 to 120 V AC, 220 V AC, 240 V AC	12 V DC, 24 V DC
	Frequency	50 Hz or 60 Hz	50 Hz or 60 Hz	—
Counting integral/ Counting max. speed		Synchronizing with power supply frequency	Synchronizing with power supply frequency	±0.2% (25°C)
Min. counting unit		0.1 h	0.1 h	0.1 h
Reset input		—	Manual reset	—
Max. power consumption		Approx. 1.5 W	Approx. 1.5 W	Approx. 1.5 W
Weight		130 g 4.586 oz	135 g 4.762 oz	170 g 5.997 oz
Remarks		Both the TH13 and 23 series have numbers at the end of the part number that indicate the voltage and frequency required. The third number from the front of the part number indicates the required voltage as follows: 4:100 V, 5:200 V, 6:110 V, 7:115 V (for 50 Hz only) or 115 V to 120 V (for 60 Hz only), 8:220 V, 9:240 V The fourth number from the front of the part number indicates the required frequency as follows: 5:50 Hz, 6:60 Hz Ex.) The part number for the TH13 series of 220 V & 50 Hz specification is TH1385.		—

**Panasonic**  
ideas for life

**DIN HALF SIZE  
HOUR METER**

**LH2H**



Panel mounting type  
One-touch installation type



Panel mounting type  
Installation frame type



PC board mounting type

## Features

- **8.7 mm Character Height (previously 7 mm .343 inch)**  
Easy-to-read character height increased from 7 mm to 8.7 mm .276 inch to .343 inch.



- **Plenty of Digits**



- **Select by switch between two time ranges in a single meter.**  
0 to 999999.9h/0 to 3999d23.9h switchable  
0 to 999h59m59s/0 to 9999h59.9m switchable

- **Panel Mounting Type Features 2 Installation Methods**

Comes with very easy one-touch installation type and also installation frame type that uses the frame on the timer/counter. Choose a method that suits the application.

- **Battery Replacement Easy on Environment**

To replace battery simply remove body for the one-touch installation type, and remove battery lid for the installation frame type.

- **Screw Terminals Designed for Safety**

Built in finger protection.

- **Panel Covers Replacable (Standard color is ash gray.)**

Change the panel design by replacing with a black panel cover.

- **Conforms to IP66 Protective Construction (Only installation frame type.) (Front panel surface)**

- **Input Methods**

- 1) Non-voltage input method
- 2) Voltage input method
- 3) Free voltage input method

- **Backlight Type Added to Series and Now 2-color Switchable (green/red)**

Easy viewing even in dark places and switchable between green and red (Voltage input type).

- **Compliant with UL, c-UL and CE marking.**

## Product chart

Type		Standard type			Backlight type
		Non-voltage input type	Voltage input type (4.5 to 30 V DC)	Free voltage input type (24 to 240 V AC/DC)	Voltage input type (4.5 to 30 V DC)
Installation type	One-touch installation type	○	○	○	○
	Installation frame type	○	○	○	○
PC board mounting type		○	—	—	—

## Product types

### 1. Panel mounting type

1) One-touch installation type

① Standard type

No. digits	Measurement time range	Front reset	Input method	Part No.
7 digits	0 to 999999.9h/0 to 3999d23.9h switchable	Yes	Non-voltage input type	LH2H-FE-DHK
	0 to 999h59m59s/0 to 9999h59.9m switchable			LH2H-FE-HMK
	0 to 999999.9h/0 to 3999d23.9h switchable		Voltage input type (4.5 to 30 V DC)	LH2H-FE-DHK-DL
	0 to 999h59m59s/0 to 9999h59.9m switchable			LH2H-FE-HMK-DL
	0 to 999999.9h/0 to 3999d23.9h switchable		Free voltage input type (24 to 240 V AC/DC)	LH2H-FE-DHK-FV
	0 to 999h59m59s/0 to 9999h59.9m switchable			LH2H-FE-HMK-FV



# LH2H

## ② Backlight type

No. digits	Measurement time range	Front reset	Input method	Part No.
7 digits	0 to 999999.9h/0 to 3999d23.9h switchable	Yes	Voltage input type (4.5 to 30 V DC)	LH2H-FE-DHK-DL-B
	0 to 999h59m59s/0 to 9999h59.9m switchable			LH2H-FE-HMK-DL-B

## 2) Installation frame type

### ① Standard type

No. digits	Measurement time range	Front reset	Input method	Part No.
7 digits	0 to 999999.9h/0 to 3999d23.9h switchable	Yes	Non-voltage input type	LH2H-F-DHK
	0 to 999h59m59s/0 to 9999h59.9m switchable			LH2H-F-HMK
	0 to 999999.9h/0 to 3999d23.9h switchable		Voltage input type (4.5 to 30 V DC)	LH2H-F-DHK-DL
	0 to 999h59m59s/0 to 9999h59.9m switchable			LH2H-F-HMK-DL
	0 to 999999.9h/0 to 3999d23.9h switchable		Free voltage input type (24 to 240 V AC/DC)	LH2H-F-DHK-FV
	0 to 999h59m59s/0 to 9999h59.9m switchable			LH2H-F-HMK-FV

## ② Backlight type

No. digits	Measurement time range	Front reset	Input method	Part No.
7 digits	0 to 999999.9h/0 to 3999d23.9h switchable	Yes	Voltage input type (4.5 to 30 V DC)	LH2H-F-DHK-DL-B
	0 to 999h59m59s/0 to 9999h59.9m switchable			LH2H-F-HMK-DL-B

## 2. PC board mounting type

No. digits	Measurement time range	Front reset	Input method	Part No.
7 digits	0 to 999999.9h	No	Non-voltage input type	LH2H-C-H-N
	0 to 9999h59.9m			LH2H-C-HM-N

## Specifications

### 1. Panel mounting type

Item	Type	Standard type		Backlight type	Standard type
		Non-voltage input	Voltage input		Free voltage type
No. digits		7 digits			
External power supply		Not required (built-in battery)			
Measurement time range		0 to 999999.9h/0 to 3999d23.9h (Switchable by switch) 0 to 999h59m59s/0 to 9999h59.9m (Switchable by switch) Separate product type			
Start input	Min. input signal width	200 ms			
	Input method (signal)	Non-voltage input using contacts or open collector connection	High level: 4.5 to 30 V DC Low level: 0 to 2 V DC		High level: 24 to 240 V AC/DC Low level: 0 to 2.4 V AC/DC
	Input impedance	When shorted: Max. 10 kΩ When open: Max. 750 kΩ	Approx. 4.7 kΩ		—
	Residual voltage	Max. 0.5 V	—		—
Reset input	Min. input signal width	100 ms			
	Input method (signal)	Non-voltage input using contacts or open collector connection	High level: 4.5 to 30 V DC Low level: 0 to 2 V DC		Non-voltage input using contacts or open collector connection
	Input impedance	When shorted: Max. 10 kΩ When open: Max. 750 kΩ	Approx. 4.7 kΩ		When shorted: Max. 10 kΩ When open: Max. 750 kΩ
	Residual voltage	Max 0.5 V	—		Max. 0.5 V
Display method		7-segment LCD		7-segment LCD With green/red backlight	7-segment LCD
Breakdown voltage (initial)		Between charged and uncharged parts: 1,000 V AC for 1 minute.			Between charged and uncharged parts: 2,000 V AC for 1 minute.
Insulation resistance (initial)		Min. 100 MΩ (measured at 500 V DC) Measurement location same as for break down voltage.			
Backlight power		—		24 V DC (±10%)	—
Protective construction (Note)		IEC Standard IP66 (only panel front: when using rubber gasket)			
Accessories (Note)		Rubber gasket, mounting bracket			
Battery life		10 years (at 25°C 77°F)			

Note) Only for installation frame type.

## 2. PC board mounting type

Item	Type	PC board mounting type
Input method		Non DC voltage input
No. digits		7 digits
Rated operation voltage		3 V DC
Allowable operation voltage range		2.7 to 3.3 V DC
Current consumption		Max. 20 $\mu$ A (max. 200 $\mu$ A during reset input)
Measurement time range		0 to 999999.9h
Start input	Min. input signal width	200 ms
	Input method	Non-voltage input using contacts or open collector connection
	Input impedance	When shorted: Max. 10 k $\Omega$ When open: Max. 750 k $\Omega$
	Residual voltage	Max. 0.5 V
Reset input	Min. input signal width	10 ms
	Input method	Non-voltage input using contacts or open collector connection
	Input impedance	When shorted: Max. 10 k $\Omega$ When open: Max. 750 k $\Omega$
	Residual power	Max. 0.5 V
Break down voltage (initial)		Between charged and uncharged parts: 1,000 V AC for 1 minute.
Insulation resistance (initial)		Min. 100 M $\Omega$ (measured at 500 V DC) Measurement location same as for break down voltage.

## 3. Common

Item	Type	Panel mounting/PC board mounting types
Time accuracy		$\pm$ 100 ppm (25°C 77°F)
Vibration resistance	Functional	10 to 55 Hz (1 cycle/min.), single amplitude: 0.15 mm (10 min. on 3 axes)
	Destructive	10 to 55 Hz (1 cycle/min.), single amplitude: 0.375 mm (1 hr. on 3 axes)
Shock resistance	Functional	Min. 98 m/s <sup>2</sup> (4 times on 3 axes)
	Destructive	Min. 294 m/s <sup>2</sup> (5 times on 3 axes)
Operation temperature		-10 to +55°C +14 to +131°F (without frost or dew)
Storage temperature		-25 to +65°C -13 to +149°F (without frost or dew)
Ambient humidity		35 to 85% RH (non-condensing)

## Applicable standard

Safety standard	EN61010-1	Pollution Degree 2/Overvoltage Category III
EMC	(EMI)EN61000-6-4 Radiation interference electric field strength	EN55011 Group1 ClassA
	Noise terminal voltage (EMS)EN61000-6-2	EN55011 Group1 ClassA
	Static discharge immunity	EN61000-4-2 4 kV contact 8 kV air
	RF electromagnetic field immunity	EN61000-4-3 10 V/m AM modulation (80 MHz to 1 GHz) 10 V/m pulse modulation (90 MHz)
	EFT/B immunity	EN61000-4-4 2 kV (power supply line)
	Conductivity noise immunity	EN61000-4-6 10 V/m AM modulation (0.15 MHz to 80 MHz)
	Power frequency magnetic field immunity	EN61000-4-8 30 A/m (50 Hz)

# LH2H

## Part names

### 1. Front reset button

Reset the elapsed time. It does not work when the lock switch is ON. Be aware that battery life will decrease if this switch is used frequently.

### 2. Lock switch (Refer to chart on right.)

Disable the front reset button.

Note) Turn ON at the LCD side (reset disabled) and OFF at the terminal block side (reset enabled).

### 3. Time range switch (See chart on right.)

Switch the time range.

Note) Always press the front reset button when operating the time range switch.

### 4. Time unit sticker

Unit seals are included in the package. Affix them in accordance with the time range.

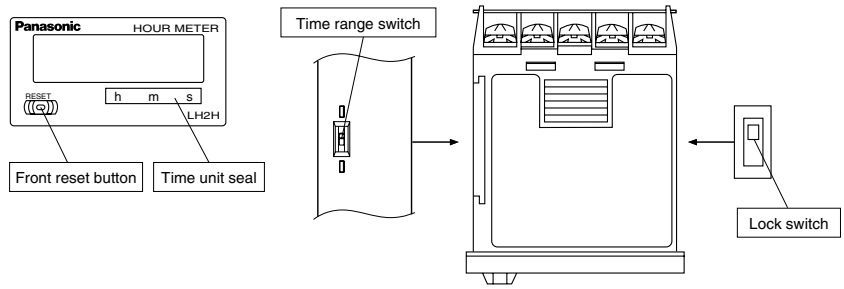

	0 to 999999.9h/0 to 3999d23.9h	0 to 999h59m59s/0 to 9999h59.9m
Lock switch (Unit display 1)	(Terminal block side) OFF* ↕ (LCD side) ON	(Terminal block side) OFF* ↕ (LCD side) ON
Count speed switch (Unit display 2)	(Terminal block side) 0 to 999999.9h* ↕ (LCD side) 0 to 3999d23.9h	(Terminal block side) 0 to 9999h59.9m* ↕ (LCD side) 0 to 999h59m59s

Notes) 1. \*Default setting when shipped.  
2. Make the switch setting before installing to panel.

## Dimensions

### 1. Panel mounting type

#### • External dimensions

#### 1) One-touch installation type

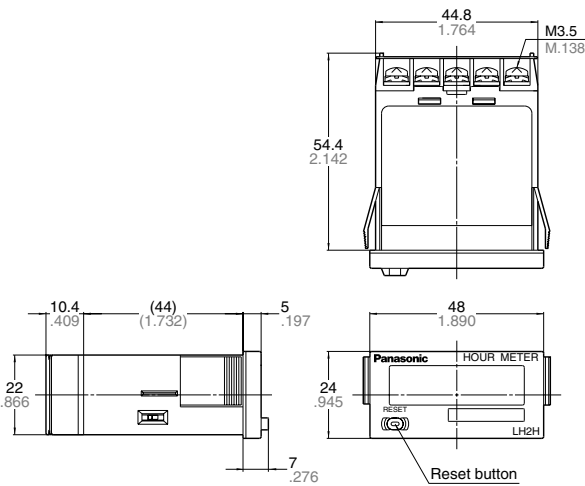

mm inch

General tolerance: ±1.0 ±.039

#### • Panel installation diagram

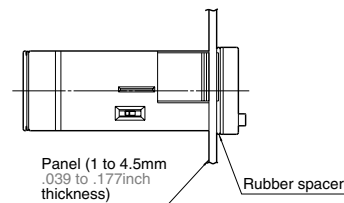

Note) When installing to a 4.5 mm .177 inch thick panel, remove the rubber spacer first.

When installing the one-touch installation type model, make sure that the installation spring does not pinch the rubber gasket.

To prevent the installation spring from pinching the rubber gasket:

1. Set the rubber gasket on both ends of the installation spring (left and right).
2. Confirm that the installation spring is not pinching the rubber gasket, and then insert and fix the installation spring in place from the rear of the timer unit.

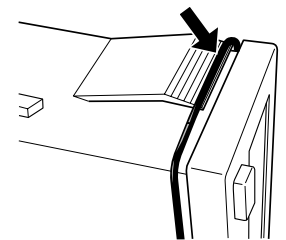

# LH2H

## 2) Installation frame type

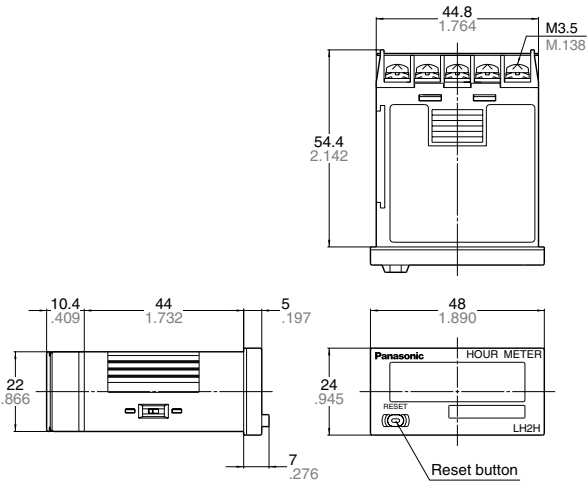

## • Panel mounting diagram

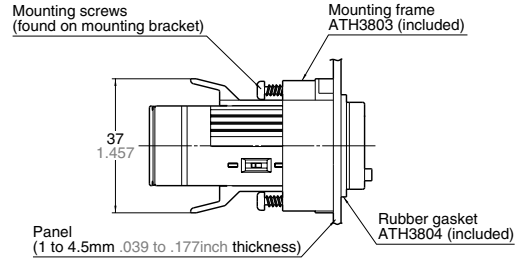

## • Panel cut-out dimensions

The standard panel cut-out is shown below.  
Use the mounting frame (ATH3803) and the rubber packing (ATH3804).  
(Only installation frame type.)

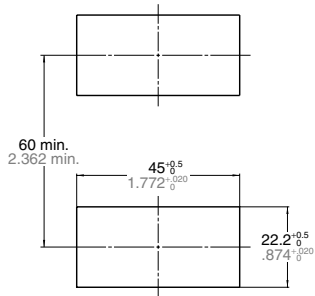

## • For connected installation (sealed installation) (Only installation frame type.)

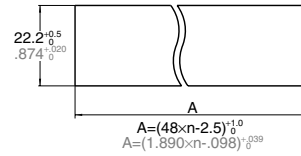

Notes) 1. Suitable installation panel thickness is 1 to 4.5 mm .039 to .177 inch.  
2. Waterproofing will be lost when installing repeatedly (sealed installation).

## • Terminal layout and wiring diagrams

### 1) Standard type

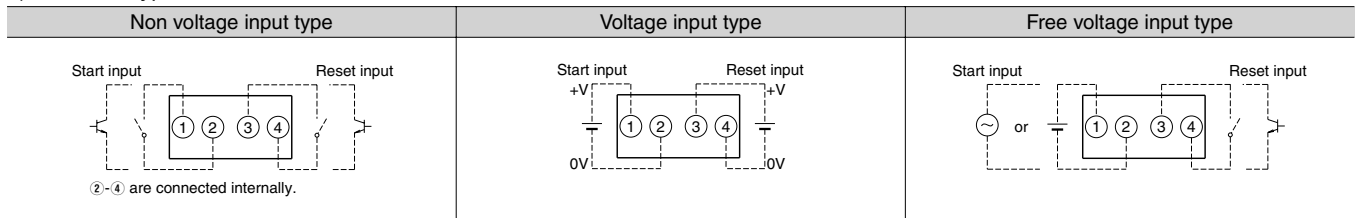

### 2) Backlight type

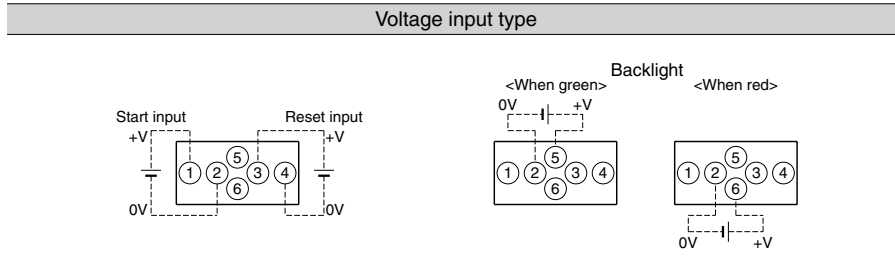

# LH2H

## 2. PC board mounting type

General tolerance:  $\pm 1.0 \pm 0.039$  mm inch

### External dimensions

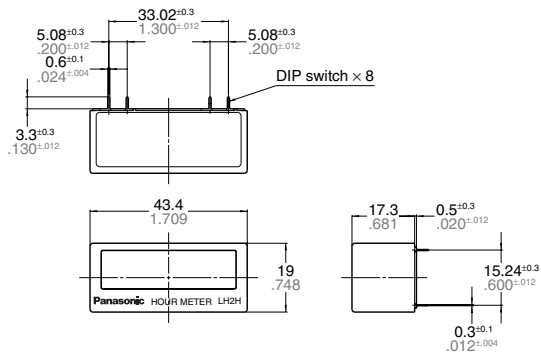

### PC board pattern (BOTTOM VIEW)

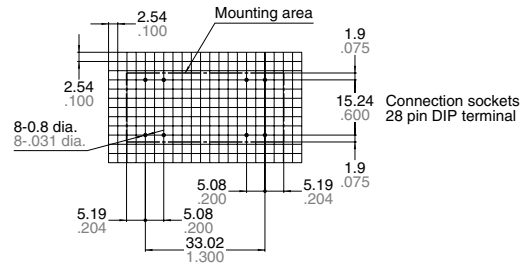

General tolerance:  $\pm 0.1 \pm 0.004$

### Terminal layout and wiring diagrams

Note: The AXS212811K is recommended as a compatible connection socket.

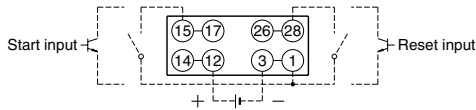

①-③, ⑫-⑭, ⑮-⑰ and ⑳-㉘ are connected internally.  
An external power supply is required.

## Input method

### 1. Standard type

Non-voltage input type			
Panel mounting type		PC board mounting type	
Contact input	Transistor input NPN transistor	Contact input	Transistor input NPN transistor
<p>(② and ④ are connected internally.)</p>	<p>(② and ④ are connected internally.)</p>	<p>3V DC</p>	<p>3V DC</p>

Notes) 1. When using contact input, since current flow is small from terminals ① and ③ on the panel mounting type and terminals ⑮ to ⑰ and ⑹ to ⑸ on the PC board mounting type, please use relays and switches with high contact reliability.  
2. When using transistor input, use the following as a guide for which transistors (Tr) to use for inputting. (Collector withstand voltage  $\geq 50$  V, leakage current  $< 1 \mu\text{A}$ )

Voltage input type			Free voltage input type
Contact input	Transistor input		
	NPN transistor	PNP transistor	

Notes) 1. ② and ④. (The input and reset circuits are functionally insulated.)  
2. When using transistor (Tr) input, use the right as a guide. (Collector withstand voltage  $\geq 50$  V, leakage current  $< 1 \mu\text{A}$ )  
3. Be aware that the application of voltage that exceeds the voltage range of the H level to the count input terminal, and the application of voltage to the reset input terminal, can cause damage to the internal elements.

## 2. Backlight type

Contact input	Voltage input type		Backlight connection
	NPN transistor	PNP transistor	

- Notes)
1. Do not reverse the polarities when connecting the DC voltage for the backlight.
  2. ② and ④. (The input and reset circuits are functionally insulated.)
  3. When using transistor (Tr) input, use the right as a guide. (Collector withstand voltage  $\geq 50$  V, leakage current  $< 1 \mu\text{A}$ )
  4. Be aware that the application of voltage that exceeds the voltage range of the H level to the count input terminal, and the application of voltage to the reset input terminal, can cause damage to the internal elements.

## Explanation of operation

1. Time measuring takes place when the start input is ON.
2. When the elapsed (measured) time reaches full scale it returns to "0", and then measuring starts again from "0".
3. When reset input is ON, the display becomes "0". You cannot measure during reset input.  
For PC board mounting type the display disappears while the reset input is ON; however, the display reads "0" when the reset input turns OFF.
4. Press the front reset button if you want to perform a manual reset (for panel installation type)

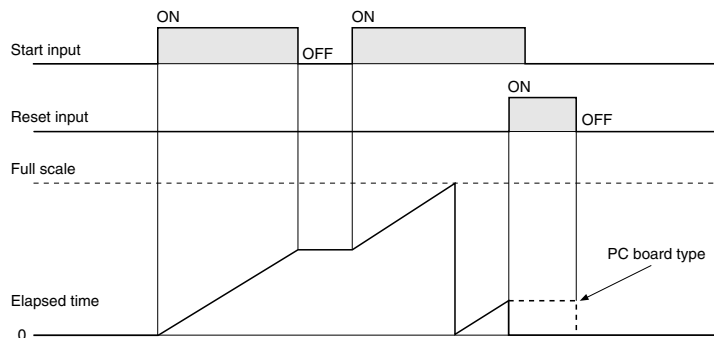

## Cautions for use

### 1. Non-voltage input type

#### For both panel mounting and PC board mounting types

1) Never apply voltage to the non-voltage input type. This will damage the internal elements.

2) Since the current flow is very small from the start input and reset input terminals (① and ③ on the panel mounting type and terminals ⑮ to ⑰ and ⑳ to ㉓ on the PC board mounting type) please use relays and switches with high contact reliability. When inputting with an open collector of a transistor, use a transistor for small signals in which ICBO is 1  $\mu$ A or less and always input with no voltage.

3) When wiring, try to keep all the input lines to the start and reset inputs as short as possible and avoid running them together with high voltage and power transmission lines or in a power conduit. Also, malfunctions might occur if the floating capacitance of these wires exceeds 500 pF (10 m 32.808 ft. for parallel wires of 2 mm<sup>2</sup>). In particular, when using shielded wiring, be careful of the capacitance between wires.

#### PC board mounting type

1) For external power supply use manganese dioxide or lithium batteries (CR type: 3V).

2) Always reset after external power is applied and confirm that the display reads "0".

3) Make the wiring from the battery to the hour meter unit as short as absolutely possible. Also, be careful of polarity.

4) Calculate battery life with the following formula.

$$t = A/I$$

t: battery life [h]

I: LH2H current consumption [mA]

A: battery capacity until minimum operation voltage is reached [mAh]

5) Hand solder to the lead terminal. Do not dip solder. With the tip of the soldering iron at 300°C 572°F perform soldering within 3 seconds (for 30 to 60 W soldering iron).

### 2. Voltage input type

1) Be aware that applying more than 30 V DC to start input terminals ① and ②, and reset input terminals ③ and ④ will cause damage to the internal elements.

2) For external resetting use H level (application of 4.5 to 30 V DC) between reset terminals ③ and ④ of the rear terminals. In this case, connect + to terminal ③ and - to terminal ④. This is the valid polarity; therefore, the hour meter will not work if reversed.

3) When wiring, try to keep all the input lines to the start and reset inputs as short as possible and avoid running them together with high voltage and power transmission lines or in a power conduit.

Also, malfunctions might occur if the floating capacitance of these wires exceeds 500 pF (10 m 32.808 ft. for parallel wires of 2 mm<sup>2</sup>).

### 3. Free voltage input type

1) Use start input terminals ① and ② for free voltage input and reset terminals ③ and ④ for non-voltage input.

2) Be aware that the application of voltage that exceeds the voltage range of the H level to the start input terminal, and the application of voltage to the reset input terminal, can cause damage to the internal elements.

3) Since the current flow is very small from reset input terminal ③, please use relays and switches with high contact reliability.

4) When inputting a reset with an open collector of a transistor, use a transistor for small signals in which ICBO is 1  $\mu$ A or less and always input with no voltage.

5) To reset externally, short reset input terminals ③ and ④ on the rear.

6) Input uses a high impedance circuit; therefore, erroneous operation may occur if the influence of induction voltage is present. If you plan to use wiring for the input signal that is 10 m or longer (wire capacitance 120 pF/m at normal temperature), we recommend the use of a CR filter or the connection of a bleeder resistor.

### 4. How to reset multiple panel mounting type counters all at once (input is the same for count)

#### Non-voltage input type

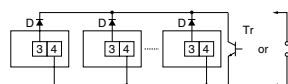

- Notes) 1. Use the following as a guide for choosing transistors used for input (Tr).  
Leakage current < 1  $\mu$ A
2. Use as small a diode (D) as possible in the forward voltage so that the voltage between terminals 3 and 4 during reset input meets the standard value (0.5 V).  
( At IF = 20  $\mu$ A, forward voltage 0.1 and higher.)

#### Voltage input type

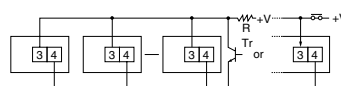

Note) Make sure that H (reset ON) level is at least 4.5 V.

### 5. Backlight luminance

To prevent varying luminance among backlights when using multiple Backlight types, please use the same backlight power supply.

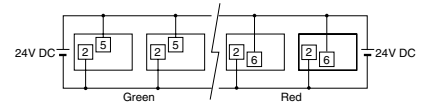

### 6. Acquisition of CE marking

Please abide by the conditions below when using in applications that comply with EN 61010-1/IEC 61010-1

1) Ambient conditions

- Overvoltage category II, pollution level 2
- Indoor use
- Acceptable temperature and humidity range: -10 to +55°C, 35 to 85%RH (with no condensation at 20°C)
- Under 2000 m elevation

2) Use the main unit in a location that matches the following conditions.

- There is minimal dust and no corrosive gas.
- There is no combustible or explosive gas.
- There is no mechanical vibration or impacts.
- There is no exposure to direct sunlight.
- Located away from large-volume electromagnetic switches and power lines with large electrical currents.

3) Connect a breaker that conforms to EN60947-1 or EN60947-3 to the voltage input section.

4) Applied voltage should be protected with an overcurrent protection device (example: T 1A, 250 V AC time lag fuse) that conforms to the EN/IEC standards.

(Free voltage input type)

### 7. Terminal connection

Tighten the terminal screws with a torque of 0.8 N·cm or less.

**Panasonic**  
ideas for life

**PRESET  
HOUR METER**

**LH2H**



### Features

- Preset function equipped in half size (24 × 48 mm 0.945 × 1.890 inch).
- Display has backlight for instant recognition.

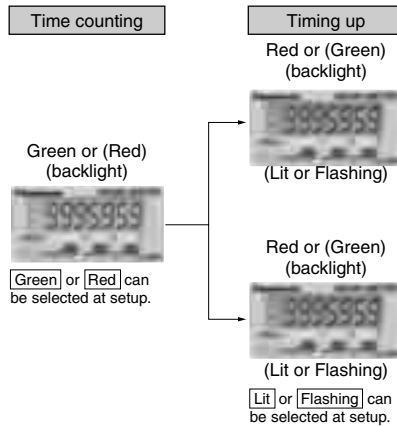

- **8.7 mm 0.343 inch Character Height (previously 7 mm 0.276 inch)**  
Easy-to read character height increased from 7 mm to 8.7 mm 0.276 inch to 0.343 inch.



- **Plenty of Digits**



- **Select by switch between two time ranges in a single meter.**  
0 to 999999.9h/0 to 3999d23.9h  
Selectable  
0 to 999h59m59s/0 to 9999h59.9m  
Selectable
- **Conforms to IP66 Protective Construction (Front panel surface)**  
Weatherproofing supported by using optional mounting bracket and rubber gasket
- **Includes reassuring lock mode and lock switch to prevent erroneous operation.**
- **Screw terminals are constructed to protect fingers to ensure safety.**
- **Compliant with UL, c-UL and CE marking.**

### Product types

No. digits	Measurement time range	Operation mode	Output	Operating voltage	Part No.
7 digits	0 to 999999.9h/ 0 to 3999d23.9h selectable	G (Totalizing ON delay) B (Signal ON delay) F (Signal flicker) E (Pulse ON delay)	Transistor (1a)	24 V DC	LH2HP-FEW-DHK-B-DC24V
	0 to 999h59m59s/ 0 to 9999h59.9m selectable				LH2HP-FEW-HMK-B-DC24V
Options		Mounting frame	Use for waterproofing (front panel surface)		ATH3803
		Rubber gasket			ATH3804

Note: Mounting frame and rubber gasket are not included.



## Specifications

Item		Descriptions
Rating	Rated operating voltage	24 V DC
	Rated power consumption	Max. 1.5 W
	Rated control output	100 mA 30 V DC
	Time counting direction	Addition or Subtraction (selectable by front switch)
	Measurement time range	0 to 999999.9h/0 to 3999d23.9h (selectable by slide switch on side) 0 to 999h59m59s/0 to 9999h59.9m (selectable by slide switch on side)
	Start input	Min. input signal width: Min. 30 ms
	Reset input	Min. input signal width: Min. 30 ms
	Input signal	<ul style="list-style-type: none"> <li>• Non-voltage input using contacts or open-collector connection</li> <li>• Input impedance; when shorted: Max. 1 kΩ, when open: Min. 100 kΩ</li> <li>• Residual voltage: Max. 2 V</li> </ul>
	Operation mode	Totalizing ON delay, Signal ON delay, Signal flicker, Pulse ON delay (selectable by front switch)
	Display method	7-segment LCD (Switch between red and green for backlight, and between lit and flashing for time up.)
	Power failure emory	EER-ROM (Overwriting times: 10 <sup>5</sup> operations or more)
Time accuracy	Operating time fluctuation	$\pm 0.01\% \pm 50$ ms in case of power on start $\pm 0.01\% \pm 30$ ms in case of input signal start Rated operating voltage: 85 to 110% Ambient temperature: -10 to +55°C +14 to +131°F
	Voltage error	
	Temperature error	
	Setting error	
Contact arrangement		1 Form A (Open collector)
Electrical life (contact)		10 <sup>7</sup> operations (at rated control voltage)
Electrical	Allowable operating voltage range	85 to 110% of rated operating voltage
	Break down voltage (Initial value)	Between input and output: 1,500 V AC, for 1 min.
	Insulation resistance (Initial value)	Between input and output: 100 MΩ (at 500 V DC)
Mechanical	Functional vibration resistance	10 to 55 Hz (1 cycle/min), Single amplitude: 0.15 mm (10 min. on 3 axes)
	Destructive vibration resistance	10 to 55 Hz (1 cycle/min), Single amplitude: 0.375 mm (1 hr. on 3 axes)
	Functional shock resistance	Min. 98 m/s <sup>2</sup> (4 times on 3 axes)
	Destructive shock resistance	Min. 294 m/s <sup>2</sup> (5 times on 3 axes)
Operating conditions	Operation temperature	-10 to 55°C +14 to +131°F (without frost or dew)
	Storage temperature	-25 to +65°C -13 to +149°F (without frost or dew)
	Ambient humidity	35 to 85% RH (non-condensing)
Protective construction		IP66 (front panel with mounting bracket and rubber gasket)

\* The factory default preset value is set to 0.1.

## Applicable standard

EMC	(EMI)EN61000-6-4 Radiation interference electric field strength	EN55011 Group1 ClassA
	Noise terminal voltage	EN55011 Group1 ClassA
	(EMS)EN61000-6-2 Static discharge immunity	EN61000-4-2 4 kV contact 8 kV air
	RF electromagnetic field immunity	EN61000-4-3 10 V/m AM modulation (80 MHz to 1 GHz) 10 V/m pulse modulation (895 MHz to 905 MHz)
	EFT/B immunity	EN61000-4-4 2 kV (power supply line) 1 kV (signal line)
	Conductivity noise immunity	EN61000-4-6 10 V/m AM modulation (0.15 MHz to 80 MHz)
	Power frequency magnetic field immunity	EN61000-4-8 30 A/m (50 Hz)

# LH2H

## Part names

### 1. Front reset key

This key resets the elapsed value. It does not work when the lock switch is ON.

### 2. Mode key

Use to set preset values or to switch between each mode.

### 3. Setting key

Used to set digits of preset values or set each mode.

### 4. Set key

Use to set preset values or to switch between modes.

### 5. Time unit seal

Unit seals are included in the package. Affix them in accordance with the time range.

### 6. Lock switch

Disable the operation of the front panel reset key and the mode key. With the lock switch on, Lock is displayed for about two seconds when the reset key or mode switch is operated.

### 7. Time range switch

Switch the time range.

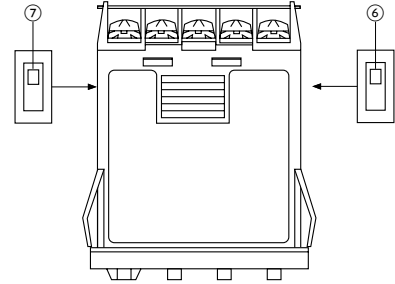
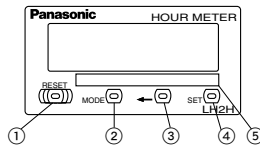

※: Default setting when shipped.

		LH2HP-FEW-DHK-B-DC24V	LH2HP-FEW-HMK-B-DC24V
⑥	Lock switch (unit display 1)	(Terminal block side) ↑ (LCD side)	(Terminal block side) ↑ OFF※ ↓ ON
		(Terminal block side) ↑ (LCD side)	(Terminal block side) ↑ 0 to 999999.9h※ ↓ 0 to 3999d23.9h
⑦	Time range switch (unit display 2)	(Terminal block side) ↑ (LCD side)	(Terminal block side) ↑ 0 to 9999h59.9m※ ↓ 0 to 999h59m59s
		(Terminal block side) ↑ (LCD side)	(Terminal block side) ↑ 0 to 999999.9h※ ↓ 0 to 3999d23.9h

Notes: 1. Make the switch setting before installing to panel.

2. Please turn the power off if you change the setting of the time range switch when the power is on. The setting will become valid when the power is turned back on.

## Dimensions

### • External dimensions

mm inch

General tolerance: ±1.0 ±0.039

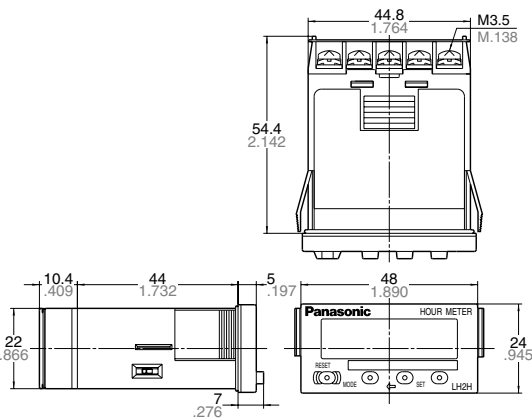

When installing the one-touch installation type model, make sure that the installation spring does not pinch the rubber gasket.

To prevent the installation spring from pinching the rubber gasket:

1. Set the rubber gasket on both ends of the installation spring (left and right).
2. Confirm that the installation spring is not pinching the rubber gasket, and then insert and fix the installation spring in place from the rear of the timer unit.

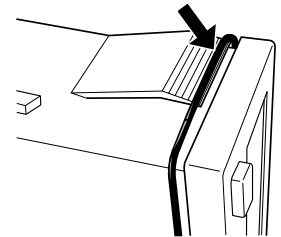

### • Panel cut out dimensions

The standard panel cut out is shown below.

Use the mounting frame (ATH3803) and the rubber gasket (ATH3804). (Only installation frame type)

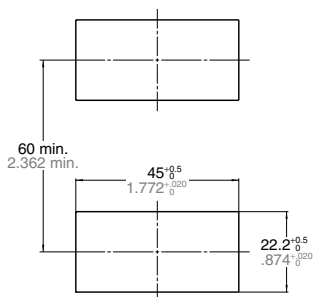

### • For connected installation (sealed installation) (Only installation frame type)

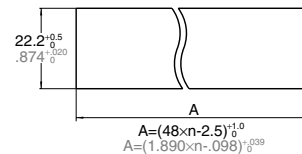

- Notes: 1. Suitable installation panel thickness is 1 to 4.5 mm 0.39 to 0.177 inch.  
2. Waterproofing will be lost when installing repeatedly (sealed installation).

## How to set

### 1. Preset value setting mode

This is the mode for setting preset values.

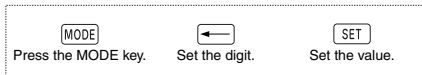

1) Pressing the MODE key takes you to the preset value setting mode.

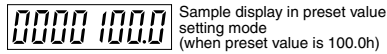

\* The factory default preset value is set to 1.0.

- 2) Pressing the setting key moves the flashing digit left by one. Following the highest digit it returns to the lowest digit and each time the digit setting key is pressed it moves one to the left.
- 3) Pressing the set key increases the value by one. (After 9 it returns to 0 and then changes to 1, 2, 3, etc.)
- 4) Pressing the front panel reset key sets the displayed preset value and returns you to the regular operation mode.
- 5) In the preset value setting mode if you do not operate the digit setting key or the set key for ten seconds or more you will be returned to regular operation. In this case the preset value will not change.

### 2. Lock mode

This mode prohibits everything except the preset value setting mode.



1) Pressing the set key while holding down the mode key takes you to the lock mode.

2) The display reads "Un-Lock" after entering the lock mode (initial setting).

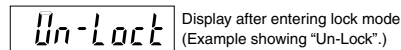

3) Pressing the setting key changes the display between "Lock" and "Un-lock".

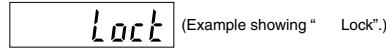

4) Pressing the front panel reset key sets the content displayed and returns you to regular operation mode.

Note: You will not be returned to regular operation mode if you do not press the front panel reset key.

- 5) When the lock mode display reads "Lock", you will not be able to move to the backlight setting mode, the time counting direction setting mode, or the operation setting mode.

### 3. Backlight setting mode

This is the mode for setting the backlight during time up.



1) Pressing the SET key two times while holding down the MODE key takes you to the backlight setting mode.

2) The display in the backlight setting mode reads "LED".



3) The LED backlight will be red (initial setting).

4) The backlight changes from flashing green to flashing red to lit green and to lit red with each press of the setting key.

5) Pressing the front panel reset key sets the current backlight color and returns you to regular operation mode.

Note: You will not be returned to regular operation mode if you do not press the front panel reset key.

### 4. Time counting direction setting mode

This is the mode for setting addition or subtraction.



1) Pressing the SET key three times while holding down the MODE key takes you to the time counting direction setting mode.

2) The display after entering the time counting direction setting mode reads "UP" (initial setting).



3) Pressing the setting key changes the display to "dn" (subtraction) and pressing it again changes it to "UP" (addition). The display alternates between "dn" and "UP".

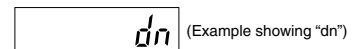

4) Pressing the front panel reset key sets the content displayed and returns you to regular operation mode.

Note: You will not be returned to regular operation mode if you do not press the front panel reset key.

## 5. Operation mode

This sets the operation mode.

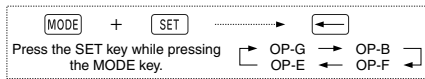

1) Pressing the SET key four times while holding down the MODE key takes you to the operation setting mode.

2) The display reads "OP-G" (Totalizing ON delay) after entering the operation setting mode.

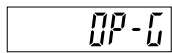

3) Pressing the setting key causes the display to change as follows:

OP-B (Signal ON delay)

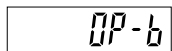

OP-F (Signal flicker)

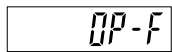

OP-E (Pulse ON delay)

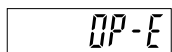

OP-G (Totalizing ON delay)

4) Pressing the front panel reset key sets the display content and returns you to regular operation mode.

Note: You will not be returned to regular operation mode if you do not press the front panel reset key.

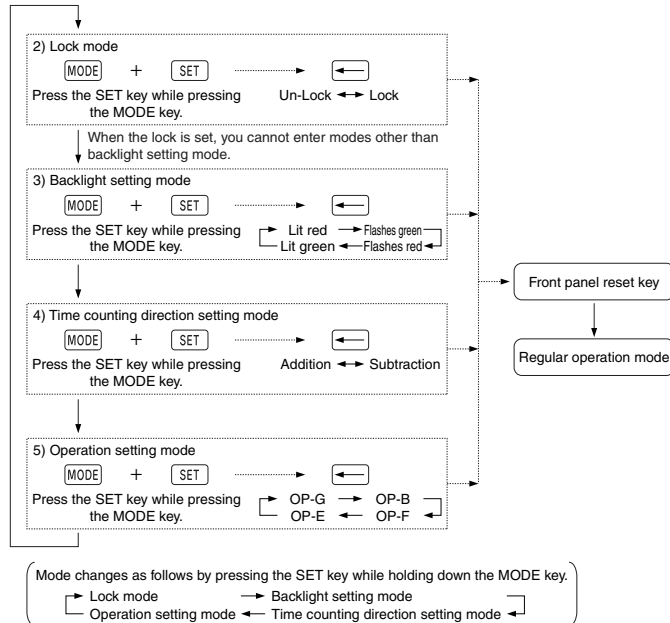

Please be aware that after doing a front panel reset key and returning to regular operation mode, the preset values, elapsed value and output will be as shown in this table.

	Preset value	Elapsed value	Output change
Lock mode	×	×	×
Backlight setting mode	×	×	×
Time counting direction setting mode	×	Addition: "0" Subtraction: "Preset value"	ON→OFF
Operation setting mode	×	Addition: "0" Subtraction: "Preset value"	ON→OFF

Note: "×" sign: No change

## Changing the set time (preset value)

1. It is possible to change the set time even during time delay with the timer. However, be aware of the following points.

1) If the set time is changed to less than the elapsed time (elapsed value) with the time delay set to the addition direction, time delay will continue until the elapsed time reaches full scale, returns to "0 (zero)", and then reaches the new set time.

If the set time is changed to a time above the elapsed time, the time delay will continue until the elapsed time reaches the new set time.

2) If the time delay is set to the subtraction direction, time delay will continue until "0 (zero)" regardless of the new set time.

2. If the set time is changed to "0 (zero)", the hour meter will operate differently depending on the operation mode. In the G (Totalizing ON delay), B (Signal ON delay), and E (Pulse ON delay) modes, the output turns ON when the start input is ON. However, the output will be OFF while reset is being input. In the F (Signal flicker) mode, the flicker operation will not work even if start input is turned ON.

# PRECAUTIONS IN USING THE LH2H SERIES

## Operation mode

Operation mode	Explanation	Time chart
Totalizing ON delay Ⓒ	<ul style="list-style-type: none"> <li>Elapsed value does not clear at power ON. (Power outage countermeasure function)</li> <li>The output remains ON even after the power is OFF and restarted.</li> </ul>	<p>The time chart for Totalizing ON delay mode shows four cycles of power supply (ON/OFF), output (ON/OFF), reset (ON/OFF), and start (ON/OFF). The output remains ON during power outages. Time intervals <math>T</math>, <math>t_1</math>, <math>t_2</math>, and <math>t_a</math> are marked. The total time <math>T = t_1 + t_2</math> is shown for the first cycle, and <math>T &gt; t_a</math> is shown for the last cycle.</p>
Signal ON delay Ⓑ	<ul style="list-style-type: none"> <li>Clears elapsed value at power ON.</li> <li>Time delay starts at start ON and output resets at start OFF.</li> <li>Time delay starts at reset OFF and power ON while start is ON.</li> </ul>	<p>The time chart for Signal ON delay mode shows two cycles of power supply (ON/OFF), output (ON/OFF), reset (ON/OFF), and start (ON/OFF). The output resets at start OFF and starts again at reset OFF. Time interval <math>T</math> is marked.</p>
Signal Flicker Ⓕ	<ul style="list-style-type: none"> <li>Clears elapsed value at power ON.</li> <li>Time delay starts at start ON.</li> <li>After timer completion, control output reverses, elapsed value clears, and time delay starts.</li> <li>Ignores start input during time delay.</li> </ul>	<p>The time chart for Signal Flicker mode shows two cycles of power supply (ON/OFF), output (ON/OFF), reset (ON/OFF), and start (ON/OFF). The output reverses after timer completion. Time intervals <math>T</math> and <math>t_a</math> are marked.</p>
Pulse ON delay Ⓖ	<ul style="list-style-type: none"> <li>Clears elapsed value at power ON.</li> <li>Time delay starts at start ON.</li> <li>After timer completion, control output is ON.</li> <li>Ignores start input during time delay.</li> </ul>	<p>The time chart for Pulse ON delay mode shows two cycles of power supply (ON/OFF), output (ON/OFF), reset (ON/OFF), and start (ON/OFF). The output is ON during the timer delay. Time interval <math>T</math> is marked.</p>

# PRECAUTIONS IN USING THE LH2H SERIES

## Cautions for use

### 1. Input and output connection

#### 1) Input connection

##### (1) Contact input

Use highly reliable metal plated contacts. Since the contact's bounce time leads directly to error in the timer operating time, use contacts with as short a bounce time as possible.

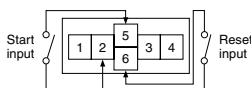

##### (2) Non-contact input (Transistor input)

Connect with an open collector. Use transistors whose characteristics satisfy the criteria given below.

$V_{CE0} = \text{Min. } 20 \text{ V}$

$I_c = \text{Min. } 20 \text{ mA}$

$I_{CBO} = \text{Max. } 6 \mu\text{A}$

Also, use transistors with a residual voltage of less than 2 V when the transistor is on.

\* The short-circuit impedance should be less than 1 k $\Omega$ .

(When the impedance is 0  $\Omega$ , the current coming from the start input terminal is approximately 5 mA and from the reset input terminal is approximately 1.5 mA.)

Also, the open-circuit impedance should be more than 100 k $\Omega$ .

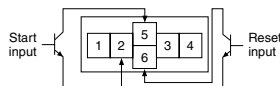

#### (3) Input wiring

When wiring, use shielded wires or metallic wire tubes, and keep the wire lengths as short as possible.

#### 2) Output connection

Since the transistor output of hour meter is insulated from the internal circuitry by a photo-coupler, it can be used as an NPN output or PNP (equal value) output.

##### As NPN output

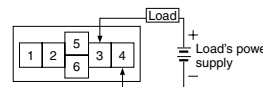

##### As PNP output

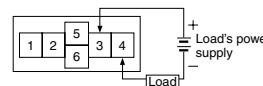

## 2. Self-diagnosis function

If a malfunction occurs, one of the following displays will appear.

Display	Contents	Output condition	Restoration procedure	Preset values after restoration
Err-00	Malfunctioning CPU	OFF	Enter front reset key or restart hour meter	Preset value at start-up before the CPU malfunction occurred
Err-01	Malfunctioning memory*			0

\* Includes the possibility that the EEPROM's life has expired.

## 3. Power failure memory

The EEPROM is overwriting with the following timing.

Operation mode	Overwrite timing
G (Totalizing ON delay) mode	Change of preset value or when power is OFF after start and reset input turns ON
Other modes	When power is OFF after changing preset value

## 4. Terminal connection

1) When wiring the terminals, refer to the terminal layout and wiring diagrams and be sure to perform the wiring properly without errors.

Tighten the terminal screws with a torque of 0.8 N-cm or less. The screws are M3.5.

An external power supply is required in order to run the main unit.

Power should be applied between terminals (1) and (2). Terminal (1) acts as the positive connection and terminal (2) as the negative.

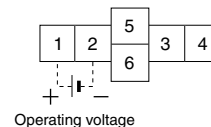

2) After turning the hour meter off, make sure that any resulting induced voltage or residual voltage is not applied to power supply terminals (1) through (2). (If the power supply wire is wired parallel to the high voltage wire or power wire, an induced voltage may be generated at the power supply terminal.)

3) Have the power supply voltage pass through a switch or relay so that it is applied at one time.

## Compliance with the CE marking

• EMC Directive (89/336/EEC)

The LH2H Preset Hour Meter conforms to the EMC Directive as a simple hour meter.

Applicable standards: EN61000-6-4, EN61000-6-2

# PRECAUTIONS IN USING THE LH2H SERIES

## Cautions for use

### 1. Insulation sheet

Before using a panel mounting type, please pull and remove the insulation sheet in the direction of the arrow. In consideration that the product might be stored for long periods without being used, an insulation sheet is inserted before shipping. Remove the insulation sheet and press the front reset button.

### • LH2H hour meter (one-touch installation type)

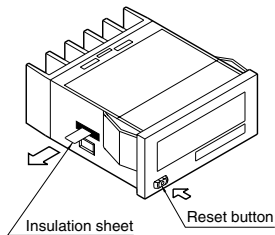

### • LH2H hour meter (installation frame type)

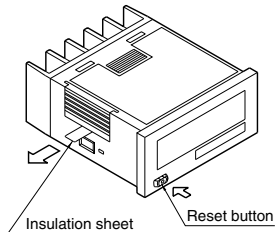

### 2. Waterproof construction

#### • LH2H hour meter (installation frame type)

The operation part of the panel installation type (installation frame type) is constructed to prevent water from entering the unit and a rubber gasket is provided to prevent water from entering the gap between the unit and the panel cutout.

There must be sufficient pressure applied to the rubber gasket to prevent water from entering.

Be sure to use the mounting screws when installing the mounting frame (ATH3803).

Note: The one-touch installation type is not waterproof.

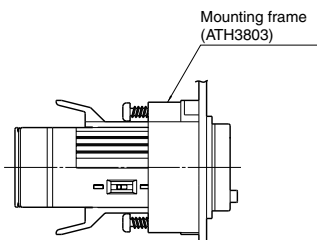

### • LH2H preset hour meter

1) When using the waterproof type (IP66: panel front only), install the hour meter to the front plate with mounting frame ATH3803 (sold separately) and rubber gasket ATH3804 (sold separately). Be sure to tighten using mounting screws.

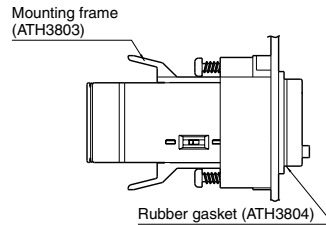

When installing the mounting frame and rubber gasket please remove the pre-attached o-ring.

### 2) Panel installation order

- (1) Remove o-ring.
- (2) Place rubber gasket.
- (3) Insert hour meter into panel.
- (4) Insert mounting frame from the rear.
- (5) Secure with mounting screws (two locations)

### 3. Do not use in the following environments

- 1) In places where the temperature changes drastically.
- 2) In places where humidity is high and there is the possibility of dew. (When dew forms the display may vanish and other display errors may occur.)

### 4. Conditions of use

- 1) Do not use on places where there is flammable or corrosive gas, lots of dust, presence of oil, or where the unit might be subject to strong vibrations or shocks.
- 2) Since the cover is made of polycarbonate resin, do not use in places where the unit might come into contact with or be exposed to environments that contain organic solvents such as methyl alcohol, benzene and thinner, or strong alkali substances such as ammonia and caustic soda.

### 5. Cautions regarding battery replacement

- 1) Remove wiring before replacing the battery. You may be electrocuted if you come into contact to a part where high voltage is applied.
- 2) Make sure you are not carrying a static electric charge when replacing the battery.
- 3) Battery replacement procedure  
For LH2H hour meter (one-touch installation type)
  - (1) Remove the up/down hook of the case using a tool.
  - (2) Pull the unit away from the case.
  - (3) Remove the battery from the side of the unit. Do not touch the display or other parts.
  - (4) Before inserting wipe clean the surface of the new battery.
  - (5) Insert the new battery with the "+" and "-" sides in the proper position.
  - (6) After replacing the battery, return the unit to the case. Verify that the hook of the case has properly engaged.
  - (7) Before using, press the reset button on the front.

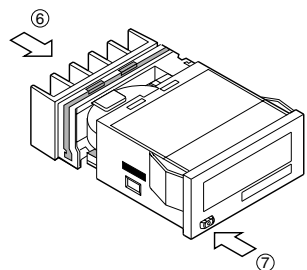
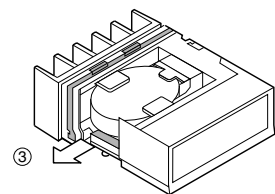
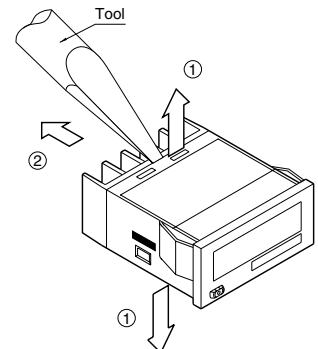

# PRECAUTIONS IN USING THE LH2H SERIES

For LH2H hour meter  
(installation frame type)

- (1) Remove the battery cover from the case.
- (2) Remove the battery from the side of the case. The battery will come loose if you put the battery side face down and lightly shake the unit.
- (3) Before inserting wipe clean the surface of the new battery.
- (4) Insert the new battery with the “+” and “-” sides in the proper position.
- (5) After replacing the battery, return the battery cover to the case. Verify that the hook of the battery cover is properly engaged.
- (6) Before using press the reset button on the front.

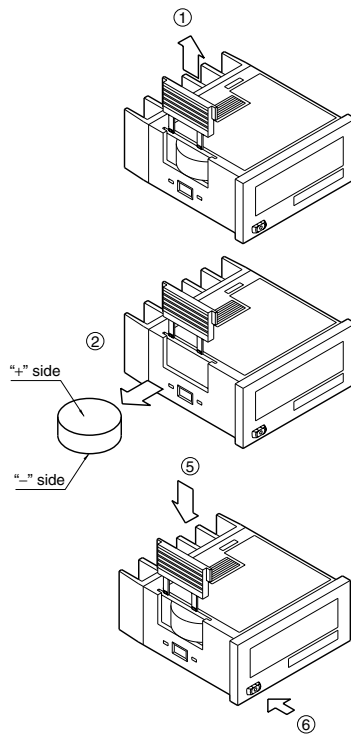



**Panasonic**  
ideas for life

**HOUR METER**

**TH13 / TH23**

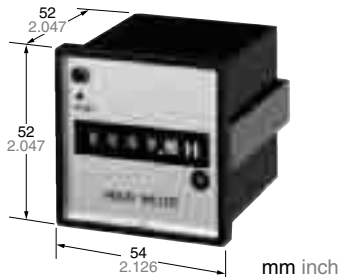

TH23 series (with reset function)



TH13 series (without reset function)

**UL File No.: E42876**  
**CSA File No.: LR39291**



## Features

- **High-performance compact synchronous motor**  
The accurately turning motor is employed to provide for longer period of measurement.
- **Compact and stylish**
- **Easier wiring**  
The flat terminals (#187) are quick and easy to connect.
- **Rotary indicator**  
The rotary indicator makes one turn every 2 minutes for monitoring.
- **Compliant with UL, CSA and CE.**

## Typical applications

Maintenance management of machine tools, automated machines, control panels, forming machines, medical equipment, generators, compressors, water treatment facilities, presses, motors, etc.

## Specifications

Rated operating voltage	100V AC, 200V AC, 110V AC, 115 to 120V AC, 220V AC, 240V AC	
Allowable operating voltage range	85 to 115% of rated operating voltage	
Rated frequency	50 Hz, 60 Hz (other model)	
Counting range	0 to 99999.9 hours (TH13 series) 0 to 9999.9 hours (TH23 series)	
Minimum time display	0.1 hours (6 min)	
Rated power consumption	Approx. 1.5 W	
Insulation resistance (Initial value)	Min. 100 MΩ, Between live and dead metal parts (At 500V DC)	
Breakdown voltage (Initial value)	2,000 Vrms, Between live and dead metal parts	
Max. temperature rise	55°C 131°F	
Vibration resistance	Functional	10 to 55 Hz: 1 cycle/min double amplitude of 0.5 mm (10 min on 3 axes)
Shock resistance	Functional	Min. 98 m/s: {10 G} (4 times on 3 axes)
	Destructive	Min. 980 m/s: {100 G} (5 times on 3 axes)
Ambient temperature	-10 to +50°C +14 to 122°F	
Ambient humidity	Max. 85% RH (non-condensing)	
Weight	135 g 4.76 oz	130 g 4.59 oz

## Product types

Type	Operating voltage	Part number		Operating voltage	Part number	
		50Hz	60Hz		50Hz	60Hz
TH13 types (without reset button)	100V AC	TH1345	TH1346	115V AC (115 to 120V AC)	TH1375	TH1376
	200V AC	TH1355	TH1356	220V AC	TH1385	TH1386
	110V AC	TH1365	TH1366	240V AC	TH1395	TH1396
TH23 types (with reset button)	100V AC	TH2345	TH2346	115V AC (115 to 120V AC)	TH2375	TH2376
	200V AC	TH2355	TH2356	220V AC	TH2385	TH2386
	110V AC	TH2365	TH2366	240V AC	TH2395	TH2396

Note) The 115 to 120V AC, 220V AC and 240V AC types are UL-recognized and CSA-certified. For those products, specify "U" at the end of the part number when ordering.

# TH13 / TH23

## Applicable standard

Safety standard	EN61010-1	Pollution Degree 2/Overvoltage Category II
EMC	(EM)EN61000-6-4 Radiation interference electric field strength Noise terminal voltage (EMS)EN61000-6-2 Static discharge immunity	EN55011 Group1 ClassA EN55011 Group1 ClassA
	RF electromagnetic field immunity EFT/B immunity Surge immunity Conductivity noise immunity Power frequency magnetic field immunity Voltage dip/Instantaneous stop/Voltage fluctuation immunity	EN61000-4-2 4 kV contact 8 kV air EN61000-4-3 10 V/m AM modulation (80 MHz to 1 GHz) 10 V/m pulse modulation (895 MHz to 905 MHz) EN61000-4-4 2 kV (power supply line) EN61000-4-5 1 kV (power line) EN61000-4-6 10 V/m AM modulation (0.15 MHz to 80 MHz) EN61000-4-8 30 A/m (50 Hz) EN61000-4-11 10 ms, 30% (rated voltage) 100 ms, 60% (rated voltage) 1,000 ms, 60% (rated voltage) 5,000 ms, 95% (rated voltage)

## Dimensions

mm inch  
General tolerance:  $\pm 1.0 \pm .039$

### • TH13 series

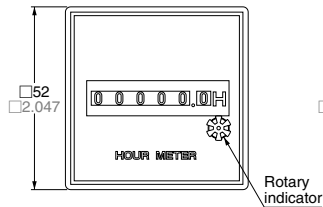

### • TH23 series

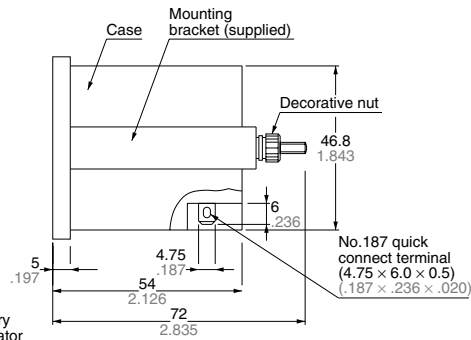
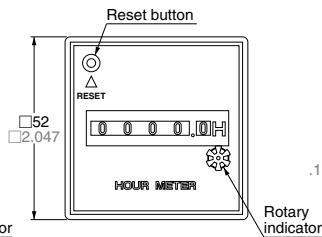

(TH13 and TH23 series common)

## Wiring diagram

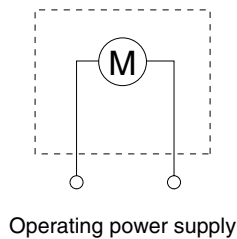

## Panel mounting

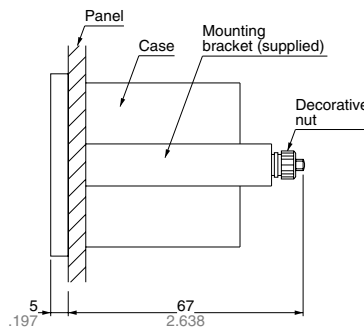

### • Panel cutout dimensions

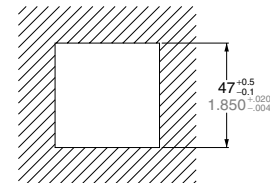

## Replacing the TH13/23 series with the TH14/24 series

The TH13/TH23 series hour meter are interchangeable with the TH14/24 series hour meter. Use the specified mounting frame because of a different setup method. It is advisable to introduce the TH14/24 series hour meters for the first time.

### DIN48 size and mounting frame setup

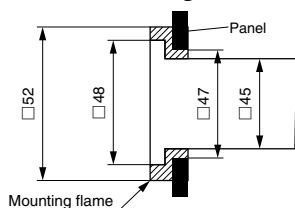

Mounting frame  
(sold separately):  
TH1400020

**Panasonic**  
ideas for life

**DIN 48 SIZE  
HOUR METER**

**TH14 / TH24**

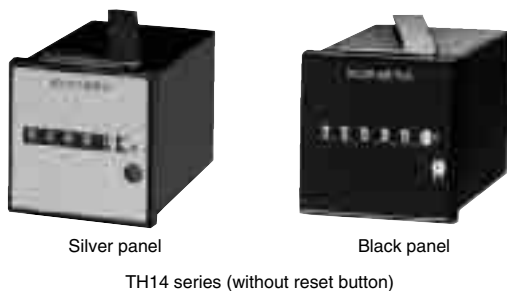
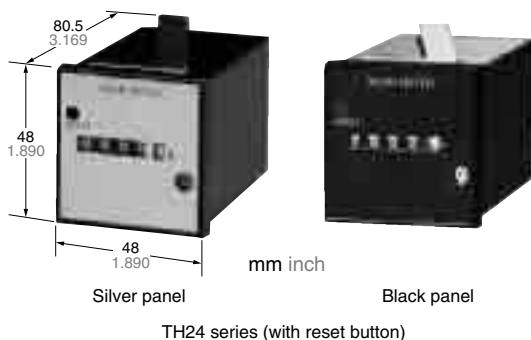

UL File No.: E42876  
CSA File No.: LR39291



## Features

- **High-performance compact synchronous motor**  
The accurately turning motor is employed to provide for longer period of measurement.
- **Common for 50/60 Hz power frequency**  
A lever is used to select 50 Hz or 60 Hz. There is no need to rearrange the control panel and other signal destinations.
- **Dimensions as per DIN 43700 standard**  
The units are in the 48x48 DIN standard size. They can be fitted in panels and give refined metallic appearance.
- **Easier wiring**  
The flat terminals (#187) are quick and easy to connect.
- **Rotary indicator**  
The rotary indicator makes one turn every 2 minutes for monitoring.
- **Compliant with UL, CSA and CE.**

## Typical applications

Maintenance management of machine tools, automated machines, control panels, forming machines, medical equipment, generators, compressors, water treatment facilities, presses, motors, etc.

## Specifications

Rated operating voltage	12 V AC, 24 V AC, 48 V AC, 100 V AC, 110 V AC, 115 to 120 V AC, 200 V AC, 220 V AC, 240 V AC	
Allowable operating voltage range	85 to 115% of rated operating voltage	
Rated frequency	50/60 Hz (selectable by switch)	
Counting range	0 to 99999.9 hours (TH14 series) 0 to 9999.9 hours (TH24 series)	
Minimum time display	0.1 hours (6 min)	
Rated power consumption	Approx. 1.5 W	
Insulation resistance (Initial value)	Min. 100 MΩ; Between live and dead metal parts (At 500V DC)	
Breakdown voltage (Initial value)	2,000 Vrms Between live and dead metal parts	
Max. temperature rise	55°C 131°F	
Vibration resistance	Functional	10 to 55 Hz: 1 cycle/min double amplitude of 0.5 mm (10 min on 3 axes)
Shock resistance	Functional	Min 98 m/s <sup>2</sup> {10 G} (4 times on 3 axes)
	Destructive	Min 980 m/s <sup>2</sup> {100 G} (5 times on 3 axes)
Ambient temperature	-10 to +50°C +14 to +122°F	
Ambient humidity	Max. 85% RH (non-condensing)	
Weight	145 g 5.11 oz (TH14 series)	150 g 5.29 oz (TH24 series)

## Product types

Type	Operating voltage	Part number		Operating voltage	Part number		Operating voltage	Part number	
		Silver panel	Black panel		Silver panel	Black panel		Silver panel	Black panel
TH14 series (without reset button)	100V AC	TH141S	TH141	24V AC	TH144S	TH144	115 to 120V AC	TH147S	TH147
	200V AC	TH142S	TH142	48V AC	TH145S	TH145		TH148S	TH148
	12V AC	TH143S	TH143	110V AC	TH146S	TH146		TH149S	TH149
TH24 series (with reset button)	100V AC	TH241S	TH241	24V AC	TH244S	TH244	115 to 120V AC	TH247S	TH247
	200V AC	TH242S	TH242	48V AC	TH245S	TH245		TH248S	TH248
	12V AC	TH243S	TH243	110V AC	TH246S	TH246		TH249S	TH249

Note) Only the black-panel type is UL-recognized and CSA-certified. For this type, specify "U" at the end of the part number when ordering.

# TH14 / TH24

## Applicable standard

Safety standard	EN61010-1	Pollution Degree 2/Overvoltage Category II
EMC	(EM)EN61000-6-4 Radiation interference electric field strength Noise terminal voltage (EMS)EN61000-6-2 Static discharge immunity	EN55011 Group1 ClassA EN55011 Group1 ClassA
	RF electromagnetic field immunity EFT/B immunity Surge immunity Conductivity noise immunity Power frequency magnetic field immunity Voltage dip/Instantaneous stop/Voltage fluctuation immunity	EN61000-4-2 4 kV contact 8 kV air EN61000-4-3 10 V/m AM modulation (80 MHz to 1 GHz) 10 V/m pulse modulation (895 MHz to 905 MHz) EN61000-4-4 2 kV (power supply line) EN61000-4-5 1 kV (power line) EN61000-4-6 10 V/m AM modulation (0.15 MHz to 80 MHz) EN61000-4-8 30 A/m (50 Hz) EN61000-4-11 10 ms, 30% (rated voltage) 100 ms, 60% (rated voltage) 1,000 ms, 60% (rated voltage) 5,000 ms, 95% (rated voltage)

## Dimensions (TH14 and TH24 series common)

mm inch  
General tolerance:  $\pm 1.0 \pm .039$

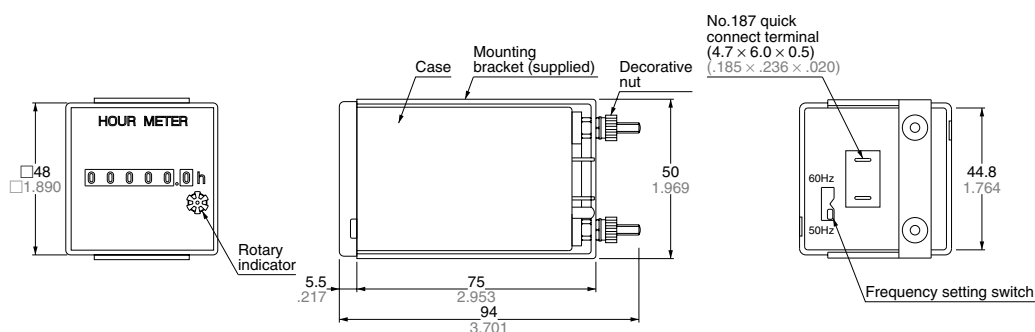

## Wiring diagram

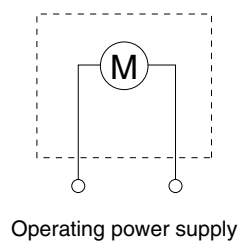

## Panel mounting

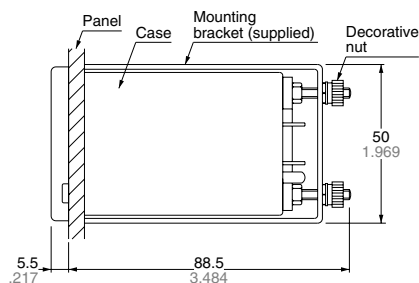

## Panel cutout dimensions

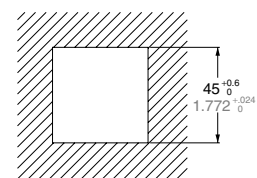

**Panasonic**  
ideas for life

**DIN 48  
DUAL INDICATOR  
HOUR METER**

**TH40**

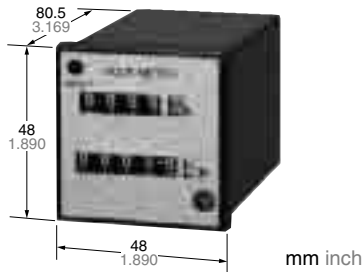

Silver panel



Black panel



## Features

- Upgraded composite function**  
 Specified-period measurement and total-time measurement can be monitored on a single hour meter.
- High-performance compact synchronous motor**  
 The accurately turning motor is employed to provide for longer period of measurement.
- Common for 50/60 Hz power frequency**  
 A lever is used to select 50 Hz or 60 Hz. There is no need to rearrange the control panel and other signal destinations.
- Dimensions as per DIN 43700 standard**  
 The units are in the 48x48 DIN standard size. They can be fitted in panels and give refined metallic appearance.
- Easier wiring**  
 The flat terminals (#187) are quick and easy to connect.
- Rotary indicator**  
 The rotary indicator makes one turn every 2 minutes for monitoring.
- Compliant with CE.**

## Specifications

Rated operating voltage	12 V AC, 24 V AC, 48 V AC, 100 V AC, 110 V AC, 115 to 120 V AC, 200 V AC, 220 V AC, 240 V AC	
Allowable operating voltage range	85 to 115% of rated operating voltage	
Rated frequency	50/60 Hz (selectable by switch)	
Counting range	0 to 9999.9 hours (upper side) ... with reset indicator 0 to 99999.9 hours (lower side) ... without reset indicator	
Minimum time display	0.1 hours (6 min)	
Rated power consumption	Approx. 1.5 W	
Insulation resistance (Initial value)	Min. 100 MΩ; Between live and dead metal parts (At 500V DC)	
Breakdown voltage (Initial value)	2,000 Vrms Between live and dead metal parts	
Max. temperature rise	55°C 131°F	
Vibration resistance	Functional	10 to 55 Hz: 1 cycle/min double amplitude of 0.5 mm (10 min on 3 axes)
Shock resistance	Functional	Min 98 m/s <sup>2</sup> {10 G} (4 times on 3 axes)
	Destructive	Min 980 m/s <sup>2</sup> {100 G} (5 times on 3 axes)
Ambient temperature	-10 to +50°C +14 to +122°F	
Ambient humidity	Max. 85% RH (non-condensing)	
Weight	160 g 5.64 oz	

## Product types

Type	Operating voltage	Part number		Operating voltage	Part number		Operating voltage	Part number	
		Silver panel	Black panel		Silver panel	Black panel		Silver panel	Black panel
TH40 series	100V AC	TH401S	TH401	24V AC	TH404S	TH404	115 to 120V AC	TH407S	TH407
	200V AC	TH402S	TH402	48V AC	TH405S	TH405	220V AC	TH408S	TH408
	12V AC	TH403S	TH403	110V AC	TH406S	TH406	240V AC	TH409S	TH409

# TH40

## Applicable standard

Safety standard	EN61010-1	Pollution Degree 2/Overvoltage Category II
EMC	(EM)EN61000-6-4 Radiation interference electric field strength Noise terminal voltage (EMS)EN61000-6-2 Static discharge immunity	EN55011 Group1 ClassA EN55011 Group1 ClassA
	RF electromagnetic field immunity EFT/B immunity Surge immunity Conductivity noise immunity Power frequency magnetic field immunity Voltage dip/Instantaneous stop/Voltage fluctuation immunity	EN61000-4-2 4 kV contact 8 kV air EN61000-4-3 10 V/m AM modulation (80 MHz to 1 GHz) 10 V/m pulse modulation (895 MHz to 905 MHz) EN61000-4-4 2 kV (power supply line) EN61000-4-5 1 kV (power line) EN61000-4-6 10 V/m AM modulation (0.15 MHz to 80 MHz) EN61000-4-8 30 A/m (50 Hz) EN61000-4-11 10 ms, 30% (rated voltage) 100 ms, 60% (rated voltage) 1,000 ms, 60% (rated voltage) 5,000 ms, 95% (rated voltage)

## Dimensions

mm inch  
General tolerance:  $\pm 1.0 \pm .039$

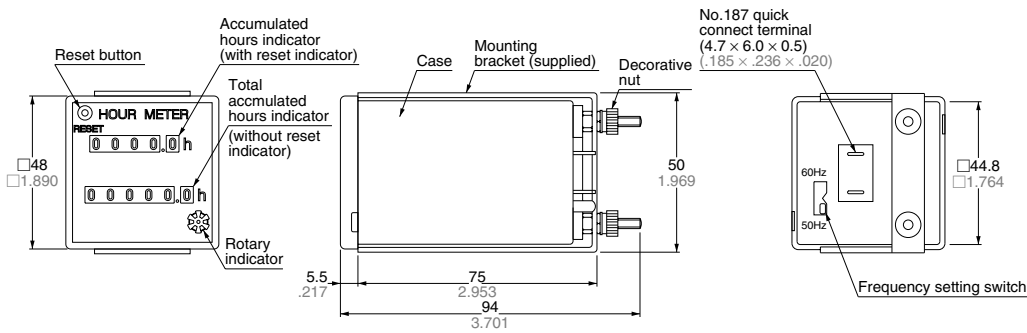

## Wiring diagram

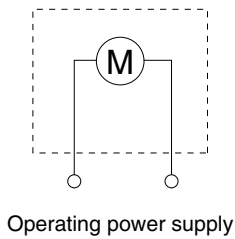

## Panel mounting

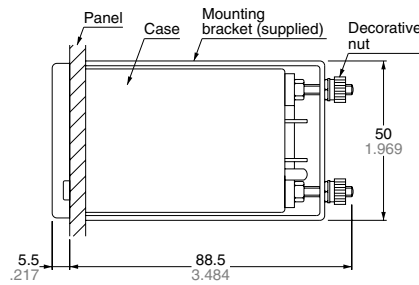

### • Panel cutout dimensions

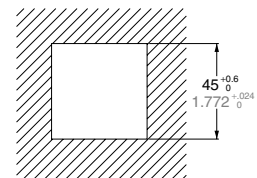

**Panasonic**  
ideas for life

**DIN 48 MINUTES  
INDICATOR  
HOUR METER**

**TH50**

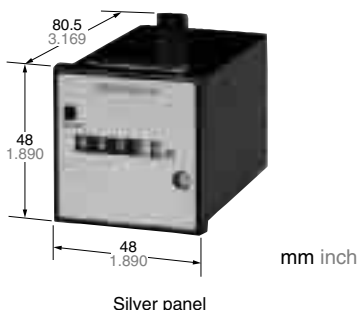

## Features

- Measurement and management in units of minutes**  
 Unlike conventional hour meters, the time can be measured and managed in minutes.
- Reset button**  
 The hour meters can be reset to zero for repeated measurement.
- High-performance compact synchronous motor**  
 The accurately turning motor is employed to provide for longer period of measurement.
- Common for 50/60 Hz power frequency**  
 A lever is used to select 50 Hz or 60 Hz. There is no need to rearrange the control panel and other signal destinations.
- Dimensions as per DIN 43700 standard**  
 The units are in the 48x48 DIN standard size. They can be fitted in panels and give refined metallic appearance.
- Easier wiring**  
 The flat terminals (#187) are quick and easy to connect.
- Rotary indicator**  
 The rotary indicator makes one turn every 2 seconds for monitoring.
- Compliant with CE.**

## Specifications

Rated operating voltage	12 V AC, 24 V AC, 48 V AC, 100 V AC, 110 V AC, 115 to 120 V AC, 200 V AC, 220 V AC, 240 V AC	
Allowable operating voltage range	85 to 115% of rated operating voltage	
Rated frequency	50/60 Hz (selectable by switch)	
Counting range	0 to 9999.9 min	
Minimum time display	0.1 min (6 sec)	
Rated power consumption	Approx. 1.5 W	
Insulation resistance (Initial value)	Min. 100 MΩ, Between live and dead metal parts (At 500 V DC)	
Breakdown voltage (Initial value)	2,000 Vrms, Between live and dead metal parts	
Max. temperature rise	55°C 131°F	
Vibration resistance	Functional	10 to 55 Hz: 1 cycle/min double amplitude of 0.5 mm (10 min on 3 axes)
Shock resistance	Functional	Min. 98 m/s <sup>2</sup> {10 G} (4 times on 3 axes)
	Destructive	Min. 980 m/s <sup>2</sup> {100 G} (5 times on 3 axes)
Ambient temperature	-10 to +50°C +14 to +122°F	
Ambient humidity	Max. 85% RH (non-condensing)	
Weight	150 g 5.29 oz	

## Product types

Type	Operating voltage	Part number		Operating voltage	Part number		Operating voltage	Part number	
		Silver panel	Black panel		Silver panel	Black panel		Silver panel	Black panel
TH50 series	100V AC	TH501S	TH501	24V AC	TH504S	TH504	115 to 120V AC	TH507S	TH507
	200V AC	TH502S	TH502	48V AC	TH505S	TH505	220V AC	TH508S	TH508
	12V AC	TH503S	TH503	110V AC	TH506S	TH506	240V AC	TH509S	TH509

# TH50

## Applicable standard

Safety standard	EN61010-1	Pollution Degree 2/Overvoltage Category II
EMC	(EM)EN61000-6-4 Radiation interference electric field strength Noise terminal voltage (EMS)EN61000-6-2 Static discharge immunity RF electromagnetic field immunity	EN55011 Group1 ClassA EN55011 Group1 ClassA
	EFT/B immunity Surge immunity Conductivity noise immunity Power frequency magnetic field immunity Voltage dip/Instantaneous stop/Voltage fluctuation immunity	EN61000-4-2 4 kV contact 8 kV air EN61000-4-3 10 V/m AM modulation (80 MHz to 1 GHz) 10 V/m pulse modulation (895 MHz to 905 MHz) EN61000-4-4 2 kV (power supply line) EN61000-4-5 1 kV (power line) EN61000-4-6 10 V/m AM modulation (0.15 MHz to 80 MHz) EN61000-4-8 30 A/m (50 Hz) EN61000-4-11 10 ms, 30% (rated voltage) 100 ms, 60% (rated voltage) 1,000 ms, 60% (rated voltage) 5,000 ms, 95% (rated voltage)

## Dimensions

mm inch  
General tolerance:  $\pm 1.0 \pm .039$

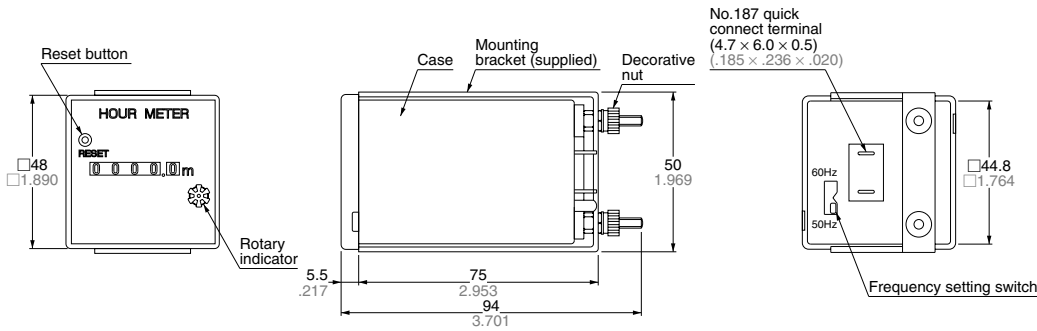

## Wiring diagram

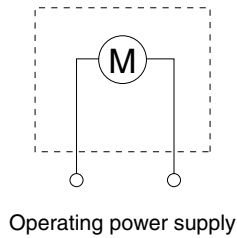

## Panel mounting

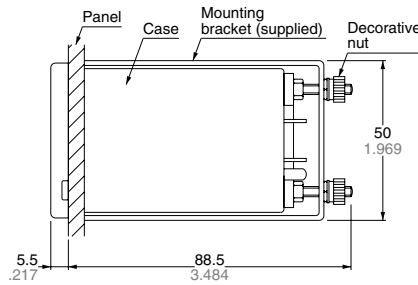

### • Panel cutout dimensions

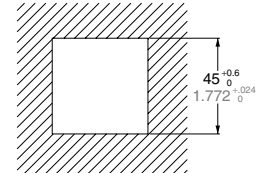



**Panasonic**  
ideas for life

**DIN HALF SIZE  
HOUR METER**

**TH63 / TH64**

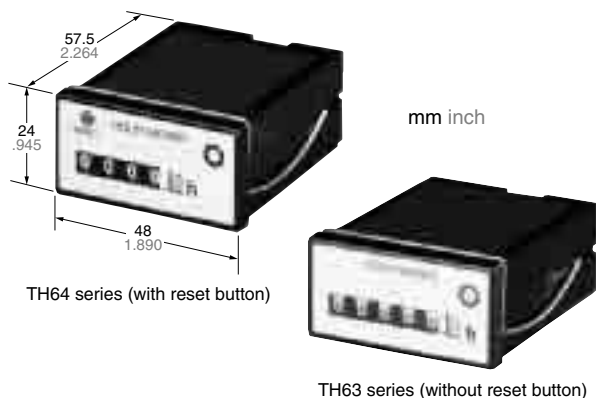

UL File No.: E42876  
CSA File No.: LR39291



## Features

- **Compact to save panel space**  
The 24x48 mm hour meters are just half the DIN 48x48 standard size. They help save the panel space.
- **Reset button**  
The hour meters can be reset to zero (TH64 series).
- **Wide-ranging measurement display**  
The measurement can be displayed from 0.1 hour up to 99999.9 hours (TH63 series). The dial size is the same as that of 48x48 DIN size hour meters (TH14 and TH24 series).
- **Easy to install**  
The flat terminals (#187) are used for easier wiring. There is no need to undo the lock spring.
- **High-performance sync motor with 50/60 Hz selector**  
The noise-resistant, accurately turning motor is employed to provide for longer period of measurement. The power frequency can be selected for 50 or 60 Hz.
- **Rotary indicator**  
The rotary indicator makes one turn every 72 seconds for monitoring.
- **Compliant with UL, CSA and CE.**

## Typical applications

Management of small generators and food processing machines; hour counting for leased equipment; maintenance management of various equipment, etc.

## Specifications

Rated operating voltage	12 V AC, 24 V AC, 48 V AC, 100 V AC, 110 V AC, 115 to 120 V AC, 200 V AC, 220 V AC, 240 V AC	
Allowable operating voltage range	85 to 115% of rated operating voltage	
Rated frequency	50/60 Hz (selectable by switch)	
Counting range	0 to 99999.9 hours (TH63 series) 0 to 9999.9 hours (TH64 series)	
Minimum time display	0.1 hours (6 min)	
Rated power consumption	Approx. 1.5 W	
Insulation resistance (Initial value)	Min. 100 MΩ, Between live and dead metal parts (At 500 V DC)	
Breakdown voltage (Initial value)	2,000 Vrms, Between live and dead metal parts	
Max. temperature rise	55°C 131°F	
Vibration resistance	Functional	10 to 55 Hz: 1 cycle/min double amplitude of 0.5 mm (10 min on 3 axes)
Shock resistance	Functional	Min 98 m/s <sup>2</sup> {10 G} (4 times on 3 axes)
	Destructive	Min 980 m/s <sup>2</sup> {100 G} (5 times on 3 axes)
Ambient temperature	-10 to +50°C +14 to +122°F	
Ambient humidity	Max. 85% RH (non-condensing)	
Weight	Approx. 80 g 2.82 oz	

## Product types

Type	Operating voltage	Part number	Operating voltage	Part number	Operating voltage	Part number
TH63 series (without reset button)	100V AC	TH631	24V AC	TH634	115 to 120V AC	TH637
	200V AC	TH632	48V AC	TH635	220V AC	TH638
	12V AC	TH633	110V AC	TH636	240V AC	TH639
TH64 series (with reset button)	100V AC	TH641	24V AC	TH644	115 to 120V AC	TH647
	200V AC	TH642	48V AC	TH645	220V AC	TH648
	12V AC	TH643	110V AC	TH646	240V AC	TH649

- Notes
1. Only the metallic-looking (silver) panel mounting type is available.
  2. Standard products are UL-recognized as well as CSA-certified. There is no need to add "U" at the end of the part number. Just specify the standard part number when ordering.

# TH63/64

## Applicable standard

Safety standard	EN61010-1	Pollution Degree 2/Overvoltage Category II
EMC	(EM)EN61000-6-4 Radiation interference electric field strength Noise terminal voltage (EMS)EN61000-6-2 Static discharge immunity	EN55011 Group1 ClassA EN55011 Group1 ClassA
	RF electromagnetic field immunity EFT/B immunity Surge immunity Conductivity noise immunity Power frequency magnetic field immunity Voltage dip/Instantaneous stop/Voltage fluctuation immunity	EN61000-4-2 4 kV contact 8 kV air EN61000-4-3 10 V/m AM modulation (80 MHz to 1 GHz) 10 V/m pulse modulation (895 MHz to 905 MHz) EN61000-4-4 2 kV (power supply line) EN61000-4-5 1 kV (power line) EN61000-4-6 10 V/m AM modulation (0.15 MHz to 80 MHz) EN61000-4-8 30 A/m (50 Hz) EN61000-4-11 10 ms, 30% (rated voltage) 100 ms, 60% (rated voltage) 1,000 ms, 60% (rated voltage) 5,000 ms, 95% (rated voltage)

## Dimensions

mm inch  
General tolerance:  $\pm 0.5 \pm .020$

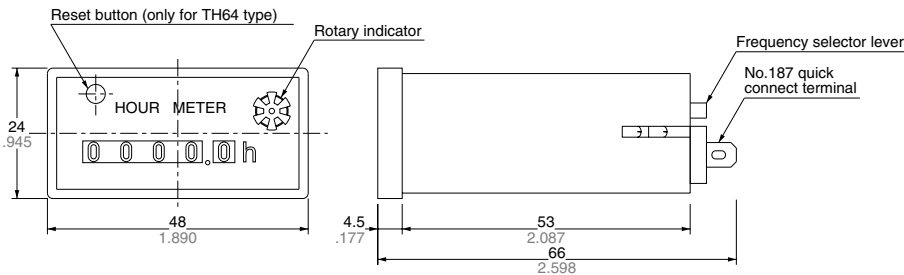

## Wiring diagram

mm inch

### • Panel cutout dimensions

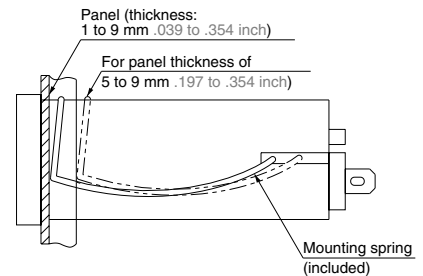
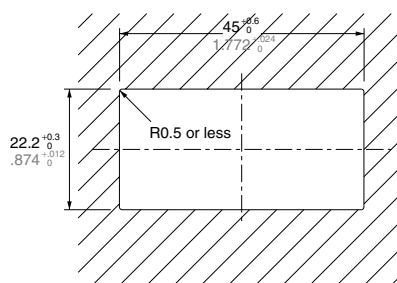
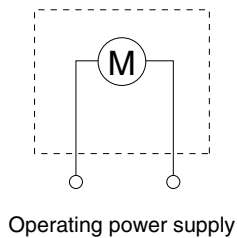

## Mounting

1. Cut a  $22.2^{+0.3}_0 \times 45^{+0.6}_0$  mm ( $.874^{+0.012}_0 \times 1.772^{+0.024}_0$  inch) opening in the panel.
2. Swing the mounting spring to the rear of the hour meter and fit the hour meter into the panel opening. (There is no need to detach the mounting spring from the hour meter.) If the panel is 5 to 9 mm .197 to .354 inch thick, move the mounting spring to the other hole toward the rear of the hour meter.
3. Swing the mounting spring to the front of the hour meter to secure the hour meter to the panel.
4. Wire the supplied quick connectors and connect to the hour meter. Be sure to use the supplied insulating sleeves to cover the connectors.

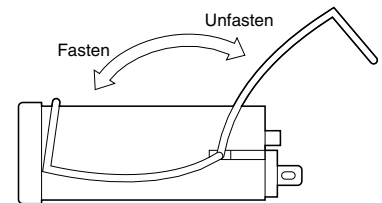

**Panasonic**  
ideas for life

**DIN HALF SIZE  
HOUR METER**

**TH8**



## Features

- **IP66 waterproof construction**  
The front panel surface keeps water and dust out. Perfect for use in rough conditions.
- **Includes operation light (LED)**  
The operation LED illuminates so you can quickly verify operation status.
- **Compliant with UL, c-UL and CE.**

## Product type

Installation	Measurement time	Operation light	Rated voltage	Part No.
Panel installation	0 to 9999.9 hours	LED illuminates while operating.	12 V DC	TH833C
			24 V DC	TH834C

Note: Products are UL and c-UL certified as standard. (Suffix "U" is not required ON part numbers when ordering.)

## Specifications

Item		Type	TH833C	TH834C
Rating	Rated voltage		12 V DC	24 V DC
	Usage voltage range		10.2 to 15.6 V DC	20.4 to 31.2 V DC
	Measurement time		0 to 9999.9 hours	
	Min. measurement time		0.1 hour (6 min.)	
	Power consumption		Approx. 1.5 W (With rated voltage applied at 25°C 77°F)	
Electrical characteristics	Insulation resistance (initial)		Min. 100 MΩ between charged and uncharged parts (measured at 500 V DC)	
	Breakdown voltage (initial)		Between charged and uncharged parts: 2,000 V AC for 1 minute.	
	Temperature rise		Max. 55°C 131°F (measured at rated voltage and resistance law)	
Mechanical characteristics	Functional vibration resistance		10 to 55 Hz (1 cycle/min.) Single amplitude: 0.35 mm (10 min. ON 3 axes)	
	Functional shock resistance		Min. 98 m/s <sup>2</sup> (4 times ON 3 axes)	
	Destructive vibration resistance		Min. 980 m/s <sup>2</sup> (5 times ON 3 axes)	
Usage conditions	Operation temperature		-20°C to +60°C -4°F to +140°F (Without due and frost)	
	Ambient humidity		35 to 85% RH (relative humidity) (non-condensing)	
	Power supply ripple		Approx. 48% or less (single phase, all-wave rectification)	
Protective construction			IP66 (front panel with a rubber gasket)	

## Applicable standard

EMC	(EMI)EN61000-6-4 Radiation interference electric field strength	EN55011 Group1 ClassA
	Noise terminal voltage	EN55011 Group1 ClassA
	(EMS)EN61000-6-2 Static discharge immunity	EN61000-4-2 4 kV contact 8 kV air
	RF electromagnetic field immunity	EN61000-4-3 10 V/m AM modulation (80 MHz to 1 GHz)
	EFT/B immunity	EN61000-4-4 2 kV (power supply line)
	Conductivity noise immunity	EN61000-4-6 10 V/m AM modulation (0.15 MHz to 80 MHz)
	Power frequency magnetic field immunity	EN61000-4-8 30 A/m (50 Hz)

# TH8

## Dimensions and part names (unit: mm inch)

Tolerance:  $\pm 1.0 \pm .039$

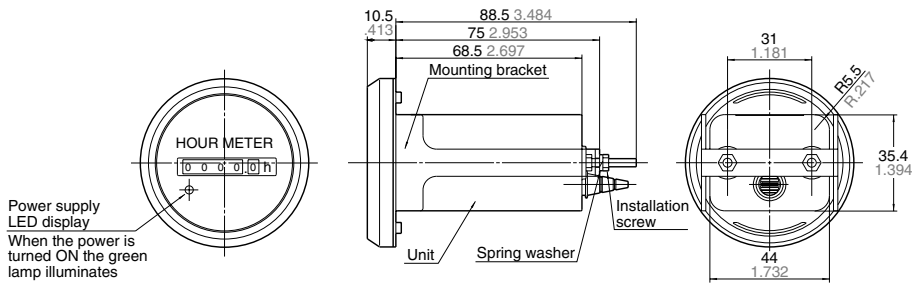

Power supply  
LED display  
When the power is  
turned ON the green  
lamp illuminates

## Wiring diagram

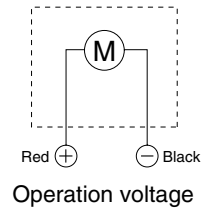

## Panel installation diagram

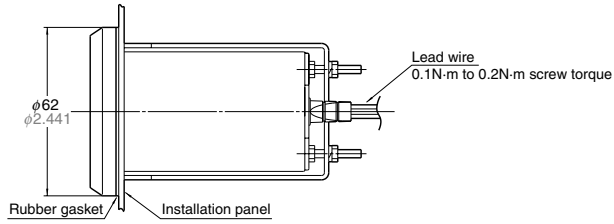

## Panel cutout dimensions

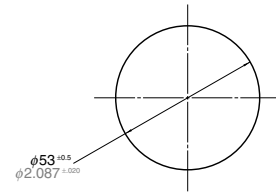

(Unit: mm inch)

# PRECAUTIONS IN USING THE HOUR METERS

## 1. Frequency setting

Frequency is specified for AC motor-driven hour meters. Before installing, be sure to check your local power frequency.

## 2. Connections

- TH13,23,14,24,40,50,63,64

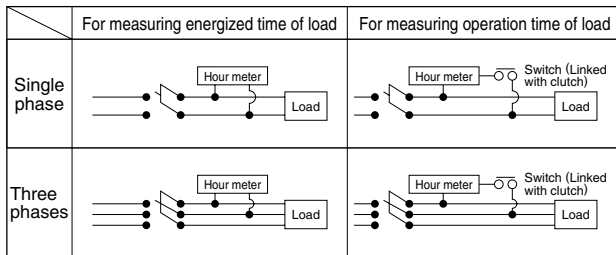

Note) Make the connection with the accompanying flat connector first and then with the hour meter's terminal (#187). In such case, be sure to cover the connection with the accompanying insulating sleeve.

- TH70, TH8

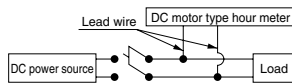

Note) Solder the lead wires in position.

## 3. Safety precautions

Do not use the hour meters in the following places.

- Where ambient temperature is below  $-10^{\circ}$  or above  $+50^{\circ}\text{C}$
- In wet, dusty or gaseous environments
- Where exposed to vibrations and shocks
- Outdoors, or where exposed to rain or direct sunlight

## 4. Compliant with CE.

- LH2H

Ambient conditions:

Overvoltage category III, contamination factor 2, indoor use.  
Ambient temperature and humidity  $-10$  and  $+55^{\circ}\text{C}$  and 35% to 85%RH respectively.

- TH13, 23, 14, 24, 40, 50, 63, 64

Ambient conditions:

Overvoltage category II, contamination factor 2, indoor use.  
Ambient temperature and humidity  $-10$  and  $+50^{\circ}\text{C}$  and below 85%RH respectively.

## 5. Reset-type hour meter

- Precautions for use

If the number indications are off before use, press the reset button and confirm that all zeroes ("0") are displayed.

- Resetting caution

Exercise due caution as an insufficient amount of pressure on the reset button may result in abnormal readings.

## 6. Acquisition of CE marking

Please abide by the conditions below when using in applications that comply with EN 61010-1/IEC 61010-1

### 1) Ambient conditions

- Overvoltage category II, pollution level 2
- Indoor use
- Acceptable temperature and humidity range:  $-10$  to  $+55^{\circ}\text{C}$ , 35 to 85%RH (with no condensation at  $20^{\circ}\text{C}$ )
- Under 2000 m elevation

### 2) Use the main unit in a location that matches the following conditions.

- There is minimal dust and no corrosive gas.
- There is no combustible or explosive gas.
- There is no mechanical vibration or impacts.
- There is no exposure to direct sunlight.
- Located away from large-volume electromagnetic switches and power lines with large electrical currents.

### 3) Connect a breaker that conforms to EN60947-1 or EN60947-3 to the voltage input section.

### 4) Applied voltage should be protected with an overcurrent protection device (example: T 1A, 250 V AC time lag fuse) that conforms to the EN/IEC standards. (Free voltage input type)

# OPTIONS AND ACCESSORIES

## Options

### 1. Accessories (for LC2H total counter)

Panel cover (black)



Part No.: AEL3801

You can change the design of the front panel by replacing it with this black panel cover. The counter comes with an ash gray panel cover as standard.

Note: No panel cover accessory (black) is available for the LC2H preset counter.

### 2. Lithium battery (3 V)



Part No.: ATH3802

Packaged with the LC2H (excluding the PC board mounting type).

#### Warning

- Make sure the “+” and “-” polarities are positioned correctly.
- Do not throw the old battery into a fire, short circuit it, take it apart, or allow it to come into contact with heat.
- The battery is not rechargeable.

### 3. Installation parts

#### Mounting frame

(Suitable for installation frame type LC2H total counter and LC2H preset counter)

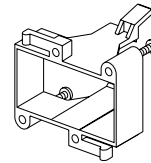

Part No.: ATH3803

Packaged with the mounting bracket type LC2H total counter

#### Rubber gasket

(Suitable for installation bracket type LC2H total counter and LC2H preset counter)



Part No.: ATH3804

Packaged with the mounting bracket type LC2H total counter

## Options

### 1. Accessories (for LH2H hour meter)

Panel cover (black)



Part No.: ATH3801

You can change the design of the front panel by replacing it with this black panel cover. The counter comes with an ash gray panel cover as standard.

Note: No panel cover option (black) is available for the LH2H preset hour meter.

### 2. Lithium battery (3 V)



Part No.: ATH3802

Packaged with the LH2H (excluding the PC board mounting type).

#### Warning

- Make sure the “+” and “-” polarities are positioned correctly.
- Do not throw the old battery into a fire, short circuit it, take it apart, or allow it to come into contact with heat.
- The battery is not rechargeable.

### 3. Installation parts

#### Mounting frame

Suitable for installation frame type LH2H hour meter and LH2H preset hour meter

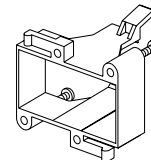

Part No.: ATH3803

Packaged with the mounting bracket type LH2H hour meter

#### Rubber gasket

Suitable for installation frame type LH2H hour meter and LH2H preset hour meter



Part No.: ATH3804

Packaged with the mounting bracket type LH2H hour meter



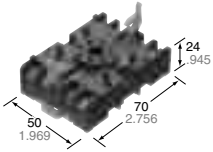
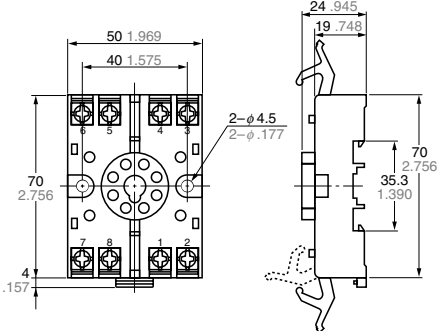
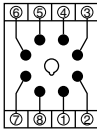
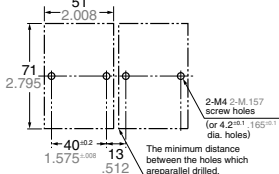
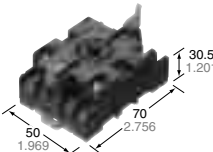
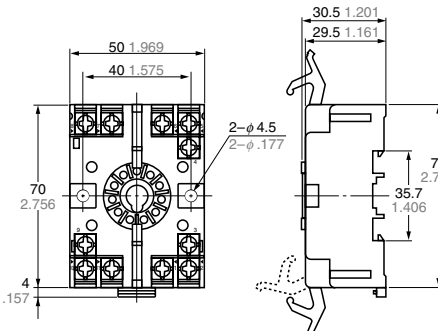
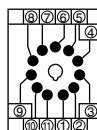
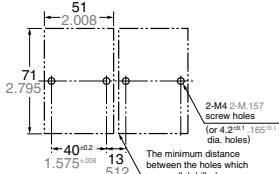

# DIN SIZE COUNTERS COMMON OPTIONS

## Terminal sockets (Unit: mm inch, Tolerance: $\pm 1 \pm .039$ )

Type	Appearance	Dimensions	Terminal wiring (Top view)	Mounting hole dimensions
LC4H (8-pin type)	<ul style="list-style-type: none"> <li>• DIN rail socket (8-pin)</li> </ul>  <p>ATC180031</p>		 <p>Note: Terminal No. on the main body are identical to those on the terminal socket.</p>	
LC4H LC4H-S LC4H-W (11-pin type)	<ul style="list-style-type: none"> <li>• DIN rail socket (11-pin)</li> </ul>  <p>ATC180041</p>		 <p>Note: Terminal No. on the main body are identical to those on the terminal socket.</p>	

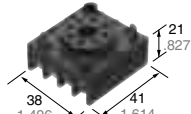
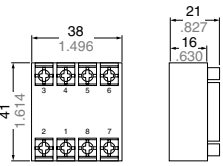
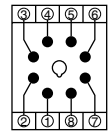
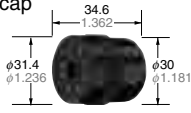
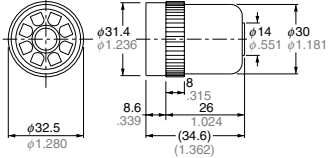
Note: The terminal numbers on the counter are identical to those on the terminal socket.

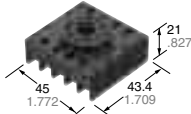
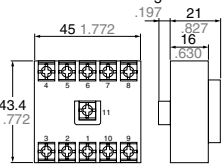
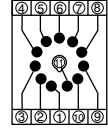
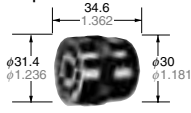
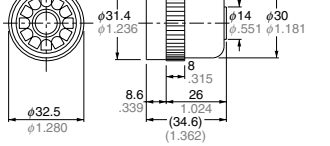
## Sockets (Unit: mm inch, Tolerance: $\pm 1 \pm .039$ )

Type	Appearance	Dimensions	Terminal wiring (Top view)	Mounting hole dimensions
LC4H (8-pin type)	<ul style="list-style-type: none"> <li>• Rear terminal socket</li> </ul>  <p>AT78041</p>			—
	<ul style="list-style-type: none"> <li>• 8P cap</li> </ul>  <p>AD8-RC</p>			—
LC4H LC4H-S LC4H-W (11-pin type)	<ul style="list-style-type: none"> <li>• Rear terminal socket</li> </ul>  <p>AT78051</p>			—
	<ul style="list-style-type: none"> <li>• 11P cap</li> </ul>  <p>AT8-DP11</p>			—

Note: The terminal numbers on the counter are identical to those on the socket.

# DIN SIZE COUNTERS COMMON OPTIONS

## • Rubber gasket

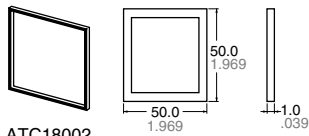

ATC18002

Applicable for LC4H series

The rubber gasket is enclosed in the LC4H series.

## • Mounting frame



AT8-DA4

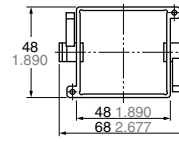

Applicable for LC4H series

## • Mounting rails (Applicable for DIN and IEC standards)



AT8-DLA1  
Length: 1 m  
aluminum

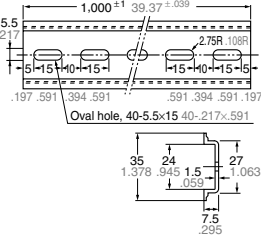

## • Fastening plate



ATA4806

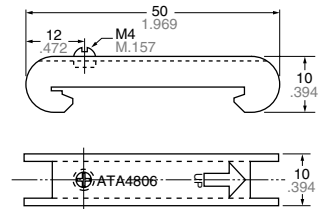

For holding DIN rails

## • Protective cover for DIN 48 size

Hard type

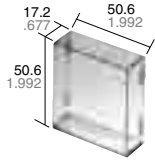

AQM4801

Flexible type

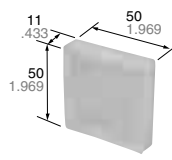

AQM4803

## • Panel cover (Black)

LC4H Panel cover (4 digits)



AEL58011

LC4H Panel cover (6 digits)



AEL58012

LC4H-S Panel cover (4 digits)



AEL58013

LC4H-S Panel cover (6 digits)

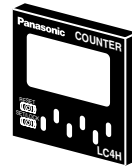

AEL58014

LC4H-W Panel cover (6 digits)

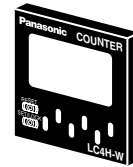

AEL68011

The black panel cover is also available so that you can change the appearance of the panel by changing the panel cover. The color of the standard panel cover is ash gray.



# APPLICATIONS

*The highly accurate, reliable counters can be controlled from the front panel and are suitable for a wide range of applications.*

## Typical Counter Applications

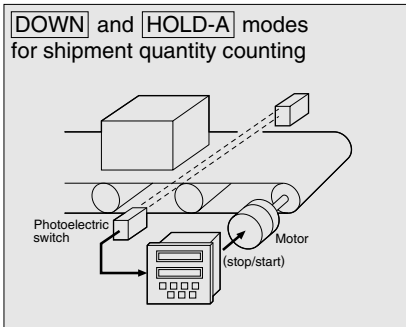

Shipment quantities are counted to control the conveyor line flow.

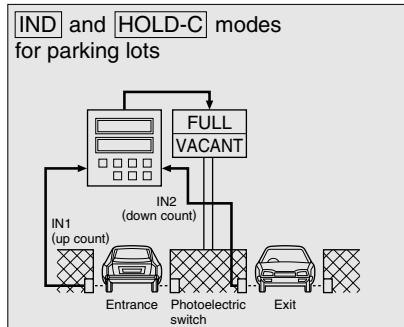

Incoming and outgoing cars are counted to switch the FULL and VACANT signs.

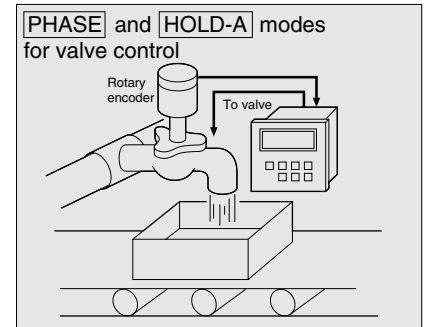

Rotary encoder signals are counted to control a valve aperture.

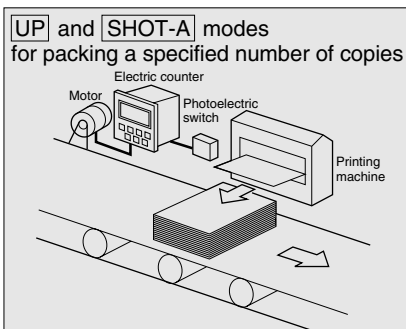

Printed matter is counted to package a specified number of copies.

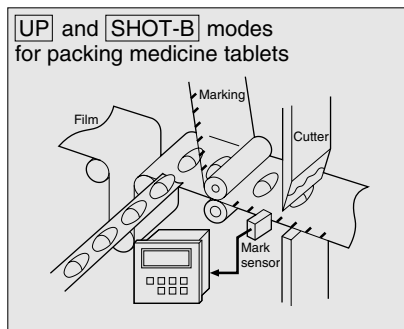

Medicine tablets are packed in specified quantities.

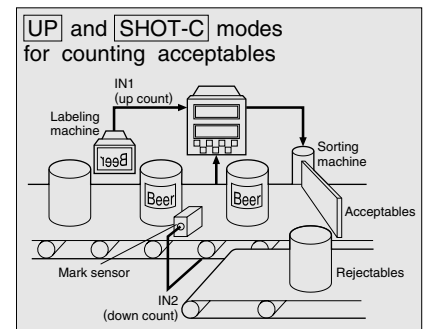

Labeled cans alone are counted up. Rejected cans are not counted.

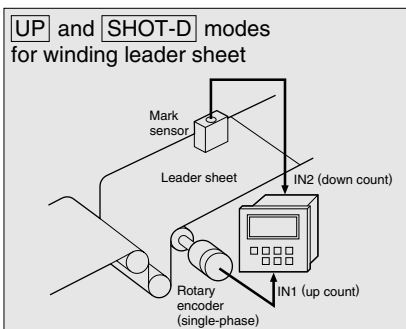

Extra leader sheet that is now wound is counted by a rotary encoder and a color detecting sensor.

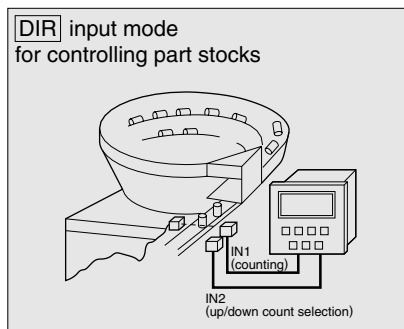

Incoming and outgoing parts are counted to keep parts feeders well-stocked.

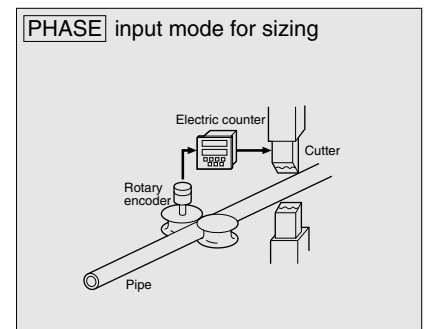

Teamed up with a rotary encoder, the counter is used to control the cutting length of pipes.

# POWER SUPPLIES

**Panasonic**  
ideas for life

**POWER  
SUPPLIES**

**FP 24VDC**



## Features

- **Incredibly small size:**
  - FP0 power supply: 90 x 60 x 30.4mm
  - FP power supply: 115 x 75 x 42mm
- **Maximum output current:**
  - FP0 power supply: 0.7A (24VDC)
  - FP power supply: 2.1A (24VDC)
- **Multiple voltage input:** 85 to 265VAC
- **Optimal protection:** overvoltage, overcurrent, overheating, etc.
- **Global approvals** (UL/cUL, EN, CE-marking)
- **DIN-rail mounting** (FP0 power supply also side mounting)

## Performance Specifications

Order No:	FP0-PSA2	FP-PS24-050E
Primary side:		
Rated operating voltage	115/230VAC	
Operating voltage range	85 to 265VAC	
Rated operating frequency	50/60Hz	
Operating frequency range	40 to 70Hz	
Inrush current	< 50A at 55°C	< 50A at 25°C / < 70A at 55°C
Current consumption	145mA (at 230VAC and 0.7A output current)	400mA (at 230VAC and 2.1A output current)
Over voltage protection	PROTECTED	
Secondary side:		
Rated output voltage	24VDC	
Output voltage range	23.5V to 24.5VDC	
Nominal output current	0.7A	2.1A
Output current range	0 to 0.7A	0 to 2.1A
Output ripple	< 60mV <sub>pp</sub>	< 240mV <sub>pp</sub>
Short circuit protected	Electronic, automatic restart mode	Continuous
Over voltage protected	Yes	
Over load protected	Yes (switch off at approx. 0.8A and more)	Yes (switch off at approx. 3.5A and more)
Holding time	Min. 20ms at 230VAC	Min. 110ms at 230VAC
Power OK signal	-	Yes

## General Specifications

Ambient temperature	0°C to +55°C	
Storage temperature	-20°C to +70°C	
Ambient humidity	5 to 95% non-condensing	
Storage humidity	5 to 95% non-condensing	
Vibration resistance	10 to 55Hz, 1 cycle/min.: double amplitude of 0.75mm, 10 min. on 3 axes	
Shock resistance	10g min., 4 times on 3 axes	
Life time min.	7 years at nom. load, 25°C ambient temperature, 20000 h at 55°C with full load/continuous operation	
Mounting	DIN rail or FP0 flat attachment plate	DIN rail
Size	90 x 60 x 30.4mm	115 x 75 x 42mm
Input connection AC side	MC connector, 2 pin	2 pin
Output connection DC side	MC connector, 6 pin, 3 pin for „+“ and 3 pin for „-“	5 pin, 2 pin for „+“ and 2 pin for „-“; 1 pin Power OK
Status display	LED (green) at the front side for the secondary voltage indication	

## Standards

EMC	EN 50082-2, EN50082-1, EN 50081-2, EN 50081-1	EN 55011/B, EN 55022/B, EN 61000-4-2, -4-3, -4-4, -4-5, -4-6, -4-11
LVD	EN 60950, EN 50178 (overvoltage category 3)	EN 60950, EN 50178 (overvoltage category 2)
Others	UL Recognized according to UL 508, UL 1950, cUL Recognized according to CAN/CSA-C22.2 No. 950.95	
Protection	IP30	IP20 outside/IP67 inside

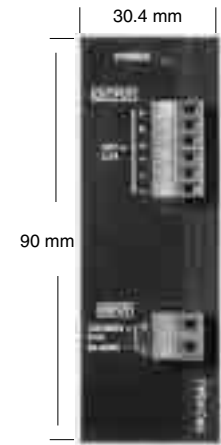

**FP0 Power supply  
FP0-PSA2**

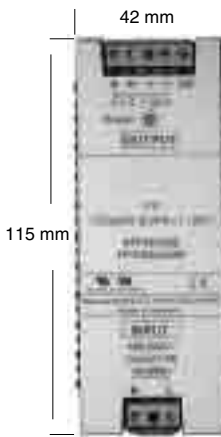

**FP Power supply  
FP-PS24-050 E**

### NOTE:

- 1) Mounting distance between the FP0 power supply and the FP0 CPU is needed to permit heat radiation for the FP0-CPU
- 2) For side mounting, 2 additional blue clips are needed: order part-no. 677-021-17101 (1pce.) for FP0-PSA2
- 3) Mounting distance between the power supply FP-PS24-050E and other devices is needed for cooling/heat radiation.

# INTERNATIONAL STANDARDS

## 1. International Standards

### IEC standard

#### International Electrotechnical Commission

By promoting international cooperation toward all problems and related issues regarding standardization in the electrical and electronic technology fields, the IEC, a non-governmental organization, was started in October, 1908, for the purpose of realizing mutual understanding on an international level. To this end, the IEC standard was enacted for the purpose of promoting international standardization.

## 2. North America

LISTING MARK



Fig. 1

RECOGNITION MARK



Fig. 2

Certification



Fig. 3

Component Acceptance



Fig. 4



Fig. 5



Fig. 6

#### UL (Underwriters Laboratories Inc.)

This is a non-profit testing organization formed in 1894 by a coalition of U.S. fire insurance firms, which tests and approves industrial products (finished products). When electrical products are marketed in the U.S., UL approval is mandated in many states, by state law and city ordinances. In order to obtain UL approval, the principal parts contained in industrial products must also be UL-approved parts.

UL approval is divided into two general types. One is called "listing" (Fig. 1), and applies to industrial products (finished products). Under this type of approval, products must be approved unconditionally. The other type is called "recognition" (Fig. 2), and is a conditional approval which applies to parts and materials.

#### CSA (Canadian Standards Association)

This was established in 1919 as a non-profit, non-governmental organization aimed at promoting standards. It sets standards for industrial products, parts, and materials, and has the authority to judge electrical products to determine whether they conform to those standards. The CSA is the ultimate authority in the eyes of both the government and the people in terms of credibility and respect. Almost all states and provinces in Canada require CSA approval by law, in order to sell electrical products. As a result, electrical products exported from Japan to Canada are not approved under Canadian laws unless they have received CSA approval and display the CSA mark. Approval is called "certification", and products and parts which have been approved are called "certified equipment", and display the mark shown in Fig. 3. The mark shown in Fig. 4 is called the "Component Acceptance" mark, and indicates conditional approval which is applicable to parts. The C-UL mark shown in Fig. 5 (finished products) and Fig. 6 (parts) indicates that the product has been tested and approved in UL laboratories, based on UL and CSA standards, through mutual approval activities.

## 3. Europe

### EN standard

#### European Standards/Norme Europeenne (France)/Europaishe Norm (Germany)

Abbreviation for European Standards. A unified standard enacted by CEN/CENELEC (European Standards Committee/European Electrical Standards Committee). EU and EFTA member nations employ the content of the EN standards into their own national standards and are obligated to abolish those national standards that do not agree with the EN standards.

### (1) Germany



#### VDE (Verband Deutscher Elektrotechniker)

The VDE laboratory was established mainly by the German Electric Technology Alliance, which was formed in 1893. It carries out safety experiments and passes approval for electrical devices and parts. Although VDE certification is not enforced under German law, punishment is severe should electrical shock or fire occur; therefore, it is, in fact, like an enforcement.



#### TÜV (Technischer Überwachungs-Verein)

TÜV is a civilian, non-profit, independent organization that has its roots in the German Boiler Surveillance Association, which was started in 1875 for the purpose of preventing boiler accidents. A major characteristic of TÜV is that it exists as a combination of 14 independent organizations (TÜV Rheinland, TÜV Bayern, etc.) throughout Germany. TÜV carries out inspection on a wide variety of industrial devices and equipment, and has been entrusted to handle electrical products, as well, by the government. TÜV inspection and certification is based mainly on the VDE standard.

TÜV certification can be obtained from any of the 14 TÜVs throughout Germany and has the same effectiveness as obtaining VDE certification.

## 4. Shipping Standards

### (1) Lloyd's Register of Shipping



Standards from the Lloyd's Register shipping association based in England. These standards are safety standards for environmental testing of the temperature and vibration tolerances of electrical components used for UMS (unmanned machine rooms in marine vessels) applications. These standards have become international standards for control equipment in all marine vessel applications. No particular action is taken to display the conformation to these standards on the products.

# INTERNATIONAL STANDARDS

## 5. Pilot Duty

One of the specifications in the “UL508 Industrial Control Equipment” regulations at UL (Underwriters Laboratories Inc.), has to do with the grade of contact control capacity by NEMA (National Electrical Manufacturers Association) standards. By obtaining both UL and CSA approval for this grade, the product becomes authorized publicly.

### Pilot Duty A300

AC applied voltage [V]	Electrification current [A]	Input power [A]	Breaker power [A]	[VA]	
				During input	During breaker
120	10	60	6	7,200	720
240		30	3	7,200	720

### Pilot Duty B300

AC applied voltage [V]	Electrification current [A]	Input power [A]	Breaker power [A]	[VA]	
				During input	During breaker
120	5	30	3	3,600	360
240		15	1.5	3,600	360

### Pilot Duty C300

AC applied voltage [V]	Electrification current [A]	Input power [A]	Breaker power [A]	[VA]	
				During input	During breaker
120	2.5	15	1.5	1,800	180
240		7.5	0.7	1,800	180

# INTERNATIONAL STANDARDS

## Timers

Product Name	Recognized by UL Standards		Certified by CSA Standards		Lloyd's Register Standards		Remarks	
	File No.	Recognized rating	File No.	Certified rating	File No.	Certified rating		
PM4H-A PM4H-S PM4H-M PM4H-SD PM4H-W	E122222	5A250VAC PILOT DUTY C300	LR39291	5A250VAC PILOT DUTY C300	98/10004	5A 250V AC (resistive)		
PM4H-F	E122222	3A250VAC PILOT DUTY C300	LR39291	3A250VAC PILOT DUTY C300	98/10004	3A 250V AC (resistive)		
LT4H LT4H-W	E122222	5A250VAC PILOT DUTY C300	E122222 (C-UL)	5A250VAC PILOT DUTY C300	—	—		
		100mA30VDC		100mA30VDC				
QM4H	E43149	5A250VAC PILOT DUTY C300	E43149 (C-UL)	5A250VAC PILOT DUTY C300	—	—		
S1DXM- A/M (Relay output)	2C	E122222	7A125VAC 6A250VAC 1/6HP125, 250VAC PILOT DUTY C300	LR39291	7A125VAC 6A250VAC 1/6HP125, 250VAC PILOT DUTY C300	98/10004	7A 250V AC (resistive)	
	4C	E122222	5A250VAC 1/10HP125, 250VAC PILOT DUTY C300	LR39291	5A250VAC 1/10HP125, 250VAC PILOT DUTY C300	98/10004	5A 250V AC (resistive)	
S1DX (Relay output)	2C	E122222	7A125VAC 6A250VAC 1/6HP125, 250VAC PILOT DUTY C300	LR39291	7A125VAC 6A250VAC 1/6HP125, 250VAC PILOT DUTY C300	98/10004	7A 250V AC (resistive)	
	4C	E122222	5A250VAC 1/10HP125, 250VAC PILOT DUTY C300	LR39291	5A250VAC 1/10HP125, 250VAC PILOT DUTY C300	98/10004	5A 250V AC (resistive)	
PM5S-A PM5S-S PM5S-M	E59504 (C-UL)	5A250VAC PILOT DUTY C300	E59504 (C-UL)	5A250VAC PILOT DUTY C300	—	—		

## Accessories

Products Name	Recognized by UL Standards		Certified by CSA Standards		Lloyd's Register Standards		Remarks
	File No.	Recognized rating	File No.	Certified rating	File No.	Certified rating	
Common mounting tracks for timers	E59504	10A250VAC AT8-RFD (AT78039) 7A250VAC AT8-DF8L (ATA48211) 8P cap was an approved as an option. AD8-RC (AD8013)	LR39291	10A250VAC AT8-RFD (AT78039) 7A250VAC AT8-DF8L (ATA48211) 8P cap was an approved as an option. AD8-RC (AD8013)	—	—	
	E148103	AT8-DF8K (ATC180031) AT8-DF11K (ATC180041) AT8-R8K (AT78041) AT8- R11K (AT78051)	E148103 (C-UL)	AT8-DF8K (ATC180031) AT8-DF11K (ATC180041) AT8-R8K (AT78041) AT8- R11K (AT78051)	—	—	

# INTERNATIONAL STANDARDS

## Counters

Product name	UL recognized		CSA certified		Remarks
	File No.	Approved ratings	File No.	Approved ratings	
LC4H LC4H-S	E122222	5A250V AC PILOT DUTY C300 100mA 30V DC	E122222 (C-UL)	5A250V AC PILOT DUTY C300 100mA 30V DC	"The standard models conform to the UL/C-UL standard. (To place an order, you do not need to specify the tailing character ☉ of each item number.)"
LC4H-W	E122222	3A250V AC PILOT DUTY C300 100mA 30V DC	E122222 (C-UL)	3A250V AC PILOT DUTY C300 100mA 30V DC	
LC2H	E122222	24-240 V AC/DC 4.5-30 V DC 3 V DC	E122222 (C-UL)	24-240 V AC/DC 4.5-30 V DC 3 V DC	

(Notes) For UL-listed products, specify „9“ at the end of the part No. when ordering.

Standard products of LC4H series are UL-recognized as well as CSA-certified. There is no need to add „9“ at the end of the part No.

## Hour Meters

Product name	UL recognized		CSA certified		Remarks
	File No.	Approved ratings	File No.	Approved ratings	
TH13 · TH23 series	E42876	115-120, 220, 240V AC	LR39291	115-120, 220, 240V AC	• For UL-recognized and CSA-certified products, specify "U" at the end of the part No.
TH14 · TH24 series	E42876	12, 24, 48, 100, 110, 115-120, 200, 220, 240V AC	LR39291	12, 24, 48, 100, 110, 115-120, 200, 220, 240V AC	• Only black panel-mounting type UL-recognized and CSA-certified. • For UL-recognized and CSA-certified products, specify "U" at the end of the product code. • Panel-mounting silver type not UL-recognized nor CSA-certified.
TH63 · 64 series	E42876	12, 24, 48, 100, 110, 115-120, 200, 220, 240V AC	LR39291	12, 24, 48, 100, 110, 115-120, 200, 220, 240V AC	• Standard products are UL-recognized and CSA-certified.
LH2H	E122222	24-240 V AC/DC 4.5-30 V DC 3 V DC	E122222 (C-UL)	24-240 V AC/DC 4.5-30 V DC 3 V DC	Standard products are UL and C-UL-recognized. To place an order, you do not need to specify the tailing character ☉ of each item number.
TH8 series	E42876	12 V DC 24 V DC	E42876 (C-UL)	12 V DC 24 V DC	Standard products are UL and C-UL-recognized. To place an order, you do not need to specify the tailing character "U" of each item number.

(Notes) For UL-recognized and CSA-certified products, specify "U" at the end of the part No. when ordering.

① UL-recognized as well as CSA-certified TH13 and TH23 series products have operating voltages of 115-120V, 220V and 240V AC.

② Standard products of TH63 and 64 series are UL-recognized as well as CSA-certified. There is no need to add "U" at the end of the part No.

③ Standard products of LH2H and TH8 series are UL/C-UL recognized. There is no need to add ☉ or "U" at the end of the part No.

## Accessories

Product name	UL-recognized		CSA certified		Remarks
	File No.	Rating	File No.	Rating	
Common counter fixtures	E59504	10A250V AC AT8-RFV (AT78029) AT8-RFD (AT78039) 7A250V AC AT8-DF8L (ATA48211) AT8-RR (AT78049) 8P cap CSA-certified as option. AD8-RC (AD8013)	LR26550 LR39291	10A250V AC AT8-RFV (AT78029) AT8-RFD (AT78039) 7A250V AC AT8-DF8L (ATA48211) AT8-RR (AT78049) 8P cap UL-listed as option. AD8-RC(AD8013)	
	E148103	AT8-DF8K (ATC180031) AT8-DF11K (ATC180041) AT8-R8K (AT78041) AT8- R11K (AT78051) Relay Socket	E148103 (C-UL)	AT8-DF8K (ATC180031) AT8-DF11K (ATC180041) AT8-R8K (AT78041) AT8- R11K (AT78051)	

# CE MARKINGS OVERVIEW

## Counter, Hour Meter conforming to EN/IEC standards

The Timer, Counter, Hour Meter shown below conform to both EN and IEC standards, and may display the CE markings.

Product classification	Product name	EMC directives	Low-voltage directives	
Timers	LT4H	EN 61000-6-4/EN 61000-6-2	EN 61812-1	
	LT4H-W	EN 61000-6-4/EN 61000-6-2	EN 61812-1	
	PM4H	EN 61000-6-4/EN 61000-6-2	EN 61812-1	
	S1DX	EN 61000-6-4/EN 61000-6-2	EN 61812-1	
	S1DXM-AM	EN 61000-6-4/EN 61000-6-2	EN 61812-1	
	PM55	EN 61000-6-4/EN 61000-6-2	EN 61812-1	
	QM4H	EN 61000-6-4/EN 61000-6-2	EN 61010-1	
Counters	LC4H	EN 61000-6-4/EN 61000-6-2	EN 61812-1	
	LC4H-S	EN 61000-6-4/EN 61000-6-2	EN 61812-1	
	LC4H-W	EN 61000-6-4/EN 61000-6-2	EN 61812-1	
	LC2H	EN 61000-6-4/EN 61000-6-2	EN 61010-1	
	LC2H preset	EN 61000-6-4/EN 61000-6-2	—	
Hour Meters	TH13	EN 61000-6-4/EN 61000-6-2	EN 61010-1	
	TH20	EN 61000-6-4/EN 61000-6-2	EN 61010-1	
	TH14	EN 61000-6-4/EN 61000-6-2	EN 61010-1	
	TH24	EN 61000-6-4/EN 61000-6-2	EN 61010-1	
	TH40	EN 61000-6-4/EN 61000-6-2	EN 61010-1	
	TH50	EN 61000-6-4/EN 61000-6-2	EN 61010-1	
	TH63	EN 61000-6-4/EN 61000-6-2	EN 61010-1	
	TH64	EN 61000-6-4/EN 61000-6-2	EN 61010-1	
	LH2H	EN 61000-6-4/EN 61000-6-2	EN 61010-1	
		LH2H preset	EN 61000-6-4/EN 61000-6-2	—
		TH8	EN 61000-6-4/EN 61000-6-2	—

## What are EN standards?

An abbreviation of Norme Européenne (in French), and called European Standards in English. Approval is by vote among the CEN/CENELEC member countries, and is a unified standards limited to EU member countries, but the contents conform to the international ISO/IEC standards.

If the relevant EN standard does not exist, it is necessary to obtain approval based on the relevant IEC standard or, if the relevant IEC standard does not exist, the relevant standard from each country, such as VDE, BS, SEMKO, and so forth.

## CE markings and EC directives

The world's largest single market, the European Community (EC) was born on 1 January 1993 (changing its name to EU in November 1993. It is now always expressed as EU, apart from EC directives.) EU member country products have always had their quality and safety guaranteed according to the individual standards of each member country. However, the standards of each country being different prevented the free flow of goods within the EU. For this reason, in order to eliminate non-tariff barriers due to these standards, and to maximize the merits of EU unification, the EC directives were issued concomitant to the birth of the EU.

The EN standards were established as universal EU standards in order to facilitate EU directives. These standards were merged with the international IEC standards and henceforth reflect the standards in all countries. Also, the CE markings show that products conform to EC directives, and guarantee the free flow of products within the EC.

## Appropriate EC directives for control equipment products

The main EC directives that are to do with machinery and electrical equipment are the machinery directive, the EMC directive, the low voltage directive, and the telecom directive. Although these directives have already been issued, the date of their enactment is different for each one. The machinery directive was 1 January 1995. The EMC directive was 1 January 1996, and the low voltage directive was enacted from 1 January 1997. The telecom directive was established by the separate CTR (Common Technology References.)

North America

Europe

Asia Pacific

China

Japan

## Panasonic Electric Works

Please contact our Global Sales Companies in:

### Europe

▶ <b>Headquarters</b>	<b>Panasonic Electric Works Europe AG</b>	Rudolf-Diesel-Ring 2, 83607 Holzkirchen, Tel. +49 (0) 8024 648-0, Fax +49 (0) 8024 648-111, <a href="http://www.panasonic-electric-works.com">www.panasonic-electric-works.com</a>
▶ <b>Austria</b>	<b>Panasonic Electric Works Austria GmbH</b>	Rep. of PEWDE, Josef Madersperger Str. 2, 2362 Biedermansdorf, Tel. +43 (0) 2236-26846, Fax +43 (0) 2236-46133 <a href="http://www.panasonic-electric-works.at">www.panasonic-electric-works.at</a>
	<b>PEW Electronic Materials Europe GmbH</b>	Ennshafenstraße 30, 4470 Enns, Tel. +43 (0) 7223 883, Fax +43 (0) 7223 88333, <a href="http://www.panasonic-electronic-materials.com">www.panasonic-electronic-materials.com</a>
▶ <b>Benelux</b>	<b>Panasonic Electric Works Sales Western Europe B.V.</b>	De Rijn 4, (Postbus 211), 5684 PJ Best, (5680 AE Best), Netherlands, Tel. +31 (0) 499 372727, Fax +31 (0) 499 372185, <a href="http://www.panasonic-electric-works.nl">www.panasonic-electric-works.nl</a>
▶ <b>Czech Republic</b>	<b>Panasonic Electric Works Czech s.r.o.</b>	Průmyslová 1, 34815 Planá, Tel. (+420-)374 799 990, Fax (+420-)374 799 999, <a href="http://www.panasonic-electric-works.cz">www.panasonic-electric-works.cz</a>
▶ <b>France</b>	<b>Panasonic Electric Works Sales Western Europe B.V.</b>	Succursale française, 10, rue des petits ruisseaux, 91370 Verrières Le Buisson, Tél. +33 (0) 1 6013 5757, Fax +33 (0) 1 6013 5758, <a href="http://www.panasonic-electric-works.fr">www.panasonic-electric-works.fr</a>
▶ <b>Germany</b>	<b>Panasonic Electric Works Deutschland GmbH</b>	Rudolf-Diesel-Ring 2, 83607 Holzkirchen, Tel. +49 (0) 8024 648-0, Fax +49 (0) 8024 648-555, <a href="http://www.panasonic-electric-works.de">www.panasonic-electric-works.de</a>
▶ <b>Hungary</b>	<b>Panasonic Electric Works Europe AG</b>	Magyarországi Közvetlen Kereskedelmi Képviselő, 1117 Budapest, Neumann János u. 1., Tel. +36 (0) 1482-9258, Fax +36 (0) 1482-9259, <a href="http://www.panasonic-electric-works.hu">www.panasonic-electric-works.hu</a>
▶ <b>Ireland</b>	<b>Panasonic Electric Works UK Ltd.</b>	Dublin, Tel. +353 (0) 14600969, Fax +353 (0) 14601131, <a href="http://www.panasonic-electric-works.co.uk">www.panasonic-electric-works.co.uk</a>
▶ <b>Italy</b>	<b>Panasonic Electric Works Italia srl</b>	Via del Commercio 3-5 (Z.I. Ferlina), 37012 Bussolengo (VR), Tel. +39 (0) 456752711, Fax +39 (0) 456700444, <a href="http://www.panasonic-electric-works.it">www.panasonic-electric-works.it</a>
▶ <b>Nordic Countries</b>	<b>Panasonic Electric Works Nordic AB</b> <b>PEW Fire &amp; Security Technology Europe AB</b>	Sjöängsvägen 10, 19272 Sollentuna, Sweden, Tel. +46 859476680, Fax +46 859476690, <a href="http://www.panasonic-electric-works.se">www.panasonic-electric-works.se</a>
▶ <b>Poland</b>	<b>Panasonic Electric Works Polska sp. z o.o.</b>	Jungmansgatan 12, 21119 Malmö, Tel. +46 40 697 7000, Fax +46 40 697 7099, <a href="http://www.panasonic-fire-security.com">www.panasonic-fire-security.com</a>
▶ <b>Portugal</b>	<b>Panasonic Electric Works España S.A.</b>	Al. Krakowska 4/6, 02-284 Warszawa, Tel. +48 (0) 22 338-11-33, Fax +48 (0) 22 338-12-00, <a href="http://www.panasonic-electric-works.pl">www.panasonic-electric-works.pl</a>
▶ <b>Spain</b>	<b>Panasonic Electric Works España S.A.</b>	Portuguese Branch Office, Avda Adelino Amaro da Costa 728 R/C J, 2750-277 Cascais, Tel. +351 214812520, Fax +351 214812529
▶ <b>Switzerland</b>	<b>Panasonic Electric Works Schweiz AG</b>	Barajas Park, San Severo 20, 28042 Madrid, Tel. +34 913293875, Fax +34 913292976, <a href="http://www.panasonic-electric-works.es">www.panasonic-electric-works.es</a>
▶ <b>United Kingdom</b>	<b>Panasonic Electric Works UK Ltd.</b>	Grundstrasse 8, 6343 Rotkreuz, Tel. +41 (0) 41 7997050, Fax +41 (0) 41 7997055, <a href="http://www.panasonic-electric-works.ch">www.panasonic-electric-works.ch</a>
		Sunrise Parkway, Linford Wood, Milton Keynes, MK14 6 LF, Tel. +44 (0) 1908 231555, Fax +44 (0) 1908 231599, <a href="http://www.panasonic-electric-works.co.uk">www.panasonic-electric-works.co.uk</a>

### North & South America

▶ <b>USA</b>	<b>PEW Corporation of America</b>	629 Central Avenue, New Providence, N.J. 07974, Tel. 1-908-464-3550, Fax 1-908-464-8513, <a href="http://www.pewa.panasonic.com">www.pewa.panasonic.com</a>
--------------	-----------------------------------	---

### Asia Pacific/China/Japan

▶ <b>China</b>	<b>Panasonic Electric Works (China) Co., Ltd.</b>	Level 2, Tower W3, The Towers Oriental Plaza, No. 2, East Chang An Ave., Dong Cheng District, Beijing 100738, Tel. (010) 8518-5988, Fax (010) 8518-1297
▶ <b>Hong Kong</b>	<b>Panasonic Electric Works (Hong Kong) Co., Ltd.</b>	RM1205-9, 12/F, Tower 2, The Gateway, 25 Canton Road, Tsimshatsui, Kowloon, Hong Kong, Tel. (0852) 2956-3118, Fax (0852) 2956-0398
▶ <b>Japan</b>	<b>Panasonic Electric Works Co., Ltd.</b>	1048 Kadoma, Kadoma-shi, Osaka 571-8686, Japan, Tel. (06) 6908-1050, Fax (06) 6908-5781, <a href="http://www.panasonic-electric-works.net">www.panasonic-electric-works.net</a>
▶ <b>Singapore</b>	<b>Panasonic Electric Works Asia Pacific Pte. Ltd.</b>	101 Thomson Road, #25-03/05, United Square, Singapore 307591, Tel. (06255) 5473, Fax (06253) 5689