

SBE®80 / SBO® 60 Connectors - up to 80 Amps



SBE® and SBO® connectors build on the capability of the two pole SB® connectors by offering up to 8 auxiliary power / signal contacts along with an IEC 60950 touch safe housing. The center of the main connector features a connector holder for either: two PP15-45, two PPMX, or APP's innovative 1x4 auxiliary connector.

- **Touch Safe Interface**
Minimizes potential contact with live circuits per IEC 60950
- **Up to 8 Last Mate / First Break Auxiliary's**
Enables intelligent power switching, CAN and interlock loop circuitry, as well as power up to 20 amps per pole
- **Silver Plated Wire Contacts up to #4 (25 mm²)**
Allows UL rated currents up to 80 amps per pole

| SBE®80 / SBO®60 ORDERING INFORMATION |

SBE®80 / SBO®60 Housings

The smallest size of SBE®, X, O style housing. SBE® housings are molded from a chemical resistant PBT. SBO® housings are molded from PC. SBE®80 and SBO®60 housings of the same Voltage Color Code can be mated but is not recommended as it invalidates UL approvals. SBO®60 housings do not meet EN1175-1 requirements for industrial trucks.

Description	Voltage Color Code	----- SBE®80 Part Numbers -----		----- SBO®60 Part Numbers -----	
		400	25	400	25
Minimum Quantity		400	25	400	25
Yellow	12V	SBE80YEL-BK	SBE80YEL	SBO60YEL-BK	SBO60YEL
Orange	18V	SBE80ORN-BK	SBE80ORN	SBO60ORN-BK	SBO60ORN
Red	24V	SBE80RED-BK	SBE80RED	SBO60RED-BK	SBO60RED
Gray	36V	SBE80GRA-BK	SBE80GRA	N/A	N/A
White	144V	N/A	N/A	SBO60WHT-BK	SBO60WHT

SBE®80 / SBO®60 Silver Plated Primary Power Wire Contacts

Use two silver plated contacts per housing for the best electrical performance and durability up to 10,000 mating cycles.

AWG	mm ²	Mating Force	- Loose Piece Part Numbers -		Dimensions				
					- A -		- B -		
			inches	mm	inches	mm			
Minimum Quantity			1,000	100					
4	25	Low	1339G4-BK	1339G4	0.28	7.11	0.35	9.0	
6	16	High	1339G1-BK	1339G1	0.22	5.59	0.29	7.3	

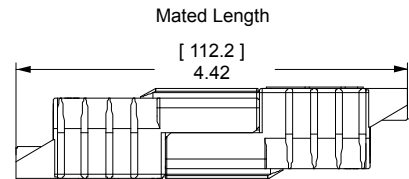
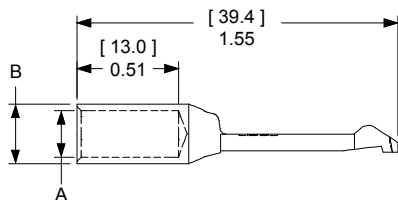

Side View

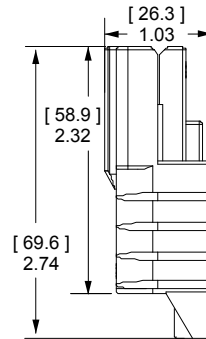

Top View

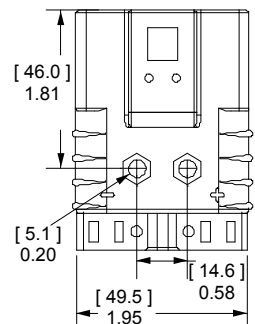

| SBE® 80 / SBO® 60 CONNECTOR SPECIFICATIONS |

Electrical		
Current Rating Amperes¹	SBO60	SBE80
Primary Power (6 AWG)	70	80
Powerpole® Auxiliary (12 AWG)	20	20
1x4 Auxiliary (12 AWG)	20	20
PPMX Auxiliary (20 AWG)	7 UL	5 CSA
Voltage Rating AC/DC	UL 1977	EN1175-1
Primary Power	600	150 ⁴
Powerpole® Auxiliary	600	150 ⁴
1x4 Auxiliary	200	
PPMX Auxiliary	300	
Dielectric Withstanding Voltage Primary Power		
Volts AC	2,200	
Avg. Mated Contact Resistance Milliohms¹		
1 1/4" of #6 AWG wire	0.200	
Hot Plug Current Rating Amperes - 250 cycles at 120V DC		
Power	60A	
Powerpole® Auxiliary	30A	
1x4 Auxiliary	5A	

Materials	
Housing	
SBO® and Powerpole® Plastic Resin	Polycarbonate
SBE® and 1x4 Auxiliary Housing	Polycarbonate / PBT blend
Contact Retention Spring	Stainless Steel
Housing Flammability Rating	
UL94	V-0
Power & Powerpole® Contact	Silver Plated Copper Alloy
1x4 Auxiliary Contacts	
Pin	Copper alloy, Au over Ni
Socket	BeCu, Au over Ni
Socket Body	Copper alloy, Sn bright over Ni
Retention Clip	Stainless Steel
PPMX Contacts	Gold Plated Copper Alloy
Contact Termination Methods	
Crimp ³	
Hand Solder	

Mechanical		
Wire Size Range	AWG	mm²
Power Contacts	16 to 6	1.3 to 13.3
Auxiliary Contacts	24 to 10	0.25 to 5.3
Max. Wire Insulation Diameter	in.	mm
Power Contacts	0.440	11.200
Powerpole® Auxiliary	0.175	4.450
1x4 Auxiliary	0.140	3.600
Operating Temperature²	°F	°C
SBO® and SBE® Housings	-4° to 221°	-20° to 105°
Mating Cycles No Load by Plating	Silver (Ag)	Gold (Au)
Power Contacts	10,000	
Powerpole® Auxiliary	10,000	
1x4 Auxiliary		10,000
PPMX Auxiliary		5,000
Avg. Mating / Unmating Force	Lbf.	N
Main Connector Housing	16	70
Per Powerpole®	5	22
Per Contact in 1x4 Auxiliary	0.7	3.0
Per PPMX Housing	4.50	20.00
Min. Contact / Spring Retention Force	Lbf.	N
Power Standard Housing	50	222
Powerpole® Housing	25	111
1x4 Auxiliary Housing	10	44.5
PPMX Housing	12	53

Protection	
Touch Safety Main Connector Housing	
IEC 60950	Pass
IEC 60529	IP20

¹ Based on: 105°C rated or better cable of the largest size, Properly calibrated APP® recommended tooling, and a 25°C ambient temperature. UL rating not to exceed the maximum operating temperature. CSA rating below a 30°C temperature rise.

² Limited by the thermal properties of the connector plastic housing.

³ Use APP® recommended tooling only. Alternate tools may adversely affect the performance of our connectors along with UL and CSA recognition.

⁴ Voltage capability of SBE® housings is identical to SBO®, but derated to meet EN1175-1 requirements.



| SBE®80 / SBO®60 CONNECTOR TEMPERATURE CHARTS |

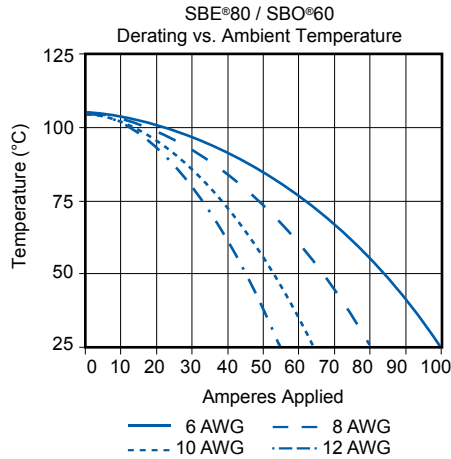
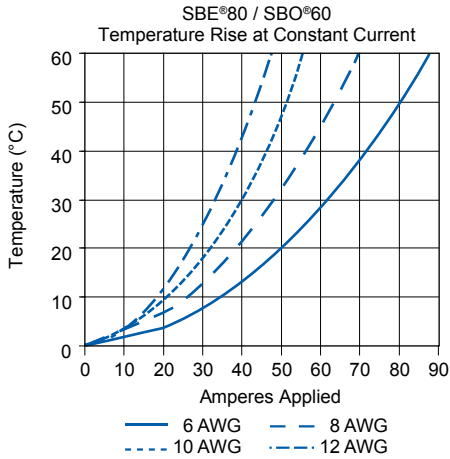

NOTE: Temperature rise charts are based on a 25°C ambient temperature.

| SBE®80 / SBO®60 Accessories |

Cable Clamps

Clamps are made out the same chemical resistant PBT material that is used in the SBE® housings. Clamp holds the cable between the clamp piece and the connector housing. Screws must be ordered separately for part numbers starting with "113".

Description	Part Numbers	
Minimum Quantity	100	25
Red Clamp and Hardware Kit	-	SBE80CLPRED or SBO60CLPRED
Red Clamp Only	113953P1	-
Screws (2 per clamp)	H1120P42 (Individual)	-

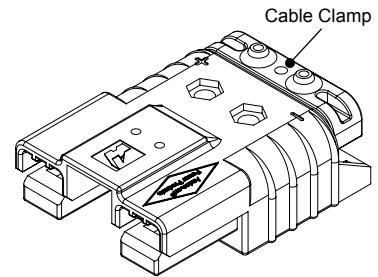

"T" Handle

Handles are made out the same chemical resistant PBT material that is used in the SBE® housings. (2) screws and (2) nuts are required to attach each handle.

Description	Part Numbers		
Minimum Quantity	500	100	25
Red Handle and Hardware Kit	-	-	SBE80HDLRED or SBO60HDLRED
Red Handle Only	113952P1	-	-
Hardware Bag	-	-	105G13
M5 x 35mm Screws	-	113715P4	-
M5 Nut	-	113716P3	-

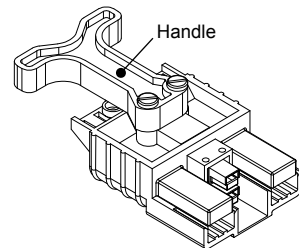

Powerpole® Auxiliary

Powerpole® auxiliary connectors are rated up to 30 amps 600 volts and can be used for auxiliary power, control or sensing. The auxiliary kit includes (1) each black and red Standard Powerpole® housing, (2) contacts, (2) zip cable straps, and (2) retaining pins.

Description	Part Numbers		
Minimum Quantity	200	100	25 ...
Powerpole® Auxiliary Kit	-	111822G1	6344
Black Powerpole® Housing	1327G6	-	-
Red Powerpole® Housing	1327	-	-
#16 to #12 Contact	1331	-	-
Retaining Pin	-	110G9	-

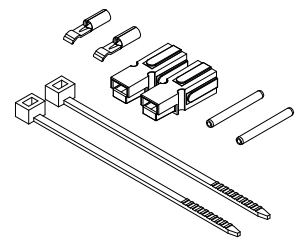

SECTION 3
SBE® 80 / SBO® 60

1x4 Auxiliary Connector

APP's unique 1x4 auxiliary connector allows up to 4 auxiliary circuits up to 20 amps 200 volts each in SBE®, SBO®, & SBX® housings. The genderless design holds two each of the gold plated pin & socket contacts. This innovation allows the very durable and cost effective design of SBE®, O, X connectors to substitute for DIN 43589-1 applications where 4 auxiliary contacts are required. Multiple pin lengths allow the further benefit of sequencing between circuits.

(2) Retaining pins are required to hold the auxiliary housing in place. Auxiliary Kits include (1) Auxiliary Housing, (2) Standard Length Pin Contacts, and (2) Socket Contacts, (2) Retaining Pins and (1) Retaining Clip.

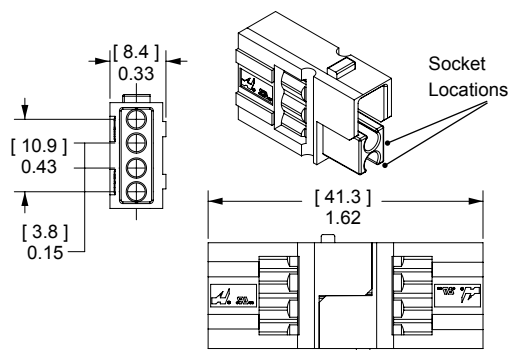

Description	AWG	mm ²	----- Part Numbers -----		
Minimum Quantity			1,000	250	25 ...
1x4 Auxiliary Kit	12	4	-	-	441G1
1x4 Auxiliary Kit	16 to 14	1.5 to 2.5	-	-	441G2
1x4 Auxiliary Kit	20 to 16	0.5 to 1.5	-	-	441G3
1x4 Auxiliary Housing	Contacts Sold Separately		3-5956P1	444G1	-

Pin Contacts for 1x4 Auxiliary Connector

Gold plated contacts are available in 4 lengths to allow sequencing of circuits.

Description	AWG	mm ²	----- Part Numbers -----	
Minimum Quantity			500	50
Standard Length 7.7mm	12	2.5	PM16P12S30	PM16P12S30-50
	16 to 14	1.0 to 1.5	PM16P1416S30	PM16P1416S30-50
	20 to 16	0.75 to 1.0	PM16P1620S30	PM16P1620S30-50
	24 to 20	0.50 to 0.75	PM16P2024S30	PM16P2024S30-50
Pre-Mate 9.3mm	12	2.5	PM16P12A30	PM16P12A30-50
	16 to 14	1.0 to 1.5	PM16P1416A30	PM16P1416A30-50
	20 to 16	0.75 to 1.0	PM16P1620A30	PM16P1620A30-50
	24 to 20	0.50 to 0.75	PM16P2024A30	PM16P2024A30-50
Pre-Mate 8.5mm	12	2.5	PM16P12B30	PM16P12B30-50
	16 to 14	1.0 to 1.5	PM16P1416B30	PM16P1416B30-50
	20 to 16	0.75 to 1.0	PM16P1620B30	PM16P1620B30-50
	24 to 20	0.50 to 0.75	PM16P2024B30	PM16P2024B30-50
Post-Mate 6.4mm	12	2.5	PM16P12C30	PM16P12C30-50
	16 to 14	1.0 to 1.5	PM16P1416C30	PM16P1416C30-50
	20 to 16	0.75 to 1.0	PM16P1620C30	PM16P1620C30-50
	24 to 20	0.50 to 0.75	PM16P2024C30	PM16P2024C30-50

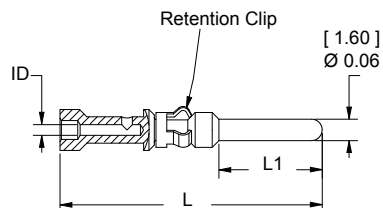

Auxiliary Pin Contact Lengths	- L -		- L1 -	
	in.	mm	in.	mm
Standard Length 7.7mm	0.77	19.6	0.30	7.7
Pre-Mate 9.3mm	0.83	21.2	0.37	9.3
Pre-mate 8.5mm	0.80	20.4	0.33	8.5
Post-Mate 6.6mm	0.72	18.3	0.25	6.4

Socket Contacts for 1x4 Auxiliary Connector

Selectively gold plated contacts offer low resistance and durability up to 10,000 mating cycles.

Description	AWG	mm ²	----- Part Numbers -----	
Minimum Quantity			500	50
Socket Contact	12	2.5	PM16S12S32	PM16S12S32-50
	16 to 14	1.0 to 1.5	PM16S1416S32	PM16S1416S32-50
	20 to 16	0.75 to 1.0	PM16S1620S32	PM16S1620S32-50
	24 to 20	0.50 to 0.75	PM16S2024S32	PM16S2024S32-50

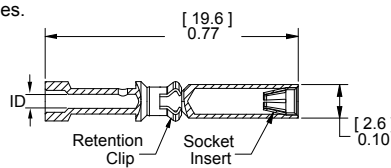

Auxiliary Socket Contacts Crimp Barrel ID		
Wire Gauge	in.	mm.
#24 / 20	0.04	1.1
#20 / 16	0.07	1.7
#16 / 14	0.08	2.1
#12	0.10	2.6

PPMX Auxiliary Connector

The PPMX auxiliary connector allows up to 8 auxiliary circuits to be used in the SBE®, SBO®, & SBX® housings. There are 4 auxiliary circuits per PPMX connector and two PPMX housings fit into the auxiliary port in the main connector housing. Rated up to 7 amps 300 volts per contact, the genderless design holds two each gold plated pin & socket contacts. This innovation allows the very durable and cost effective equipment design of SBE®, O, X connectors to be used for applications requiring up to 8 battery monitoring or vehicle communication circuits. (2) Retaining pins or (1) Retaining clip is required to hold the auxiliary housing in place.

Auxiliary Kits include (1) Auxiliary Housing, (2) Pin Contacts, and (2) Socket Contacts.

Description	AWG	mm ²	----- Part Numbers -----		
Minimum Quantity			1,000	100	25
PPMX Auxiliary Kit	24 to 20	0.50 to 0.25	-	4850G6	-
1x4 Auxiliary Housing	Contacts Sold Separately		4827G6-BK	-	4827G6

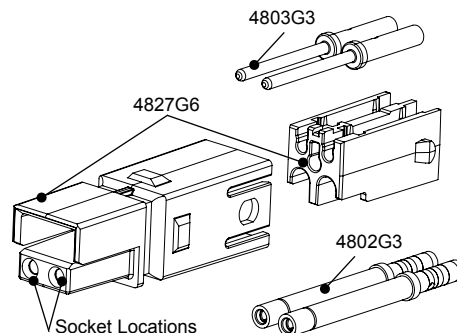

Pin & Socket Contacts for PPMX Auxiliary Connector

Gold plated contacts are ideal for signal or low power use with durability up to 5,000 mating cycles.

Description	AWG	mm ²	----- Part Numbers -----	
Minimum Quantity			2,000	50
Pin Contacts	24 to 20	0.50 to 0.25	4803G3-BK	4803G3
Socket Contacts	24 to 20	0.50 to 0.25	4802G3-BK	4802G3

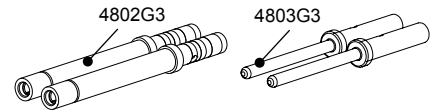

NOTE: Contacts sold individually, not sold as a set of two.

SBE® Air Tubes

Air tubes fit into SBE® housings to allow electrolyte circulation while charging the battery. Genderless tube design allows the same part to be used on both sides. (2) Retaining pins are required to hold the air tube in place. Retaining pins are included in Air Tube Kit.

Description	----- Part Numbers -----	
Minimum Quantity	500	25
Air Tube Kit, Black	-	6396G1
Air Tube Only	3-5798P1	-

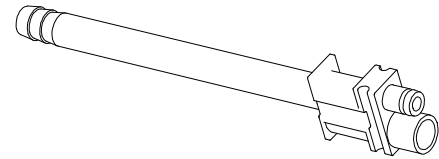

Retaining Pins

Retaining pins are used to hold accessories in the auxiliary port in SBE®, SBO®, & SBX® housings. Dimension "B" is +/- 0.015 in or 0.38 mm.

Description	--- Part Numbers ---		Dimensions			
	1,000	100	- A -		- B -	
			inches	mm	inches	mm
Minimum Quantity	1,000	100				
For SBE®80 & SBO®60	110G9-BK	110G9	0.093 / 0.103	2.36 / 2.62	1.000	38.100

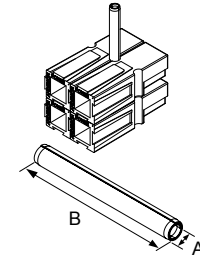

Zip Cable Straps

Zip cable straps are used to secure auxiliary wires to the side of the main power cables.

Description	-- Part Number --
Minimum Quantity	1,000
White	H1835P3

Use cable ties to secure auxiliary contact leads to one of the main cables.

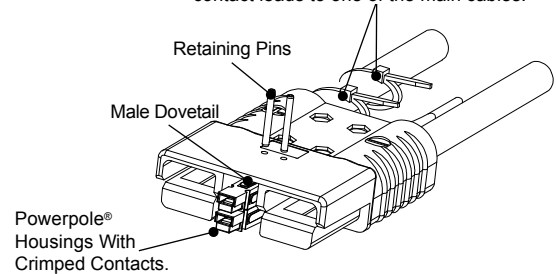

Reducing Bushings

Use with contact part number 1339G1 to allow a smaller wire to be used with the connector. Electrical capability is derated with smaller wire.

Contact Barrel Size	Wire Size	----- Part Numbers -----			Dimensions			
		3,000	1,000	100	- ID -		- Length -	
					inches	mm	Inches	mm
Minimum Quantity		3,000	1,000	100				
#6 AWG [13.3 mm ²]	#8 AWG [8.4 mm ²]	-	5912-BK	5912	0.18	4.57	0.45	11.43
#6 AWG [13.3 mm ²]	#12- 10 AWG [3.3- 5.3 mm ²]	5910-BK	-	5910	0.14	3.56	0.47	11.94
#6 AWG [13.3 mm ²]	#16- 14 AWG [1.3- 2.1 mm ²]	5913-BK	-	5913	0.09	2.29	0.47	11.94

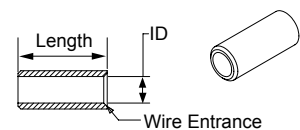

SBO® / SBE® / SBX®

- Tooling Information

Wire Size		Loose Piece Part Numbers	Loose Piece Contact Crimp Tool				
AWG	mm²	Contacts	Pneumatic Bench Tool	+ Die	+ Locator	Number of Crimps	or Hand Tool
SBE 320 / SBX 350							
300 MCM	152	6358	N/A	N/A	N/A	N/A	1368
4/0 AWG	107.2	6356	1387G2	1303G12	1304G28	Double	
3/0 AWG	85	6355					
2/0 AWG	67.4	6354					
N/A	95 mm²	1341G3	1387G2	1303G17	1304G35	Double	
N/A	70 mm²	1341G2		1303G12	1304G34		
N/A	50 mm²	1341G1		1303G8	1304G36		
SBE 160 / SBX 175							
1/0 AWG	53.5	6384G1	1387G2	1303G2	1304G2	Single	1368
#2	35 mm²	6384G2	1387G1	1388G3	1389G3		
			1387G2	1303G2	1304G2		
SBO 60 / SBE 80							
#4	25	1339G4	1387G1	1388G7	1389G9	Single	N/A
#6	16	1339G1		1388G6			1309G4
Powerpole 15/45 Auxiliary Contacts **							
#16 / 20	1.3 / .52	1332	1367G1	N/A	N/A	Single	1309G2 or 1309G8
#12 / 16	3.3 / 1.3	1331					
PowerMod 1x4 Auxiliary Contacts							
#12 / 24	2.5 / .25	All Crimp Pins	TP0001*	N/A	TL0001	Single	TM0001*
		All Crimp Sockets			TL0002		PM1000G1
PPMX Auxiliary Contacts							
#20 / 24	0.50 / 0.25	4803G3	TP0001*	N/A	TL0005	Single	TM0001* or
		4802G3					PM1000G1

* TP0001 and TM0001 tools require locators to properly position contacts.

** See Powerpole® family tooling chart for other Powerpole® contacts

NOTE: See website for the most current information.