



Distribution Channel Tooling Solutions

Hand Tools, Applicators and Terminator Presses



Distribution Channel Tooling Solutions

EUROPE / MIDDLE EAST

Austria

Phone: +43-1-90-560-0
gatd.at@te.com

Belarus - Russia - Ukraine

Phone: +7-910-452-3571
gatd.ru@te.com

Belgium - Netherlands - Luxemburg

Phone: +31-73-6246246
gatd.nl@te.com

Bulgaria - Hungary - Latvia

Lithuania - Poland - Romania
Phone: +48-601-522-935
gatd.pl@te.com

Czech - Slovakia

Phone: +420-541-162-150
gatd.cz@te.com

Denmark - Norway - Sweden

Phone: +46-8-507-250-00
gatd.se@te.com

Egypt - Ireland - United Kingdom

Phone: +44-1237-42-8657
gatd.gb@te.com

Finland and Estonia

Phone +358-9-5123-4224
gatd.se@te.com

France - Morocco - Tunisia

Phone: +33-1-34-20-87-70
gatd.fr@te.com

Germany - Slovenia - Turkey

Phone: +49-6251-133-1376
gatd.de@te.com

India - Middle East

Phone: +91-990-240-0577
gatd.in@te.com

Italy - Greece

Phone: +39-011-401-2272
gatd.it@te.com

Switzerland

Phone: +41-71-447-02 84
gatd.ch@te.com

Spain - Portugal

Phone: +34-93-291-03-96
gatd.sp@te.com

Product Information Center France

Phone: +33 134208943
Fax: +33 134208623
Pic.france@te.com

Product Information Center Germany

Phone: +49 (0) 6251 1331999
Fax: +49 (0) 6251 1331998
germany-pic@te.com

Product Information Center Netherlands

Phone: +31 736246999
Fax: +31 736246931
picbenelux@te.com

Product Information Center Poland

Phone: +48 224576704
Fax: +48 224576720
jmatasz@te.com

Product Information Center Spain

Phone: +34 932910330
Fax: +34 932017879
pic.spain@te.com

Tool Repair

Amperestr 7-11
63225 Langen Germany
Phone: +49 (0) 6103 709 1534
Fax: +49 (0) 6103 709 3076
ghertzog@te.com

AMERICAS

USA - Harrisburg, PA

Tooling Assistance Center
Phone: +1-800-722-1111

Tool Repair

627 N Grant St
Waynesboro, PA 17268
Phone: 717-765-3607
toolrepair@te.com

Pricing

Phone: 800-526-5142
or 717-986-5536

Field Engineering Services

Phone: 800-722-1111 or 717-986-3434

Canada

Phone: +1-908-612-6499
richard.grawehr@te.com

Brazil

Mauricio Oliveira
Phone: +55-11-2103-6062
maolivei@te.com

Mexico - Mexico City

Tooling Assistance Center
Phone: +1-717-986-3434

ASIA / PACIFIC

Product Information Center

Phone: +86-400-820-6015
china.prod.info@te.com

Shanghai

Phone: +86-21-24071588
Fax: 86-21-24071599

Beijing

Phone: +86-10-65693488
Fax: 86-10-65693208

Hong Kong

Phone: +852-27351628
Fax: +852-27350243

Australia

Phone: +61-2-95542612
Fax: +61-295543859

Japan

Phone: +44-900-5027
Fax: +44-900-5037

Korea

Phone: +82-2-3415-4636
Fax: +82-2-3486-6873

Singapore

Phone: +65-64164567
Fax: +65-64821012



Introduction to Tooling Solutions

Anyone can make a tool to crimp terminals onto a wire. But not everyone can manufacture a tool to crimp them properly.

Crimp termination of wires isn't easy. At least, doing it right isn't easy. We know. We started it. TE developed the technology of hand crimping over 50 years ago.

Why is this experience important to you? That's easy to answer. It's because along the way we've learned how to crimp correctly. We've learned how the forces of crimping can affect how a tool works, whether it meets specifications, and even whether it reaches its expected service life.

We've led the way, with tool frames and die sets that maintain their geometry and produce consistent crimps time after time after time. There are differences that aren't readily apparent: the materials, the manufacturing processes, the designs to diverse requirements for different applications. These are all part of what we've known and practiced for years.

Your business, your profitability depend on your product yields. When you can take advantage of our quality, selection, and tradition of innovation, why would you choose otherwise?

Crimping correctly saves you money and makes you money. Make crimp tooling from TE Connectivity your standard.

Choices at Any Production Level

We can offer you a performance continuity in tools, so you can have the same crimp functionality and quality whether you're developing, building, or servicing your product. In many cases you can use the same die set in tooling that spans the range from hand operation through battery, pneumatic, and even electrically powered tools.

Choices Driven by Your Design

Freedom. It's a good thing. Feel free to design your wiring harness to meet the required specifications. Then turn to TE for the tooling to do the crimping. We have the broadest selection of tooling and crimp dies available.

- **Low Volume: Prototype, Repair**
(Manual Hand Tools)



- **Intermediate: Small to Mid-Level Volumes**
(Power Hand Tools and Benchtop Tooling)



The Tools to Choose Your Tooling

Once you've identified the wire and the terminal you need to crimp, there's a convenient selection process on our web site, tooling.te.com. Just type the terminal part number in the search box at the upper right, click on search, and you're on your way.

If you don't find the tooling you need for your application, we usually can make it to your specification. This capability is made possible by our experience and our engineering and manufacturing resources.

Need More Information?

For information about tooling, call 888-777-5917 or 717-810-2080; email: toolingsales@te.com.

Catalog 5-1773465-1
Issued 09-2012

For drawings or technical data, contact your TE Connectivity sales engineer or call the Technical Support Center: 1-800-522-6752. Dimensions are in millimeters unless specified otherwise. Values in brackets are English equivalents unless specified otherwise. Specifications subject to change. Consult TE Connectivity for latest specifications.



Table of Contents

| | |
|-------------------------------------------------|-------|
| TE Application Tooling Key Contacts | 2 |
| Introduction to Tooling Solutions | 3 |
| Choices at any Production Level | 3 |
| Service and Certification | 5 |
| Match the Terminal to the Tooling | 5 |
| Contractor Tooling | |
| Wire & Cable Cutting Tools | 6 |
| Wire & Cable Stripping Tools (Standard) | 6 |
| Wire & Cable Stripping Tools (Premium) | 7 |
| All Purpose Tools | 7 |
| SL Series 110 Jack Termination Tool | 8 |
| Impact Tools | 9 |
| Pro-Installer Twisted Pair Tool Kit | 9 |
| Testers | 10 |
| Telecom Termination Tool | 10 |
| Modular Plug Tooling | 11 |
| JacKnack Tool | 12 |
| Customized Hand Tool Kit / Custom Tooling | 13 |
| Manual Tooling | |
| SDE (Standard Die Envelope) Tooling | 14 |
| PRO-CRIMPER Hand Tool | 15 |
| CERTI-CRIMP II Hand Tools | 16-17 |
| Flip Locator, LightKnack | 18-19 |
| Pistol Grip Tooling | 20-22 |
| Insertion/Extraction Tools | 23 |
| Power Tooling | |
| BT Series of Tooling | 24-30 |
| 626 Pneumatic System Power Unit | 31-32 |
| Hydraulic Tooling | 33-35 |
| BenchTop Tooling | |
| SDE Bench Terminator | 36 |
| AT-SC Crimping Machines | 37 |
| AT-55 Crimping Machines | 38 |
| AT-66 Crimping Machines | 39 |
| Ocean Applicators | 40 |
| AMP 3K/40, AMP 5K/40 Terminators | 41 |
| Crimp Quality Guidelines | 42 |
| Notes | 43 |



Service and Certification — Keys to Ongoing Crimp Performance

Once you've made the right choice in crimp tooling—TE quality tooling, certification and maintenance are the keys to keep your crimp tooling operating at peak performance. CERTI-CRIMP hand tools, pneumatic crimping heads and die sets, and hydraulic hand tools, all benefit from factory or on-site service.

- Recertification—promotes ongoing tooling maintenance in accordance with accepted industry and ISO 9001 standards. We recommend recertification to original production specifications every 6 months or 5,000 cycles.
- Visual Inspection—checks tool operation and looks for missing or damaged parts.
- Handle pressure check—measures pressure with calibrated machine or gauge; adjusts to match design specification.
- Quality Inspection Plan (QIP).



Periodic maintenance, including recalibration, helps ensure compliance with specifications.



Handle force, measured at the factory, is a critical component of precise, reliable crimping.

A Full Selection of Standard Tooling

TE offers a vast selection of standard tooling for the myriad of combinations of terminals and wires used in today's industry. To find the right tooling for your application, go to our web site tooling.te.com or contact your TE representative.

Matching the Terminal to the Tooling

SOLISTRAND



W-Crimp

Uninsulated DIAMOND GRIP



Crescent

PIDG



Crescent

STRATO-THERM



W-Crimp

PIDG STRATO-THERM

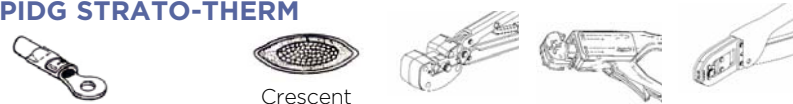

Crescent

Closed-end Splices



Confined Crescent

AMPLI-BOND



Confined Crescent

TERMINYL



Confined Crescent

AMPOWER



Crescent

Open Barrel



F-Crimp

Need More Information?

For information about tooling, call 888-777-5917 or 717-810-2080; email: toolsales@te.com.

Catalog 5-1773465-1
Issued 09-2012

For drawings or technical data, contact your TE Connectivity sales engineer or call the Technical Support Center: 1-800-522-6752. Dimensions are in millimeters unless specified otherwise. Values in brackets are English equivalents unless specified otherwise. Specifications subject to change. Consult TE Connectivity for latest specifications.



Distribution Channel Tooling Solutions

Wire & Cable Cutting Tools

Diagonal Cutter, 1116571-1

- Cut wires flush
- Spring loaded handles



Group Cutter, 1490498-1

- Ideal for cutting cable up to 2/0
- Also cuts coax cable up to RG-9



350 MCM Cable Cutter, 605744-1

- Steel handles
- Not for steel or ACSR cable



500 MCM Cable Cutter, 605742-1

- 21" overall length
- Fiberglass handles
- Not for steel or ACSR cable



Ratcheted Cable Cutter - Compact, 1490489-1

- Ratchet mechanism keeps handle force low
- Handles lock together for safety/storage
- Compact design for easy fit into tight places
- Quick release lever for easy take-up



Wire & Cable Stripping Tools — Standard

Economy Wire Stripper and Cutter, 1490491-1

- Strips 10-24 AWG
- Adjustable to any of 8 wire sizes



Rotary Cable Stripper, 606700-1

- Round cable tool can be used on single or multiple conductor cable up to 1.75" in diameter



Coax Stripper, 1490490-1

- 3 blades designed to strip RTG-6, 58, 59 cable in one step
- Replaceable blade cartridges



Automatic Wire Stripper, 734185-1

- Strips PVC, THHN, and THHW
- Adjustable wire stop
- Built-in cutter



JackKnack Telecomm Cable Prep Tool, 2119000-1

- Cable jacket stripper
- Cable filler shear
- JackKnack clamp
- Wire placement tool



CONTRACTOR TOOLING



Distribution Channel Tooling Solutions

Wire & Cable Stripping Tools — Premium

Cable Stripping Tool, 2-1579002-4, Spare Blade, 7-1579005-4

- Fine adjustability and repeatability provided by 9-position adjustment wheel
- Flexible: strips the sheath from most multi-core and fiber optic cables up to 11mm/0.43" in diameter
- Tough: manufactured from a new impact resistant nylon.
- Replaceable blade cassette available



Rotary Cable Stripping Tool, 2-1579002-5, Spare Blade, 7-1579005-5

- End strip (circular + straight + spiral)
- Window strip (circular + spiral + circular strip)
- 4,5-40 mm [0.18" - 1.57"] diameter
- Interchangeable cable guide hooks



Automatic Wire Stripper

- Easy change stripping blade cassettes
- Cuts and strips up to 10mm² / 34-8 AWG
- Strips PVC, THHN, THHW



| Tool | Description | Spare Blades |
|-------------|--------------------------------------------------------------|--------------|
| 2-1579002-1 | Parallel blade - std. ver. 0.02-10mm ² [34-8 AWG] | 7-1579005-1 |
| 2-1579002-2 | V-blade - version 0.02-4.0mm ² [28-12 AWG] | 7-1579005-2 |
| 2-1579002-3 | Form blade - version 16mm ² [6 AWG] | 7-1579005-3 |

All Purpose Tools

Cable Tie Gun, 734587-1

- For cable ties 2.2 - 4.8 mm
- Thickness up to 1.6 mm
- Automatic cut-off
- Adjustable tension setting



4-Way Indent Tool, 1490492-1

- Full ratchet cycle
- Contact locator
- Used for closed-barrel D-Sub contacts



BNC Connector Removal Tool, 1725122-1

F Connector Removal Tool, 1725123-1

- For security system use
- Remove BNC/F connectors in high density or hard-to-reach locations



Need More Information?

For information about tooling, call 888-777-5917 or 717-810-2080; email: toolingsales@te.com.

Catalog 5-1773465-1
Issued 09-2012

For drawings or technical data, contact your TE Connectivity sales engineer or call the Technical Support Center: 1-800-522-6752. Dimensions are in millimeters unless specified otherwise. Values in brackets are English equivalents unless specified otherwise. Specifications subject to change. Consult TE Connectivity for latest specifications.

CONTRACTOR TOOLING



SL Series 110 Jack Termination Tool

Tool Kit, 1725150-1

- Kit consists of the tool assembly (1725080-1) and lacing fixture (1673956-1)
- Termination tool for SL series jacks. Simplifies the termination process, especially for category 6 jacks (tool can be used for cat 3 - cat 5 jacks). Terminates and cuts all 8 conductors at once. Simplifies lacing process and speeds up terminations.
- Time savings creates cost savings. Ability to maintain consistent termination increases system performance and reduces trouble-shooting and re-terminations. Greatly simplifies category 6 terminations as pairs are easily placed in a lacing fixture, maintaining twisted pair integrity with one step termination and wire cutting.
- Built-in cable stripper (replacement blades are available, order PN 231674-2, MOQ of 20)



An Easy Step-By-Step Process

(View the video on-line at tooling.te.com/video/slseries_demo.wmv)



Cable Stripping

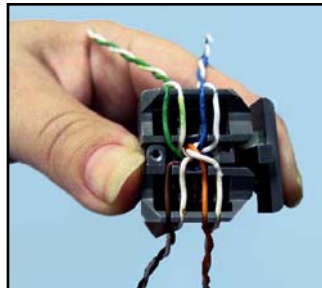

Wire Lacing

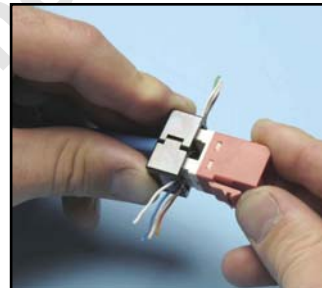

Inserting Connector

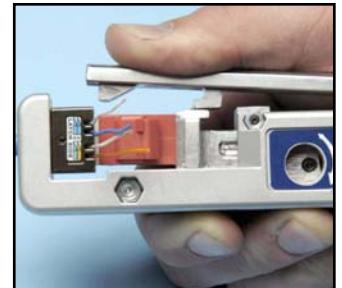

Terminate and Cut

610XC Four-Pair Punch Down Tool

- Punch down tool for 4-pair telecommunication distribution system. Developed for latest 110 style connectors to accommodate cat 6 performance levels.

PN 1725062-1 termination tool





Distribution Channel Tooling Solutions

Impact Tools

Impact Tool

- Non-slip rubber grips on handle
- Blade storage in rear of tool
- Adjustable hi/lo impact setting
- Accepts all twist and lock blades



Pro Impact Tool

- Hook and spudger
- Non-slip rubber grips on handle
- Blade storage in rear of tool
- Adjustable hi/lo impact setting
- Accepts all twist and lock blades



Non-Impact Tool

- Rubber palm grip
- Blade storage area inside of tool
- Accepts all twist and lock blades



| Replacement blades | |
|----------------------|-----------|
| Standard 110 blade | 1583609-1 |
| Standard 66 blade | 1583609-2 |
| Premium 110 blade | 1375309-1 |
| Premium 66/110 blade | 1375310-1 |
| Premium 66 blade | 1725872-1 |

| | Tool w/110 blade | Tool w/66/110 combination blade | Tool w/66 blade |
|------------|------------------|---------------------------------|-----------------|
| Impact | 1583608-1 | N/A | 1583608-3 |
| Pro impact | 1375308-1 | 1375308-4 | 1375308-3 |
| Non-impact | 1583236-1 | N/A | 1583236-3 |

Pro-Installer Twisted Pair Tool Kit, 1375307-1

Includes:

- Installer's knife
- Pro impact tool with extended-life blade (1375308-1)
- Shears
- Pouch



Need More Information?

For information about tooling, call 888-777-5917 or 717-810-2080; email: toolingsales@te.com.

Catalog 5-1773465-1
Issued 09-2012

For drawings or technical data, contact your TE Connectivity sales engineer or call the Technical Support Center: 1-800-522-6752. Dimensions are in millimeters unless specified otherwise. Values in brackets are English equivalents unless specified otherwise. Specifications subject to change. Consult TE Connectivity for latest specifications.

CONTRACTOR TOOLING



Distribution Channel Tooling Solutions

Testers

Tone Tracer, 1490533-1

- Permits wire and cable identification without direct metallic contact
- Ergonomic design
- Can be used with any tone generator
- Quick change tips available



Tone Generator, 1490531-1

- Three built-in tones
- Auto-off
- Separate talk battery for increased voltage and power for test sets
- Modular jack allows multiple cord sets to be used for different applications



Tone Tracer / Generator Kit, 1673606-1



4-Pair Tester, 1490530-1

- Test for opens, shorts, mis-wires, reversals, and split pairs
- Auto-on/auto-off
- Battery low indicator



Telecom Products Termination Tools

Tel-Splice Pliers, 790162-1

- Works with all Tel-splice part numbers
- Rounded nose won't snag on wires
- Wire cutter built into side
- Spring loaded handle
- Non-spring loaded version, 231839-1

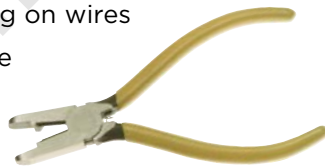

Tel-Splice Applicator Kit, 1583100-1 (includes 2- and 3-wire applicators)

- Single-handed operation
- Uses ultrasonically welded connector strips
- Automatically cuts connector from strip and feeds next connector
- Durable, lightweight design
- Part number 1490017-1 (2-wire applicator)
Part number 1490018-1 (3-wire applicator)



Butterfly Tool, 229378-1 (50 pos), 231880-1 (64 pos)

- Mass terminates and shears all wires in a single operation
- Portable, comes with carrying case
- Base can be bench mounted
- Used for CHAMP connectors



CONTRACTOR TOOLING



Distribution Channel Tooling Solutions

Category 6 Mod Plug Termination Tool

- Termination of category 6 modular plug style connectors, using PRO-CRIMPER hand tool system. Allows one step process to crimp all conductor and integrated shells.

PN 790163-1 termination tool w/die

PN 790163-2 die only

PN 354940-1 PRO-CRIMPER frame only



Professional Hand Tool - Fast Facts

- Low handle force
- Terminates both strain reliefs and inserts contacts in one motion
- Cuts, strips and terminates
- Ratchet control provides complete termination cycle
- Interchangeable die sets terminate all plugs except 10-position
- TE plugs are UL approved when terminated using this tool and the procedures outlined in IS 408-9767



ModPlug Single Terminator - Fast Facts

- Terminate up to 250 connectors/hr
- Interchangeable steel die sets terminate all TE plugs
- Compact, low cost pneumatically designed bench unit
- Independent adjustments for insertion, primary strain relief, and secondary strain relief depths
- Compact size — 31/2" x 83/4" x 51/8" tall, weighs only 13 lbs
- TE plugs are UL approved when terminated using this tool and the procedures outlined in IS 408-9919



ModPlug Dual Terminator - Fast Facts

- Pneumatically powered, foot pedal actuated
- Terminate two connectors at the same time
- Interchangeable die sets — easy changeover die sets for your particular product. Die sets have been designed to terminate all TE modular plug products
- Programmable tester — Check for shorts and opens as product is terminated. Program tester for individual positions or crossovers.
- Terminate up to 200 dual-ended cables/hr
- Steel die sets for long life
- Fully adjustable, primary strain relief, secondary strain relief and contact height
- Lightweight (36 lbs) design makes the press easy to move
- Compact size — 8" x 8" x 101/2" tall
- TE plugs are UL approved when terminated using this tool and the procedures outlined in CM 409-10010 and IS 408-9743



Need More Information?

For information about tooling, call 888-777-5917 or 717-810-2080; email: toolsales@te.com.

Catalog 5-1773465-1
Issued 09-2012

For drawings or technical data, contact your TE Connectivity sales engineer or call the Technical Support Center: 1-800-522-6752. Dimensions are in millimeters unless specified otherwise. Values in brackets are English equivalents unless specified otherwise. Specifications subject to change. Consult TE Connectivity for latest specifications.

CONTRACTOR TOOLING



The JackNack Telecommunications Cable Prep Tool



Untwisting wires sounds easy, doesn't it? It might sound easy to anyone who doesn't do a lot of it. The truth is that more time is dedicated to preparing a cable than to actually terminating it, and the longest part of the preparation process is untwisting wires. It is also one of the largest determinates to the ultimate speed, loss, and cross talk. So, proper cable preparation is an absolute necessity in order to obtain the desired performance.

Network installers and anyone who works in the telecommunications industry can quickly understand the amount of time required to prepare Category 5, 5e, or 6 cables for termination. First, the cable jacket must be stripped, then the rip cord and cable filler are trimmed and then comes the untwisting and lacing of the wires. Finally, the termination is made. In total, the process can take 3-4 minutes. Some people will claim it can be done in 1-2 minutes, but this is rarely a pace that can be maintained for an entire day's work. That is, until now.

The new JackNack tool from TE Connectivity provides a simple method to perform all the basic cable preparation functions including the time consuming untwisting of wires. When the tool is used in conjunction with the TE SL mod jack hand tool (PN 1725150-x), the results are a quick termination that is reliable and repeatable between operators, regardless of their experience level.



Strips cable jacket on cables with diameters ranging from 4.83-10.16mm [.190-.400 in].



Easily cuts the cable filler with the cable filler shear.

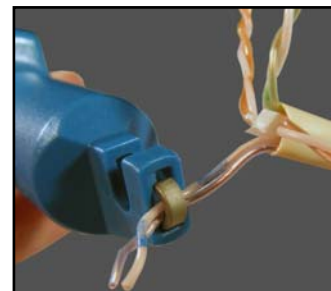

Untwists wire pairs with the innovative wire hook.

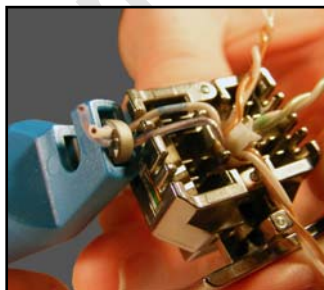

Easily places wire in SL mod jack lacing fixture.



Keep the JackNack tool hanging around while performing other tasks.

Fast Facts

- Cable Jacket Stripper
- Cable Filler Shear
- JackNack Clamp
- Wire Placement Tool
- Lightweight Design
- Ergonomic Design
- Portable
- Convenient

CONTRACTOR TOOLING



Distribution Channel Tooling Solutions

Customized Hand Tool Kits

In addition to providing standard kits, TE Connectivity is also able to provide custom kits for volume requirements containing only tools, or a combination of tools, dies and terminals tailored to your specific requirements.

The kit shown is an example designed specifically for the Automotive Industry. However, we can also provide kits for promotion and product support as well as application support and repair.

The flexibility in creation of these individual kits enables the customer to help both control and ensure quality.

Advantages

- Portability
- Customization
- Cost effectiveness
- OEM personalization
- Flexibility in the factory as well as in service and repair garages
- Consist of well-proven hand tools and dies as well as accessories matched to special applications
- A selection of sample terminals enables the technician to start work immediately



Custom Tooling – If What You Need Isn't in Our Catalog

While we offer die sets for thousands of terminal and wire combinations, in most cases our engineering capability allows us to create a custom die set to meet your specific requirements, with the same high quality as our standard products. You can take advantage of the same portability across platforms with the custom die sets as for a standard die set. And since we know that custom requirements often arise during the prototyping stage of your product development, a time when you can't afford to wait for normal engineering cycles for custom tooling, we've set up a special rapid response program.

Talk to us about your non-standard tooling requirement. Sometimes we can point you to existing solutions to get you on your way fast. If not, we'll find a way to get you back on your prototype or production path. Just fill out a custom order form, and give it to your local TE sales person.

| Part | Terminal Part # & Part | Steel Part | Application | Wire Size (AWG, mm) | Wire Size (mm) | Wire Crimp Height (mm) | Wire Crimp Length (mm) | Insulation Stripping Length (mm) | Insulation Stripping Type | Insulation Stripping Height (mm) | Insulation Stripping Width (mm) |
|------|------------------------|------------|-------------|---------------------|----------------|------------------------|------------------------|----------------------------------|---------------------------|----------------------------------|---------------------------------|
| 1 | | | | | | | | | | | |
| 2 | | | | | | | | | | | |
| 3 | | | | | | | | | | | |
| 4 | | | | | | | | | | | |
| 5 | | | | | | | | | | | |
| 6 | | | | | | | | | | | |
| 7 | | | | | | | | | | | |
| 8 | | | | | | | | | | | |
| 9 | | | | | | | | | | | |
| 10 | | | | | | | | | | | |
| 11 | | | | | | | | | | | |
| 12 | | | | | | | | | | | |
| 13 | | | | | | | | | | | |
| 14 | | | | | | | | | | | |
| 15 | | | | | | | | | | | |
| 16 | | | | | | | | | | | |
| 17 | | | | | | | | | | | |
| 18 | | | | | | | | | | | |
| 19 | | | | | | | | | | | |
| 20 | | | | | | | | | | | |
| 21 | | | | | | | | | | | |
| 22 | | | | | | | | | | | |
| 23 | | | | | | | | | | | |
| 24 | | | | | | | | | | | |
| 25 | | | | | | | | | | | |
| 26 | | | | | | | | | | | |
| 27 | | | | | | | | | | | |
| 28 | | | | | | | | | | | |
| 29 | | | | | | | | | | | |
| 30 | | | | | | | | | | | |
| 31 | | | | | | | | | | | |
| 32 | | | | | | | | | | | |
| 33 | | | | | | | | | | | |
| 34 | | | | | | | | | | | |
| 35 | | | | | | | | | | | |
| 36 | | | | | | | | | | | |
| 37 | | | | | | | | | | | |
| 38 | | | | | | | | | | | |
| 39 | | | | | | | | | | | |
| 40 | | | | | | | | | | | |
| 41 | | | | | | | | | | | |
| 42 | | | | | | | | | | | |
| 43 | | | | | | | | | | | |
| 44 | | | | | | | | | | | |
| 45 | | | | | | | | | | | |
| 46 | | | | | | | | | | | |
| 47 | | | | | | | | | | | |
| 48 | | | | | | | | | | | |
| 49 | | | | | | | | | | | |
| 50 | | | | | | | | | | | |
| 51 | | | | | | | | | | | |
| 52 | | | | | | | | | | | |
| 53 | | | | | | | | | | | |
| 54 | | | | | | | | | | | |
| 55 | | | | | | | | | | | |
| 56 | | | | | | | | | | | |
| 57 | | | | | | | | | | | |
| 58 | | | | | | | | | | | |
| 59 | | | | | | | | | | | |
| 60 | | | | | | | | | | | |
| 61 | | | | | | | | | | | |
| 62 | | | | | | | | | | | |
| 63 | | | | | | | | | | | |
| 64 | | | | | | | | | | | |
| 65 | | | | | | | | | | | |
| 66 | | | | | | | | | | | |
| 67 | | | | | | | | | | | |
| 68 | | | | | | | | | | | |
| 69 | | | | | | | | | | | |
| 70 | | | | | | | | | | | |
| 71 | | | | | | | | | | | |
| 72 | | | | | | | | | | | |
| 73 | | | | | | | | | | | |
| 74 | | | | | | | | | | | |
| 75 | | | | | | | | | | | |
| 76 | | | | | | | | | | | |
| 77 | | | | | | | | | | | |
| 78 | | | | | | | | | | | |
| 79 | | | | | | | | | | | |
| 80 | | | | | | | | | | | |
| 81 | | | | | | | | | | | |
| 82 | | | | | | | | | | | |
| 83 | | | | | | | | | | | |
| 84 | | | | | | | | | | | |
| 85 | | | | | | | | | | | |
| 86 | | | | | | | | | | | |
| 87 | | | | | | | | | | | |
| 88 | | | | | | | | | | | |
| 89 | | | | | | | | | | | |
| 90 | | | | | | | | | | | |
| 91 | | | | | | | | | | | |
| 92 | | | | | | | | | | | |
| 93 | | | | | | | | | | | |
| 94 | | | | | | | | | | | |
| 95 | | | | | | | | | | | |
| 96 | | | | | | | | | | | |
| 97 | | | | | | | | | | | |
| 98 | | | | | | | | | | | |
| 99 | | | | | | | | | | | |
| 100 | | | | | | | | | | | |

Need More Information?

For information about tooling, call 888-777-5917 or 717-810-2080; email: toolingsales@te.com.

Catalog 5-1773465-1
Issued 09-2012

For drawings or technical data, contact your TE Connectivity sales engineer or call the Technical Support Center: 1-800-522-6752. Dimensions are in millimeters unless specified otherwise. Values in brackets are English equivalents unless specified otherwise. Specifications subject to change. Consult TE Connectivity for latest specifications.

CONTRACTOR TOOLING



Standard Die Envelope (SDE) Crimp Tooling

Standard Die Envelope (SDE) is a new, flexible approach to crimp tooling, that allows use of the same dies on tooling across a range of application platforms. Dies are interchangeable in tools from portable hand tools—manual or battery-powered—to pneumatic hand tools and electric bench terminators. It's a family of tools that you can take from bench to production or into the field, without the need for dies fitted to each kind of tool. They're ideally suited for R & D, networking applications and on-site maintenance work.

You can be sure your dies will fit your long-term needs, because they are completely compatible with all tools in the SDE system. They move with you as your needs grow.

Featuring:

- User-adjustable ratchet control for a complete crimping cycle
- Emergency ratchet release
- Angled head, providing a comfortable hand and wrist position
- Over 100 interchangeable SDE die sets for crimping a broad range of connectors
- Able to handle multiple wire and terminal sizes in one die set

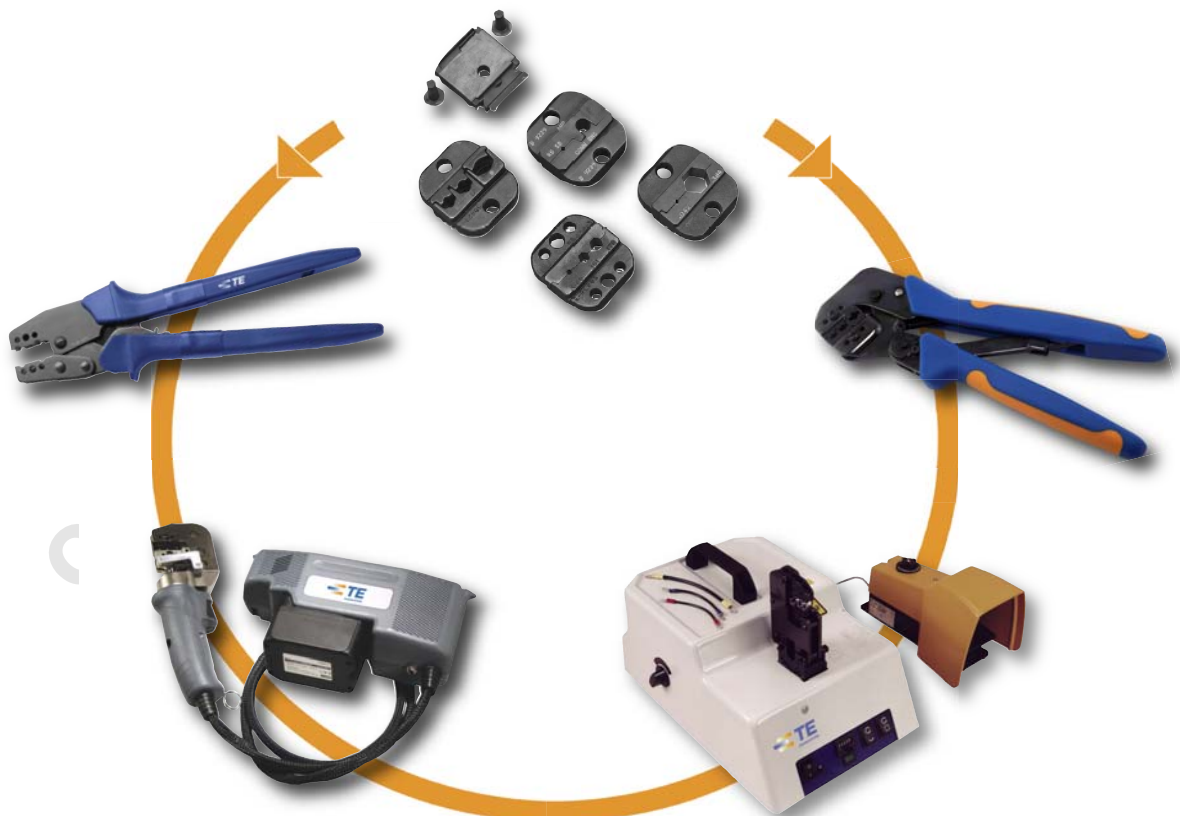

SDE (Standard Die Envelope) die sets can be interchanged from tool to tool as your crimping needs expand.

MANUAL TOOLING



Distribution Channel Tooling Solutions

SDE SA Hand Tool, Part No. 9-1478240-0 (frame only)

The unique geometry of this tool results in a comfortable, easy-to-use handle design that is unmatched in the market.

- Large crimp jaw arc, minimizing "roll" in open barrel applications
- Easy accessibility for space-constrained applications
- User-adjustable ratchet control and emergency ratchet release



SDE DA Hand Tool, Part No. 1213745-1 (frame only)

This tool is specifically designed for closed barrel SDE dies. It incorporates all the convenient operational features of the SDE family.

- Excellent mechanical advantage, enhancing user comfort
- Adjustable ratchet with emergency release



PRO-CRIMPER III Hand Tool, Part No. 354940-1 (frame only)

The PRO-CRIMPER III hand tool is ideally suited for R&D prototyping, networking applications, and commercial, industrial, and institutional maintenance work.

- Enhanced ergonomics, with a thin, comfortable handle profile
- Manufactured with precision stamping that permits close tolerance controls on critical parts, for better performance and repeatability
- Improved tool geometry for a longer life, stronger tool frame
- Fits industry's largest selection of crimp die options



PRO-CRIMPER Hand Tool Kits

TE specialty hand tools are available in convenient kits that contain the tooling, terminations, and spare parts you need for your crimping operations.

PRO-CRIMPER III Hand Tool PIDG and PLASTI-GRIP Terminal Kit, Part No. 55823-1

Includes hand tool (part no. 58433-3), 225 insulated ring and spade terminals in 12-10, 16-14 and 22-16 AWG [3.0-5.0, 1.3-2.0 and 0.3-1.3 mm²] wire sizes.

BNC Premises Wiring Kit, Part No. 58477-1

Includes hand tool (part no. 58433-1); plugs—5 RG-58, 10 RG-59/62, 5 RG-58 plenum and RG-59/62 plenum sizes; adapters—2 jack-to-jack and 2 "T".

PRO-CRIMPER III Hand Tool Repair Kit, Part No. 679221-1

Includes retaining rings, handle return spring, pawl spring, pivot pins, pawl pin, ratchet pawl, die pins, nut and die set screws.



SDE (Standard Die Envelope) die sets can be interchanged from tool to tool as your crimping needs expand.

Need More Information?

For information about tooling, call 888-777-5917 or 717-810-2080; email: toolingsales@te.com.

Catalog 5-1773465-1
Issued 09-2012

For drawings or technical data, contact your TE Connectivity sales engineer or call the Technical Support Center: 1-800-522-6752. Dimensions are in millimeters unless specified otherwise. Values in brackets are English equivalents unless specified otherwise. Specifications subject to change. Consult TE Connectivity for latest specifications.



Premium CERTI-CRIMP II Hand Tools

Fast Facts

- Designed to exacting specifications
- Ratchet control provides complete crimping cycle
- For most military, UL and CSA applications
- Manufactured using the highest quality materials
- Requires minimum skill
- Repairable
- Calibrated; recalibration recommended every 6 months or 5,000 cycles
- Many SAHT and DAHT crimping heads, and many die sets, can be adapted for use with the 626 pneumatic tool system (*Request catalog 124208*)
- Produced under a quality management system certified to ISO 9001. (*A copy of the certificate is available upon request.*)

CERTI-CRIMP hand tools are top-of-the-line, premium, hand-operated tools for crimping a broad array of terminals, contacts and special wiring devices available from TE Connectivity. They are designed to exacting specifications to produce consistent, high-quality terminations. A potential service life of over 50,000 cycles is possible, depending on operator care.

There are currently seven basic styles of CERTI-CRIMP hand tools. The choice depends on the product being applied and/or your preferred method of application. For example, open barrel contacts typically require straight-action die movement to minimize possible rotation during crimping. Or, if your application requires crimping different sizes of terminals, you may prefer using a single tool with a combination of crimping nests, rather than two or three separate tools.

Other options include insulation crimp adjustment for different insulation thicknesses, a locator for properly positioning and supporting the terminal or contact in the tool, a wire stop, and color-coding and/or wire size information on the head of the tool or on the handles.

All CERTI-CRIMP hand tools feature the reliable ratchet control. The ratchet will not release until the handles are fully closed and the dies bottomed. This helps eliminate partial crimps.

CERTI-CRIMP hand tools are well suited for low production runs, prototype work, and repairs—almost any application requiring consistent, highly-reliable terminations. CERTI-CRIMP hand tools are designed to meet all feature requirements listed on applicable TE application specifications. (Check appropriate product catalogs for qualification to military specifications, UL recognition and CSA certification.)





Flip Locator for Premium CERTI-CRIMP II Hand Tools

Fast Facts

- Highly visible, easier to load terminals
- “New” spring loaded retention feature
- Configured for CERTI-CRIMP II heads
- Available with short and long handle tools
- Accurately locates the terminal for a more consistent crimp termination

TE Connectivity introduces a flip locator hand tool feature designed to provide the ultimate in terminal placement accuracy, increased efficiency and ease of use.

Function

The new wire size trends have translated into new operator, tooling, and application challenges. Small terminal handling is a particular challenge as terminals continue to miniaturize. In fact, TE Connectivity is working on a terminal that has a crimp width of only 0.015” (0.38 mm). Miniaturization can create various issues in handling the terminal and locating it properly into a hand tool’s die set.

To help with the problem, TE is releasing its new “flip locator” on selected premium CERTI-CRIMP II straight action hand tools. This TE flip locator system allows the operator to “flip” the locator approx 150 degrees, which provides exact placement of small terminals. After loading, the locator is “flipped” back into position and the terminal is properly located automatically. Now, with the terminal held in place, the operator can concentrate on proper wire placement and complete the termination process.

Another Hand Tool Solution from TE Connectivity.



Step-by-Step



Need More Information?

For information about tooling, call 888-777-5917 or 717-810-2080; email: toolingsales@te.com.

Catalog 5-1773465-1
Issued 09-2012

For drawings or technical data, contact your TE Connectivity sales engineer or call the Technical Support Center: 1-800-522-6752. Dimensions are in millimeters unless specified otherwise. Values in brackets are English equivalents unless specified otherwise. Specifications subject to change. Consult TE Connectivity for latest specifications.



CERTI-CRIMP Tooling Options

Double Action Hand Tool (DAHT)

- Dies travel in arc-like path
- Locator on tools for FASTON, MATE-N-LOK, PIDG and PLASTI-GRIP terminals
- Insulation adjustment on tools for FASTON, MATE-N-LOK, PIDG and PLASTI-GRIP terminals
- Approx. weight 1.2 lb [0.54 kg]



T-HEAD Hand Tool

- Dies close in a straight line
- Locator
- Quick take-up on handle for holding terminal or splice in place
- Adjust insulation crimp with a 4-position screw
- Color-coded
- Approx. weight 1.3 lb [0.59 kg]



TETRA-CRIMP Hand Tool Part No. 59824-1

- Dies travel in arc-like path
- Multiple color-coded crimping cavities
- Terminal locator and wire stop
- Ratchet control release
- Approx. weight 1.4 lb [0.64 kg]



Heavy Head Hand Tool (HHHT)

- Terminates most large coaxial cable and heavy-gage wire
- Dies close in a straight line
- Locator and wire stop when applicable
- Insulation adjustment on tools for AMPLI-BOND, PIDG and PLASTI-GRIP terminals
- Approx. weight 2.1 lb [0.95 kg]



Platform Die Hand Tool Part No. 58078-3

- Same frame configuration as TETRA-CRIMP hand tool
- Dies are interchangeable
- Adjustable terminal locator
- Approx. weight 1.4 lb [0.64 kg]



"C" Head Straight Action Hand Tool Part No. 69710-1

- Dies close in a straight line
- Dies are interchangeable
- Locators and other applicable features included with dies
- Approx. weight 1.9 lb [0.86 kg]



Straight Action Hand Tool (SAHT)

- Dies close in a straight line
- Contact locator and support
- Wire stop
- Insulation crimp adjustment (4 positions)
- Ejects crimped contact
- Approx. weight 1.3 lb [0.59 kg]





LightKnack Accessory for CERTI-CRIMP II Hand Tools

Fast Facts

- High-intensity, long-life LED bulb
- Eases the termination process
- Magnetic for a secure placement while maintaining flexibility
- Applicable for any metallic tool surface
- Available separately in packs of 3
- Up to 8 hours of battery life
- Replaceable CR12166 batteries

This portable, magnetic LightKnack accessory is designed to provide light anywhere you need it. Attach it to hand tools, use it in engine compartments, or behind a computer...the possibilities are endless!

How it works

Simply place the light on any ferromagnetic surface, point the light to where light is needed and turn on the switch. The high-intensity LED provides hours of bright light onto the work surface. The magnets provide hands-free use. The LightKnack runs on two small CR1216 batteries (included) that are available in many retail stores.

Another Solution from TE Connectivity.

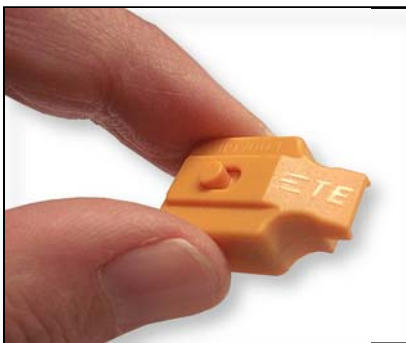

MANUAL TOOLING

Need More Information?

For information about tooling, call 888-777-5917 or 717-810-2080; email: toolingsales@te.com.

Catalog 5-1773465-1
Issued 09-2012

For drawings or technical data, contact your TE Connectivity sales engineer or call the Technical Support Center: 1-800-522-6752. Dimensions are in millimeters unless specified otherwise. Values in brackets are English equivalents unless specified otherwise. Specifications subject to change. Consult TE Connectivity for latest specifications.



Pistol Grip Hand Tool System for IDCs

Fast Facts

- Terminates 28-16 AWG [0.08-1.2 mm²] wires
- No wire stripping needed for lower applied cost
- Pistol grip (manual or air) or bench mount (air or electric) power units
- Lightweight; easy to operate
- For prototypes or low- to medium-volume production
- Small size; useful in confined work areas
- Interchangeable terminating heads:
 - Pin and socket connectors (AMPLIMITE HDE and MATE-N-LOK)
 - Printed circuit board connectors (AMPMODU, MT-6/MT-7, 2 mm CT, and MTA)
 - Category 5 connectors (CHAMP)
 - Card edge connectors
- Most terminating heads can be rotated to any angle
- Adjustment available for proper wire insertion depth
- Most terminating heads automatically index connectors to the next contact position, or connectors can be advanced by hand to any position
- Anti-backup pawl prevents connectors from moving in the wrong direction
- Produced under a quality management system certified to ISO 9001

The pistol grip hand tool system uses interchangeable terminating heads to apply a broad range of TE IDC products. The basic tool requires a pistol grip handle assembly and a terminating head; power-assist and bench mount versions are available to suit your specific needs.

This system is well suited for low- to medium-volume production. Simply order the standard or extended-wear terminating heads based on your anticipated needs. Since most terminating heads can be rotated to any angle, the operator can also tackle more difficult terminations in confined work areas.

The terminating force is provided by a manual-, pneumatic- or electric-powered assembly. The wire inserter, inside each head, pushes the end of an unstripped wire into the insulation displacement contact. Then, most tools automatically index the connector to the next contact. The tools offer precise termination depth control.

For maximum productivity, a bench mount power unit (pneumatic or electric) is recommended. Optional feed tracks can increase application rates further. Actual production rate depends on the IDC product, discrete wire or ribbon cable, and operator dexterity.

Technical Documents

Customer Manual

409-5746—
Electric Power Unit

Instruction Sheets

408-6790—
Pistol Grip Manual Handle Assembly
408-6789—
Pistol Grip Pneumatic Handle Assembly
408-9393—
Bench Mount Pneumatic Power Unit





Pistol Grip Power Units



Pistol Grip Manual Handle Assembly

Part Number 58074-1

A basic hand tool requires a handle assembly and a terminating head, ordered separately.

- Lightweight, easy to use
- Ratchet control will not release cam trigger until it is fully bottomed
- Ratchet release
- “U”-shaped key slides into handle to hold interchangeable heads securely
- Material (handle) — molded nylon



Pistol Grip Pneumatic Handle Assembly

Part Number 58075-1

- Lightweight
- Power assist for less operator effort
- Push-button trigger actuated
- Quiet — 78 dB max.
- “U”-shaped key slides into handle to secure interchangeable heads
- Material (handle) — molded nylon



Bench Mount Pneumatic Power Unit

Part number 58338-1

Assembly consists of a bench mount with attached pneumatic power unit, a foot switch, and two air lines which connect the switch to the power unit and the air source to the switch. Mounting hardware is not included.

- Mounting bracket allows interchangeable heads to be pointed up or down
- Power assist for greater productivity
- Actuated by foot switch
- Key retains heads, or heads and feed tracks

Notes: 1. Interchangeable terminating heads must be ordered separately, see page 4.
2. Loose-piece or tape (reel) feed track accessories are available, see page 3.

Need More Information?

For information about tooling, call 888-777-5917 or 717-810-2080; email: toolingsales@te.com.



Bench Mount Power Units (continued)



Bench Mount Electric Power Unit

Part number 931800-1

- Portable, compact
- Low noise
- Semi-automatic operation
- Foot pedal actuated
- Feed track options

Notes:

1. Interchangeable terminating heads must be ordered separately, see page 4.
2. Loose-piece, tube or tape (reel) feed track accessories are available, see below.

Accessories for Bench Mount Power Units

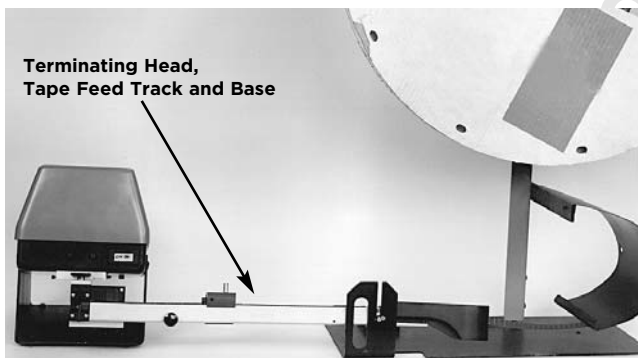

Loose-Piece, Tube or Tape Feed Track Options

- No special setup required
- Connectors load easily into feed track
- Simple, spring-loaded pusher feeds connectors into head
- Power units shown for size reference only

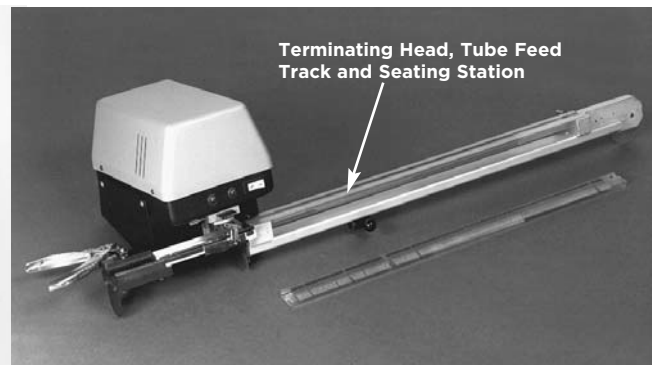
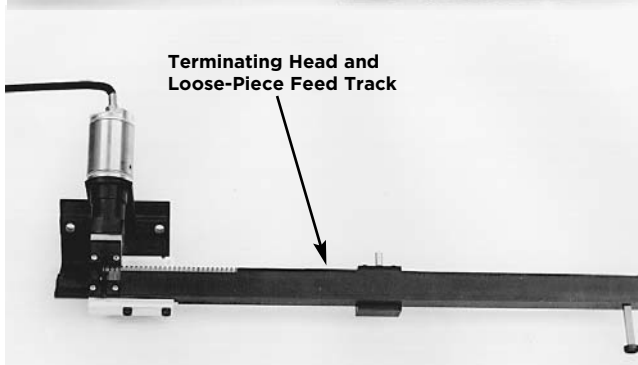

| TE IDC Product | Terminating Head and Loose-Piece Feed Track | Terminating Head, Tape Feed Track and Base | Terminating Head, Tube Feed Track, and Seating Station for Electric Power Unit Only |
|----------------------------|-----------------------------------------------------|--------------------------------------------------------------|-------------------------------------------------------------------------------------|
| AMPMODU MTE Connectors | — | — | 856675-1 (Instruction Sheet 408-9759) |
| MTA Closed-End Receptacles | MTA-100 933567-1 (Instruction Sheet 408-9435) | 853546-1 and 853542-1 (Base) (Instruction Sheet 408-9636) | |
| | MTA-156 933568-1 (Instruction Sheet 408-9466) | 853547-1 and 853542-1 (Base) (Instruction Sheet 408-9637) | — |



Insertion/Extraction Tools

Insertion/extraction tools are used for inserting discrete terminals into connector housings or removing them, without causing damage to either the terminals or housings.

Our new standard design features a comfortable handle and snap-in/out protective cover that allows users to stow the business end of the tool to help protect from inadvertent personal injury when the tools are not in use.

Many different design types currently exist for our vast terminal product range, which we continue to convert. If you would like the tool you use converted to the new design, want a custom kit or tools in this design for other manufacturers' products - contact us, and where volumes permit, we will be pleased to provide you with a quotation for your requirement.



*For universal handle (with adjustable strap) with short tip holder (1.87 [47.5]), specify "-1" suffix; with long tip holder (5.87 [149]), specify "-2" suffix.

Requires installation tip:

Part no. 465468-1 (\leq .185 [4.7] insul. dia. and/or crimp width) or **part no. 465488-1** ($>$.185 [4.7] insul. dia. and/or crimp width).



Universal Handle
Part No. 465629-□*



Insertion/Extraction Tool
Part No. 91285-1



Extraction Tool
Part No. 305183



Extraction Tool
Part No. 318851-1



Extraction Tool
Part No. 455822-2



Extraction Tool
Part No. 465644-1



Extraction/Lance Reset Tool
Part No. 843996-3

Need More Information?

For information about tooling, call 888-777-5917 or 717-810-2080; email: toolsales@te.com.

Catalog 5-1773465-1
Issued 09-2012

For drawings or technical data, contact your TE Connectivity sales engineer or call the Technical Support Center: 1-800-522-6752. Dimensions are in millimeters unless specified otherwise. Values in brackets are English equivalents unless specified otherwise. Specifications subject to change. Consult TE Connectivity for latest specifications.



BT Series (BT 1900 and BT 3500) Kits

Fast Facts

More than a ton of power in your hand. (BT 3500)

- Highly Portable
- Lightweight
- Ergonomic
- Compatible with SDE dies and numerous heads
 - 9 different heads/adapters
 - 7 for BT 3500 Tool
 - 2 for BT 1900 Tool
- New 'quick take-up' feature
- Approximately 250 crimps per charge
- Generates up to 3500 lbs of crimp force.

The BT series of battery-hydraulic hand tool kits is designed to provide the ultimate in flexibility, modularity, and powered efficiency in a lightweight, ergonomic, and powerful crimp unit powered by a superior Lithium-ion battery.

The BT series flexibility begins with the availability of 2 different power units (BT 1900 and BT 3500), 9 different heads and adapters, and various user options. The kit comes with a shoulder strap that can be used on the kit's case or directly on either power unit (BT 1900 or BT 3500). An optional belt allows the unit to be worn on the user's waist, and an optional 4-point harness can be incorporated for added stability. If the unit will remain stationary, an optional bench mount holder is available.

By using the BT carrying case, multiple storage pockets permit a convenient location for terminals, wire cutters, wire strippers, spare batteries, the battery charger, and any other items an operator might require.

The BT kit's modularity follows the TE Connectivity powered hand tool lineage, through compatibility with a multitude of dies and heads.



SDE (Standard Die Envelope) die sets can be interchanged from tool to tool as your crimping needs expand.



Distribution Channel Tooling Solutions

BT 3500 Battery-Hydraulic Hand Tool

More than a ton of portable power in your hand

The BT 3500 battery-hydraulic hand tool provides the ultimate in flexibility, modularity, and powered efficiency in a powerful crimp unit powered by a superior Lithium-ion battery.

- Highly portable, lightweight
- Ergonomic
- Approx. 250 crimps per charge
- New 'quick take-up' feature
- Compatible with CERTI-CRIMP II heads, SDE closed heads and SDE C-heads
- Generates up to 3500 lbs of crimp force



Request catalog 1773381-5 for more information.



- Red pressure release button
- Knurled reset tool is specially threaded and removable

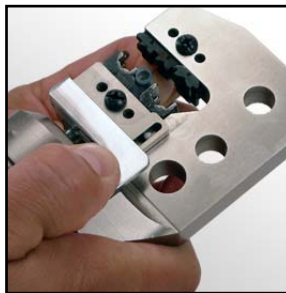

BT 3500 with the "quick take-up" terminal retention feature

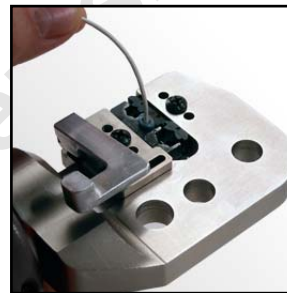

Options

4-point Harness
(for use with Padded Belt)



Shoulder Strap



Belt



Shoulder Strap with Case



SDE (Standard Die Envelope) die sets can be interchanged from tool to tool as your crimping needs expand.

Need More Information?

For information about tooling, call 888-777-5917 or 717-810-2080; email: toolingsales@te.com.

Catalog 5-1773465-1
Issued 09-2012

For drawings or technical data, contact your TE Connectivity sales engineer or call the Technical Support Center: 1-800-522-6752. Dimensions are in millimeters unless specified otherwise. Values in brackets are English equivalents unless specified otherwise. Specifications subject to change. Consult TE Connectivity for latest specifications.

POWER TOOLING



BT 3500 Kit

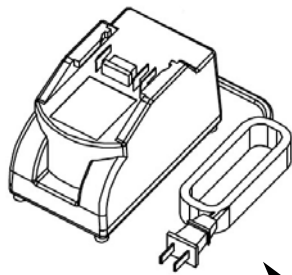

Battery Charger
2063870-1, 110V US
2063870-2, 220V, EU
2063870-3, 220V UK
2063870-4, 110V Japan
2063870-5, 220V Aus/China
(1 included with kit)

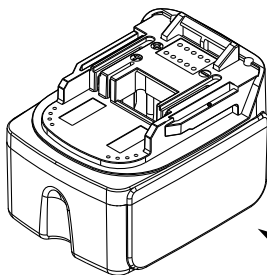

Rechargeable Li-ion Battery,
2031440-1
(included in kit)

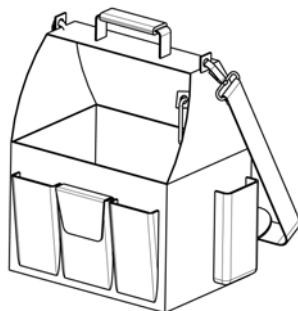

**Carrying Case with
Shoulder Strap 2031489-1**
(Included with Kit)

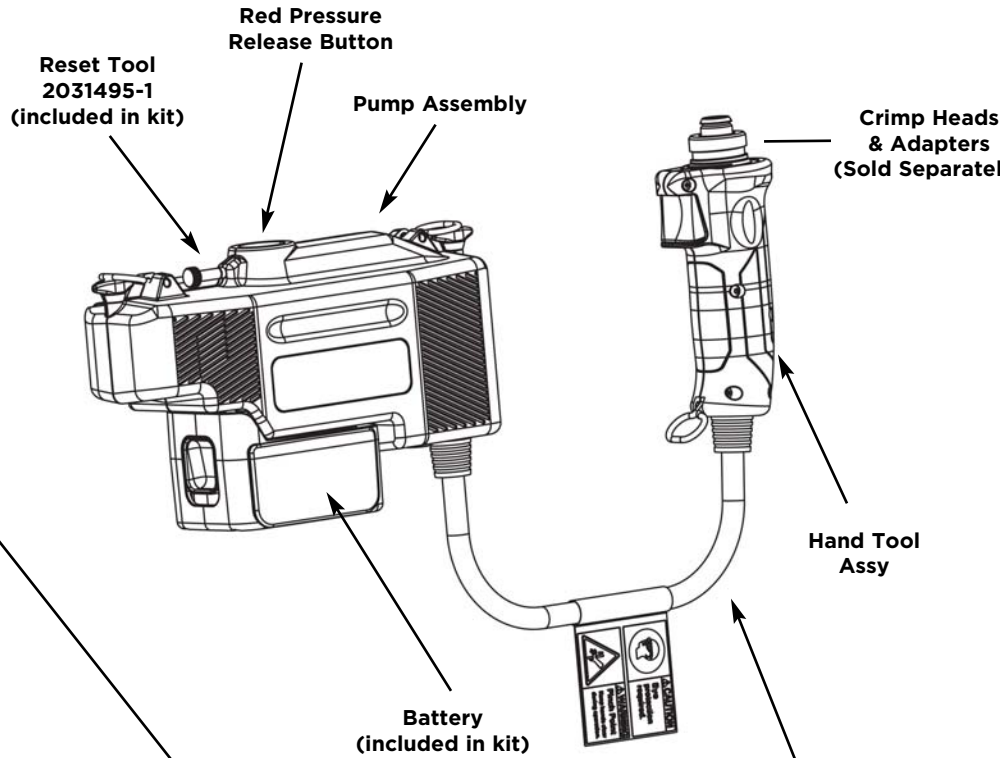

BT 3500 Kit
2031400-1, 110V, US
1-2031400-1, 110V, Japan
2-2031400-1, 220V, Europe
3-2031400-1, 220V, UK
4-2031400-1, 220V, China/Aus

POWER TOOLING



Distribution Channel Tooling Solutions

BT 3500 Compatible Heads

(All heads, dies and adapters sold separately)



SDE C Head, 2031450-1
For use with shoulder-type SDE Dies



SDE Shoulder-type Die
Numerous styles & P/Ns available — see catalog 1773379-1.



Double Action Adapter, 2119483-1



Double Action Head
Numerous styles & P/Ns available — see catalog 65780.



SDE Closed Head, 2031460-1
For use with pin and shoulder-type SDE Dies



SDE Shoulder-type Die
Numerous styles & P/Ns available — see catalog 1773379-1.



Large Die C-Head, 2119810-1
For use with large C-Head Dies



Large C-Head Die
Numerous styles & P/Ns available — see catalog 65780.



CERTI-CRIMP II SA Head
Numerous styles & P/Ns available — see catalog 65780.



CERTI-CRIMP II SA/T-HEAD Adapter, 2031480-1



T-HEAD, 2161000-1
(specific to BT 3500)



Heavy Head Adapter, 2119840-1



Heavy Head
Numerous styles & P/Ns available — see catalog 65780.

POWER TOOLING

Need More Information?

For information about tooling, call 888-777-5917 or 717-810-2080; email: toolingsales@te.com.

Catalog 5-1773465-1
Issued 09-2012

For drawings or technical data, contact your TE Connectivity sales engineer or call the Technical Support Center: 1-800-522-6752. Dimensions are in millimeters unless specified otherwise. Values in brackets are English equivalents unless specified otherwise. Specifications subject to change. Consult TE Connectivity for latest specifications.



BT 1900 Kit

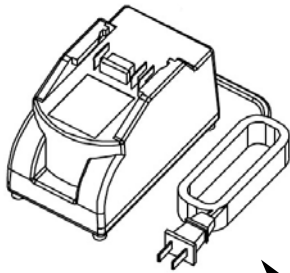

Battery Charger
2063870-1, 110V US
2063870-2, 220V, EU
2063870-3, 220V UK
2063870-4, 110V Japan
2063870-5, 220V Aus/China
(1 included with kit)

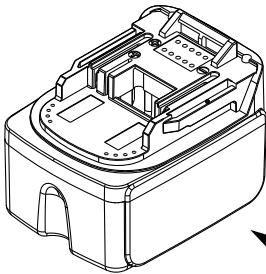

Rechargeable Li-ion Battery,
2031440-1
(included in kit)

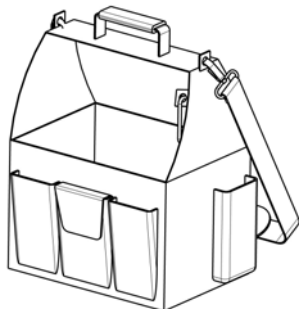

**Carrying Case with
Shoulder Strap 2031489-1**
(Included with Kit)

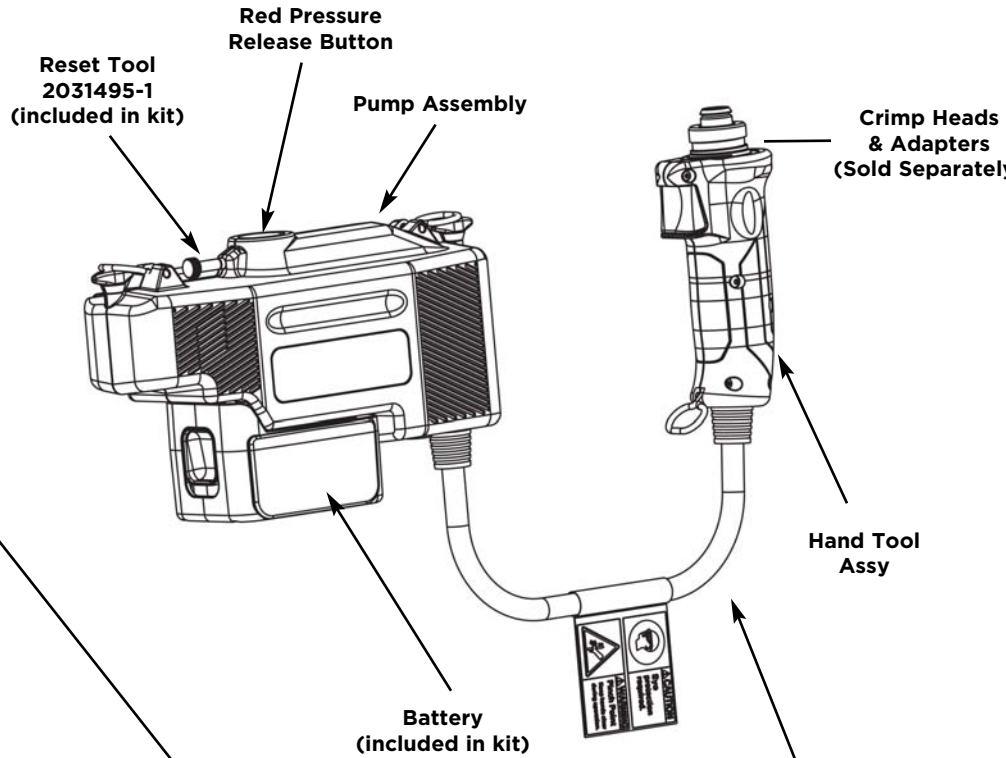

BT 1900 Kit
2031400-5, 110V, US
1-2031400-5, 110V, Japan
2-2031400-5 220V, Europe
3-2031400-5, 220V, UK
4-2031400-5, 220V, China/Aus

POWER TOOLING



Distribution Channel Tooling Solutions

BT 1900 Compatible Heads

(Sold separately)



DMC AFE8-R Head, 2161658-1
Numerous styles & P/Ns available.



DMC AFME8-R Head, 2161659-1
Numerous styles & P/Ns available.

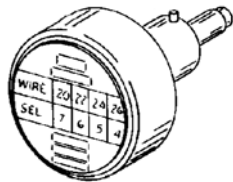

Positioner

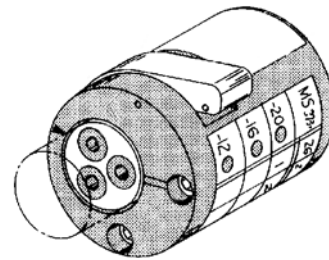

Turret Head

| Description | Part Number | Military Spec |
|---------------------------|-------------|------------------|
| Positioner or Turret Head | 601966-2 | MIL-C-22520/2-02 |
| | 601966-4 | MIL-C-22520/2-06 |
| | 601966-5 | MIL-C-22520/2-08 |
| | 601966-6 | MIL-C-22520/2-09 |
| | 601966-8 | MIL-C-22520/2-23 |
| | 601967-2 | MIL-C-22520/1-02 |
| | 1-601966-2 | MIL-C-22520/1-11 |

*One charger with appropriate electrical specifications is included with each kit.

DMC is a trademark.

Need More Information?

For information about tooling, call 888-777-5917 or 717-810-2080; email: toolingsales@te.com.

Catalog 5-1773465-1
Issued 09-2012

For drawings or technical data, contact your TE Connectivity sales engineer or call the Technical Support Center: 1-800-522-6752. Dimensions are in millimeters unless specified otherwise. Values in brackets are English equivalents unless specified otherwise. Specifications subject to change. Consult TE Connectivity for latest specifications.



Options for both the BT 1900 and BT 3500

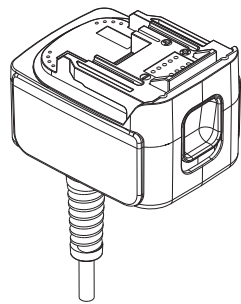

AC Adapter (optional)
2063874-1, 110V US
2063874-2, 220V, EU
2063874-3, 220V UK
2063874-4, 110V Japan
2063874-5, 220V Aus/China

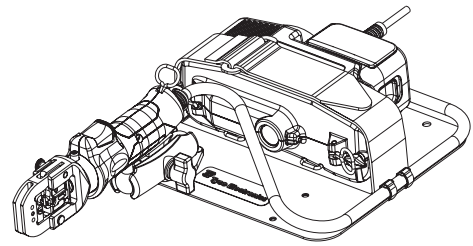

Optional Bench Mount Holder, 2031403-1
(Shown with BT 3500 tool and AC Adapter.
The BT 3500 and AC Adapter are not included with the bench mount holder.)

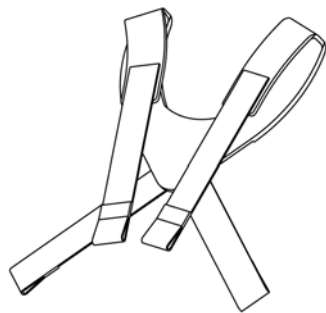

4-Point Harness for use with Padded Belt (optional)
2063864-1

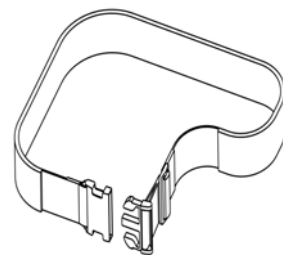

Padded Belt (optional)
2063863-1



626 Pneumatic System Power Unit

Fast Facts

Effortless crimping for a broad range of terminals, either bench-mounted or hand-held for working in cramped quarters.

- Lightweight; eliminates physical force required by hand tools
- Hand- or foot-switch operation
- Works with existing TE-compatible crimp heads and die sets
- Ratchet control option provides complete crimp cycle, eliminating partial crimps
- Rotating head reaches difficult termination locations
- Engineered and manufactured using processes independently certified to internationally recognized quality standards ISO-9001:2000 and telecommunications industry standard TL 9000

Maximize your productivity while minimizing your effort—replace your manual hand tools with the 626 pneumatic tool system. Terminating wires from 26–6 AWG [0.12–13.0 mm²] has never been easier. And you can continue to use most, if not all, of your existing TE-compatible crimp heads and die sets.

Stop Working So Hard

The powerful 626 pneumatic tool system makes crimping as easy as pressing a hand or foot switch. Besides reducing operator fatigue, this means you don't have to design your production bench around your tool.

Include the fully adjustable bench mount assembly with the foot switch, and you're completely free to concentrate on aligning the wire and terminal. Now you can crimp faster and with fewer mistakes.

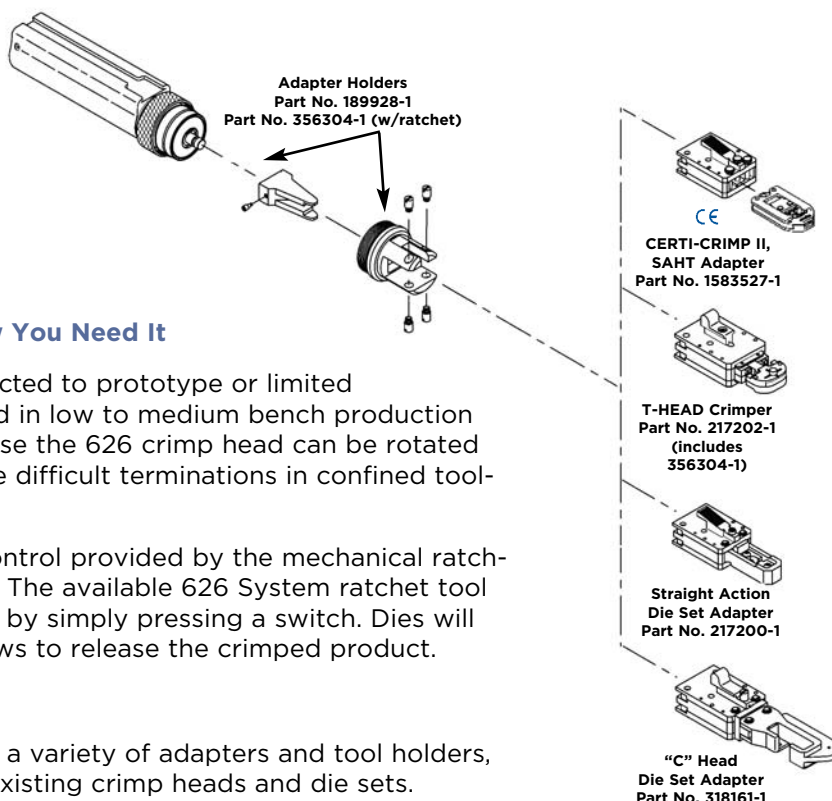
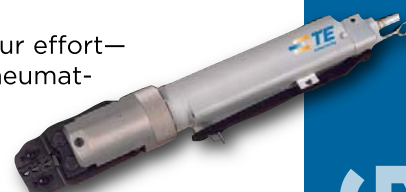

The 626 System Works Where and How You Need It

Using 626 adapters, tools previously restricted to prototype or limited production applications can now be used in low to medium bench production and harness assembly operations. Because the 626 crimp head can be rotated to any angle, you can also work on those difficult terminations in confined tooling cabinets or enclosures.

Looking for the complete crimp cycle control provided by the mechanical ratchet in premium CERTI-CRIMP hand tools? The available 626 System ratchet tool holders produce a complete crimp cycle by simply pressing a switch. Dies will fully bottom before you can open the jaws to release the crimped product.

Protect Your Investment

The 626 system's power unit works with a variety of adapters and tool holders, so you can continue to work with your existing crimp heads and die sets.

SDE (Standard Die Envelope) die sets can be interchanged from tool to tool as your crimping needs expand.

Need More Information?

For information about tooling, call 888-777-5917 or 717-810-2080; email: toolingsales@te.com.

Catalog 5-1773465-1
Issued 09-2012

For drawings or technical data, contact your TE Connectivity sales engineer or call the Technical Support Center: 1-800-522-6752. Dimensions are in millimeters unless specified otherwise. Values in brackets are English equivalents unless specified otherwise. Specifications subject to change. Consult TE Connectivity for latest specifications.



Distribution Channel Tooling Solutions

Big Return in a Micro Package

Does your crimping application demand even more accessibility and flexibility than the 626 system offers? The micro pneumatic tool system terminates wires in the 26-14 AWG [0.12-2 mm²] range,* but with a smaller and lighter power unit. Weighing in at only 0.7 kg [1.5 lb] and just 146.5 mm [5.75 in] long, the hand-actuated micro system is compatible with three different head systems.

* With the exception of the SOLISTRAND head combination, which crimps 22-10 AWG [0.3-2 mm²] combinations.

Die Interchangeability

For the ability to change dies quickly when needs change, whether from one terminal type to another or from tool to tool when workload and environment change, consider the SDE family of tools and dies. For more information, see catalog 1773379-1.



626 Pneumatic System Power Unit



| | |
|------------------|----------------------------------------------------------------------------------------|
| Outside Diameter | 45 mm [1.8] |
| Length | 225 mm [8.88] for foot actuated unit 230 mm [9.00] for hand actuated unit |
| Grip Span | 55 mm [2.19] over button/handle |
| Mass | 0.60 kg [1.32 lbm] for foot actuated unit 0.72 kg [1.58 lbm] for hand actuated unit |
| Air Pressure | 6.21-6.89 bar [90-100 psi] |
| Air Displacement | 0.00018 m ³ [11.14 in ³] |
| Air Supply Hose | 3.05 m [10 ft] long, 4.8 mm [3/16] I.D. with 1/8 in NPT fitting |
| Cycle Time | 0.7-0.8 s (for 16-14 AWG [1.3-2 mm ²] PIDG Terminals) |

Micro Pneumatic System Power Unit

| | |
|------------------|--------------------------------------------------------------------|
| Outside Diameter | 45 mm [1.8] |
| Length | 146.5 mm [5.75] |
| Grip Span | 55 mm [2.19] over button/handle |
| Mass | 0.70 kg [1.5 lbm] |
| Air Pressure | 6.21-6.89 bar [90-100 psi] |
| Air Displacement | 0.00018 m ³ [11.14 in ³] |
| Air Supply Hose | 3.05 m [10 ft] long, 4.8 mm [3/16 in] I.D. with 1/8 in NPT fitting |
| Cycle Time | 0.7-0.8 s (for 16-14 AWG [1.3-2 mm ²] PIDG Terminals) |

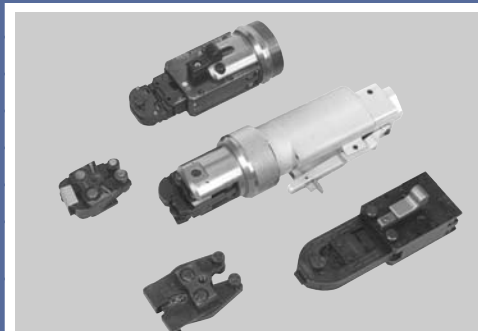

SDE Compatible Kit

| | | |
|-----------------------------------------|---------------|--------------------------------------|
| Complete tool with hand-held power unit | P/N 1213855-1 | 0.3 - 6.0mm ² (22-10 AWG) |
|-----------------------------------------|---------------|--------------------------------------|

Tool and Adapter Holders*

| | Large Tool Holder | Small Tool Holder | Adapter Holder |
|-----------------------------|-------------------|-------------------|-------------------|
| Length (with Head Assembly) | 100 [3.88] | 70 [2.75] | 70 [2.75] |
| Weight (with Head Assembly) | 0.76 kg [1.68 lb] | 0.44 kg [0.96 lb] | 0.44 kg [0.96 lb] |

*Measurements are averages.

Bench Mount Assembly*

| | |
|---------------------------|----------------------------------------------------------|
| Base Size | 200 x 200 [8 x 8] |
| Weight | 2.9 kg [6.5 lb] |
| Bench Mounting Dimensions | Base has two, 1/4-20 tapped holes on 150 [6] centerlines |
| Part No. | 856402-1 |

* Not for use in the European Community.



Hydraulic Crimp Tooling

Fast Facts

- Standard 10,000 psi [68,950 kPa] rated hydraulic pumps and heads
- Interchangeable TE-design U-dies for crimp force up to 14 tons [125 kN]
- U-die stroke options of 1 in [25 mm] and 1.5 in [38 mm]
- Termination range varies by product type
- Integrated head/die for crimping #8-2 AWG [7-34 mm²] SOLISTRAND terminals
- Heads compatible with shank-dies available for larger wires requiring crimp force greater than 14 tons [125 kN]
- Portable power, using a hand-held tool with rechargeable battery, or a portable battery hydraulic unit for standard crimping system
- Electric & manual hydraulic pumps for crimping at fixed locations
- Produced under a quality management system certified to ISO 9001. A certificate copy is available upon request.

New 10,000 psi-rated Tools with industry-standard U-dies, also available with portable, powered pumps

TE Connectivity continues the quality tradition of crimping tools with a new line of industry-standard 10,000 psi [68,950 kPa] hydraulic compression crimp heads, pumps, and interchangeable U-dies. A new battery-powered pump and tool options provide unprecedented portability for any crimping application. The U-dies, made with the TE-design precision and performance you've come to expect, are well suited for applications requiring a crimp force of up to 14 tons [125 kN]. For wire sizes requiring more than 14 tons [125 kN], TE offers five heavy-duty crimp head configurations that are compatible with shank dies.

There are four light-duty crimp head options, including three in the U-die format. U-dies are available in two types, with 1 in [25 mm] and 1.5 in [38 mm] stroke, respectively. The two 12 ton [101 kN] head options have 1 in [25 mm] stroke. The 14 ton [125 kN] head is for larger products that call for a 1.5 in [38 mm] stroke. Also available is an integrated head/die for crimping #8 to #2 SOLISTRAND terminals. The heavy-duty heads are available in five different configurations. *Note: These heads are not compatible with 8,200 psi [56,540 kPa] tooling.*

The basic 10,000 psi hydraulic tool system requires a pump, hose (multiple lengths are available with all configurations), crimp head, and crimp die. There is a TE hydraulic pump to meet the demands of any crimping application. For maximum portability, the hand-held crimping tool with rechargeable battery is an effective solution. Or, to power a standard crimping system at any location, order the portable battery hydraulic unit. For fixed crimping locations, you can choose between a 110 V or 220 V electric hydraulic pump (with optional remote hand control), or manual foot and hand hydraulic pumps.



U-Die Line up, including #8-#2 SOLISTRAND head, for 10,000 psi [68,950 kPa] systems providing up to 14 tons [125 kN] of crimp force.



Shank-Die Line up, for wiring sizes requiring more than 14 tons [125 kN] of crimp force.



Heavy-Duty Crimp Head (U-Die).



Need More Information?

For information about tooling, call 888-777-5917 or 717-810-2080; email: toolsales@te.com.

Catalog 5-1773465-1
Issued 09-2012

For drawings or technical data, contact your TE Connectivity sales engineer or call the Technical Support Center: 1-800-522-6752. Dimensions are in millimeters unless specified otherwise. Values in brackets are English equivalents unless specified otherwise. Specifications subject to change. Consult TE Connectivity for latest specifications.

Selecting a Hydraulic System?

Have you remembered a...

- Pump
- Hand or Foot control
- Hose
- Crimp Head
- Crimp Die

- Powered systems require a pump, hand or foot control, hose, crimp head and die except with 1673672-1 (see below).
- The portable battery pump, 180411-1, includes a hand control.
- Manual systems require hand tools (see below) and the battery hand tool (see back page) requires only dies.
- Refer to colored matrix throughout the catalog for die, head and hand tool options.

HYDRAULIC TOOLING SELECTION GUIDE

Hydraulic Pumps, Controls and Hoses *The Heavy-duty Pump is designed for higher crimp cycle frequency.*

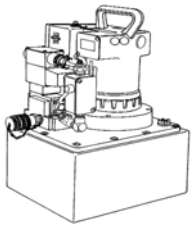

Heavy Duty Electric Hydraulic Pump (110V)^{1,2} PN 1804700-1
OR
Heavy Duty Electric Hydraulic Pump (220V)^{1,2} PN 1804700-2

WITH

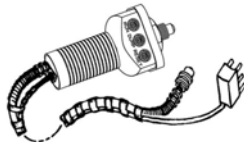

Remote Hand Control³
(for Heavy-Duty pump)
w/hose attached
PN 1901775-1 (7 ft hose)
PN 1901776-1 (15 ft hose)
PN 1901777-1 (21 ft hose)

OR



Remote Foot Control³
(for Heavy-Duty pump)
PN 68284-1

AND



Hydraulic Hoses⁴
(not required for hand control)
PN 1583662-1 (6 ft)
PN 1583662-2 (10 ft)
PN 1583662-3 (20 ft)

Heavy-Duty Crimp Heads (Shank Dies) (> 25,000 cycles)

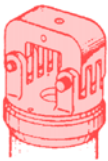

250 MCM - 600 MCM
33 ton output force
28 lbs
PN 1752788-1
IS 408-8915

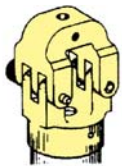

8 - 4/0 A
22 ton output force
16 lbs
PN 1752877-1
IS 408-8956



4/0 AWG - 1000 MCM
26 ton output force
29 lbs
PN 1752786-1
IS 408-8958



8 - 4/0 AWG
33 ton output force
28 lbs
PN 1752787-1
IS 408-8914



12-10 AWG - 350 MCM
18 ton output force
13 lbs
PN 1752868-1
IS 408-8959

Shank Dies



| | |
|-----------------------------|-----------------------|
| AMPLI-BOND | 8 AWG - 4/0 AWG |
| AMPOWER | 6 AWG - 1500 MCM |
| AMPOWER Quick Disconnect | 1/0 AWG - 600 MCM |
| Insulation Piercing COPALUM | 10 AWG (Cu) - 3/0 AWG |
| Sealed COPALUM | 10 AWG - 3/0 AWG |
| Bar COPALUM | 10 AWG (Cu) - 400 MCM |
| SOLISTRAND | 8 AWG - 600 MCM |
| STRATOTHERM | 8 AWG - 2/0 AWG |
| TERMINYL | 1/0 AWG thru 4/0 AWG |

Medium-Duty Crimp Heads & Hand Tools (U-Dies)



12 ton output force
1" stroke; 20,000 cycle
Light Duty
Compression Head²
U-Die Compatible
PN 1490745-1
IS 408-10111



12 ton output force
1.5" stroke; 20,000 cycle
Light Duty
Compression Head
U-Die Compatible
PN 1490746-1
IS 408-10112



12 ton output force
1" stroke Titanium
Compression Head
U-Die Compatible
PN 1490747-1
IS 408-8715



14 ton output force
1.5" stroke;
Heavy-Duty
Compression Head
U-Die Compatible
PN 1976230-1
IS 408-10145



14 ton output force
1.5" stroke
Compression Tool
U-Die Compatible
PN 1490749-1
IS 408-8717

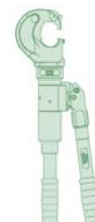

1" stroke Hand
Compression Tool
U-Die Compatible
PN 1490748-1
IS 408-8716



| | |
|------------|-----------------|
| AMPLI-BOND | 8 AWG - 2 AWG |
| AMPOWER | 6 AWG - 4/0 AWG |
| SOLISTRAND | 8 AWG - 4/0 AWG |
| TERMINYL | 8 AWG - 1/0 AWG |

Not sure what's right for you? Call our Tooling Specialists at 888-777-5917 or 717-810-2080.

SOLISTRAND (Integrated Crimp Dies)

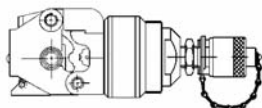

#8-#2 AWG SOLISTRAND
Compression Head
(No crimp dies required)
PN 1673672-1
IS 408-8910

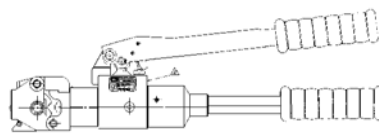

#8-#2 AWG SOLISTRAND
Compression Tool
(No crimp dies required)
PN 59975-1
IS 408-6758

- ¹ Portable battery pump 1804111-1, Foot pump 1583659-1 OR hand pump 1583661-1 can be substituted as manual options for electro-hydraulic pumps (see back page).
- ² Includes male screw-to-connect, 3/8" NPT quick couplers
- ³ Not required with manual pump options.
- ⁴ Includes female screw-to-connect, 3/8" NPT quick couplers



Distribution Channel Tooling Solutions

Dies, Hand Tools, and Hydraulic Heads—Configuration Options

STRATO-THERM™ Terminals and Splices

| | Hydraulic Crimp Tooling 10,000 psi Operating Pressure | DYNA-CRIMP System 8,200 psi Operating Pressure |
|-------------------------------------|----------------------------------------------------------|---------------------------------------------------|
| | Hydraulic Head (Shank Die) | Hydraulic Head (Shank Die) |
| Wire Size AWG [mm ²] | 1752868-1 | 69099 |
| 8 [7-8.5] | 69211-1 | 69211-1 |
| 6 [13-15] | 69212-1 | 69212-1 |
| 4 [21] | 69213-1 | 69213-1 |
| 2 [34-35] | 69214-1 | 69214-1 |
| 1/0 [50-60] | 69215-1 | 69215-1 |
| 2/0 [67-70] | 69254-1 | 69254-1 |

Portability Options

Portable tools and pump units allow you to perform crimping where it's needed—in the factory or in the field.



Kit includes hand control, hose not included. See page 2.

Portable Battery Hydraulic Unit

| | |
|-----------|-------------------------------------------------|
| 1804111-1 | Portable Battery Unit (10,000-psi [68,950 kPa]) |
| 1804112-1 | Nickel-Metal Hydride Battery Pack |
| 1804113-1 | Nickel-Cadmium Battery Pack |
| 1804114-1 | Battery Charger 110 V |
| 1804117-1 | Control Switch Sub-assembly |



Self contained power unit. Crimp dies not included.

Hydraulic Crimping Tool with Rechargeable Battery

| | |
|--------------|-------------------|
| PN 1213875-1 | Crimping Tool Kit |
| PN 1213872-1 | Battery |
| PN 1213873-1 | Battery Charger |

Compatible with same dies as 12 ton [101 kN] 1 in [25 mm] compression head, P/N 1490745-1

Pumps for Fixed Locations

For fixed crimping locations, choose for fixed crimping between a 110 or 220 V electric hydraulic pump (with optional remote hand control), or manual foot and hand hydraulic pumps.

Heavy-Duty Electric Hydraulic Pump

P/N 1804700-1 (110 V) or 1804700-2 (220 V)

- 2½ gallon reservoir
- 1½ HP motor
- 56 cu. in. flow rate
- 65 lbs

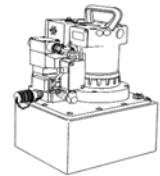

Remote Hand Control (for Electric Hydraulic Pump)

- 1901775-1 (7 ft hose)
- 1901776-1 (15 ft hose)
- 1901777-1 (21 ft hose)



Remote Foot Control (for Electric Hydraulic Pump)

PN 68284-1



3-Way Multidirectional Valve

PN 1901782-1 (manual)

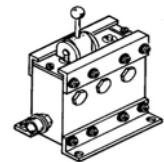

Manual Pumps

Foot Hydraulic Pump

PN 1583659-1



Hand Hydraulic Pump

PN 1583661-1

- Not for steel or ACSR cable



Need More Information?

For information about tooling, call 888-777-5917 or 717-810-2080; email: toolingsales@te.com.

Catalog 5-1773465-1
Issued 09-2012

For drawings or technical data, contact your TE Connectivity sales engineer or call the Technical Support Center: 1-800-522-6752. Dimensions are in millimeters unless specified otherwise. Values in brackets are English equivalents unless specified otherwise. Specifications subject to change. Consult TE Connectivity for latest specifications.



SDE Electric Benchtop Terminator

Fast Facts

This convenient, powerful terminator is a dependable asset for small-scale bench production or wire harness assembly.

- Compatible with over 100 SDE dies
- Terminates wires to 10 AWG [6 mm²]
- Small footprint—390 x 260 x 200 mm [15.5 x 10 x 8 in]; lightweight—13 kg [29 lb]
- Foot actuated, with jog cycle
- Crimp jaws normally closed
- Power requirement: 110/120V or 220/240V; 0.7 KVA
- Engineered and manufactured using processes independently certified to internationally recognized quality standards ISO-9001:2000 and telecommunications industry standard TL 9000.

The SDE electric terminator offers excellent price to performance ratio in a compact benchtop unit with the features normally found on more expensive models. It is ideally suited for low to medium volume bench production and harness assembly. As part of the SDE family, it is compatible with a broad range of crimp dies that are fully interchangeable among tools and tool platforms.

Versatile. As an SDE tool, the system accommodates dozens of interchangeable dies in an ever expanding range, including those for open-barrel contacts and terminals. Many die sets have multiple cavities for crimping more than one wire or terminal size. The tool can terminate wires up to and including 10 AWG [6mm²].

Convenient. A completely logical, simple arrangement of control switches and connections provides easy setup and requires only minimal operator training. Operator safety is enhanced by a safety reverse switch and safety lock foot pedal.

In addition, crimp jaws are normally closed. The sprung shut jaws grip the terminal prior to wire insertion, to ensure precise positioning. A cycle counter tracks operation, for maintenance planning.

Quality. Every SDE terminator crimps with precision, incorporating the traditional quality of all TE products.



SDE (Standard Die Envelope) die sets can be interchanged from tool to tool as your crimping needs expand.



AT-SC Crimping Machine

The AT-SC pneumatic crimping machine features a newly developed safety mechanism, and is designed to crimp connections up to 50.0 mm² depending on the terminal design.

By means of a fitted safety valve, crimping is not released where the size of the opening between the impact surfaces of the dies exceeds 5.9 mm. Consequently, there is no need to specify any safety covers to protect the operator.

The use of a safety double foot pedal simplifies the operation while increasing productivity.

Basic Machine

- Electronic piece counter
- Pneumatic safety double foot switch
- Color-coded air hoses
- AT-SC SDE die holder PN 1-528051-0
- Tool kit
- Grease gun
- Customer manual 412-18876

Special Features

- Adjustable pre-crimp pressure and speed
- Parallel closing mechanism
- Variable closing speed
- Electronic piece counter
- Safety system

Machine PN 528050-1

Technical Data

- Air pressure max. 600 kPa (6 bar) / 90 PSI
- Air consumption 2.3 NL/cycle
- Noise level <62 dB(A)
- Dimensions HxWxD = 300.0 x 160.0 x 280.0 mm
- Weight 22.0 kg

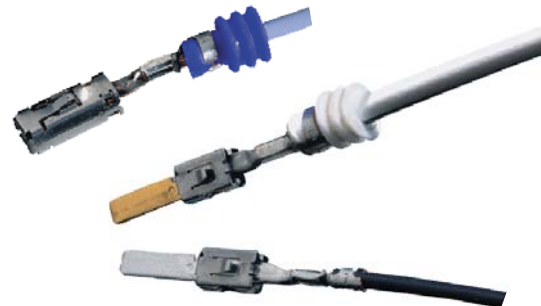

SDE (Standard Die Envelope) die sets can be interchanged from tool to tool as your crimping needs expand.

Need More Information?

For information about tooling, call 888-777-5917 or 717-810-2080; email: toolingsales@te.com.

Catalog 5-1773465-1
Issued 09-2012

For drawings or technical data, contact your TE Connectivity sales engineer or call the Technical Support Center: 1-800-522-6752. Dimensions are in millimeters unless specified otherwise. Values in brackets are English equivalents unless specified otherwise. Specifications subject to change. Consult TE Connectivity for latest specifications.



AT-55 Crimping Machine

The AT-55 pneumatic crimping machine was designed for crimping insulated and non-insulated terminals from 0.14 mm² to 120.0 mm² depending on the terminal.

With the addition of an optional cutting unit, the AT-55 crimping machine is able to cut ribbon cable up to a width of 30.0 mm as well as copper conductors up to max. Ø 28.0 mm.

This series is equipped with a battery cycle counter. Safety guards allow crimp terminals up to a diameter of 25.0 mm. Larger terminals can be applied upon request.

Basic Machine

- Battery cycle counter
- Pneumatic foot switch
- Air hoses
- Tool kit to assemble dies and holders
- EHC 10 die adapter PN 528051-5
- Grease gun
- Customer manual 412-18877

Die Sets and Special Parts

Additional die sets and special parts are available upon request.

Machine PN 528050-4

Technical Data

- Crimping force at P = 550 kPa (5.5 bar) / 53 kN
- Crimping force at P = 600 kPa (6.0 bar) / 57 kN
- Crimping force at P = 700 kPa (7.0 bar) / 67 kN
- Air pressure max. 600-750 kPa (6-7.5 bar) / 90 PSI
- Air consumption 31 NL/cycle
- Max. stroke 32.0 mm
- Noise level < 69 dB(A)
- Dimensions HxWxD = 420.0 x 230.0 x 425.0 mm
- Weight 49.0 kg





AT-66 Crimping Machine

The AT-66 hydraulic crimping machine features an extremely compact design for low space requirement. The hydraulic power is provided by a separate hydraulic unit with main switch, power distribution and pump.

The AT-66 machine offers possibilities for various applications with a crimp force of 150 kN and an open operating space of 100.0 mm in height. This machine can be easily used for wire sizes from 0.14 mm² up to 300.0 mm².

Basic Machine

- Remote hydraulic unit
- Electric foot pedal
- U-die adapter 528051-4
- Customer manual 412-18954

Freely Programmable Features

- Crimp height
- Return height
- Pre-crimp position
- 3 different crimp cycles
- 250 program memory locations

Special Features

- Key operated switch protected user interface
- Fast changeover times
- Short cycle time

Die Sets and Special Parts

Additional die sets and special parts are available upon request.

Machine PN 528050-5 EUROPE version
Machine PN 528050-6 USA version

Technical Data

- Max. power 150 kN
- Max. stroke 40.0 mm
- Speed <10 mm/cycle
- Power supply 400 V, 3 phase, 50 Hz - Europe
230 V, 3 phase, 60 Hz - USA
- Dimensions HxWxD = 510.0 x 220.0 x 290.0 mm
- Weight approx. 135.0 kg



Need More Information?

For information about tooling, call 888-777-5917 or 717-810-2080; email: toolingsales@te.com.

BENCHTOP TOOLING

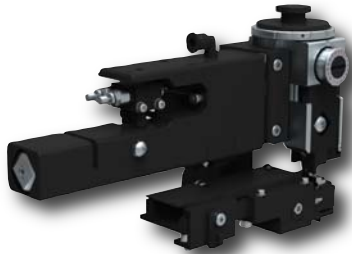

*ATLANTIC-Style Side-Feed
Pneumatic Applicator*



*ATLANTIC-Style End-Feed
Mechanical Applicator*



*PACIFIC-Style Side-Feed
Mechanical Applicator*

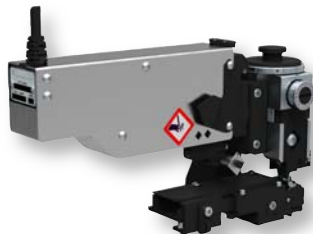

*PACIFIC-Style Side-Feed
Servo Applicator*

OCEAN Applicator

The lead and harness industry of today is more price and quality competitive than ever before. TE Connectivity OCEAN applicators are designed to meet these demands. We strive to keep our applicators competitively priced while providing the consistent, high-quality terminations you've come to expect from TE Connectivity.

Why a new TE Connectivity Applicator Design?

We standardized our applicator offerings to provide global design consistency and to offer the ultimate flexibility with choices in feeding options.

The OCEAN applicator is designed so that all feed options are interchangeable with the common base applicator. Our pneumatic and mechanical feed options have been completely redesigned. They offer finer, more precise terminal positioning along with quicker adjustability while being much more user friendly. The interchangeability also makes it possible to upgrade to smart applicator technology.

Advantages of the OCEAN Applicator:

- One applicator platform — modular family design
 - Two styles with 3 feed options: mechanical, pneumatic and servo
- Same wire crimper, insulation crimper and anvil used on both applicator styles
- Open architecture allows for design flexibility
- 60% tighter fit between the ram and housing for improved alignment and crimp consistency
- Finer incremental crimp height adjustment
- Improved and simpler adjustments on all feed units



Request catalog 9-1773458-6 for more information.

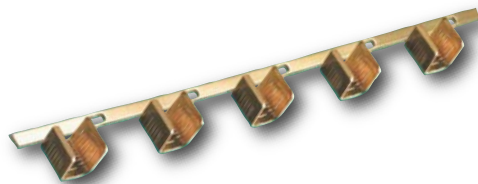

BENCHTOP TOOLING



AMP 3K/40 and AMP 5K/40 Terminators

These value-oriented terminators are based on the field-proven AMP-O-LECTRIC Model G terminator. They are the latest in the series of machines for terminating wire using reeled terminals and contacts. The AMP 3K/40 and AMP 5K/40 are designed for customers that require the increased output and quality of a benchtop, semi-automatic machine at a competitive price. Reliability is evident in features like the direct motor drive system and robust construction.

- Crimp force for AMP 3K/40 13.3 kN [3,000 lb]; for AMP 5K/40 22.2 kN [5,000 lb]
- Accepts TE applicators
- Tool-less removal of applicators and guards for maintenance and product changeover
- Jog capability
- DC motor with gearbox drive, for small footprint and quiet operation
- Air feed available
- Available equipped with stripping module
- Available equipped with CQM II
- Light weight—68 kg [150 lb]



| AMP 3K/40 | Part No. |
|--------------------------------------------------------------------------------------------|-------------|
| Manual precision crimp height adjust | 1725950-2 |
| Manual precision crimp height adj. w/crimp quality monitor II | 3-1725950-0 |
| Manual precision crimp height adjust, with stripping module | 1725910-2 |
| Manual crimp height adjust, with stripping module, with crimp quality monitor II | 1-1725910-9 |
| AMP 5K/40 | Part No. |
| Manual precision crimp height adjust | 1725900-2 |
| Manual precision crimp height adj. w/crimp quality monitor II | 3-1725910-1 |
| Manual precision crimp height adjust, with stripping module | 1725910-6 |
| Manual precision crimp height adjust, with stripping module, with crimp quality monitor II | 2-1725910-0 |
| Air feed kit for AMP 3K/40 or AMP 5K/40 | 1424266-1 |

Need More Information?

For information about tooling, call 888-777-5917 or 717-810-2080; email: toolingsales@te.com.

Catalog 5-1773465-1
Issued 09-2012

For drawings or technical data, contact your TE Connectivity sales engineer or call the Technical Support Center: 1-800-522-6752. Dimensions are in millimeters unless specified otherwise. Values in brackets are English equivalents unless specified otherwise. Specifications subject to change. Consult TE Connectivity for latest specifications.

Correct

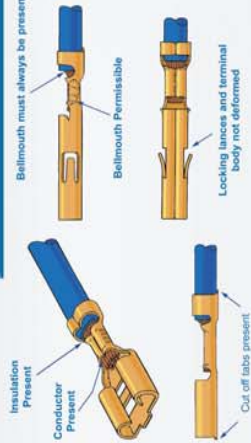

INSULATION CRIMP

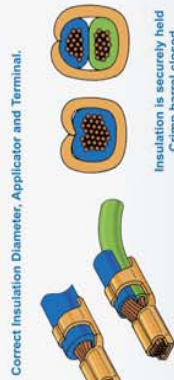

WRAP OVER



Incorrect

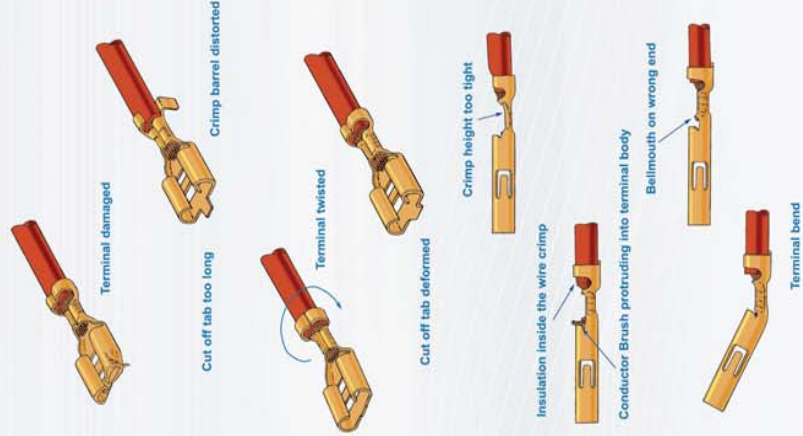

Test

WIRE CRIMP

Crimp height measurement
Crimp heights and tolerances
For crimp height tolerances for any given contact, please refer to the relevant application specification.

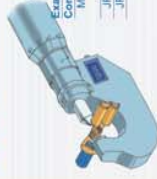

Examples:

| Contact | PIN | Wire Range | Tolerance | Application Spec. |
|---------|--------|-----------------------------|-----------|-------------------|
| NCS | 962885 | 0.20 - 0.50 mm ² | ± 0.03 mm | 114-18025 |
| JPT | 962896 | 0.40 - 1.00 mm ² | ± 0.04 mm | 144-18050 |
| JPT | 962773 | 1.50 - 2.50 mm ² | ± 0.05 mm | 144-18050 |

Digital crimp height micrometer
(0.001mm increments) according to
DIN ISO 9001



Part Number 547203-1

WIRE CRIMP

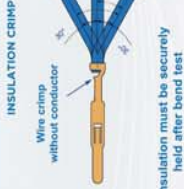

Training & Services

Please contact our
service hotline
for information.
Tel: 1-800-722-1111

The TE Connectivity logo and TE Connectivity are trademarks. © 2011 Tyco Electronics Corporation 18796-01 Revised 05-11
All figures are schematic depictions. In every case, relevant product and application specification take precedence.



Distribution Channel Tooling Solutions

Notes

Need More Information?

For information about tooling, call 888-777-5917 or
717-810-2080; email: toolsales@te.com.

Catalog 5-1773465-1
Issued 09-2012

For drawings or technical data, contact your TE Connectivity sales engineer or call the Technical Support Center: 1-800-522-6752. Dimensions are in millimeters unless specified otherwise. Values in brackets are English equivalents unless specified otherwise. Specifications subject to change. Consult TE Connectivity for latest specifications.

tooling.te.com
tooling.te.com/china
tooling.te.com/europe

Disclaimer

While TE Connectivity has made every reasonable effort to ensure the accuracy of the information in this catalog, TE does not guarantee that it is error-free, nor does TE make any other representation, warranty or guarantee that the information is accurate, correct, reliable or current.

TE reserves the right to make any adjustments to the information contained herein at any time without notice. TE expressly disclaims all implied warranties regarding the information contained herein, including, but not limited to, any implied warranties of merchantability or fitness for a particular purpose.

The dimensions in this catalog are for reference purposes only and are subject to change without notice. Specifications are subject to change without notice. Consult TE for the latest dimensions and design specifications.

Catalog 5-1773465-1 / 09-12 / Application Tooling

© 2012 Tyco Electronics Corp. All Rights Reserved. AMP, AMPLI-BOND, AMPMODU, AMP-O-LECTRIC, AMP 3K/40, AMP 5K/40, AMPLIMITE, AMPOWER, CERTI-CRIMP, CHAMP, COPALUM, DIAMOND GRIP, JacKnack, MATE-N-LOK, PIDG, PRO-CRIMPER, SOLISTRAND, STRATOTHERM, TERMINYL, the TE Connectivity (logo) and TE Connectivity are trademarks.

Tyco Electronics Corporation, Harrisburg, PA 17105, Phone: 888-777-5917 or 717-810-2080; email: toolingsales@te.com

