

TR11 Series

UL1077 Recognized Supplementary Protector/ Circuit Breaker for Equipment



E209569



up to 12 Amps

Applications:

Protection of Control Transformers, UPS, Power strips, Solenoids etc., against damage due to overload conditions.

Current Rating (A)	0.1 - 16A
Standard Current Rating (A)	0.1, 0.25, 0.5, 0.9, 1.0, 1.2, 1.5, 1.8, 2.0, 2.2, 2.5, 2.7, 3.0, 3.3, 4.0, 5.0, 6.0, 6.5, 7.0, 8.0, 9.0, 10.0, 12.0, 15.0, 16.0
Rated Voltage	240V AC, 50/60Hz, 50V DC / 24V DC (VDE)
Initial insulation resistance (500V DC)	> 100 M ohms. (As per EN 60934)
Dielectric strength	1.5 KV for One minute. (As per EN 60934)
Overload Switching Capacity	6 I _n - AC up to 9.0A 4 I _n - DC up to 12.0A (As per EN 60934) 60A AC/DC Max. - from 10.0A to 12.0A
Maximum Breaking Capacity	8x I _n AC/DC for <6.0A 60A AC/DC MAX. for > 6.0A
Power Loss	1 - 2 Watts
Operating Temperature	Maximum 60°C Ambient
Operational Life at 2xI _n	1000 Cycles
Rated Conditional Short Circuit Current Capacity I _{nc1} (PC1)	1000 Amps PC 1, 240V AC, 24V DC, Ref.: EN60934 SC: 1KA, C1, 240V AC 50V DC Ref.: CSA22.2 No.235-04, UL-1077
Tripping Current Code TC	TC 2 Ref.: CSA22.2 No. 235-04
Overload Rating	OL0 240V AC, 50V DC, Ref.: CSA22.2 No. 235-04
Application Type	General Industrial Ref.: CSA22.2 No. 235-04
Method of Tripping	Thermal 'TO' Trip Free
Type of Actuation	Reset Type 'R'
Application Standards	CSA 22.2 No. 235-04, UL-1077, EN 60934
Weight	aprox. 11g
Approvals	0.1 - 16.0A 240V AC 50V DC 0.5 - 12.0A 240V AC 24V DC

Operating Characteristic

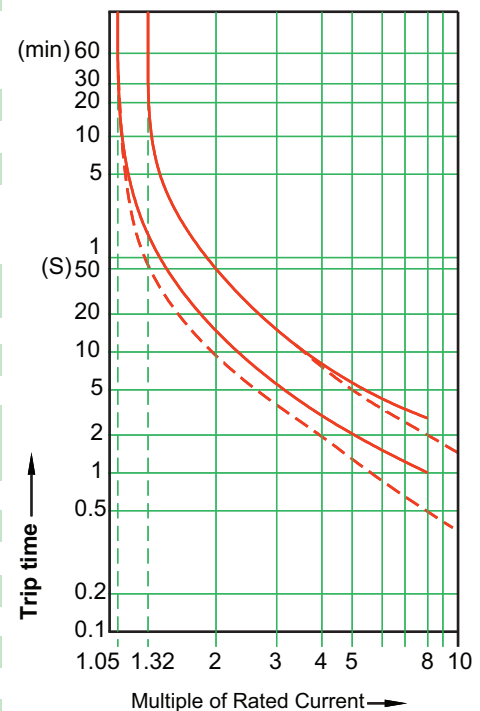

Rated current < 6 A
 - - - - - Ambient >= 6 A
 Temperature 23°C

ORDERING INSTRUCTIONS

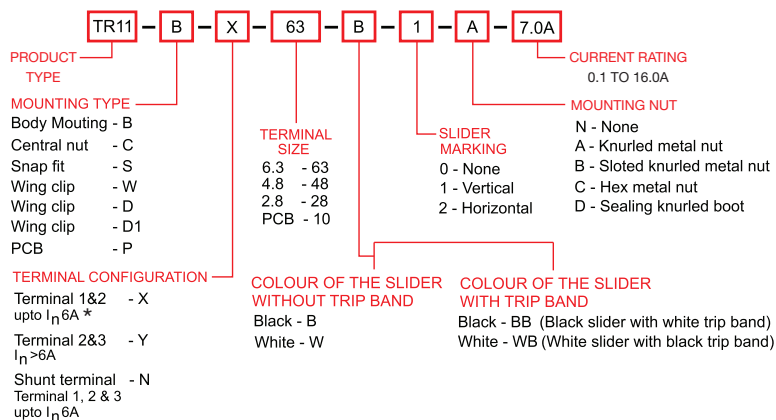

* Terminal configuration option X is available up to 12A; special order only. Consult Altech for ordering.

Time Current Characteristics:

The standard characteristic is valid for ambient temperatures of +23°C. If the device is to be used in an ambient temperature other than +23°C, allowances must be made when selecting the current rating according to the following guidelines:

Ambient temp.°C	-20	-5	0	+10	+20	+30	+40	+50	+60
Correction Factor	0.8	0.88	0.9	0.96	1	1.05	1.12	1.2	1.3

Example:	Normal Continuous Current	1.8A
	Ambient Temperature	40°C
	Correction Factor	1.12
	Recommended Current Rating	1.8 x 1.12 = 2.016
	Select the nearest	2.0A

Note: TR11-C Series stocked; contact Altech for availability.

TR-11 Dimensions & Mounting Options

Central Mounting

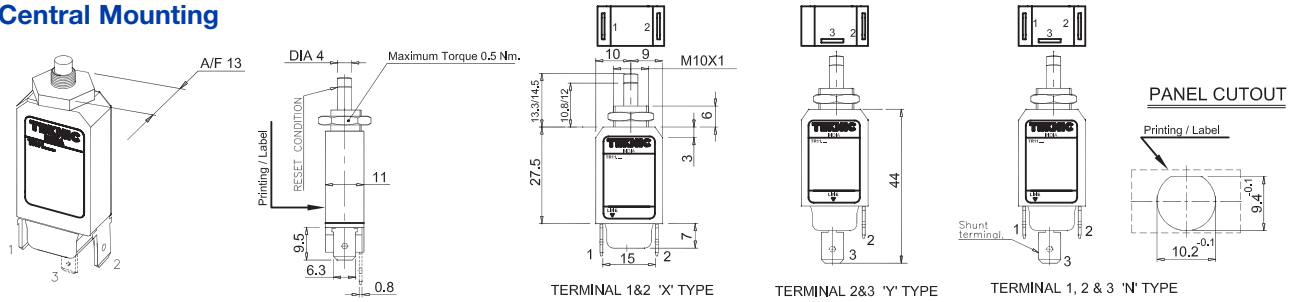

Wing Clips

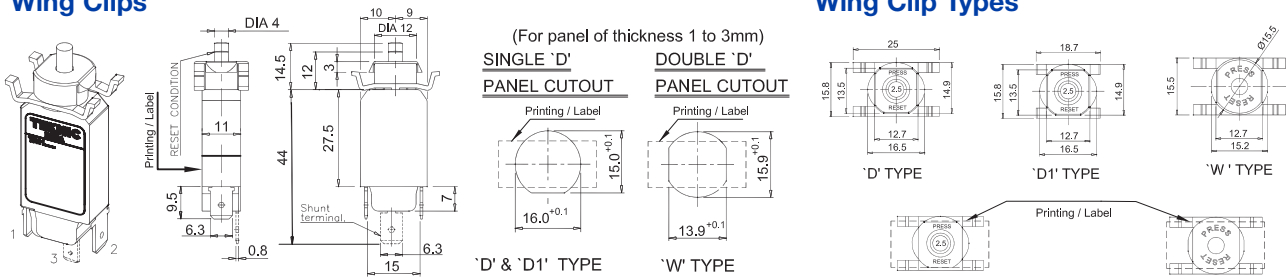

Snap Fitting

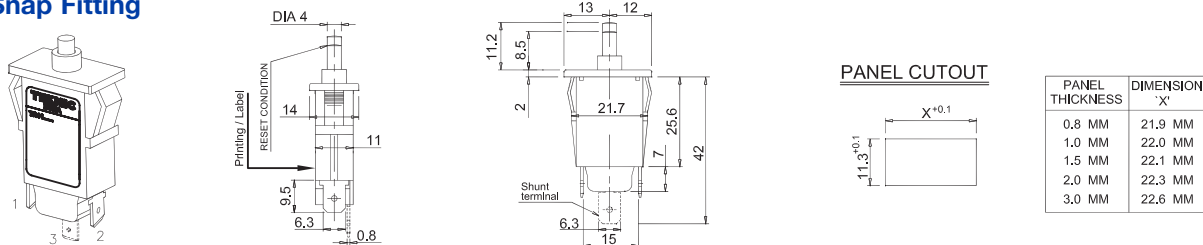

Body Mounting

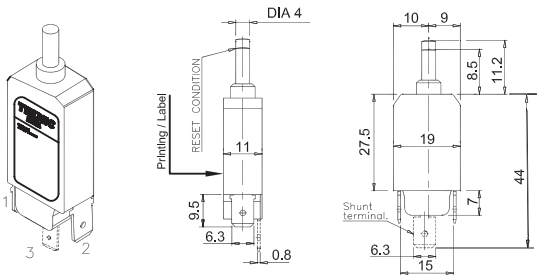

PCB Mounting

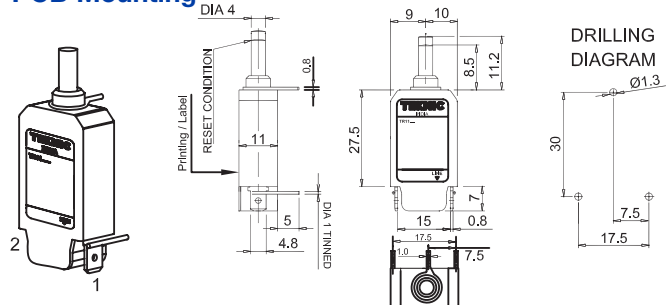

Slider Printing for Current Rating

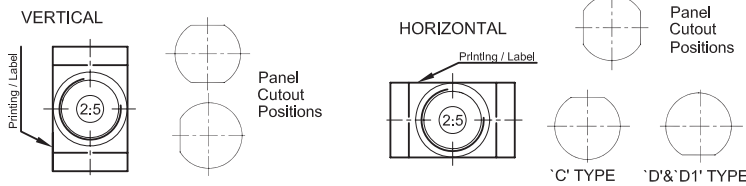

Slider Color with Trip Band

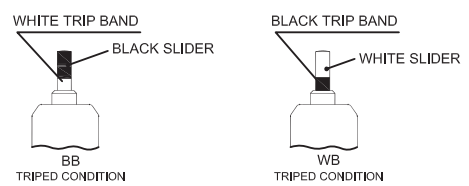

Accessories

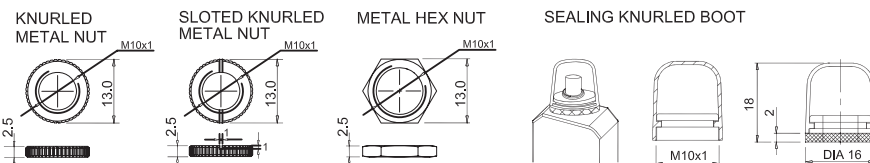

Dimensions in mm (to convert to inches multiply by 0.03937)

A sealing boot for central mounting Type (C) Circuit breaker to provide dust & splash protection (IP 54).

UL 489

UL 508

UL 1077

UL 1077
Equipment Breakers

Earth Leakage
Circuit Breakers



ANNEX

TR20 Series

UL1077 Recognized Supplementary Protector/ Circuit Breaker for Equipment

Applications:

Protection of Control Transformers, UPS, Power strips, Solenoids etc., against damage due to overload conditions.

Application Type	General Industrial Ref. CSA22.2 No.235-04
Function	SPST
Standard Current Rating (A)	3, 4, 5, 6, 7, 8, 10, 12, 15, 16 & 20 AC-Inductive, DC-Resistive
Rated Voltage	125/125V AC, 50/60 Hz, 50V DC
Method of tripping	Thermol TO, Cycling trip - free
Type of Actuation	Reset Type 'R'
Initial insulation resistance	> 100 M ohms. (DC500V)
Dielectric strength	1,500 KV for 1 minute
Impulse withstand voltage	2.5kV Ref.: EN 60934
Contact Gap	Micro disconnection(μ) Ref.: EN60934
Housing Material	Thermoplastic / Thermoset
Slider Material	Thermoset
Contact Material	Silver alloy
Terminal Material	Copper alloy
Fixing	By a nut or snap fitting
Resettable overload capacity	10 times the rated current
Overload capacity	2 times rated current for 50 switching cycles min. Ref.: UL 1077
Rated Short Circuit Capacity I_{cn}	Min 6 times the rated current ($6I_n$) for 250V AC (Inductive) Ref.: EN60934 Min 4 times the rated current ($4I_n$) for 50V DC (Resistive)
Rated Conditional Short Circuit Current Capacity I_{nc1} (PC1)	1000 Amps 125/250V AC, 50V DC SC: 1kA, C1, 125/250V AC, 50V AC Ref.: CSA22.2 No.235-04, UL-1077
Tripping Current Code TC	TC 2Ref.: CSA22.2 No. 235-04
Overload Rating	OLO 125/250V AC, 50V DC, Ref.: CSA 22.2 No. 235-04
Weight	aprox. 17g
Application Standards	UL 1077, CSA 22.2 No. 235-04, EN 60934
Approvals	  



E209569



up to 12 Amps

Operating Characteristic

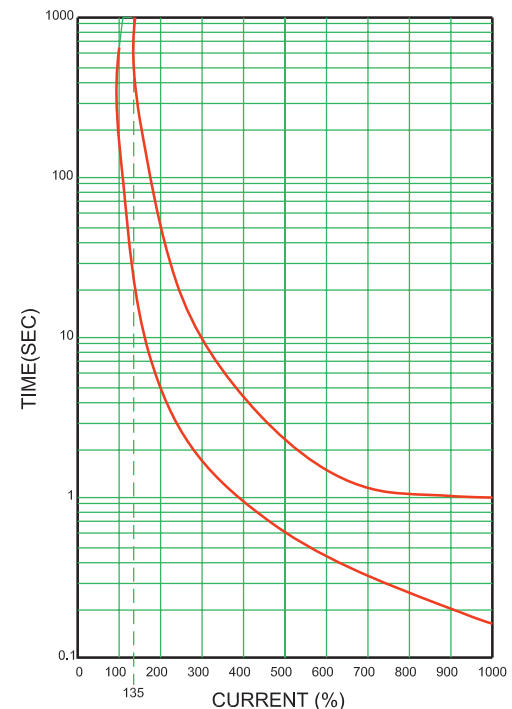

ORDERING INSTRUCTIONS

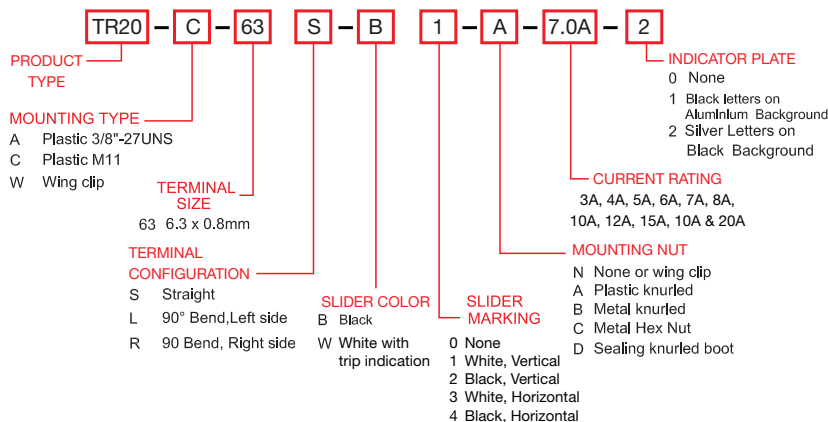

Time Current Characteristics:

The standard characteristic is valid for ambient temperatures of +25°C. If the device is to be used in an ambient temperature other than +25°C, allowances must be made when selecting the current rating according to the following guidelines:

Ambient temp. °C -20 -10 0 +10 +25 +30 +35

Multiplication Factor	0.8	0.85	0.9	0.9	1	1	1.1
3A to 4A							

Multiplication Factor	0.8	0.85	0.88	0.9	1	1.1	1.3	1.4
5A to 20A								

Example: Normal Continuous Current 5.0A
Ambient Temperature 40°C
Multiplication Factor 1.1
Selected rated current at +40°C
Ambient temperature 5 x 1.1 = 5.5
6.0A (nearest)

* SPECIAL ORDER ONLY. Contact Altech for more details.

PCB Mounting and additional Shunt Terminal available, please contact Altech.

TR-20 Dimensions & Mounting Options

Central Mounting

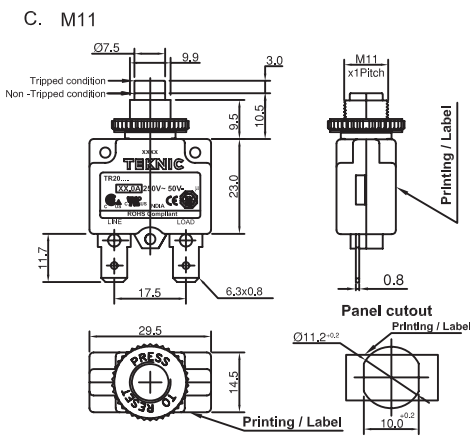
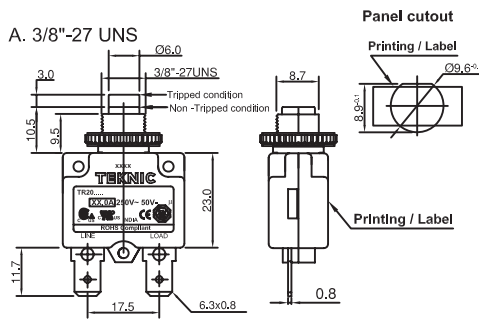

Wing Clips

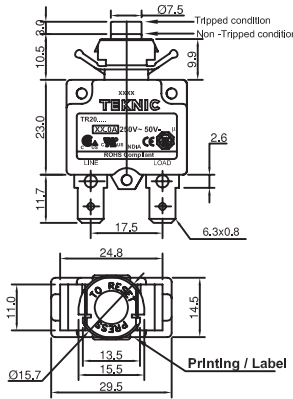

PANEL CUTOUT

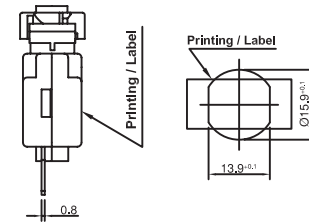

PANEL THICKNESS 1 TO 3MM.

Terminal Options

S. STRAIGHT

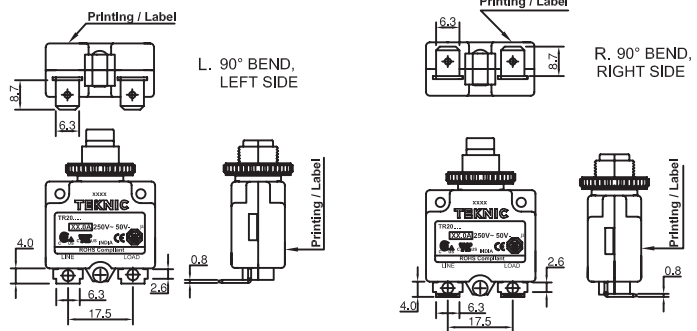
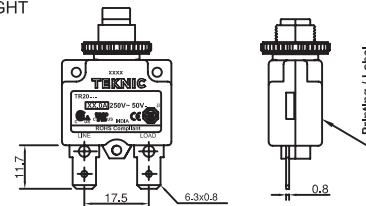

Slider Printing for Current Rating

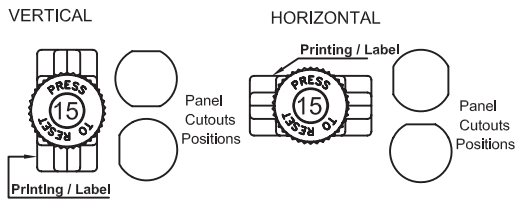

Accessories

PLASTIC NUT

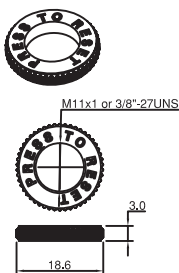

METAL NUT

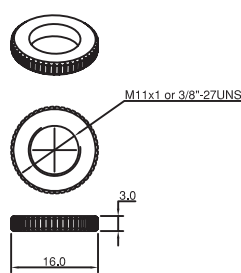

METAL HEX NUT

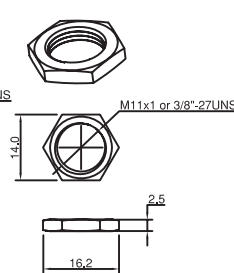

SEALING KNURLED BOOT

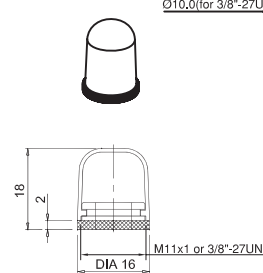

INDICATOR PLATE

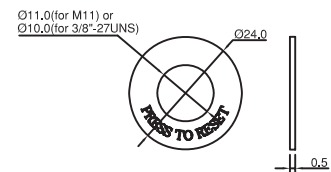

TYPES:

- A. Black letters on Aluminium Background.
- B. Silver Letters on Black Background.

Dimensions in mm (to convert to inches multiply by 0.03937)

TR30 Series

UL1077 Recognized
Supplementary Protector/
Circuit Breaker for Equipment

BOLD currents available.



up to 12 Amps

Applications:

Protection of Control Transformers, UPS, Power strips, Solenoids etc., against damage due to overload conditions.

Application Type	General Industrial Ref. CSA22.2 No.235-04
Function	SPST
Standard Current Rating (A)	5A-25A 5A, 6A, 7A, 10A, 12A, 15A, 20A, 25A, 30A & 35A
Rated Voltage	125/125V AC, 50/60 Hz, 50V DC
Method of tripping	Thermol TO, Cycling trip - free
Type of Actuation	Reset Type 'R'
Initial insulation resistance	> 100 M ohms. (DC500V)
Dielectric strength	1.500 KV for 1 minute
Impulse withstand voltage	2.5kV Ref.: EN 60934
Contact Gap	Micro disconnection(μ) Ref.: EN60934
Housing Material	Thermoset - UL94-V0 flammability class
Slider Material	Thermoset - UL94-V0 flammability class
Contact Material	Silver alloy
Terminal Material	Copper alloy
Fixing	By a nut or snap fitting
Resettable overload capacity	10 times the rated current
Rated Short Circuit Capacity I _{cn}	Min 6 times the rated current (6 _{In}) for 250V AC (Inductive) Ref.: EN60934 Min 4 times the rated current (4 _{In}) for 50V DC (Resistive)
Rated Conditional Short Circuit Current Capacity I _{nc1} (PC1)	1kA, 5 to 15A, 250V AC, 2kA, 20 to 35A, 250V AC, As per EN60934 1kA, 5 to 35A, 50V DC As per CSA 22.2 No. 235-04 & UL 1077 1kA, C1, 50V Dc, -(5-35A); 500A, U3, 125V AC, -(20-35A); 1kA, U1a, 125V AC, -(5-35A); 2kA, C1, 125V AC, -(5-35A); 1kA, C1, 250V AC, -(5-15A); 2kA, C1, 250V AC, -(20-35A)
Tripping Current Code TC	TC 3 Ref.: CSA22.2 No. 235-04
Overload Rating	5-35A - OL0 125/250V AC, 50V DC; As per CSA 22.2 No. 235-04 5-35A - OL1 125V AC; 5-35A - OL1 250V AC
Weight	aprox. 25g
Application Standards	UL 1077, CSA 22.2 No. 235-04, EN 60934, UL 1500
Approvals	
Ignition Protected	Compliant as per UL 1500 (Standard for safety for Ignition protection test for Marine products)

Operating Characteristic

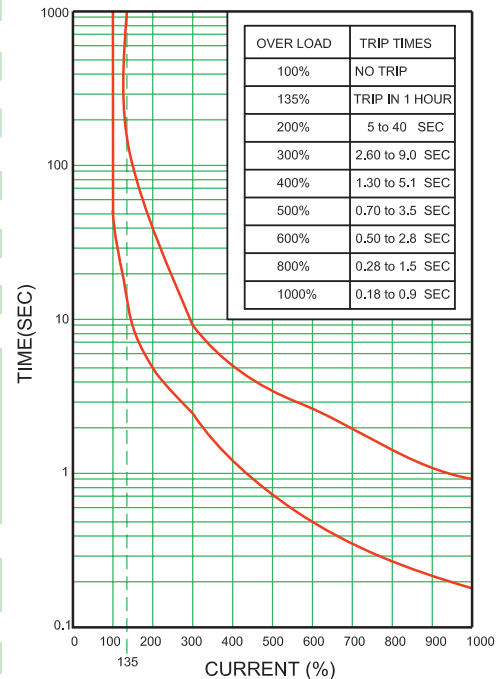

ORDERING INSTRUCTIONS

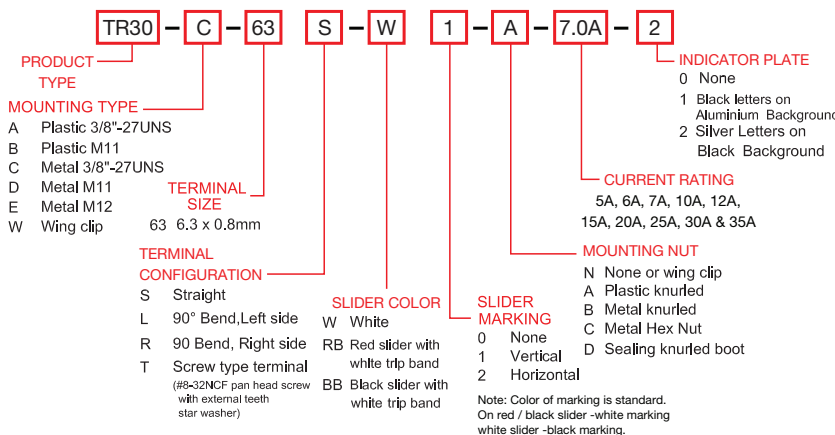

Time Current Characteristics:

The standard characteristic is valid for ambient temperatures of +25°C. If the device is to be used in an ambient temperature other than +25°C, allowances must be made when selecting the current rating according to the following guidelines:

Ambient temp. °C	-5	-0	+10	+20	+25	+30	+40	+50	+60
Multiplication Factor 5A	0.9	0.92	0.95	0.98	1	1.12	1.15	1.25	1.5
Multiplication Factor 5A to 30A	0.9	0.92	0.95	0.98	1	1.05	1.15	1.25	1.35
Multiplication Factor 35A	0.9	0.93	0.95	0.98	1	1.05	1.15	1.25	1.35

Example: Normal Continuous Current 5.0A
Ambient Temperature 40°C
Multiplication Factor 1.15
Selected rated current at +40°C ambient temperature 5 x 1.15 = 5.75
6.0A (nearest)

* SPECIAL ORDER ONLY. Contact Altech for more details.
PCB Mounting and additional Shunt Terminal available, please contact Altech.

TR-30 Dimensions & Mounting Options

Central Mounting

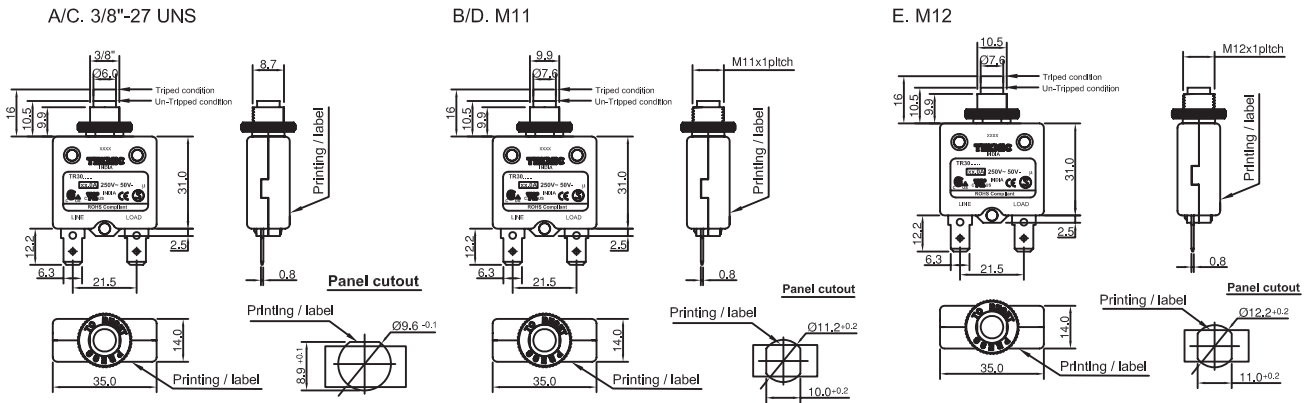

Wing Clips

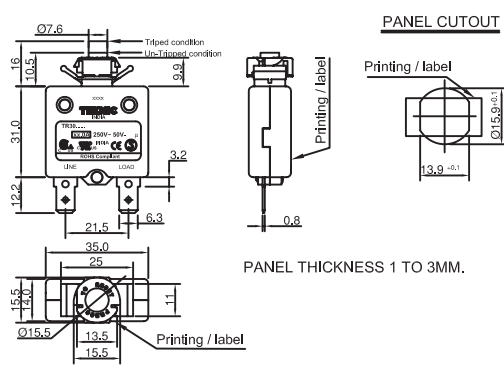

Terminal Options

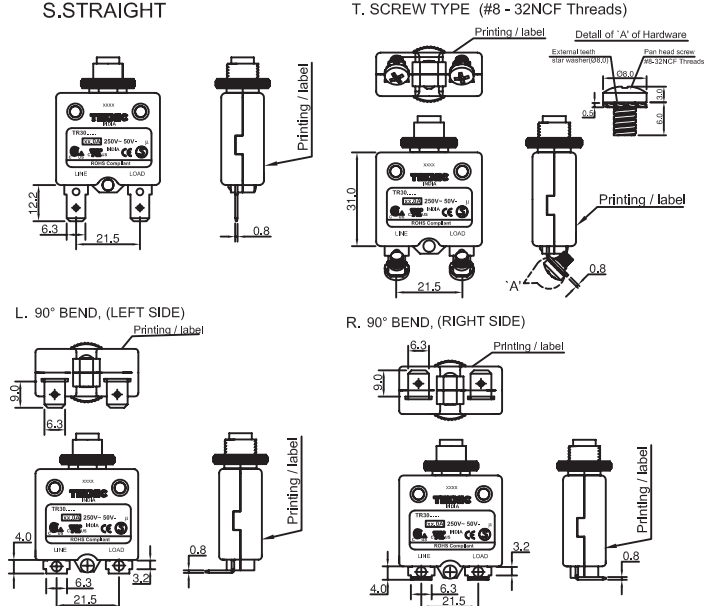

Slider Printing for Current Rating

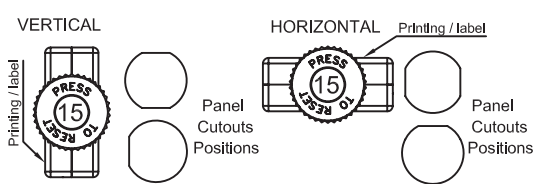

Accessories

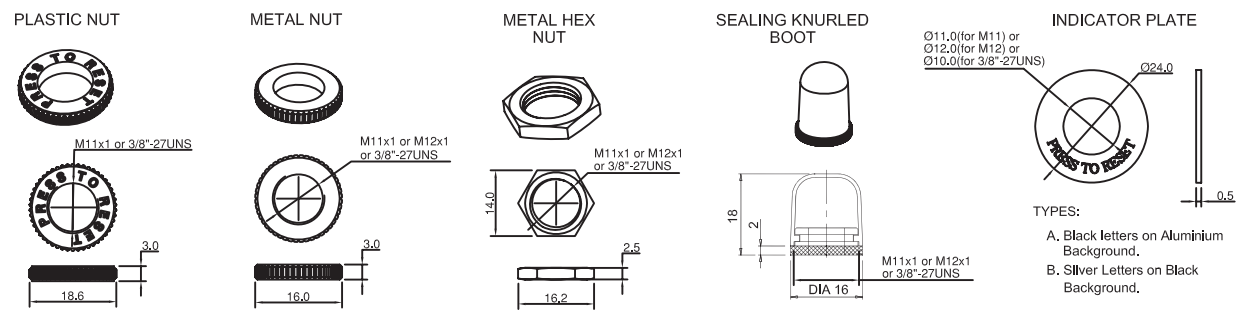

Dimensions in mm (to convert to inches multiply by 0.03937)