



16 - DIN Rail circuit protective devices



OVR Surge protective devices16.1 - 16.28

General information	
Introduction	16.2
General points on lightning and it's risks	16.3
Terminology of SPD electrical characteristics	16.4
UL 1449 Update to 3rd Edition	16.5 - 16.6
OVR NE12 products	
Introduction	16.8
Product Ordering details	16.9 - 16.10
Technical data	16.11
Approximate dimensions	16.12
OVR DIN rail products	
Introduction	16.14
Product Ordering details	16.15 - 16.19
Technical data	16.20 - 16.21
Approximate dimensions	16.22 - 16.24
UL 1449 2nd Edition to 3rd Edition cross-reference	16.25
Photovoltaic surge protection	16.26 - 16.27
Data line surge protection	16.28

F200 Residual current devices16.29 - 16.40

General information	
Description and features	16.29
Ordering details	
F200AC	16.30
F200AC S	16.31
F200A	16.32
F200A AP-R	16.33
F200A S	16.34
Technical data	16.35, 16.40
Application guide	16.37 - 16.39

E90 Fuseholders and fuse disconnectors16.41 - 16.50

General information	
Description	16.41
Ordering details	
E 90 fuse switch disconnectors	16.42 - 16.46
E 90 Class CC fuseholders	16.47
E 930 fuse disconnectors	16.48
E 930 fuseholders	16.49

E210 Command devices16.51 - 16.60

General information	
Description and new features	16.51
Ordering details	
E 210 Switches	16.52 - 16.55
E 210 Pushbuttons with and without LEDs	16.56 - 16.57
E 210 Indicator lights with LEDs	16.58
E 210 Accessories	16.59

Notes

OVR Series Surge protective devices



Surge protective devices

OVR NE12 products

OVR DIN rail products



General information

Introduction

What is a transient surge?

A transient surge is a sudden (shorter than a millisecond) rise in the flow of power. Voltage can peak at 12x the nominal system voltage. Transient surges result from a number of sources, the most common of which are internal, such as load switching and even normal equipment operations. In fact, approximately 80% of transients are generated internally. External transients are the result of lightning and load switching by utilities and upstream facilities.

Internal load switching

Switching on/off any elements that create a sudden variation of load will also cause a sudden change in current flow and generate transient surges.

Lightning strikes

A lightning strike (direct or indirect) can have a destructive or disturbing effect on installations located up to several miles from the actual point of the strike. During a storm, underground cables can transmit energy from a lightning strike to equipment installed inside buildings.

A lightning protection device (such as a lightning rod or Faraday cage) installed on a building to protect against the risk of a direct strike can increase the risk of damage to electrical equipment connected to the main power supply near or inside the building.

The lightning protection device diverts the high strike current to ground, considerably raising the potential of the ground close to the building on which it is installed. This causes overvoltages on the electrical equipment directly via the ground terminals and induced via the underground supply cables.

Switching effects on power distribution

The switching of transformers, motors or inductances in general, variation of load, disconnection of circuit breakers or cut outs lead to overvoltages that penetrate a building. The closer the building is to a generating station, substation or upstream switching point, the higher the overvoltages may be.

Facilities and operations left unprotected are highly susceptible to the damaging effects of transients. Such as:

- Catastrophic equipment failure
- Immediate operation shutdown
- Long term disruption of business
- Expensive equipment repair and replacement
- Data losses, system resets and network down time

In order to ensure protection from transient surges, installation of surge protective devices (SPD) is a must.

ABB has a long history of engineering and manufacturing quality surge protective devices. This brochure will provide all the information needed to select the proper products to begin protecting any facility or operation.

ABB's family of surge protective devices include the following:

- OVR NE12 enclosed SPD for service entrance locations
- OVR DIN rail AC SPD for equipment protection
- OVR PV DIN rail DC SPD for photovoltaic installations
- OVR DIN rail data line SPD for sensitive communications networks



General information

General points on lightning and its risks

Overvoltages due to direct lightning strikes

These can take two forms:

- When lightning strikes a lightning conductor or the roof of a building which is grounded, the lightning current is dissipated into the ground. The impedance of the ground and the current flowing through it create large difference of potential: this is the overvoltage. This overvoltage then propagates throughout the building via the cables, damaging equipment along the way.
- When lightning strikes an overhead low voltage line, the strike produces high currents which penetrate into the building creating large overvoltages. The damage caused by this type of overvoltage is usually catastrophic (e.g. fire in the electrical switchboard causing the destruction of buildings and industrial equipment) and results in explosions.



Direct lightning strike on a lightning conductor or the roof of a building



Direct lightning strike on an overhead line

Overvoltages due to the indirect effects of lightning strikes

Overvoltages are also produced when lightning strikes in the vicinity of a building, due to the increase in potential of the ground at the point of impact. The electromagnetic fields created by the lightning current generate inductive and capacitive coupling, leading to other overvoltages. Within a radius up to several kilometers, the electromagnetic field caused by lightning in clouds can also create sudden increases in voltage.

Although less spectacular than in the previous case, irreparable damage is also caused to sensitive equipment such as fax machines, computer power supplies and safety and communication systems.



Increase in ground potential



Magnetic field



Electrostatic field

General information

Terminology of SPD electrical characteristics

SPD terminology

8/20 wave:

Current waveform which passes through equipment when subjected to an overvoltage (low energy).

Type 2 surge protective device (SPD)

Permanently connected SPDs intended for installation on the load side of the service equipment overcurrent device, including SPDs located at a branch panel. It has successfully passed testing to the standard with the 8/20 wave (class II test).

Metal oxide varistor (MOV)

A varistor is an electronic component with a "diode like" nonlinear current-voltage characteristic, used to protect circuits against excessive transient voltages. Most commonly composed of metal oxides.

Maximum continuous operating voltage (MCOV, U_c)

The maximum designated root mean square (rms) value of power frequency voltage that may be applied continuously between the terminals of the SPD.

Nominal discharge current (I_n)

Peak current value of an 8/20 waveform which the SPD is rated for based on the test program.

Maximum discharge current (I_{max})

Peak current value of an 8/20 waveform which can be safely discharged by the SPD, with an amplitude complying with the class II operating test sequence. $I_{max} > I_n$

Short circuit current rating (SCCR)

Maximum symmetrical fault current, at rated voltage, that the SPD can withstand without sustaining damage that exceeds acceptable criteria or creates a hazardous operating condition.

Voltage protection rating (VPR)

The value of the VPR is determined as the nearest highest value, taken from Table 63.1 of ANSI/UL 1449 3rd Edition, to the measured limiting voltage determined during the transient voltage surge suppression test using the combination wave generator at a setting of 6kV, 3kA.

Voltage protection level (U_p or U_{res})

The voltage let through by the SPD while diverting surge current to ground must not exceed the voltage withstand value of the equipment connected downstream.

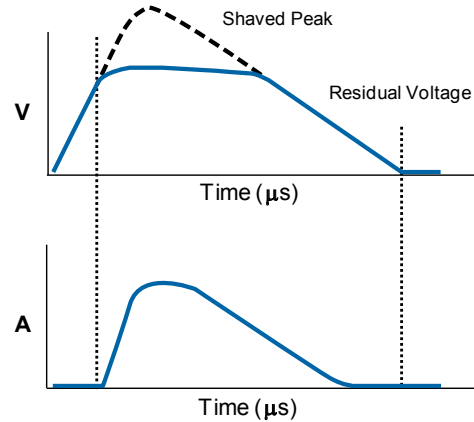

* Graph depicts an 8/20 μ s wave

Notes:

Test wave 8/20 μ s according to IEEE # C62.62-200/UL 1449

The first number corresponds to the time from 10% to 90% of its peak value (8 μ s).

The second number corresponds to the time taken for the wave to descend to 50% of its peak value (20 μ s).

Common mode and / or differential mode protection

Common mode

Common mode overvoltages appear between the live conductors and ground, e.g. phase/ground or neutral/ground. A live conductor not only refers to the phase conductors but also to the neutral conductor.

This overvoltage mode destroys equipment connected to ground (class I equipment) and also equipment not connected to ground (class II equipment) which is located near a grounded mass and which does not have sufficient electrical isolation (a few kilovolts).

Class II equipment not located near a grounded mass is theoretically protected from this type of attack.

Differential mode

Differential mode overvoltages circulate between live conductors: phase/phase or phase/neutral.

These overvoltages have a potentially high damaging effect for all equipment connected to the electrical network, especially 'sensitive' equipment.

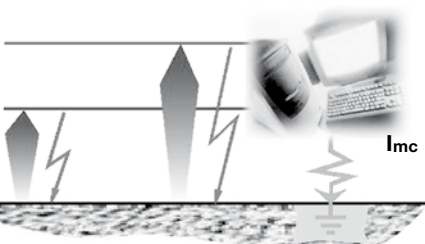

Note:
Common mode overvoltages affect all grounding systems.



General information

UL 1449 Update to 3rd Edition

Surge Protective
Devices

The Underwriters Laboratories (UL) standard for surge protective devices (SPDs) has been the primary safety standard for surge protection since the first edition was published in 1985, and updated to the second edition in 1996.

The objective of UL 1449 has always been to increase safety in terms of surge protection. Thus, major changes have recently been made to the surge protection standard.

The latest edition, known as UL 1449 3rd Edition, was published on September 29, 2006 and took effect September 2009, and is now also an ANSI standard. A revision was made on February 8, 2011.

To avoid confusion, the objective of this paper is to explain and summarize the major changes made to the standard.

The key updates are:

- Change in the standard's name
- The different type designations of surge protective devices
- The measured voltage protection level
- The Nominal discharge current

Change in the standard's name: From TVSS to SPDs

Prior to UL 1449 3rd Edition taking effect, the devices this standard covers were known as Transient Voltage Surge Suppressors (TVSS), operating on power circuits not exceeding 600 V. With the inception of the 3rd Edition, these devices are now known as Surge Protective Devices (SPDs), and may operate on power circuits not exceeding 1000 V.

This new designation moves the UL standard closer to the international designation and to IEC standards. The new edition is now renamed UL Standard for Safety for Surge Protective Devices, UL 1449.

The different type designations of surge protective devices

The new UL 1449 3rd Edition places SPDs into five different Type categories based on installation location within an electrical system. While Type 1, Type 2 and Type 3 categories refer to different types of SPDs that can be installed at specific locations, Type 4 and Type 5 categories refer to components used in an SPDs configuration.

Type 1 – “Permanently connected SPDs intended for installation between the secondary of the service transformer and the line side of the service equipment overcurrent device.”

Type 2 – “Permanently connected SPDs intended for installation on the load side of the service equipment overcurrent device.”



Type 3 – “Point of utilization SPDs, installed at a minimum conductor length of 10 meters (30 feet) from the electrical service panel.”

Type 4 – Component assemblies – “Component assembly consisting of one or more Type 5 components together with a disconnect (integral or external) or a means of complying with the limited current tests.”

Type 1, 2, 3 – Component assemblies – “Consists of a Type 4 component assembly with internal or external short circuit protection.”

Type 5 – “Discrete component surge suppressors, such as MOVs that may be mounted on a PWB, connected by its leads or provided within an enclosure with mounting means and wiring terminations.”

These new categories are by far the major changes applied to UL 1449 3rd Edition. SPDs installation location is now taken into account. The closer an SPD is installed to the equipment, the better the protection is. This is a push in the direction of providing stepped protection including external and internal surge protection.

The measured voltage protection level

One of the last changes found in the new UL 1449 3rd Edition, is the modification in the measured voltage protection level. The Measured Limiting Voltage (MLV) is the maximum magnitude of voltage measured at the application of a specific impulse wave shape.

When applying a certain surge current on the SPD the measured voltage at the device terminals is the so called “let-through voltage.” In UL 1449 2nd Edition, the let-through voltage was referred to as Suppressed Voltage Rating (SVR) and was calculated with a 0.5 kA surge wave form at 6 kV. The new designation is Voltage Protection Rating (VPR) and is calculated with a 3 kA surge wave form at 6 kV.

General information

Terminology of SPD electrical characteristics



The nominal discharge current: I_n

The nominal discharge current, known as I_n test, is new to UL 1449, coming from the IEC standard.

During the test, the SPD is subjected to 15 impulses at the selected nominal discharge current. In order to pass, the SPD cannot create a shock or fire hazard during the test, and nothing in the surge path can open during or after the test. The nominal discharge current values, with a 8/20 μ s wave shape, are selected by the manufacturer as follows:

Type 1: 10 or 20 kA

Type 2: 3, 5, 10 or 20 kA

Type 1, Type 2 and Type 4 SPDs (intended for Type 1 or Type 2 applications) are subjected to this test.

Sources: Underwriters Laboratories Inc., Standard for Safety, Surge Protective Devices (UL 1449 Third Edition, 2011)

The MLV will allow comparison of different types of SPDs with regards to the let-through voltage. However, it is important to note that the surge current used to measure the let-through voltage is six times higher in the 3rd Edition than in the 2nd Edition. This means that, comparing the obsolete SVR designation with the new VPR ratings will not be valid, as VPR ratings will of course be higher than SVR ratings.

OVR Series NE12 products



Product introduction

OVR NE12 enclosed SPD

Introduction

The OVR NE12 enclosed surge protective device (SPD) is the latest addition to ABB's extensive range of surge protection products. It is designed to be installed at the service entrance, thereby protecting the entire facility from the harmful effects of transient surges. These surges are the result of:

- Direct and indirect lightning strikes
- Power company load switching
- Upstream load switching at other facilities

Extensive damage and expensive repairs can result from these types of disturbances if surge protection is not present.

Features & benefits

The OVR NE12 is a multistage protector with fast acting varistor (MOV) and EMI/RFI noise attenuation filter to limit overvoltage to values compatible with the sensitive equipment connected to the network. In addition to the OVR NE12, ABB recommends adding OVR DIN rail SPDs at branch panels and equipment, creating a multi-level approach to protection.

General

- NEMA 12 enclosure
- All mode protection (L-L/L-N/L-G/N-G)
- Auxiliary contacts for remote monitoring
- Safety disconnect, fused
- LED power on/fault indicator
- Audible alarm

MOV technology

- 160kA or 320kA per phase
- Replaceable MOV blocks
- Visual and audible MOV replacement indication

Surge counter/diagnostic LCD display (optional)

- Count of surges 2kA and higher with time and date
- Visual diagnostic information

Applications

The OVR NE12 is suitable for protection for all manner of facilities and operations. It is designed with a NEMA Type 12 enclosure, and rated as a Type 2 SPD, requiring indoor installation on the load side of the main breaker or fuse.

Here are some examples of operations that would benefit from an OVR NE12 enclosed SPD:

- Critical power (hospitals, data centers, etc)
- Renewable energy
- Water/wastewater
- Communications
- Manufacturing
- Commercial

Specifications

- **Approvals: UL 1449 - 3rd Edition Listed, UL 1283, CSA 22.2 No. 8**
- Type 2 Surge Protective Device
- NEMA 12 enclosure
- Three service voltages (AC): 240/120V Split phase, 480V Delta and 480/277V Wye
- 160kA or 320kA per phase protection
- Short circuit current rating (SCCR): 200kA

ABB recommends the installation of the OVR NE12 enclosed SPD wherever uptime is a critical element of a facility or operation.



Product selection

OVR NE12 enclosed SPD

Choosing the correct model

There are three steps to choosing the correct OVR NE12 model:

1) Select service voltage

Consult qualified personnel if the facility or operation service voltage is unknown.

The OVR NE12 is available in three service voltages:

- 480V Delta
- 480Y/277V
- 240/120V Split phase

2) Select the surge capacity (I_{max})

The surge capacity is the maximum discharge current (I_{max}) per phase. Each MOV is capable of withstanding multiple surges below the maximum surge level.

Two protection levels are available:

- 160kA per phase
- 320kA per phase

3) Choose a basic display or the surge counter/diagnostic LCD display

- Basic display: LED lights and alarm
- Surge counter/diagnostic LCD display: LED lights, alarm and LCD screen displaying percentage protection level, surge count and last surge date

Once these three steps are complete, consult the tables below and on Page 16.10 to select

the unit. If technical assistance is required, please call ABB Technical Support at (888) 385-1221 option #4.



OVR NE12 enclosed SPD part number diagram

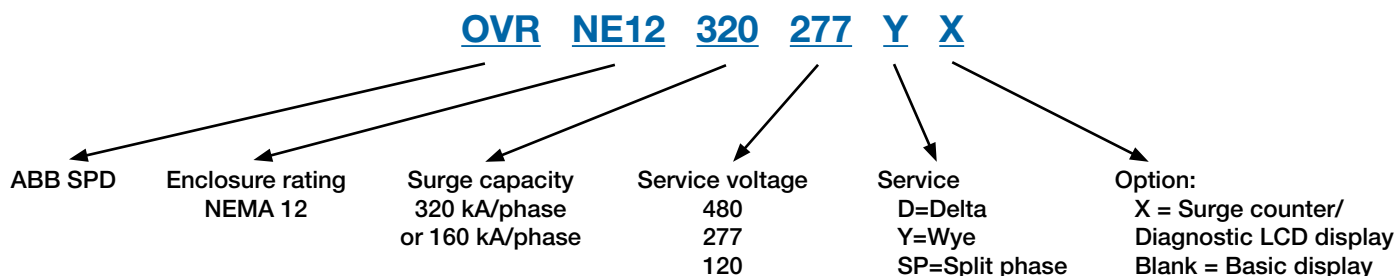

Designation	Service voltage	Features		
		Default visualization Green/red LED	Audible alarm	Surge counter
OVR NE12 320 480D X	480V Delta	Yes	Yes	Yes
OVR NE12 160 480D X	480V Delta	Yes	Yes	Yes
OVR NE12 320 277Y X	480Y/277V	Yes	Yes	Yes
OVR NE12 160 277Y X	480Y/277V	Yes	Yes	Yes
OVR NE12 320 120SP X	240/120V Split phase	Yes	Yes	Yes
OVR NE12 160 120SP X	240/120V Split phase	Yes	Yes	Yes
OVR NE12 320 480D	480V Delta	Yes	Yes	No
OVR NE12 160 480D	480V Delta	Yes	Yes	No
OVR NE12 320 277Y	480Y/277V	Yes	Yes	No
OVR NE12 160 277Y	480Y/277V	Yes	Yes	No
OVR NE12 320 120SP	240/120V Split phase	Yes	Yes	No
OVR NE12 160 120SP	240/120V Split phase	Yes	Yes	No

Product selection

OVR NE12 enclosed SPD

OVR NE12 enclosed SPD

Surge capacity per phase kA	Service voltage	Catalog number	Description
320	480V Delta	OVRNE12320480DX	OVR NE12 enclosed SPD, 480V Delta, 320kA, w/ Surge counter
		OVRNE12320480D	OVR NE12 enclosed SPD, 480V Delta, 320kA
	480Y/277V	OVRNE12320277YX	OVR NE12 enclosed SPD, 480Y/277V, 320kA, w/ Surge counter
		OVRNE12320277Y	OVR NE12 enclosed SPD, 480Y/277V, 320kA
	240/120V SP	OVRNE12320120SPX	OVR NE12 enclosed SPD, 240/120V Split phase, 320kA, w/ Surge counter
		OVRNE12320120SP	OVR NE12 enclosed SPD, 240/120V Split Phase, 320kA
160	480V Delta	OVRNE12160480DX	OVR NE12 enclosed SPD, 480V Delta, 160kA, w/ Surge counter
		OVRNE12160480D	OVR NE12 enclosed SPD, 480V Delta, 160kA
	480Y/277V	OVRNE12160277YX	OVR NE12 enclosed SPD, 480Y/277V, 160kA, w/ Surge counter
		OVRNE12160277Y	OVR NE12 enclosed SPD, 480Y/277V, 160kA
	240/120V SP	OVRNE12160120SPX	OVR NE12 enclosed SPD, 240/120V Split phase, 160kA, w/ Surge counter
		OVRNE12160120SP	OVR NE12 enclosed SPD, 240/120V Split phase, 160kA

Replacement power supply and MOV block ¹⁾

Surge capacity kA	Service voltage	Catalog number	Description
160	480V Delta	OVR1N160480PS	OVR NE12 Power supply, 480V Delta, 160kA
		OVR1N160480	OVR NE12 MOV, 480V Delta, 160kA
	480Y/277V	OVR1N160277PS	OVR NE12 Power supply, 480Y/277V, 160kA
		OVR1N160277	OVR NE12 MOV, 480Y/277V, 160kA
	240/120V SP	OVR1N160120PS	OVR NE12 Power supply, 240/120V split phase, 160kA
		OVR1N160120	OVR NE12 MOV, 240/120V split phase, 160kA

¹⁾ Consult the OVR NE12 installation and operation manual (document number 1SXU430222M0201) for power supply and MOV block replacement instructions

Service parts and accessories

Description	Catalog number	Extended description
3P SW 100A J FUSE 600V*	OS100GJ03	Fusible disconnect switch - 480V Delta and 240/120V split phase
3P+N SW 100A J FUSE 600V*	OS100GJ04N2	Fusible disconnect switch - 480Y/277V
PSTL HDL 6X65MM BLACK	OHB65J6	Enclosure door handle for fusible disconnect switch
PSTL SHAFT 6X150MM	OXp6X150	Metal shaft for fusible disconnect switch
3P LUG KIT 100A FUSED (6 LUGS)	OZXA-24	Terminal lug kit
WALL MOUNTING BRACKETS (4)	AA1206	Enclosure mounting brackets

* Fuses by others (Type J 100A)

Technical data

OVR NE12 enclosed SPD

Surge Protective
Devices

		OVRNE12320480DX OVRNE12320480D OVRNE12160480DX OVRNE12160480D	OVRNE12320277YX OVRNE12320277Y OVRNE12160277YX OVRNE12160277Y	OVRNE12320120SPX OVRNE12320120SP OVRNE12160120SPX OVRNE12160120SP
Technical characteristics				
Service voltage		480V Delta	480/277V Wye	240/120V Split phase
Application		Service entrance	Service entrance	Service entrance
Phases		3	3	2
Mode of protection		L-L / L-N / L-G / N-G	L-L / L-N / L-G / N-G	L-L / L-N / L-G / N-G
Surge capacity/phase (I_{max})	kA	160 or 320	160 or 320	160 or 320
Maximum continuous operating voltage (MCOV)	V	550	320	150
Voltage protection rating (VPR - UL 3rd Ed.)				
L-N	V	/	1200	900
L-L	V	1800	2000	1200
L-G	V	1800	1200	800
N-G	V	/	1200	800
Nominal discharge current (I_n)	kA	10	10	10
Short circuit current rating (SCCR)	kA	200	200	200
AC power frequency	Hz	50-60	50-60	50-60
Thermal fuse		Type J 100A	Type J 100A	Type J 100A
EMI/RFI filtering	dB	-30	-30	-30
Mechanical characteristics				
Connection terminals	Inches	1/4 - 5/16 - 3/8 - 1/2	1/4 - 5/16 - 3/8 - 1/2	1/4 - 5/16 - 3/8 - 1/2
Terminal torque	Nm	6-75	6-75	6-75
Auxiliary contact connection terminals	AWG	22 - 12	22 - 12	22 - 12
Auxiliary contact terminal torque	Nm	1	1	1
Front display		Yes	Yes	Yes
LED indicators		Yes	Yes	Yes
Audible alarm		Yes	Yes	Yes
Auxiliary contact		Yes	Yes	Yes
Surge counter		Yes - Option "X"	Yes - Option "X"	Yes - Option "X"
Enclosure material		Painted steel	Painted steel	Painted steel
Enclosure rating		NEMA 12	NEMA 12	NEMA 12
Dimensions H x W x D (approx.)	Inches	24" x 16" x 8"	24" x 16" x 8"	24" x 16" x 8"
Weight (approx.)	lbs	40	40	40
Miscellaneous characteristics				
Stocking temperature		32°F (0°C) to 104°F (40°C)	32°F (0°C) to 104°F (40°C)	32°F (0°C) to 104°F (40°C)
Operating temperature		32°F (0°C) to 104°F (40°C)	32°F (0°C) to 104°F (40°C)	32°F (0°C) to 104°F (40°C)
Maximum altitude		6600 feet (2000 m)	6600 feet (2000 m)	6600 feet (2000 m)
Fire resistance according to UL 94		V0	V0	V0
Approvals		ANSI/UL 1449 3rd Ed. Meets IEEE requirements	ANSI/UL 1449 3rd Ed. Meets IEEE requirements	ANSI/UL 1449 3rd Ed. Meets IEEE requirements
Replacement MOV block				
		OVR1N160480PS (power supply) OVR1N160480	OVR1N160277PS (power supply) OVR1N160277	OVR1N160120PS (power supply) OVR1N160120

Approximate dimensions OVR NE12 enclosed SPD

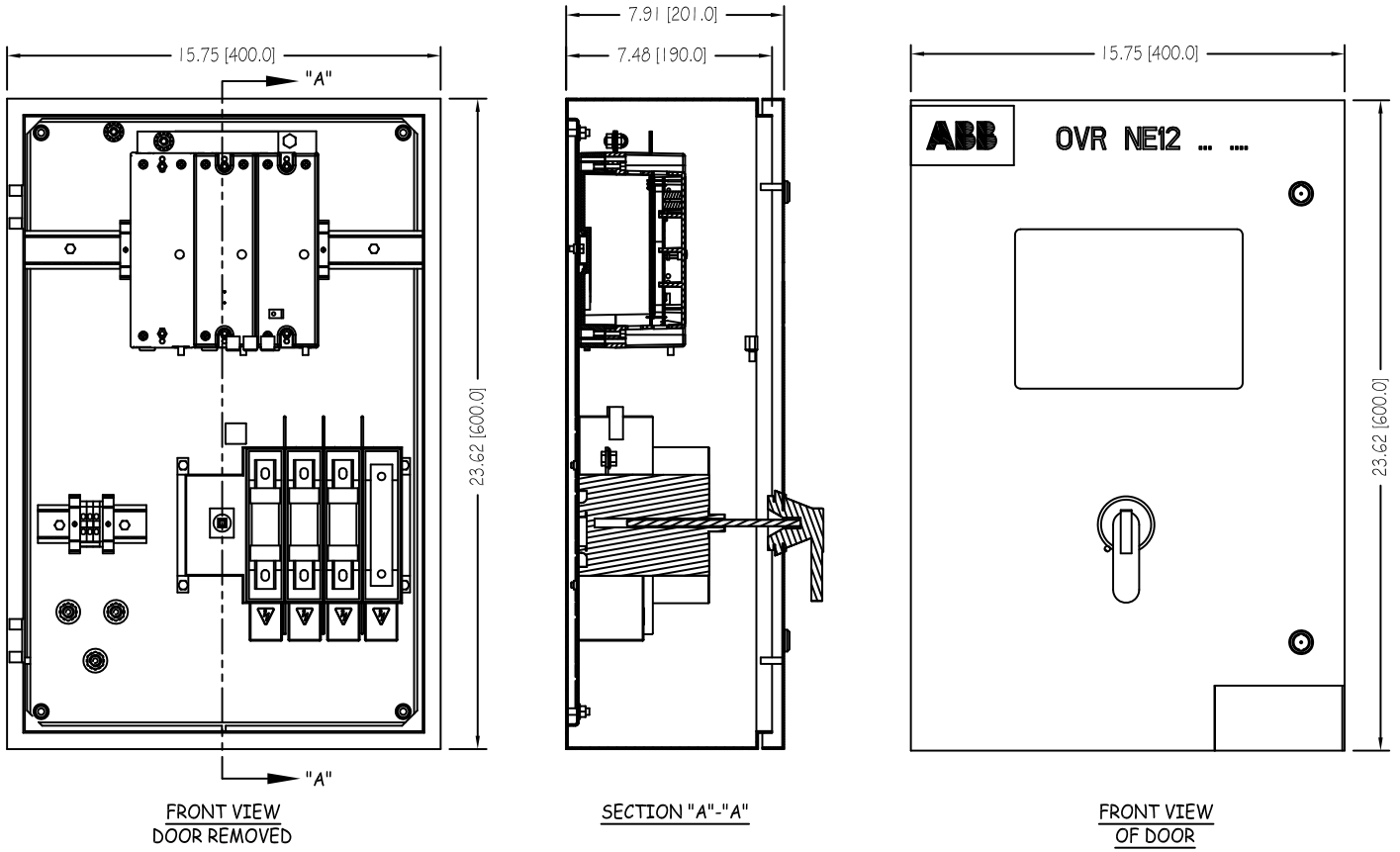



OVR Series DIN rail products



Product introduction

OVR DIN rail SPD

Introduction

Over 80% of transient surges are caused by internal sources such as load switching and normal equipment operations. The installation of ABB OVR UL 1449 3rd Edition pluggable AC DIN rail SPDs will combat these surges and provide protection to valuable equipment and help keep an operation up and running. This new product range is approved as Type 4 recognized components and is usable in Type 2 applications. These products are of the same high quality as ABB UL 1449 2nd Edition devices, with improved safety as a result of additional testing required by the UL 1449 3rd Edition standard. Installation at branch panels, control panels and terminal equipment is recommended to provide the most complete protection.

Features & benefits

The OVR DIN rail SPDs utilize fast acting metal oxide varistor (MOV) technology to limit overvoltage to values compatible with the sensitive equipment connected to the network.

End of life indicator

This feature is standard on all ABB pluggable OVR DIN rail surge protectors. Each cartridge is equipped with a mechanical indicator which is green when the SPD is operational and protecting the system, and turns red when it has reached end of life. When this occurs, the cartridge must be replaced to guarantee protection.

End-of-life indicator



NOTE: A surge protector that has reached end of life does not interrupt service, it simply disconnects itself, and the system is no longer protected.

Pluggable

The ability to efficiently maintain equipment is a key focus topic for industrial facilities. For this reason, ABB OVR DIN rail SPDs (excluding data line products) now utilize pluggable cartridges. Should one or more cartridges reach end of life, the electrical circuit does not have to be isolated, nor does the whole device have to be removed. Simply pull the dead cartridge from its housing and plug in a new one.



NOTE: Pluggable surge protector cartridges are equipped with a "key" matched to each part number base, preventing incorrect replacements.

Remote indication (Optional - "TS" designation)

This function, achieved by wiring an integrated 3-point 1A volt-free contact, enables the operational state of the SPD to be monitored remotely.

Technical features of the remote indicator

- 1 NO (normally open) contact and 1 NC (normally closed) contact
- Min. load: 12 VDC - 10 mA
- Max. load: 250 VAC - 1 A
- Connection cross section: 1.5 mm² (16 AWG)

Specifications

- **UL 1449 3rd Edition - Type 4 Recognized Component**
- I_{max} - 15kA and 40kA
- Maximum continuous operating voltage (U_c) - 175, 320, 440, 550 and 660 VAC
- Configuration - 1L, 2L, 3L, N, 1N, 2N, 3N

ABB recommends a multi-level approach to surge protection. Combining OVR DIN rail SPDs with the OVR NE12 enclosed SPD will ensure the facility or operation is fully protected.

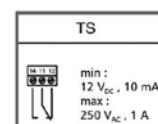

Wiring schematic
Remote indication contact



Surge protector fitted with
the remote indication option



Product selection

OVR DIN rail SPD

Choosing the correct model

1) Determine the service voltage

Consult qualified personnel if the facility or operation service voltage is unknown.

2) Select the SPD maximum continuous operating voltage (MCOV, U_c)

The MCOV should correspond to the service voltage.

Example: If the service voltage is 480V Delta, an SPD with 550V or 660V MCOV will be required.

Surge protection devices must also provide a level of protection compatible with the withstand voltage of the equipment. This withstand voltage depends on the type of equipment and its sensitivity. The incoming surge protector may not provide adequate protection by itself, as certain electrical phenomena may greatly increase its residual voltage if cable lengths exceed 10m. A second SPD may be necessary. See Coordination below.

3) Select the SPD surge capacity (I_{max})

Surge capacity is the amount of energy the SPD can withstand from a single surge event. The higher the surge capacity, the longer the device will protect the system. A second surge protector may be required if the surge capacity of the first is not capable of diverting all surge current to ground. See Coordination below.

4) Remote monitoring (Optional)

Integrated auxiliary contact for remote monitoring available on models with "TS" designation.

Consult the Service Voltage and Location table on page 16.16 for help in the selection of SPDs.

OVR DIN rail SPD - Part number diagram

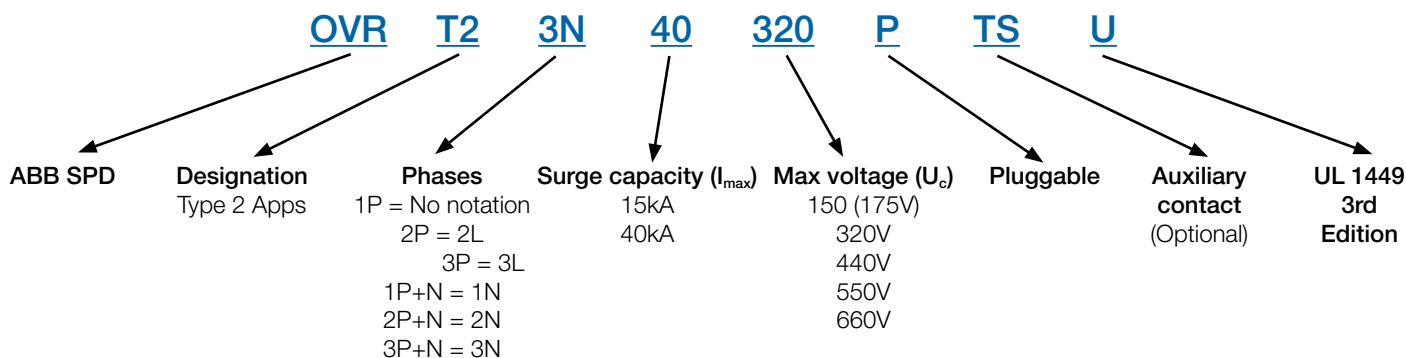

Complete facility protection

Installing surge protection at the main distribution panel is only the beginning of protecting the entire operation. As most transient surges are created internally, it is necessary to install surge protection at sub-distribution panels (equipment protection) to be fully protected. Stepping down the I_{max} level from the service entrance panel toward equipment to be protected is recommended.

For example, if a 40kA I_{max} SPD is installed in the main distribution panel, then 15kA I_{max} SPDs should be installed in sub-distribution panels for equipment protection.

Coordination

It may be necessary to add a second surge protector, wired to the incoming unit, to achieve the required voltage protection and/or surge capacity. For Type 2 or 4 SPDs, installing this second unit a minimum of 1m from the first unit will allow the two to work together, achieving the required protection.

Wiring rules

The impedance of the cables increases the voltage across the connected equipment. Therefore, the length of the cable between the surge protector and the equipment should be minimized.

The surge protective device should be installed as close to the equipment to be protected as possible. If this is not possible (the equipment is over 30m from the panel), then a second surge protector must be installed.

Product selection

Service voltage and location

Service voltage and location

Network	Service voltage	Number of wires	Service entrance	Main distribution panel	Sub-distribution panel
			OVR NE12 enclosed SPD	OVR DIN rail SPD	OVR DIN rail SPD
Delta	240/120V HLD	4W+G	----	OVRT23N40320PTSU	OVRT23N15320PU
	240V	3W+G	----	OVRT23L40320PTSU	OVRT23L15320PU
	480V	3W+G	OVRNE12320480D(X) OVRNE12160480D(X)	OVRT23L40550PTSU	OVRT23L40550PTSU
	600V	3W+G	----	3 x OVRT240660PTSU	3 x OVRT240660PTSU
Single phase	120V	2W+G	----	OVRT21N40150PTSU	OVRT21N15150PU
	240V	2W+G	----	OVRT21N40320PTSU	OVRT21N15320PU
	277V	2W+G	----	OVRT21N40320PTSU	OVRT21N15320PU
Split phase	240/120V	3W+G	OVRNE12320120SP(X) OVRNE12160120SP(X)	OVRT22N40150PTSU	OVRT22N15150PU
	480/240V	3W+G	----	OVRT22N40320PTSU	OVRT22N15320PU
Wye	208/120V	4W+G	----	OVRT23N40150PTSU	OVRT23N15150PU
	480/277V	4W+G	OVRNE12320277Y(X) OVRNE12160277Y(X)	OVRT23N40320PTSU	OVRT23N15320PU
	600/347V	4W+G	----	OVRT23N40440PTSU	OVRT23N40440PTSU

General wiring diagrams - DIN rail devices

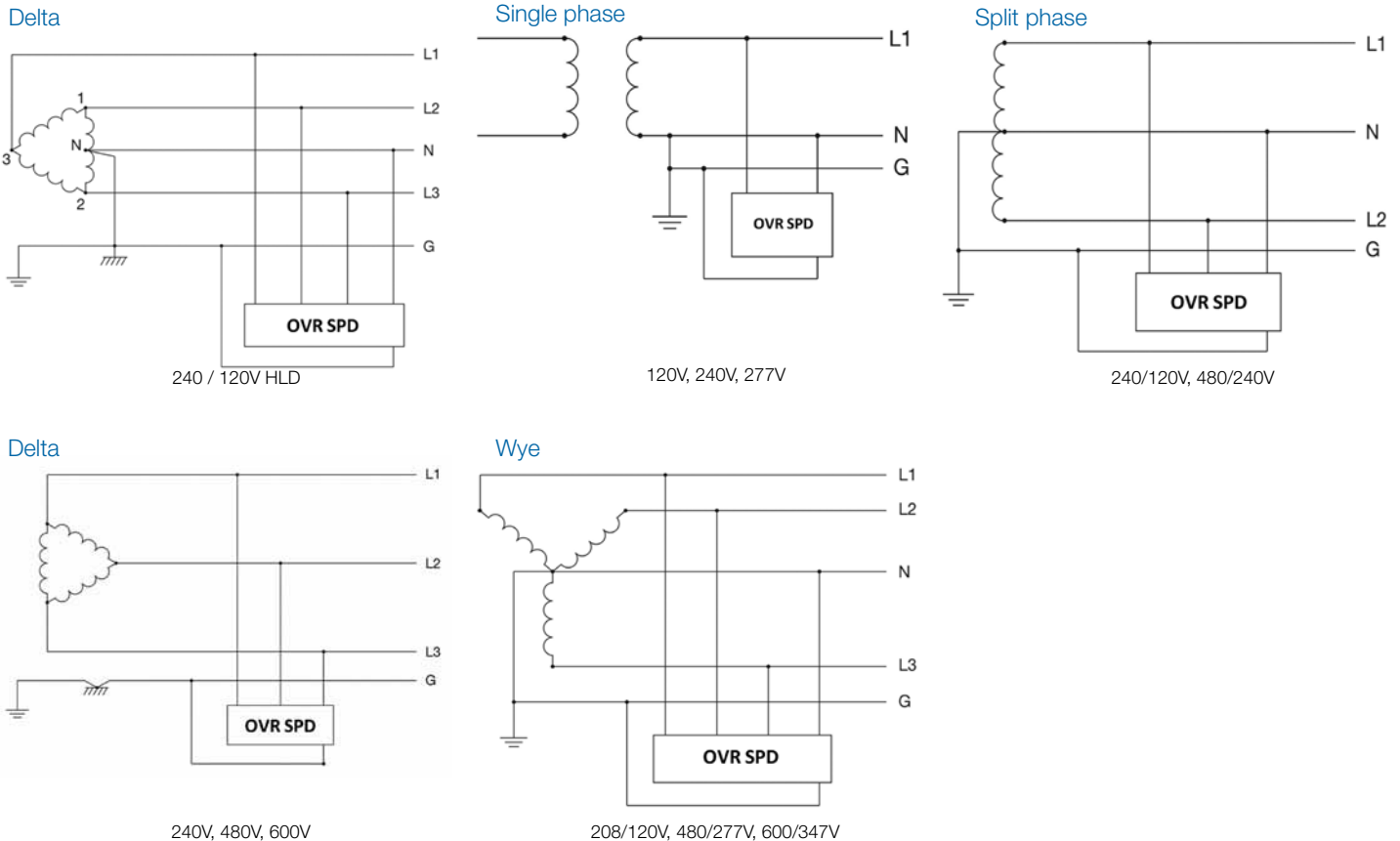

NOTE: Multiple pole SPDs shown. Wiring diagrams for reference only.

Product selection OVR DIN rail SPD

Surge Protective
Devices

Consult the Service Voltage and Location table on page 16.16 for proper SPD selection. The following tables also present information on service voltage compatibility. Please note that multiple SPDs may be required depending on service voltage. Contact ABB Technical Support with any questions.

One pole

Catalog number	Service voltage ¹⁾	Max. discharge current (I_{max} , 8/20 μ s, kA)	Aux. contact - remote monitoring	Replacement cartridge
OVRT215150PU	120V Single Phase, 240/120V Split Phase, 208/120V Wye	15	No	OVRT215150CU
OVRT215320PU	240/120V HLD, 240V Delta, 240V Single Phase, 277V Single Phase, 480/240V Split Phase, 480/277V Wye	15	No	OVRT215320CU
OVRT240150PU	120V Single Phase, 240/120V Split Phase, 208/120V Wye	40	No	OVRT240150CU
OVRT240150PTSU	120V Single Phase, 240/120V Split Phase, 208/120V Wye	40	Yes	OVRT240150CU
OVRT240320PU	240/120V HLD, 240V Delta, 240V Single Phase, 277V Single Phase, 480/240V Split Phase, 480/277V Wye	40	No	OVRT240320CU
OVRT240320PTSU	240/120V HLD, 240V Delta, 240V Single Phase, 277V Single Phase, 480/240V Split Phase, 480/277V Wye	40	Yes	OVRT240320CU
OVRT240440PTSU	600/347V Wye	40	Yes	OVRT240440CU
OVRT240550PTSU	480V Delta	40	Yes	OVRT240550CU
OVRT240660PTSU	600V Delta	40	Yes	OVRT240660CU

1) May require multiple SPDs

Two pole

Catalog number	Service voltage ¹⁾	Max. discharge current (I_{max} , 8/20 μ s, kA)	Aux. contact - remote monitoring	Replacement cartridge ²⁾
OVRT22L15150PU	120V Single phase, 240/120V Split phase, 208/120V Wye	15	No	OVRT215150CU
OVRT22L15320PU	240/120V HLD, 240V Delta, 240V Single phase, 277V Single phase, 480/240V Split phase, 480/277V Wye	15	No	OVRT215320CU
OVRT22L40150PTSU	120V Single phase, 240/120V Split phase, 208/120V Wye	40	Yes	OVRT240150CU
OVRT22L40320PTSU	240/120V HLD, 240V Delta, 240V Single phase, 277V Single phase, 480/240V Split phase, 480/277V Wye	40	Yes	OVRT240320CU

1) May require multiple SPDs

2) May require up to two replacement cartridges

Three pole

Catalog number	Service voltage ¹⁾	Max. discharge current (I_{max} , 8/20 μ s, kA)	Aux. contact - remote monitoring	Replacement cartridge ²⁾
OVRT23L15150PU	240/120V Split phase, 208/120V Wye	15	No	OVRT215150CU
OVRT23L15320PU	240/120V HLD, 240V Delta, 480/240V Split phase, 480/277V Wye	15	No	OVRT215320CU
OVRT23L40150PTSU	240/120V Split phase, 208/120V Wye	40	Yes	OVRT240150CU
OVRT23L40320PTSU	240/120V HLD, 240V Delta, 480/240V Split phase, 480/277V Wye	40	Yes	OVRT240320CU
OVRT23L40440PTSU	240V Delta, 480/240V Split phase, 600/347V Wye	40	Yes	OVRT240440CU
OVRT23L40550PTSU	480V Delta	40	Yes	OVRT240550CU

1) May require multiple SPDs

2) May require up to three replacement cartridges

16

Product selection

OV R DIN rail SPD

One pole + neutral

Catalog number	Service voltage ¹⁾	Max. discharge current (I_{max} , 8/20 μ s, kA)	Aux. contact - remote monitoring	Replacement cartridge ²⁾
OVRT21N15150PU	120V Single phase, 240/120V Split phase, 208/120V Wye	15	No	OVRT215150CU, OVRT270NCU
OVRT21N15320PU	240/120V HLD, 240V Single phase, 277V Single phase, 480/240V Split phase, 480/277V Wye	15	No	OVRT215320CU, OVRT270NCU
OVRT21N40150PTSU	120V Single phase, 240/120V Split phase, 208/120V Wye	40	Yes	OVRT240150CU, OVRT270NCU
OVRT21N40320PTSU	240/120V HLD, 240V Single phase, 277V Single phase, 480/240V Split phase, 480/277V Wye	40	Yes	OVRT240320CU, OVRT270NCU
OVRT21N40440PTSU	600/347V Wye	40	Yes	OVRT240440CU, OVRT270NCU
OVRT21N40550PTSU	600/347V Wye	40	Yes	OVRT240550CU, OVRT270NCU
OVRT21N40660PTSU	600/347V Wye	40	Yes	OVRT240660CU, OVRT270NCU

1) May require multiple SPDs

2) May require up to one phase and one neutral replacement cartridges

Two pole + neutral

Catalog number	Service voltage ¹⁾	Max. discharge current (I_{max} , 8/20 μ s, kA)	Aux. contact - remote monitoring	Replacement cartridge ²⁾
OVRT22N15150PU	240/120V Split phase, 208/120V Wye	15	No	OVRT215150CU, OVRT270NCU
OVRT22N15320PU	240/120V HLD, 480/240V Split phase, 480/277V Wye	15	No	OVRT215320CU, OVRT270NCU
OVRT22N40150PTSU	240/120V Split phase, 208/120V Wye	40	Yes	OVRT240150CU, OVRT270NCU
OVRT22N40320PTSU	240/120V HLD, 480/240V Split phase, 480/277V Wye	40	Yes	OVRT240320CU, OVRT270NCU
OVRT22N40440PTSU	600/347V Wye	40	Yes	OVRT240440CU, OVRT270NCU
OVRT22N40550PTSU	600/347V Wye	40	Yes	OVRT240550CU, OVRT270NCU
OVRT22N40660PTSU	600/347V Wye	40	Yes	OVRT240660CU, OVRT270NCU

1) May require multiple SPDs

2) May require up to two phase and one neutral replacement cartridges.

Product selection

OVR DIN rail SPD

Surge Protective
Devices

Three pole + neutral

Catalog number	Service voltage	Max. discharge current (I_{max} , 8/20 μ s, kA)	Aux. contact - remote monitoring	Replacement cartridge ¹⁾
OVRT23N15150PU	208/120V Wye	15	No	OVRT215150CU OVRT270NCU
OVRT23N15320PU	480/277V Wye, 240/120V HLD	15	No	OVRT215320CU OVRT270NCU
OVRT23N40150PTSU	208/120V Wye	40	Yes	OVRT240150CU OVRT270NCU
OVRT23N40320PTSU	480/277V Wye, 240/120V HLD	40	Yes	OVRT240320CU OVRT270NCU
OVRT23N40440PTSU	600/347V Wye	40	Yes	OVRT240440CU OVRT270NCU
OVRT23N40550PTSU	600/347V Wye	40	Yes	OVRT240550CU OVRT270NCU
OVRT23N40660PTSU	600/347V Wye	40	Yes	OVRT240660CU OVRT270NCU

1) May require up to three phase and one neutral replacement cartridges

Neutral

Catalog number	Service voltage	Max. discharge current (I_{max} , 8/20 μ s, kA)	Aux. contact - remote monitoring	Replacement cartridge
OVRT270NPU	HLD, Single Phase, Split Phase and Wye	70	No	OVRT270NCU

Replacement cartridges

Catalog number
OVRT215150CU
OVRT215320CU
OVRT240150CU
OVRT240320CU
OVRT240440CU
OVRT240550CU
OVRT240660CU
OVRT270NCU

NOTE: These replacement cartridges are usable only with the new OVR DIN rail product range shown in this brochure.

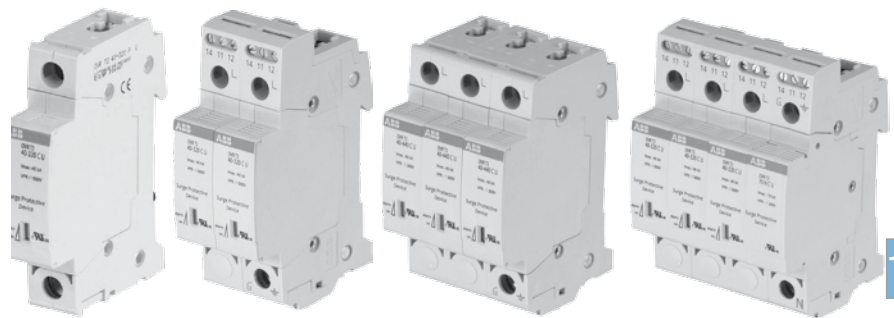

16

Technical data

OVR DIN rail SPD

Electrical characteristics

Type / Test class

UL 1449 3rd Ed. - Type 4 for Type 2
apps

IEC 61 643-1 2nd Ed - T2 / II

Frequency	Hz	50-60
Response time	ns	<25
Operating current (I_o)	mA	<0.1
Short circuit withstand current (I_{scst})	kA	200
Integrated thermal disconnecter		Yes
State indicator		Yes
Safety reserve		No
Remote indicator		Optional
Disconnecter	Circuit breaker - B or C curve	A ≤125
	Class J fuse	A ≤100

Mechanical characteristics

Wire range - solid wire	AWG	4-14
Wire range - stranded wire	AWG	6-14
Stripping length	in	0.5
Tightening torque	in-lbs	24.5
Degree of protection		NEMA 1

Remote indicator (Optional)

Type of contact		1 NO / 1 NC
Minimum load		12 VDC / 10 mA
Maximum load		250 VAC / 1 A
Connection cross section	AWG	16

Miscellaneous characteristics

Operating temperature	F	-40° to 176°
Maximum altitude	ft	6562
Color of housing / Fire resistance according to UL 94		Gray RAL 7035 / V-0
Reference standards		UL 1449 3rd Ed, IEC 61 643-1 2nd Ed

Technical data

OVR DIN rail SPD

Surge Protective
Devices

Catalog number	Max. discharge current (I_{max} , 8/20 μ s, kA)	Maximum continuous operating voltage (U _c)	Voltage protection rating, kV
OVRT215150PU	15	175	0.6
OVRT215320PU	15	320	1.0
OVRT240150PU	40	175	0.6
OVRT240150PTSU	40	175	0.6
OVRT240320PU	40	320	1.0
OVRT240320PTSU	40	320	1.0
OVRT240440PTSU	40	440	1.3
OVRT240550PTSU	40	550	1.7
OVRT240660PTSU	40	660	1.9
OVRT270NPU	70	255	1.2
OVRT22L15150PU	15	175	0.6
OVRT22L15320PU	15	320	1.0
OVRT22L40150PTSU	40	175	0.6
OVRT22L40320PTSU	40	320	1.0
OVRT23L15150PU	15	175	0.6
OVRT23L15320PU	15	320	1.0
OVRT23L40150PTSU	40	175	0.6
OVRT23L40320PTSU	40	320	1.0
OVRT23L40440PTSU	40	440	1.3
OVRT23L40550PTSU	40	550	1.7
OVRT21N15150PU	15	175	0.6 / 0.7 (L-N / L-G)
OVRT21N15320PU	15	320	1.0 / 1.1 (L-N / L-G)
OVRT21N40150PTSU	40	175	0.6 / 0.7 (L-N / L-G)
OVRT21N40320PTSU	40	320	1.0 / 1.1 (L-N / L-G)
OVRT21N40440PTSU	40	440	1.3 / 1.4 (L-N / L-G)
OVRT21N40550PTSU	40	550	1.7 / 1.8 (L-N / L-G)
OVRT21N40660PTSU	40	660	1.9 / 2.0 (L-N / L-G)
OVRT22N15150PU	15	175	0.6 / 1.2 / 0.7 (L-N / N-G / L-G)
OVRT22N15320PU	15	320	1.0 / 1.2 / 1.1 (L-N / N-G / L-G)
OVRT22N40150PTSU	40	175	0.6 / 1.2 / 0.7 (L-N / N-G / L-G)
OVRT22N40320PTSU	40	320	1.0 / 1.2 / 1.1 (L-N / N-G / L-G)
OVRT22N40440PTSU	40	440	1.3 / 1.2 / 1.4 (L-N / N-G / L-G)
OVRT22N40550PTSU	40	550	1.7 / 1.2 / 1.8 (L-N / N-G / L-G)
OVRT22N40660PTSU	40	660	1.9 / 1.2 / 2.0 (L-N / N-G / L-G)
OVRT23N15150PU	15	175	0.6 / 1.2 / 0.7 (L-N / N-G / L-G)
OVRT23N15320PU	15	320	1.0 / 1.2 / 1.1 (L-N / N-G / L-G)
OVRT23N40150PTSU	40	175	0.6 / 1.2 / 0.7 (L-N / N-G / L-G)
OVRT23N40320PTSU	40	320	1.0 / 1.2 / 1.1 (L-N / N-G / L-G)
OVRT23N40440PTSU	40	440	1.3 / 1.2 / 1.4 (L-N / N-G / L-G)
OVRT23N40550PTSU	40	550	1.7 / 1.2 / 1.8 (L-N / N-G / L-G)
OVRT23N40660PTSU	40	660	1.9 / 1.2 / 2.0 (L-N / N-G / L-G)

Approximate dimensions OVR DIN rail SPD

One pole

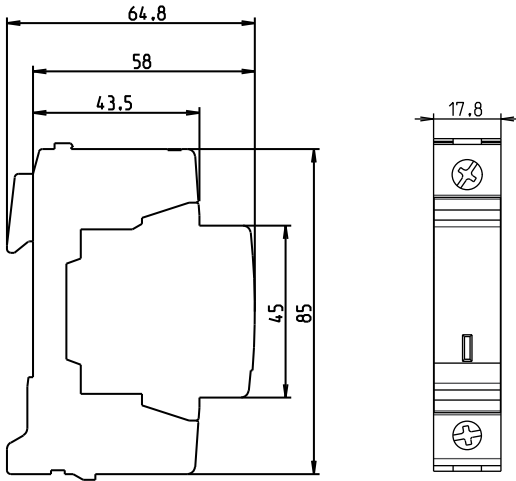

OVRT215150PU
OVRT215320PU
OVRT240150PU
OVRT240320PU
OVRT270NPU

Two pole

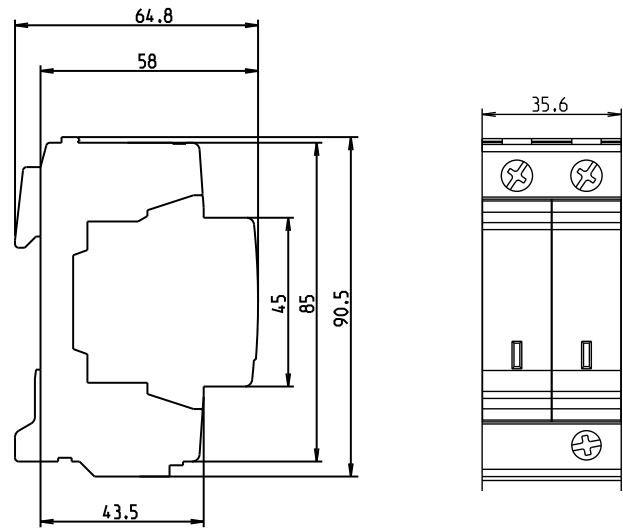

OVRT22L15150PU
OVRT22L15320PU

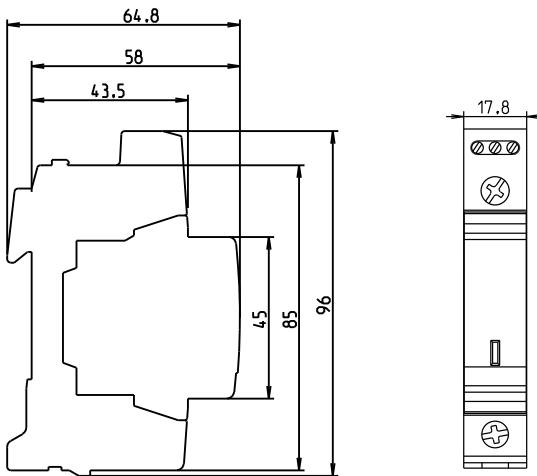

OVRT240150PTSU
OVRT240320PTSU
OVRT240440PTSU
OVRT240550PTSU
OVRT240660PTSU

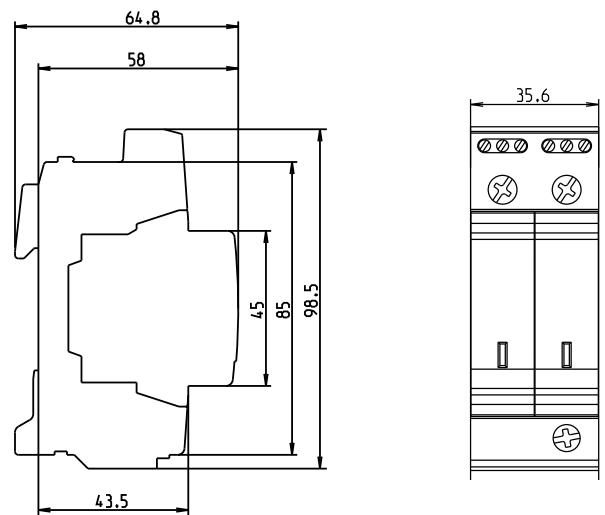

OVRT22L40150PTSU
OVRT22L40320PTSU

16

Approximate dimensions

OVR DIN rail SPD

Surge Protective
Devices

Three pole

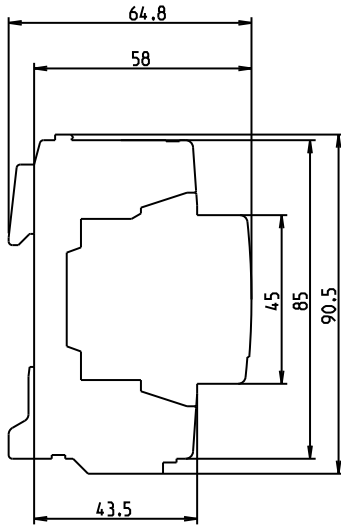

OVRT23L15150PU
OVRT23L15320PU

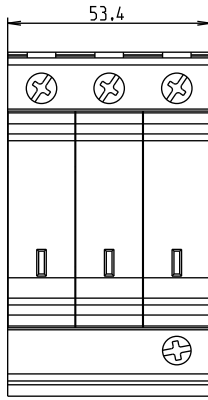

One pole + neutral

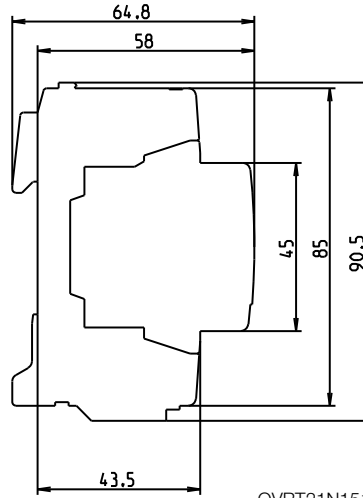

OVRT21N15150PU
OVRT21N15320PU

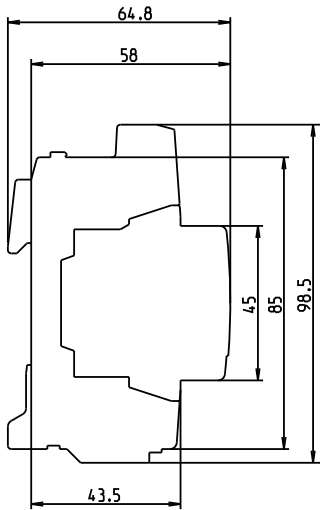
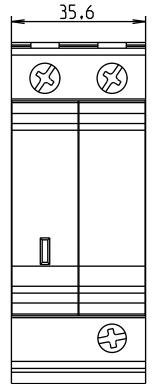

OVRT23L40150PTSU
OVRT23L40320PTSU
OVRT23L40440PTSU
OVRT23L40550PTSU

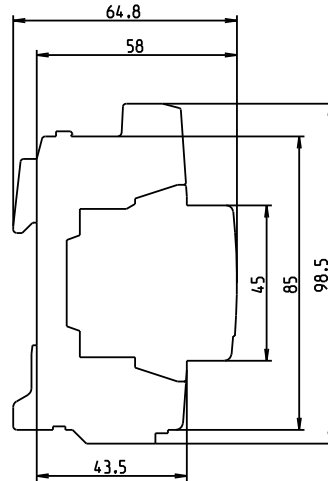
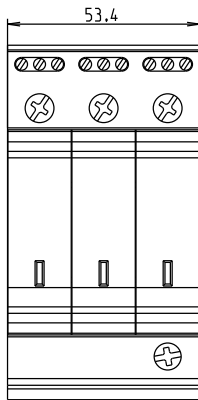

OVRT21N40150PTSU
OVRT21N40320PTSU
OVRT21N40440PTSU
OVRT21N40550PTSU
OVRT21N40660PTSU

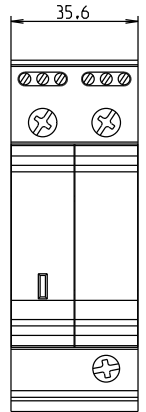

Approximate dimensions OVR DIN rail SPD

Two pole + neutral

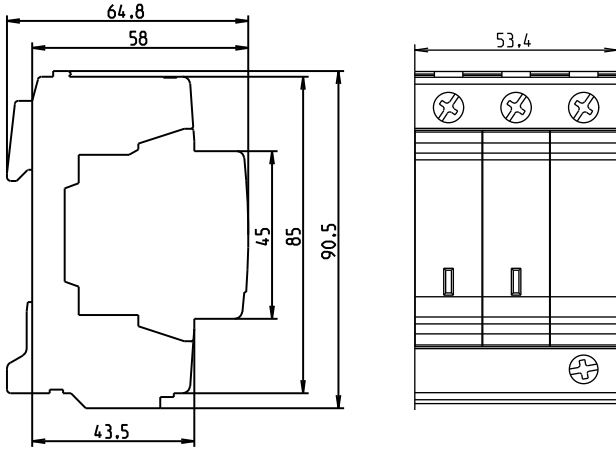

OVRT22N15150PU
OVRT22N15320PU

Three pole + neutral

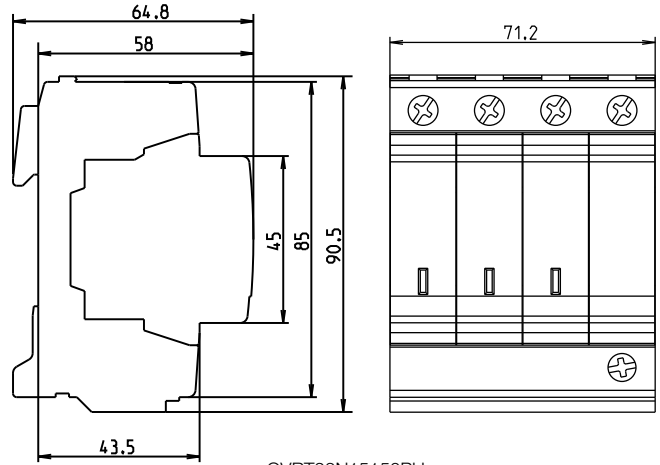

OVRT23N15150PU
OVRT23N15320PU

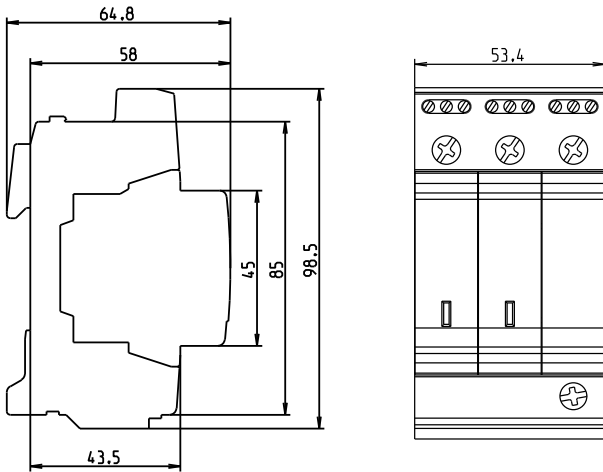

OVRT22N40150PTSU
OVRT22N40320PTSU
OVRT22N40440PTSU
OVRT22N40550PTSU
OVRT22N40660PTSU

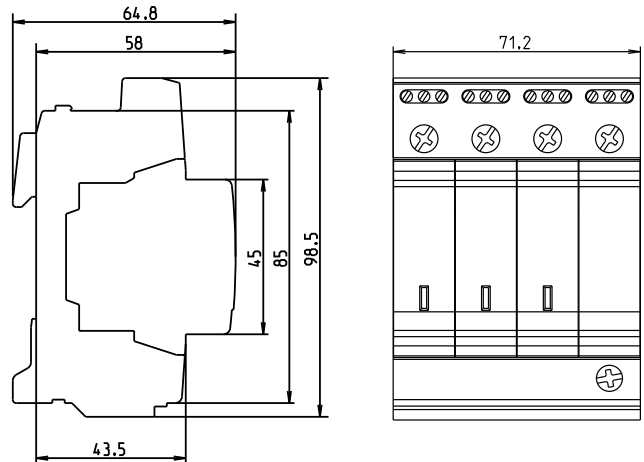

OVRT23N40150PTSU
OVRT23N40320PTSU
OVRT23N40440PTSU
OVRT23N40550PTSU
OVRT23N40660PTSU

UL 1449 2nd Edition to 3rd Edition

Cross reference

Surge Protective
Devices

Previous ABB catalog number - UL 1449 2nd Edition parts	New ABB catalog number - UL 1449 3rd Edition parts	
OVR15150	OVRT215150PU	
OVR15150SP		
OVR15275		
OVR40150P	OVRT215320PU	
OVR40150		
OVR40150SP	OVRT240150PU	
OVR65150SP		
OVR40150SPTS		OVRT240150PTSU
OVR40275P		
OVR40275SP		OVRT240320PU
OVR40-320P		
OVR65275SP		
OVR100275SP		
OVR40320SP		
OVR65320SP		
OVR100320SP		
OVR40275SPTS	OVRT240320PTSU	
OVR40320SPTS		
OVR65275SPTS		
OVR100320SPTS		
OVR15275PTS		
OVR40440	OVRT240440PTSU	
OVR40440SP		
OVR40-320D440P		
OVR40440SPTS		
OVR65440SPTS		
OVR15440		
OVR65440SP		
OVR100440S		
OVR100440SP		
OVR15550		OVRT240550PTSU
OVR65550S		
OVR40550		
OVR40550S		
OVR40660PTS	OVRT240660PTSU	
OVR40660P		
OVR40660SP		
OVR40660SPTS		
OVR15660		
OVR40660S		
OVR65660S	OVRT270NPU	
OVR65NP		
OVR100NP		

Previous ABB catalog number - UL 1449 2nd Edition parts	New ABB catalog number - UL 1449 3rd Edition parts
OVR3L15275P	OVRT23L15320PU
OVR3L40275SP	OVRT23L40320PTSU
OVR3L65275SP	
OVR3N15150	OVRT23N15150PU
OVR3N15320	OVRT23N15320PU
OVR3N40150SP	OVRT23N40150PTSU
OVR3N40320PTS	OVRT23N40320PTSU
OVR3N15275	
OVR3N40320P	
OVR3N40320SPTS	
OVR3N100320SPTS	
OVR3N40275SP	
OVR3N65275SP	
OVR3N40320SP	
OVR3N65320SP	
OVR3N65320SPTS	
OVR3N100320SP	OVRT23N40440PTSU
OVRN340320SPTS	
OVR3N40440SP	
OVRN365440S	OVRT21N15150PU
OVR3N65440SP	
OVR1N15150	
OVR1N15150SPTS	OVRT21N40150PTSU
OVR1N40150SP	
OVR1N40150SPTS	
OVR1N65150SP	OVRT21N40320PTSU
OVRN140275P	
OVRN140275PTS	
OVR4L65440S	OVRT23L40440PTSU + OVRT240440PTSU

Photovoltaic surge protection OVR PV DIN rail SPD

Introduction

Providing power with photovoltaic (PV) solar panels is an ever increasing part of public utilities' renewable energy portfolios, designed to provide electricity in an economical manner, within the context of regulations and scarce resources. Installations are frequently in isolated areas, and combined with the large surface area of a group of panels, the risk of damage from direct and indirect lightning strikes is high.

To mitigate this risk, ABB recommends the installation of OVR PV surge protective devices on the DC portion of the system. ABB provides a wide range of surge protection devices that have been specifically designed for photovoltaic systems.

The main features of the OVR PV surge protectors are:

- Built-in thermal protection with 25A DC breaking capacity
- Removable cartridges for easy maintenance with no need to isolate the line
- Remote signalling contact for monitoring the operating status (TS versions)
- No subsequent short-circuit current
- No risk if the polarity is reversed
- Approvals: UL 1449 3rd Ed, IEC



OVR PV DIN rail SPD

Catalog number	Maximum continuous operating voltage, U_{cpv}	Max. discharge current (I_{max} , 8/20 μ s, kA)	Aux. contact - remote monitoring	Number of poles	Replacement cartridge
OVRPV15600PU	600	15	No	3	OVRPV15600CU
OVRPV15600PTSU	600	15	Yes	3	OVRPV15600CU
OVRPV40600PU	600	40	No	3	OVRPV40600CU
OVRPV40600PTSU	600	40	Yes	3	OVRPV40600CU
OVRPV15800PU	800	15	No	3	OVRPV15800CU
OVRPV15800PTSU	800	15	Yes	3	OVRPV15800CU
OVRPV40800PU	800	40	No	3	OVRPV40800CU
OVRPV40800PTSU	800	40	Yes	3	OVRPV40800CU
OVRPV151000PU	1000	15	No	3	OVRPV151000CU
OVRPV151000PTSU	1000	15	Yes	3	OVRPV151000CU
OVRPV401000PU	1000	40	No	3	OVRPV401000CU
OVRPV401000PTSU	1000	40	Yes	3	OVRPV401000CU

16

Replacement cartridges

Catalog number
OVRPV15600CU
OVRPV15800CU
OVRPV151000CU
OVRPV40600CU
OVRPV40800CU
OVRPV401000CU



Photovoltaic surge protection

OVR PV DIN rail SPD

Surge Protective
Devices

Installation of OVR SPD on photovoltaic networks

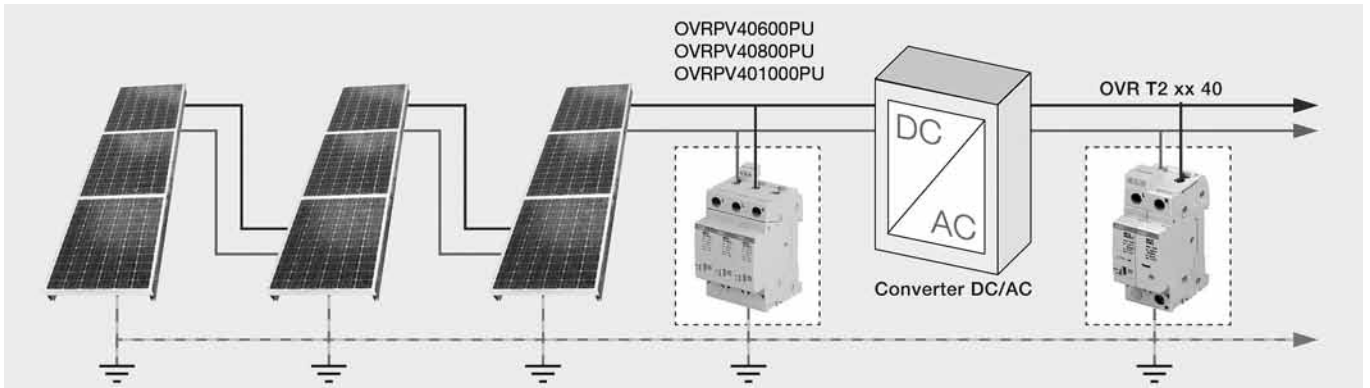

OVR PV approximate dimensions

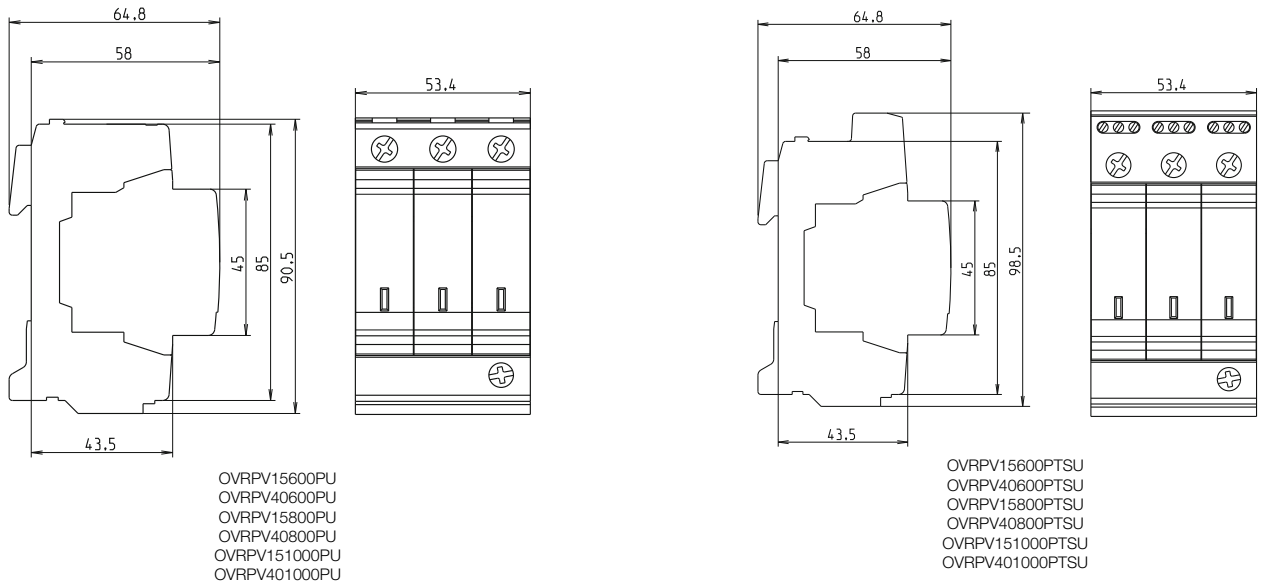

Data line surge protection OVR DIN rail SPD

Introduction

In order to ensure complete protection for equipment in a facility, telecommunication lines entering the installation must have surge protection. Doing so will keep computers, fax machines and other data and communications equipment safe.

The main features of OVR data line surge protectors are:

- 10kA maximum discharge current
- Nominal voltage: 6, 12, 24, 48 and 200 VDC
- Visual life indicator
- UL 497B approved

OVR data line DIN Rail SPD

Catalog number	Maximum continuous operating voltage (U _c)	Max. discharge current (I _{max} , 8/20µs, kA)
OVRTC06V	7	10
OVRTC12V	14	10
OVRTC24V	27	10
OVRTC48V	53	10
OVRTC200V ¹⁾	220	10
OVRTC200FR	220	10

¹⁾ Connection type is parallel. All other parts, series.

16

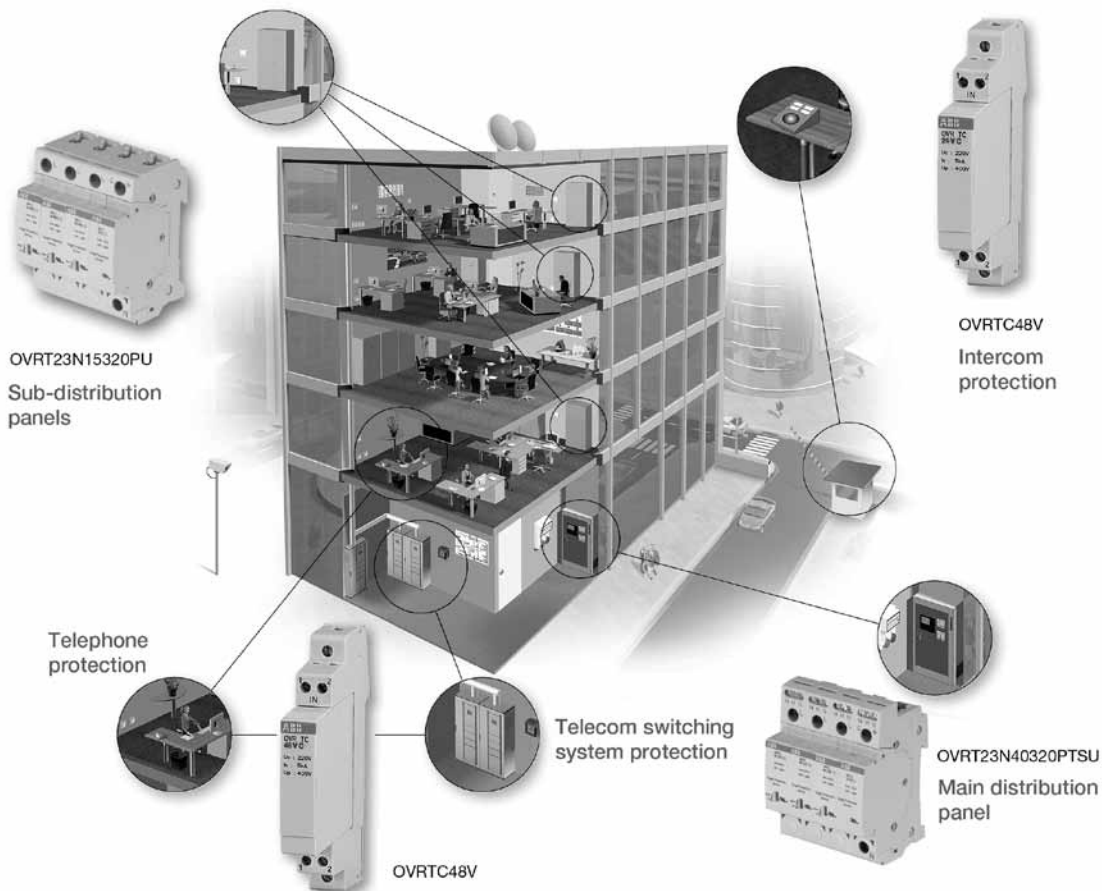



Description

The F200 Series residual current devices offer a wide range of product for all of your fault protection needs.

A & AC

A large offering for standard instantaneous and selective AC and A types.

All sizes up to 63 mA with sensitivity thresholds up to 1 A are offered in all possible pole configurations.

ABB RCDs carry many marks and approvals for the worldwide market.

Features

RCDs assure protection to equipment against current leakage to earth.

UL 1053

UL file number: E244046

Type	F200AC AC	F200A A
Amperage (A)	16, 25, 40, 63, 80, 100, 125 ^①	16, 25, 40, 63, 80, 100, 125 ^①
Voltage	Up to 480 VAC	Up to 480 VAC
Sensitivity (mA)	0.01, 0.03, 0.1, 0.3, 0.5	0.01, 0.03, 0.1, 0.3, 0.5
Type	-	F200A AP-R A
Amperage (A)	-	25, 40, 63, 80, 100, 125 ^①
Voltage	-	Up to 480 VAC
Sensitivity (mA)	-	0.03
Type	F200AC S AC	F200A S A
Amperage (A)	40, 63	40, 63, 100, 125 ^①
Voltage	Up to 480 VAC	Up to 480 VAC
Sensitivity (mA)	0.1, 0.3, 0.5, 1.0	0.1, 0.3, 0.5, 1.0

^① 125A versions are not UL approved.

F200AC

F200 Series

AC Type



F202AC



F204AC



No. of poles	Rated residual current mA	Rated current A	Catalog number	
2	10	16	F202AC-16/0.01	
		30	25	F202AC-25/0.03
			40	F202AC-40/0.03
	63		F202AC-63/0.03	
	80		F202AC-80/0.03	
	100		F202AC-100/0.03	
	100	25	F202AC-25/0.1	
		40	F202AC-40/0.1	
		63	F202AC-63/0.1	
		80	F202AC-80/0.1	
		100	F202AC-100/0.1	
	300	25	F202AC-25/0.3	
		40	F202AC-40/0.3	
		63	F202AC-63/0.3	
		80	F202AC-80/0.3	
		100	F202AC-100/0.3	
500	25	F202AC-25/0.5		
	40	F202AC-40/0.5		
	63	F202AC-63/0.5		
	80	F202AC-80/0.5		
	100	F202AC-100/0.5		

No. of poles	Rated residual current mA	Rated current A	Catalog number
4	30	25	F204AC-25/0.03
		40	F204AC-40/0.03
		63	F204AC-63/0.03
		80	F204AC-80/0.03
		100	F204AC-100/0.03
		125	F204AC-125/0.03 ^⓪
	100	25	F204AC-25/0.1
		40	F204AC-40/0.1
		63	F204AC-63/0.1
		80	F204AC-80/0.1
		100	F204AC-100/0.1
		125	F204AC-125/0.1 ^⓪
	300	25	F204AC-25/0.3
		40	F204AC-40/0.3
		63	F204AC-63/0.3
		80	F204AC-80/0.3
		100	F204AC-100/0.3
		125	F204AC-125/0.3 ^⓪
	500	25	F204AC-25/0.5
		40	F204AC-40/0.5
		63	F204AC-63/0.5
		80	F204AC-80/0.5
		100	F204AC-100/0.5
		125	F204AC-125/0.5 ^⓪

Type AC

- Suitable for protection against AC earth leakage current
- 2 & 4 poles
- 16-125 A range
- Can be used as a main device providing ground fault protection against earth leakage for several MCB branch devices

Technical data

Technical data – See page 16.36

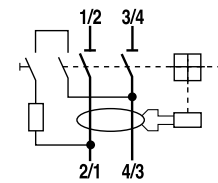

F202AC

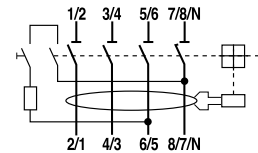

F204AC

^⓪ 125A versions are not UL approved.

F200AC S

F200 Series

AC Type



F202AC S



F204AC S



No. of poles	Rated residual current mA	Rated current A	Catalog number
2	100	40	F202ACS-40/0.1
		63	F202ACS-63/0.1
	300	40	F202ACS-40/0.3
		63	F202ACS-63/0.3
	500	40	F202ACS-40/0.5
		63	F202ACS-63/0.5
	1000	40	F202ACS-40/1.0
		63	F202ACS-63/1.0

No. of poles	Rated residual current mA	Rated current A	Catalog number
4	100	40	F204ACS-40/0.1
		63	F204ACS-63/0.1
	300	40	F204ACS-40/0.3
		63	F204ACS-63/0.3
	500	40	F204ACS-40/0.5
		63	F204ACS-63/0.5
	1000	40	F204ACS-40/1.0
		63	F204ACS-63/1.0

Type AC S (Selectivity)

- Intentional tripping delay, permitting selectivity with downstream instantaneous devices
- 5kA surge current resistance
- Suitable for protection against AC earth leakage current
- 2 & 4 poles
- 40 and 63 A range
- Can be used as a main device providing ground fault protection against earth leakage for several MCB branch devices

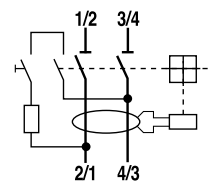

F202AC S

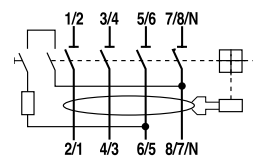

F204AC S

Technical data

Technical data – See page 16.36

F200A

F200 Series

A Type



F202A



F204A



No. of poles	Rated residual current mA	Rated current A	Catalog number	
2	10	16	F202A-16/0.01	
		30	25	F202A-25/0.03
			40	F202A-40/0.03
			63	F202A-63/0.03
			80	F202A-80/0.03
			100	F202A-100/0.03
	100	25	F202A-25/0.1	
		40	F202A-40/0.1	
		63	F202A-63/0.1	
		80	F202A-80/0.1	
		100	F202A-100/0.1	
	300	25	F202A-25/0.3	
		40	F202A-40/0.3	
		63	F202A-63/0.3	
		80	F202A-80/0.3	
100		F202A-100/0.3		
500	25	F202A-25/0.5		
	40	F202A-40/0.5		
	63	F202A-63/0.5		
	80	F202A-80/0.5		
		100	F202A-100/0.5	

No. of poles	Rated residual current mA	Rated current A	Catalog number
4	30	25	F204A-25/0.03
		40	F204A-40/0.03
		63	F204A-63/0.03
		80	F204A-80/0.03
		100	F204A-100/0.03
		125	F204A-125/0.03 [ⓐ]
	100	25	F204A-25/0.1
		40	F204A-40/0.1
		63	F204A-63/0.1
		80	F204A-80/0.1
		100	F204A-100/0.1
		125	F204A-125/0.1 [ⓐ]
	300	25	F204A-25/0.3
		40	F204A-40/0.3
		63	F204A-63/0.3
		80	F204A-80/0.3
		100	F204A-100/0.3
		125	F204A-125/0.3 [ⓐ]
	500	25	F204A-25/0.5
		40	F204A-40/0.5
		63	F204A-63/0.5
		80	F204A-80/0.5
		100	F204A-100/0.5
		125	F204A-125/0.5 [ⓐ]

Type A

- Suitable for protection against AC and pulsating DC earth leakage current
- 2 & 4 poles
- 16-125 A range
- Can be used as a main device providing ground fault protection against earth leakage for several MCB branch devices

Technical data

Technical data – See page 16.36

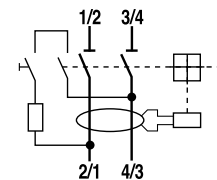

F202A

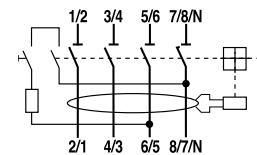

F204A

[ⓐ] 125A versions are not UL approved.

F200A AP-R

F200 Series

A Type



F202A AP-R



F204A AP-R



No. of poles	Rated residual current mA	Rated current A	Catalog number
2	30	25	F202A-25/0.03APR
		40	F202A-40/0.03APR
		63	F202A-63/0.03APR
		80	F202A-80/0.03APR
		100	F202A-100/0.03APR

No. of poles	Rated residual current mA	Rated current A	Catalog number
4	30	25	F204A-25/0.03APR
		40	F204A-40/0.03APR
		63	F204A-63/0.03APR
		80	F204A-80/0.03APR
		100	F204A-100/0.03APR
		125	F204A-125/0.03APR ①

Type A AP-R (High Immunity)

- Resistance to unwanted tripping (high immunity)
- 3kA surge current resistance
- Suitable for protection against AC and pulsating DC earth leakage current
- 2 & 4 poles
- 25-125 A range
- Can be used as a main device providing ground fault protection against earth leakage for several MCB branch devices

Technical data

Technical data – See page 16.36

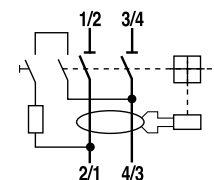

F202A AP-R

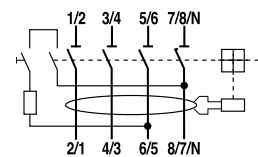

F204A AP-R

① 125A versions are not UL approved.

F200A S

F200 Series

A Type



F202A S



F204A S



No. of poles	Rated residual current mA	Rated current A	Catalog number
2	100	40	F202AS-40/0.1
		63	F202AS-63/0.1
		100	F202AS-100/0.1
	300	40	F202AS-40/0.3
		63	F202AS-63/0.3
		100	F202AS-100/0.3
	500	40	F202AS-40/0.5
		63	F202AS-63/0.5
		100	F202AS-100/0.5
	1000	40	F202AS-40/1.0
		63	F202AS-63/1.0
		100	F202AS-100/1.0

No. of poles	Rated residual current mA	Rated current A	Catalog number
4	100	40	F204AS-40/0.1
		63	F204AS-63/0.1
		100	F204AS-100/0.1
	300	40	F204AS-40/0.3
		63	F204AS-63/0.3
		100	F204AS-100/0.3
	500	40	F204AS-40/0.5
		63	F204AS-63/0.5
		100	F204AS-100/0.5
	1000	40	F204AS-40/1.0
		63	F204AS-63/1.0
		100	F204AS-100/1.0

Type A S (Selectivity)

- Intentional tripping delay, permitting selectivity with downstream instantaneous devices
- 5kA surge current resistance
- Suitable for protection against AC and pulsating DC earth leakage current
- 2 & 4 poles
- 40-125 A range
- Can be used as a main device providing ground fault protection against earth leakage for several MCB branch devices

Technical data

Technical data – See page 16.36

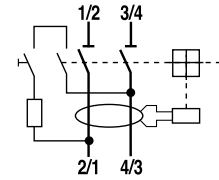

F202A S

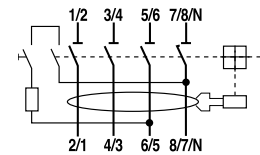

F204A S

Ⓢ 125A versions are not UL approved.

Technical data

Functions and classification criteria

RCDs

Power loss of RCDs

RCCBs F200 series

Rated Current in [A]	Power loss [W]	
	2P	4P
16	1.5	-
25	2.0	4.8
40	4.8	8.4
63	7.2	13.2

Performance in altitude of RCDs

Up to the height of 2000 m, ABB RCDs do not undergo any alterations in their rated performances. Over this height the properties of the atmosphere change in terms of composition, dielectric capacity, cooling capacity and pressure, therefore the performances of the RCDs undergo derating, which can basically be measured in terms of variations in significant parameters, such as the maximum operating voltage and the rated current.

F200

Altitude [m]	2000	3000	4000
Rated service voltage U_e [V]	400	380	380
Rated current in	I_n	$0.96 \times I_n$	$0.93 \times I_n$

Introduction

Residual current devices (RCD) have always played an important role in circuit protection by detecting leakage to ground for equipment in many installations. RCD's are used in unison with a circuit protective device in industrial applications in the United States. The following guide will give an insight to the construction, mechanical operation, and applications of RCD's.

RCD Definitions

Important definitions:

Earth leakage current

Current that flows between line to line or line to earth.

Residual current

The sum of the values of the electric currents in all live conductors

Fault current

Current that flows between line to line or line to earth.

Earth fault

When a conductive path is accidentally induced between a line and the earth

RCD Definition

RCD's provide ground fault protection to equipment by monitoring the leakage of current to ground. An RCD will trip when a ground fault is detected in excess of the trip rating of the device. An RCD is designed to disconnect a circuit whenever it detects that the electrical current is unbalanced between the phase conductor and the neutral conductor. An imbalance may be caused by phase leaking to ground.

Difference between type A and AC

Types of RCD's

Type AC

Must be used for protection against AC earth leakage current.



Type A

Must be used for protection against AC and pulsating DC (rectified AC) earth leakage current. The type A RCD must be installed in any circuit where the main supply is likely to be rectified. Some examples of applications where this would apply are motor speed controllers (drives) and power tools.

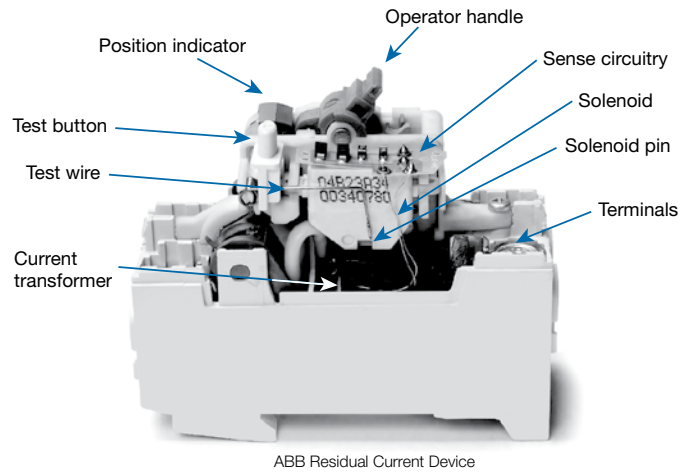
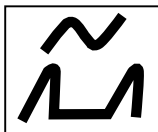

RCD Mechanical operation

Main Incoming Supply and Terminals

The main incoming and the grounded neutrals are connected to the terminals. The operator handle places the RCD in the on and off position as the position indicator shows.

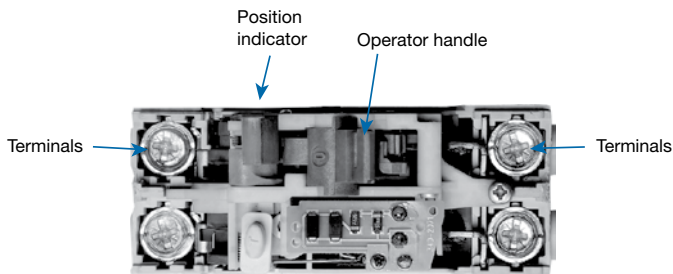

Test button and Test Wire

When the test button is pressed it allows the correct operation of the device to be verified by passing a small current through the test wire. This simulates a leakage to ground by creating an imbalance in the current transformer (CT).

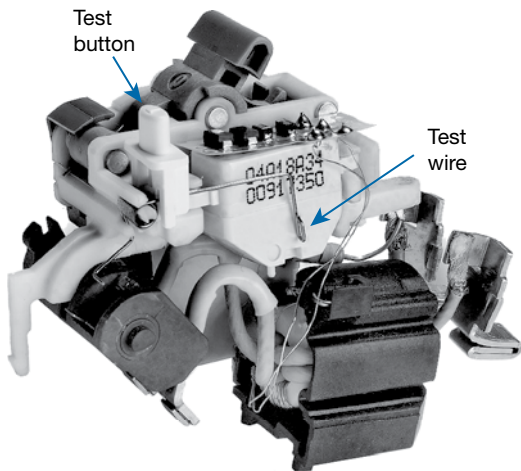

Current Transformer and Sense Circuitry

The current transformer surrounds the neutral and L1 conductors. During normal operation, all of the current being carried through the L1 conductor returns up through the neutral conductor. Therefore the currents in the two conductors are equal and opposite. When a leakage to ground occurs it causes some of the current to take a path to ground and creates an imbalance in the current between the two conductors. This imbalance in current induces a current in the current transformer (CT) which is then picked up by the sense circuitry. The sense circuitry then actuates the solenoid and the contacts are forced apart by a spring, terminating the electricity supply to the device.

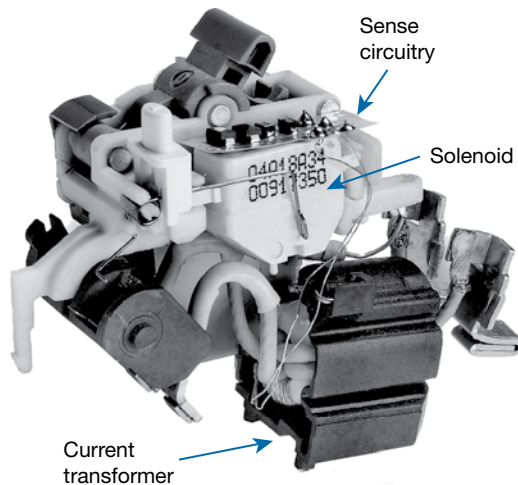

Solenoid

Once an imbalance has been detected by the CT, there is voltage induced on the CT. The voltage travels through the connected copper wires to the sense circuitry and the solenoid is actuated. The plunger at the bottom of the solenoid is then pushed out to trip the breaker.

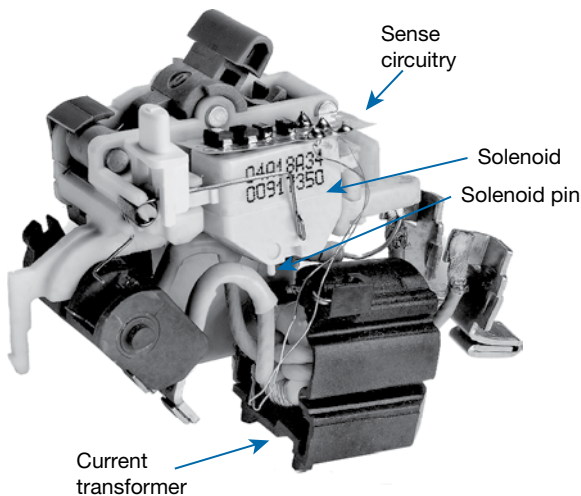

Application manual

Difference between RCD and MCB

Example of current leakage to ground

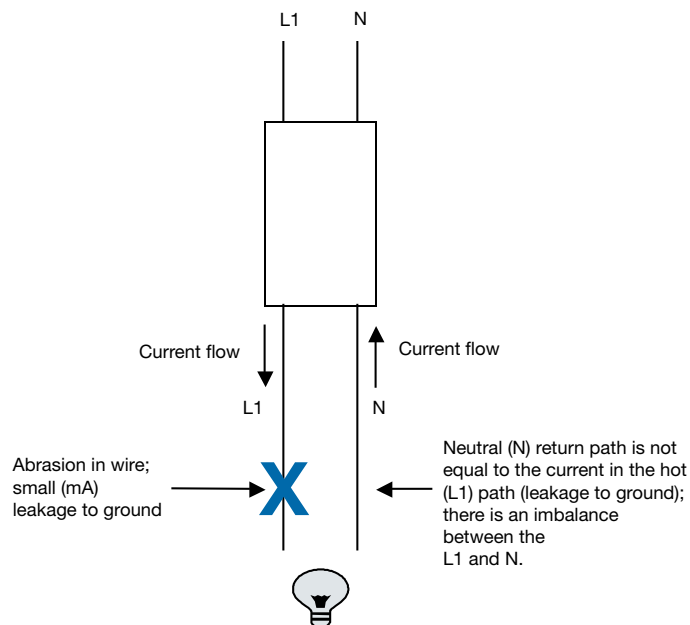

Difference between RCD and MCB

Miniature Circuit Breaker (MCB)

A miniature circuit breaker (MCB) is a device designed to isolate a circuit during an overcurrent event without the use of a fusible element. A breaker is a resettable protective device that protects against two types of overcurrent situations; overload and short circuit.

Residual Current Device (RCD)

A residual current device (RCD) is a device designed to provide protection against voltage leakage to ground. *RCD's are sensitive to a 30-300mA. RCD's are mechanical devices that contain a CT and a solenoid.* RCD's are designed to protect equipment, not wires against overload and short circuit situations. For this reason, an RCD should always be used in conjunction with an MCB in order to provide full protection from overload and leakage to ground.

Ground Fault Interrupter (GFI)

GFI Definition (NEC): A device intended for the protection of personnel that functions to de-energize a circuit or portion thereof within an established period of time when a current to ground exceeds the values established for a Class A device.

A ground fault interrupter (GFI) is a device designed to measure the current between the hot wire and neutral wire. Like the RCD, the GFI will open the closed contacts in order to protect against damage. A GFI is sensitive to 5mA and higher and is designed to protect people, not equipment.

A GFI is an electric device that contains a printed circuit board (PCB). GFI's have a "pigtail" wire at the end that carries a signal to the PCB that tells the contacts to open when a current imbalance is detected between the two conductors.

Technical data

F200AC, F200A

Item	F200AC	F200AC S
Approvals:		
UL	1053	1053
CSA	-	-
VDE	-	-
IEC	-	-
Number of Poles:	2, 4	2, 4
Rated Currents:	16, 25, 40, 63, 80, 100, 125 ^⓪	40, 63
Operating Voltage:	Up to 480 VAC	Up to 480 VAC
Production Category:	IP20	IP20
Depth of Unit Per DIN 43880:	68mm/ 2.68 in.	68mm/ 2.68 in.
Mounting Position:	vertical, horizontal	vertical, horizontal
Standard Mounting:	35mm DIN rail	35mm DIN rail
Main and Shunt Trip Terminals:		
Wire Size	18-4 AWG/.82-21.2mm ²	18-4 AWG/.82-21.2mm ²
Torque	17.5 in-lbs./1.978 nm	17.5 in-lbs./1.978 nm
Tool	#2 Posidrive	#2 Posidrive
Accessory Terminals		
Wire Size	18-16 AWG/.82-1.3mm ²	18-16 AWG/.82-1.3mm ²
Torque	4.5 in-lbs./.51nm	4.5 in-lbs./.51nm
Tool	# 1 Posidrive	# 1 Posidrive
Service Life at Rated Load:	No Load 20,000 operations Full Load 10,000 operations	No Load 20,000 operations Full Load 10,000 operations
Shock Resistance:	30g minimum of 2 impacts, shock duration of 13ms	30g minimum of 2 impacts, shock duration of 13ms
Vibration Resistance:	5g, 20 cycles, 5 Hz, 150 Hz @ 0.8 ~ 1n	5g, 20 cycles, 5 Hz, 150 Hz @ 0.8 ~ 1n

Item	F200A	F200A AP-R	F200A S
Approvals:			
UL	1053	1053	1053
CSA	-	-	-
VDE	-	-	-
IEC	-	-	-
Number of Poles:	2, 4	2, 4	2, 4
Rated Currents:	16, 25, 40, 63, 80, 100, 125 ^⓪	25, 40, 63, 80, 100, 125 ^⓪	40, 63, 100, 125 ^⓪
Operating Voltage:	Up to 480 VAC	Up to 480 VAC	Up to 480 VAC
Production Category:	IP20	IP20	IP20
Depth of Unit Per DIN 43880:	68mm/ 2.68 in.	68mm/ 2.68 in.	68mm/ 2.68 in.
Mounting Position:	vertical, horizontal	vertical, horizontal	vertical, horizontal
Standard Mounting:	35mm DIN rail	35mm DIN rail	35mm DIN rail
Main and Shunt Trip Terminals:			
Wire Size	18-4 AWG/.82-21.2mm ²	18-4 AWG/.82-21.2mm ²	18-4 AWG/.82-21.2mm ²
Torque	17.5 in-lbs./1.978 nm	17.5 in-lbs./1.978 nm	17.5 in-lbs./1.978 nm
Tool	#2 Posidrive	#2 Posidrive	#2 Posidrive
Accessory Terminals			
Wire Size	18-16 AWG/.82-1.3mm ²	18-16 AWG/.82-1.3mm ²	18-16 AWG/.82-1.3mm ²
Torque	4.5 in-lbs./.51nm	4.5 in-lbs./.51nm	4.5 in-lbs./.51nm
Tool	# 1 Posidrive	# 1 Posidrive	# 1 Posidrive
Service Life at Rated Load:	No Load 20,000 operations Full Load 10,000 operations	No Load 20,000 operations Full Load 10,000 operations	No Load 20,000 operations Full Load 10,000 operations
Shock Resistance:	30g minimum of 2 impacts, shock duration of 13ms	30g minimum of 2 impacts, shock duration of 13ms	30g minimum of 2 impacts, shock duration of 13ms
Vibration Resistance:	5g, 20 cycles, 5 Hz, 150 Hz @ 0.8 ~ 1n	5g, 20 cycles, 5 Hz, 150 Hz @ 0.8 ~ 1n	5g, 20 cycles, 5 Hz, 150 Hz @ 0.8 ~ 1n

^⓪ 125A versions are not UL approved.

E90 Series Fuseholders and fuse disconnectors



Fuseholders and fuse disconnectors E90 Series



Description

E90 fuseholders and fuse disconnectors can be used in a variety of applications where electrical protection and isolation are required.

E 90 Fuse switch disconnectors

E 90 series fuse switch disconnectors are designed for switching circuits under load, providing protection against short circuits and overloads. The case is made of self-extinguishing thermoplastic material resistant to high temperatures (all materials are UL listed) while the contact clips are in silver plated copper.

E 90 fuse switch disconnectors can be sealed or padlocked to ensure operator safety during maintenance. For easy and quick installation E 90 range is totally compatible with connecting bars, terminals and caps of S 200 MCBs.

Thanks to cURus approval, they can be installed in UL certified machines.

E90 fuse disconnectors for 10.3 x 38 mm fuses (AC-22B)

No. of poles	Modules	Rated Current I _n A	Catalog number
1	1	32	E91/32
1	1	32	E91/32s
1+N	2	32	E91N/32
1+N	2	32	E91N/32s
2	2	32	E92/32
3	3	32	E93/32
3+N	4	32	E93N/32
4	4	32	E94/32

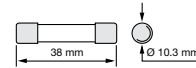

s: version with blown fuse indicator light.



Type		E 90/32
Fuse	[mm]	10 x 38
Current type		a.c. / d.c.
Rated frequency	[Hz]	50-60
Rated current	[A]	32
Max power dissipation	[W]	3
Tightening torque	[Nm]	PZ2 2-2.5
Terminal cross section	[mm ²]	25
Protection degree		IP20
Can be padlocked (open)		■
Can be sealed (closed)		■

IEC 60947-3		
Rated operating voltage	[V]	400
Utilization category		AC-22B
Markings		IMQ, NF

Alternate current characteristics according to IEC 60947-3		
Rated operating voltage	[V]	690
Utilization category		AC-22B

Direct current characteristics according to IEC 60947-3		
Rated operating voltage	[V]	690
Utilization category		DC-20B ①

IEC 60269-1		
Rated a.c. voltage	[V]	690
Rated d.c. voltage	[V]	690

IEC 60269-2		
Fuse system		F
Rated a.c. voltage	[V]	690
Rated d.c. voltage	[V]	440
Breaking capacity	[kA]	200 (a.c.) – 100 (d.c.)

IEC 60269-3		
Fuse system		B
Rated a.c. voltage	[V]	400

IEC 60269-4		
Fuse system		F
Rated a.c. voltage	[V]	690
Rated d.c. voltage	[V]	690

UL 4248		
Markings		cURus

① If the product is used with direct current, switching under load is not permitted. In this case, the warning "do not open under load" must be visible in the front of the device.

E 90 Fuse switch disconnectors

Technical data

Materials

Plastic parts	Case:	Material PA 6 +30% glass fibre
		Self-extinguishing class: V2 (UL94)
		Temperature resistance: 130 °C
	Opening handle	Material PA 66 +25% glass fibre
		Self-extinguishing class V0 (UL94)
		Temperature resistance: 140 °C
Metal parts	Clips	Silver plated copper
	Clip spring	Stainless steel
	Terminals	Galvanized steel

The E 90 series is environmental friendly and protects the health of people: all used materials are conform to the RoHS and REACH directives and they completely exclude hazardous substances and halogen.

Utilization category

Current type	Utilization category	Typical applications
Alternating current	AC-20A - AC-20B	Connecting and disconnecting under no load (in this case the devices must be marked "Do not disconnect under load")
	AC-21A - AC-21B	Switching of resistive loads, including moderate overloads
	AC-22A - AC-22B	Switching of mixed resistive/inductive loads, including moderate overloads
	AC-23A - AC-23B	Switching of motors and other highly inductive loads
Direct current	DC-20A - DC-20B	Connecting and disconnecting under no load (in this case the devices must be marked "Do not open under load")
	DC-21A - DC-21B	Switching of resistive loads, including moderate overloads
	DC-22A - DC-22B	Switching of mixed resistive / inductive loads, including moderate overloads
	DC-23A - DC-23B	Switching of motors or other highly inductive loads
	Suffix A	Frequent use
	Suffix B	Infrequent use

Electrical symbols

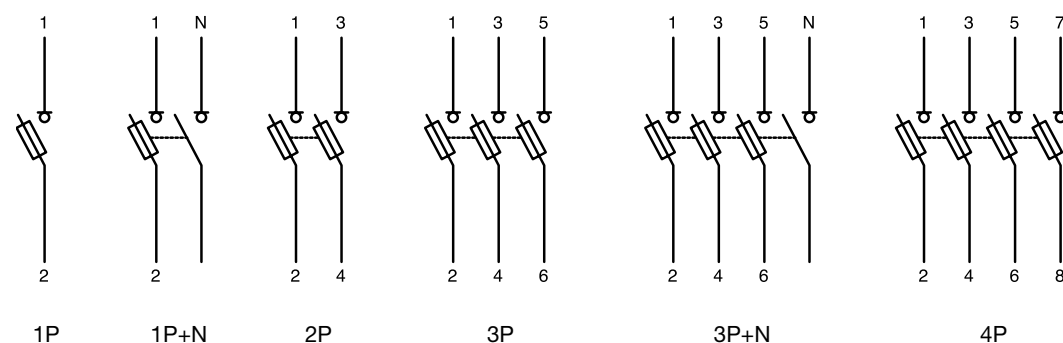

E 90h Fuseholders

E 90h fuseholders are suitable for protection against overloads and short circuits. Available in a single module 1P+N version and in a three-module 3P+N version, they are designed for use with gG and aM cylindrical fuse links. The body is made from self-extinguishing material resistant to high temperatures, while the contact clips are in silver-plated copper. E 90h fuseholders can be sealed or padlocked to assure operator safety during maintenance.



E90h fuseholders for 10.3 x 38 mm fuses

No. of poles	Modules	Rated Current I _n , A	Catalog number
1+N	1	32	E91hN/32
1+N	1	32	E91hN/32s
3+N	3	32	E93hN/32

s: version with blown fuse indicator light.

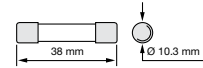

Technical data

Type	E 90hN/32	
Fuse	[mm]	10 x 38
Current type		a.c. / d.c.
Rated frequency	[Hz]	50-60
Rated current	[A]	32
Max power dissipation	[W]	3
Tightening torque	[Nm]	PZ2 0.8-1.2
Terminal cross section	[mm ²]	16
Protection degree		IP20
Can be padlocked (open)		■
Can be sealed (closed)		■



Note: NF mark is available on custom versions with left sided neutral for French market

IEC 60269-1

Rated a.c. voltage	[V]	690
Rated d.c. voltage	[V]	690

IEC 60269-2

Fuse system		F
Rated a.c. voltage	[V]	690
Rated d.c. voltage	[V]	440
Breaking capacity	[kA]	200 (a.c.) – 100 (d.c.)

IEC 60269-3

Fuse system		B
Rated a.c. voltage	[V]	400
Markings		IMQ

IEC 60269-4

Fuse system		F
Rated a.c. voltage	[V]	690
Rated d.c. voltage	[V]	690

UL 4248

Mark		cURus
------	--	-------

Electrical symbols

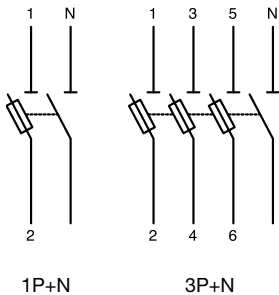

1P+N

3P+N

E 90 PV Fuse disconnectors

E 90 PV series fuse disconnectors (UL approved), designed for operating voltages of 1000 V d.c. with utilization category DC-20B, are particularly suited for protection against overcurrents of photovoltaic systems. The single-pole or two-pole E 90 PV disconnectors for 10.3 x 38 mm cylindrical fuse links offer a reliable, compact and affordable solution for photovoltaic installations. Versions with blown fuse indicator allow to check whether the fuse is still working correctly or not.



E90 PV fuse disconnectors for 10.3 x 38 mm fuses (DC-20B)

No. of poles	Modules	Rated Current I _n A	Catalog number
1	1	32	E91/32PV
1	1	32	E91/32PVs
2	2	32	E92/32PV
2	2	32	E92/32PVs



s: version with blown fuse indicator light



Note: CCC mark is available on custom versions for Chinese market

Technical data

Type	E 90/32 PV	
Fuse	[mm]	10 x 38
Current type		d.c.
Rated frequency	[Hz]	-
Rated current	[A]	32
Max power dissipation	[W]	3
Tightening torque	[Nm]	PZ2 2-2.5
Terminal cross section	[mm ²]	25
Protection degree		IP20
Can be padlocked (open)		■
Can be sealed (closed)		■

Fuse indicator LED



IEC 60947-3		
Rated operating voltage	[V]	1000
Utilization category		DC-20B
UL 4248		
Mark		cULus

Wiring of E 90 PV with blown fuse indicator light in direct current

Electrical symbols

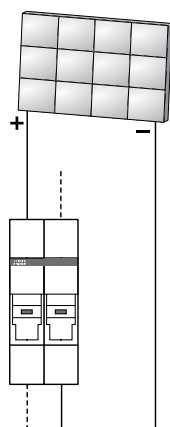
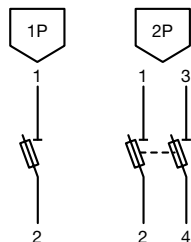

In direct current systems, since the LED allows the current to flow only from positive to negative, the wiring of the blown fuse indicator version should follow the current direction as shown in the diagram.

E 90 PV Fuse disconnectors

Protection and disconnection of 1000 V DC lines

String protection

To avoid equipment damage on DC lines and to ensure isolation of the PV system in case of maintenance, E90 PV disconnecter fuses can be installed downstream the inverter to protect each single string. The fuses must be selected according to the rated current of the line and to the maximum dissipated power.

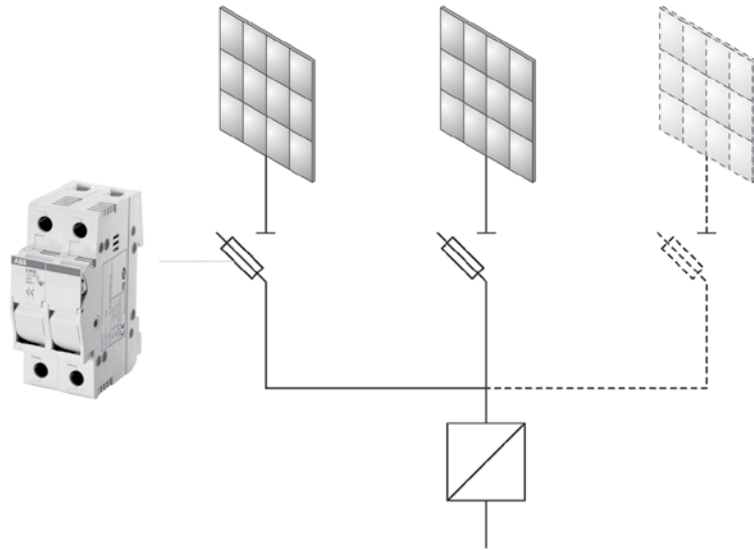

Back-up download

When the loc short circuit current, at the point of installation, is greater than 100 A DC, the OVR PVs Surge Protective Devices require a back-up protection with a specific type gR fuse.

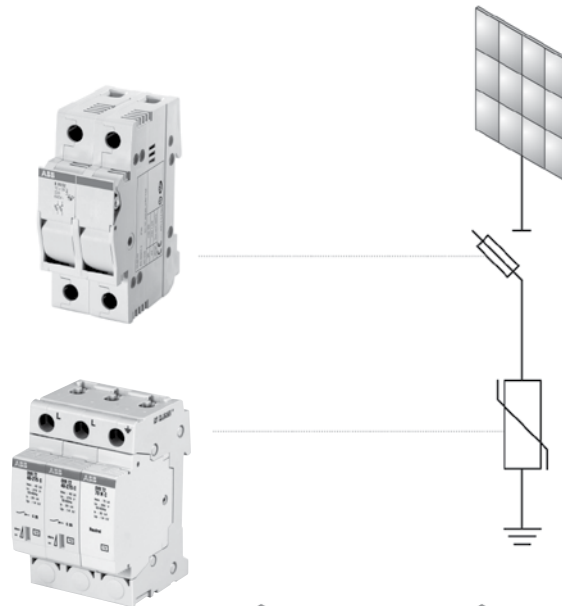

DC side of the inverter

For small size photovoltaic systems, E 90 PV fuse disconnectors can be used to protect the DC side of the inverter. The fuse should be chosen according to the rated current of the inverter.

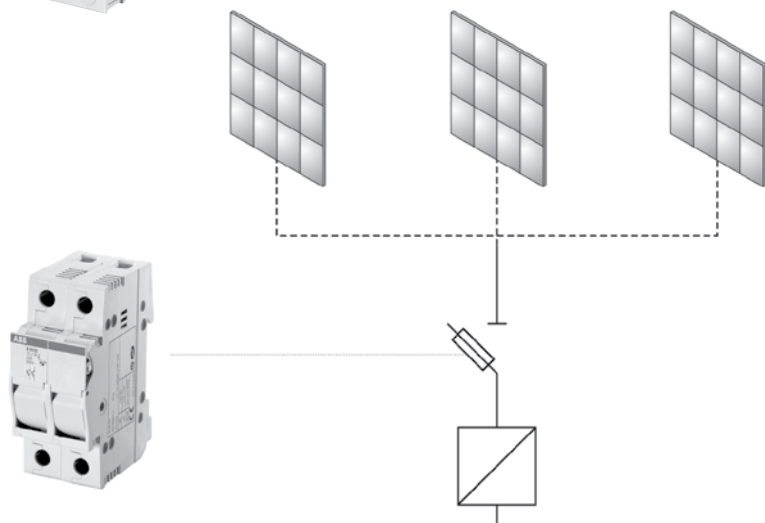

E 90 Class CC fuseholders

The E 90 fuse carriers for Class CC cylindrical fuse links are specifically designed for the North American market in compliance with the UL standards. In accordance with the reference standards UL 4248-1 and UL 4248-4, they come in voltage and current ratings up to 600V and 30A. They are available in 1P, 1P+N, 2P, 3P, 3P+N and 4P versions. They can be padlocked open and sealed closed.

The E 90 fuse carriers are the ideal solution for process control and industrial systems, automation systems, industrial installations and control circuits.



E90 fuseholders for Class CC 10.4 x 38 mm fuses

No. of poles	Modules	Rated Current I _n , A	Catalog number
1	1	30	E91/30
1	1	30	E91/30s
1+N	2	30	E91N/30
2	2	30	E92/30
3	3	30	E93/30
3+N	4	30	E93N/30
4	4	30	E94/30

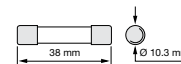

s: version with blown fuse indicator light.

Technical data

		30A
Rated voltage U _n	[V]	600 a.c. /d.c.
Rated current I _n	[A]	30
Rated frequency	[Hz]	50-60
Fuse size	[mm]	10.4 x 38.1
Tightening torque	[Nm]	PZ2 2-2.5
Rated temperature	[°C]	75
Can be sealed closed		■
Can be padlocked open		■
Markings		UL CSA
Standards		UL 4248-1 (General) UL 4248-4 (Class CC)

E 930 Fuse disconnectors

The E 930 fuse disconnector range, for current of 50 A and 125 A, is specifically intended for industrial circuit protection. The E 930 can carry any type of cylindrical fuses 14x51 and 22x58 mm, they are padlockable in open position to ensure operator safety during maintenance operations. The E 930 also support MCR microswitches, through which you can get a complete remote monitoring of the device state. The microswitch makes it possible to report: the fuse intervention, the opening of the drawer and the fuse absence with closed drawer.



E931/50

E930 fuse disconnectors for 14 x 51 mm fuses (AC-20B)

No. of poles	Modules	Rated Current I _n , A	Catalog number
1	1.5	50	E931/50
1+N	3	50	E931N/50
2	3	50	E932/50
3	4.5	50	E933/50
3+N	6	50	E933N/50

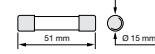

E930 fuse disconnectors for 22 x 58 mm fuses (AC-20B)

No. of poles	Modules	Rated Current I _n , A	Catalog number
1	2	125	E931/125
1+N	4	125	E931N/125
2	4	125	E932/125
3	6	125	E933/125
3+N	8	125	E933N/125

Microswitches for E930 series fuse disconnectors

No. of poles	Modules	Rated Current I _n , A	Catalog number
1	1	50	E930/MCR1P50
3	3	50	E930/MCR3P50
1	1	125	E930/MCR1P125
3	3	125	E930/MCR3P125

Technical data

		50 A	125 A
Rated voltage U _n	[V]		750 a.c./d.c.
Insulation voltage	[V]		8000
Rated current I _n	[A]	50	125
Short circuit current I _{cc}	[A]		see fuse link
Rated frequency	[Hz]		50-60
Fuse size	[mm]	14 x 51	22 x 58
Utilization category			AC-20B/DC-20B
Max power dissipation	[W]	5	9.5
Terminals	[mm ²]	25	35
Can be sealed closed			■
Can be padlocked open			■
Protection degree			IP20
Markings			UL, CSA
Standards			IEC 60947-3

E 930 Fuseholders

Electrical symbols

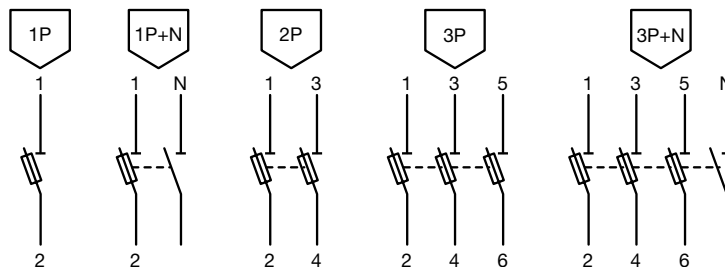

Padlocked in open position

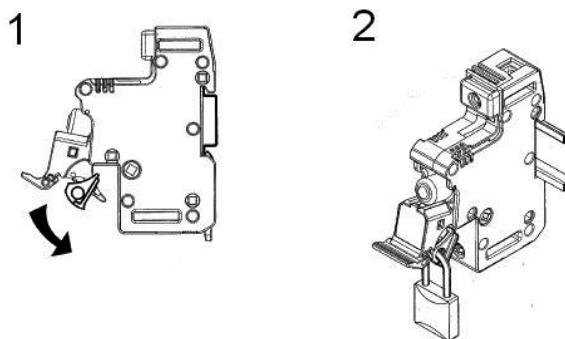

State of the E 930/MCR microswitch contact

Closed fuseholders with fuse

Open fuseholders without fuse

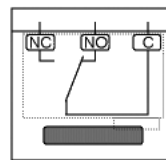
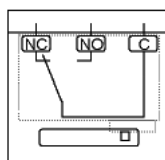

Microswitch functions

- a - fuse blown : indicates fuse break condition
- b - pre-opening: indicates when the fuseholders cover is open
- c - presence: indicates when the cover is closed but there is no fuse

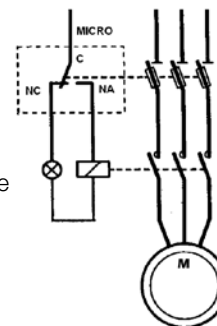

Microswitch assembly and disassembly steps

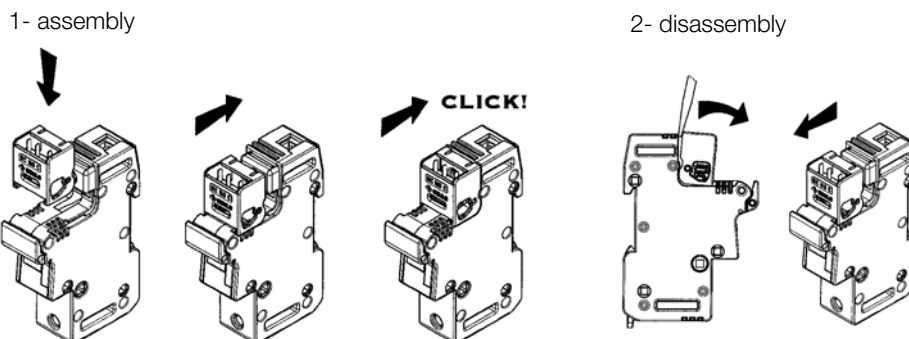

Notes

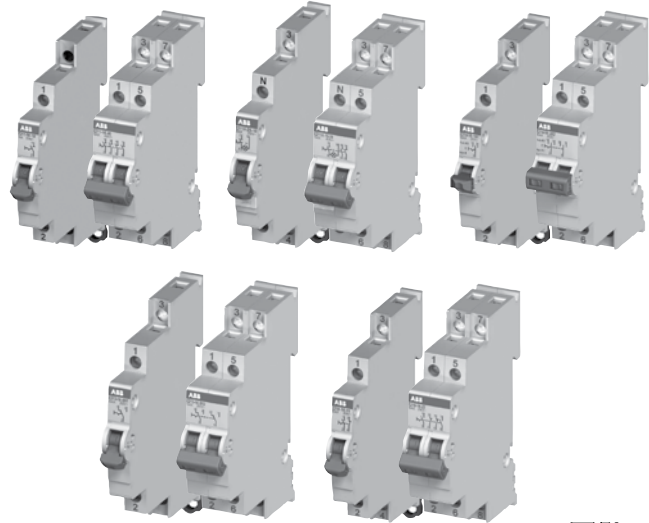

Description

These devices are specifically made for commanding loads and signalling electrical conditions in any low-voltage switchboard. They are available in half module or 1 module, depending on the contact-layout. The devices with indicator lights are equipped with a LED, which grants an optimum illumination with very low consumption.

The functions of these devices are particularly switching, pushing and signalling electrical conditions in any installations (low-voltage area)

General new features

- Space-saving through 9mm modules
- All terminals equipped with Pozidrive 1 screws
- Safe connection due to cage-clamp
- LED with bright colors and available in three different voltage ranges
- Different lens and button colors
- Compliance to international standards

E210 Switches

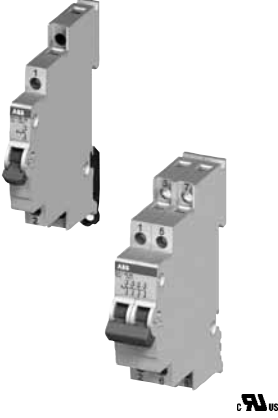

E211-... ON-OFF switches

Contacts	Rated voltage	Power loss	Width	Catalog number
	VAC	W	mm	
Rated current = 16A				
1 NO	250	0.32	9	E211-16-10
2 NO	230/400	0.82	9	E211-16-20
3 NO	230/400	1.14	18	E211-16-30
4 NO	230/400	1.64	18	E211-16-40
Rated current = 25A				
1 NO	250	0.75	9	E211-25-10
2 NO	230/400	1.95	9	E211-25-20
3 NO	230/400	2.70	18	E211-25-30
4 NO	230/400	3.90	18	E211-25-40
Rated current = 32A				
1 NO	250	1.12	9	E211-32-10
2 NO	230/400	2.73	9	E211-32-20
3 NO	230/400	3.85	18	E211-32-30
4 NO	230/400	5.46	18	E211-32-40

E211-... ON-OFF switch devices are used to switch indicators or other electrical components (like fan's, air-conditions, e.g.). The new On-Off switches distinguish themselves through simple handling, easy mounting and optimal functionality.

E210 Switches

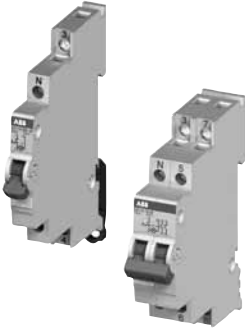

E211X-... ON-OFF switches with yellow LED for contact indication LED voltage 115-250 VAC

Contacts	Rated voltage	Power loss	LED color	Width	Catalog number
	VAC	W		mm	
Rated current = 16A					
1 NO	250	0.50	Yellow	9	E211X-16-10
2 NO	230/400	1.00	Yellow	18	E211X-16-20
3 NO	230/400	1.50	Yellow	18	E211X-16-30
Rated current = 25A					
1 NO	250	0.75	Yellow	9	E211X-25-10
2 NO	230/400	1.95	Yellow	18	E211X-25-20
3 NO	230/400	2.70	Yellow	18	E211X-25-30

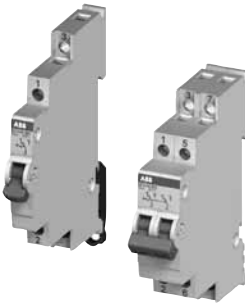

E213-... Change over switches

Contacts	Rated voltage	Power loss	LED color	Width	Catalog number
	VAC	W		mm	
Rated current = 16A					
1 CO	250	0.32	-	9	E213-16-001
2 CO	250	0.82	-	18	E213-16-002
Rated current = 25A					
1 CO	250	0.40	-	9	E213-25-001
2 CO	250	0.88	-	18	E213-25-002

The new change-over switches distinguish themselves through simple handling, easy mounting and optimal functionality. Example applications include opening and closing of electrically operated flaps.



Terminal assignment

ON / OFF switch



1 NO



2 NO



3 NO

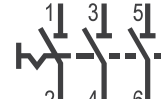

4 NO

OFF switches with indicator lamps



1 NO



2 NO



3 NO

Change-over switches



1 C/O

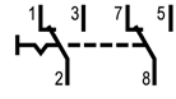

2 C/O

E210 Switches

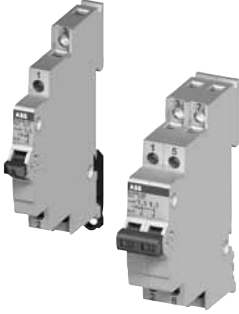

E214-... Group switches (I-0-II, manual-OFF-automatic)

Contacts	Rated voltage	Power loss	Width	Catalog number
	VAC	W	mm	
Rated current = 16A				
1 CO	250	0.32	9	E214-16-101
2 CO	250	0.82	18	E214-16-202
Rated current = 25A				
1 CO	250	0.40	9	E214-25-101
2 CO	250	0.88	18	E214-25-202

The new Group switches can be used to control the main installation of an emergency supply. Such devices distinguish themselves through simple handling, easy mounting and optimal functionality.

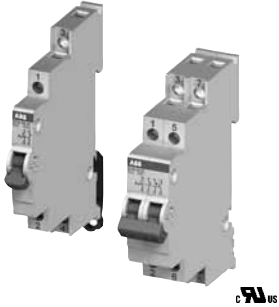

E218-... Control switches

Contacts	Rated voltage	Power loss	Width	Catalog number
	VAC	W	mm	
Rated current = 16A				
1NO+1NC	250	0.50	9	E218-16-11
2NO+2NC	250	1.00	18	E218-16-22
3NO+1NC	250	1.50	18	E218-16-31
Rated current = 25A				
1NO+1NC	250	0.75	18	E218-25-11

These devices can be used in distribution board for any control function. The new control switches distinguish themselves through simple handling, easy mounting and optimal functionality.

Terminal assignment

Group switches

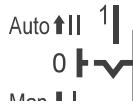

1-pole

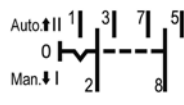

2-pole

Control switches



1 NO + 1 NC

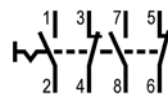

2 NO + 2 NC

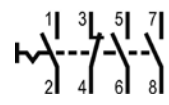

3 NO + 1 NC

E210 Switches

Technical data

Switching capacity		according to EN 60669-1
Isolating properties		according to EN 60669-2-4; IEC/EN 60947-3
Utilization category		AC-22A; DC-22A acc. IEC/EN60947-3
Short-circuit withstand capacity [kA]		3
Rated voltage U_n [V]		250/400 in accordance with EN 240 in accordance UL 508
Lowest operating voltage		24 V; 25 mA
Rated current I_n [A]		16, 25, 32
LED current [mA]		5
Rated frequency [Hz]		50/60
Modules [No]		0.5 or 1
Sealable		in ON and OFF position
Climatic resistance		according to IEC 60068-2-2 (Dry heat) IEC 60068-2-30 (Damp heat) IEC 60068-2-1 (Cold)
Ambient temperature [°C/°F]		-25°C/-13°F to +55°C/+131°F
Storage temperature [°C]		-40°C to +70°C
Connection capacity [mm ²]		from 1x1 mm ² to 1x6 mm ² or 2x2.5 mm ² massive; Flexible up 1x0.75 mm ² to 2x1.5 mm ² with connector sleeve or pin end connector
Tightening torque [Nm]		1.2 - 1.5
Positive opening		according to EN 60204-1
Standards		DIN EN 60669-1 *VDE 0632-1 DIN EN 60669-2-4 *VDE 0632-2-4 UL 508
Approvals		VDE, UL, GOST, CCC

DC switching capacity E211 16A

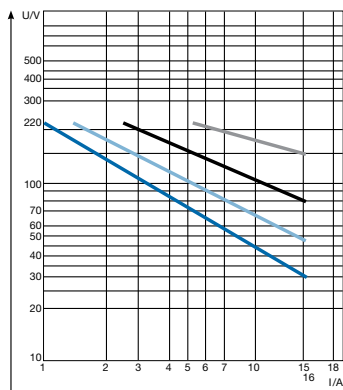

DC switching capacity E211 25A

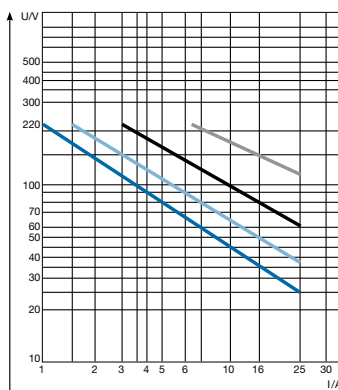

DC switching capacity E211 32A

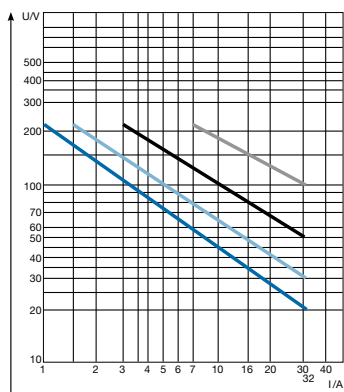

- Ohmic load
 - Normally-open contact
 - Normally-closed contact
- Load with time constant $t = 15\text{ms}$ (inductive load)
 - Normally-open contact
 - Normally-closed contact

E210 Pushbuttons with and without LEDs



Pushbuttons without and with LED

The new products are available in 9 mm widths (= 0.5 modules). The devices can be used in distribution boards and are all distinguished by their simple handling, ease of mounting and optimal functionality. The pushbuttons are used for remote control in all kinds of electrical installation (e.g. public, industrial). The range offers three different voltages. (Ranges: 12-48 V AC/DC; 115-250 V AC and 110-220 V DC).

E215-... Pushbuttons (6 different button colors)

Contacts	Rated voltage	Power loss	Button color	Width	Catalog number
	VAC	W		mm	
Rated current = 16A					
1NO+1NC	250	0.50	Grey	9	E215-16-11B
1NO+1NC	250	0.50	Red	9	E215-16-11C
1NO+1NC	250	0.50	Green	9	E215-16-11D
1NO+1NC	250	0.50	Yellow	9	E215-16-11E
1NO+1NC	250	0.50	Black	9	E215-16-11F
1NO+1NC	250	0.50	Blue	9	E215-16-11G

E217-... Luminous pushbuttons (5 different LED colors)

Contacts	Rated voltage	Power loss	Button color	Width	Catalog number
	VAC	W		mm	
Rated current = 16A					
LED Voltage range - 115-250VAC					
1NO	250	1.10	White	9	E217-16-10B
1NO	250	1.10	Red	9	E217-16-10C
1NO	250	1.10	Green	9	E217-16-10D
1NO	250	1.10	Yellow	9	E217-16-10E
1NO	250	1.10	Blue	9	E217-16-10G
1NC	250	1.10	White	9	E217-16-01B
1NC	250	1.10	Red	9	E217-16-01C
1NC	250	1.10	Green	9	E217-16-01D
1NC	250	1.10	Yellow	9	E217-16-01E
1NC	250	1.10	Blue	9	E217-16-01G

E210 Pushbuttons with and without LEDs



E217-... Luminous pushbuttons (5 different LED colors)

Contacts	Rated voltage	Power loss	Button color	Width	Catalog number
	VAC	W		mm	

Rated current = 16A

LED voltage range - 12-48VAC/DC

1NO	250	0.72	White	9	E217-16-10B48
1NO	250	0.72	Red	9	E217-16-10C48
1NO	250	0.72	Green	9	E217-16-10D48
1NO	250	0.72	Yellow	9	E217-16-10E48
1NO	250	0.72	Blue	9	E217-16-10G48
1NC	250	0.72	White	9	E217-16-01B48
1NC	250	0.72	Red	9	E217-16-01C48
1NC	250	0.72	Green	9	E217-16-01D48
1NC	250	0.72	Yellow	9	E217-16-01E48
1NC	250	0.72	Blue	9	E217-16-01G48

LED voltage range - 110-220VDC

1NO	250	1.50	White	9	E217-16-10B220
1NO	250	1.50	Red	9	E217-16-10C220
1NO	250	1.50	Green	9	E217-16-10D220
1NO	250	1.50	Yellow	9	E217-16-10E220
1NO	250	1.50	Blue	9	E217-16-10G220
1NC	250	1.50	White	9	E217-16-01B220
1NC	250	1.50	Red	9	E217-16-01C220
1NC	250	1.50	Green	9	E217-16-01D220
1NC	250	1.50	Yellow	9	E217-16-01E220
1NC	250	1.50	Blue	9	E217-16-01G220

E210 Indicator lights with LEDs



E219-... Indicator Lights with LED (5 different colors)

Single indicator light - LED Voltage range = 115-250 V AC

Button color	Power loss	Width	Catalog number
	W	mm	
White	0.47	9	E219-B
Red	0.47	9	E219-C
Green	0.47	9	E219-D
Yellow	0.47	9	E219-E
Blue	0.47	9	E219-G

The new products are available in 9 mm width (= 0.5 modules) and can be used for indicating any operational condition such as signalling loss of a phase. The range offers three different voltages. (Ranges: 12-48 V AC/DC; 115-250 V AC and 110-220 V DC).



Single indicator light - LED Voltage range = 12-48 V AC/DC

Button color	Power loss	Width	Catalog number
	W	mm	
White	0.40	9	E219-B48
Red	0.40	9	E219-C48
Green	0.40	9	E219-D48
Yellow	0.40	9	E219-E48
Blue	0.40	9	E219-G48



Single indicator light - LED Voltage range = 110-220 V DC

Button color	Power loss	Width	Catalog number
	W	mm	
White	1.00	9	E219-B220
Red	1.00	9	E219-C220
Green	1.00	9	E219-D220
Yellow	1.00	9	E219-E220
Blue	1.00	9	E219-G220

Terminal assignment

Pushbutton



Luminous Pushbutton

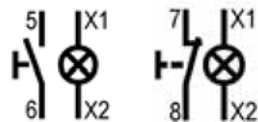

Indicator Light

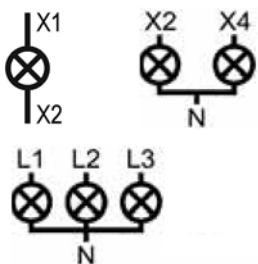

Technical data

Pushbuttons and Single indicator light

Rated Voltage Un	[V]	250/400
Lowest operat. voltage		24 V; 25 mA
Rated current In	[A]	16
LED current	[mA]	5
Rated frequency	[Hz]	50/60
Modules	[No]	0.5
Tightening torque	[Nm]	1.2 - 1.5
Standards		EN 60669-1; EN 62094-1; UL 508
Approvals		Pushbuttons: VDE, UL, GOST, CCC Single Indicator light: VDE, UL, GOST

E210 Accessories



E210-DH

Dummy housing for 9 mm wide units

Item	Catalog number
Dummy housing for 9mm wide units	E210-DH

The modular width of 18 mm must be complied with to use the devices in the SMISLINE socket system. The dummy housing is ready-made with two expanding connectors. Always snap on dummy housing on the left.

Padlock

Item	Catalog number
to use for 9 and 18mm wide units	E210-ASV9



E210-ASV9

