

# AF16-30-10-.. / AF16Z-30-10-.. 3-pole Contactors AC / DC Operated - with Screw Terminals

AF16(Z) contactors are used for controlling power circuits up to 690 V AC and 220 V DC. They are mainly used for controlling 3-phase motors, non-inductive or slightly inductive loads.

- AF..(Z) contactors include an electronic coil interface providing reduced pull-in and holding consumption, particularly for AC control circuits
- Only four coils are needed to cover control voltages between 24...500 V 50/60 Hz or 20...500 V DC.
- AF..(Z) offer extended operating limits and are suitable worldwide for different control voltages. e.g.: the coil 100...250 V 50/60 Hz - DC is suitable for Europe (230 V 50 Hz) and for North America (120 V 60 Hz and 208 V 60 Hz).
- AF..(Z) contactors can manage large control voltage variations
- AF.Z contactors equipped with a 24...60 V 50/60 Hz - 20...60 V DC coil allow direct control by 24 V DC 500 mA PLC-output
- AF.Z contactors withstand short voltage dips and voltage sags (SEMI F47-0706 compliance)
- AF..(Z) contactors have built-in surge protection and do not require additional surge suppressors.



		7.5 kW	
		10 hp	

3D CAD outline drawings available on «Control Product 3D» portal

### Ordering Details

IEC	UL/CSA	Control voltage		Main contacts	Auxiliary contacts fitted	Type	Order code	EAN	Weight
Rated power	3-phase motor rating	Uc min. ... Uc max.							Pack <sup>(ing)</sup>
400 V	480 V	V 50/60 Hz	V DC						1 piece
kW	hp								kg

### 3-pole Contactors

7.5	10	24...60	20...60	3 0	1 0	<b>AF16-30-10-11</b>	<b>1SBL 177 001 R1110</b>	3471523110618	0.270
		48...130	48...130	3 0	1 0	<b>AF16-30-10-12</b>	<b>1SBL 177 001 R1210</b>	3471523110625	0.270
		100...250	100...250	3 0	1 0	<b>AF16-30-10-13</b>	<b>1SBL 177 001 R1310</b>	3471523110632	0.270
		250...500	250...500	3 0	1 0	<b>AF16-30-10-14</b>	<b>1SBL 177 001 R1410</b>	3471523110649	0.310

Note: AF16-30-10-11 not suitable for a direct control by PLC-output. AF16-30-10-11 available in some countries: please consult your ABB representative.

### 3-pole Contactors - Low Consumption



7.5	10	-	12...20	3 0	1 0	<b>AF16Z-30-10-20</b>	<b>1SBL 176 001 R2010</b>	3471523113800	0.310
		24...60	20...60	3 0	1 0	<b>AF16Z-30-10-21</b>	<b>1SBL 176 001 R2110</b>	3471523113817	0.310
		48...130	48...130	3 0	1 0	<b>AF16Z-30-10-22</b>	<b>1SBL 176 001 R2210</b>	3471523113824	0.310
		100...250	100...250	3 0	1 0	<b>AF16Z-30-10-23</b>	<b>1SBL 176 001 R2310</b>	3471523113831	0.310

Note: Only AF.Z contactors with DC control voltage 12...20 V DC need to respect the connection polarities indicated close to the coil terminals: A1+ for the positive pole and A2- for the negative pole

### Certifications and Approvals

CE	cULus	CCC	GOST	C-Tick					

## Main Pole - Utilization Characteristics according to IEC

<b>Standards</b>	IEC 60947-1 / 60947-4-1 and EN 60947-1 / 60947-4-1	
<b>Rated operational voltage <math>U_e</math> max.</b>	690 V	
<b>Rated frequency limits</b>	25 ... 400 Hz	
<b>Conventional free-air thermal current <math>I_{th}</math></b> acc. to IEC 60947-4-1, open contactors, $\theta \leq 40^\circ\text{C}$	35 A	
with conductor cross-sectional area	6 mm <sup>2</sup>	
<b>AC-1 Utilization category</b> for air temperature close to contactor		
<b><math>I_e</math> / AC-1 rated operational current</b>	$\theta \leq 40^\circ\text{C}$	30 A
$U_e$ max. $\leq 690\text{ V}$ , 50/60 Hz	$\theta \leq 60^\circ\text{C}$	30 A
	$\theta \leq 70^\circ\text{C}$	26 A
with conductor cross-sectional area	6 mm <sup>2</sup>	
<b>AC-3 Utilization category</b> for air temperature close to contactor $\theta \leq 60^\circ\text{C}$ (for 1500 r.p.m., 50 Hz or 1800 r.p.m., 60 Hz, 3-phase motors)		
<b><math>I_e</math> / AC-3 max. rated operational current</b>	<b>220-230-240 V</b>	18 A
 3-phase motors	<b>380-400 V</b>	18 A
	<b>415 V</b>	18 A
	<b>440 V</b>	18 A
	<b>500 V</b>	15 A
	<b>690 V</b>	10.5 A
	<b>AC-3 rated operational power</b>	<b>220-230-240 V</b>
 1500 r.p.m. 50 Hz 1800 r.p.m. 60 Hz 3-phase motors	<b>380-400 V</b>	7.5 kW
	<b>415 V</b>	9 kW
	<b>440 V</b>	9 kW
	<b>500 V</b>	9 kW
	<b>690 V</b>	9 kW
	<b>Rated making capacity AC-3</b>	10 x $I_e$ AC-3 acc. to IEC 60947-4-1
<b>Rated breaking capacity AC-3</b>	8 x $I_e$ AC-3 acc. to IEC 60947-4-1	
<b>AC-8a Utilization category</b> (without thermal overload relay - $U_e 400\text{ V}$ - $\theta \leq 40^\circ\text{C}$ )		
<b><math>I_e</math> / AC-8a rated operational current</b>	22 A	
<b>AC-8a rated operational power</b>	11 kW	
<b>Short-circuit protection for contactors</b> without thermal O/L relay - Motor protection excluded $U_e \leq 500\text{ V AC}$ - gG type fuse	32 A	
<b>Rated short-time withstand current <math>I_{cw}</math></b> at $40^\circ\text{C}$ ambient temperature, in free air from a cold state	<b>1 s</b>	300 A
	<b>10 s</b>	150 A
	<b>30 s</b>	80 A
	<b>1 min</b>	60 A
	<b>15 min</b>	35 A
<b>Maximum breaking capacity</b>	<b>at 440 V</b>	250 A
$\cos \phi = 0.45$	<b>at 690 V</b>	106 A
<b>Heat dissipation per pole</b>	<b><math>I_e</math> / AC-1</b>	1.2 W
	<b><math>I_e</math> / AC-3</b>	0.35 W
<b>Max. electrical switching frequency</b>	<b>AC-1</b>	600 cycles/h
	<b>AC-3</b>	1200 cycles/h
	<b>AC-2, AC-4</b>	300 cycles/h

## Built-in Auxiliary Contacts according to IEC

Rated operational voltage U <sub>e</sub> max.		690 V
Conventional free air thermal current I <sub>th</sub> - θ ≤ 40 °C		16 A
Rated frequency limits		25 ... 400 Hz
Rated operational current I <sub>e</sub> / AC-15		
acc. to IEC 60947-5-1	24-127 V 50/60 Hz	6 A
	220-240 V 50/60 Hz	4 A
	400-440 V 50/60 Hz	3 A
	500 V 50/60 Hz	2 A
	690 V 50/60 Hz	2 A
Making capacity AC-15		10 x I <sub>e</sub> AC-15 acc. to IEC 60947-5-1
Breaking capacity AC-15		10 x I <sub>e</sub> AC-15 acc. to IEC 60947-5-1
Rated operational current I <sub>e</sub> / DC-13		
acc. to IEC 60947-5-1	24 V DC	16 A / 144 W
	48 V DC	2.8 A / 134 W
	72 V DC	1 A / 72 W
	110 V DC	0.55 A / 60 W
	125 V DC	0.55 A / 69 W
	220 V DC	0.27 A / 60 W
	250 V DC	0.27 A / 68 W
	400 V DC	0.15 A / 60 W
	500 V DC	0.13 A / 65 W
	600 V DC	0.1 A / 60 W
Short-circuit protection gG type fuse		10 A
Rated short-time withstand current I <sub>cw</sub>	for 1.0 s	100 A
	for 0.1 s	140 A
Minimum switching capacity		12 V / 3 mA
with failure rate acc. to IEC 60947-5-4		10 <sup>-7</sup>
Non-overlapping time between N.O. and N.C. contacts		≥ 2 ms
Heat dissipation per pole at 6 A		0.1 W
Max. electrical switching frequency	AC-15	1200 cycles/h
	DC-13	900 cycles/h

## Main Pole - Utilization Characteristics according to UL / NEMA / CSA

Standards		UL 508, CSA C22.2 N°14
Rated operational voltage U <sub>e</sub> max.		600 V
NEMA size		-
NEMA continuous amp rating	thermal current	
NEMA maximum H.P. ratings 1-phase, 60 Hz	115 V AC	
	230 V AC	
NEMA maximum H.P. ratings 3-phase, 60 Hz	200 V AC	
	230 V AC	
	460 V AC	
	575 V AC	
UL General use rating		
600 V AC		30 A
With conductor cross-sectional area		AWG 10
80 V DC - 1-pole		30 A
With conductor cross-sectional area		AWG 10
UL maximum 1-phase motor rating		
Amp-rating	120 V AC	20 A
	240 V AC	17 A
Motor power	120 V AC	1-1/2 hp
	240 V AC	3 hp
UL maximum 3-phase motor rating		
Amp-rating	200-208 V AC	17.5 A
	220-240 V AC	15.2 A
	440-480 V AC	14 A
	550-600 V AC	17 A
Motor power	200-208 V AC	5 hp
(for 1500 r.p.m., 50 Hz or 1800 r.p.m., 60 Hz 3-phase motors)	220-240 V AC	5 hp
	440-480 V AC	10 hp
	550-600 V AC	15 hp
Short-circuit protection		
for contactors without thermal O/L relay - Motor protection excluded		
Fuse rating		60 A
Fuse type, 600 V		NTD
Max. electrical switching frequency		
for general use		600 cycles/h
for motor use		1200 cycles/h

## Built-in Auxiliary Contacts according to UL / CSA

Max. rated operational voltage $U_e$ max.	600 V AC, 600 V DC
Pilot duty	A600, Q600
AC thermal rated current	10 A
AC maximum volt-ampere making	7200 VA
AC maximum volt-ampere breaking	720 VA
DC thermal rated current	2.5 A
DC maximum volt-ampere making-breaking	69 VA

## General Technical Data

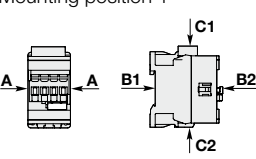
Rated insulation voltage $U_i$ acc. to IEC 60947-4-1	690 V
acc. to UL / CSA	600 V
Rated impulse withstand voltage $U_{imp}$	6 kV
Electromagnetic compatibility	Devices complying with IEC 60947-1 / EN 60947-1 - Environment A
Ambient air temperature close to contactor	
Operation fitted with thermal overload relay	-25 ... +60 °C
without thermal overload relay	-40 ... +70 °C
Storage	-60 ... +80 °C
Climatic withstand	Category B according to IEC 60947-1 Annex Q
Operating altitude	≤ 3000 m
Mechanical durability	
Number of operating cycles	10 millions operating cycles
Max. switching frequency	3600 cycles/h
Shock withstand acc. IEC 60068-2-27 and EN 60068-2-27	
Mounting position 1	
	
Shock direction	1/2 sinusoidal shock for 11 ms: no change in contact position
A	30 g
B1	25 g Closed position / 5 g Open position
B2	15 g
C1	25 g
C2	25 g
Vibration withstand acc. to IEC 60068-2-6	
	5 ... 300 Hz
	4 g Closed position / 2 g Open position

## Magnet System Characteristics

Coil operating limits acc. to IEC 60947-4-1	AC supply	at $\theta \leq 60$ °C 0.85 x $U_c$ min ... 1.1 x $U_c$ max at $\theta \leq 70$ °C 0.85 x $U_c$ min ... $U_c$ max
	DC supply	at $\theta \leq 60$ °C 0.85 x $U_c$ min ... 1.1 x $U_c$ max at $\theta \leq 70$ °C (AF) 0.85 x $U_c$ min ... $U_c$ max - (AF..Z) 0.85 x $U_c$ min ... 1.1 x $U_c$ max
AC control voltage 50/60 Hz	Rated control circuit voltage $U_c$	24 ... 500 V AC
	Coil consumption	Average pull-in value (AF) 50 VA - (AF..Z) 16 VA Average holding value (AF) 2.2 VA / 2 W - (AF..Z) 1.7 VA / 1.5 W
DC control voltage	Rated control circuit voltage $U_c$	12 ... 500 V DC
	Coil consumption	Average pull-in value (AF) 50 W - (AF..Z) 12 ... 16 W Average holding value (AF) 2 W - (AF..Z) 1.7 W
PLC-Output control		(AF..Z) ≥ 500 mA 24 V DC
Drop-out voltage in % of $U_c$ min.		≤ 60 % $U_c$ min
Voltage sag immunity according to SEMI F47-0706		(AF..Z) conditions of use on request
Dips withstand (level 0% according to IEC 61000-4-11) -20 °C ≤ $\theta$ ≤ +60 °C		(AF..Z) 22 ms average for $U_c = 24$ ... 250 V 50/60Hz
Operating time		
between coil energization and:	N.O. contact closing	40 ... 95 ms
	N.C. contact opening	38 ... 90 ms
between coil de-energization and:	N.O. contact opening	11 ... 95 ms
	N.C. contact closing	13 ... 98 ms

## Mounting Characteristics

### Mounting positions

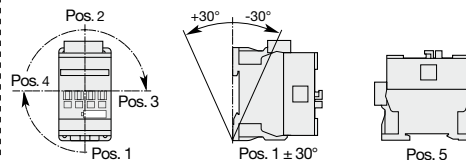

Max. N.C. built-in and add-on N.C. auxiliary contacts: see accessory fitting details for a 3-pole contactor AF09 ... AF38

### Mounting distances

The contactors can be assembled side by side.

### Fixing

on rail according to IEC 60715, EN 60715  
by screws (not supplied)

35 x 7.5 mm or 35 x 15 mm  
2 x M4 screws placed diagonally

## Connecting Characteristics

### Main terminals



Screw terminals with cable clamp

### Connecting capacity (min. ... max.)

#### Main conductors (poles)

	Rigid	solid ( $\leq 4 \text{ mm}^2$ )	1 x	1 ... 6 mm <sup>2</sup>
		stranded ( $\geq 6 \text{ mm}^2$ )	2 x	1 ... 6 mm <sup>2</sup>
	Flexible with non insulated ferrule		1 x	0.75 ... 6 mm <sup>2</sup>
			2 x	0.75 ... 6 mm <sup>2</sup>
	Flexible with insulated ferrule		1 x	0.75 ... 4 mm <sup>2</sup>
			2 x	0.75 ... 2.5 mm <sup>2</sup>
	Bars or lugs		L <	9.6 mm

Capacity according to UL/CSA 1 or 2 x AWG 16 ... 10

Stripping length 10 mm

#### Auxiliary conductors

(built-in auxiliary terminals + coil terminals)

	Rigid solid		1 x	1 ... 2.5 mm <sup>2</sup>
			2 x	1 ... 2.5 mm <sup>2</sup>
	Flexible with non insulated ferrule		1 x	0.75 ... 2.5 mm <sup>2</sup>
			2 x	0.75 ... 2.5 mm <sup>2</sup>
	Flexible with insulated ferrule		1 x	0.75 ... 2.5 mm <sup>2</sup>
			2 x	0.75 ... 1.5 mm <sup>2</sup>
	Bars or lugs		L <	8 mm

Capacity according to UL/CSA 1 or 2 x AWG 18 ... 14

Stripping length 10 mm

### Degree of protection

acc. to IEC 60947-1 / EN 60947-1 and IEC 60529 / EN 60529

Main terminals IP20

Coil terminals IP20

Built-in auxiliary terminals IP20

### Screw terminals

(delivered in open position, screws of unused terminals must be tightened)

Main terminals M3.5

Coil terminals M3.5

Built-in auxiliary terminals M3.5

### Screwdriver type

Flat  $\varnothing 5.5$  / Pozidriv 2

### Tightening torque

Main pole terminals 1.5 Nm / 13 lb.in

Coil terminals 1.2 Nm / 11 lb.in

Built-in auxiliary terminals 1.2 Nm / 11 lb.in

## Accessory Fitting Details for a 3-pole Contactor

Many configurations of accessories are possible depending on whether these are front-mounted or side-mounted.

Main poles	Built-in auxiliary contacts	Front-mounted accessories				Electrical and mechanical interlock set (between 2 contactors)	Side-mounted accessories	
		Auxiliary contact blocks					Auxiliary contact blocks	
		1-pole CA4		2-pole CAT4-11	4-pole CA4	VEM4	Left side	Right side
		1-pole CC4					2-pole CAL4-11	
Max. N.C. built-in and add-on N.C. auxiliary contacts: 4 N.C. max. on positions 1, 2, 3, 4 and 3 N.C. max. on positions 1 ±30°, 5								
3 0 1 0	▶	4 max.	or 1		or 1	–	+ 1	–
		2 max.	or 1		–	–	+ 1	+ 1
		3 max.	–		–	+ 1	+ 1	or 1

## Overview of main accessories (other accessories available)

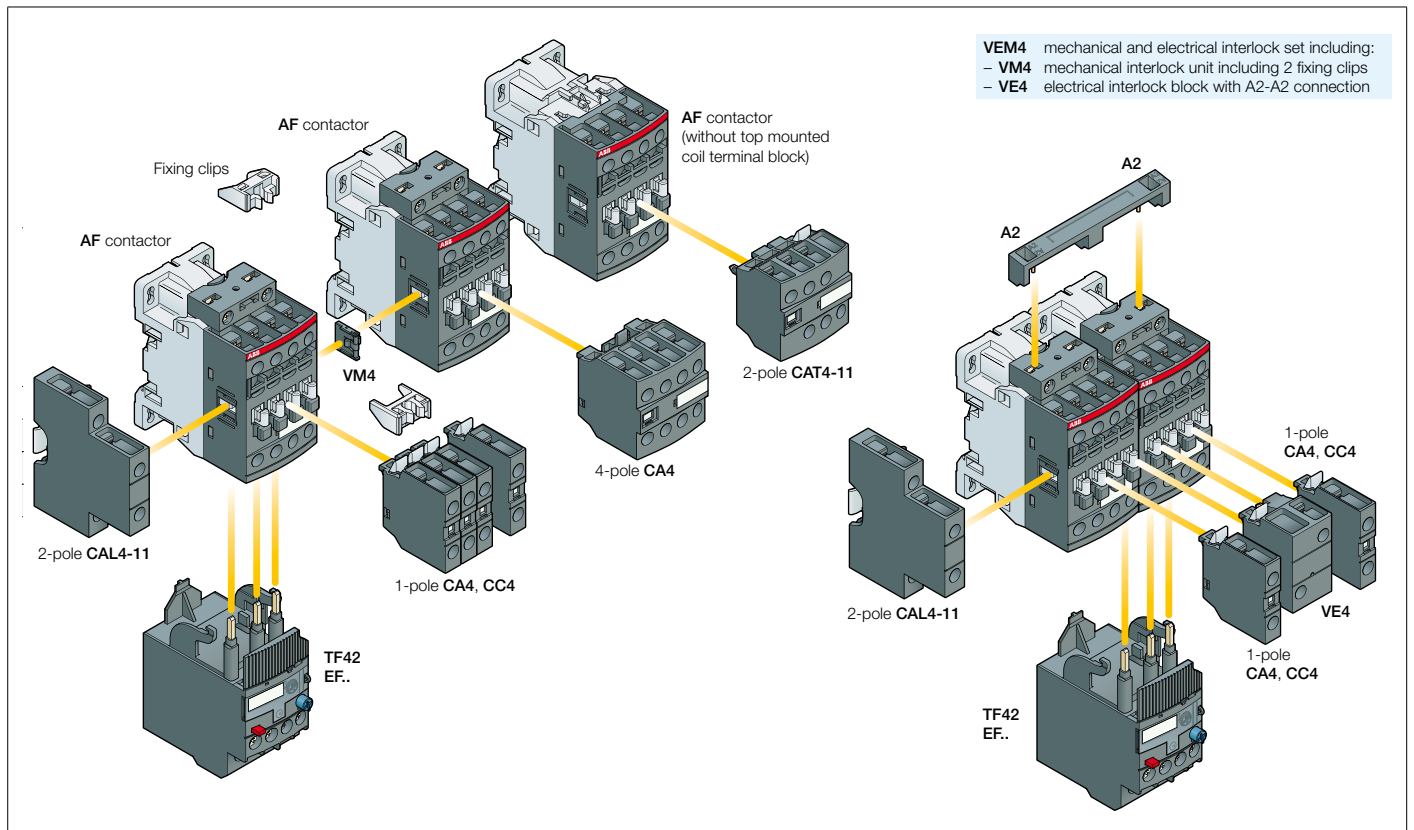

## Main Accessories

### Ordering Details

Description	Auxiliary contacts 	Type	Order code	EAN	Pack <sup>(ing)</sup> piece	Weight	
						kg (1 pce)	
<b>Additional auxiliary contact blocks</b>	Front-mounted instantaneous auxiliary contact blocks	0 1 - -	CA4-01	1SBN 010 110 R1001	3471523130029	1	0.014
		1 0 - -	CA4-10	1SBN 010 110 R1010	3471523130005	1	0.014
		0 1 - -	CA4-01-T	1SBN 010 110 T1001	3471523130395	10	0.014
		1 0 - -	CA4-10-T	1SBN 010 110 T1010	3471523130371	10	0.014
	Front-mounted auxiliary contact blocks with N.O. leading contact and N.C. lagging contact	- - 0 1	CC4-01	1SBN 010 111 R1001	3471523130432	1	0.014
		- - 1 0	CC4-10	1SBN 010 111 R1010	3471523130425	1	0.014
	Side-mounted instantaneous auxiliary contact blocks	1 1 - -	CAL4-11	1SBN 010 120 R1011	3471523130043	1	0.040
		1 1 - -	CAL4-11-T	1SBN 010 120 T1011	3471523130418	10	0.040
	Front-mounted instantaneous auxiliary contact blocks	0 4 - -	CA4-04M	1SBN 010 140 R1104	3471523130197	1	0.055
		1 3 - -	CA4-13M	1SBN 010 140 R1113	3471523130180	1	0.055
	2 2 - -	CA4-22M	1SBN 010 140 R1122	3471523130166	1	0.055	
	3 1 - -	CA4-31M	1SBN 010 140 R1131	3471523130173	1	0.055	
	Front-mounted instantaneous auxiliary contact and A1/A2 coil terminal blocks	1 1 - -	CAT4-11M	1SBN 010 151 R1111	3471523130074	1	0.040
<b>Interlocks</b>	Mechanical interlock unit		VM4	1SBN 030 105 T1000	3471523130609	10	0.005
	Mechanical and electrical interlock set	1 1 - -	VEM4	1SBN 030 111 R1000	3471523130616	1	0.035
	Fixing clips		BB4	1SBN 110 120 W1000	3471523130722	50	0.002
<b>Connection accessories for starting</b>	Connecting links with manual motor starters		BEA16-4	1SBN 081 306 T1000	3471523130739	10	0.025
	Connection sets for reversing contactors		BER16-4	1SBN 081 311 R1000	3471523130777	1	0.045
<b>Additional coil terminal block</b>	Additional coil terminal block		LDC4	1SBN 070 156 T1000	3471523130678	10	0.010
<b>Protective covers</b>	Protective covers		BX4	1SBN 110 108 T1000	3471523130708	10	0.006
			BX4-CA	1SBN 110 109 W1000	3471523130715	50	0.001
<b>Function markers</b>	Function markers		BA4	1SNA 235 156 R2700	3472592351568	16	0.011
			HTP500-BA4	1SNA 235 712 R2400	3472592357126	1	0.220
			SPRC 1	1SNA 360 010 R1500	3472593600108	1	0.290

Note:

- CAT4: not fittable on AF..Z contactors with DC control voltage 12...20VDC.
- VM4: includes 2 fixing clips (BB4) to maintain together both contactors.
- VEM4: includes a VM4 mechanical interlock unit with 2 fixing clips (BB4), a VE4 electrical interlock block and A2-A2 connection. VE4 block must be used with its A2-A2 connection to respect the electrical connection diagram.
- VE4 not fittable on AF..Z contactors with DC control voltage 12...20 V DC.

## Terminal Marking and Positioning

Standard devices without addition of auxiliary contacts

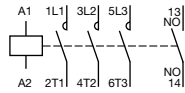
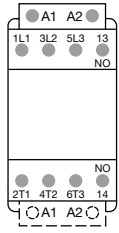

**AF16-30-10.. / AF16Z-30-10..**

**AF16-30-10.. / AF16Z-30-10..**

## Dimensions mm, inches

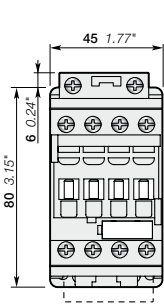

**AF16**

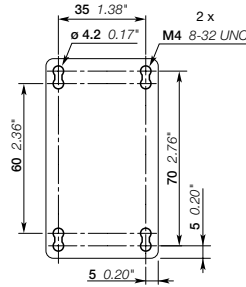
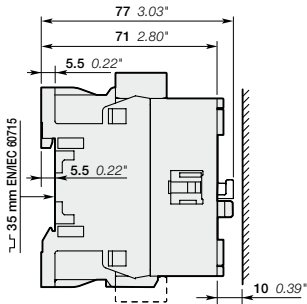

**AF16**

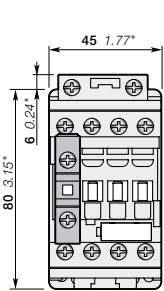

**AF16**

+ CA4, CC4 1-pole auxiliary contact block

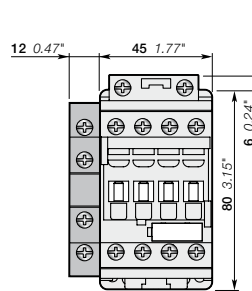
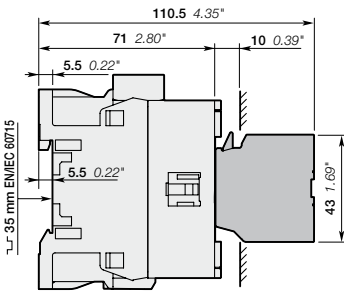

**AF16**

+ CAL4-11 2-pole auxiliary contact block

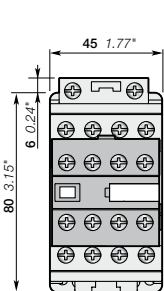
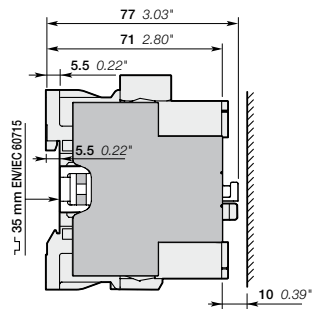

**AF16**

+ CA4 4-pole auxiliary contact block

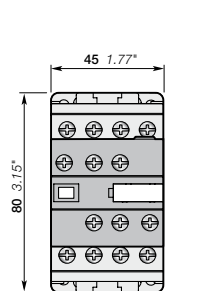
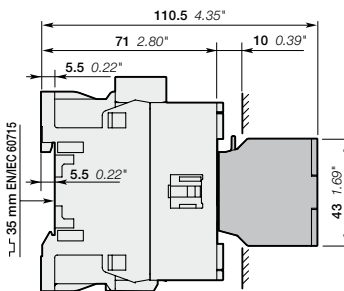

**AF16**

+ CAT4 2-pole auxiliary contact and coil terminal block

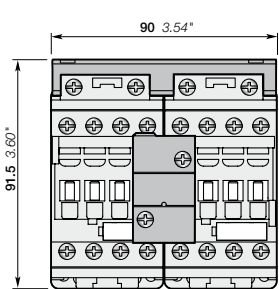
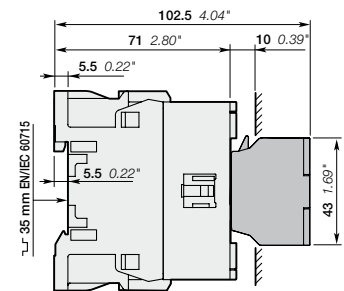

**AF16**

+ VEM4 mechanical and electrical interlock set

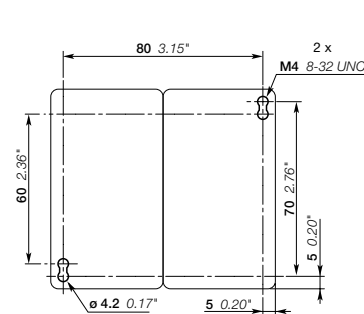
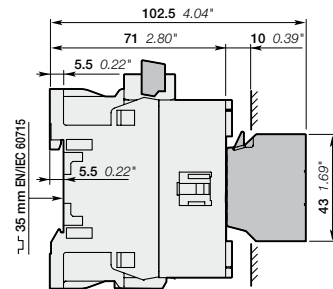

**AF16**

+ VEM4 mechanical and electrical interlock set

Note: contactor lateral distance to grounded component 2 mm 0.08" min.



# Contact us

## **ABB France**

### **Low Voltage Products Division**

10, rue Ampère Z.I. - B.P. 114  
F-69685 Chassieu cedex / France

You can find the address of your local sales organisation  
on the ABB home page  
<http://www.abb.com/contacts> -> Low Voltage products

## **Note**

We reserve the right to make technical changes or modify the contents of this document without prior notice. With regard to purchase orders, the agreed particulars shall prevail. ABB does not accept any responsibility whatsoever for potential errors or possible lack of information in this document.

We reserve all rights in this document and in the subject matter and illustrations contained therein. Any reproduction, disclosure to third parties or utilization of its contents – in whole or in parts – is forbidden without prior written consent of ABB.

Copyright© 2011 ABB  
All rights reserved