

SV 7.62HP/02/270MF2 3.5SN BK BX

Weidmüller Interface GmbH & Co. KG

Klingenbergstraße 26

D-32758 Detmold

Germany

www.weidmueller.com

Product image

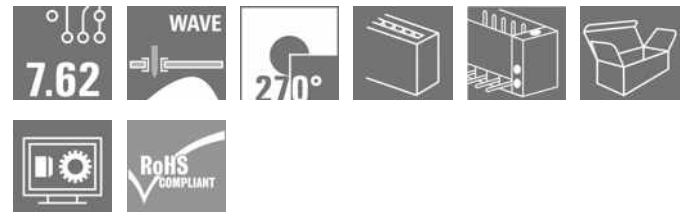
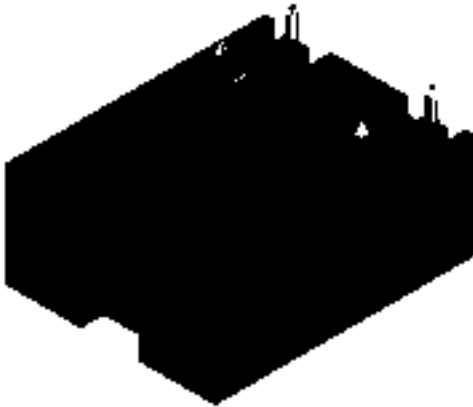

270° male header with middle flange with a 7.62 pitch. Meets the requirements of IEC 61800-5-1 and enables UL approval as per UL840 600 V. Without a female header, the mating profile guarantees minimum touch safety of >3 mm with 20 N pressure on the test finger. The automatically locking middle flange which can optionally also be screwed, reduces space requirements by one pitch width in comparison with conventional solutions.

On request: available with screw flange or without flange.

General ordering data

Version	PCB plug-in connector, male header, closed side, Middle flange, THT solder connection, 7.62 mm, Number of poles: 2, 270°, Solder pin length (l): 3.5 mm, tinned, black, Box
Order No.	1048370000
Type	SV 7.62HP/02/270MF2 3.5SN BK BX
GTIN (EAN)	4032248786657
Qty.	78 pc(s).
Product data	IEC: 1000 V / 57 A UL: 300 V / 40.5 A
Packaging	Box

Creation date October 11, 2023 10:58:59 AM CEST

SV 7.62HP/02/270MF2 3.5SN BK BX

Weidmüller Interface GmbH & Co. KG

Klingenbergstraße 26

D-32758 Detmold

Germany

www.weidmueller.com

Technical data

Dimensions and weights

Depth	28.3 mm	Depth (inches)	1.114 inch
Height	14.9 mm	Height (inches)	0.587 inch
Height of lowest version	11.4 mm	Width	22.86 mm
Width (inches)	0.9 inch	Net weight	6.13 g

Temperatures

Operating temperature, min.	-50 °C	Operating temperature, max.	130 °C
-----------------------------	--------	-----------------------------	--------

System specifications

Product family	OMNIMATE Power - series BV/SV 7.62HP	Type of connection	Board connection
Mounting onto the PCB	THT solder connection	Pitch in mm (P)	7.62 mm
Pitch in inches (P)	0.3 inch	Outgoing elbow	270°
Number of poles	2	Number of solder pins per pole	2
Solder pin length (l)	3.5 mm	Solder pin length tolerance	+0.1 / -0.3 mm
Solder pin dimensions	0.8 x 1.0 mm	Solder eyelet hole diameter (D)	1.3 mm
Solder eyelet hole diameter tolerance (D)	+ 0,1 mm	L1 in mm	15.24 mm
L1 in inches	0.6 inch	Number of rows	1
Pin series quantity	1	Touch-safe protection acc. to DIN VDE 57 106	Touch-safe above the printed circuit board
Touch-safe protection acc. to DIN VDE 0470	IP 20	Protection degree	IP20, when fully mounted
Volume resistance	2.00 mΩ	Can be coded	Yes
Plugging cycles	25		

Material data

Insulating material	PA GF	Colour	black
Colour chart (similar)	RAL 9011	Insulating material group	II
Comparative Tracking Index (CTI)	≥ 500	UL 94 flammability rating	V-0
Contact material	Copper alloy	Contact surface	tinned
Layer structure of solder connection	1...3 µm Ni / 4...6 µm Sn matt	Storage temperature, min.	-40 °C
Storage temperature, max.	70 °C	Operating temperature, min.	-50 °C
Operating temperature, max.	130 °C	Temperature range, installation, min.	-25 °C
Temperature range, installation, max.	130 °C		

Rated data acc. to IEC

tested acc. to standard	IEC 60664-1, IEC 61984	Rated current, min. number of poles (Tu=20°C)	57 A
Rated current, max. number of poles (Tu=20°C)	41 A	Rated current, min. number of poles (Tu=40°C)	41 A
Rated current, max. number of poles (Tu=40°C)	41 A	Rated voltage for surge voltage class / pollution degree II/2	1,000 V
Rated voltage for surge voltage class / pollution degree III/2	630 V	Rated voltage for surge voltage class / pollution degree III/3	630 V
Rated impulse voltage for surge voltage class/ pollution degree II/2	6 kV	Rated impulse voltage for surge voltage class/ pollution degree III/2	6 kV
Rated impulse voltage for surge voltage class/ contamination degree III/3	6 kV	Short-time withstand current resistance	3 x 1s with 420 A
Clearance, min.	6.9 mm	Creepage distance, min.	9.6 mm

SV 7.62HP/02/270MF2 3.5SN BK BX

Weidmüller Interface GmbH & Co. KG
 Klingenbergstraße 26
 D-32758 Detmold
 Germany

www.weidmueller.com

Technical data

Rated data acc. to CSA

Institute (CSA)		Certificate No. (CSA)	200039-1121690
Rated voltage (Use group B / CSA)	300 V	Rated voltage (Use group C / CSA)	300 V
Rated voltage (Use group D / CSA)	600 V	Rated current (Use group B / CSA)	35 A
Rated current (Use group C / CSA)	35 A	Rated current (Use group D / CSA)	5 A
Reference to approval values	Specifications are maximum values, details - see approval certificate.		

Rated data acc. to UL 1059

Institute (cURus)		Certificate No. (cURus)	E60693
Rated voltage (Use group B / UL 1059)	300 V	Rated voltage (Use group C / UL 1059)	300 V
Rated voltage (Use group D / UL 1059)	600 V	Rated current (Use group B / UL 1059)	40.5 A
Rated current (Use group C / UL 1059)	40.5 A	Rated current (Use group D / UL 1059)	5 A
Clearance distance, min.	6.9 mm	Creepage distance, min.	9.6 mm
Reference to approval values	Specifications are maximum values, details - see approval certificate.		

Packing

Packaging	Box	VPE length	30 mm
VPE width	135 mm	VPE height	350 mm

Classifications

ETIM 6.0	EC002637	ETIM 7.0	EC002637
ETIM 8.0	EC002637	ETIM 9.0	EC002637
ECLASS 9.0	27-44-04-02	ECLASS 9.1	27-44-04-02
ECLASS 10.0	27-44-04-02	ECLASS 11.0	27-46-02-01
ECLASS 12.0	27-46-02-01	ECLASS 13.0	27460201

Important note

IPC conformity	Conformity: The products are developed, manufactured and delivered according international recognized standards and norms and comply with the assured properties in the data sheet resp. fulfill decorative properties in accordance with IPC-A-610 "Class 2". Further claims on the products can be evaluated on request.
Notes	<ul style="list-style-type: none"> • Additional variants on request • Rated current related to rated cross-section & min. No. of poles. • P on drawing = pitch • Rated data refer only to the component itself. Clearance and creepage distances to other components are to be designed in accordance with the relevant application standards. • Long term storage of the product with average temperature of 50 °C and maximum humidity 70%, 36 months

Data sheet

SV 7.62HP/02/270MF2 3.5SN BK BX

Weidmüller Interface GmbH & Co. KG
 Klingenbergstraße 26
 D-32758 Detmold
 Germany

www.weidmueller.com

Technical data

Approvals

Approvals



ROHS	Conform
UL File Number Search	UL Website
Certificate No. (cURus)	E60693

Downloads

Approval/Certificate/Document of Conformity	Declaration of the Manufacturer
Engineering Data	CAD data – STEP
Catalogues	Catalogues in PDF-format
Brochures	FL DRIVES EN MB DEVICE MANUF. EN FL DRIVES DE FL HEATING ELECTR EN FL APPL INVERTER EN FL_BASE_STATION_EN FL ELEVATOR EN FL POWER SUPPLY EN FL 72H SAMPLE SER EN PO OMNIMATE EN PO OMNIMATE EN

SV 7.62HP/02/270MF2 3.5SN BK BX

Weidmüller Interface GmbH & Co. KG
 Klingenbergstraße 26
 D-32758 Detmold
 Germany

www.weidmueller.com

Accessories

Coding elements



The pluggable connections for power electronics - optimised for modern drive technologies, e.g. motor starters, frequency converters and servo-controllers.

OMNIMATE Power sets the new standard – with increased safety and innovative solutions such as the pluggable shield, integrated signal contacts and one-handed operation.

The three product lines offer you further advantages:

- Application-oriented scalability: from the compact 4 mm² connector for 29 A (IEC) or 20 A (UL) up to the sturdy 16 mm² connector for 76 A (IEC) or 54 A (UL)
- Unlimited usage up to 1,000 V (IEC) or 600 V (UL)
- A variety of application optimised mounting options

Our Service:

Design your individual connectors simply by using the

General ordering data

Type	BV/SV 7.62HP KO	Version	Product data	Packaging
Order No.	1937590000	PCB plug-in connector, Accessories, Coding element, black, Number		Box
GTIN (EAN)	4032248608881	of poles: 1		
Qty.	50 pc(s).			

allgemeingültige Kundenzeichnung, aktueller Stand nur auf Anfrage /
general customer drawing, topical version only if required

SHOWN: SV 7.62HP/04/90MSF

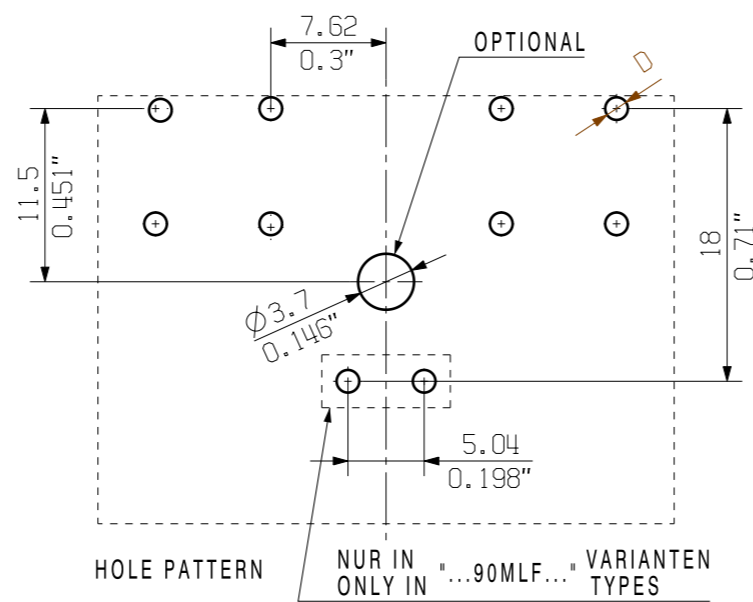
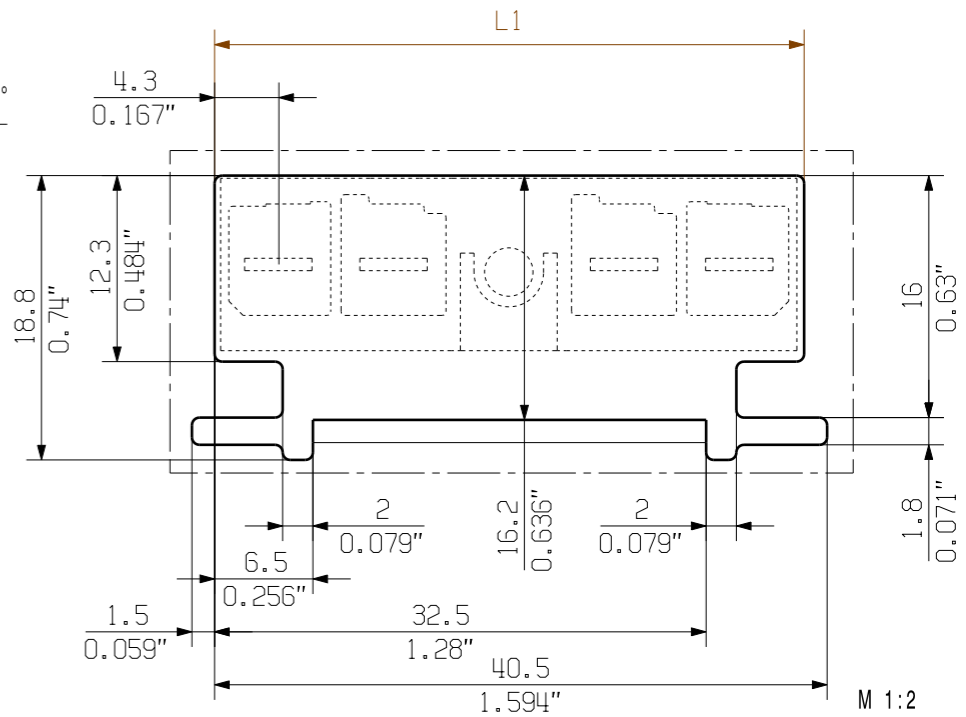
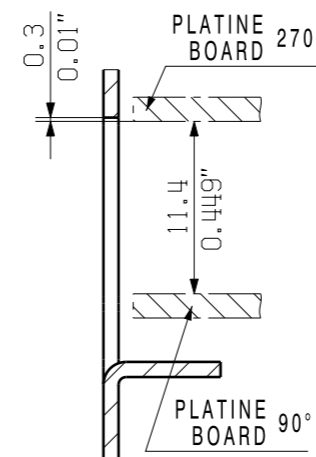
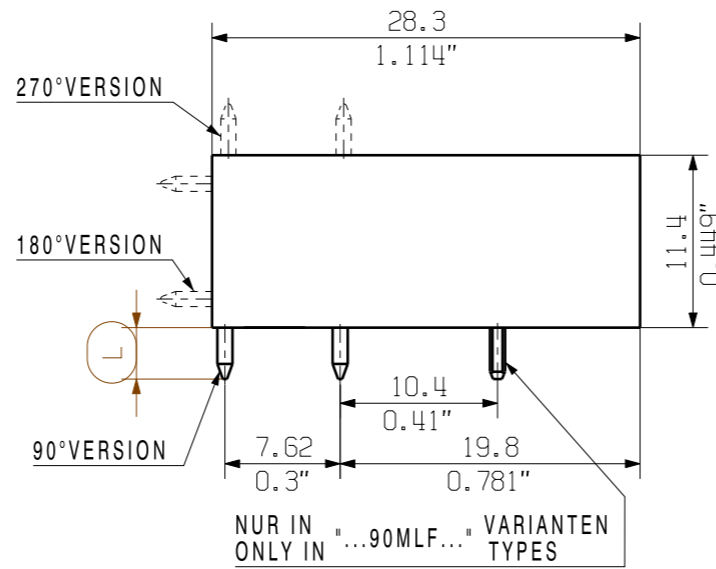
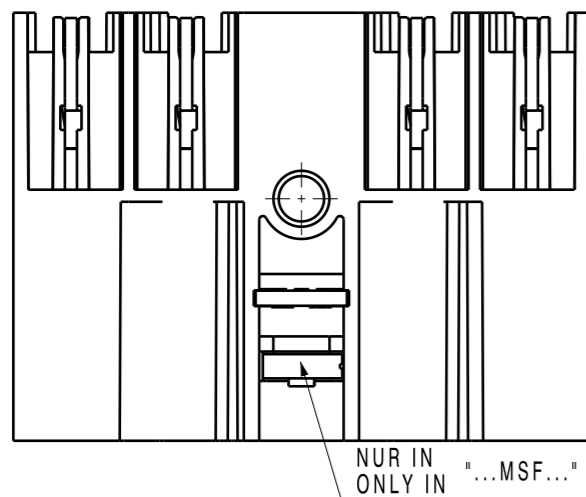
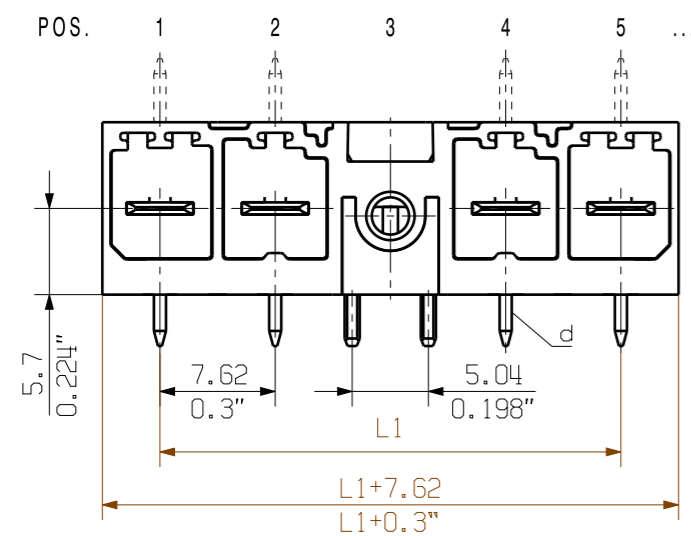

D=Ø1.3
d=0.8x1.0

MF= Mittelflansch
middle flange
MSF= Mittelschraubflansch
middle flange with screw
MLF= Mittellötflansch
middle solder flange

For the mounting of PCBs, it should be noted that the rated data relates only to the PCB components alone. The necessary creepage and clearance paths must be observed in connection with the respective applicant in accordance to IEC 664 / VDE 0110. The current-carrying capacity and pitch tolerance is to be determined according to DIN IEC 326 part 3 very fine.

Weidmüller PCB components are tested to the DIN EN 61984 standard, and are valid for its field of application. Provided that the components are used to the intended purpose, all requirements with respect to the occurring of electrical, mechanical, thermic and corrosive stress will be satisfied.

description	n no of poles	L1 [mm]	L1 [inch]	1	2	3	4	5	6	7	8	9
SV 7.62HP/08/...M(S/L)F5	8	60.92	2.34						MF			
SV 7.62HP/06/...M(S/L)F6									MF			
SV 7.62HP/06/...M(S/L)F5									MF			
SV 7.62HP/06/...M(S/L)F4	6	45.72	1.80						MF			
SV 7.62HP/06/...M(S/L)F3									MF			
SV 7.62HP/06/...M(S/L)F2									MF			
SV 7.62HP/05/...M(S/L)F5									MF			
SV 7.62HP/05/...M(S/L)F4	5	38.10	1.50						MF			
SV 7.62HP/05/...M(S/L)F3									MF			
SV 7.62HP/05/...M(S/L)F2									MF			
SV 7.62HP/04/...M(S/L)F4									MF			
SV 7.62HP/04/...M(S/L)F3	4	30.48	1.20						MF			
SV 7.62HP/04/...M(S/L)F2									MF			
SV 7.62HP/03/...M(S/L)F3	3	22.86	0.90						MF			
SV 7.62HP/03/...M(S/L)F2									MF			
SV 7.62HP/02/...M(S/L)F2	2	15.24	0.60						MF			

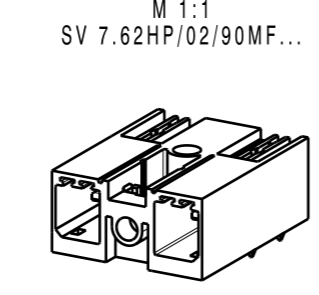
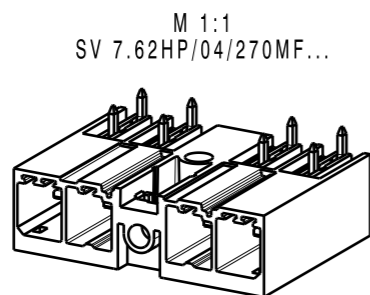
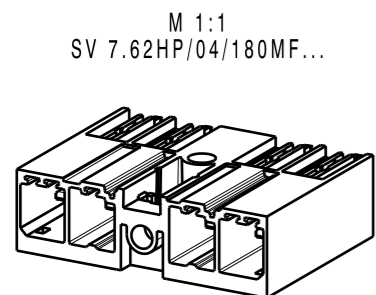
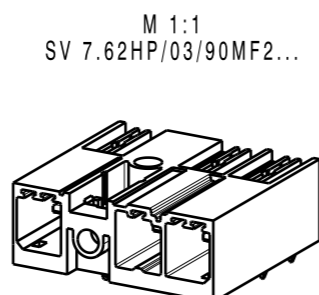
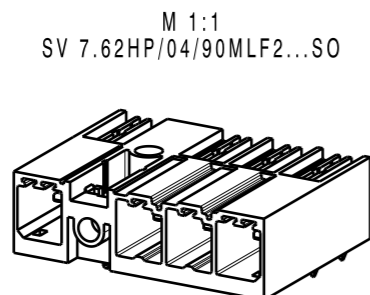
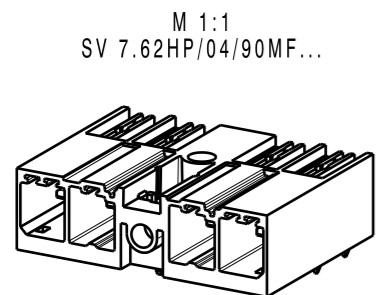

3.5	+0.1
	-0.3
Stiftlänge/ pin length L	Toleranz/ tolerance

GENERAL TOLERANCE:
DIN ISO 2768-m

Scale: 2:1
Supersedes: .

100459/5	12.06.18	HELIS_MA	00
Modification			
Drawn	24.02.2009	HELIS_MA	
Responsible		KRUG_M	
Checked	10.07.2018	HERTEL_S	
Approved		LANG_T	

Cat.no.: .

Weidmüller

3 49530 19

Drawing no. Issue no.

Sheet 01 of 01 sheets

SV 7.62HP...M(S/L)F...
STIFTLISTE
MALE HEADER

Product file: SV/BVZ 7.62HP

7340

The reproduction, distribution and utilization of this document as well as the communication of its contents to others without explicit authorization is prohibited. Offenders will be held liable for the payment of damages. Weidmüller exclusively reserves the right to file for patents, utility models or designs.

Recommended wave soldering profiles

Weidmüller Interface GmbH & Co. KG
 Klingenbergstraße 16
 D-32758 Detmold
 Germany
 Fon: +49 5231 14-0
 Fax: +49 5231 14-292083
 www.weidmueller.com

Single Wave:

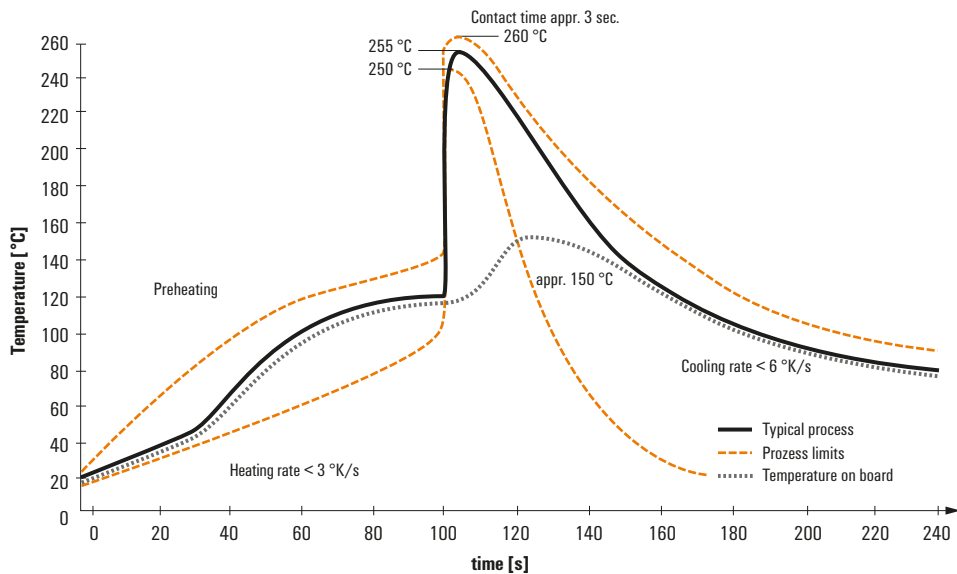

Double Wave:

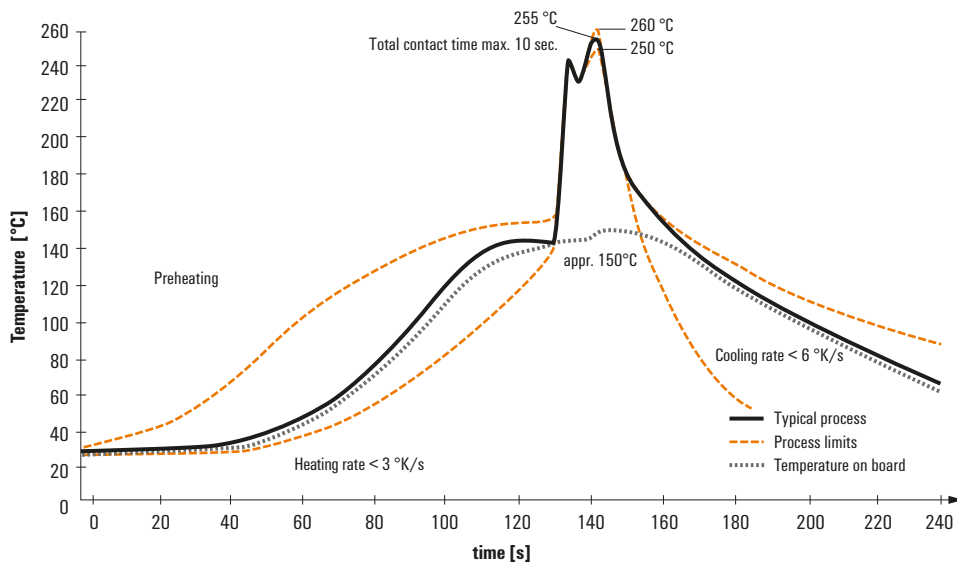

Wave soldering profiles

Wired connection elements should be processed in accordance with the DIN EN 61760-1 standard. We have included two recommendations for practical wave soldering profiles, with which Weidmüller PCB terminals and connectors are qualified.

When choosing a suitable profile for your application, the following factors also need to be considered:

- PCB thickness
- Proportion of Cu in the layers
- Single/double-sided assembly
- Product range
- Heating and cooling rates

The single and double wave profiles each indicate the recommended operating range, including the maximum soldering temperature of 260°C. In practice, the maximum soldering temperature is quite often well below the above maximum profile.