

# Notice for TAIYO YUDEN products

Please read this notice before using the TAIYO YUDEN products.

## ⚠️ REMINDERS

### ■ Product Information in this Catalog

Product information in this catalog is as of October 2019. All of the contents specified herein and production status of the products listed in this catalog are subject to change without notice due to technical improvement of our products, etc. Therefore, please check for the latest information carefully before practical application or use of our products.

Please note that TAIYO YUDEN shall not be in any way responsible for any damages and defects in products or equipment incorporating our products, which are caused under the conditions other than those specified in this catalog or individual product specification sheets.

### ■ Approval of Product Specifications

Please contact TAIYO YUDEN for further details of product specifications as the individual product specification sheets are available. When using our products, please be sure to approve our product specifications or make a written agreement on the product specification with TAIYO YUDEN in advance.

### ■ Pre-Evaluation in the Actual Equipment and Conditions

Please conduct validation and verification of our products in actual conditions of mounting and operating environment before using our products.

### ■ Limited Application

#### 1. Equipment Intended for Use

The products listed in this catalog are intended for general-purpose and standard use in general electronic equipment (e.g., AV equipment, OA equipment, home electric appliances, office equipment, information and communication equipment including, without limitation, mobile phone, and PC) and other equipment specified in this catalog or the individual product specification sheets.

TAIYO YUDEN has the line-up of the products intended for use in automotive electronic equipment, telecommunications infrastructure and industrial equipment, or medical devices classified as GHTF Classes A to C (Japan Classes I to III). Therefore, when using our products for these equipment, please check available applications specified in this catalog or the individual product specification sheets and use the corresponding products.

#### 2. Equipment Requiring Inquiry

Please be sure to contact TAIYO YUDEN for further information before using the products listed in this catalog for the following equipment (excluding intended equipment as specified in this catalog or the individual product specification sheets) which may cause loss of human life, bodily injury, serious property damage and/or serious public impact due to a failure or defect of the products and/or malfunction attributed thereto.

- (1) Transportation equipment (automotive powertrain control system, train control system, and ship control system, etc.)
- (2) Traffic signal equipment
- (3) Disaster prevention equipment, crime prevention equipment
- (4) Medical devices classified as GHTF Class C (Japan Class III)
- (5) Highly public information network equipment, data-processing equipment (telephone exchange, and base station, etc.)
- (6) Any other equipment requiring high levels of quality and/or reliability equal to the equipment listed above

#### 3. Equipment Prohibited for Use

Please do not incorporate our products into the following equipment requiring extremely high levels of safety and/or reliability.

- (1) Aerospace equipment (artificial satellite, rocket, etc.)
- (2) Aviation equipment \*<sup>1</sup>
- (3) Medical devices classified as GHTF Class D (Japan Class IV), implantable medical devices \*<sup>2</sup>

- (4) Power generation control equipment (nuclear power, hydroelectric power, thermal power plant control system, etc.)
- (5) Undersea equipment (submarine repeating equipment, underwater work equipment, etc.)
- (6) Military equipment
- (7) Any other equipment requiring extremely high levels of safety and/or reliability equal to the equipment listed above

\*Notes:

1. There is a possibility that our products can be used only for aviation equipment that does not directly affect the safe operation of aircraft (e.g., in-flight entertainment, cabin light, electric seat, cooking equipment) if such use meets requirements specified separately by TAIYO YUDEN. Please be sure to contact TAIYO YUDEN for further information before using our products for such aviation equipment.
2. Implantable medical devices contain not only internal unit which is implanted in a body, but also external unit which is connected to the internal unit.

#### 4. Limitation of Liability

Please note that unless you obtain prior written consent of TAIYO YUDEN, TAIYO YUDEN shall not be in any way responsible for any damages incurred by you or third parties arising from use of the products listed in this catalog for any equipment that is not intended for use by TAIYO YUDEN, or any equipment requiring inquiry to TAIYO YUDEN or prohibited for use by TAIYO YUDEN as described above.

### ■ Safety Design

When using our products for high safety and/or reliability-required equipment or circuits, please fully perform safety and/or reliability evaluation. In addition, please install (i) systems equipped with a protection circuit and a protection device and/or (ii) systems equipped with a redundant circuit or other system to prevent an unsafe status in the event of a single fault for a failsafe design to ensure safety.

### ■ Intellectual Property Rights

Information contained in this catalog is intended to convey examples of typical performances and/or applications of our products and is not intended to make any warranty with respect to the intellectual property rights or any other related rights of TAIYO YUDEN or any third parties nor grant any license under such rights.

### ■ Limited Warranty

Please note that the scope of warranty for our products is limited to the delivered our products themselves and TAIYO YUDEN shall not be in any way responsible for any damages resulting from a failure or defect in our products. Notwithstanding the foregoing, if there is a written agreement (e.g., supply and purchase agreement, quality assurance agreement) signed by TAIYO YUDEN and your company, TAIYO YUDEN will warrant our products in accordance with such agreement.

### ■ TAIYO YUDEN's Official Sales Channel

The contents of this catalog are applicable to our products which are purchased from our sales offices or authorized distributors (hereinafter "TAIYO YUDEN's official sales channel"). Please note that the contents of this catalog are not applicable to our products purchased from any seller other than TAIYO YUDEN's official sales channel.

### ■ Caution for Export

Some of our products listed in this catalog may require specific procedures for export according to "U.S. Export Administration Regulations", "Foreign Exchange and Foreign Trade Control Law" of Japan, and other applicable regulations. Should you have any questions on this matter, please contact our sales staff.

# Industrial Application Guide

The products described as “For Telecommunications Infrastructure and Industrial Equipment” in this catalog are intended for use in the equipment shown in the below table as its typical example. Therefore, when using our products for these equipment, please check it carefully by referring to the part number or the individual product specification sheets and use the corresponding products. Should you have any questions on this matter, please contact us.

Category	Telecommunications Infrastructure and Industrial Equipment (Typical Example)
Telecommunications Infrastructure	<ul style="list-style-type: none"> <li>• Base Station</li> <li>• Optical Transceiver</li> <li>• Router/Switch (Carrier-Grade)</li> <li>• UPS (Uninterruptible Power Supply), etc.</li> </ul>
Factory Automation	<ul style="list-style-type: none"> <li>• PLC (Programmable Logic Controller)</li> <li>• Servomotor/Servo Driver</li> <li>• Industry Robot, etc.</li> </ul>
Measurement	<ul style="list-style-type: none"> <li>• Gas Meter</li> <li>• Water Meter</li> <li>• Flow Meter</li> <li>• Pressure Gauge Meter</li> <li>• Magnetometer</li> <li>• Thermometer, etc.</li> </ul>
Electric Power Apparatus	<ul style="list-style-type: none"> <li>• Power Conditioner (Solar Power System)</li> <li>• Smart Meter</li> <li>• GFCI (Ground Fault Circuit Interrupter)</li> <li>• Electric Vehicle Charging Station, etc.</li> </ul>

## Part Numbering System

Multilayer Ceramic Capacitors:

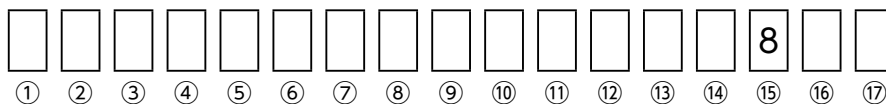

If the 15th code from the left is “8”, it indicates “For Telecommunications Infrastructure and Industrial Equipment” or “For Medical Devices”.

Inductors:

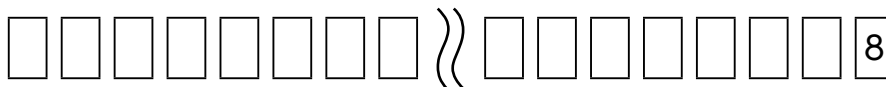

If the 1st code from the right is “8” regardless of the total digit number, it indicates “For Telecommunications Infrastructure and Industrial Equipment” or “For Medical Devices”.

Because there are some exceptions, for details please refer to each page of this catalog where the part numbering system of each product is described.

# Medical Application Guide

The products described as “For Medical Devices” in this catalog are intended for use in the medical devices classified as GHTF Classes A to C (Japan Classes I to III) except for all medical devices classified as GHTF Class D (Japan Class IV) and implantable medical devices (bone-anchored hearing aid, artificial retina system, and external unit which is connected to internal unit which is implanted in a body, etc.). Therefore, when using our products for these medical devices, please check it carefully by referring to the part number or the individual product specification sheets and use the corresponding products. Should you have any questions on this matter, please contact us.

Risk Level		Low  High			
Japan	Classification according to the PMD Act of Japan (based on the GHTF Rules)	<b>Class I</b> General Medical Devices (GHTF Class A)	<b>Class II</b> Controlled Medical Devices (GHTF Class B)	<b>Class III</b> Specially-controlled Medical Devices (GHTF Class C)	<b>Class IV</b> Specially-controlled Medical Devices (GHTF Class D)
		Medical devices with extremely low risk to the human body in case of problems  [Ex.] • In Vitro Diagnostic Devices • Nebulizer • Blood Gas Analyzer • Plethysmographs • Breathing Sensor • AC-powered Operating Table • Surgical Light • Cholesterol Analysis Device • Blood Type Analysis Device, etc.	Medical devices with relatively low risk to the human body in case of problems  [Ex.] • Electronic Thermometer • Electronic Blood Pressure Gauge • Electronic Endoscope • Hearing Aid • Electrocardiograph • MRI • Ultrasonic Diagnostic System • Diagnostic Imaging Equipment • X-ray Diagnostic Equipment • Central Monitor • Pulse Oximeter, etc.	Medical devices with relatively high risk to the human body in case of problems  [Ex.] • Dialysis Machine • Radiation Therapy Equipment • Infusion Pump • Respirator • Glucose Monitoring System • AED (Automated External Defibrillator) • Skin Laser Scanner • Electric Surgical Unit • Insulin Pump, etc.	Medical devices highly invasive to patients and with life-threatening risk in case of problems  [Ex.] • Cardiac Pacemaker • Video Flexible Angioscope • Implantable Infusion Pump • Cardiac Electrosurgical Unit • Inspection Device with Cardiac Catheter • Defibrillator, etc.
U.S.A.	FDA Classification	<b>Class I</b> General Controls	<b>Class II</b> General Controls and Special Controls	<b>Class III</b> General Controls and Premarket Approval	
		Medical devices without the possibility of causing serious injury or harm to the patient or user even if there is a defect or malfunction in such medical devices	Medical devices with the possibility of causing injury or harm to the patient or user if there is a defect or malfunction in such medical devices	Medical devices with the possibility of causing serious injury, disability or death to the patient or user if a defect or malfunction occurs in such medical devices	

Coverage of those Classes by TAIYO YUDEN Products	<b>Product Series for Medical Devices</b>  *Note: It is prohibited that our products are used in some medical devices such as implantable medical devices even if such medical devices are classified as GHTF Class C (Japan Class III).	N/A
---	--	-----

► This catalog contains the typical specification only due to the limitation of space. When you consider the purchase of our products, please check our product specification sheets. For details of each product (characteristics graph, reliability information, precautions for use, and so on), see our website (<http://www.ty-top.com/>).

# MULTILAYER CHIP BEAD INDUCTORS (BK SERIES)

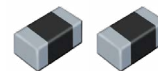

REFLOW

■ PART NUMBER

\*Operating Temp. : -55~125°C

B	K	△	1	0	0	5	H	S	1	2	1	-	T	V
①	②	③	④	⑤	⑥	⑦								

△=Blank space

① Series name

Code	Series name
BK△	Multilayer chip bead inductor

② Dimensions (L × W)

Code	Type (inch)	Dimensions (L × W) [mm]
0603	0603(0201)	0.6 × 0.3
1005	1005(0402)	1.0 × 0.5

③ Material

Code	Material
HW	Refer to impedance curves for material differences
HS	
HR	
HM	
LM	
LL	
TS	

④ Nominal impedance

Code (example)	Nominal impedance [Ω]
100	10
330	33
121	120
102	1000

⑤ Characteristics

Code	Characteristics
-	Standard

⑥ Packaging

Code	Packaging
T	Taping

⑦ Internal code

Code	Internal code
V	MLCI for Automotive
8	MLCI for Telecommunications infrastructure and Industrial equipment / Medical devices

■ FEATURES

- HW: For broadband noise suppression.
- HS: For broadband noise suppression.
- HR: For upper 10MHz noise suppression.
- HM: For upper 20MHz noise suppression.
- LM: For high frequency noise suppression around 200MHz.
- LL: For high frequency noise suppression from 100MHz.
- TS: Low DC resistance HS version.

■ STANDARD EXTERNAL DIMENSIONS / STANDARD QUANTITY

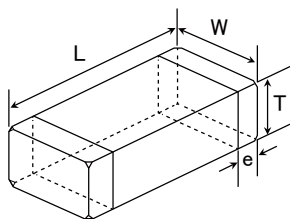

Type	L	W	T	e	Standard quantity [pcs]	
					Paper tape	Embossed tape
BK 0603 (0201)	0.60 ± 0.03 (0.024 ± 0.001)	0.30 ± 0.03 (0.012 ± 0.001)	0.30 ± 0.03 (0.012 ± 0.001)	0.15 ± 0.05 (0.006 ± 0.002)	15000	-
BK 1005 (0402)	1.00 ± 0.05 (0.039 ± 0.002)	0.50 ± 0.05 (0.020 ± 0.002)	0.50 ± 0.05 (0.020 ± 0.002)	0.25 ± 0.10 (0.010 ± 0.004)	10000	-

Unit: mm (inch)

For Telecommunications Infrastructure and Industrial Equipment / Medical Devices  
MULTILAYER CHIP BEAD INDUCTORS (BK SERIES)

NOISE SUPPRESSION COMPONENTS

INDL

► This catalog contains the typical specification only due to the limitation of space. When you consider the purchase of our products, please check our product specification sheets. For details of each product (characteristics graph, reliability information, precautions for use, and so on), see our website (<http://www.ty-top.com/>).

■ PART NUMBER

• All the Multilayer Chip Bead Inductors of the catalog lineup are RoHS compliant.

Notes)

- The exchange of individual specifications is necessary depending on your application and/or circuit condition. Please contact TAIYO YUDEN's official sales channel.
- The products are for Telecommunications infrastructure and Industrial equipment and for Medical devices.

Please consult with TAIYO YUDEN's official sales channel for the details of the product specifications, etc., and please review and approve the product specifications before ordering.

Please be sure to contact us for further information in advance when the products are used for automotive electronic equipment.

● BK 0603

Part number	Nominal impedance [Ω]	Impedance tolerance	Measuring frequency [MHz]	DC Resistance [Ω] (max.)	Rated current [mA] (max.)	Thickness [mm]	Note
BK 0603HS220-T8	22	±25%	100	0.065	500	0.30 ±0.03	
BK 0603HS330-T8	33	±25%	100	0.070	500	0.30 ±0.03	
BK 0603TS800-T8	80	±25%	100	0.18	500	0.30 ±0.03	
BK 0603TS121-T8	120	±25%	100	0.23	450	0.30 ±0.03	
BK 0603TS241-T8	240	±25%	100	0.32	400	0.30 ±0.03	
BK 0603TS601-T8	600	±25%	100	0.75	270	0.30 ±0.03	

● BK 1005

Part number	Nominal impedance [Ω]	Impedance tolerance	Measuring frequency [MHz]	DC Resistance [Ω] (max.)	Rated current [mA] (max.)	Thickness [mm]	Note
BK 1005HW680-T8	68	±25%	100	0.17	500	0.50 ±0.05	
BK 1005HW121-T8	120	±25%	100	0.24	450	0.50 ±0.05	
BK 1005HW241-T8	240	±25%	100	0.31	400	0.50 ±0.05	
BK 1005HW431-T8	430	±25%	100	0.50	350	0.50 ±0.05	
BK 1005HW601-T8	600	±25%	100	0.60	300	0.50 ±0.05	
BK 1005HS100-T8	10	±25%	100	0.03	1,000	0.50 ±0.05	
BK 1005HS330-T8	33	±25%	100	0.06	700	0.50 ±0.05	
BK 1005HS680-T8	68	±25%	100	0.10	700	0.50 ±0.05	
BK 1005HS800-T8	80	±25%	100	0.10	700	0.50 ±0.05	
BK 1005HS121-T8	120	±25%	100	0.20	500	0.50 ±0.05	
BK 1005HS241-T8	240	±25%	100	0.30	400	0.50 ±0.05	
BK 1005HS431-T8	430	±25%	100	0.45	350	0.50 ±0.05	
BK 1005HS601-T8	600	±25%	100	0.55	300	0.50 ±0.05	
BK 1005HS102-T8	1000	±25%	100	0.58	300	0.50 ±0.05	
BK 1005HR601-T8	600	±25%	100	0.60	300	0.50 ±0.05	
BK 1005HM750-T8	75	±25%	100	0.18	350	0.50 ±0.05	
BK 1005HM121-T8	120	±25%	100	0.18	300	0.50 ±0.05	
BK 1005HM241-T8	240	±25%	100	0.30	300	0.50 ±0.05	
BK 1005HM471-T8	470	±25%	100	0.45	250	0.50 ±0.05	
BK 1005HM601-T8	600	±25%	100	0.50	250	0.50 ±0.05	
BK 1005HM102-T8	1000	±25%	100	0.70	150	0.50 ±0.05	
BK 1005LL100-T8	10	±25%	100	0.11	500	0.50 ±0.05	
BK 1005LL220-T8	22	±25%	100	0.18	400	0.50 ±0.05	
BK 1005LL330-T8	33	±25%	100	0.25	400	0.50 ±0.05	
BK 1005LL470-T8	47	±25%	100	0.33	350	0.50 ±0.05	
BK 1005LL680-T8	68	±25%	100	0.31	400	0.50 ±0.05	
BK 1005LL121-T8	120	±25%	100	0.45	350	0.50 ±0.05	
BK 1005LL181-T8	180	±25%	100	0.50	300	0.50 ±0.05	
BK 1005LL241-T8	240	±25%	100	0.70	250	0.50 ±0.05	
BK 1005LM182-T8	1800	±25%	100	0.90	120	0.50 ±0.05	

※) The rated current is the value of current at which the temperature of the element is increased within 20°C.

▶ This catalog contains the typical specification only due to the limitation of space. When you consider the purchase of our products, please check our product specification sheets. For details of each product (characteristics graph, reliability information, precautions for use, and so on), see our website (<http://www.ty-top.com/>).

For Telecommunications Infrastructure and Industrial Equipment / Medical Devices  
MULTILAYER CHIP BEAD INDUCTORS (BK SERIES)  
NOISE SUPPRESSION COMPONENTS  
INDL

ELECTRICAL CHARACTERISTICS

BK 0603

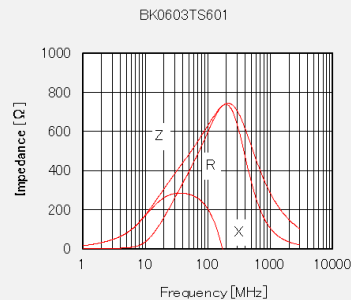
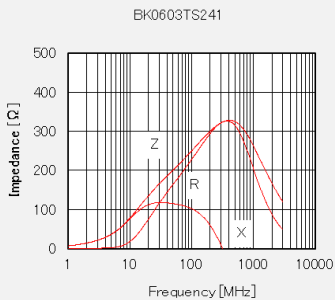
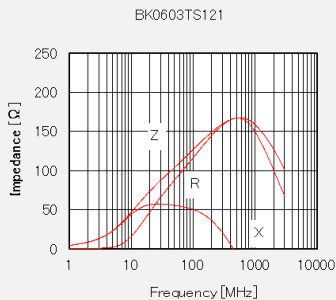
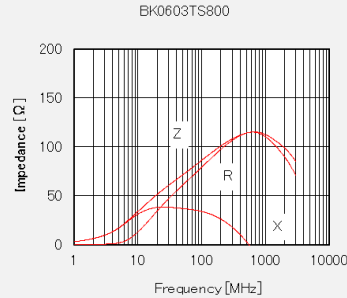
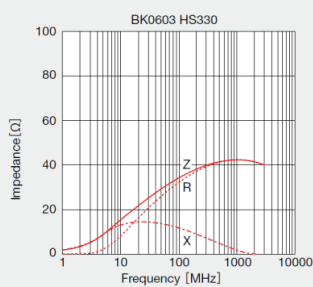
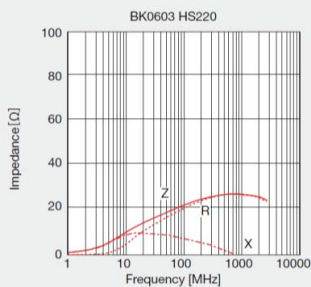

BK 1005

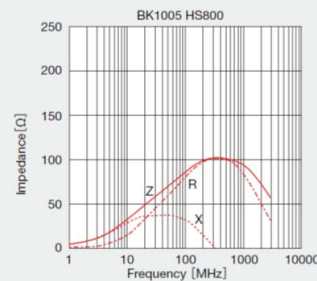
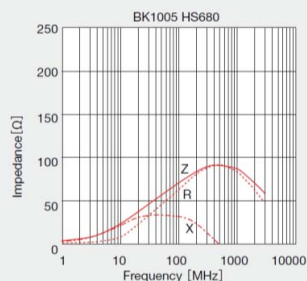
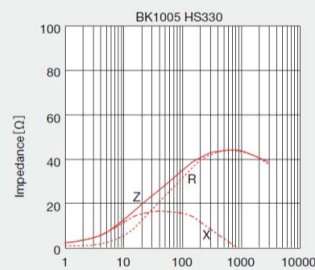
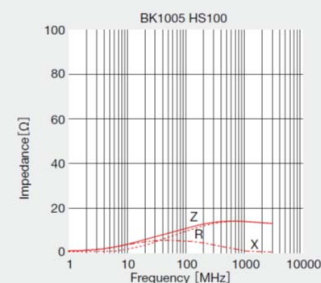
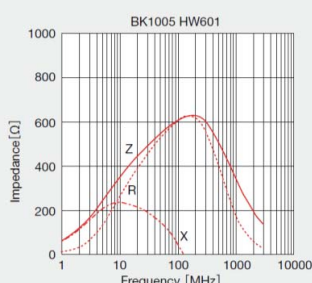
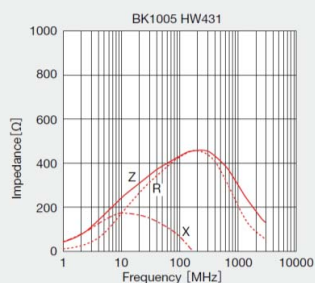
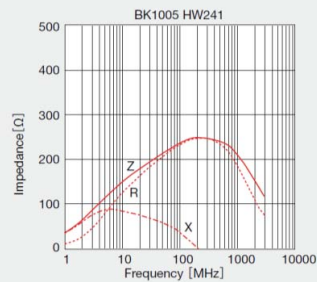
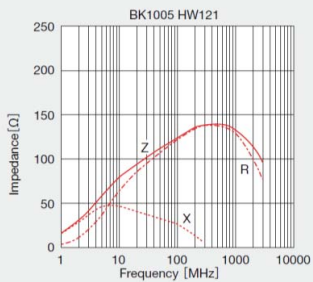
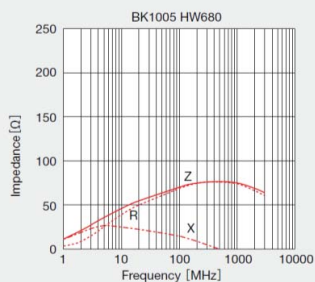

For Telecommunications Infrastructure and Industrial Equipment / Medical Devices  
MULTILAYER CHIP BEAD INDUCTORS (BK SERIES)

NOISE SUPPRESSION COMPONENTS

INDL

► This catalog contains the typical specification only due to the limitation of space. When you consider the purchase of our products, please check our product specification sheets. For details of each product (characteristics graph, reliability information, precautions for use, and so on), see our website (<http://www.ty-top.com/>).

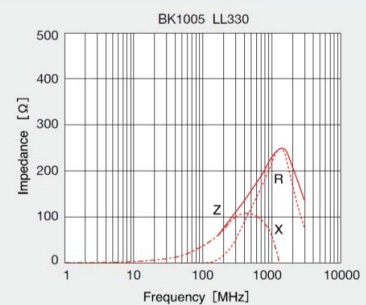
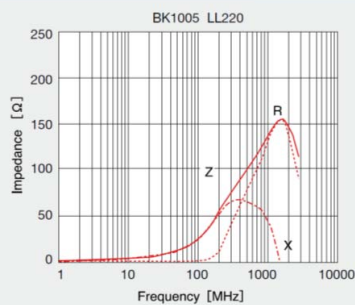
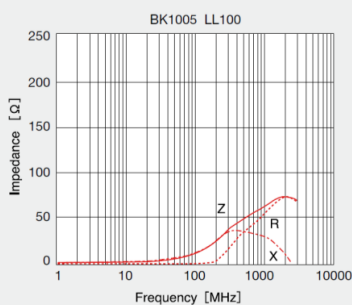
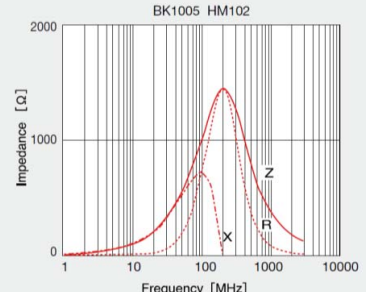
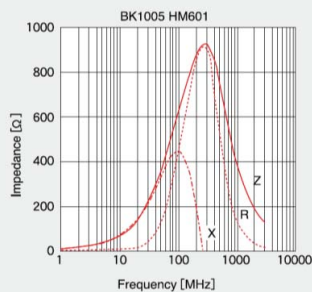
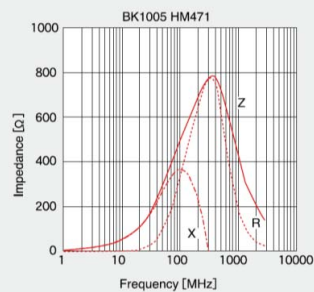
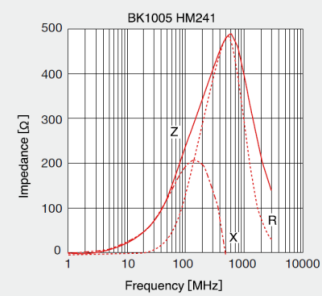
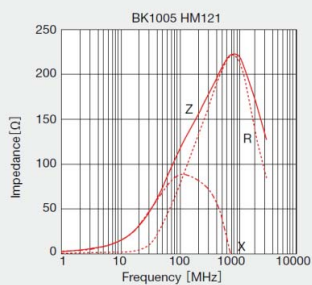
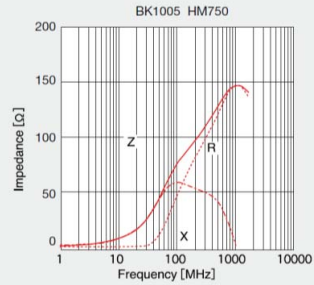
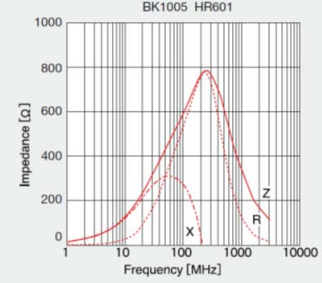
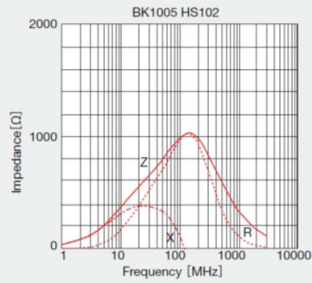
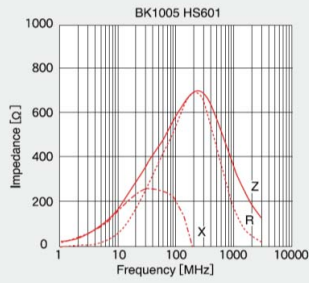
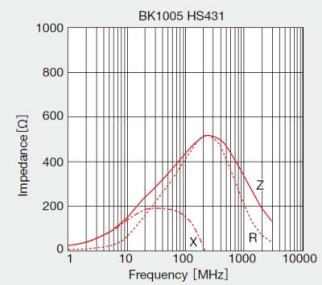
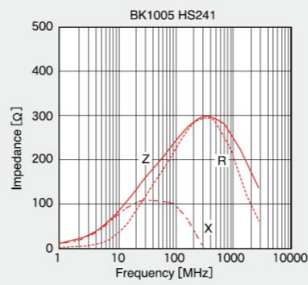
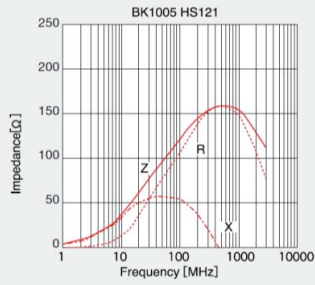

▶ This catalog contains the typical specification only due to the limitation of space. When you consider the purchase of our products, please check our product specification sheets. For details of each product (characteristics graph, reliability information, precautions for use, and so on), see our website (<http://www.ty-top.com/>).

For Telecommunications Infrastructure and Industrial Equipment / Medical Devices  
MULTILAYER CHIP BEAD INDUCTORS (BK SERIES)

NOISE SUPPRESSION COMPONENTS  
INDL

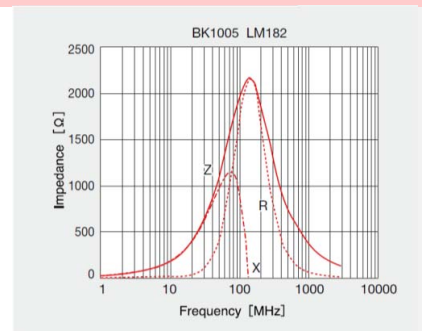
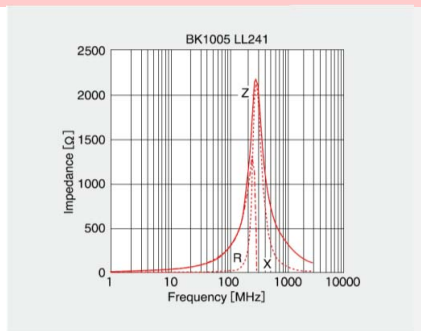
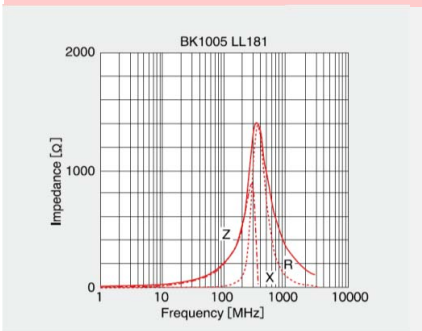
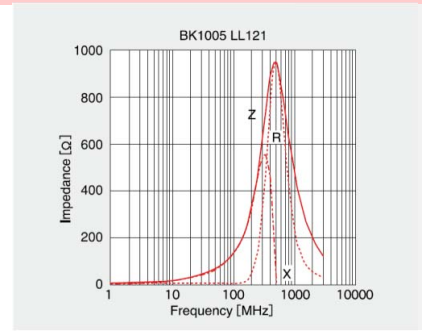
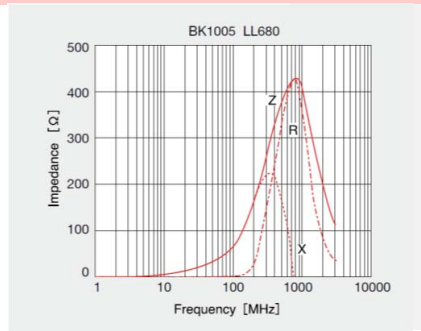
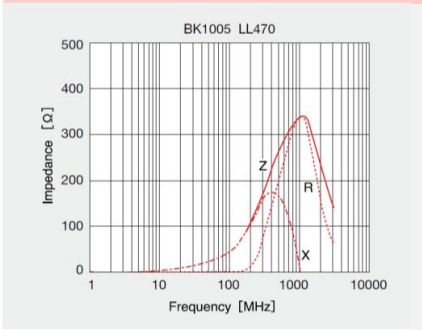

● BK series

Until 125 °C ambient temperature, BK series is available at 100% of the rated current. Please refer to the chart shown below.

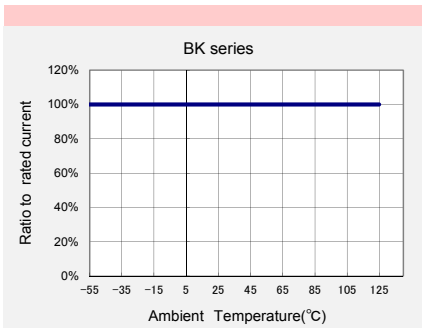

► This catalog contains the typical specification only due to the limitation of space. When you consider the purchase of our products, please check our product specification sheets. For details of each product (characteristics graph, reliability information, precautions for use, and so on), see our website (<http://www.ty-top.com/>).



# MULTILAYER CHIP BEAD INDUCTORS FOR POWER LINES (BK SERIES P TYPE)

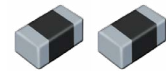

REFLOW

**PART NUMBER**

\*Operating Temp. : -55~125°C(Including self-generated heat)

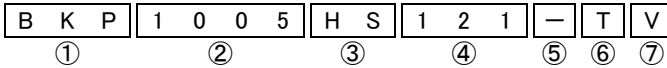

△=Blank space

①Series name

Code	Series name
BKP	Multilayer chip bead inductor for power line

②Dimensions (L × W)

Code	Type (inch)	Dimensions (L × W) [mm]
0603	0603 (0201)	0.6 × 0.3
1005	1005 (0402)	1.0 × 0.5

③Material

Code	Material
HS	Refer to impedance curves for material differences
HM	
TS	
TM	

④Nominal impedance

Code (example)	Nominal impedance [Ω]
100	10
330	33
121	120
221	220

⑤Characteristics

Code	Characteristics
-	Standard

⑥Packaging

Code	Packaging
T	Taping

⑦Internal code

Code	Internal code
V	MLCI for Automotive
8	MLCI for Telecommunications infrastructure and Industrial equipment / Medical devices

**FEATURES**

- HS: For broadband noise suppression
- HM: For upper 20MHz noise suppression
- TS: Low DC resistance HS version.
- TM: Low DC resistance HM version.

**STANDARD EXTERNAL DIMENSIONS / STANDARD QUANTITY**

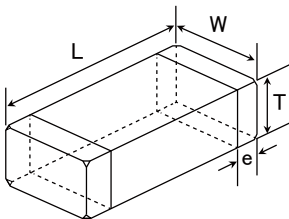

Type	L	W	T	e	Standard quantity [pcs]	
					Paper tape	Embossed tape
BKP0603 (0201)	0.6±0.03 (0.024±0.001)	0.3±0.03 (0.012±0.001)	0.3±0.03 (0.012±0.001)	0.15±0.05 (0.006±0.002)	15000	-
BKP1005 (0402)	1.0±0.05 (0.039±0.002)	0.5±0.05 (0.020±0.002)	0.5±0.05 (0.020±0.002)	0.25±0.1 (0.010±0.004)	10000	-

Unit: mm (inch)

▶ This catalog contains the typical specification only due to the limitation of space. When you consider the purchase of our products, please check our product specification sheets. For details of each product (characteristics graph, reliability information, precautions for use, and so on), see our website (<http://www.ty-top.com/>).

## PART NUMBER

• All the Multilayer Chip Bead Inductors of the catalog lineup are RoHS compliant.

## Notes)

- The exchange of individual specifications is necessary depending on your application and/or circuit condition. Please contact TAIYO YUDEN's official sales channel.
  - The products are for Telecommunications infrastructure and Industrial equipment and for Medical devices. Please consult with TAIYO YUDEN's official sales channel for the details of the product specifications, etc., and please review and approve the product specifications before ordering.
- Please be sure to contact us for further information in advance when the products are used for automotive electronic equipment.

## ● BKP0603

Part number	Nominal impedance [Ω]	Impedance tolerance	Measuring frequency [MHz]	DC Resistance [mΩ] (max.)	Rated current [A] (max.)	Thickness [mm]	Note
BKP0603HS100-T8	10	±5Ω	100	30	1.3	0.30 ±0.03	
BKP0603HS220-T8	22	±25%	100	65	1.0	0.30 ±0.03	
BKP0603HS330-T8	33	±25%	100	70	1.0	0.30 ±0.03	
BKP0603HM100-T8	10	±5Ω	100	30	1.3	0.30 ±0.03	

## ● BKP1005

Part number	Nominal impedance [Ω]	Impedance tolerance	Measuring frequency [MHz]	DC Resistance [mΩ] (max.)	Rated current [A] (max.)	Thickness [mm]	Note
BKP1005HS100-T8	10	±25%	100	30	2.0	0.50 ±0.05	
BKP1005HS330-T8	33	±25%	100	50	1.7	0.50 ±0.05	
BKP1005HS680-T8	68	±25%	100	75	1.5	0.50 ±0.05	
BKP1005HS121-T8	120	±25%	100	140	1.0	0.50 ±0.05	
BKP1005HS221-T8	220	±25%	100	200	0.80	0.50 ±0.05	
BKP1005HM121-T8	120	±25%	100	120	1.1	0.50 ±0.05	
BKP1005HM221-T8	220	±25%	100	180	0.90	0.50 ±0.05	
BKP1005TS330-T8	33	±25%	100	39±30%	1.7	0.50 ±0.05	
BKP1005TS680-T8	68	±25%	100	55±30%	1.5	0.50 ±0.05	
BKP1005TS121-T8	120	±25%	100	70±30%	1.3	0.50 ±0.05	
BKP1005TM121-T8	120	±25%	100	100	1.3	0.50 ±0.05	

※) The rated current is the value of current at which the temperature of the element is increased within 40°C.

ELECTRICAL CHARACTERISTICS

BKP0603

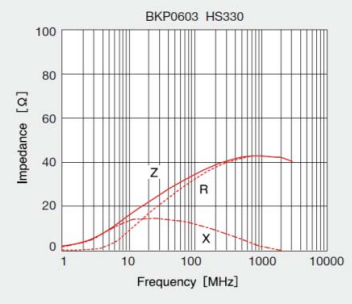
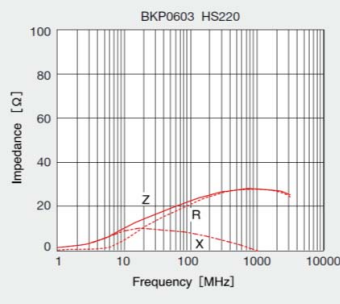
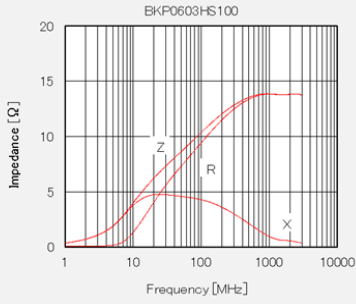

BKP1005

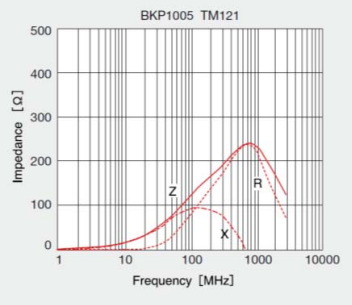
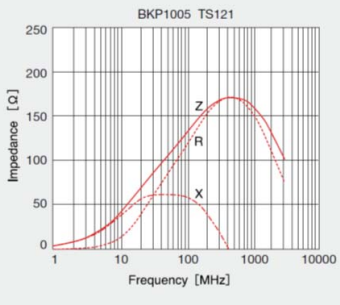
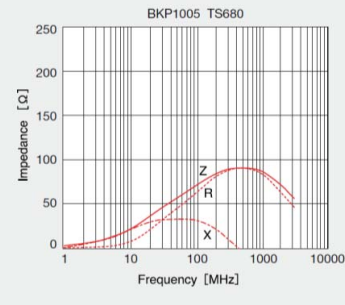
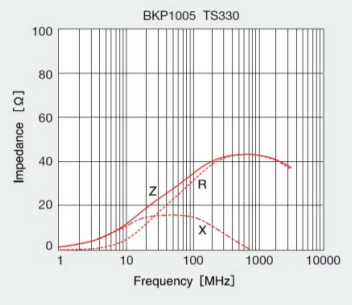
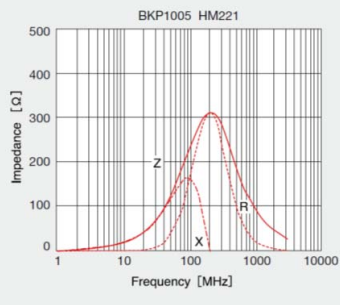
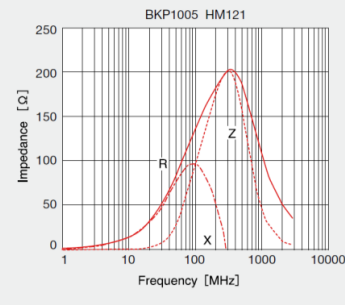
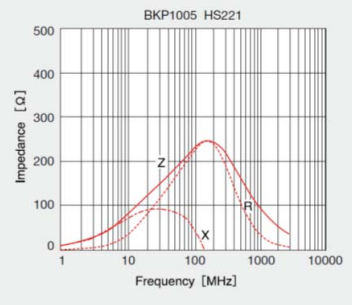
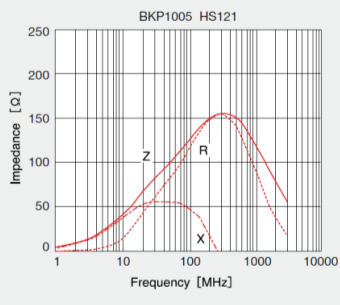
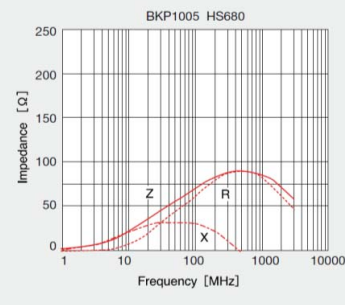
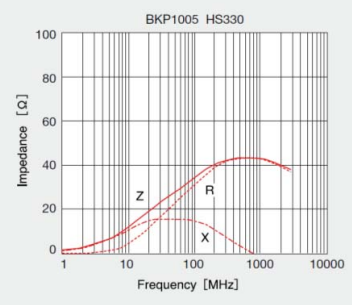
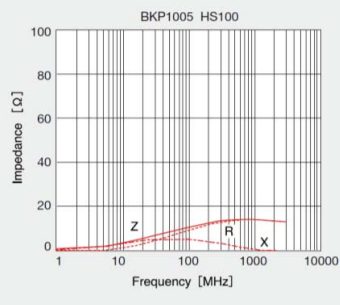
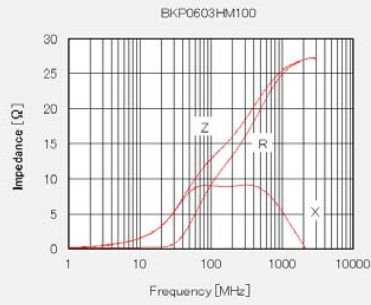

For Telecommunications Infrastructure and Industrial Equipment / Medical Devices  
MULTILAYER CHIP BEAD INDUCTORS FOR POWER LINES (BK SERIES P TYPE)

NOISE SUPPRESSION  
COMPONENTS

INDL

▶ This catalog contains the typical specification only due to the limitation of space. When you consider the purchase of our products, please check our product specification sheets. For details of each product (characteristics graph, reliability information, precautions for use, and so on), see our website (<http://www.ty-top.com/>).

■ Derating of Rated Current

● BK series P type

Derating of current is necessary for BK series P type depending on ambient temperature. Please refer to the chart shown below for appropriate derating of current.

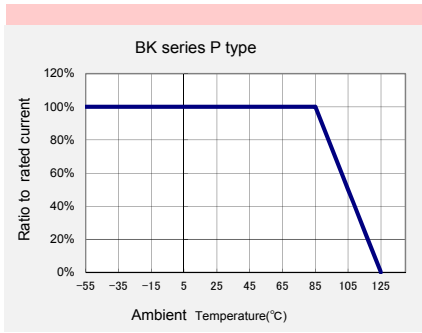

► This catalog contains the typical specification only due to the limitation of space. When you consider the purchase of our products, please check our product specification sheets. For details of each product (characteristics graph, reliability information, precautions for use, and so on), see our website (<http://www.ty-top.com/>).

## Multilayer chip inductors

Multilayer chip inductors for high frequency, Multilayer chip bead inductors

Multilayer common mode choke coils (MC series F type)

Metal Multilayer Chip Power Inductors (MCOIL™ MC series)

### PACKAGING

#### ① Minimum Quantity

##### ● Tape & Reel Packaging

Type	Thickness mm (inch)	Standard Quantity [pcs]	
		Paper Tape	Embossed Tape
CK1608(0603)	0.8 (0.031)	4000	—
CK2125(0805)	0.85(0.033)	4000	—
	1.25(0.049)	—	2000
CKS2125(0805)	0.85(0.033)	4000	—
	1.25(0.049)	—	2000
CKP1608(0603)	0.8 (0.031)	4000	—
CKP2012(0805)	0.9 (0.035)	—	3000
CKP2016(0806)	0.9 (0.035)	—	3000
CKP2520(1008)	0.7 (0.028)	—	3000
	0.9 (0.035)	—	3000
	1.1 (0.043)	—	2000
LK1005(0402)	0.5 (0.020)	10000	—
LK1608(0603)	0.8 (0.031)	4000	—
LK2125(0805)	0.85(0.033)	4000	—
	1.25(0.049)	—	2000
HK0603(0201)	0.3 (0.012)	15000	—
HK1005(0402)	0.5 (0.020)	10000	—
HK1608(0603)	0.8 (0.031)	4000	—
HK2125(0805)	0.85(0.033)	—	4000
	1.0 (0.039)	—	3000
HKQ0603S(0201)	0.3 (0.012)	15000	—
HKQ0603U(0201)	0.3 (0.012)	15000	—
AQ105(0402)	0.5 (0.020)	10000	—
BK0603(0201)	0.3 (0.012)	15000	—
BK1005(0402)	0.5 (0.020)	10000	—
BKH0603(0201)	0.3 (0.012)	15000	—
BKH1005(0402)	0.5 (0.020)	10000	—
BK1608(0603)	0.8 (0.031)	4000	—
BK2125(0805)	0.85(0.033)	4000	—
	1.25(0.049)	—	2000
BK2010(0804)	0.45(0.018)	4000	—
BK3216(1206)	0.8 (0.031)	—	4000
BKP0603(0201)	0.3 (0.012)	15000	—
BKP1005(0402)	0.5 (0.020)	10000	—
BKP1608(0603)	0.8 (0.031)	4000	—
BKP2125(0805)	0.85(0.033)	4000	—
MCF0605(0202)	0.3 (0.012)	15000	—
MCF0806(0302)	0.4 (0.016)	—	10000
MCF1210(0504)	0.55(0.022)	—	5000
MCF2010(0804)	0.45(0.018)	—	4000
MCEE1005(0402)	0.55(0.022)	10000	—
MCEK1210(0504)	0.5 (0.020)	5000	—
MCFK1608(0603)	0.6 (0.024)	4000	—
MCFE1608(0603)	0.65(0.026)	4000	—
MCHK1608(0603)	0.8 (0.031)	4000	—
MCKK1608(0603)	1.0 (0.039)	—	3000
MCHK2012(0806)	0.8 (0.031)	4000	—
MCKK2012(0805)	1.0 (0.039)	—	3000

► This catalog contains the typical specification only due to the limitation of space. When you consider the purchase of our products, please check our specification. For details of each product (characteristics graph, reliability information, precautions for use, and so on), see our Web site (<http://www.ty-top.com/>).

## ② Taping material

### ● Card board carrier tape

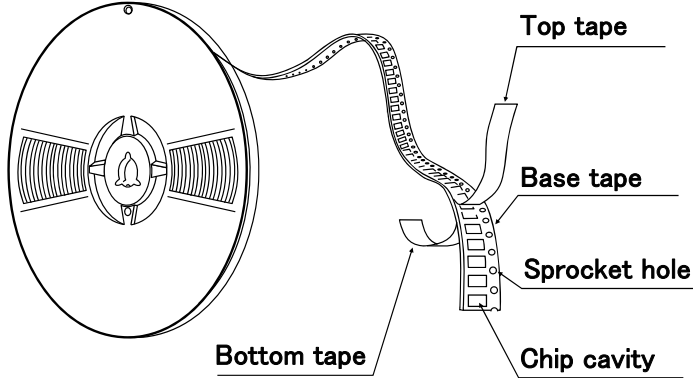

CK	1608
CKP	1608
CK	2125
CKS	2125
LK	1005
LK	1608
LK	2125
HK	0603
HK	1005
HK	1608
HKQ	0603
AQ	105

BK	0603
BK	1005
BK	1608
BK	2125
BK	2010
BKP	0603
BKP	1005
BKP	1608
BKP	2125
BKH	0603
BKH	1005
MCF	0605
MC	1005
MC	1210
MC	1608
MC	2012



### ● Embossed Tape



CK	2125
CKS	2125
CKP	2012
CKP	2016
CKP	2520
LK	2125
HK	2125

BK	2125
BK	3216
MCF	0806
MCF	1210
MCF	2010
MC	1608
MC	2012



## ③ Taping Dimensions

### ● Paper tape (8mm wide)

Unit: mm (inch)



▶ This catalog contains the typical specification only due to the limitation of space. When you consider the purchase of our products, please check our specification. For details of each product (characteristics graph, reliability information, precautions for use, and so on), see our Web site (<http://www.ty-top.com/>).

Type	Thickness mm (inch)	Chip cavity		Insertion Pitch	Tape Thickness
		A	B	F	T
CK1608(0603)	0.8 (0.031)	1.0±0.2 (0.039±0.008)	1.8±0.2 (0.071±0.008)	4.0±0.1 (0.157±0.004)	1.1max (0.043max)
CK2125(0805)	0.85(0.033)	1.5±0.2 (0.059±0.008)	2.3±0.2 (0.091±0.008)	4.0±0.1 (0.157±0.004)	1.1max (0.043max)
CKS2125(0805)	0.85(0.033)	1.5±0.2 (0.059±0.008)	2.3±0.2 (0.091±0.008)	4.0±0.1 (0.157±0.004)	1.1max (0.043max)
CKP1608(0603)	0.8 (0.031)	1.0±0.2 (0.039±0.008)	1.8±0.2 (0.071±0.008)	4.0±0.1 (0.157±0.004)	1.1max (0.043max)
LK1005(0402)	0.5 (0.020)	0.65±0.1 (0.026±0.004)	1.15±0.1 (0.045±0.004)	2.0±0.05 (0.079±0.002)	0.8max (0.031max)
LK1608(0603)	0.8 (0.031)	1.0±0.2 (0.039±0.008)	1.8±0.2 (0.071±0.008)	4.0±0.1 (0.157±0.004)	1.1max (0.043max)
LK2125(0805)	0.85(0.033)	1.5±0.2 (0.059±0.008)	2.3±0.2 (0.091±0.008)	4.0±0.1 (0.157±0.004)	1.1max (0.043max)
HK0603(0201)	0.3 (0.012)	0.40±0.06 (0.016±0.002)	0.70±0.06 (0.028±0.002)	2.0±0.05 (0.079±0.002)	0.45max (0.018max)
HK1005(0402)	0.5 (0.020)	0.65±0.1 (0.026±0.004)	1.15±0.1 (0.045±0.004)	2.0±0.05 (0.079±0.002)	0.8max (0.031max)
HK1608(0603)	0.8 (0.031)	1.0±0.2 (0.039±0.008)	1.8±0.2 (0.071±0.008)	4.0±0.1 (0.157±0.004)	1.1max (0.043max)
HKQ0603S(0201)	0.3 (0.012)	0.40±0.06 (0.016±0.002)	0.70±0.06 (0.028±0.002)	2.0±0.05 (0.079±0.002)	0.45max (0.018max)
HKQ0603U(0201)	0.3 (0.012)	0.40±0.06 (0.016±0.002)	0.70±0.06 (0.028±0.002)	2.0±0.05 (0.079±0.002)	0.45max (0.018max)
AQ105(0402)	0.5 (0.020)	0.75±0.1 (0.030±0.004)	1.15±0.1 (0.045±0.004)	2.0±0.05 (0.079±0.002)	0.8max (0.031max)
BK0603(0201)	0.3 (0.012)	0.40±0.06 (0.016±0.002)	0.70±0.06 (0.028±0.002)	2.0±0.05 (0.079±0.002)	0.45max (0.018max)
BK1005(0402)	0.5 (0.020)	0.65±0.1 (0.026±0.004)	1.15±0.1 (0.045±0.004)	2.0±0.05 (0.079±0.002)	0.8max (0.031max)
BK1608(0603)	0.8 (0.031)	1.0±0.2 (0.039±0.008)	1.8±0.2 (0.071±0.008)	4.0±0.1 (0.157±0.004)	1.1max (0.043max)
BK2125(0805)	0.85(0.033)	1.5±0.2 (0.059±0.008)	2.3±0.2 (0.091±0.008)	4.0±0.1 (0.157±0.004)	1.1max (0.043max)
BK2010(0804)	0.45(0.018)	1.2±0.1 (0.047±0.004)	2.17±0.1 (0.085±0.004)	4.0±0.1 (0.157±0.004)	0.8max (0.031max)
BKP0603(0201)	0.3 (0.012)	0.40±0.06 (0.016±0.002)	0.70±0.06 (0.028±0.002)	2.0±0.05 (0.079±0.002)	0.45max (0.018max)
BKP1005(0402)	0.5 (0.020)	0.65±0.1 (0.026±0.004)	1.15±0.1 (0.045±0.004)	2.0±0.05 (0.079±0.002)	0.8max (0.031max)
BKP1608(0603)	0.8 (0.031)	1.0±0.2 (0.039±0.008)	1.8±0.2 (0.071±0.008)	4.0±0.1 (0.157±0.004)	1.1max (0.043max)
BKP2125(0805)	0.85(0.033)	1.5±0.2 (0.059±0.008)	2.3±0.2 (0.091±0.008)	4.0±0.1 (0.157±0.004)	1.1max (0.043max)
BKH0603(0201)	0.3 (0.012)	0.40±0.06 (0.016±0.002)	0.70±0.06 (0.028±0.002)	2.0±0.05 (0.079±0.002)	0.45max (0.018max)
BKH1005(0402)	0.5 (0.020)	0.65±0.1 (0.026±0.004)	1.15±0.1 (0.045±0.004)	2.0±0.05 (0.079±0.002)	0.8max (0.031max)
MCF0605(0202)	0.3 (0.012)	0.62±0.03 (0.024±0.001)	0.77±0.03 (0.030±0.001)	2.0±0.05 (0.079±0.002)	0.45max (0.018max)
MCFK1608(0603)	0.6 (0.024)	1.1±0.05 (0.043±0.002)	1.9±0.05 (0.075±0.002)	4.0±0.1 (0.157±0.004)	0.72max (0.028max)
MCEE1005(0402)	0.55(0.021)	0.8±0.05 (0.031±0.002)	1.3±0.05 (0.051±0.002)	2.0±0.05 (0.079±0.002)	0.64max (0.025max)
MCEK1210(0504)	0.5 (0.020)	1.3±0.1 (0.051±0.004)	1.55±0.1 (0.061±0.004)	4.0±0.1 (0.157±0.004)	0.64max (0.025max)
MCFK1608(0603)	0.6 (0.024)	1.1±0.05 (0.043±0.002)	1.9±0.05 (0.075±0.002)	4.0±0.1 (0.157±0.004)	0.72max (0.028max)
MCFE1608(0603)	0.65(0.026)	1.1±0.05 (0.043±0.002)	1.9±0.05 (0.075±0.002)	4.0±0.1 (0.157±0.004)	0.72max (0.028max)
MCHK1608(0603)	0.8 (0.031)	1.2±0.05 (0.047±0.002)	2.0±0.05 (0.079±0.002)	4.0±0.1 (0.157±0.004)	0.9max (0.035max)
MCHK2012(0805)	0.8 (0.031)	1.65±0.1 (0.065±0.004)	2.4±0.1 (0.094±0.004)	4.0±0.1 (0.157±0.004)	0.9max (0.035max)

Unit : mm (inch)

● Embossed Tape (8mm wide)

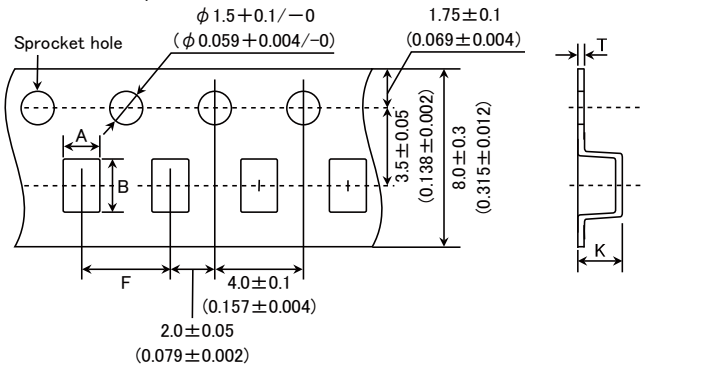

Type	Thickness mm (inch)	Chip cavity		Insertion Pitch	Tape Thickness	
		A	B	F	K	T
CK2125(0805)	1.25 (0.049)	1.5 ± 0.2 (0.059 ± 0.008)	2.3 ± 0.2 (0.091 ± 0.008)	4.0 ± 0.1 (0.157 ± 0.004)	2.0 (0.079)	0.3 (0.012)
CKS2125(0805)	1.25 (0.049)	1.5 ± 0.2 (0.059 ± 0.008)	2.3 ± 0.2 (0.091 ± 0.008)	4.0 ± 0.1 (0.157 ± 0.004)	2.0 (0.079)	0.3 (0.012)
CKP2012(0805)	0.9 (0.035)	1.55 ± 0.2 (0.061 ± 0.008)	2.3 ± 0.2 (0.091 ± 0.008)	4.0 ± 0.1 (0.157 ± 0.004)	1.3 (0.051)	0.3 (0.012)
CKP2016(0806)	0.9 (0.035)	1.8 ± 0.1 (0.071 ± 0.004)	2.2 ± 0.1 (0.087 ± 0.004)	4.0 ± 0.1 (0.157 ± 0.004)	1.3 (0.051)	0.25 (0.01)
CKP2520(1008)	0.7 (0.028)	2.3 ± 0.1 (0.091 ± 0.004)	2.8 ± 0.1 (0.110 ± 0.004)	4.0 ± 0.1 (0.157 ± 0.004)	1.4 (0.055)	0.3 (0.012)
	0.9 (0.035)				1.4 (0.055)	
	1.1 (0.043)				1.7 (0.067)	
	1.1 (0.043)				1.7 (0.067)	
LK2125(0805)	1.25 (0.049)	1.5 ± 0.2 (0.059 ± 0.008)	2.3 ± 0.2 (0.091 ± 0.008)	4.0 ± 0.1 (0.157 ± 0.004)	2.0 (0.079)	0.3 (0.012)
HK2125(0805)	0.85 (0.033)	1.5 ± 0.2 (0.059 ± 0.008)	2.3 ± 0.2 (0.091 ± 0.008)	4.0 ± 0.1 (0.157 ± 0.004)	1.5 (0.059)	0.3 (0.012)
	1.0 (0.039)				2.0 (0.079)	
BK2125(0805)	1.25 (0.049)	1.5 ± 0.2 (0.059 ± 0.008)	2.3 ± 0.2 (0.091 ± 0.008)	4.0 ± 0.1 (0.157 ± 0.004)	2.0 (0.079)	0.3 (0.012)
BK3216(1206)	0.8 (0.031)	1.9 ± 0.1 (0.075 ± 0.004)	3.5 ± 0.1 (0.138 ± 0.004)	4.0 ± 0.1 (0.157 ± 0.004)	1.4 (0.055)	0.3 (0.012)
MCF0806(0302)	0.4 (0.016)	0.75 ± 0.05 (0.030 ± 0.002)	0.95 ± 0.05 (0.037 ± 0.002)	2.0 ± 0.05 (0.079 ± 0.002)	0.55 (0.022)	0.3 (0.012)
MCF1210(0504)	0.55 (0.022)	1.15 ± 0.05 (0.045 ± 0.002)	1.40 ± 0.05 (0.055 ± 0.002)	4.0 ± 0.1 (0.157 ± 0.004)	0.65 (0.026)	0.3 (0.012)
MCF2010(0804)	0.45 (0.018)	1.1 ± 0.1 (0.043 ± 0.004)	2.3 ± 0.1 (0.091 ± 0.004)	4.0 ± 0.1 (0.157 ± 0.004)	0.85 (0.033)	0.3 (0.012)
MCKK1608(0603)	1.0 (0.039)	1.1 ± 0.1 (0.043 ± 0.004)	1.95 ± 0.1 (± 0.004)	4.0 ± 0.1 (0.157 ± 0.004)	1.4 (0.055)	0.25 (0.01)
MCKK2012(0805)	1.0 (0.039)	1.55 ± 0.1 (0.061 ± 0.004)	2.35 ± 0.1 (0.093 ± 0.004)	4.0 ± 0.1 (0.157 ± 0.004)	1.35 (0.053)	0.25 (0.010)

Unit : mm (inch)

④ LEADER AND BLANK PORTION

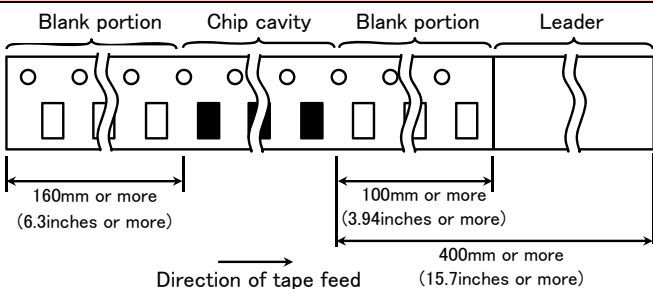

▶ This catalog contains the typical specification only due to the limitation of space. When you consider the purchase of our products, please check our specification. For details of each product (characteristics graph, reliability information, precautions for use, and so on), see our Web site (<http://www.ty-top.com/>).



⑤ Reel Size

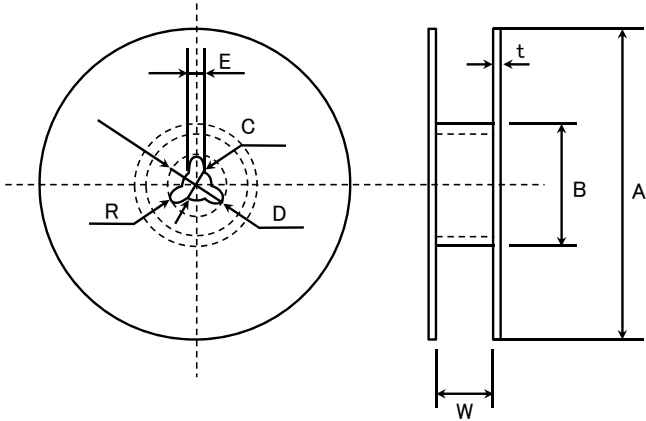

A	B	C	D	E	R
$\phi 178 \pm 2.0$	$\phi 50$ or more	$\phi 13.0 \pm 0.2$	$\phi 21.0 \pm 0.8$	$2.0 \pm 0.5$	1.0

	t	W
4mm width tape	1.5max.	$5 \pm 1.0$
8mm width tape	2.5max.	$10 \pm 1.5$

(Unit : mm)

⑥ Top tape strength

The top tape requires a peel-off force of 0.1~0.7N in the direction of the arrow as illustrated below.

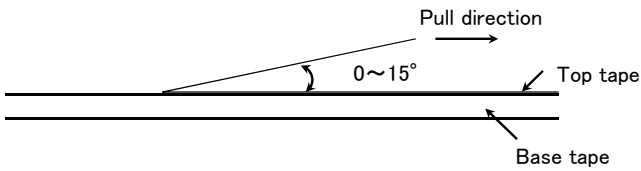

# Multilayer chip inductors

## Multilayer chip inductors for high frequency, Multilayer chip bead inductors

### RELIABILITY DATA

1. Operating Temperature Range		
Specified Value	BK series	-55~+125°C
	BKP series	-55~+125°C (Including self-generated heat)
	LK series	-40~+85°C
	HK series	-55~+125°C
2. Storage Temperature Range		
Specified Value	BK series	-55~+125°C
	BKP series	-55~+125°C
	LK series	-40~+85°C
	HK series	-55~+125°C
3. Rated Current		
Specified Value	BK series	The temperature of the element is increased within 20°C.
	BKP series	The temperature of the element is increased within 40°C
	LK series	The decreasing-rate of inductance value is within 5 %
	HK series	The decreasing-rate of inductance value is within 5 %, or the temperature of the element is increased within 20°C
4. Impedance		
Specified Value	BK series	Refer to each specification.
	BKP series	
	LK series	
	HK series	
Test Methods and Remarks	Measuring frequency : 100±1MHz Measuring equipment : 4291A (or its equivalent) Measuring jig : 16192A (or its equivalent), HW:16193A (or its equivalent)	
5. Inductance		
Specified Value	BK series	Refer to each specification.
	BKP series	
	LK series	
	HK series	
Test Methods and Remarks	LK Series Measuring frequency : 10~25MHz Measuring equipment /jig : 4291A+16193A (or its equivalent) Measuring current : 1mA rms HK Series Measuring frequency : 100MHz Measuring equipment /jig : 4291A+16193A (or its equivalent)	
6. Q		
Specified Value	BK series	Refer to each specification.
	BKP series	
	LK series	
	HK series	
Test Methods and Remarks	LK Series Measuring frequency : Refer to each specification. Measuring equipment /jig : 4291A+16193A (or its equivalent) Measuring current : 1mA rms HK Series Measuring frequency : 100MHz Measuring equipment /jig : 4291A+16193A (or its equivalent)	
7. DC Resistance		
Specified Value	BK series	Refer to each specification.
	BKP series	
	LK series	
	HK series	
Test Methods and Remarks	Measuring equipment : IWATSU VOAC7512 (or its equivalent)	

▶ This catalog contains the typical specification only due to the limitation of space. When you consider the purchase of our products, please check our specification. For details of each product (characteristics graph, reliability information, precautions for use, and so on), see our Web site (<http://www.ty-top.com/>).

8. Self Resonance Frequency (SRF)			
Specified Value	BK series	—	
	BKP series		
	LK series		
	HK series		
Test Methods and Remarks	Refer to each specification.		
Test Methods and Remarks	LK Series		
	Measuring equipment		: 4195A (or its equivalent)
	Measuring jig		: 41951 + 16092A (or its equivalent)
	HK Series :		
	Measuring equipment	: 8719C (or its equivalent)	

9. Resistance to Flexure of Substrate		
Specified Value	BK series	No mechanical damage.
	BKP series	
	LK series	
	HK series	
Test Methods and Remarks	Warp : 2mm Testing board : glass epoxy-resin substrate Thickness : 0.8mm	
	<p>(Unit: mm)</p>	

10. Solderability		
Specified Value	BK series	At least 90% of terminal electrode is covered by new solder.
	BKP series	
	LK series	
	HK series	
Test Methods and Remarks	Solder temperature	: 230 ± 5°C (JIS Z 3282 H60A or H63A)
	Solder temperature	: 245 ± 3°C (Sn/3.0Ag/0.5Cu)
	Duration	: 4 ± 1 sec.

11. Resistance to Soldering		
Specified Value	BK series	Appearance: No significant abnormality
	BKP series	Impedance change: Within ±30%
	LK series	Appearance: No significant abnormality Inductance change: Within ±15%
	HK series	Appearance: No significant abnormality Inductance change: Within ±5%
Test Methods and Remarks	Solder temperature	: 260 ± 5°C
	Duration	: 10 ± 0.5 sec.
	Preheating temperature	: 150 to 180°C
	Preheating time	: 3 min.
	Flux	: Immersion into methanol solution with colophony for 3 to 5 sec.
	Recovery	: 2 to 3 hrs of recovery under the standard condition after the test. (See Note 1)

(Note 1) When there are questions concerning measurement result; measurement shall be made after 48 ± 2 hrs of recovery under the standard condition.

12. Thermal Shock																
Specified Value	BK series	Appearance : No significant abnormality														
	BKP series	Impedance change : Within $\pm 30\%$														
	LK series	Appearance : No significant abnormality Inductance change : Within $\pm 10\%$ Q change : Within $\pm 30\%$														
	HK series	Appearance : No significant abnormality Inductance change : Within $\pm 10\%$ Q change : Within $\pm 20\%$														
Test Methods and Remarks	BK, BKP, HK Series Conditions for 1 cycle															
	<table border="1"> <thead> <tr> <th>Step</th> <th>temperature (°C)</th> <th>time (min.)</th> </tr> </thead> <tbody> <tr> <td>1</td> <td>-40°C +0/-3</td> <td>30±3</td> </tr> <tr> <td>2</td> <td>Room temperature</td> <td>2~3</td> </tr> <tr> <td>3</td> <td>+125°C +3/-0</td> <td>30±3</td> </tr> <tr> <td>4</td> <td>Room temperature</td> <td>2~3</td> </tr> </tbody> </table>	Step	temperature (°C)	time (min.)	1	-40°C +0/-3	30±3	2	Room temperature	2~3	3	+125°C +3/-0	30±3	4	Room temperature	2~3
Step	temperature (°C)	time (min.)														
1	-40°C +0/-3	30±3														
2	Room temperature	2~3														
3	+125°C +3/-0	30±3														
4	Room temperature	2~3														
Test Methods and Remarks	LK Series Conditions for 1 cycle															
	<table border="1"> <thead> <tr> <th>Step</th> <th>temperature (°C)</th> <th>time (min.)</th> </tr> </thead> <tbody> <tr> <td>1</td> <td>-40°C +0/-3</td> <td>30±3</td> </tr> <tr> <td>2</td> <td>Room temperature</td> <td>2~3</td> </tr> <tr> <td>3</td> <td>+85°C +3/-0</td> <td>30±3</td> </tr> <tr> <td>4</td> <td>Room temperature</td> <td>2~3</td> </tr> </tbody> </table>	Step	temperature (°C)	time (min.)	1	-40°C +0/-3	30±3	2	Room temperature	2~3	3	+85°C +3/-0	30±3	4	Room temperature	2~3
Step	temperature (°C)	time (min.)														
1	-40°C +0/-3	30±3														
2	Room temperature	2~3														
3	+85°C +3/-0	30±3														
4	Room temperature	2~3														

(Note 1) When there are questions concerning measurement result; measurement shall be made after  $48 \pm 2$  hrs of recovery under the standard condition.

13. Damp Heat ( Steady state)		
Specified Value	BK series	Appearance : No significant abnormality
	BKP series	Impedance change : Within $\pm 30\%$
	LK series	Appearance : No significant abnormality Inductance change : Within $\pm 10\%$ Q change : Within $\pm 30\%$
	HK series	Appearance : No significant abnormality Inductance change : Within $\pm 10\%$ Q change : Within $\pm 20\%$
Test Methods and Remarks	Temperature : $85 \pm 2^\circ\text{C}$ Humidity : 80 to 85%RH Duration : $1000 + 24 / - 0$ hrs Recovery : 2 to 3 hrs of recovery under the standard condition after the removal from test chamber. (See Note 1)	

14. Loading under Damp Heat		
Specified Value	BK series	Appearance : No significant abnormality
	BKP series	Impedance change : Within $\pm 30\%$
	LK series	Appearance : No significant abnormality Inductance change : Within $\pm 10\%$ Q change : Within $\pm 30\%$
	HK series	Appearance : No significant abnormality Inductance change : Within $\pm 10\%$ Q change : Within $\pm 20\%$
Test Methods and Remarks	Temperature : $85 \pm 2^\circ\text{C}$ Humidity : 80 to 85%RH Applied current : Rated current Duration : $1000 + 24 / - 0$ hrs Recovery : 2 to 3 hrs of recovery under the standard condition after the removal from test chamber. (See Note 1)	

Note on standard condition: "standard condition" referred to herein is defined as follows:

5 to 35°C of temperature, 45 to 85% relative humidity, and 86 to 106kPa of air pressure.

When there are questions concerning measurement results:

In order to provide correlation data, the test shall be conducted under condition of  $20 \pm 2^\circ\text{C}$  of temperature, 60 to 70% relative humidity, and 86 to 106kPa of air pressure.

Unless otherwise specified, all the tests are conducted under the "standard condition."

(Note 1) When there are questions concerning measurement result; Measurement shall be made after  $48 \pm 2$  hrs of recovery under the standard condition.

15. Loading at High Temperature		
Specified Value	BK series	Appearance : No significant abnormality
	BKP series	Impedance change : Within $\pm 30\%$
	LK series	Appearance : No significant abnormality Inductance change : Within $\pm 10\%$ Q change : Within $\pm 30\%$
	HK series	Appearance : No significant abnormality Inductance change : Within $\pm 10\%$ Q change : Within $\pm 20\%$
Test Methods and Remarks	Temperature : BK, HK series $\Rightarrow 125 \pm 2^\circ\text{C}$ BKP, LK series $\Rightarrow 85 \pm 2^\circ\text{C}$ Applied current : Rated current Duration : 1000+24/-0 hrs Recovery : 2 to 3 hrs of recovery under the standard condition after the removal from test chamber. (See Note 1)	

Note on standard condition: "standard condition" referred to herein is defined as follows:

5 to 35°C of temperature, 45 to 85% relative humidity, and 86 to 106kPa of air pressure.

When there are questions concerning measurement results:

In order to provide correlation data, the test shall be conducted under condition of  $20 \pm 2^\circ\text{C}$  of temperature, 60 to 70% relative humidity, and 86 to 106kPa of air pressure. Unless otherwise specified, all the tests are conducted under the "standard condition."

(Note 1) Measurement shall be made after  $48 \pm 2$  hrs of recovery under the standard condition.

# Precautions on the use of Multilayer chip inductors

## Multilayer chip inductors for high frequency, Multilayer chip bead inductors

### PRECAUTIONS

#### 1. Circuit Design

##### Precautions

- ◆ Verification of operating environment, electrical rating and performance
  1. A malfunction in medical equipment, spacecraft, nuclear reactors, etc. may cause serious harm to human life or have severe social ramifications. As such, any inductors to be used in such equipment may require higher safety and/or reliability considerations and should be clearly differentiated from components used in general purpose applications.
- ◆ Operating Current (Verification of Rated current)
  1. The operating current for inductors must always be lower than their rated values.
  2. Do not apply current in excess of the rated value because the inductance may be reduced due to the magnetic saturation effect.

#### 2. PCB Design

##### Precautions

- ◆ Pattern configurations (Design of Land-patterns)
  1. When inductors are mounted on a PCB, the size of land patterns and the amount of solder used (size of fillet) can directly affect inductor performance. Therefore, the following items must be carefully considered in the design of solder land patterns:
    - (1) The amount of solder applied can affect the ability of chips to withstand mechanical stresses which may lead to breaking or cracking. Therefore, when designing land-patterns it is necessary to consider the appropriate size and configuration of the solder pads which in turn determines the amount of solder necessary to form the fillets.
    - (2) When more than one part is jointly soldered onto the same land or pad, the pad must be designed so that each component's soldering point is separated by solder-resist.
    - (3) The larger size of land patterns and amount of solder, the smaller Q value after mounting on PCB. It makes higher the Q value to design land patterns smaller than terminal electrode of chips.
- ◆ Pattern configurations (Inductor layout on panelized [breakaway] PC boards)
  1. After inductors have been mounted on the boards, chips can be subjected to mechanical stresses in subsequent manufacturing processes (PCB cutting, board inspection, mounting of additional parts, assembly into the chassis, wave soldering the reflow soldered boards etc.) For this reason, planning pattern configurations and the position of SMD inductors should be carefully performed to minimize stress.

##### Technical considerations

- ◆ Pattern configurations (Design of Land-patterns)
  1. The following diagrams and tables show some examples of recommended patterns to prevent excessive solder amounts (larger fillets which extend above the component end terminations). Examples of improper pattern designs are also shown.
    - (1) Recommended land dimensions for a typical chip inductor land patterns for PCBs

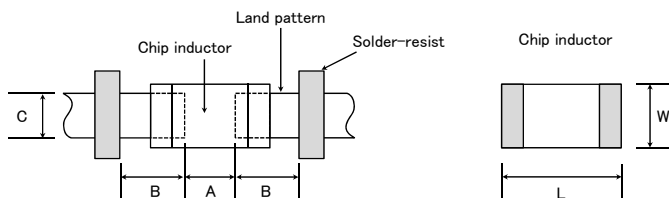

Recommended land dimensions for reflow-soldering (Unit: mm)

Type	0603	1005	
Size	L	0.6	1.0
	W	0.3	0.5
A	0.20~0.30	0.45~0.55	
B	0.20~0.30	0.40~0.50	
C	0.25~0.40	0.45~0.55	

(2) Examples of good and bad solder application

Item	Not recommended	Recommended
Mixed mounting of SMD and leaded components		
Component placement close to the chassis		
Hand-soldering of leaded components near mounted components		
Horizontal component placement		

◆Pattern configurations (Inductor layout on panelized [breakaway] PC boards)

1-1. The following are examples of good and bad inductor layout; SMD inductors should be located to minimize any possible mechanical stresses from board warp or deflection.

Item	Not recommended	Recommended
Deflection of the board		 Position the component at a right angle to the direction of the mechanical stresses that are anticipated.

1-2. To layout the inductors for the breakaway PC board, it should be noted that the amount of mechanical stresses given will vary depending on inductor layout.

An example below should be counted for better design.

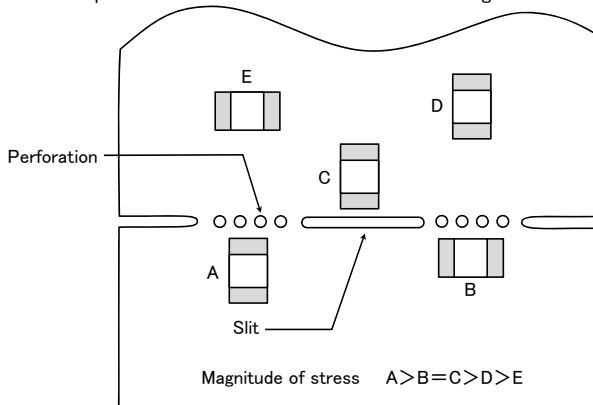

1-3. When breaking PC boards along their perforations, the amount of mechanical stress on the inductors can vary according to the method used. The following methods are listed in order from least stressful to most stressful: push-back, slit, V-grooving, and perforation. Thus, any ideal SMD inductor layout must also consider the PCB splitting procedure.

### 3. Considerations for automatic placement

#### Precautions

- ◆ Adjustment of mounting machine
  1. Excessive impact load should not be imposed on the inductors when mounting onto the PC boards.
  2. The maintenance and inspection of the mounter should be conducted periodically.
- ◆ Selection of Adhesives
  1. Mounting inductors with adhesives in preliminary assembly, before the soldering stage, may lead to degraded inductor characteristics unless the following factors are appropriately checked; the size of land patterns, type of adhesive, amount applied, hardening temperature and hardening period. Therefore, it is imperative to consult the manufacturer of the adhesives on proper usage and amounts of adhesive to use.

#### Technical considerations

- ◆ Adjustment of mounting machine
  1. If the lower limit of the pick-up nozzle is low, too much force may be imposed on the inductors, causing damage. To avoid this, the following points should be considered before lowering the pick-up nozzle:
    - (1) The lower limit of the pick-up nozzle should be adjusted to the surface level of the PC board after correcting for deflection of the board.
    - (2) The pick-up pressure should be adjusted between 1 and 3N static loads.
    - (3) To reduce the amount of deflection of the board caused by impact of the pick-up nozzle, supporting pins or back-up pins should be used under the PC board. The following diagrams show some typical examples of good pick-up nozzle placement:

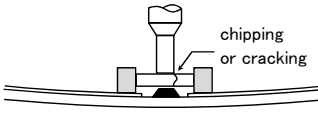
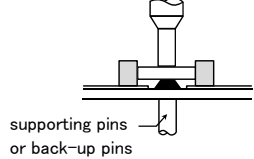
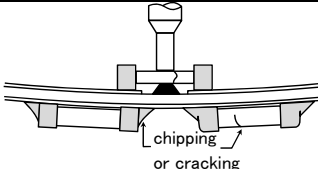
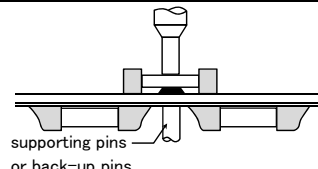
Item	Improper method	Proper method
Single-sided mounting		
Double-sided mounting		

2. As the alignment pin wears out, adjustment of the nozzle height can cause chipping or cracking of the inductors because of mechanical impact on the inductors. To avoid this, the monitoring of the width between the alignment pin in the stopped position, and maintenance, inspection and replacement of the pin should be conducted periodically.

- ◆ Selection of Adhesives
  1. Some adhesives may cause reduced insulation resistance. The difference between the shrinkage percentage of the adhesive and that of the inductors may result in stresses on the inductors and lead to cracking. Moreover, too little or too much adhesive applied to the board may adversely affect component placement, so the following precautions should be noted in the application of adhesives.
    - (1) Required adhesive characteristics
      - a. The adhesive should be strong enough to hold parts on the board during the mounting & solder process.
      - b. The adhesive should have sufficient strength at high temperatures.
      - c. The adhesive should have good coating and thickness consistency.
      - d. The adhesive should be used during its prescribed shelf life.
      - e. The adhesive should harden rapidly.
      - f. The adhesive must not be contaminated.
      - g. The adhesive should have excellent insulation characteristics.
      - h. The adhesive should not be toxic and have no emission of toxic gasses.
    - (2) When using adhesives to mount inductors on a PCB, inappropriate amounts of adhesive on the board during the solder may adversely affect component placement. Too little adhesive may cause the inductors to fall off the board during the solder process. Too much adhesive may cause defective soldering due excessive flow of adhesive on to the land or solder pad.

[Recommended conditions]

Figure	0805 case sizes as examples
a	0.3mm min
b	100~120 μm
c	Area with no adhesive

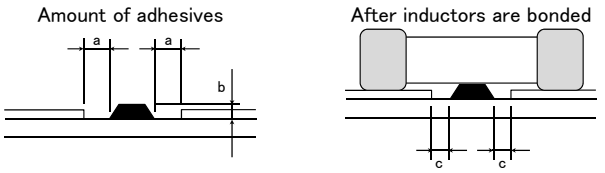

► This catalog contains the typical specification only due to the limitation of space. When you consider the purchase of our products, please check our specification. For details of each product (characteristics graph, reliability information, precautions for use, and so on), see our Web site (<http://www.ty-top.com/>).



Precautions

◆ Selection of Flux

1. Since flux may have a significant effect on the performance of inductors, it is necessary to verify the following conditions prior to use;
  - (1) Flux used should be with less than or equal to 0.1 wt% (Chlorine conversion method) of halogenated content. Flux having a strong acidity content should not be applied.
  - (2) When soldering inductors on the board, the amount of flux applied should be controlled at the optimum level.
  - (3) When using water-soluble flux, special care should be taken to properly clean the boards.

◆ Soldering

1. Temperature, time, amount of solder, etc. are specified in accordance with the following recommended conditions, and please contact us about peak temperature when you use lead-free paste.

Technical considerations

◆ Selection of Flux

- 1-1. When too much halogenated substance (Chlorine, etc.) content is used to activate the flux, or highly acidic flux is used, an excessive amount of residue after soldering may lead to corrosion of the terminal electrodes or degradation of insulation resistance on the surface of the Inductor.
- 1-2. Flux is used to increase solderability in flow soldering, but if too much is applied, a large amount of flux gas may be emitted and may detrimentally affect solderability. To minimize the amount of flux applied, it is recommended to use a flux-bubbling system.
- 1-3. Since the residue of water-soluble flux is easily dissolved by water content in the air, the residue on the surface of Inductor in high humidity conditions may cause a degradation of insulation resistance and therefore affect the reliability of the components. The cleaning methods and the capability of the machines used should also be considered carefully when selecting water-soluble flux.

◆ Soldering

1-1. Preheating when soldering

Preheating: Inductors shall be preheated sufficiently, and the temperature difference between the inductors and solder shall be within 130°C.

Cooling: The temperature difference between the components and cleaning process should not be greater than 100°C.

Inductors are susceptible to thermal shock when exposed to rapid or concentrated heating or rapid cooling. Therefore, the soldering process must be conducted with a great care so as to prevent malfunction of the components due to excessive thermal shock.

[Reflow soldering]

【Recommended condition for Pb-free soldering】

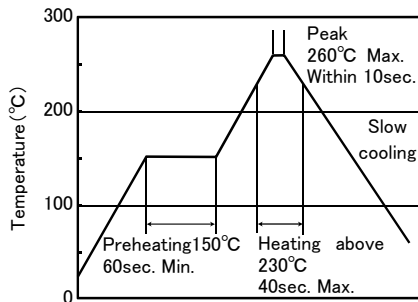

Caution

1. Solder (fillet) should wet up to 1/2 to 1/3 of the thickness of an inductor ideally as shown below:

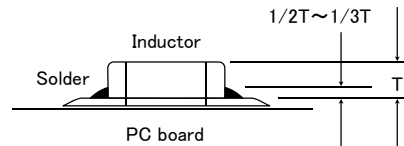

2. Because excessive dwell time can detrimentally affect solderability, soldering duration shall be kept as close to recommended time as possible.
3. The allowable number of reflow soldering is two (2) times.

[Hand soldering]

【Recommended condition for Pb-free soldering】

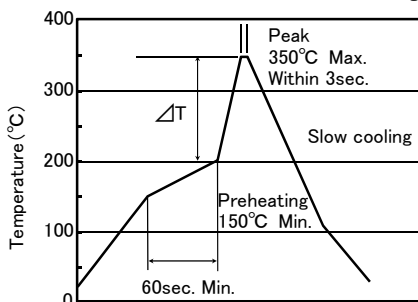

Caution

1. It is recommended to use a 20W soldering iron with a maximum tip diameter of 1.0 mm.
2. The soldering iron shall not directly touch inductors
3. The allowable number of hand soldering is one (1) time

(※ ΔT ≤ 150°C)

5. Cleaning							
Precautions	<p>◆Cleaning conditions</p> <ol style="list-style-type: none"> <li>When cleaning the PC board after the Inductors are all mounted, select the appropriate cleaning solution according to the type of flux used and purpose of the cleaning (e.g. to remove soldering flux or other materials from the production process.)</li> <li>Cleaning conditions should be determined after verifying, through a test run, that the cleaning process does not affect the inductor's characteristics.</li> </ol>						
Technical considerations	<p>◆Cleaning conditions</p> <ol style="list-style-type: none"> <li>The use of inappropriate solutions can cause foreign substances such as flux residue to adhere to the inductor, resulting in a degradation of the inductor's electrical properties (especially insulation resistance).</li> <li>Inappropriate cleaning conditions (insufficient or excessive cleaning) may detrimentally affect the performance of the inductors. In the case of ultrasonic cleaning, too much power output can cause excessive vibration of the PC board which may lead to the cracking of the inductor or the soldered portion, or decrease the terminal electrodes' strength. Therefore, the following conditions should be carefully checked;</li> </ol> <table border="0"> <tr> <td>Ultrasonic output</td> <td>20W/ℓ or less</td> </tr> <tr> <td>Ultrasonic frequency</td> <td>40kHz or less</td> </tr> <tr> <td>Ultrasonic washing period</td> <td>5 min. or less</td> </tr> </table>	Ultrasonic output	20W/ℓ or less	Ultrasonic frequency	40kHz or less	Ultrasonic washing period	5 min. or less
Ultrasonic output	20W/ℓ or less						
Ultrasonic frequency	40kHz or less						
Ultrasonic washing period	5 min. or less						

## 6. Resin coating and mold

Precautions	<ol style="list-style-type: none"> <li>With some type of resins a decomposition gas or chemical reaction vapor may remain inside the resin during the hardening period or while left under normal storage conditions resulting in the deterioration of the inductor's performance.</li> <li>Thermal expansion and thermal shrinkage characteristics of resins may lead to the deterioration of inductors' performance.</li> <li>When a resin hardening temperature is higher than inductor operating temperature, the stresses generated by the excessive heat may lead to damage in inductors.</li> </ol>
-------------	--

## 7. Handling

Precautions	<p>◆Breakaway PC boards (splitting along perforations)</p> <ol style="list-style-type: none"> <li>When splitting the PC board after mounting inductors and other components, care is required so as not to give any stresses of deflection or twisting to the board.</li> <li>Board separation should not be done manually, but by using the appropriate devices.</li> </ol> <p>◆General handling precautions</p> <ol style="list-style-type: none"> <li>Always wear static control bands to protect against ESD.</li> <li>Keep the inductors away from all magnets and magnetic objects.</li> <li>Use non-magnetic tweezers when handling inductors.</li> <li>Any devices used with the inductors ( soldering irons, measuring instruments) should be properly grounded.</li> <li>Keep bare hands and metal products (i.e., metal desk) away from inductor electrodes or conductive areas that lead to chip electrodes.</li> <li>Keep inductors away from items that generate magnetic fields such as speakers or coils.</li> </ol> <p>◆Mechanical considerations</p> <ol style="list-style-type: none"> <li>Be careful not to subject the inductors to excessive mechanical shocks. <ol style="list-style-type: none"> <li>If inductors are dropped on the floor or a hard surface they should not be used.</li> <li>When handling the mounted boards, be careful that the mounted components do not come in contact with or bump against other boards or components.</li> </ol> </li> </ol>
-------------	--

## 8. Storage conditions

Precautions	<p>◆Storage</p> <ol style="list-style-type: none"> <li>To maintain the solderability of terminal electrodes and to keep the packaging material in good condition, care must be taken to control temperature and humidity in the storage area. Humidity should especially be kept as low as possible.</li> </ol> <p>•Recommended conditions</p> <p>Ambient temperature: 30°C or below    Humidity: 70% RH or below</p> <p>The ambient temperature must be kept below 40°C. Even under ideal storage conditions, solderability of inductor is deteriorated as time passes, so inductors should be used within 6 months from the time of delivery.</p> <p>•Inductor should be kept where no chlorine or sulfur exists in the air.</p>
Technical considerations	<p>◆Storage</p> <ol style="list-style-type: none"> <li>If the parts are stocked in a high temperature and humidity environment, problems such as reduced solderability caused by oxidation of terminal electrodes and deterioration of taping/packaging materials may take place. For this reason, components should be used within 6 months from the time of delivery. If exceeding the above period, please check solderability before using the inductors.</li> </ol>

# CHIP BEAD INDUCTORS FOR POWER LINES (FB SERIES M TYPE)

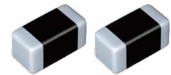

REFLOW

■ PART NUMBER

\*Operating Temp. : -40~125°C (Including self-generated heat)

F	B	△	M	J	3	2	1	6	H	S	8	0	0	-	T	V
①	②	③	④	⑤	⑥	⑦	⑧	⑨								

△ = Blank space

① Series name

Code	Series name
FB	Ferrite bead

② Shape

Code	Shape
M	Rectangular chip

③ Characteristics

Code	Characteristics
J	Standard
H	High Impedance type

④ Dimensions (L × W)

Code	Type (inch)	Dimensions (L × W) [mm]
1608	1608 (0603)	1.6 × 0.8
2125	2125 (0805)	2.0 × 1.25
2012	2012 (0805)	
2016	2016 (0806)	2.0 × 1.6
3216	3216 (1206)	3.2 × 1.6
3225	3225 (1210)	3.2 × 2.5
4516	4516 (1806)	4.5 × 1.6
4525	4525 (1810)	4.5 × 2.5

⑤ Material

Code	Material
HS	Refer to impedance curves for material differences
HM	
HL	

⑥ Nominal impedance

Code (example)	Nominal impedance [Ω]
330	33
221	220
102	1000

⑦ Impedance tolerance

Code	Impedance tolerance
-	±25%
N	±30%

⑧ Packaging

Code	Packaging
T	Taping

⑨ Internal code

Code	Internal code
V	Bead Inductor for Automotive
W	
8	Bead Inductor for Telecommunications infrastructure and Industrial equipment / Medical devices

■ FEATURES

- HS: For broadband applications
- HM: For upper MHz range applications
- HL: For GHz range applications

■ STANDARD EXTERNAL DIMENSIONS / STANDARD QUANTITY

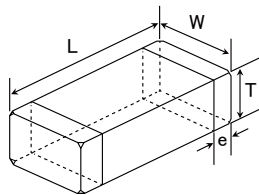

Recommended Land Patterns

Surface Mounting

• Mounting and soldering conditions should be checked beforehand.

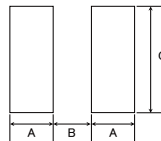

Type	A	B	C
FB MJ1608	1.0	1.0	1.0
FB MJ2125	1.4	1.2	1.65
FB MJ3216	1.4	2.2	2.0
FB MJ4516	1.75	3.5	2.0
FB MH1608	1.0	1.0	1.0
FB MH2012	1.4	1.2	1.65
FB MH2016	1.4	1.2	2.0
FB MH3216	1.4	2.2	2.0
FB MH3225	1.4	2.2	2.9
FB MH4516	1.75	3.5	2.0
FB MH4525	1.75	3.5	2.9

Unit: mm

Type	L	W	T	e	Standard quantity [pcs]	
					Paper tape	Embossed tape
FB MJ1608 (0603)	1.6±0.2 (0.063±0.008)	0.8±0.2 (0.031±0.008)	0.8±0.2 (0.031±0.008)	0.3±0.2 (0.012±0.008)	4000	-
FB MJ2125 (0805)	2.0±0.2 (0.079±0.008)	1.25±0.2 (0.049±0.008)	0.85±0.2 (0.033±0.008)	0.5±0.3 (0.020±0.012)	4000	-
FB MJ3216 (1206)	3.2±0.3 (0.126±0.012)	1.6±0.2 (0.063±0.008)	1.1±0.2 (0.043±0.008)	0.5±0.3 (0.020±0.012)	-	2000
FB MJ4516 (1806)	4.5±0.3 (0.177±0.012)	1.6±0.2 (0.063±0.008)	1.1±0.2 (0.043±0.008)	0.5±0.3 (0.020±0.012)	-	2000
FB MH1608 (0603)	1.6±0.1 (0.063±0.004)	0.8±0.1 (0.031±0.004)	0.8±0.1 (0.031±0.004)	0.3±0.15 (0.012±0.006)	4000	-
FB MH2012 (0805)	2.0±0.2 (0.079±0.008)	1.25±0.2 (0.049±0.008)	0.85±0.2 (0.033±0.008)	0.5±0.3 (0.020±0.012)	4000	-
FB MH2016 (0806)	2.0±0.2 (0.079±0.008)	1.6±0.2 (0.063±0.008)	1.6±0.2 (0.063±0.008)	0.5±0.3 (0.020±0.012)	-	2000
FB MH3216 (1206)	3.2±0.3 (0.126±0.012)	1.6±0.2 (0.063±0.008)	1.6±0.2 (0.063±0.008)	0.5±0.3 (0.020±0.012)	-	2000
FB MH3225 (1210)	3.2±0.3 (0.126±0.012)	2.5±0.3 (0.098±0.012)	2.5±0.3 (0.098±0.012)	0.5±0.3 (0.020±0.012)	-	1000
FB MH4516 (1806)	4.5±0.3 (0.177±0.012)	1.6±0.2 (0.063±0.008)	1.6±0.2 (0.063±0.008)	0.5±0.3 (0.020±0.012)	-	2000
FB MH4525 (1810)	4.5±0.4 (0.177±0.016)	2.5±0.3 (0.098±0.012)	2.5±0.3 (0.098±0.012)	0.9±0.6 (0.035±0.024)	-	1000

Unit: mm (inch)

▶ This catalog contains the typical specification only due to the limitation of space. When you consider the purchase of our products, please check our product specification sheets. For details of each product (characteristics graph, reliability information, precautions for use, and so on), see our website (<http://www.ty-top.com/>).

■ PART NUMBER

• All the Chip Bead Inductors for Power Lines of the catalog lineup are RoHS compliant.

Notes)

- The exchange of individual specifications is necessary depending on your application and/or circuit condition. Please contact TAIYO YUDEN's official sales channel.
- The products are for Telecommunications infrastructure and Industrial equipment and for Medical devices. Please consult with TAIYO YUDEN's official sales channel for the details of the product specifications, etc., and please review and approve the product specifications before ordering.

Please be sure to contact us for further information in advance when the products are used for automotive electronic equipment.

Standard type

● FB MJ2125

Part number	Nominal impedance (Ω)	Impedance tolerance	Measuring frequency [MHz]	DC Resistance [Ω] (max.)	Rated current [A] (max.)	Thickness [mm]	Note
FB MJ2125HS250NT8	25	±30%	100	0.004	6.0	0.85 ±0.2	
FB MJ2125HS420-T8	42	±25%	100	0.008	4.0	0.85 ±0.2	
FB MJ2125HM210NT8	21	±30%	100	0.004	6.0	0.85 ±0.2	
FB MJ2125HM330-T8	33	±25%	100	0.008	4.0	0.85 ±0.2	
FB MJ2125HL8R0NT8	8	±30%	100	0.008	4.0	0.85 ±0.2	

● FB MJ3216

Part number	Nominal impedance (Ω)	Impedance tolerance	Measuring frequency [MHz]	DC Resistance [Ω] (max.)	Rated current [A] (max.)	Thickness [mm]	Note
FB MJ3216HS480NT8	48	±30%	100	0.005	6.0	1.1 ±0.2	
FB MJ3216HS800-T8	80	±25%	100	0.010	4.0	1.1 ±0.2	
FB MJ3216HM380NT8	38	±30%	100	0.005	6.0	1.1 ±0.2	
FB MJ3216HM600-T8	60	±25%	100	0.010	4.0	1.1 ±0.2	
FB MJ3216HL160NT8	16	±30%	100	0.012	4.0	1.1 ±0.2	

● FB MJ4516

Part number	Nominal impedance (Ω)	Impedance tolerance	Measuring frequency [MHz]	DC Resistance [Ω] (max.)	Rated current [A] (max.)	Thickness [mm]	Note
FB MJ4516HS720NT8	72	±30%	100	0.007	6.0	1.1 ±0.2	
FB MJ4516HS111-T8	110	±25%	100	0.014	4.0	1.1 ±0.2	
FB MJ4516HM560NT8	56	±30%	100	0.007	6.0	1.1 ±0.2	
FB MJ4516HM900-T8	90	±25%	100	0.014	4.0	1.1 ±0.2	
FB MJ4516HL230NT8	23	±30%	100	0.014	3.5	1.1 ±0.2	

High impedance type (GHz Band)

● FB MH1608

Part number	Nominal impedance Measuring frequency 100 [MHz]		Nominal impedance Measuring frequency 1 [GHz]		DC Resistance [Ω] (max.)	Rated current [A] (max.)	Thickness [mm]	Note
	(Ω)	tolerance	(Ω)	tolerance				
FB MH1608HM470-T8	47	±25%	75	±40%	0.020	3.5	0.8 ±0.1	
FB MH1608HM600-T8	60	±25%	100	±40%	0.025	3.0	0.8 ±0.1	
FB MH1608HM101-T8	100	±25%	170	±40%	0.035	2.5	0.8 ±0.1	
FB MH1608HM151-T8	150	±25%	270	±40%	0.050	2.1	0.8 ±0.1	
FB MH1608HM221-T8	220	±25%	370	±40%	0.070	1.8	0.8 ±0.1	
FB MH1608HM331-T8	330	±25%	520	±40%	0.130	1.2	0.8 ±0.1	
FB MH1608HM471-T8	470	±25%	750	±40%	0.150	1.0	0.8 ±0.1	
FB MH1608HM601-T8	600	±25%	900	±40%	0.170	0.9	0.8 ±0.1	
FB MH1608HM102-T8	1000	±25%	1200	±40%	0.350	0.6	0.8 ±0.1	
FB MH1608HL300-T8	30	±25%	120	±40%	0.028	2.6	0.8 ±0.1	
FB MH1608HL600-T8	60	±25%	220	±40%	0.045	2.1	0.8 ±0.1	
FB MH1608HL121-T8	120	±25%	540	±40%	0.130	1.2	0.8 ±0.1	
FB MH1608HL221-T8	220	±25%	950	±40%	0.170	0.9	0.8 ±0.1	
FB MH1608HL331-T8	330	±25%	1200	±40%	0.210	0.8	0.8 ±0.1	
FB MH1608HL471-T8	470	±25%	1500	±40%	0.350	0.6	0.8 ±0.1	
FB MH1608HL601-T8	600	±25%	1800	±40%	0.450	0.5	0.8 ±0.1	

※) The rated current is the value of current at which the temperature of the element is increased by 40 deg.

► This catalog contains the typical specification only due to the limitation of space. When you consider the purchase of our products, please check our product specification sheets. For details of each product (characteristics graph, reliability information, precautions for use, and so on), see our website (<http://www.ty-top.com/>).

## PART NUMBER

High impedance type

## ● FB MH2012

Part number	Nominal impedance (Ω)	Impedance tolerance	Measuring frequency [MHz]	DC Resistance [Ω] (max.)	Rated current [A] (max.)	Thickness [mm]	Note
FB MH2012HM800-T8	80	±25%	100	0.025	2.7	0.85 ±0.2	
FB MH2012HM121-T8	120	±25%	100	0.032	2.5	0.85 ±0.2	
FB MH2012HM221-T8	220	±25%	100	0.060	2.0	0.85 ±0.2	
FB MH2012HM331-T8	330	±25%	100	0.080	1.8	0.85 ±0.2	

## ● FB MH2016

Part number	Nominal impedance (Ω)	Impedance tolerance	Measuring frequency [MHz]	DC Resistance [Ω] (max.)	Rated current [A] (max.)	Thickness [mm]	Note
FB MH2016HM121NT8	120	±30%	100	0.015	4.5	1.6 ±0.2	
FB MH2016HM251NT8	250	±30%	100	0.050	2.0	1.6 ±0.2	

## ● FB MH3216

Part number	Nominal impedance (Ω)	Impedance tolerance	Measuring frequency [MHz]	DC Resistance [Ω] (max.)	Rated current [A] (max.)	Thickness [mm]	Note
FB MH3216HM221NT8	220	±30%	100	0.020	4.0	1.6 ±0.2	
FB MH3216HM501NT8	500	±30%	100	0.070	2.0	1.6 ±0.2	

## ● FB MH3225

Part number	Nominal impedance (Ω)	Impedance tolerance	Measuring frequency [MHz]	DC Resistance [Ω] (max.)	Rated current [A] (max.)	Thickness [mm]	Note
FB MH3225HM601NT8	600	±30%	100	0.042	3.0	2.5 ±0.3	
FB MH3225HM102NT8	1000	±30%	100	0.100	2.0	2.5 ±0.3	
FB MH3225HM202NT8	2000	±30%	100	0.130	1.2	2.5 ±0.3	

## ● FB MH4516

Part number	Nominal impedance (Ω)	Impedance tolerance	Measuring frequency [MHz]	DC Resistance [Ω] (max.)	Rated current [A] (max.)	Thickness [mm]	Note
FB MH4516HM851NT8	850	±30%	100	0.100	1.5	1.6 ±0.2	

## ● FB MH4525

Part number	Nominal impedance (Ω)	Impedance tolerance	Measuring frequency [MHz]	DC Resistance [Ω] (max.)	Rated current [A] (max.)	Thickness [mm]	Note
FB MH4525HM102NT8	1000	±30%	100	0.060	3.0	2.5 ±0.3	
FB MH4525HM162NT8	1600	±30%	100	0.130	2.0	2.5 ±0.3	

## ● High current type

Part number	Nominal impedance (Ω)	Impedance tolerance	Measuring frequency [MHz]	DC Resistance [Ω] (max.)	Rated current [A] (max.)	Thickness [mm]	Note
FB MJ1608HS220NT8	22	±30%	100	0.004	7.5	0.8 ±0.2	
FB MJ1608HS280NT8	28	±30%	100	0.006	6.0	0.8 ±0.2	
FB MJ1608HM180NT8	18	±30%	100	0.004	7.5	0.8 ±0.2	
FB MJ1608HM230NT8	23	±30%	100	0.006	6.0	0.8 ±0.2	

※) The rated current is the value of current at which the temperature of the element is increased by 40 deg.

ELECTRICAL CHARACTERISTICS

Standard type

■ FB MJ2125

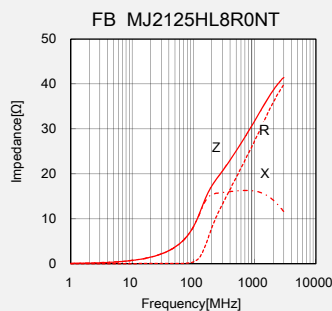
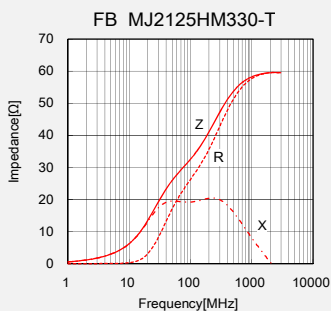
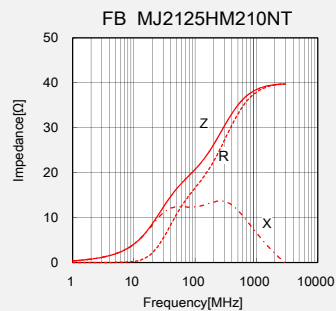
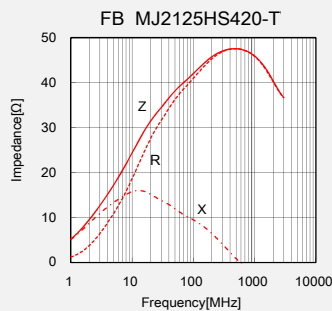
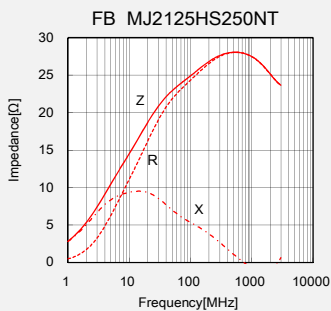

■ FB MJ3216

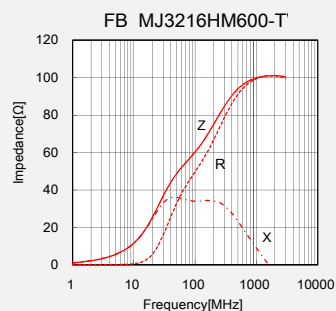
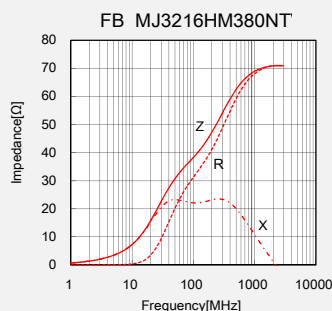
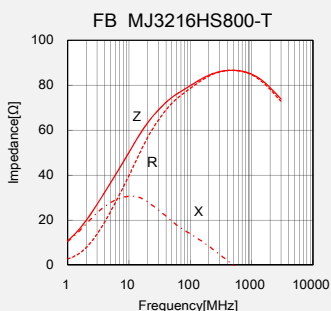
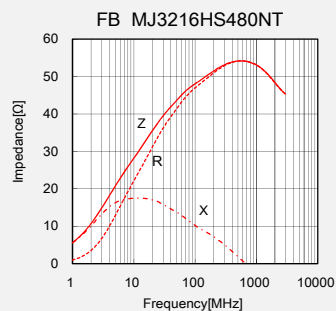

■ FB MJ4516

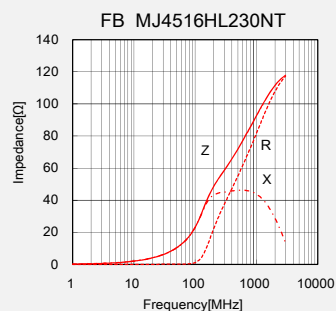
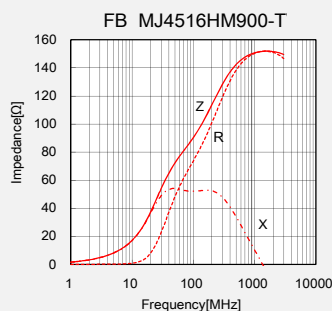
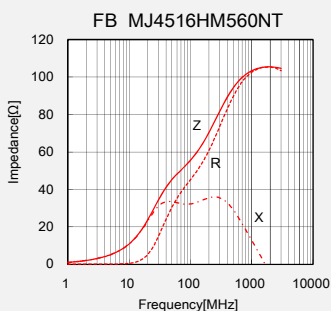
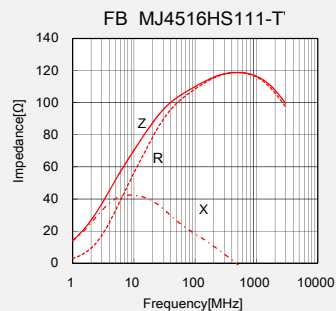
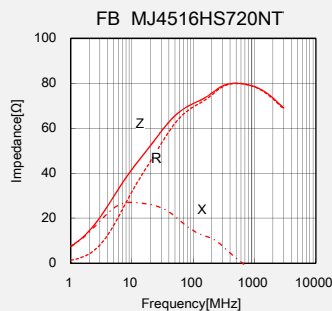
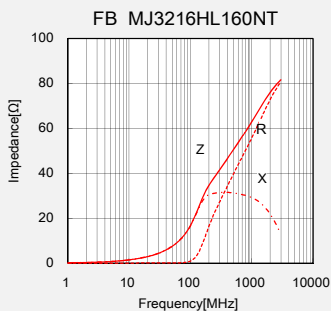

► This catalog contains the typical specification only due to the limitation of space. When you consider the purchase of our products, please check our product specification sheets. For details of each product (characteristics graph, reliability information, precautions for use, and so on), see our website (<http://www.ty-top.com/>).

ELECTRICAL CHARACTERISTICS

High impedance type(GHz Band)

FB MH1608

For Telecommunications Infrastructure and Industrial Equipment / Medical Devices  
CHIP BEAD INDUCTORS FOR POWER LINES (FB SERIES M TYPE)

NOISE SUPPRESSION COMPONENTS

INDL

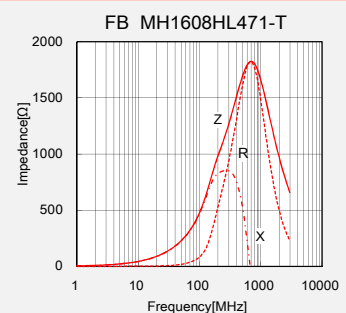
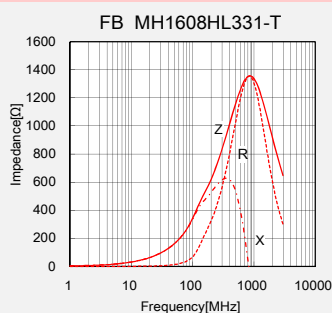
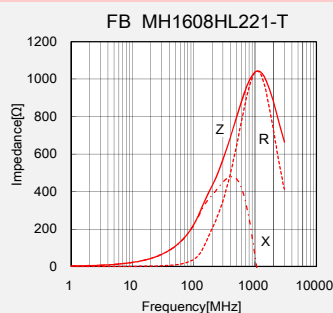
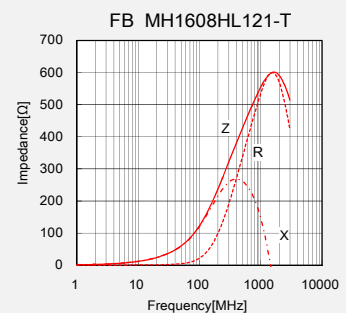
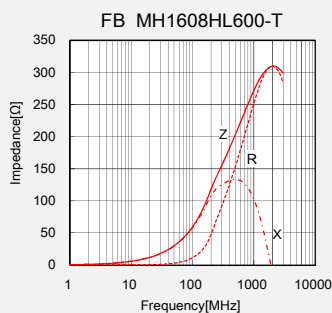
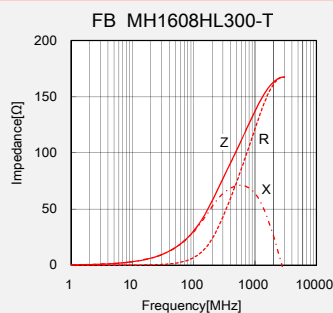
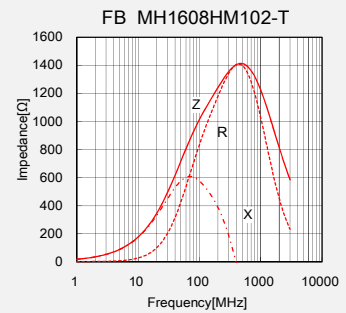
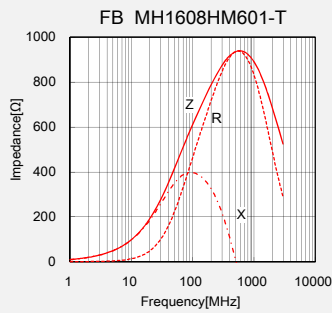
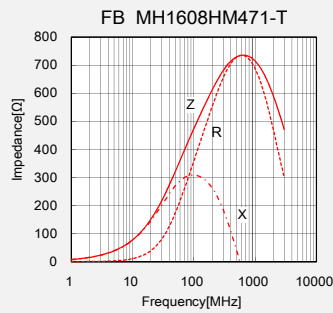
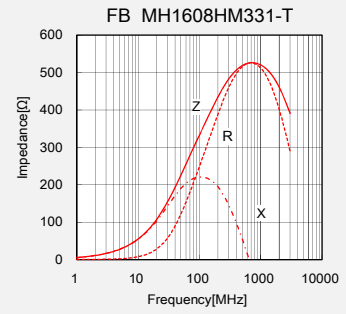
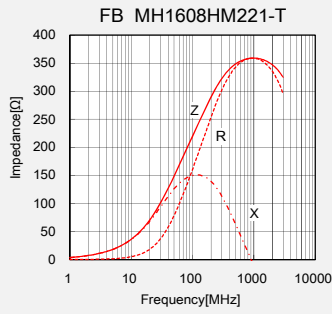
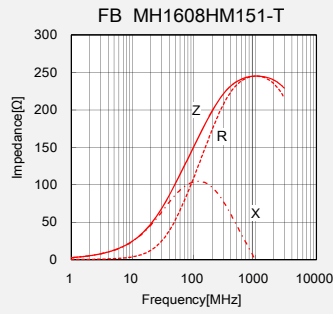
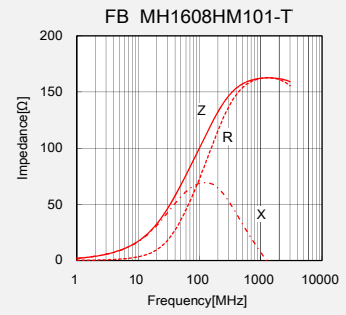
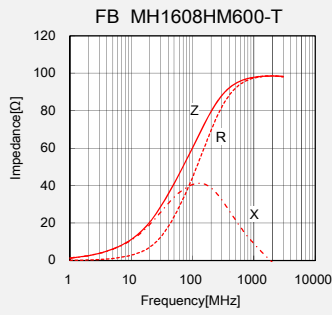
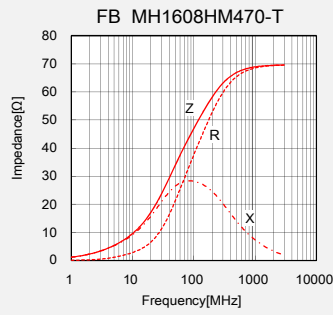

▶ This catalog contains the typical specification only due to the limitation of space. When you consider the purchase of our products, please check our product specification sheets. For details of each product (characteristics graph, reliability information, precautions for use, and so on), see our website (<http://www.ty-top.com/>).

ELECTRICAL CHARACTERISTICS

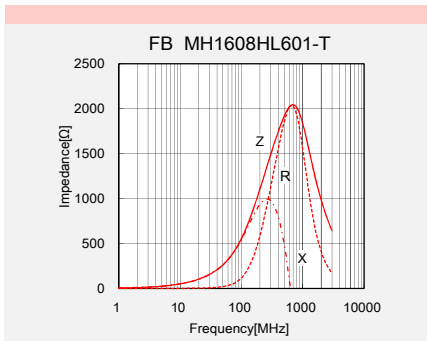

High impedance type

FB MH2012

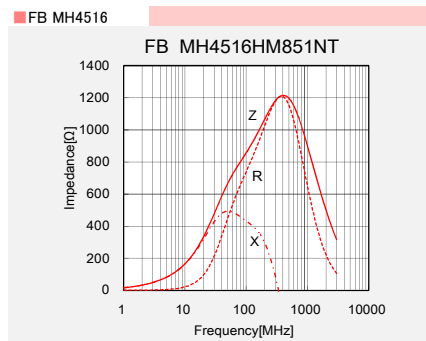
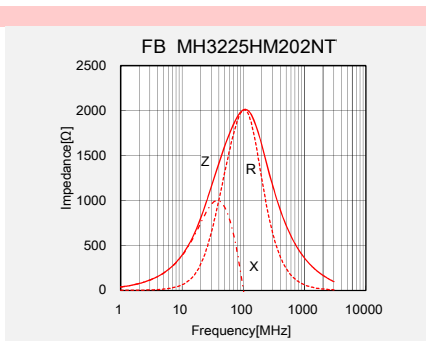
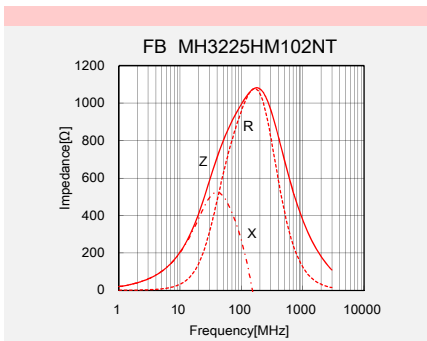
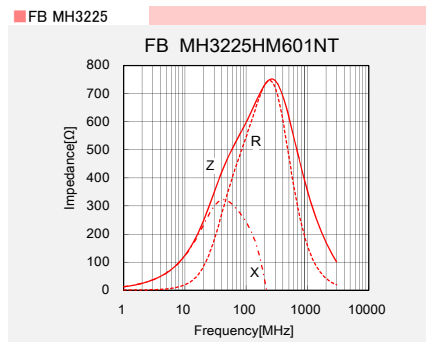
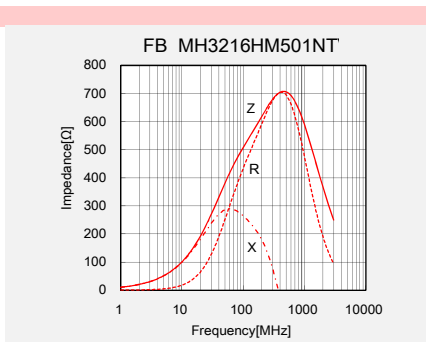
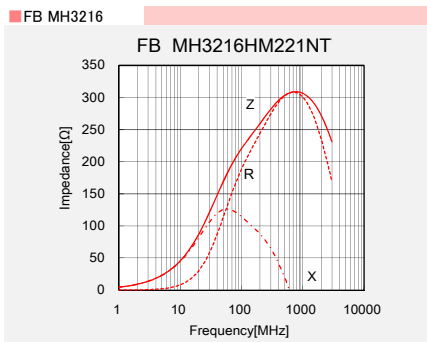
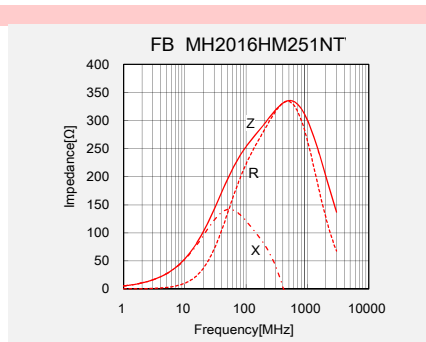
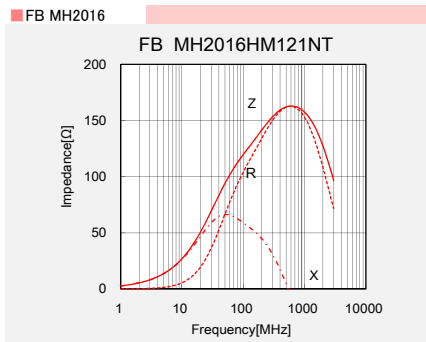
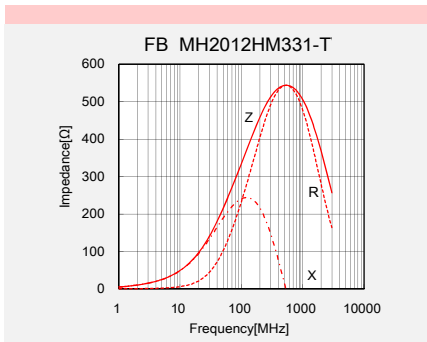
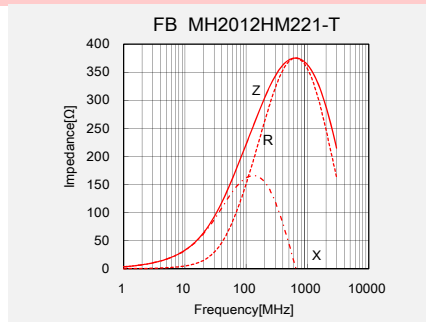
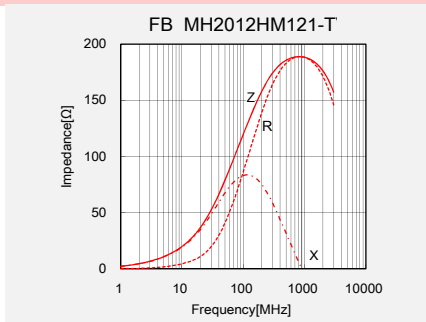
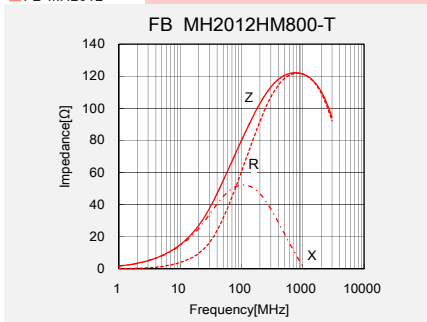

► This catalog contains the typical specification only due to the limitation of space. When you consider the purchase of our products, please check our product specification sheets. For details of each product (characteristics graph, reliability information, precautions for use, and so on), see our website (<http://www.ty-top.com/>).



ELECTRICAL CHARACTERISTICS

FB MH4525

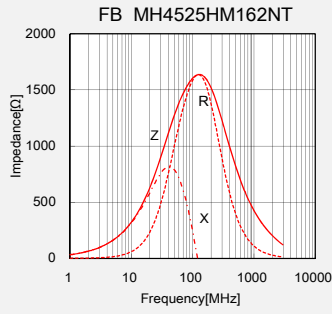
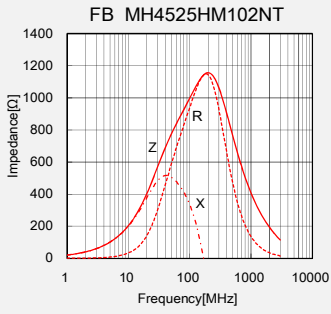

High current type

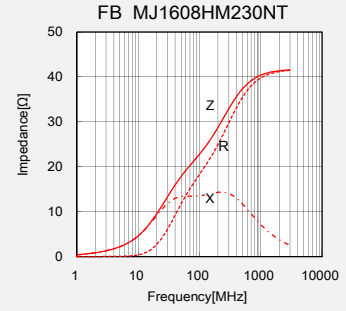
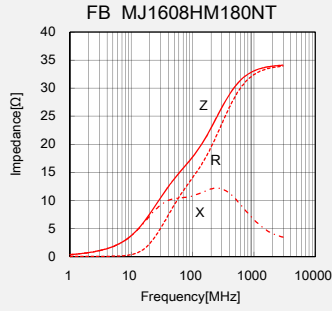
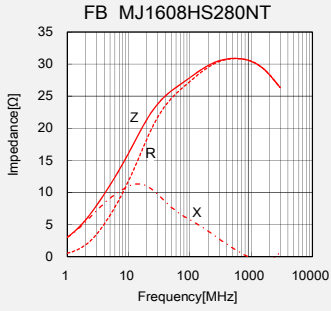
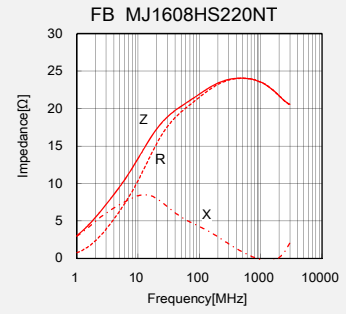

Derating of Rated Current

FB series M type

Derating of current is necessary for FB series M type depending on ambient temperature. Please refer to the chart shown below for appropriate derating of current.

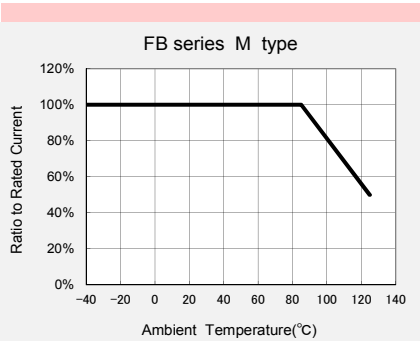

For Telecommunications Infrastructure and Industrial Equipment / Medical Devices  
CHIP BEAD INDUCTORS FOR POWER LINES (FB SERIES M TYPE)

NOISE SUPPRESSION  
COMPONENTS

INDL

▶ This catalog contains the typical specification only due to the limitation of space. When you consider the purchase of our products, please check our product specification sheets. For details of each product (characteristics graph, reliability information, precautions for use, and so on), see our website (<http://www.ty-top.com/>).

# CHIP BEAD INDUCTORS FOR POWER LINES (FB SERIES T TYPE)

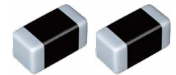

REFLOW  
AEC-Q200

AEC-Q200 Grade 1 (we conduct the evaluation at the test condition of Grade 1.)  
\*Operating environment Temp:-40~125°C

■ PART NUMBER

\*Operating Temp. : -40~150°C (Including self-generated heat)

F	B	△	T	H	1	6	0	8	H	E	4	7	0	-	T
①	②	③	④	⑤	⑥	⑦	⑧								

△=Blank space

① Series name

Code	Series name
FB	Ferrite bead

② Shape

Code	Shape
T	Rectangular chip (High-Reliability)

③ Characteristics

Code	Characteristics
H	High Impedance type

④ Dimensions (L × W)

Code	Type (inch)	Dimensions (L × W) [mm]
1608	1608 (0603)	1.6 × 0.8

⑤ Material

Code	Material
HE	Refer to impedance curves for material differences
HL	

⑥ Nominal impedance

Code (example)	Nominal impedance [Ω]
300	30
221	220
102	1000

⑦ Impedance tolerance

Code	Impedance tolerance
-	±25%

⑧ Packaging

Code	Packaging
T	Taping

■ FEATURES

- HE: For upper MHz range applications
- HL: For GHz range applications

■ STANDARD EXTERNAL DIMENSIONS / STANDARD QUANTITY

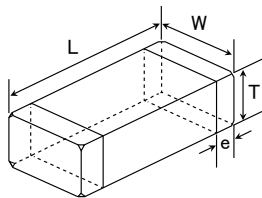

Recommended Land Patterns  
Surface Mounting

• Mounting and soldering conditions should be checked beforehand.

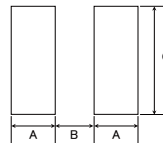

Type	A	B	C
FB TH1608	1.0	1.0	1.0

Unit: mm

Type	L	W	T	e	Standard quantity [pcs]	
					Paper tape	Embossed tape
FB TH1608 (0603)	1.6±0.15 (0.063±0.006)	0.8±0.15 (0.031±0.006)	0.8±0.15 (0.031±0.006)	0.4±0.2 (0.015±0.008)	4000	-

Unit: mm (inch)

► This catalog contains the typical specification only due to the limitation of space. When you consider the purchase of our products, please check our product specification sheets. For details of each product (characteristics graph, reliability information, precautions for use, and so on), see our website (<http://www.ty-top.com/>).

## PART NUMBER

- All the Chip Bead Inductors for Power Lines of the catalog lineup are RoHS compliant.

## Notes)

- The exchange of individual specifications is necessary depending on your application and/or circuit condition. Please contact TAIYO YUDEN's official sales channel.
- For Automotive (AEC-Q200 Qualified) products for POWERTRAIN, and SAFETY. Please check "Automotive Application Guide" for further details before using the products.
  - < AEC-Q200 : AEC-Q200 qualified >
  - All the Chip Bead Inductors for Power Lines for Automotive products are tested based on the test conditions and methods defined in AEC-Q200 by family item. Please consult with TAIYO YUDEN's official sales channel for the details of the product specifications and AEC-Q200 test results, etc., and please review and approve the product specifications before ordering.
- The products are for Telecommunications infrastructure and Industrial equipment and for Medical devices. Please consult with TAIYO YUDEN's official sales channel for the details of the product specifications, etc., and please review and approve the product specifications before ordering. Please be sure to contact us for further information in advance when the products are used for automotive electronic equipment.

## FB TH1608HE

Part number	Nominal impedance (Ω)	Impedance tolerance	Measuring frequency [MHz]	DC Resistance [Ω] (max.)	Rated current [A] (max.)	Thickness [mm]	Note
FB TH1608HE470-T	47	±25%	100	0.020	2.5	0.8 ±0.15	
FB TH1608HE600-T	60	±25%	100	0.025	2.3	0.8 ±0.15	
FB TH1608HE101-T	100	±25%	100	0.035	1.9	0.8 ±0.15	
FB TH1608HE151-T	150	±25%	100	0.050	1.5	0.8 ±0.15	
FB TH1608HE221-T	220	±25%	100	0.070	1.3	0.8 ±0.15	
FB TH1608HE331-T	330	±25%	100	0.130	0.9	0.8 ±0.15	
FB TH1608HE471-T	470	±25%	100	0.150	0.7	0.8 ±0.15	
FB TH1608HE601-T	600	±25%	100	0.170	0.6	0.8 ±0.15	
FB TH1608HE102-T	1000	±25%	100	0.350	0.5	0.8 ±0.15	

## FB TH1608HL

Part number	Nominal impedance (Ω)	Impedance tolerance	Measuring frequency [MHz]	DC Resistance [Ω] (max.)	Rated current [A] (max.)	Thickness [mm]	Note
FB TH1608HL300-T	30	±25%	100	0.028	2.00	0.8 ±0.15	
FB TH1608HL600-T	60	±25%	100	0.045	1.60	0.8 ±0.15	
FB TH1608HL121-T	120	±25%	100	0.130	0.95	0.8 ±0.15	
FB TH1608HL221-T	220	±25%	100	0.170	0.65	0.8 ±0.15	
FB TH1608HL331-T	330	±25%	100	0.210	0.60	0.8 ±0.15	
FB TH1608HL471-T	470	±25%	100	0.350	0.50	0.8 ±0.15	
FB TH1608HL601-T	600	±25%	100	0.450	0.42	0.8 ±0.15	

※) The rated current is the value of current at which the temperature of the element is increased by 40 deg.

ELECTRICAL CHARACTERISTICS

FB TH1608HE

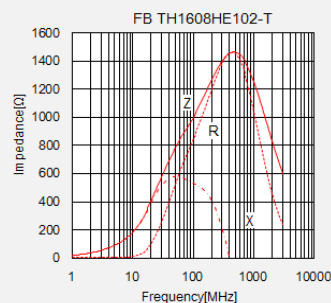
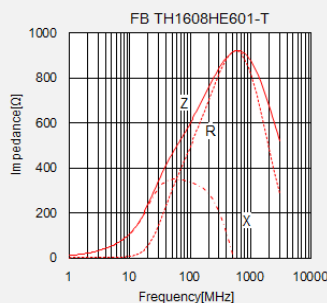
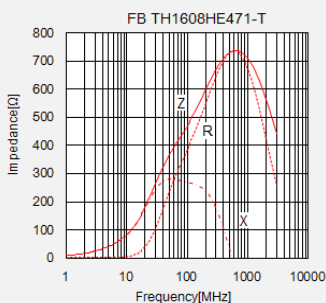
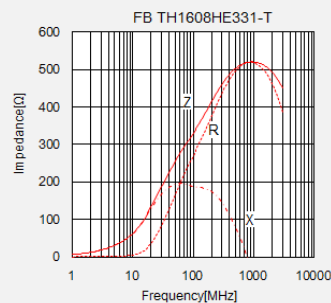
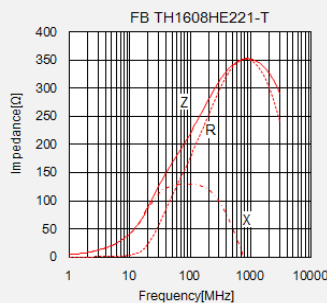
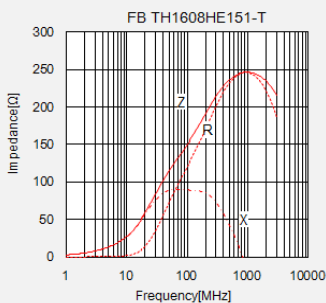
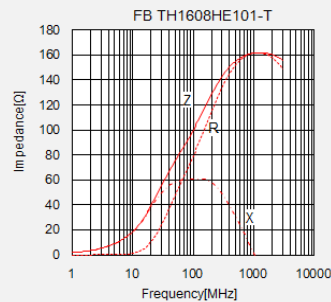
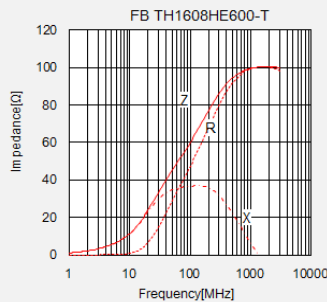
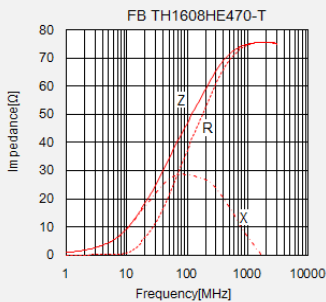

FB TH1608HL

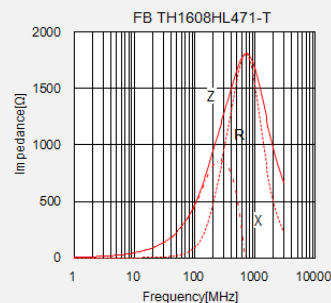
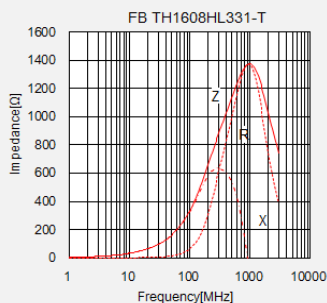
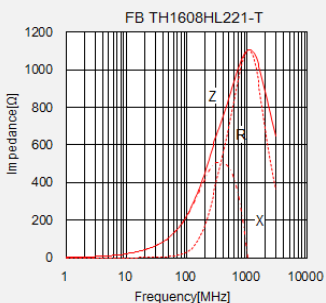
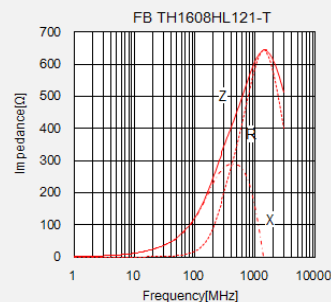
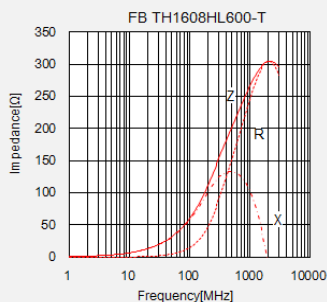
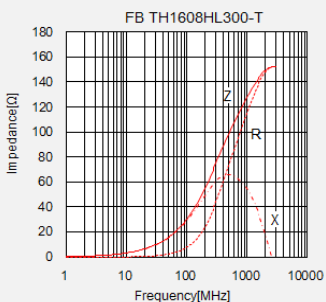

CHIP BEAD INDUCTORS FOR POWER LINES (FB SERIES T TYPE)

NOISE SUPPRESSION COMPONENTS

AUTO

INDL

► This catalog contains the typical specification only due to the limitation of space. When you consider the purchase of our products, please check our product specification sheets. For details of each product (characteristics graph, reliability information, precautions for use, and so on), see our website (<http://www.ty-top.com/>).

ELECTRICAL CHARACTERISTICS

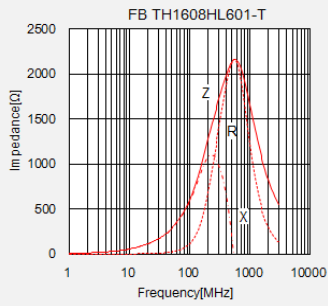

Derating of Rated Current

FB series T type

Derating of current is necessary for FB series T type depending on ambient temperature. Please refer to the chart shown below for appropriate derating of current.

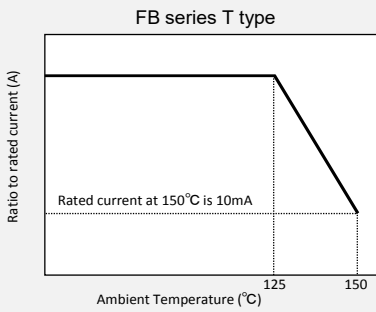

CHIP BEAD INDUCTORS FOR POWER LINES (FB SERIES T TYPE)

NOISE SUPPRESSION COMPONENTS

AUTO

INDL

► This catalog contains the typical specification only due to the limitation of space. When you consider the purchase of our products, please check our product specification sheets. For details of each product (characteristics graph, reliability information, precautions for use, and so on), see our website (<http://www.ty-top.com/>).

# CHIP BEAD INDUCTORS FOR POWER LINES (FB SERIES M TYPE / T TYPE)

## PACKAGING

### ① Minimum Quantity

Type	Standard Quantity [pcs]	
	Paper Tape	Embossed Tape
1608 (0603)	4000	—
2125 (0805)	4000	—
2012 (0805)	4000	—
2016 (0806)	—	2000
3216 (1206)	—	2000
3225 (1210)	—	1000
4516 (1806)	—	2000
4525 (1810)	—	1000
4532 (1812)	—	2000

### ② Tape Material

#### ● Card board carrier tape

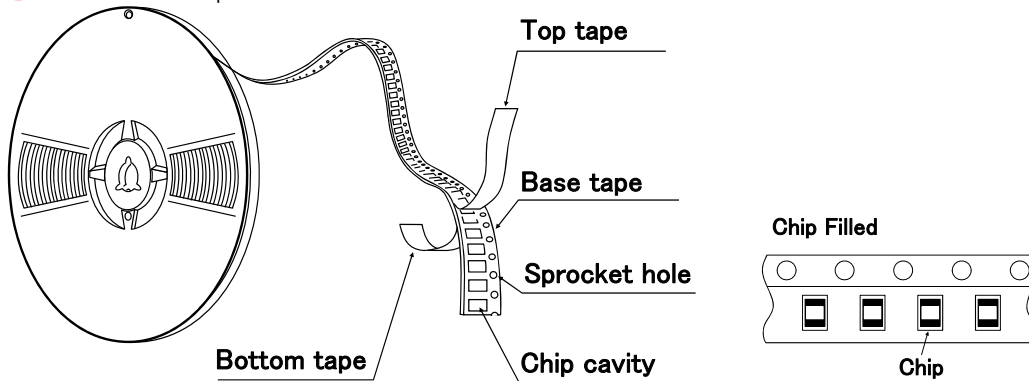

#### ● Embossed tape

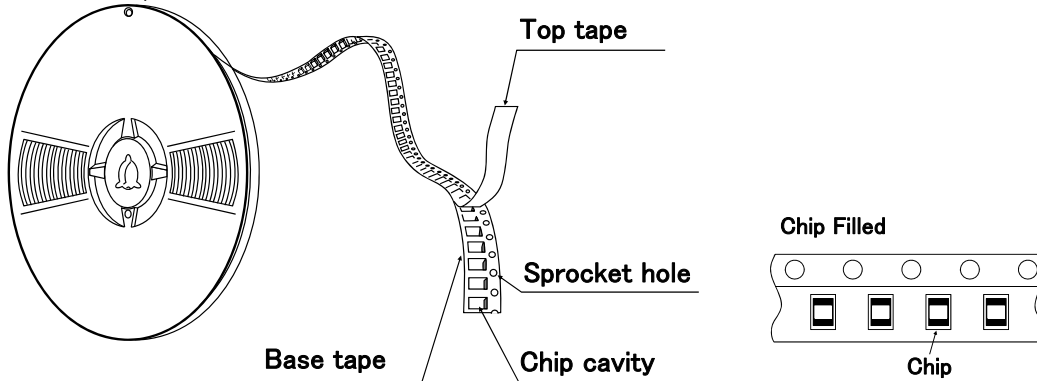

### ③ Taping Dimensions

#### ● Paper tape (0.315 inches wide)

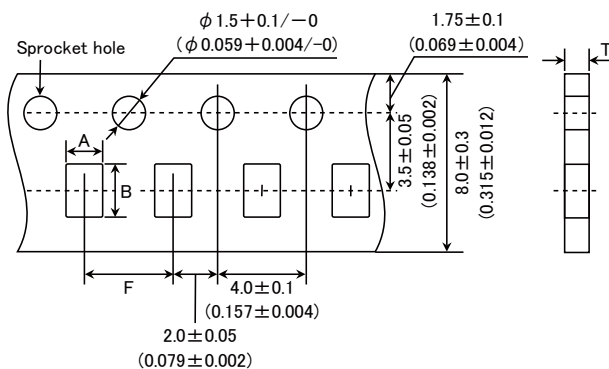

▶ This catalog contains the typical specification only due to the limitation of space. When you consider the purchase of our products, please check our specification. For details of each product (characteristics graph, reliability information, precautions for use, and so on), see our Web site (<http://www.ty-top.com/>).

Type	Chip Cavity		Insertion Pitch	Tape Thickness
	A	B	F	T
FB MJ1608 FB MH1608 FB TH1608 (0603)	1.0±0.2 (0.039±0.008)	1.8±0.2 (0.071±0.008)	4.0±0.2 (0.157±0.008)	1.1max (0.043max)
FB MJ2125 FB MH2012 (0805)	1.5±0.2 (0.059±0.008)	2.3±0.2 (0.091±0.008)	4.0±0.2 (0.157±0.008)	1.1max (0.043max)

Unit : mm (inch)

● Embossed tape (0.315 inches wide)

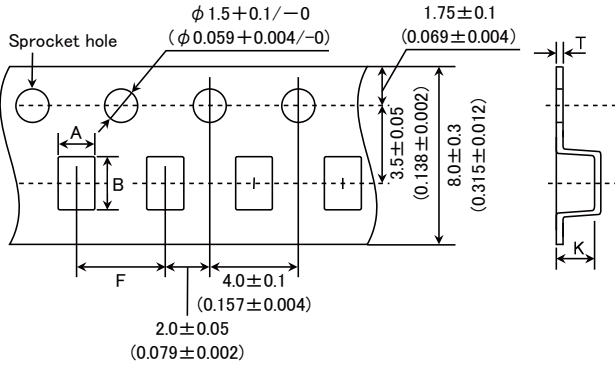

Type	Chip Cavity		Insertion Pitch	Tape Thickness	
	A	B	F	K	T
FB MH2016 (0806)	1.8±0.2 (0.071±0.008)	2.2±0.2 (0.087±0.008)	4.0±0.2 (0.157±0.008)	2.6max (0.102max)	0.6max (0.024max)
FB MJ3216 (1206)	1.9±0.2 (0.075±0.008)	3.5±0.2 (0.138±0.008)	4.0±0.2 (0.157±0.008)	1.5max (0.059max)	0.3max (0.012max)
FB MH3216 (1206)	1.9±0.2 (0.075±0.008)	3.5±0.2 (0.138±0.008)	4.0±0.2 (0.157±0.008)	2.6max (0.102max)	0.6max (0.024max)
FB MH3225 (1210)	2.8±0.2 (0.110±0.008)	3.5±0.2 (0.138±0.008)	4.0±0.2 (0.157±0.008)	4.0max (0.157max)	0.6max (0.024max)

Unit : mm (inch)

● Embossed tape (0.472 inches wide)

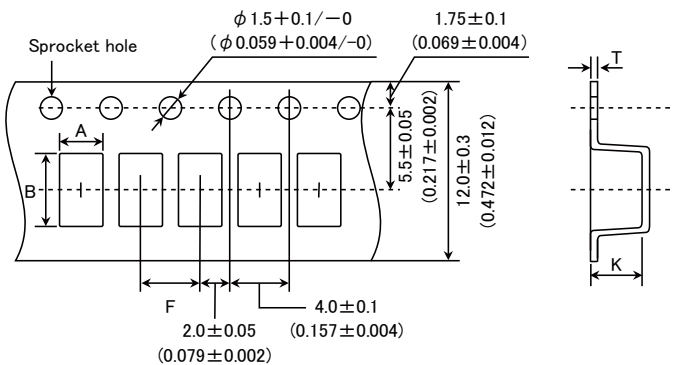

Type	Chip Cavity		Insertion Pitch	Tape Thickness	
	A	B	F	K	T
FB MJ4516 (1806)	1.9±0.2 (0.075±0.008)	4.9±0.2 (0.193±0.008)	4.0±0.2 (0.157±0.008)	1.5max (0.059max)	0.3max (0.012max)
FB MH4516 (1806)	1.9±0.2 (0.075±0.008)	4.9±0.2 (0.193±0.008)	4.0±0.2 (0.157±0.008)	2.6max (0.102max)	0.6max (0.024max)
FB MH4525 (1810)	2.9±0.2 (0.114±0.008)	4.9±0.2 (0.193±0.008)	4.0±0.2 (0.157±0.008)	4.0max (0.157max)	0.6max (0.024max)
FB MH4532 (1812)	3.6±0.2 (0.142±0.008)	4.9±0.2 (0.193±0.008)	8.0±0.2 (0.315±0.008)	4.0max (0.157max)	0.6max (0.024max)

Unit : mm (inch)

▶ This catalog contains the typical specification only due to the limitation of space. When you consider the purchase of our products, please check our specification. For details of each product (characteristics graph, reliability information, precautions for use, and so on), see our Web site (<http://www.ty-top.com/>).

#### ④ Leader and Blank portion

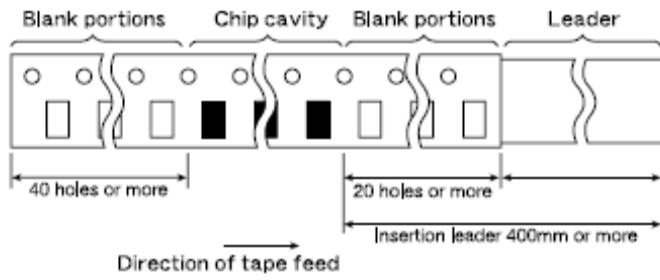

#### ⑤ Reel size

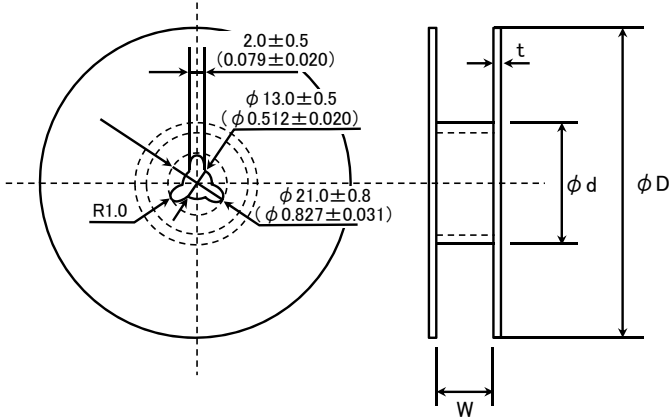

Type	$\phi D$	$\phi d$	W	t
FB MJ1608	180+0/-3 (7.09+0/-0.118 )	60+1/-0 (2.36+0.039/-0 )	10.0±1.5 (0.394±0.059)	2.5max (0.098max)
FB MJ2125			14.0±1.5 (0.551±0.059)	
FB MJ3216				
FB MJ4516			10.0±1.5 (0.394±0.059)	
FB MH1608				
FB MH2012			14.0±1.5 (0.551±0.059)	
FB MH2016				
FB MH3216				
FB MH3225				
FB MH4516				
FB MH4525	330±2.0 (12.99±0.080)	100±1.0 (3.94±0.039)	14.0±2.0 (0.551±0.080)	3.0max (1.181max)
FB MH4532				
FB TH1608	180+0/-3 (7.09+0/-0.118 )	60+1/-0 (2.36+0.039/-0 )	10.0±1.5 (0.394±0.059)	2.5max (0.098max)

Unit : mm (inch)

#### ⑥ Top tape strength

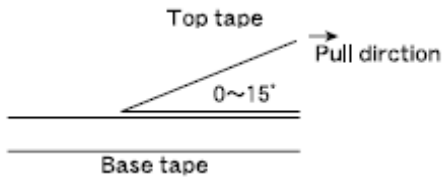

The top tape requires a peel-off force of 0.1 to 0.7N in the direction of the arrow as illustrated below.



# CHIP BEAD INDUCTORS FOR POWER LINE (FB SERIES M TYPE / T TYPE)

## RELIABILITY DATA

1. Operating Temperature Range	
Specified Value	-40°C ~ +125°C (Including self-generated heat)
Test Methods and Remarks	Including self-generated heat
2. Storage Temperature Range	
Specified Value	-40°C ~ +85°C
Test Methods and Remarks	*Note: -5 to +40°C in taped packaging
3. Impedance	
Specified Value	Within the specified tolerance
Test Methods and Remarks	Measuring equipment : Impedance analyzer (HP4291A) or its equivalent Measuring frequency : 100±1 MHz
4. DC Resistance	
Specified Value	Within the specified range
Test Methods and Remarks	Four-terminal method Measuring equipment : Milliohm High-Tester 3226 (Hioki Denki) or its equivalent
5. Rated Current	
Specified Value	Within the specified range
6. Vibration	
Specified Value	Appearance : No significant abnormality Impedance change : Within ±30% of the initial value
Test Methods and Remarks	According to JIS C 0040. Vibration type : A Time : 2 hrs each in X,Y, and Z directions Total: 6 hrs Frequency range : 10 to 55 to 10Hz (/min.) Amplitude : 1.5 mm (shall not exceed acceleration 196m/s <sup>2</sup> ) Mounting method : Soldering onto PC board
7. Solderability	
Specified Value	90% or more of immersed surface of terminal electrode shall be covered with fresh solder.
Test Methods and Remarks	Solder temperature : 230±5°C Immersion time : 4±1 sec. Preconditioning : Immersion into flux. Immersion and Removal speed : 25mm/sec.
8. Resistance to Soldering Heat	
Specified Value	Appearance : No significant abnormality Impedance change : Within ±30% of the initial value
Test Methods and Remarks	Preheating : 150°C for 3 min. Resistance to Soldering Heat : 260±5°C Duration : 10±0.5 sec. Preconditioning : Immersion into flux. Immersion and Removal speed : 25mm/sec. Recovery : 2 to 3 hrs of recovery under the standard condition after the test.

▶ This catalog contains the typical specification only due to the limitation of space. When you consider the purchase of our products, please check our specification. For details of each product (characteristics graph, reliability information, precautions for use, and so on), see our Web site (<http://www.ty-top.com/>).

### 9. Thermal Shock

Specified Value	Appearance : No significant abnormality Impedance change : Within +50/−10% of the initial value															
Test Methods and Remarks	<p>According to JIS C 0025. Conditions for 1 cycle</p> <table border="1"> <thead> <tr> <th>Step</th> <th>Temperature (°C)</th> <th>Duration (min.)</th> </tr> </thead> <tbody> <tr> <td>1</td> <td>−40±3°C</td> <td>30±3</td> </tr> <tr> <td>2</td> <td>Room Temperature</td> <td>Within 3</td> </tr> <tr> <td>3</td> <td>85±2°C</td> <td>30±3</td> </tr> <tr> <td>4</td> <td>Room Temperature</td> <td>Within 3</td> </tr> </tbody> </table> <p>Number of cycles : 100 Mounting method : Soldering onto PC board Recovery : 2 to 3 hrs of recovery under the standard condition after the removal from test chamber.</p>	Step	Temperature (°C)	Duration (min.)	1	−40±3°C	30±3	2	Room Temperature	Within 3	3	85±2°C	30±3	4	Room Temperature	Within 3
Step	Temperature (°C)	Duration (min.)														
1	−40±3°C	30±3														
2	Room Temperature	Within 3														
3	85±2°C	30±3														
4	Room Temperature	Within 3														

### 10. Resistance to Humidity (steady state)

Specified Value	Appearances : No significant abnormality Impedance change : Within ±30% of the initial value
Test Methods and Remarks	<p>Temperature : 40±2°C Humidity : 90 to 95% RH Duration : 500+24/−0 Mounting method : Soldering onto PC board Recovery : 2 to 3 hrs of recovery under the standard condition after the removal from test chamber.</p>

### 11. Loading under Damp Heat

Specified Value	Appearance : No significant abnormality Impedance change : Within ±30% of the initial value
Test Methods and Remarks	<p>Temperature : 40±2°C Humidity : 90 to 95%RH Applied current : Rated current Duration : 500+24/−0 hrs Mounting method : Soldering onto PC board Recovery : 2 to 3hrs of recovery under the standard condition after the removal from test chamber.</p>

### 12. High Temperature Loading Test

Specified Value	Appearance : No significant abnormality Impedance change : Within ±30% of the initial value
Test Methods and Remarks	<p>Temperature : 85±2°C Duration : 500+24/−0 hrs Applied current : Rated current Mounting method : Soldering onto PC board Recovery : 2 to 3 hrs of recovery under the standard condition after the removal from test chamber.</p>

### 13. Bending Strength

Specified Value	Appearance : No mechanical damage.
Test Methods and Remarks	<p>Warp : 2mm Testing board : Glass epoxy-resin substrate Thickness : 0.8mm</p> <p>(Unit: mm)</p>

► This catalog contains the typical specification only due to the limitation of space. When you consider the purchase of our products, please check our specification.  
For details of each product (characteristics graph, reliability information, precautions for use, and so on), see our Web site (<http://www.ty-top.com/>).

#### 14. Adhesion of Electrode

Specified Value No separation or indication of separation of electrode.

Test Methods and Remarks

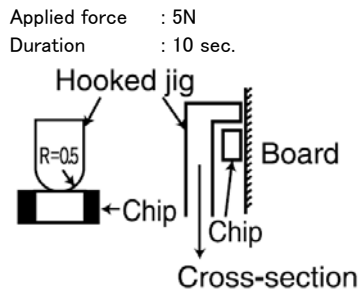

Note on standard condition: "standard condition" referred to herein is defined as follows:  
5 to 35°C of temperature, 45 to 85% relative humidity and 86 to 106kPa of air pressure.

When there are questions concerning measurement results:

In order to provide correlation data, the test shall be conducted under condition of  $20 \pm 2^\circ\text{C}$  of temperature, 60 to 70% relative humidity and 86 to 106kPa of air pressure. Unless otherwise specified, all the tests are conducted under the "standard condition."

# CHIP BEAD INDUCTORS FOR POWER LINE (FB SERIES M TYPE / T TYPE)

## PRECAUTIONS

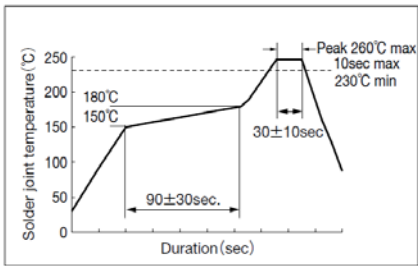
1. Circuit Design	
Precautions	<ul style="list-style-type: none"> <li>◆ Operating environment                             <ol style="list-style-type: none"> <li>1. The products listed in this catalogue are intended for use in general electronic equipment (e.g., AV equipment, OA equipment, home electric appliances, office equipment, information and communication equipment), general medical equipment, industrial equipment, and automotive interior applications, etc.</li> </ol> <p>Please be sure to contact TAIYO YUDEN for further information before using the products for any equipment which may directly cause loss of human life or bodily injury (e.g., specially controlled medical equipment, transportation equipment including, without limitation, automotive powertrain control system, train control system, and ship control system, traffic signal equipment).</p> <p>Please do not incorporate our products into any equipment requiring high levels of safety and/or reliability (e.g., aerospace equipment, aviation equipment, nuclear control equipment, undersea equipment, military equipment, etc.).</p></li> </ul> <ul style="list-style-type: none"> <li>◆ Rated current                             <ol style="list-style-type: none"> <li>1. Rated current of this product is shown in this catalogue, but please be sure to have the base board designed with adequate inspection in case of the generation of heat becomes high within the rated current range when the base board is in high resistance or in bad heating conditions.</li> </ol> </li> </ul>
2. PCB Design	
Precautions	<ul style="list-style-type: none"> <li>◆ Land pattern design                             <ol style="list-style-type: none"> <li>1. Please refer to a recommended land pattern.</li> </ol> </li> </ul>
3. Considerations for automatic placement	
Precautions	<ul style="list-style-type: none"> <li>◆ Adjustment of mounting machine                             <ol style="list-style-type: none"> <li>1. Excessive impact load should not be imposed on the products when mounting onto the PC boards.</li> <li>2. Mounting and soldering conditions should be checked beforehand.</li> </ol> </li> </ul>
Technical considerations	<ul style="list-style-type: none"> <li>◆ Adjustment of mounting machine                             <ol style="list-style-type: none"> <li>1. When installing products, care should be taken not to apply distortion stress as it may deform the products.</li> </ol> </li> </ul>
4. Soldering	
Precautions	<ul style="list-style-type: none"> <li>◆ Wave soldering                             <ol style="list-style-type: none"> <li>1. Please refer to the specifications in the catalog for a wave soldering.</li> </ol> </li> <li>◆ Reflow soldering                             <ol style="list-style-type: none"> <li>1. Please contact any of our offices for a reflow soldering, and refer to the recommended condition specified.</li> </ol> </li> <li>◆ Lead free soldering                             <ol style="list-style-type: none"> <li>1. When using products with lead free soldering, we request to use them after confirming adhesion, temperature of resistance to soldering heat, etc. sufficiently.</li> </ol> </li> <li>◆ Preheating when soldering                             <p>Heating : The temperature difference between soldering and remaining heat should not be greater than 150°C.</p> <p>Cooling : The temperature difference between the components and cleaning process should not be greater than 100°C.</p> </li> <li>◆ Recommended conditions for using a soldering iron                             <p>Put the soldering iron on the land-pattern.</p> <p>Soldering iron's temperature – Below 350°C</p> <p>Duration – 3 seconds or less</p> <p>The soldering iron should not directly touch the inductor.</p> </li> </ul>
Technical considerations	<ul style="list-style-type: none"> <li>◆ Wave, Reflow, Lead free soldering                             <ol style="list-style-type: none"> <li>1. If products are used beyond the range of the recommended conditions, heat stresses may deform the products, and consequently degrade the reliability of the products.</li> </ol> <p><b>【Recommended reflow condition】</b></p>  </li> <li>◆ Preheating when soldering                             <ol style="list-style-type: none"> <li>1. There is a case that products get damaged by a heat shock.</li> </ol> </li> <li>◆ Recommended conditions for using a soldering iron                             <ol style="list-style-type: none"> <li>1. If products are used beyond the range of the recommended conditions, heat stresses may deform the products, and consequently degrade the reliability of the products.</li> </ol> </li> </ul>

▶ This catalog contains the typical specification only due to the limitation of space. When you consider the purchase of our products, please check our specification. For details of each product (characteristics graph, reliability information, precautions for use, and so on), see our Web site (<http://www.ty-top.com/>).

5. Handling	
Precautions	<ul style="list-style-type: none"> <li>◆ Handling               <ol style="list-style-type: none"> <li>1. Keep the inductors away from all magnets and magnetic objects.</li> </ol> </li> <li>◆ Setting PC boards               <ol style="list-style-type: none"> <li>1. When setting a chip mounted base board, please make sure that there is no residual stress to the chip by distortion in the board or at screw part.</li> </ol> </li> <li>◆ Breakaway PC boards (splitting along perforations)               <ol style="list-style-type: none"> <li>1. When splitting the PC board after mounting inductors, care should be taken not to give any stresses of deflection or twisting to the board.</li> <li>2. Board separation should not be done manually, but by using the appropriate devices.</li> </ol> </li> <li>◆ Mechanical considerations               <ol style="list-style-type: none"> <li>1. Please do not give the inductors any excessive mechanical shocks.</li> </ol> </li> </ul>
Technical considerations	<ul style="list-style-type: none"> <li>◆ Handling               <ol style="list-style-type: none"> <li>1. There is a case that a characteristic varies with magnetic influence.</li> </ol> </li> <li>◆ Setting PC boards               <ol style="list-style-type: none"> <li>1. There is a case that a characteristic varies with residual stress.</li> </ol> </li> <li>◆ Breakaway PC boards (splitting along perforations)               <ol style="list-style-type: none"> <li>1. Planning pattern configurations and the position of products should be carefully performed to minimize stress.</li> </ol> </li> <li>◆ Mechanical considerations               <ol style="list-style-type: none"> <li>1. There is a case to be damaged by a mechanical shock.</li> </ol> </li> </ul>
6. Storage conditions	
Precautions	<ul style="list-style-type: none"> <li>◆ Storage               <ol style="list-style-type: none"> <li>1. To maintain the solderability of terminal electrodes and to keep the packing material in good condition, temperature and humidity in the storage area should be controlled.                   <ul style="list-style-type: none"> <li>• Recommended conditions</li> <li>  Ambient temperature -5~40°C</li> <li>  Humidity Below 70% RH</li> </ul> </li> </ol> <p>The ambient temperature must be kept below 30°C. Even under ideal storage conditions, solderability of products electrodes may decrease as time passes.</p> <p>For this reason, inductors should be used within 6 months from the time of delivery.</p> </li> </ul>
Technical considerations	<ul style="list-style-type: none"> <li>◆ Storage               <ol style="list-style-type: none"> <li>1. Under a high temperature and humidity environment, problems such as reduced solderability caused by oxidation of terminal electrodes and deterioration of taping/packaging materials may take place.</li> </ol> </li> </ul>