

UPGRADE

Metallized Polypropylene Film Capacitor (For Automotive)

ECWFG series

Non-inductive construction using metallized polypropylene film with flame retardant plastic case.



Features

- High safety (with safety function)
- High moisture resistance (85°C, 85%)
 - 600 V : 420 V, 500 h
 - 630 V : 500 V, 1000 h
 - 700 V : 500 V, 1000 h
 - 800 V : 560 V, 500 h
 - 1100 V : 700 V, 500 h (C < 2.0 μF) / 770 V, 500 h (C ≥ 2.0 μF)
- High thermal shock resistance (600 to 1100 V : -55°C ⇔ 85°C, 1000 cycles)
- High temperature load test (125°C)
 - 600 V : 360 V, 1000 h
 - 630 V : 450 V, 1000 h
 - 700 V : 450 V, 1000 h
 - 800 V : 480 V, 1000 h
 - 1100 V : 660 V, 1000 h
- Flame-retardant plastic case and non-combustible resin
- AEC-Q200 compliant
- RoHS compliant

Recommended applications

- DC/DC, AC/DC converter circuit in xEV
- High frequency and high current circuits

Explanation of part number

■ Lead pitch : 22.5 mm

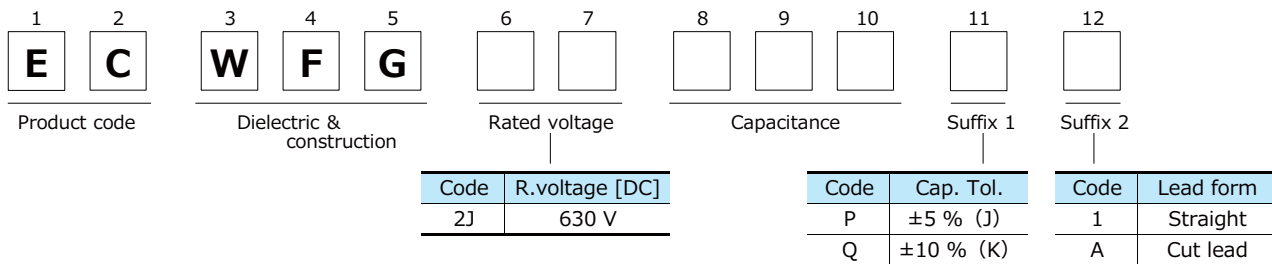

■ Lead pitch : 27.5 mm

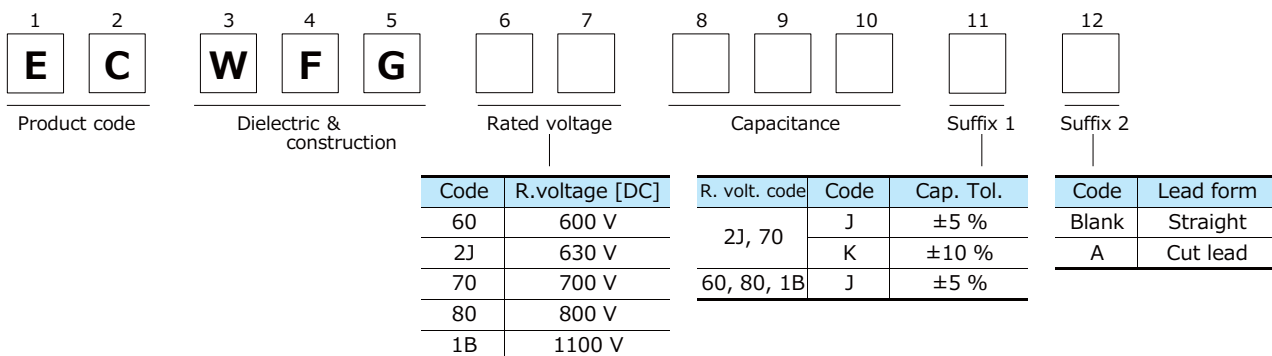

Specifications

Category temp. range (Including temperature-rise on unit surface)	-40 °C to +110 °C		
Rated voltage [DC]	600 V to 1100 V (Derating of rated voltage by 1.0 % / °C at more than 85 °C)		
Capacitance range	600 V	Lead pitch : 27.5 mm	2.0 μF to 12.0 μF
	630 V	Lead pitch : 22.5 mm	1.0 μF to 3.0 μF
		Lead pitch : 27.5 mm	1.0 μF to 4.7 μF
	700 V	Lead pitch : 27.5 mm	1.0 μF to 4.7 μF
	800 V	Lead pitch : 27.5 mm	2.0 μF to 8.0 μF
1100 V	Lead pitch : 27.5 mm	1.0 μF to 5.0 μF	
Capacitance tolerance	±5% (J), ±10 % (K)		
Dissipation factor (tan δ)	tan δ ≤ 0.1 % (20 °C, 1 kHz)		
Withstand voltage	Between terminals : Rated voltage (V) × 150 % 60 s		
Insulation resistance (IR)	IR ≥ 3,000 MΩ·μF (20 °C, 500 V [DC], 60 s)		

* In case of applying voltage in alternating current (50 Hz or 60 Hz sine wave) to a capacitor with DC rated voltage, please refer to the page of "Permissible voltage (R.M.S) in alternating current corresponding to DC rated voltage".

Dimensions

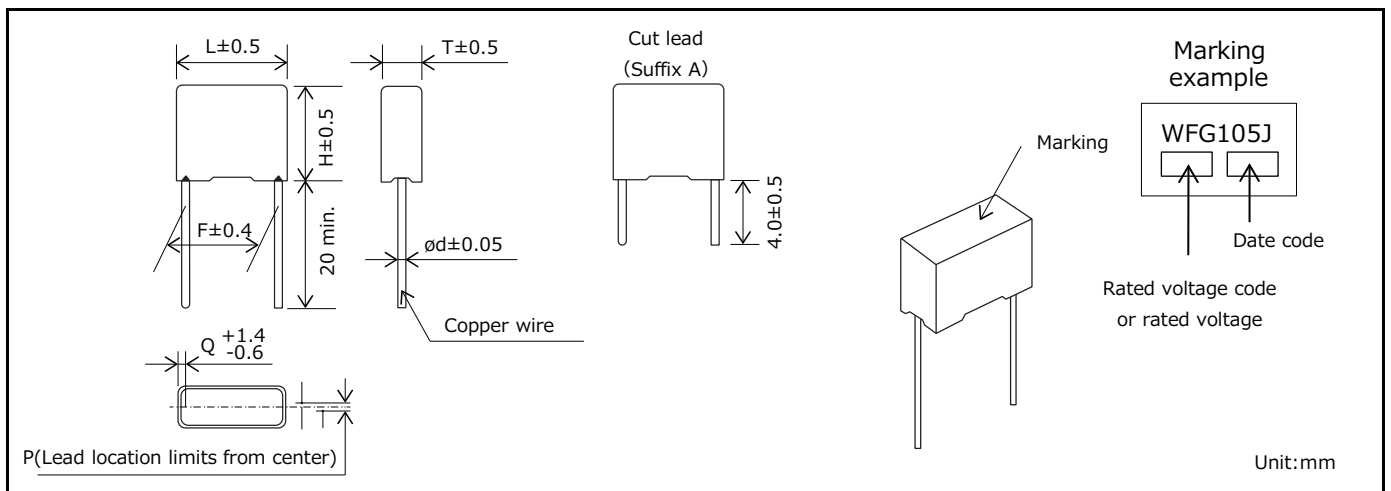

Rating · Dimensions · Quantity

■ Rated voltage [DC] : 600 V, Capacitance tolerance : ±5 % (J)

NEW Part No	Cap. (μF)	Dimensions (mm)							Min. order Q'ty (PCS)	
		L	T	H	F	ød	P	Q	Straight	Cut lead
ECWFG60205J()	2.0	31.5	8.0	17.0	27.5	0.8	0±1.0	2.0	400	400
ECWFG60225J()	2.2	31.5	8.0	17.0	27.5	0.8	0±1.0	2.0	400	400
ECWFG60275J()	2.7	31.5	9.5	18.0	27.5	0.8	0±1.0	2.0	400	350
ECWFG60305J()	3.0	31.5	9.5	18.0	27.5	0.8	0±1.0	2.0	400	350
ECWFG60335J()	3.3	31.5	9.5	18.0	27.5	0.8	0±1.0	2.0	400	350
ECWFG60355J()	3.5	31.5	9.5	18.0	27.5	0.8	0±1.0	2.0	400	350
ECWFG60395J()	3.9	31.5	10.5	21.0	27.5	0.8	0±1.0	2.0	300	300
ECWFG60405J()	4.0	31.5	10.5	21.0	27.5	0.8	0±1.0	2.0	300	300
ECWFG60475J()	4.7	31.5	12.0	24.5	27.5	0.8	0±1.0	2.0	200	250
ECWFG60505J()	5.0	31.5	12.0	24.5	27.5	0.8	0±1.0	2.0	200	250
ECWFG60565J()	5.6	31.5	12.0	24.5	27.5	0.8	0±1.0	2.0	200	250
ECWFG60605J()	6.0	31.5	12.0	24.5	27.5	0.8	0±1.0	2.0	200	250
ECWFG60685J()	6.8	31.5	12.0	24.5	27.5	0.8	0±1.0	2.0	200	250
ECWFG60705J()	7.0	31.5	13.5	28.5	27.5	0.8	0±1.0	2.0	150	150
ECWFG60755J()	7.5	31.5	13.5	28.5	27.5	0.8	0±1.0	2.0	150	150
ECWFG60805J()	8.0	31.5	13.5	28.5	27.5	0.8	0±1.0	2.0	150	150
ECWFG60825J()	8.2	31.5	13.5	28.5	27.5	0.8	0±1.0	2.0	150	150
ECWFG60905J()	9.0	31.5	13.5	28.5	27.5	0.8	0±1.0	2.0	150	150
ECWFG60106J()	10.0	31.5	13.5	28.5	27.5	0.8	0±1.0	2.0	150	150
ECWFG60126J()	12.0	31.5	17.5	32.5	27.5	0.8	0±1.0	2.0	150	100

* () : Suffix for lead crimped

Rating · Dimensions · Quantity

- Rated voltage [DC] : 630 V, Capacitance tolerance : $\pm 5\%$ (J), $\pm 10\%$ (K)
 [Lead pitch : 22.5 mm]

Part No	Cap. (μ F)	Dimensions (mm)							Min. order Q'ty (PCS)	
		L	T	H	F	ϕ d	P	Q	Straight	Cut lead
		ECWFG2J105P() ECWFG2J105Q()	1.0	27.0	10.5	19.0	22.5	1.0		
ECWFG2J155P() ECWFG2J155Q()	1.5	27.0	12.0	21.0	22.5	1.0	0 \pm 0.8	2.25	300	300
ECWFG2J225P() ECWFG2J225Q()	2.2	27.0	15.5	24.0	22.5	1.0	0 \pm 0.8	2.25	200	250
ECWFG2J305P() ECWFG2J305Q()	3.0	27.0	17.5	26.5	22.5	1.0	0 \pm 0.8	2.25	150	200

* () : Suffix for lead crimped

[Lead pitch : 27.5 mm]

Part No	Cap. (μ F)	Dimensions (mm)							Min. order Q'ty (PCS)	
		L	T	H	F	ϕ d	P	Q	Straight	Cut lead
		ECWFG2J105□() ECWFG2J155□()	1.0	31.5	9.5	18.0	27.5	1.0		
ECWFG2J225□() ECWFG2J305□()	2.2	31.5	12.0	24.5	27.5	1.0	0 \pm 0.8	2.0	200	250
ECWFG2J475□()	4.7	31.5	17.5	32.5	27.5	1.0	0 \pm 0.8	2.0	100	100

* □ : Capacitance tolerance code

* () : Suffix for lead crimped

- Rated voltage [DC] : 700 V, Capacitance tolerance : $\pm 5\%$ (J), $\pm 10\%$ (K)

Part No	Cap. (μ F)	Dimensions (mm)							Min. order Q'ty (PCS)	
		L	T	H	F	ϕ d	P	Q	Straight	Cut lead
		ECWFG70105□() ECWFG70155□()	1.0	31.5	9.5	18.0	27.5	1.0		
ECWFG70205□() ECWFG70225□()	2.0	31.5	12.0	24.5	27.5	1.0	0 \pm 0.8	2.0	200	250
ECWFG70305□() ECWFG70395□()	3.0	31.5	13.5	28.5	27.5	1.0	0 \pm 0.8	2.0	150	150
ECWFG70475□()	4.7	31.5	17.5	32.5	27.5	1.0	0 \pm 0.8	2.0	100	100

* □ : Capacitance tolerance code

* () : Suffix for lead crimped

- Rated voltage [DC] : 800 V, Capacitance tolerance : $\pm 5\%$ (J)

Part No	Cap. (μ F)	Dimensions (mm)							Min. order Q'ty (PCS)	
		L	T	H	F	ϕ d	P	Q	Straight	Cut lead
		ECWFG80205J() ECWFG80225J()	2.0	31.5	10.5	21.0	27.5	0.8		
ECWFG80275J() ECWFG80305J()	2.7	31.5	12.0	24.5	27.5	0.8	0 \pm 1.0	2.0	200	250
ECWFG80335J() ECWFG80355J()	3.3	31.5	12.0	24.5	27.5	0.8	0 \pm 1.0	2.0	200	250
ECWFG80395J() ECWFG80405J()	3.9	31.5	13.5	28.5	27.5	0.8	0 \pm 1.0	2.0	150	150
ECWFG80475J() ECWFG80505J()	4.7	31.5	13.5	28.5	27.5	0.8	0 \pm 1.0	2.0	150	150
ECWFG80565J() ECWFG80605J()	5.6	31.5	16.0	29.5	27.5	0.8	0 \pm 1.0	2.0	150	100
ECWFG80685J() ECWFG80705J()	6.0	31.5	16.0	29.5	27.5	0.8	0 \pm 1.0	2.0	150	100
ECWFG80755J() ECWFG80805J()	7.0	31.5	17.5	32.5	27.5	0.8	0 \pm 1.0	2.0	150	100
	7.5	31.5	17.5	32.5	27.5	0.8	0 \pm 1.0	2.0	150	100
	8.0	31.5	17.5	32.5	27.5	0.8	0 \pm 1.0	2.0	150	100

* () : Suffix for lead crimped

Rating · Dimensions · Quantity

■ Rated voltage [DC] : 1100 V, Capacitance tolerance : $\pm 5\%$ (J)

Part No	Cap. (μ F)	Dimensions (mm)							Min. order Q'ty (PCS)	
		L	T	H	F	ϕ d	P	Q	Straight	Cut lead
ECWFG1B105J()	1.0	31.5	10.5	21.0	27.5	0.8	0 \pm 1.0	2.0	300	300
ECWFG1B155J()	1.5	31.5	12.0	24.5	27.5	0.8	0 \pm 1.0	2.0	200	250
ECWFG1B205J()	2.0	31.5	12.0	24.5	27.5	0.8	0 \pm 1.0	2.0		
ECWFG1B225J()	2.2	31.5	13.5	28.5	27.5	0.8	0 \pm 1.0	2.0	150	150
ECWFG1B305J()	3.0	31.5	16.0	29.5	27.5	0.8	0 \pm 1.0	2.0		
ECWFG1B335J()	3.3	31.5	16.0	29.5	27.5	0.8	0 \pm 1.0	2.0		
ECWFG1B405J()	4.0	31.5	17.5	32.5	27.5	0.8	0 \pm 1.0	2.0	100	100
ECWFG1B475J()	4.7	31.5	18.5	35.0	27.5	0.8	0 \pm 1.0	2.0		
ECWFG1B505J()	5.0	31.5	18.5	35.0	27.5	0.8	0 \pm 1.0	2.0		

* () : Suffix for lead crimped

Characteristics data

■ **Rated voltage [DC] : 600 V**

Electrical characteristics <Typical data >

Temperature characteristics

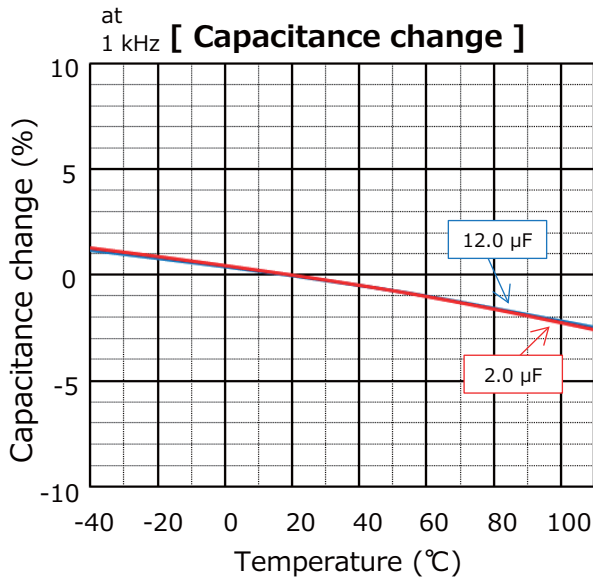

Frequency characteristics

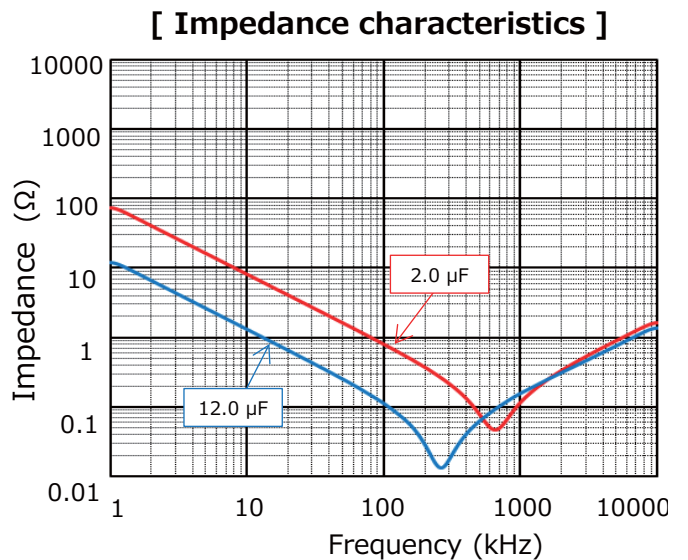
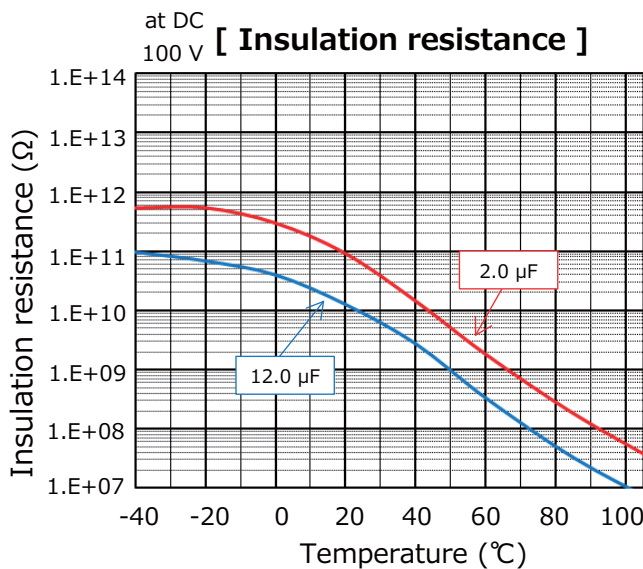
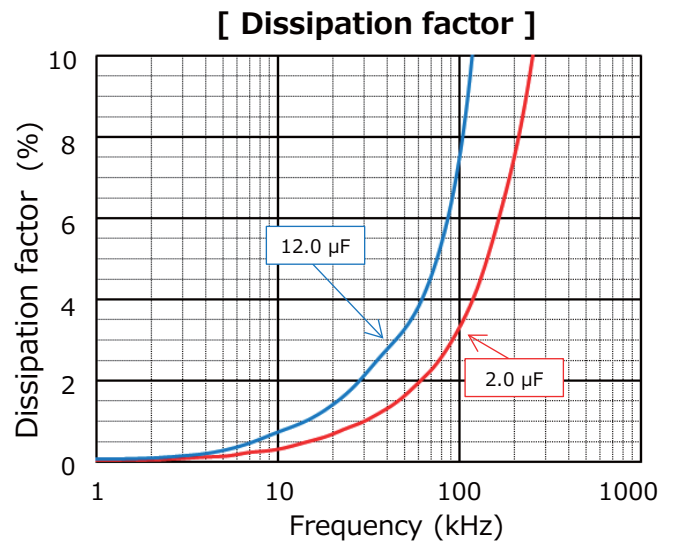
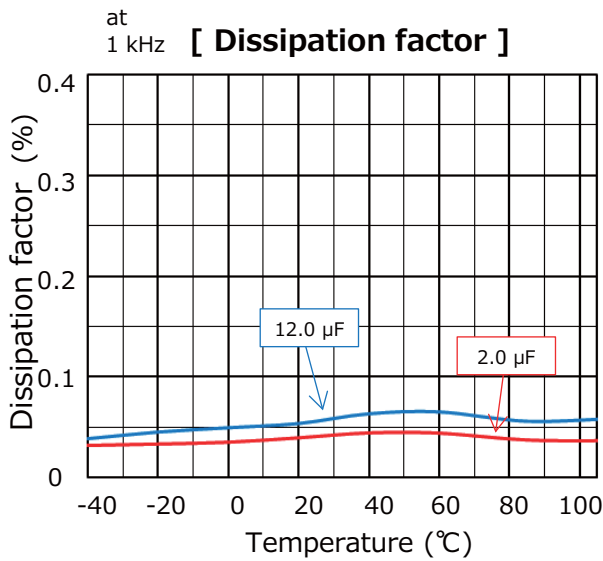
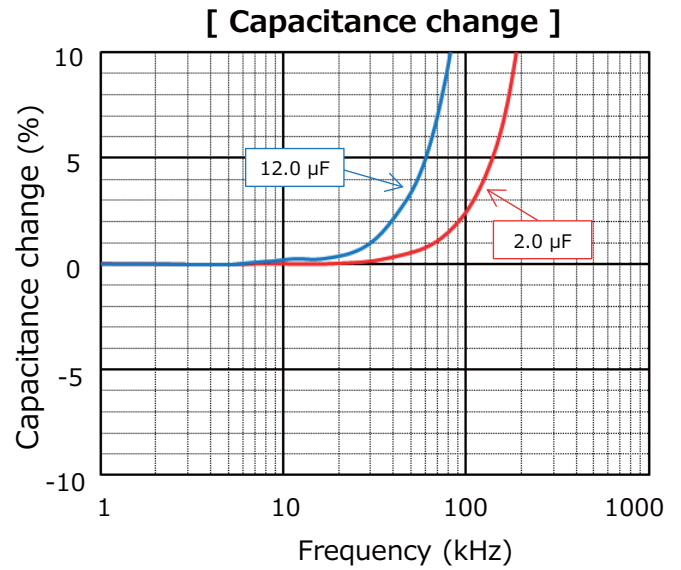

Characteristics data

■ **Rated voltage [DC] : 600 V**

Applicable specifications

[Permissible Current]

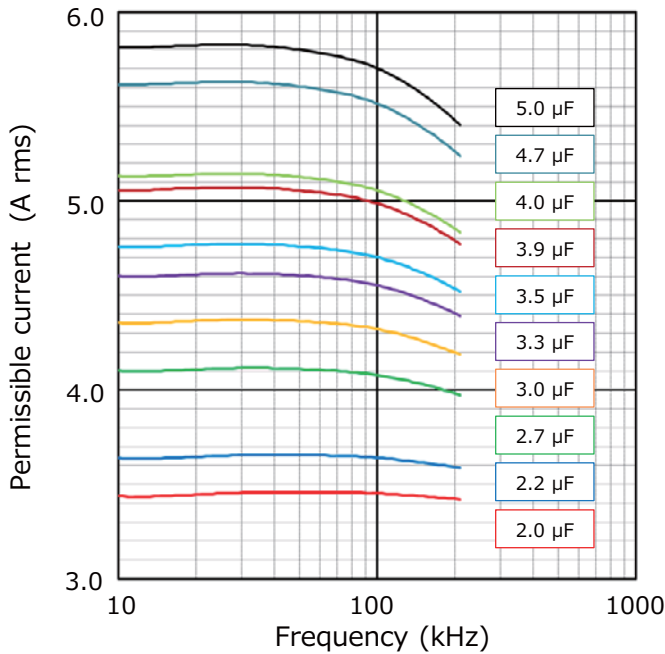

[Permissible Current Derating by Temperature]

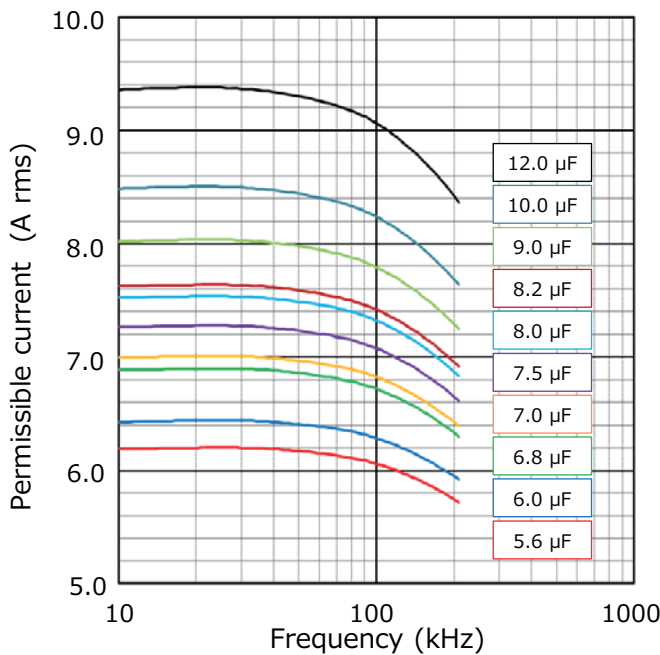
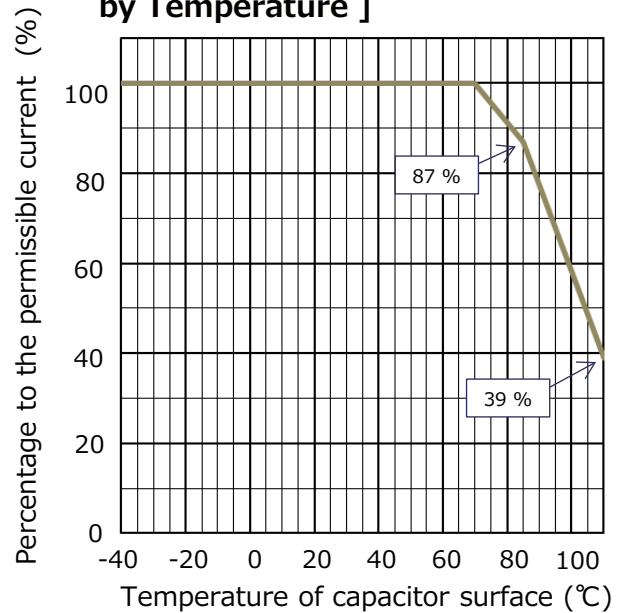

[Voltage Derating by Temperature]

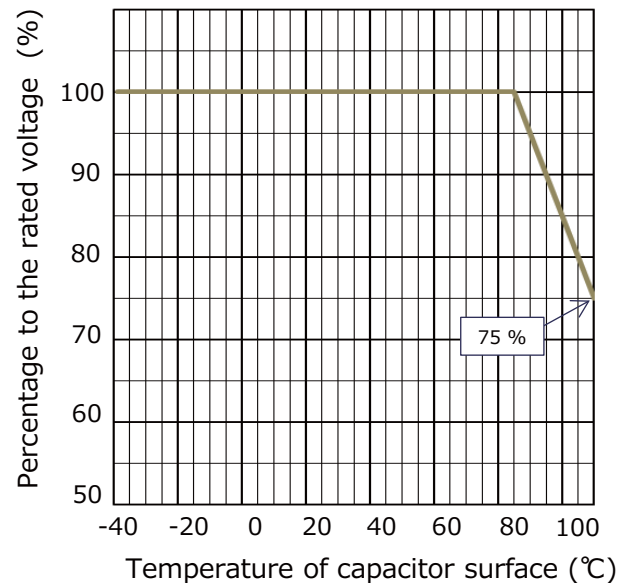

Permissible pulse current (dV/dt) (Max. 10000 cycles)

R. voltage [DC] (V)	Capacitance (µF)	Code	dV/dt (V/µs)	Current (Ao-p)
600	2.0	205	40	80
	2.2	225		88
	2.7	275		108
	3.0	305		120
	3.3	335		132
	3.5	355		140
	3.9	395		156
	4.0	405		160
	4.7	475		188
	5.0	505		200

R. voltage [DC] (V)	Capacitance (µF)	Code	dV/dt (V/µs)	Current (Ao-p)
600	5.6	565	40	224
	6.0	605		240
	6.8	685		272
	7.0	705		280
	7.5	755		300
	8.0	805		320
	8.2	825		328
	9.0	905		360
	10.0	106		400
	12.0	126		480

Characteristics data

■ Rated voltage [DC] : 630 V

Electrical characteristics <Typical data >

Temperature characteristics

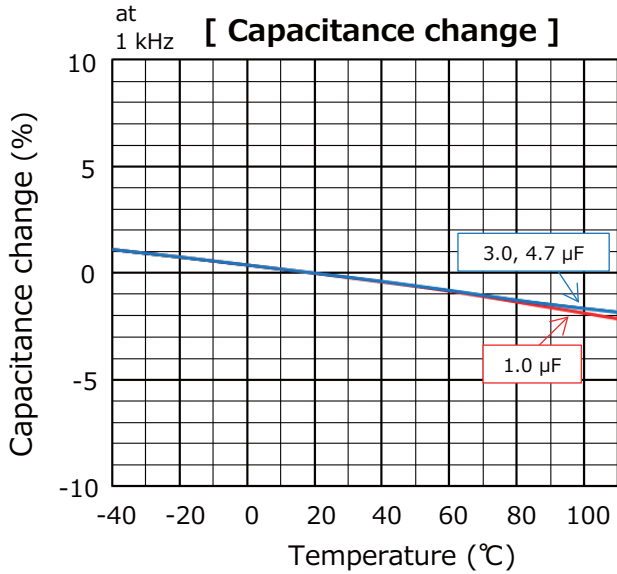

Frequency characteristics

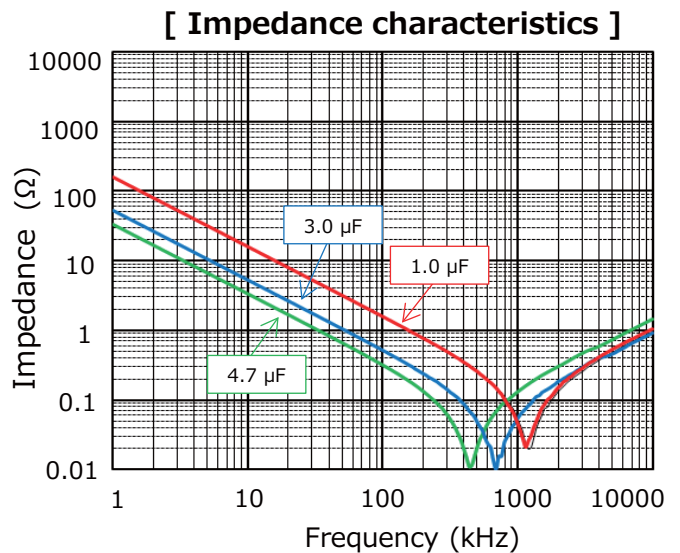
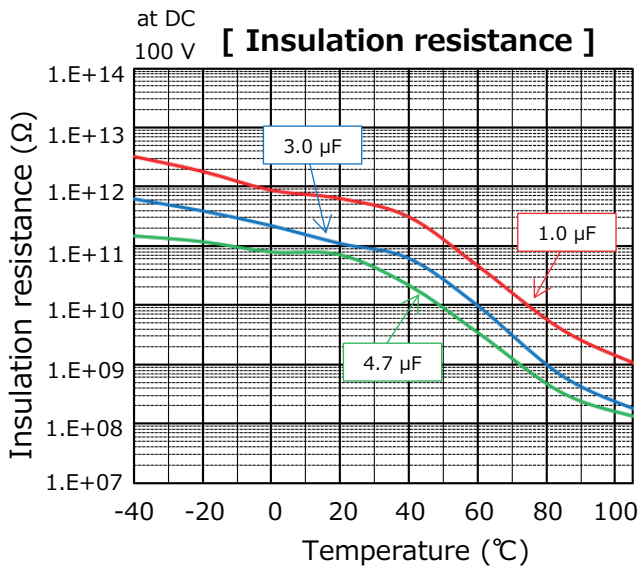
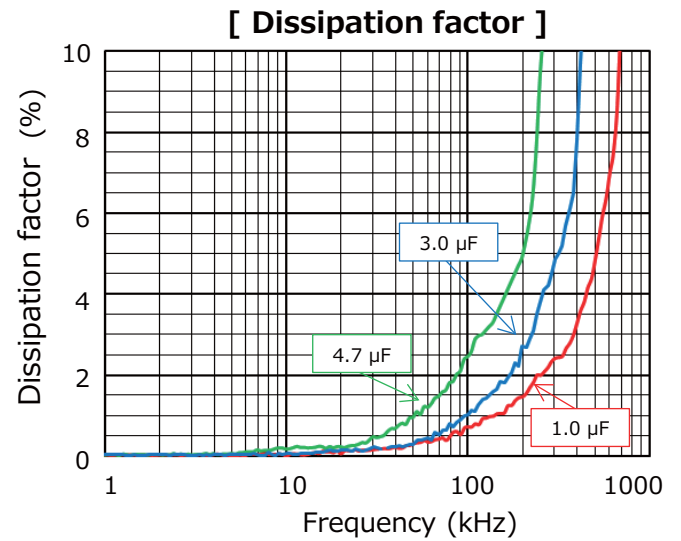
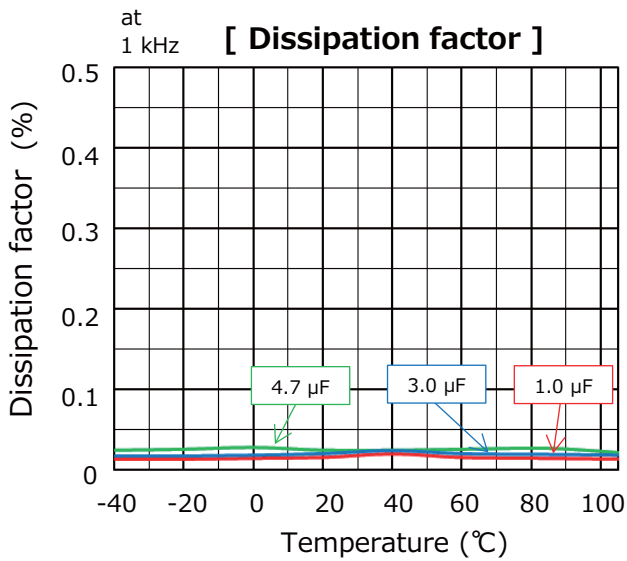
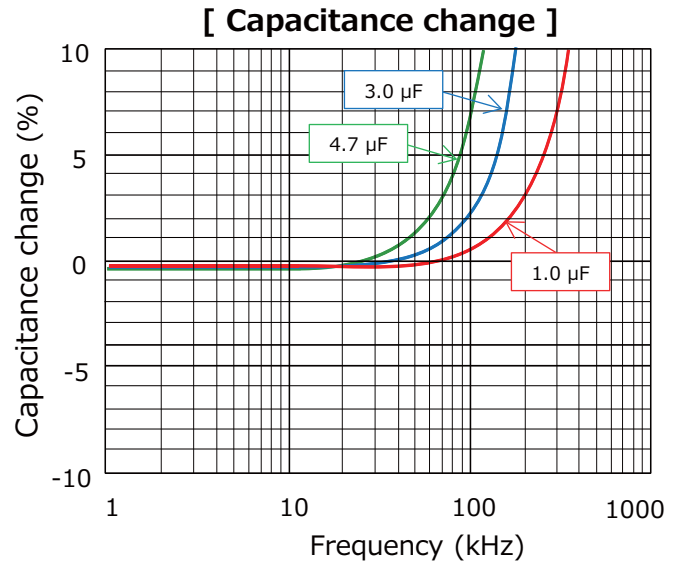

Characteristics data

■ Rated voltage [DC] : 630 V

Applicable specifications

[Permissible Current]

Lead pitch 22.5 mm

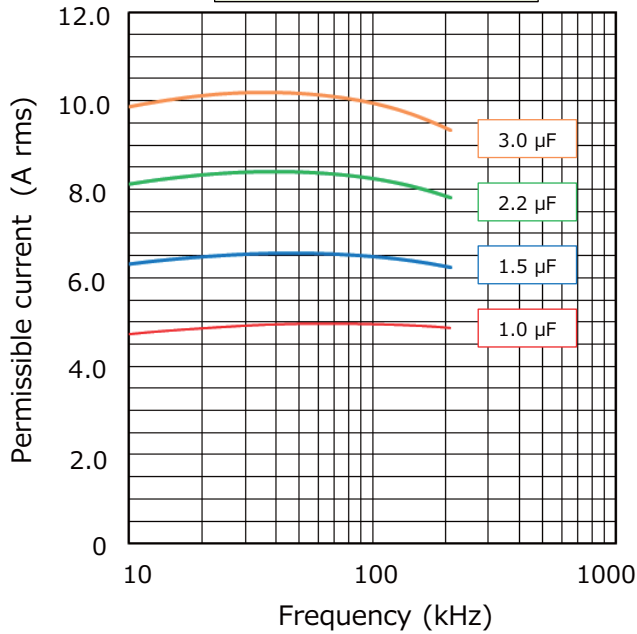

[Permissible Current Derating by Temperature]

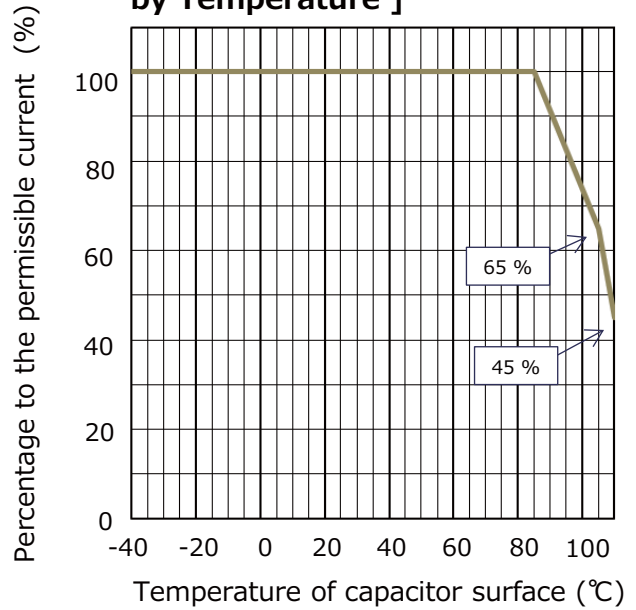

[Permissible Current]

Lead pitch 27.5 mm

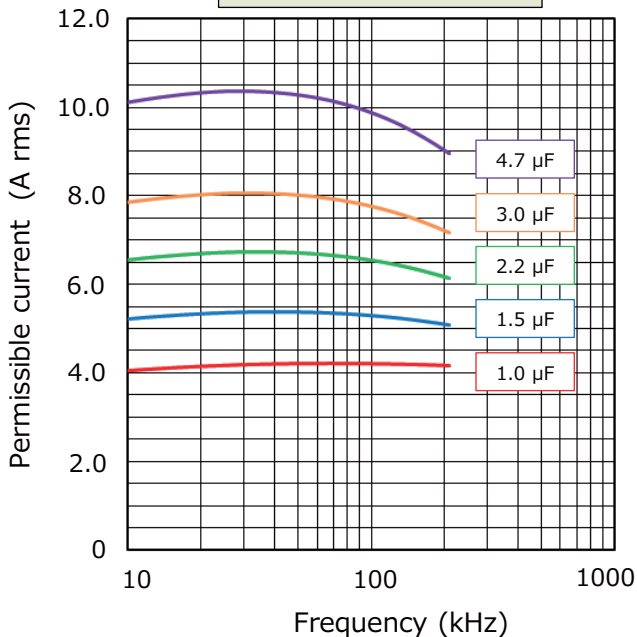

[Voltage Derating by Temperature]

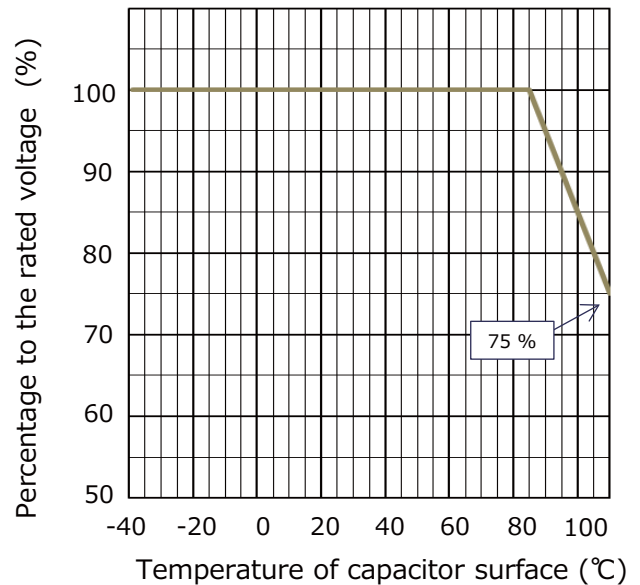

Permissible pulse current (dV/dt)
(Max. 10000 cycles)

R. voltage [DC] (V)	Pitch (mm)	Capacitance (μF)	Code	dV/dt (V/μs)	Current (Ao-p)
630	22.5	1.0	105	65	65.0
		1.5	155		97.5
		2.2	225		143.0
		3.0	305		195.0
	27.5	1.0	105	50	50.0
		1.5	155		75.0
		2.2	225		110.0
		3.0	305		150.0
		4.7	475		235.0

Characteristics data

■ Rated voltage [DC] : 700 V

Electrical characteristics <Typical data >

Temperature characteristics

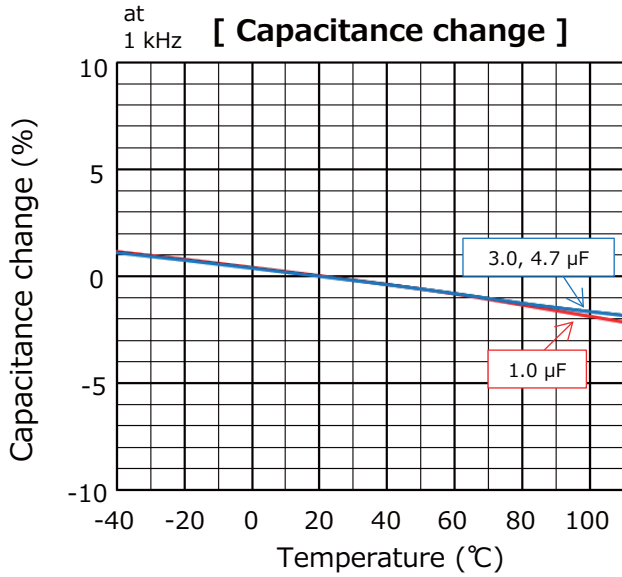

Frequency characteristics

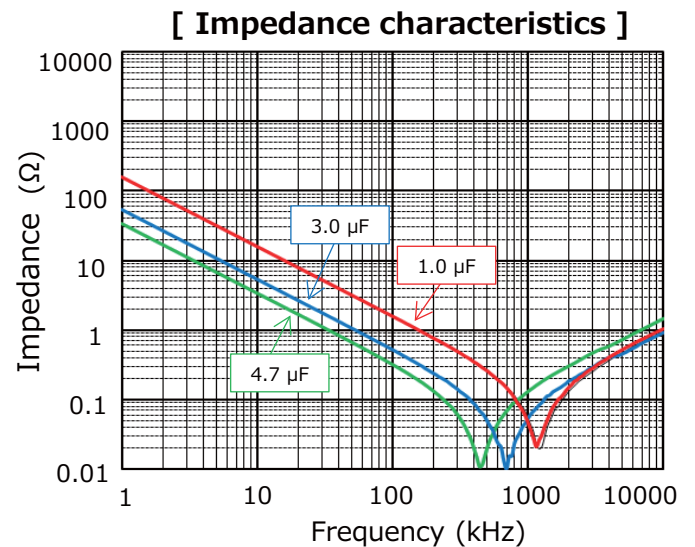
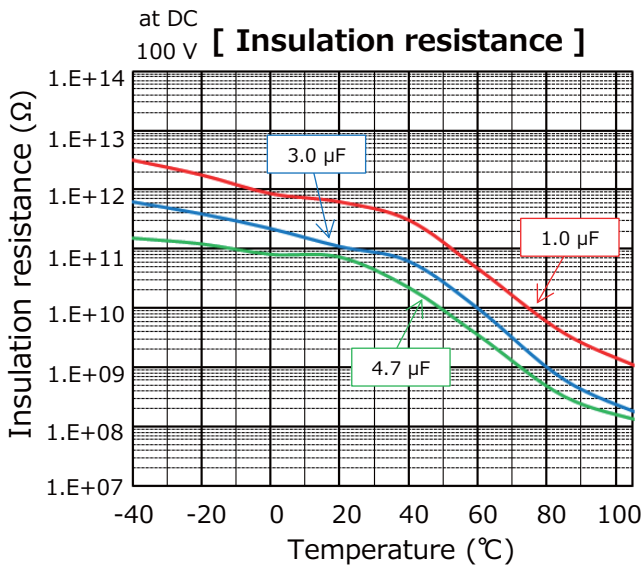
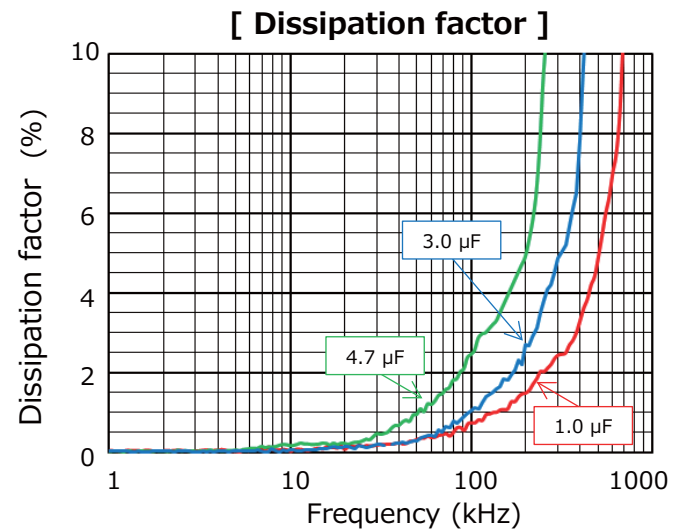
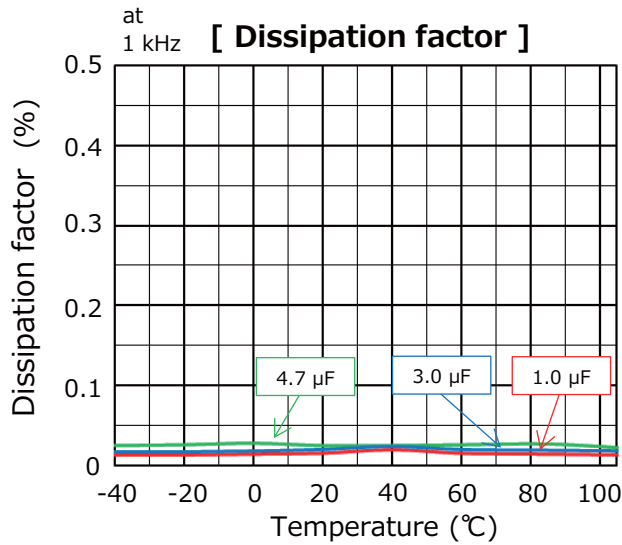
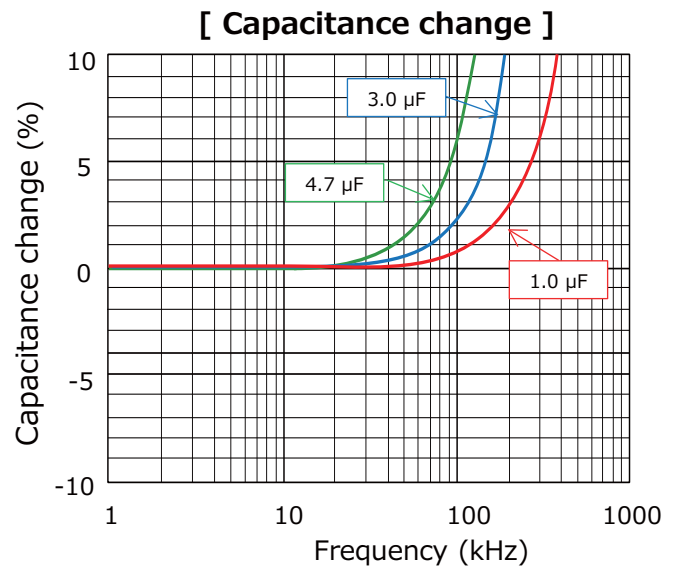

Characteristics data

■ **Rated voltage [DC] : 700 V**

Applicable specifications

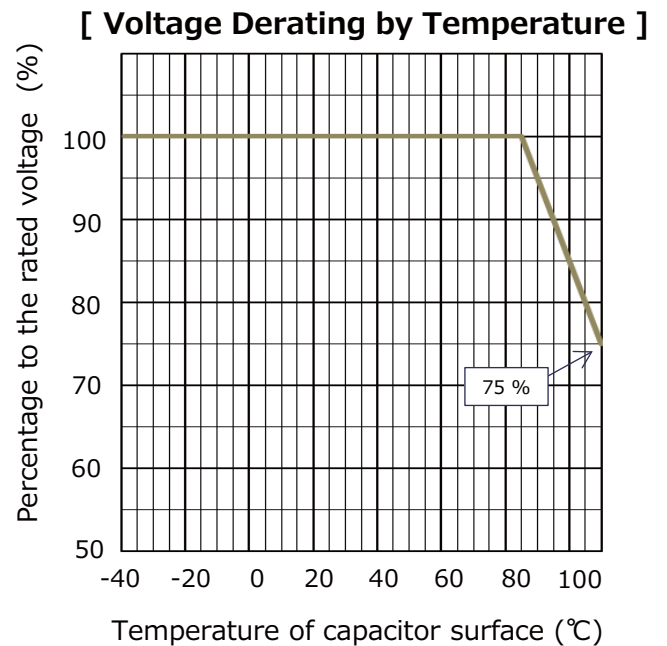
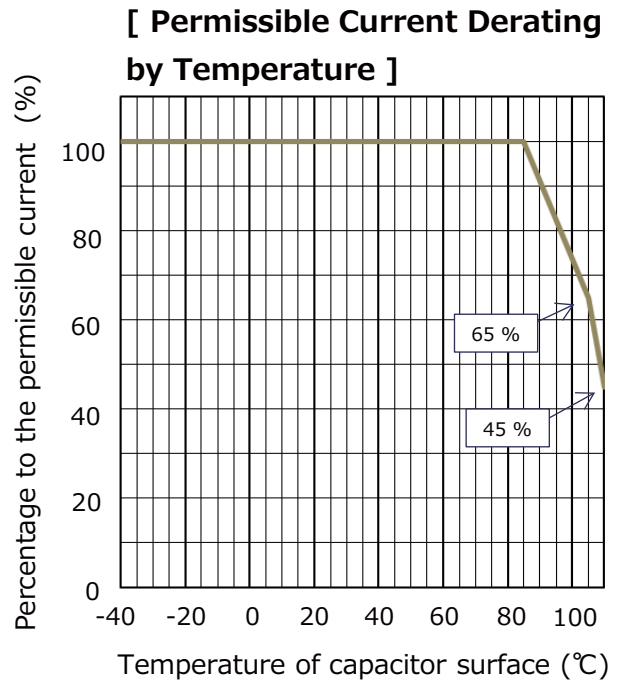
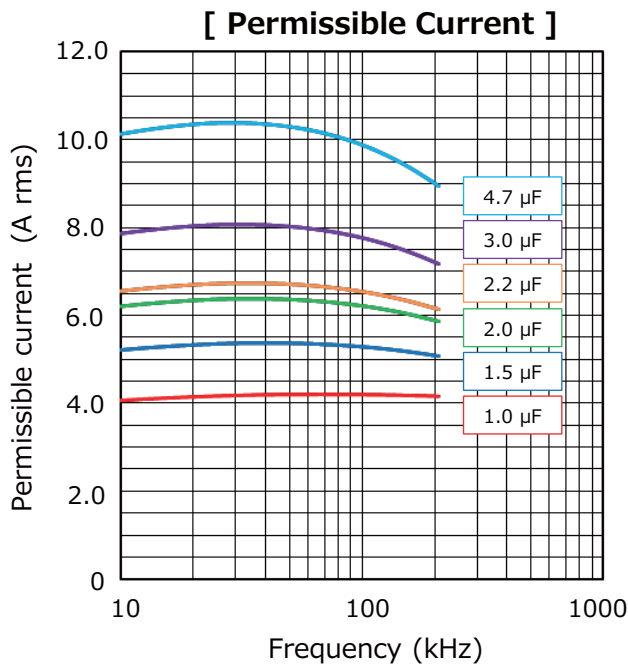

Permissible pulse current (dV/dt)
(Max. 10000 cycles)

R.voltage [DC] (V)	Capacitance (μF)	Code	dV/dt (V/μs)	Current (Ao-p)
700	1.0	105	50	50.0
	1.5	155		75.0
	2.0	205		100.0
	2.2	225		110.0
	3.0	305		150.0
	3.9	395		195.0
	4.7	475		235.0

Characteristics data

■ **Rated voltage [DC] : 800 V**

Electrical characteristics <Typical data >

Temperature characteristics

at
1 kHz [**Capacitance change**]

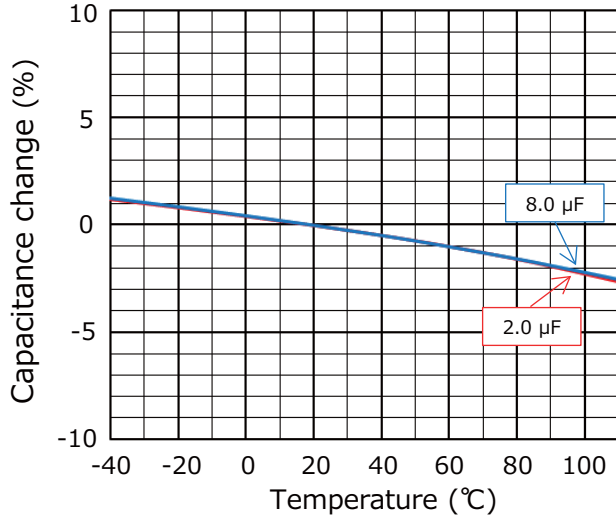

Frequency characteristics

[**Capacitance change**]

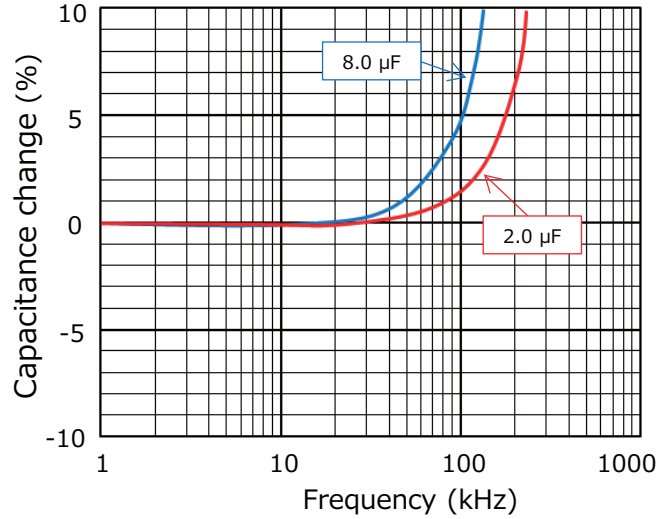

at
1 kHz [**Dissipation factor**]

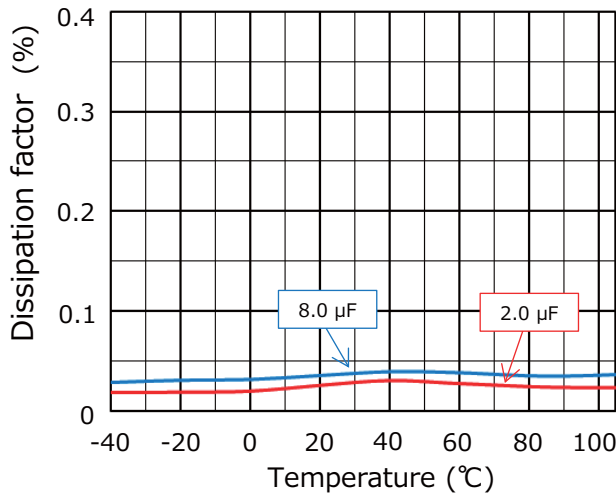

[**Dissipation factor**]

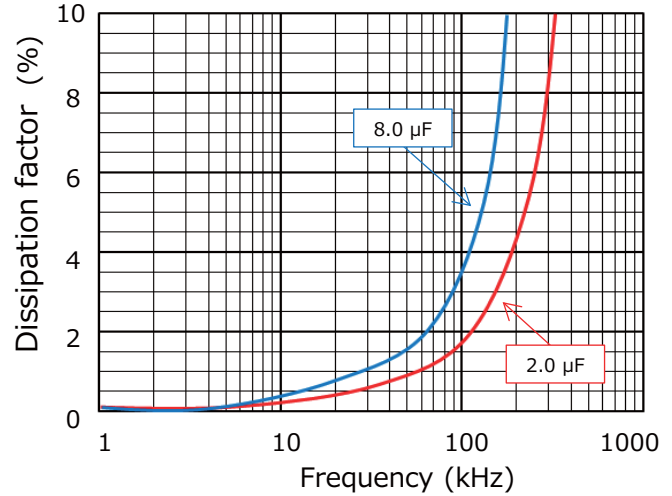

at DC
100 V [**Insulation resistance**]

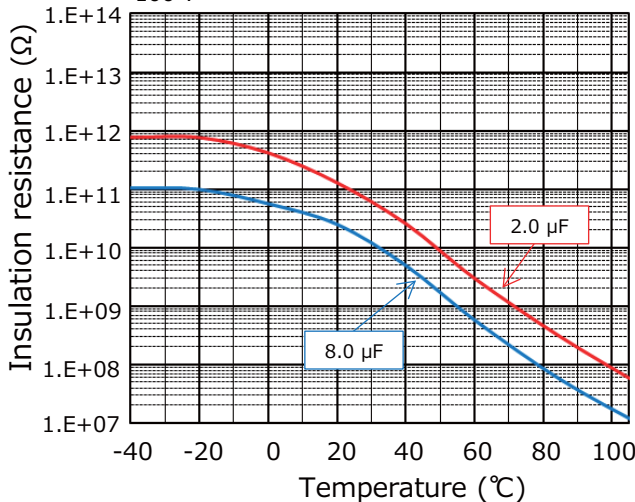

[**Impedance characteristics**]

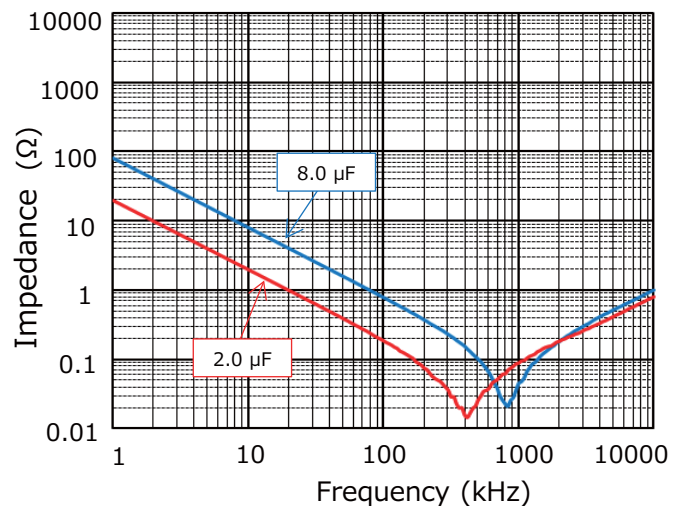

Characteristics data

■ **Rated voltage [DC] : 800 V**

Applicable specifications

[Permissible Current]

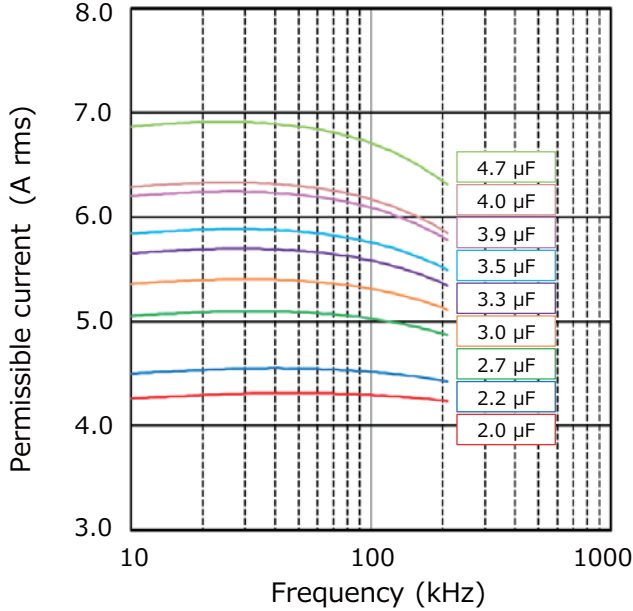

[Permissible Current Derating by Temperature]

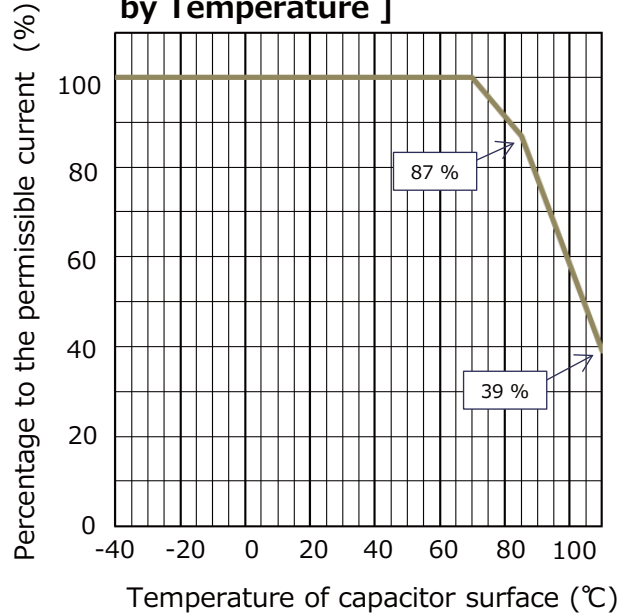

[Permissible Current]

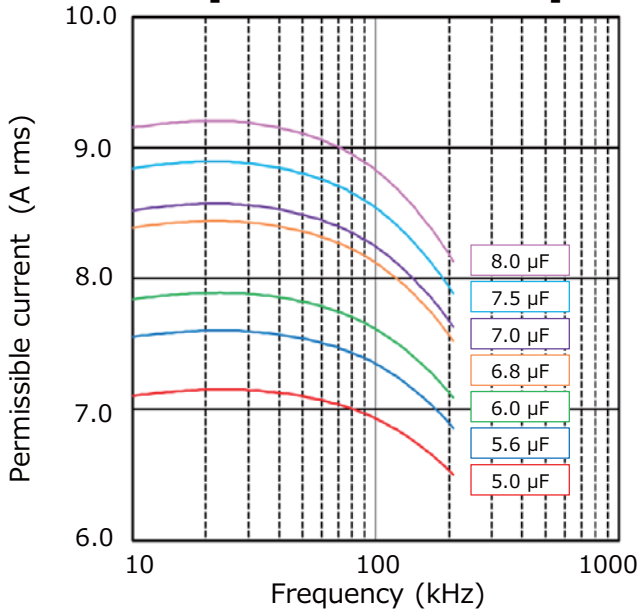

[Voltage Derating by Temperature]

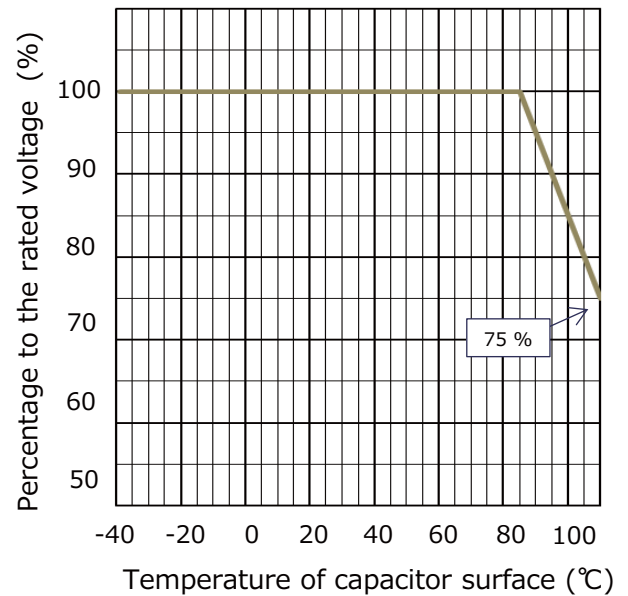

Permissible pulse current (dV/dt) (Max. 10000 cycles)

R.voltage [DC] (V)	Capacitance (μF)	Code	dV/dt (V/μs)	Current (Ao-p)
800	2.0	205	50	100.0
	2.2	225		110.0
	2.7	275		135.0
	3.0	305		150.0
	3.3	335		165.0
	3.5	355		175.0
	3.9	395		195.0
	4.0	405		200.0
4.7	475	235.0		

R.voltage [DC] (V)	Capacitance (μF)	Code	dV/dt (V/μs)	Current (Ao-p)
800	5.0	505	50	250.0
	5.6	565		280.0
	6.0	605		300.0
	6.8	685		340.0
	7.0	705		350.0
	7.5	755		375.0
	8.0	805		400.0

Characteristics data

■ Rated voltage [DC] : 1100 V

Electrical characteristics <Typical data >

Temperature characteristics

at 1 kHz [Capacitance change]

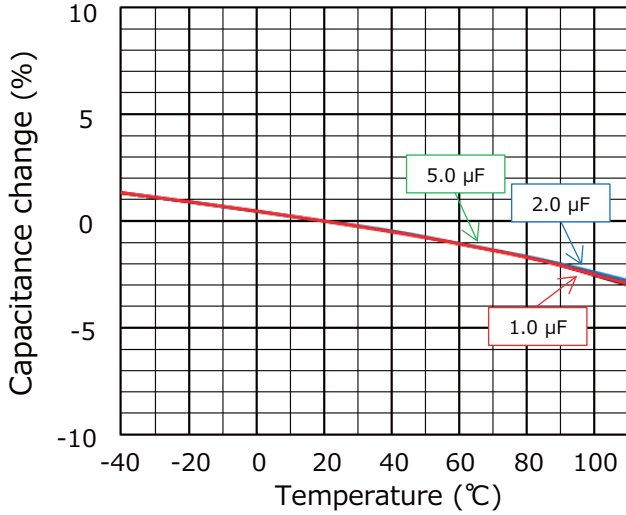

Frequency characteristics

[Capacitance change]

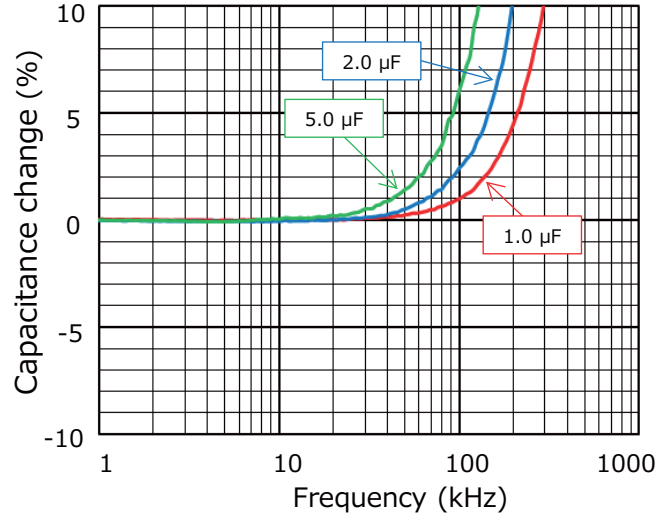

at 1 kHz [Dissipation factor]

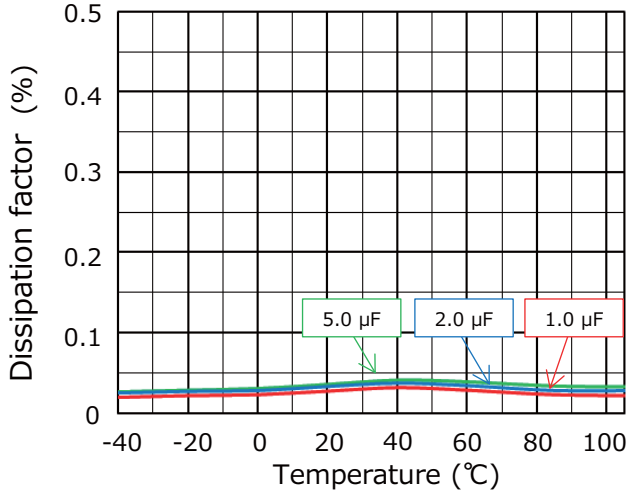

[Dissipation factor]

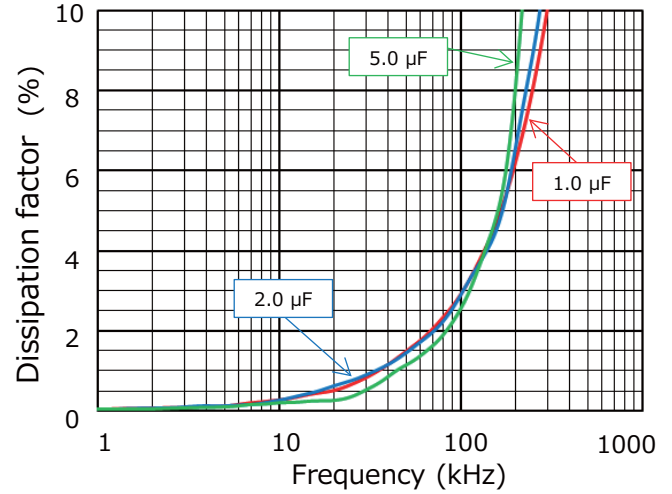

at DC 100 V [Insulation resistance]

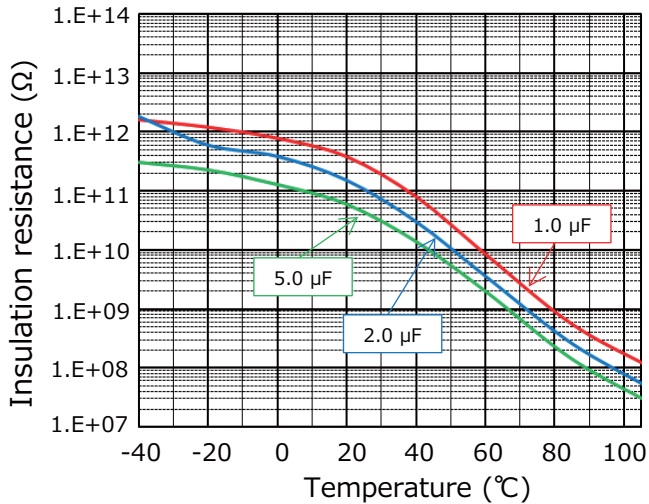

[Impedance characteristics]

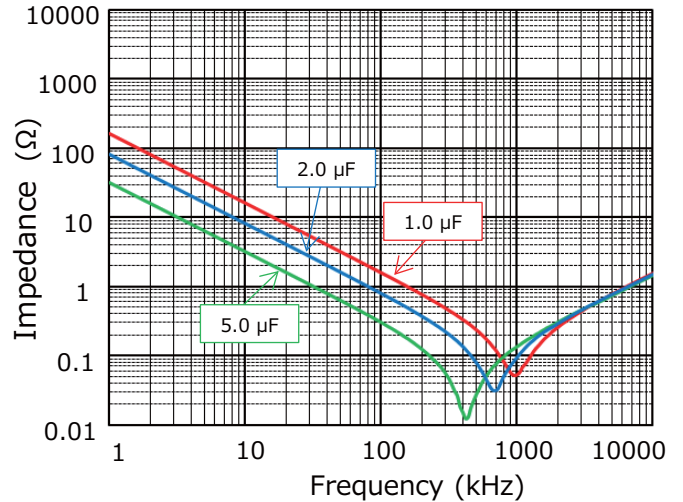

Characteristics data

■ **Rated voltage [DC] : 1100 V**

Applicable specifications

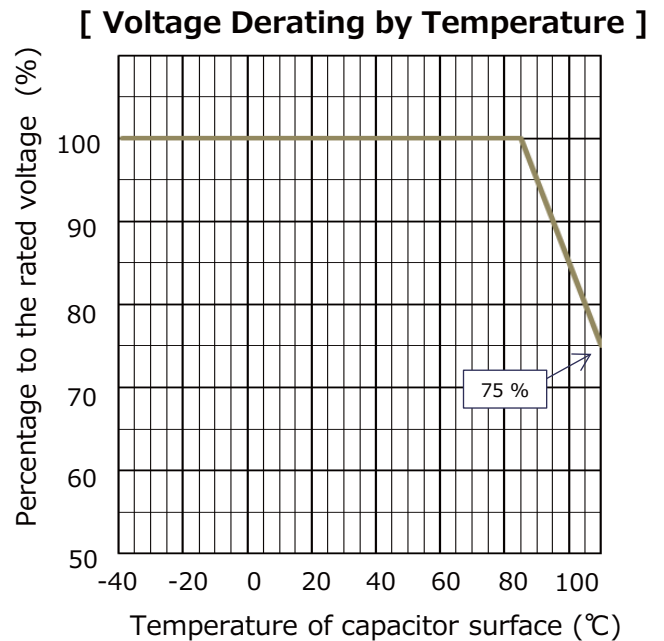
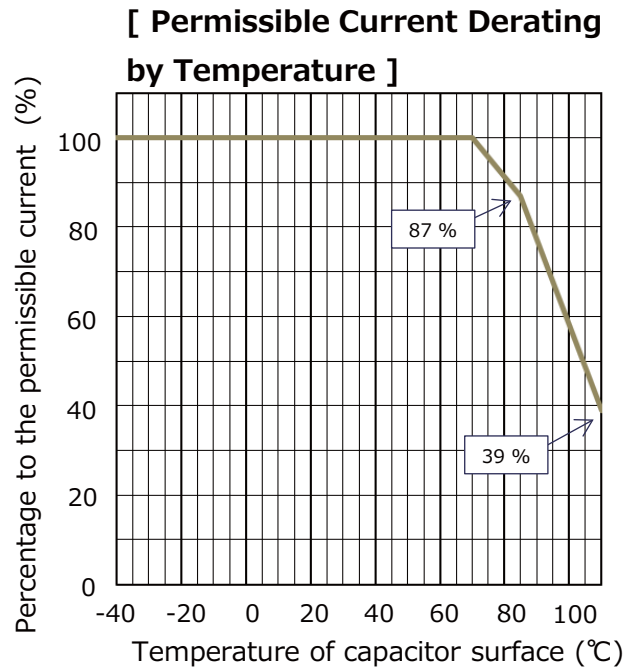
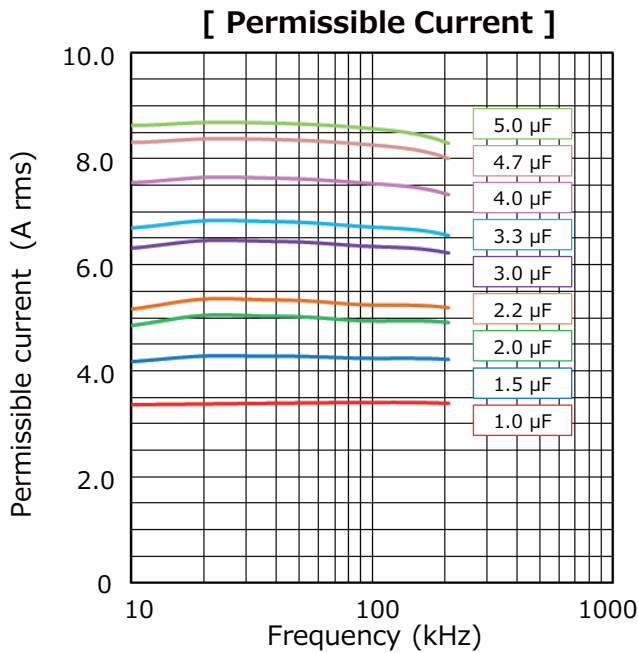

Permissible pulse current (dV/dt)
(Max. 10000 cycles)

R.voltage [DC] (V)	Capacitance (µF)	Code	dV/dt (V/µs)	Current (A _{o-p})
1100	1.0	105	100	100.0
	1.5	155		150.0
	2.0	205		200.0
	2.2	225		220.0
	3.0	305		300.0
	3.3	335		330.0
	4.0	405		400.0
	4.7	475		470.0
	5.0	505	500.0	