

Right Angle Surface Mount Infrared Phototransistor

QTLP610CPD

Description

QTLP610CPD is a phototransistor in miniature SMD package molded in a water clear plastic with right angle lens.

Features

- NPN Silicon Phototransistor
- Right Angle Surface Mount Package
- Matched Emitters: QTLP610CIR
- Available in 0.315" (8 mm) width tape on 7" (178 mm) diameter reel; 2,000 Units per Reel
- High Photo Sensitivity
- Low Junction Capacitance
- Fast Response Time
- Water Clear Lens
- This Device is Pb-Free and Halide Free

ABSOLUTE MAXIMUM RATINGS (T_A = 25°C unless otherwise noted)

Symbol	Parameter	Value	Unit
T _{OPR}	Operating Temperature	-25 to +85	°C
T _{STG}	Storage Temperature	-40 to +90	°C
T _{SOL-I}	Soldering Temperature (Iron) (Notes 2, 3, 4)	240 for 5 s	°C
T _{SOL-F}	Soldering Temperature (Flow) (Notes 2, 3)	260 for 10 s	°C
V _{CE}	Collector Emitter Voltage	30	V
V _{EC}	Emitter Collector Voltage	5	V
P _D	Power Dissipation (Note 1)	75	mW

Stresses exceeding those listed in the Maximum Ratings table may damage the device. If any of these limits are exceeded, device functionality should not be assumed, damage may occur and reliability may be affected.

1. At 25°C or below.
2. RMA flux is recommended.
3. Methanol or isopropyl alcohols are recommended as cleaning agents.
4. Pulse conditions: tp = 100 μs, T = 10 ms

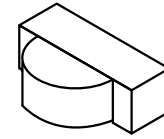

CHIPLED DETECTOR SIDELOOKER
CASE 100CQ

SCHEMATIC

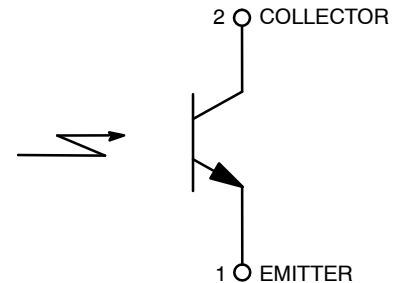

ORDERING INFORMATION

Device	Package	Shipping†
QTLP610CPDTR	CHIPLED DETECTOR SIDELOOKER (Pb-Free)	2000 / Tape & Reel

†For information on tape and reel specifications, including part orientation and tape sizes, please refer to our Tape and Reel Packaging Specification Brochure, [BRD8011/D](#).

QTLP610CPD

ELECTRICAL/OPTICAL CHARACTERISTICS ($T_A = 25^\circ\text{C}$)

Symbol	Parameter	Test Conditions	Min	Typ	Max	Unit
λ_{PS}	Peak Sensitivity Wavelength		–	860	–	nm
Θ	Reception Angle		–	± 80	–	$^\circ$
I_D	Dark Current	$V_{CE} = 20\text{ V}, E_e = 0$	–	–	100	nA
BV_{CEO}	Collector–Emitter Breakdown	$I_C = 100\ \mu\text{A}, E_e = 0$	30	–	–	V
BV_{ECO}	Emitter–Collector Breakdown	$I_E = 100\ \mu\text{A}, E_e = 0$	5	–	–	V
$I_{C(ON)}$	On–State Collector Current	$E_e = 1\ \text{mW}/\text{cm}^2, V_{CE} = 5\ \text{V}$	0.1	0.5	–	mA
$V_{CE(SAT)}$	Saturation Voltage	$E_e = 1\ \text{mW}/\text{cm}^2, I_C = 2\ \text{mA}$	–	–	0.4	V
t_r	Rise Time	$V_{CE} = 5\ \text{V}, R_L = 1000\ \Omega, I_C = 1\ \text{mA}$	–	15	–	μs
t_f	Fall Time		–	15	–	μs

Product parametric performance is indicated in the Electrical Characteristics for the listed test conditions, unless otherwise noted. Product performance may not be indicated by the Electrical Characteristics if operated under different conditions.

QTLP610CPD

TYPICAL PERFORMANCE CHARACTERISTICS

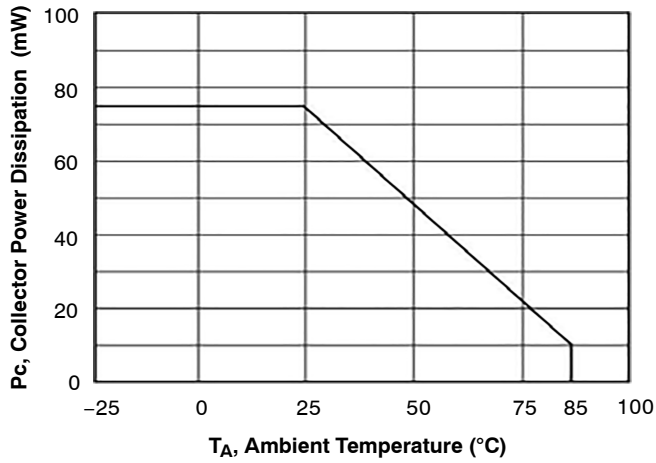

Figure 1. Collector Power Dissipation vs. Ambient Temperature

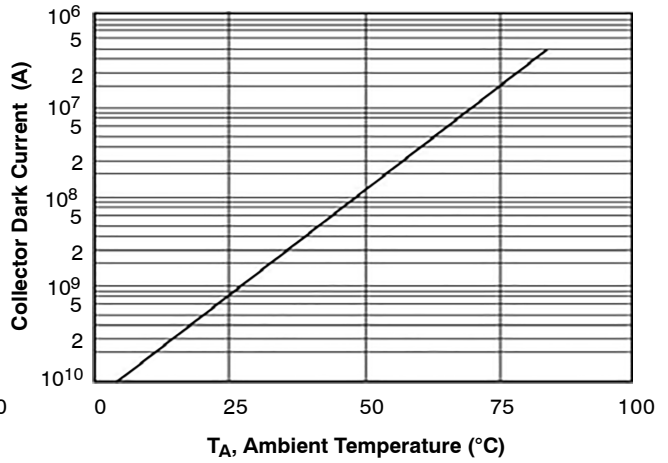

Figure 2. Collector Dark Current vs. Ambient temperature

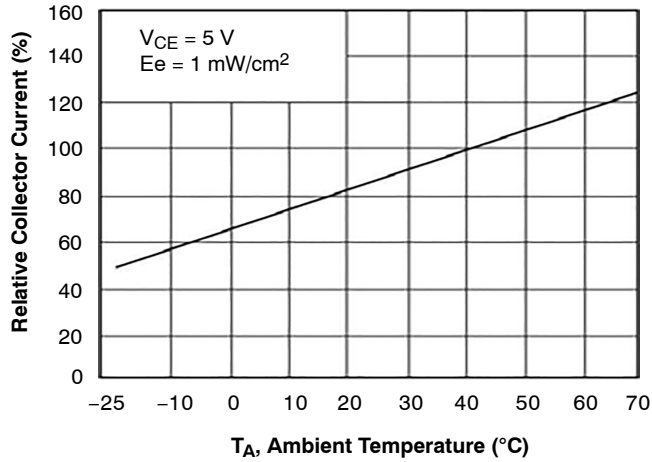

Figure 3. Relative Collector Current vs. Ambient Temperature

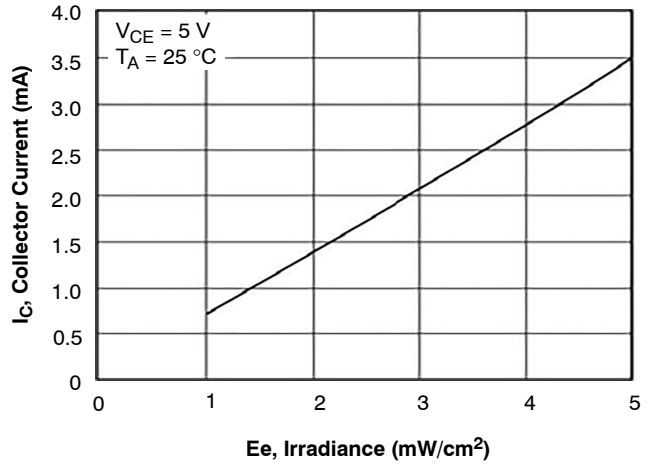

Figure 4. Collector Current vs. Irradiance

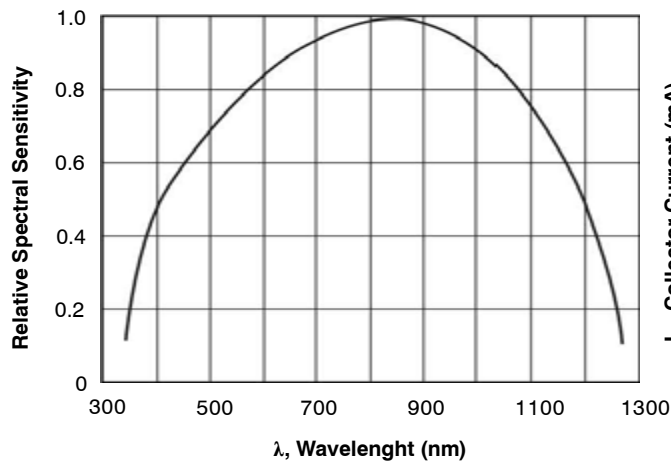

Figure 5. Spectral Sensitivity

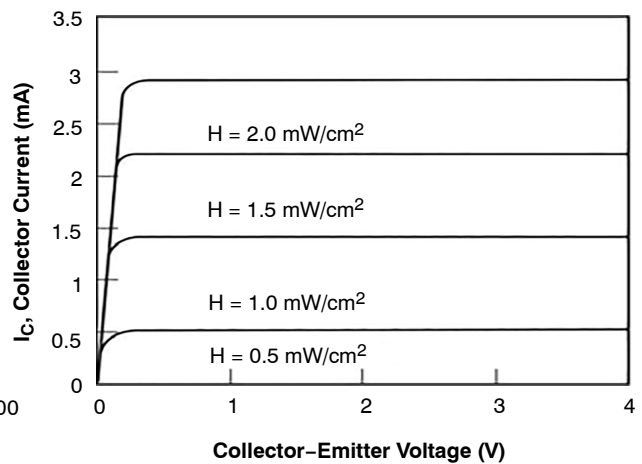
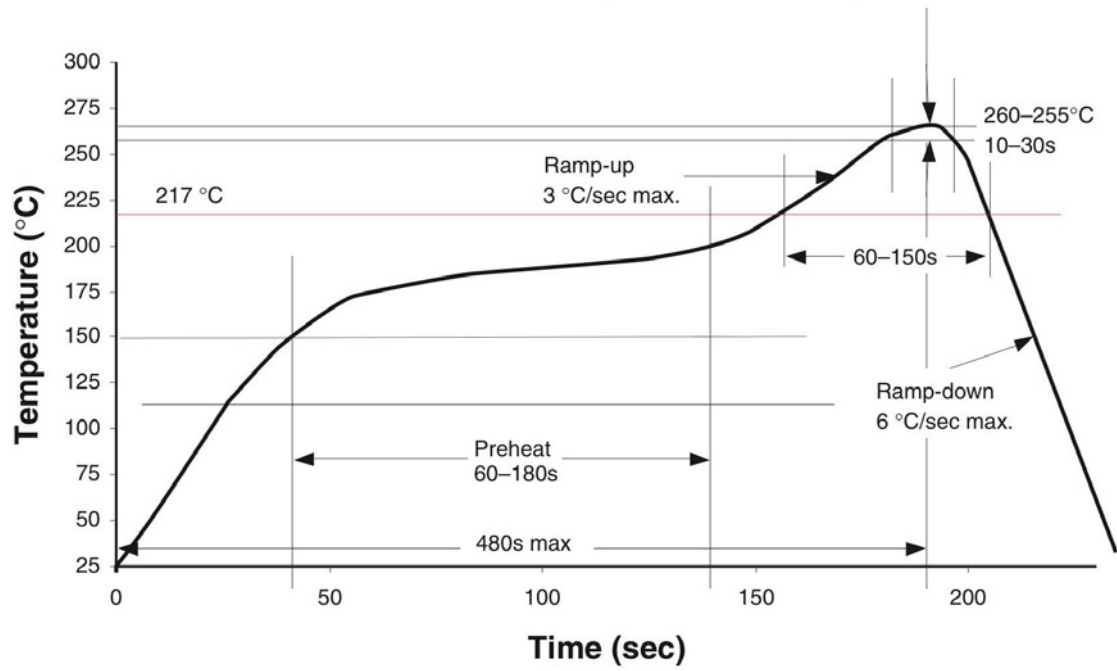

Figure 6. Collector Current vs. Collector-Emitter Voltage

QTLP610CPD

RECOMMENDED IR REFLOW SOLDERING PROFILE

Classification Reflow Profile (JEDEC J-STD-020C)



CHIPLED DETECTOR SIDELOOKER
CASE 100CQ
ISSUE O

DATE 30 NOV 2016

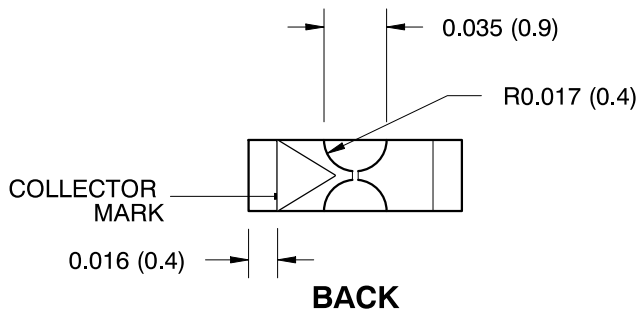
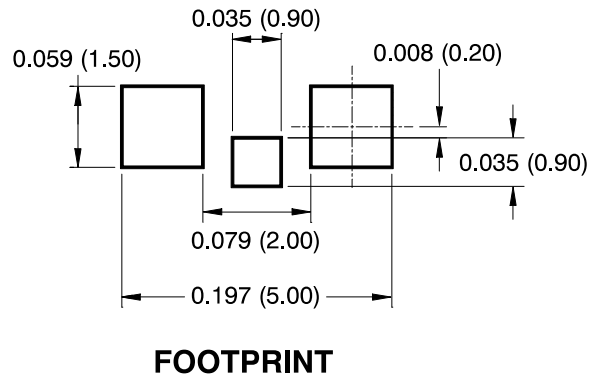
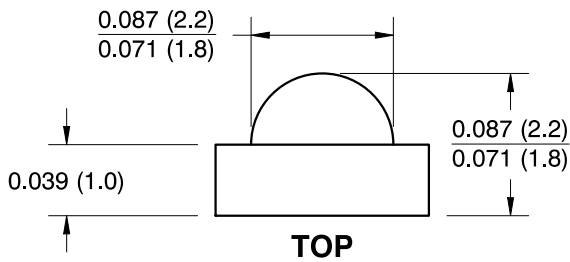
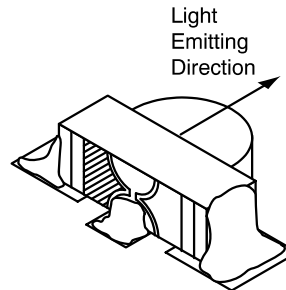
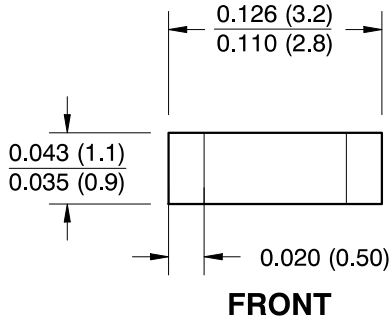

Notes:

1. Dimensions for all drawings are in inches (mm).
2. Tolerance of ± 0.010 (0.25) on all non-nominal dimensions unless otherwise specified.

DOCUMENT NUMBER:	98AON13422G	Electronic versions are uncontrolled except when accessed directly from the Document Repository. Printed versions are uncontrolled except when stamped "CONTROLLED COPY" in red.
DESCRIPTION:	CHIPLED DETECTOR SIDELOOKER	PAGE 1 OF 1

ON Semiconductor and are trademarks of Semiconductor Components Industries, LLC dba ON Semiconductor or its subsidiaries in the United States and/or other countries. ON Semiconductor reserves the right to make changes without further notice to any products herein. ON Semiconductor makes no warranty, representation or guarantee regarding the suitability of its products for any particular purpose, nor does ON Semiconductor assume any liability arising out of the application or use of any product or circuit, and specifically disclaims any and all liability, including without limitation special, consequential or incidental damages. ON Semiconductor does not convey any license under its patent rights nor the rights of others.

onsemi, **Onsemi**, and other names, marks, and brands are registered and/or common law trademarks of Semiconductor Components Industries, LLC dba "**onsemi**" or its affiliates and/or subsidiaries in the United States and/or other countries. **onsemi** owns the rights to a number of patents, trademarks, copyrights, trade secrets, and other intellectual property. A listing of **onsemi**'s product/patent coverage may be accessed at www.onsemi.com/site/pdf/Patent-Marking.pdf. **onsemi** reserves the right to make changes at any time to any products or information herein, without notice. The information herein is provided "as-is" and **onsemi** makes no warranty, representation or guarantee regarding the accuracy of the information, product features, availability, functionality, or suitability of its products for any particular purpose, nor does **onsemi** assume any liability arising out of the application or use of any product or circuit, and specifically disclaims any and all liability, including without limitation special, consequential or incidental damages. Buyer is responsible for its products and applications using **onsemi** products, including compliance with all laws, regulations and safety requirements or standards, regardless of any support or applications information provided by **onsemi**. "Typical" parameters which may be provided in **onsemi** data sheets and/or specifications can and do vary in different applications and actual performance may vary over time. All operating parameters, including "Typicals" must be validated for each customer application by customer's technical experts. **onsemi** does not convey any license under any of its intellectual property rights nor the rights of others. **onsemi** products are not designed, intended, or authorized for use as a critical component in life support systems or any FDA Class 3 medical devices or medical devices with a same or similar classification in a foreign jurisdiction or any devices intended for implantation in the human body. Should Buyer purchase or use **onsemi** products for any such unintended or unauthorized application, Buyer shall indemnify and hold **onsemi** and its officers, employees, subsidiaries, affiliates, and distributors harmless against all claims, costs, damages, and expenses, and reasonable attorney fees arising out of, directly or indirectly, any claim of personal injury or death associated with such unintended or unauthorized use, even if such claim alleges that **onsemi** was negligent regarding the design or manufacture of the part. **onsemi** is an Equal Opportunity/Affirmative Action Employer. This literature is subject to all applicable copyright laws and is not for resale in any manner.

ADDITIONAL INFORMATION

TECHNICAL PUBLICATIONS:

Technical Library: www.onsemi.com/design/resources/technical-documentation
onsemi Website: www.onsemi.com

ONLINE SUPPORT: www.onsemi.com/support

For additional information, please contact your local Sales Representative at www.onsemi.com/support/sales