

MOSFET - Symmetrical Dual N-Channel

60 V, 9 mΩ, 38 A

NTTFD9D0N06HL

General Description

This device includes two specialized N-Channel MOSFETs in a dual package. The switch node has been internally connected to enable easy placement and routing of synchronous buck converters. The control MOSFET (Q2) and synchronous (Q1) have been designed to provide optimal power efficiency.

Features

Q1: N-Channel

- Max $r_{DS(on)}$ = 9.0 mΩ at $V_{GS} = 10$ V, $I_D = 10$ A
- Max $r_{DS(on)}$ = 13 mΩ at $V_{GS} = 4.5$, $I_D = 8.0$ A

Q2: N-Channel

- Max $r_{DS(on)}$ = 9.0 mΩ at $V_{GS} = 10$ V, $I_D = 10$ A
- Max $r_{DS(on)}$ = 13 mΩ at $V_{GS} = 4.5$, $I_D = 8.0$ A
- Low Inductance Packaging Shortens Rise/Fall Times, Resulting in Lower Switching Losses
- RoHS Compliant

Typical Applications

- Computing
- Communications
- General Purpose Point of Load

PIN DESCRIPTION

Pin	Name	Description
1, 11, 12	GND (LSS)	Low Side Source
2	LSG	Low Side Gate
3, 4, 5, 6	V+ (HSD)	High Side Drain
7	HSG	High Side Gate
8, 9, 10	SW	Switching Node, Low Side Drain



ON Semiconductor®

www.onsemi.com

$V_{(BR)DSS}$	$R_{DS(on)}$ MAX	I_D MAX
60 V	9 mΩ @ 10 V	38 A
	13 mΩ @ 4.5 V	

ELECTRICAL CONNECTION

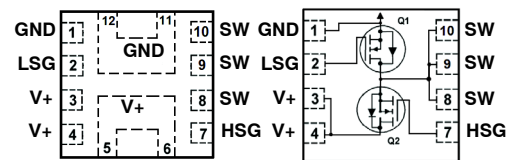

Dual N-Channel MOSFET

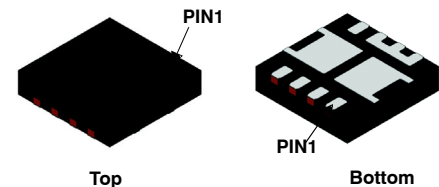

WQFN12, 3x3
CASE 510CJ

MARKING DIAGRAM

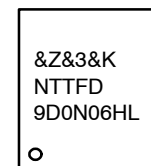

&Z = Assembly Plant Code
 &3 = Numeric Date Code
 &K = Lot Code
 NTTFD9D0N06HL = Specific Device Code

ORDERING INFORMATION

Device	Package	Shipping†
NTTFD9D0N06HLTWG	WQFN12 (Pb-Free)	3000 / Tape & Reel

†For information on tape and reel specifications, including part orientation and tape sizes, please refer to our Tape and Reel Packaging Specification Brochure, BRD8011/D.

NTTFD9D0N06HL

MOSFET MAXIMUM RATINGS ($T_A = 25^\circ\text{C}$, Unless otherwise specified)

Symbol	Parameter	Q1	Q2	Units		
V_{DS}	Drain-to-Source Voltage	60	60	V		
V_{GS}	Gate-to-Source Voltage	± 20	± 20	V		
I_D	Drain Current	-Continuous	$T_C = 25^\circ\text{C}$ (Note 4)	38	A	
		-Continuous	$T_C = 100^\circ\text{C}$ (Note 4)	23		
		-Continuous	$T_A = 25^\circ\text{C}$	9 (Note 1a)		9 (Note 1b)
		-Pulsed	$T_A = 25^\circ\text{C}$	349		349
E_{AS}	Single Pulse Avalanche Energy (Note 3)	46	46	mJ		
P_D	Power Dissipation for Single Operation	$T_C = 25^\circ\text{C}$	26	26	W	
	Power Dissipation for Single Operation	$T_A = 25^\circ\text{C}$	1.7 (Note 1a)	1.7 (Note 1b)		
T_J, T_{STG}	Operating and Storage Junction Temperature Range	-55 to +150		$^\circ\text{C}$		

Stresses exceeding those listed in the Maximum Ratings table may damage the device. If any of these limits are exceeded, device functionality should not be assumed, damage may occur and reliability may be affected.

THERMAL CHARACTERISTICS

Symbol	Parameter	Q1	Q2	Units
$R_{\theta JC}$	Thermal Resistance, Junction-to-Case	4.8	4.8	$^\circ\text{C}/\text{W}$
$R_{\theta JA}$	Thermal Resistance, Junction-to-Ambient (Note 1a), max copper	70 (Note 1a)	70 (Note 1b)	
$R_{\theta JA}$	Thermal Resistance, Junction-to-Ambient (Note 1c), min copper	135 (Note 1a)	135 (Note 1b)	

ELECTRICAL CHARACTERISTICS ($T_J = 25^\circ\text{C}$ unless otherwise noted)

Symbol	Parameter	Test Conditions	Type	Min	Typ	Max	Units
--------	-----------	-----------------	------	-----	-----	-----	-------

OFF CHARACTERISTICS

BV_{DSS}	Drain-to-Source Breakdown Voltage	$I_D = 250 \mu\text{A}, V_{GS} = 0 \text{ V}$	Q1	60			V
		$I_D = 250 \mu\text{A}, V_{GS} = 0 \text{ V}$	Q2	60			
$\frac{\Delta BV_{DSS}}{\Delta T_J}$	Breakdown Voltage Temperature Coefficient	$I_D = 250 \mu\text{A}$, referenced to 25°C	Q1		37.38		$\text{mV}/^\circ\text{C}$
		$I_D = 250 \mu\text{A}$, referenced to 25°C	Q2		37.38		
I_{DSS}	Zero Gate Voltage Drain Current	$V_{DS} = 60 \text{ V}, V_{GS} = 0 \text{ V}$	Q1			10	μA
		$V_{DS} = 60 \text{ V}, V_{GS} = 0 \text{ V}$	Q2			10	
I_{GSS}	Gate-to-Source Leakage Current, Forward	$V_{GS} = +20/-16 \text{ V}, V_{DS} = 0 \text{ V}$	Q1			± 100	nA
		$V_{GS} = +20/-16 \text{ V}, V_{DS} = 0 \text{ V}$	Q2			± 100	

ON CHARACTERISTICS

$V_{GS(th)}$	Gate-to-Source Threshold Voltage	$V_{GS} = V_{DS}, I_D = 50 \mu\text{A}$	Q1	1.2	1.6	2.0	V
		$V_{GS} = V_{DS}, I_D = 50 \mu\text{A}$	Q2	1.2	1.6	2.0	
$\frac{\Delta V_{GS(th)}}{\Delta T_J}$	Gate-to-Source Threshold Voltage Temperature Coefficient	$I_D = 50 \mu\text{A}$, referenced to 25°C	Q1		-6.19		$\text{mV}/^\circ\text{C}$
		$I_D = 50 \mu\text{A}$, referenced to 25°C	Q2		-6.19		
$r_{DS(on)}$	Drain-to-Source On Resistance	$V_{GS} = 10 \text{ V}, I_D = 10 \text{ A}$	Q1		7.3	9.0	$\text{m}\Omega$
		$V_{GS} = 4.5 \text{ V}, I_D = 8 \text{ A}$			9.8	13	
		$V_{GS} = 10 \text{ V}, I_D = 10 \text{ A}, T_J = 125^\circ\text{C}$			12.7		
$r_{DS(on)}$	Drain-to-Source On Resistance	$V_{GS} = 10 \text{ V}, I_D = 10 \text{ A}$	Q2		7.3	9.0	$\text{m}\Omega$
		$V_{GS} = 4.5 \text{ V}, I_D = 8 \text{ A}$			9.8	13	
		$V_{GS} = 10 \text{ V}, I_D = 10 \text{ A}, T_J = 125^\circ\text{C}$			12.7		
g_{FS}	Forward Transconductance	$V_{DS} = 15 \text{ V}, I_D = 10 \text{ A}$	Q1		53		S
		$V_{DS} = 15 \text{ V}, I_D = 10 \text{ A}$	Q2		53		

NTTFD9D0N06HL

ELECTRICAL CHARACTERISTICS (T_J = 25°C unless otherwise noted)

Symbol	Parameter	Test Conditions	Type	Min	Typ	Max	Units
--------	-----------	-----------------	------	-----	-----	-----	-------

DYNAMIC CHARACTERISTICS

C _{ISS}	Input Capacitance	Q1: V _{DS} = 30 V, V _{GS} = 0 V, f = 1 Mhz	Q1		948		pF
			Q2		948		
C _{OSS}	Output Capacitance	Q2: V _{DS} = 30 V, V _{GS} = 0 V, f = 1 MHz	Q1		188		pF
			Q2		188		
C _{RSS}	Reverse Transfer Capacitance		Q1		12.3		pF
			Q2		12.3		
R _G	Gate Resistance	T _A = 25°C	Q1		2.0		Ω
			Q2		2.0		

SWITCHING CHARACTERISTICS

t _{d(ON)}	Turn-On Delay Time	Q1: V _{DD} = 48 V, I _D = 19 A, V _{GS} = 4.5 V, R _{GEN} = 2.5 Ω	Q1		9.4		ns
			Q2		9.4		
t _r	Rise Time	Q2: V _{DD} = 48 V, I _D = 19 A, V _{GS} = 4.5 V, R _{GEN} = 2.5 Ω	Q1		5.8		ns
			Q2		5.8		
t _{D(OFF)}	Turn-Off Delay Time		Q1		12.8		ns
			Q2		12.8		
t _f	Fall Time		Q1		4.4		ns
			Q2		4.4		
Q _g	Total Gate Charge	V _{GS} = 0 V to 10 V	Q1		13.5		nC
			Q2		13.5		
Q _g	Total Gate Charge	V _{GS} = 0 V to 4.5 V	Q1		6.4		nC
			Q2		6.4		
Q _{gs}	Gate-to-Source Gate Charge	Q1: V _{DD} = 48 V, I _D = 19 A	Q1		2.6		nC
			Q2		2.6		
Q _{gd}	Gate-to-Drain "Miller" Charge	Q2: V _{DD} = 48 V, I _D = 19 A	Q1		2.8		nC
			Q2		2.8		

DRAIN-SOURCE DIODE CHARACTERISTICS

V _{SD}	Source to Drain Diode Forward Voltage	V _{GS} = 0 V, I _S = 10 A (Note 2)	Q1		0.79	1.2	V
		V _{GS} = 0 V, I _S = 10 A (Note 2)	Q2		0.79	1.2	
t _{rr}	Reverse Recovery Time	Q1: I _F = 19 A, di/dt = 100 A/μs	Q1		29		ns
			Q2		29		
Q _{rr}	Reverse Recovery Charge	Q2: I _F = 19 A, di/dt = 100 A/μs	Q1		14		nC
			Q2		14		

Product parametric performance is indicated in the Electrical Characteristics for the listed test conditions, unless otherwise noted. Product performance may not be indicated by the Electrical Characteristics if operated under different conditions.

1. R_{θJA} is determined with the device mounted on a 1 in² pad 2 oz copper pad on a 1.5 × 1.5 in. board of FR-4 material. R_{θCA} is determined by the user's board design.

NTTFD9D0N06HL

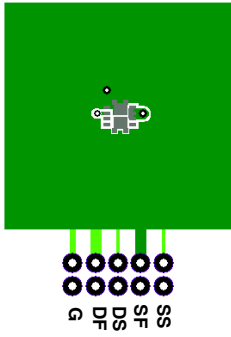

a) 70°C/W when mounted on a 1 in² pad of 2 oz copper.

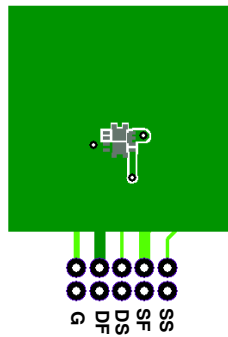

b) 70°C/W when mounted on a 1 in² pad of 2 oz copper.

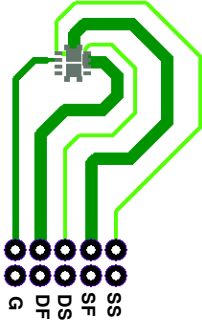

c) 135°C/W when mounted on a minimum pad of 2 oz copper.

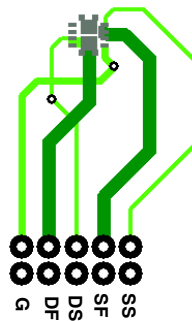

d) 135°C/W when mounted on a minimum pad of 2 oz copper.

- Pulse Test: Pulse Width < 300 μ s, Duty cycle < 2.0%.
- Q1: E_{AS} of 46 mJ is based on starting $T_J = 25^\circ\text{C}$; N-ch: $L = 1\text{ mH}$, $I_{AS} = 9.6\text{ A}$, $V_{DD} = 60\text{ V}$, $V_{GS} = 10\text{ V}$. 100% test at $L = 1\text{ mH}$, $I_{AS} = 9.6\text{ A}$.
- Q2: E_{AS} of 46 mJ is based on starting $T_J = 25^\circ\text{C}$; N-ch: $L = 1\text{ mH}$, $I_{AS} = 9.6\text{ A}$, $V_{DD} = 60\text{ V}$, $V_{GS} = 10\text{ V}$. 100% test at $L = 1\text{ mH}$, $I_{AS} = 9.6\text{ A}$.
- Computed continuous current limited to Max Junction Temperature only, actual continuous current will be limited by thermal & electro-mechanical application board design.

TYPICAL CHARACTERISTICS

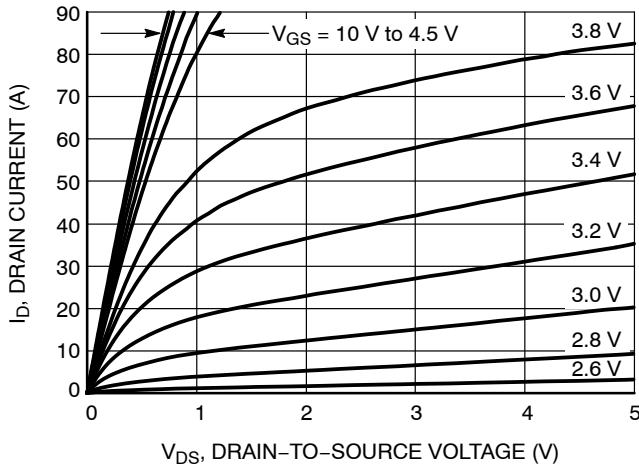

Figure 1. On-Region Characteristics

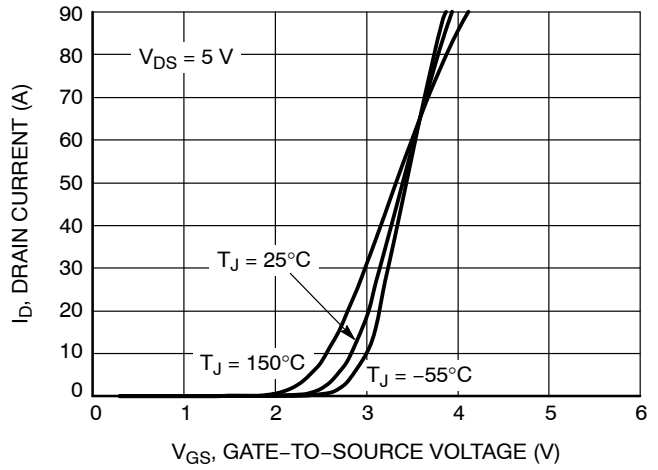

Figure 2. Transfer Characteristics

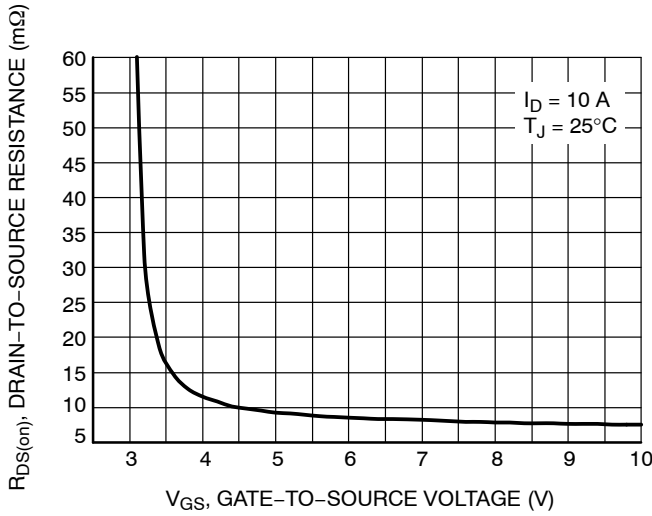

Figure 3. On-Resistance vs. Gate-to-Source Voltage

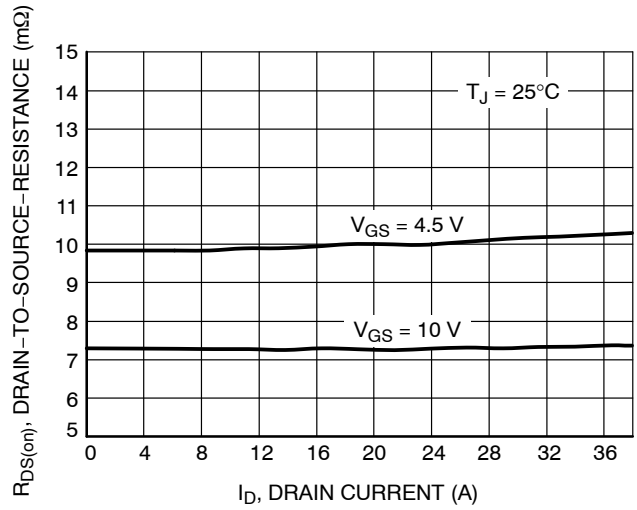

Figure 4. On-Resistance vs. Drain Current and Gate Voltage

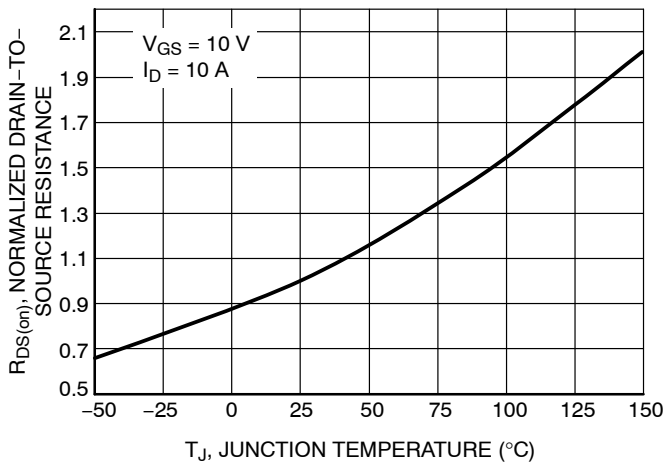

Figure 5. On-Resistance Variation with Temperature

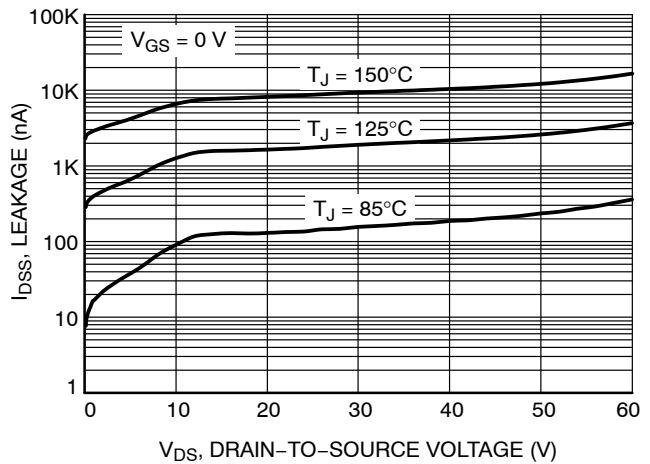

Figure 6. Drain-to-Source Leakage Current vs. Voltage

NTTFD9D0N06HL

TYPICAL CHARACTERISTICS

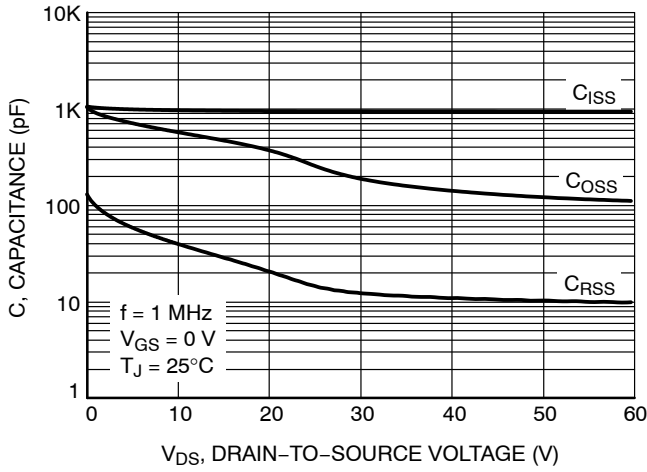

Figure 7. Capacitance Variation

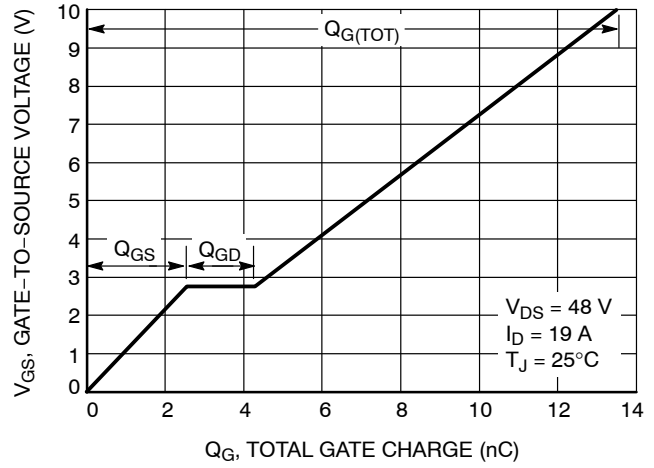

Figure 8. Gate-to-Source vs. Total Charge

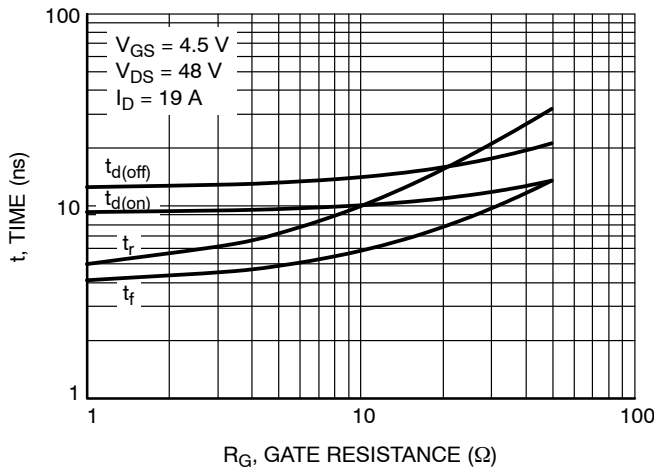

Figure 9. Resistive Switching Time Variation vs. Gate Resistance

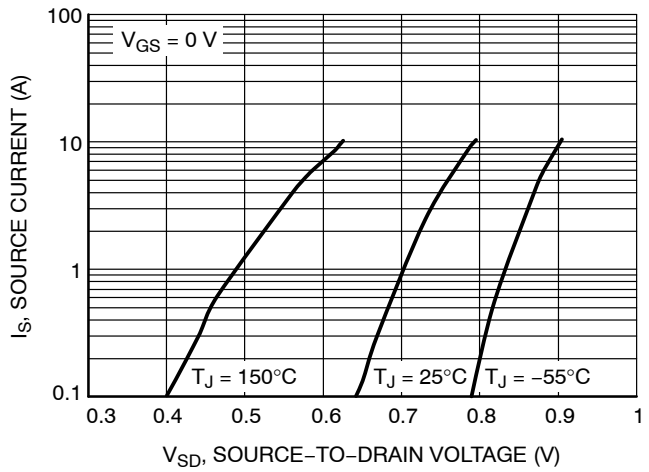

Figure 10. Diode Forward Voltage vs. Current

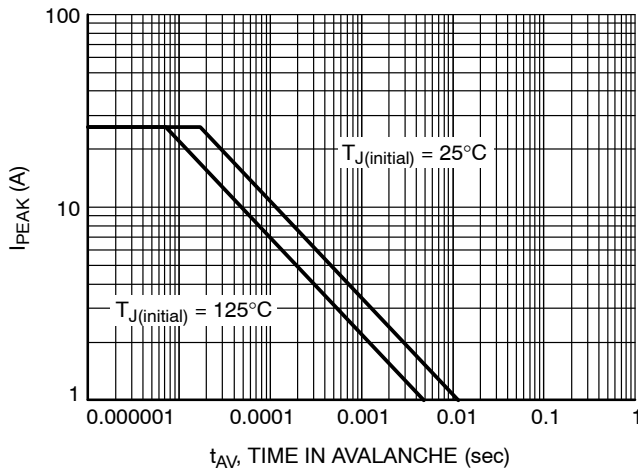

Figure 11. Unclamped Inductive Switching Capability

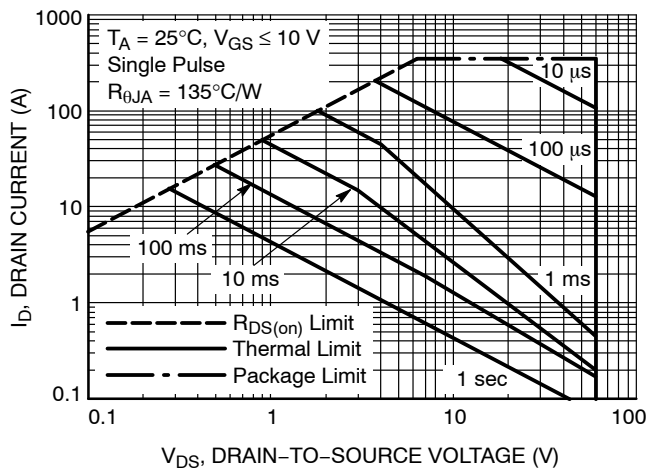

Figure 12. Forward Bias Safe Operating Area

NTTFD9D0N06HL

TYPICAL CHARACTERISTICS

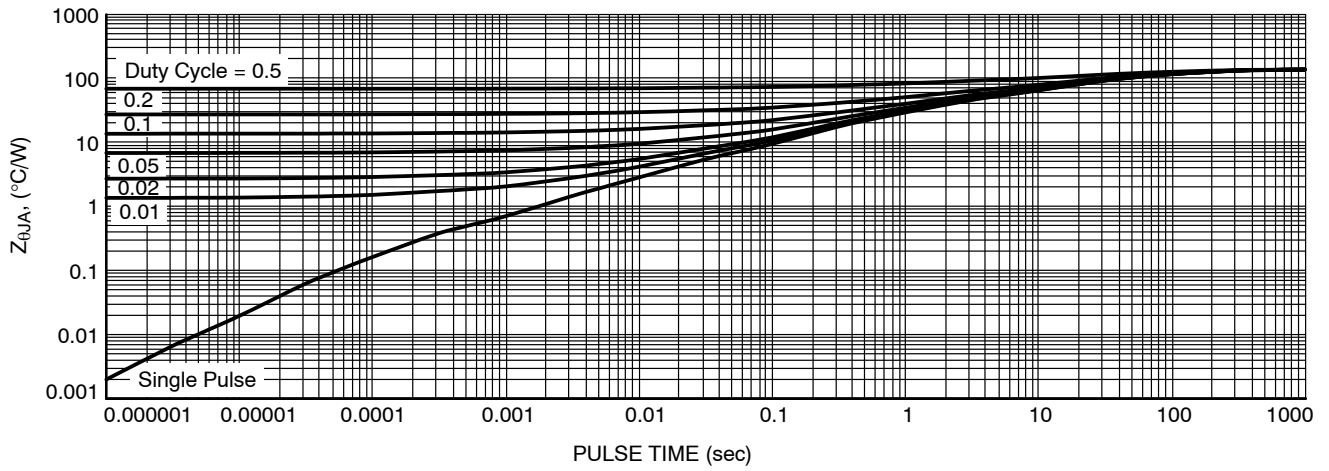
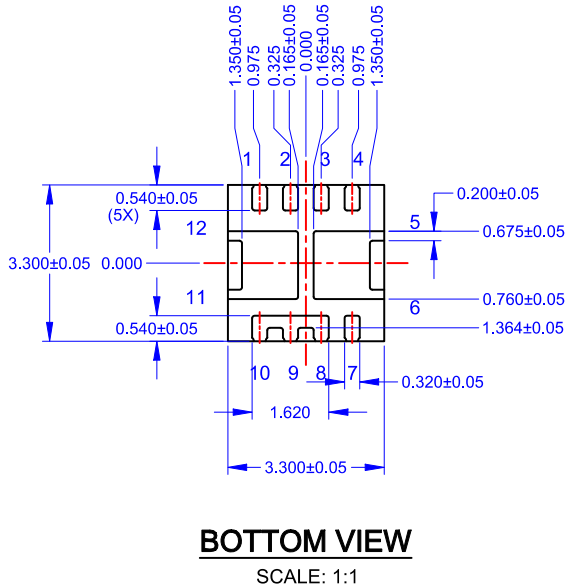
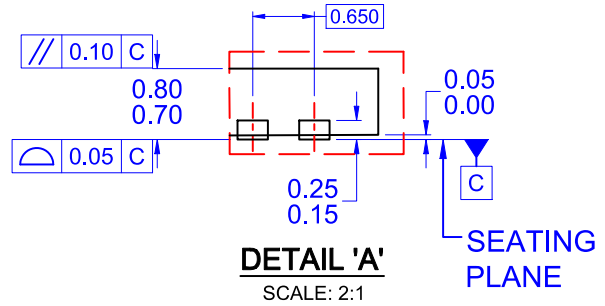
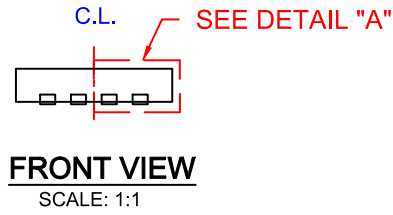
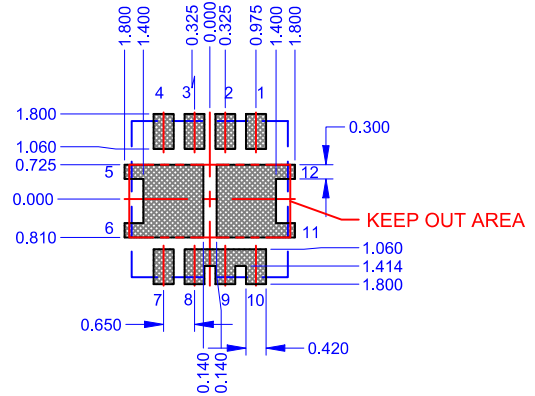
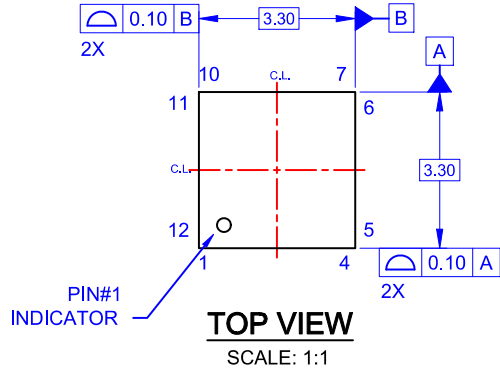

Figure 13. Transient Thermal Impedance

NTTFD9D0N06HL

PACKAGE DIMENSIONS

WQFN12 3.3X3.3, 0.65P
CASE 510CJ
ISSUE O



NOTES: UNLESS OTHERWISE SPECIFIED

- A) DRAWING DOES NOT FULLY CONFORM TO JEDEC REGISTRATION MO-220, VARIATION WEEC-1
- B) ALL DIMENSIONS ARE IN MILLIMETERS.
- C) DIMENSIONS DO NOT INCLUDE BURRS OR MOLD FLASH. MOLD FLASH OR BURRS DOES NOT EXCEED 0.10MM.

ON Semiconductor and  are trademarks of Semiconductor Components Industries, LLC dba ON Semiconductor or its subsidiaries in the United States and/or other countries. ON Semiconductor owns the rights to a number of patents, trademarks, copyrights, trade secrets, and other intellectual property. A listing of ON Semiconductor's product/patent coverage may be accessed at www.onsemi.com/site/pdf/Patent-Marking.pdf. ON Semiconductor reserves the right to make changes without further notice to any products herein. ON Semiconductor makes no warranty, representation or guarantee regarding the suitability of its products for any particular purpose, nor does ON Semiconductor assume any liability arising out of the application or use of any product or circuit, and specifically disclaims any and all liability, including without limitation special, consequential or incidental damages. Buyer is responsible for its products and applications using ON Semiconductor products, including compliance with all laws, regulations and safety requirements or standards, regardless of any support or applications information provided by ON Semiconductor. "Typical" parameters which may be provided in ON Semiconductor data sheets and/or specifications can and do vary in different applications and actual performance may vary over time. All operating parameters, including "Typicals" must be validated for each customer application by customer's technical experts. ON Semiconductor does not convey any license under its patent rights nor the rights of others. ON Semiconductor products are not designed, intended, or authorized for use as a critical component in life support systems or any FDA Class 3 medical devices or medical devices with a same or similar classification in a foreign jurisdiction or any devices intended for implantation in the human body. Should Buyer purchase or use ON Semiconductor products for any such unintended or unauthorized application, Buyer shall indemnify and hold ON Semiconductor and its officers, employees, subsidiaries, affiliates, and distributors harmless against all claims, costs, damages, and expenses, and reasonable attorney fees arising out of, directly or indirectly, any claim of personal injury or death associated with such unintended or unauthorized use, even if such claim alleges that ON Semiconductor was negligent regarding the design or manufacture of the part. ON Semiconductor is an Equal Opportunity/Affirmative Action Employer. This literature is subject to all applicable copyright laws and is not for resale in any manner.

PUBLICATION ORDERING INFORMATION

LITERATURE FULFILLMENT:

Email Requests to: orderlit@onsemi.com

ON Semiconductor Website: www.onsemi.com

TECHNICAL SUPPORT

North American Technical Support:
Voice Mail: 1 800-282-9855 Toll Free USA/Canada
Phone: 011 421 33 790 2910

Europe, Middle East and Africa Technical Support:
Phone: 00421 33 790 2910

For additional information, please contact your local Sales Representative