

NTB095N65S3HF

MOSFET – N-Channel, SUPERFET III, FRFET

650 V, 36 A, 95 mΩ

Description

SUPERFET III MOSFET is ON Semiconductor's brand-new high voltage super-junction (SJ) MOSFET family that is utilizing charge balance technology for outstanding low on-resistance and lower gate charge performance. This advanced technology is tailored to minimize conduction loss, provide superior switching performance, and withstand extreme dv/dt rate.

Consequently, SUPERFET III MOSFET is very suitable for the various power system for miniaturization and higher efficiency.

SUPERFET III FRFET MOSFET's optimized reverse recovery performance of body diode can remove additional component and improve system reliability.

Features

- 700 V @ $T_J = 150^\circ\text{C}$
- Typ. $R_{DS(on)} = 80\text{ m}\Omega$
- Ultra Low Gate Charge (Typ. $Q_g = 66\text{ nC}$)
- Low Effective Output Capacitance (Typ. $C_{oss(eff.)} = 569\text{ pF}$)
- 100% Avalanche Tested
- These Devices are Pb-Free and are RoHS Compliant

Applications

- Telecom / Server Power Supplies
- Industrial Power Supplies
- EV Charger
- UPS / Solar



ON Semiconductor®

www.onsemi.com

V_{DSS}	$R_{DS(on)}\text{ MAX}$	$I_D\text{ MAX}$
650 V	95 mΩ @ 10 V	36 A

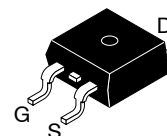
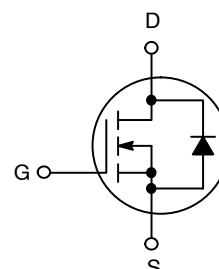

D²PAK
CASE 418AJ

MARKING DIAGRAM



\$Y = ON Semiconductor Logo
&Z = Assembly Plant Code
&3 = Data Code (Year & Week)
&K = Lot
NTB095N65S3HF = Specific Device Code

ORDERING INFORMATION

See detailed ordering and shipping information on page 2 of this data sheet.

NTB095N65S3HF

ABSOLUTE MAXIMUM RATINGS (T_C = 25°C, Unless otherwise noted)

Symbol	Parameter	Value	Unit
V _{DSS}	Drain to Source Voltage	650	V
V _{GSS}	Gate to Source Voltage	- DC	±30
		- AC (f > 1 Hz)	±30
I _D	Drain Current	- Continuous (T _C = 25°C)	36
		- Continuous (T _C = 100°C)	22.8
I _{DM}	Drain Current	- Pulsed (Note 1)	90
E _{AS}	Single Pulsed Avalanche Energy (Note 2)	440	mJ
I _{AS}	Avalanche Current (Note 2)	4.6	A
E _{AR}	Repetitive Avalanche Energy (Note 1)	2.72	mJ
dv/dt	MOSFET dv/dt	100	V/ns
	Peak Diode Recovery dv/dt (Note 3)	50	
P _D	Power Dissipation	(T _C = 25°C)	272
		- Derate Above 25°C	2.176
T _J , T _{STG}	Operating and Storage Temperature Range	-55 to +150	°C
T _L	Maximum Lead Temperature for Soldering, 1/8" from Case for 5 seconds	300	°C

Stresses exceeding those listed in the Maximum Ratings table may damage the device. If any of these limits are exceeded, device functionality should not be assumed, damage may occur and reliability may be affected.

1. Repetitive rating: pulse-width limited by maximum junction temperature.
2. I_{AS} = 4.6 A, R_G = 25 Ω, starting T_J = 25°C.
3. I_{SD} ≤ 18 A, di/dt ≤ 200 A/μs, V_{DD} ≤ 400 V, starting T_J = 25°C.

THERMAL CHARACTERISTICS

Symbol	Parameter	Value	Unit
R _{θJC}	Thermal Resistance, Junction to Case, Max.	0.46	°C/W
R _{θJA}	Thermal Resistance, Junction to Ambient, Max. (Note 4)	40	

4. Device on 1 in² 2-oz copper pad on 1.5 x 1.5 in. board of FR-4 material.

PACKAGE MARKING AND ORDERING INFORMATION

Part Number	Top Marking	Package	Reel Size	Tape Width	Shipping†
NTB095N65S3HF	NTB095N65S3HF	D ² PAK	330 mm	24 mm	800 / Tape & Reel

†For information on tape and reel specifications, including part orientation and tape sizes, please refer to our Tape and Reel Packaging Specifications Brochure, BRD8011/D.

NTB095N65S3HF

ELECTRICAL CHARACTERISTICS (T_C = 25°C unless otherwise noted)

Symbol	Parameter	Test Conditions	Min.	Typ.	Max.	Unit
--------	-----------	-----------------	------	------	------	------

OFF CHARACTERISTICS

BV _{DSS}	Drain to Source Breakdown Voltage	V _{GS} = 0 V, I _D = 1 mA, T _J = 25°C	650			V
		V _{GS} = 0 V, I _D = 1 mA, T _J = 150°C	700			V
ΔBV _{DSS} /ΔT _J	Breakdown Voltage Temperature Coefficient	I _D = 15 mA, Referenced to 25°C		0.63		V/°C
I _{DSS}	Zero Gate Voltage Drain Current	V _{DS} = 650 V, V _{GS} = 0 V			10	μA
		V _{DS} = 520 V, T _C = 125°C		97		
I _{GSS}	Gate to Body Leakage Current	V _{GS} = ±30 V, V _{DS} = 0 V			±100	nA

ON CHARACTERISTICS

V _{GS(th)}	Gate Threshold Voltage	V _{GS} = V _{DS} , I _D = 0.86 mA	3.0		5.0	V
R _{DS(on)}	Static Drain to Source On Resistance	V _{GS} = 10 V, I _D = 18 A		80	95	mΩ
g _{FS}	Forward Transconductance	V _{DS} = 20 V, I _D = 18 A		17		S

DYNAMIC CHARACTERISTICS

C _{iss}	Input Capacitance	V _{DS} = 400 V, V _{GS} = 0 V, f = 1 MHz		2930		pF
C _{oss}	Output Capacitance			61		pF
C _{oss(eff.)}	Effective Output Capacitance	V _{DS} = 0 V to 400 V, V _{GS} = 0 V		569		pF
C _{oss(er.)}	Energy Related Output Capacitance	V _{DS} = 0 V to 400 V, V _{GS} = 0 V		110		pF
Q _{g(tot)}	Total Gate Charge at 10V	V _{DS} = 400 V, I _D = 18 A, V _{GS} = 10 V (Note 5)		66		nC
Q _{gs}	Gate to Source Gate Charge			21		nC
Q _{gd}	Gate to Drain "Miller" Charge			25		nC
ESR	Equivalent Series Resistance	f = 1 MHz		2.4		Ω

SWITCHING CHARACTERISTICS

t _{d(on)}	Turn-On Delay Time	V _{DD} = 400 V, I _D = 18 A, V _{GS} = 10 V, R _g = 4.7 Ω (Note 5)		28		ns
t _r	Turn-On Rise Time			28		ns
t _{d(off)}	Turn-Off Delay Time			72		ns
t _f	Turn-Off Fall Time			24		ns

SOURCE-DRAIN DIODE CHARACTERISTICS

I _S	Maximum Continuous Source to Drain Diode Forward Current			36		A
I _{SM}	Maximum Pulsed Source to Drain Diode Forward Current			90		A
V _{SD}	Source to Drain Diode Forward Voltage	V _{GS} = 0 V, I _{SD} = 18 A			1.3	V
t _{rr}	Reverse Recovery Time	V _{DD} = 400 V, I _{SD} = 18 A, dI _F /dt = 100 A/μs		106		ns
Q _{rr}	Reverse Recovery Charge			414		nC

Product parametric performance is indicated in the Electrical Characteristics for the listed test conditions, unless otherwise noted. Product performance may not be indicated by the Electrical Characteristics if operated under different conditions.

5. Essentially independent of operating temperature typical characteristics.

TYPICAL CHARACTERISTICS

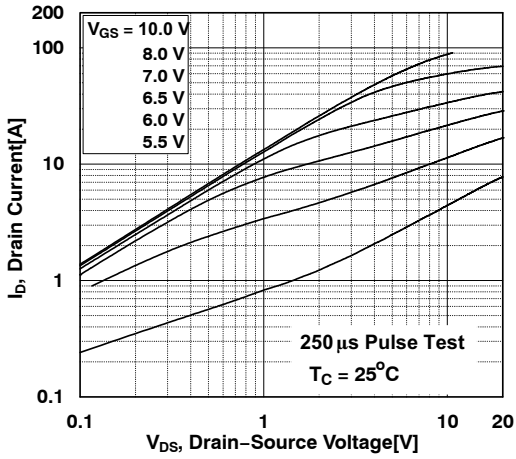

Figure 1. On-Region Characteristics

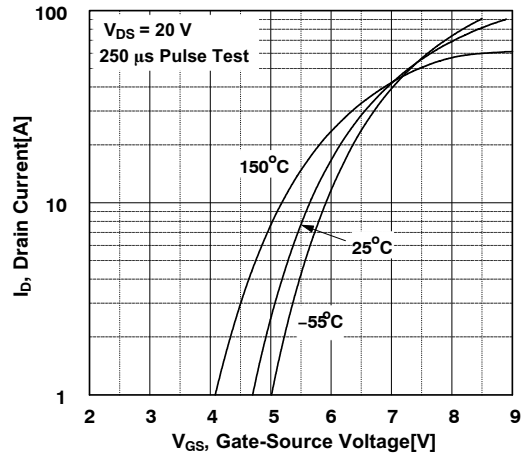

Figure 2. Transfer Characteristics



Figure 3. On-Resistance Variation vs. Drain Current and Gate Voltage

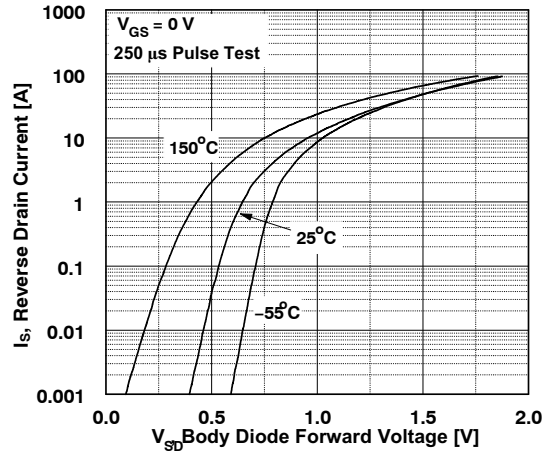

Figure 4. Body Diode Forward Voltage Variation vs. Source Current and Temperature

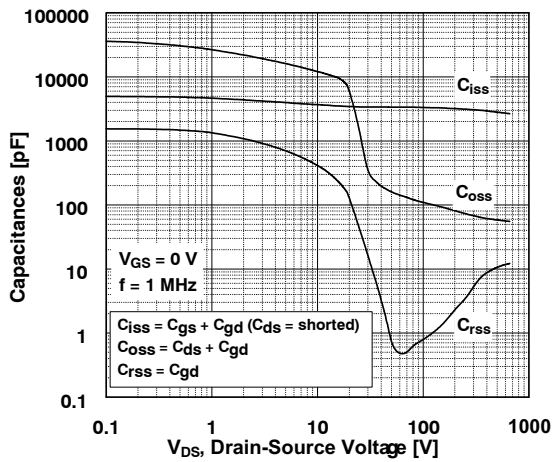

Figure 5. Capacitance Characteristics

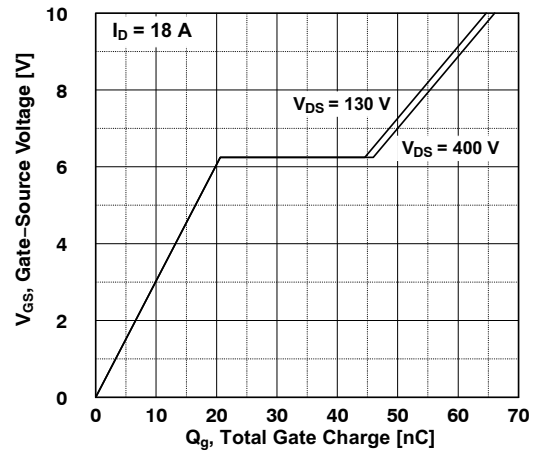

Figure 6. Gate Charge Characteristics

NTB095N65S3HF

TYPICAL CHARACTERISTICS

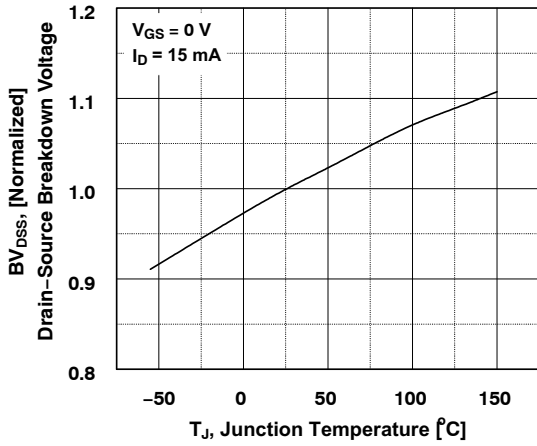

Figure 7. Breakdown Voltage Variation vs. Temperature



Figure 8. On-Resistance Variation vs. Temperature

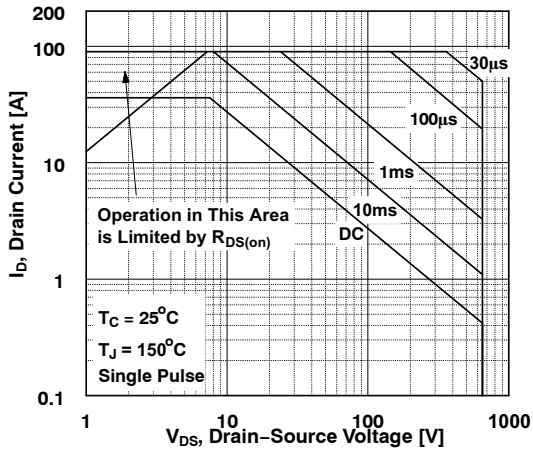

Figure 9. Maximum Safe Operating Area



Figure 10. Maximum Drain Current vs. Case Temperature



Figure 11. E_{oss} vs. Drain-to-Source Voltage

NTB095N65S3HF

TYPICAL CHARACTERISTICS

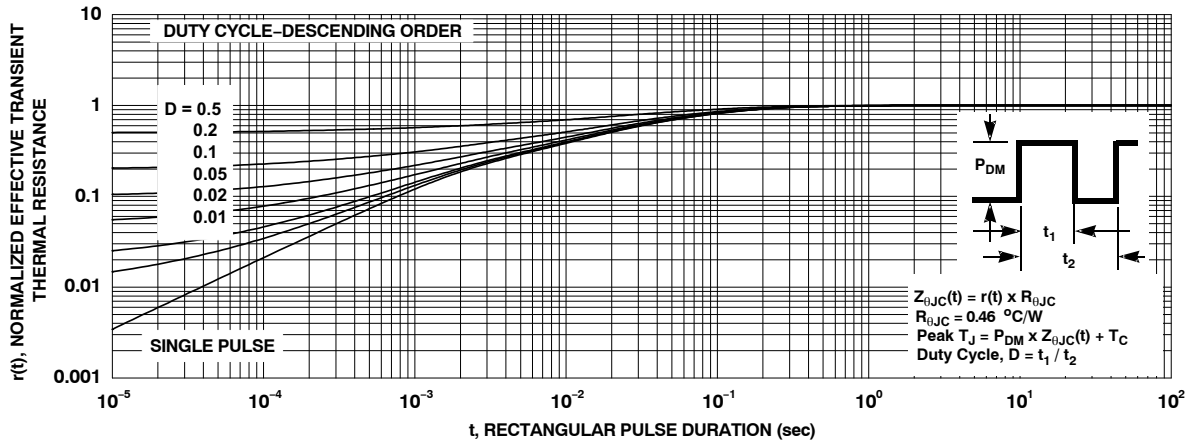

Figure 12. Transient Thermal Response Curve

NTB095N65S3HF

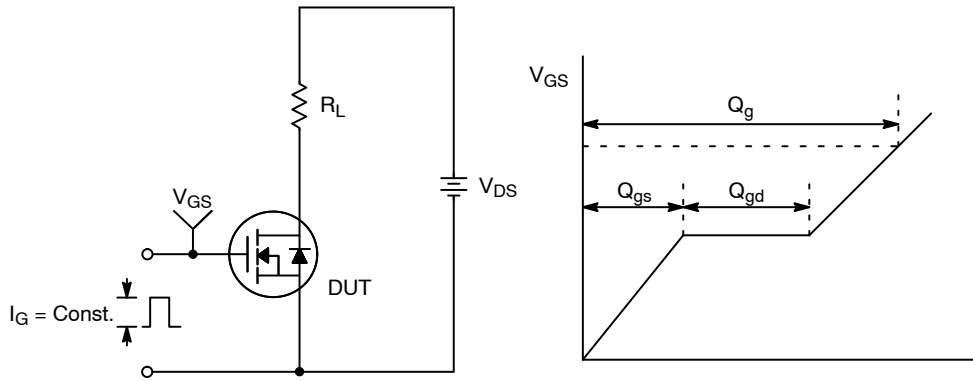

Figure 13. Gate Charge Test Circuit & Waveform

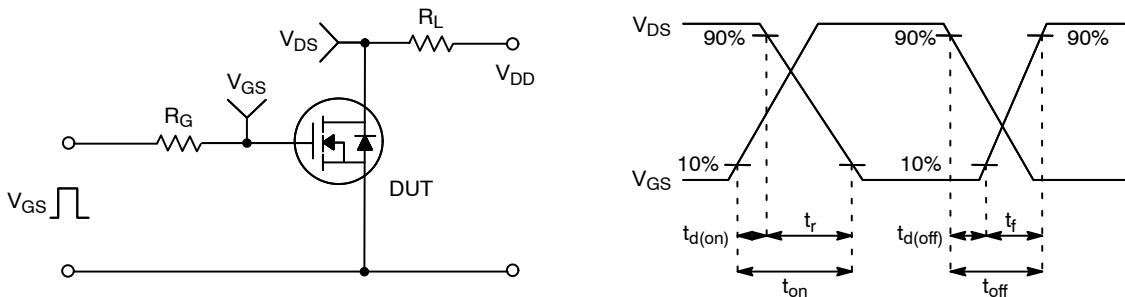

Figure 14. Resistive Switching Test Circuit & Waveforms

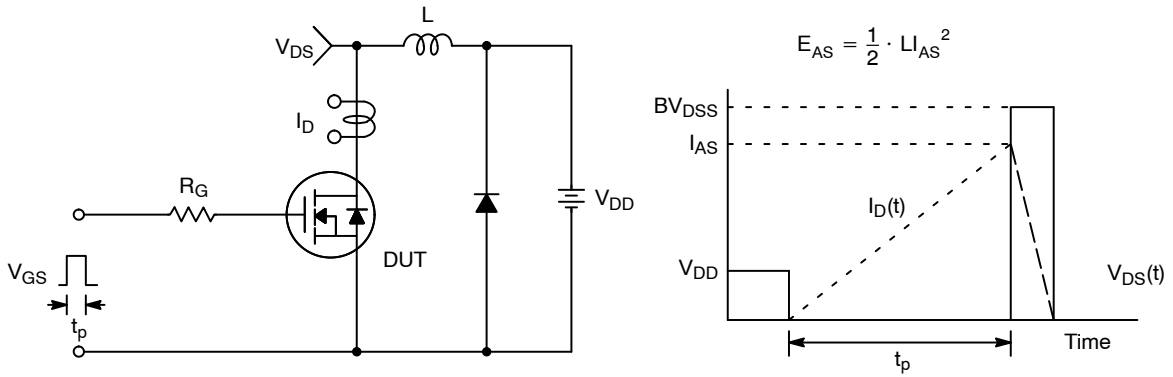

Figure 15. Unclamped Inductive Switching Test Circuit & Waveforms

NTB095N65S3HF

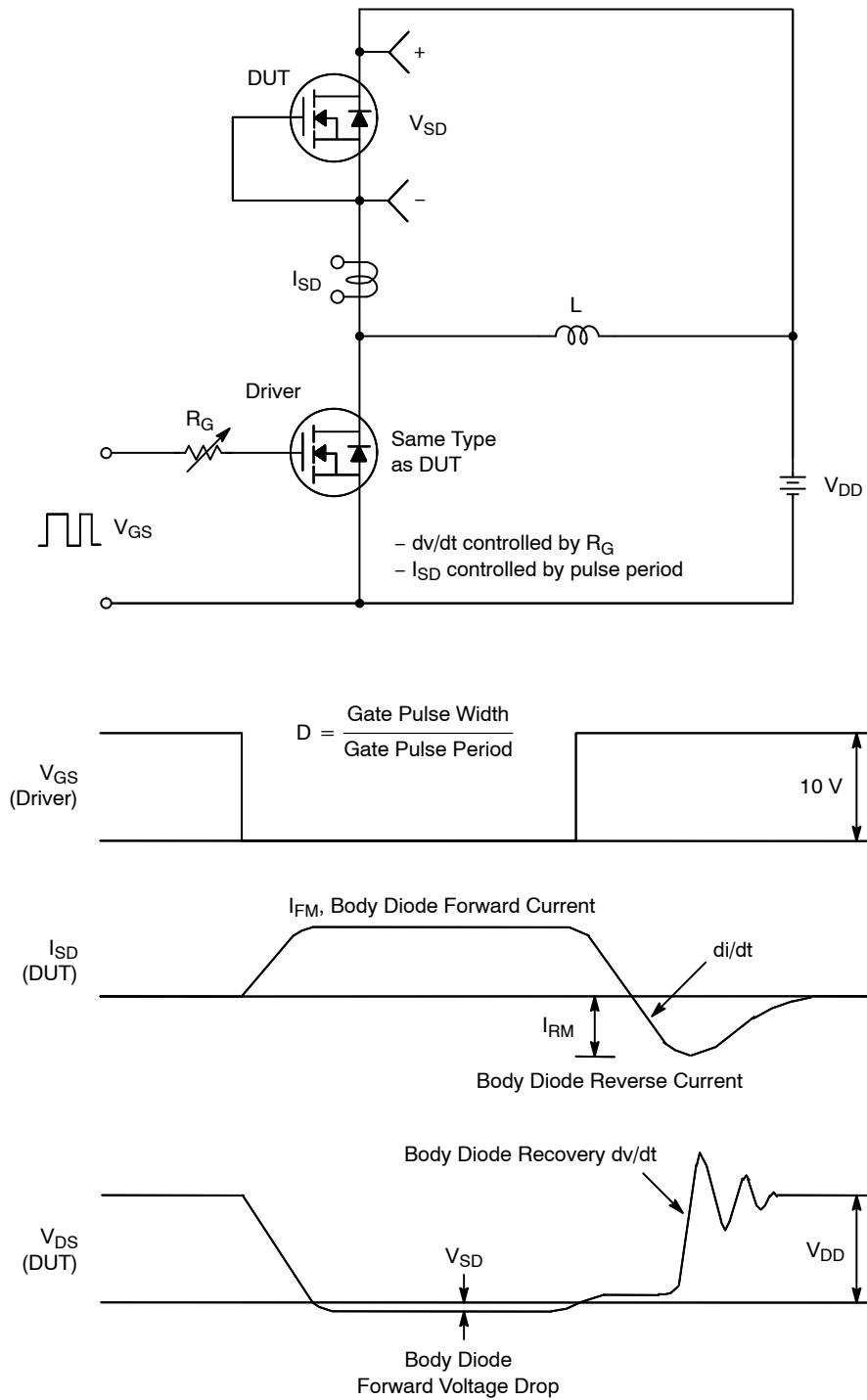
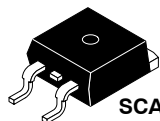

Figure 16. Peak Diode Recovery dv/dt Test Circuit & Waveforms

MECHANICAL CASE OUTLINE

PACKAGE DIMENSIONS

ON Semiconductor®



SCALE 1:1

D²PAK-3 (TO-263, 3-LEAD)

CASE 418AJ

ISSUE F

DATE 11 MAR 2021

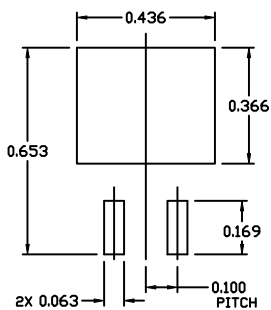

RECOMMENDED MOUNTING FOOTPRINT

For additional information on our Pb-Free strategy and soldering details, please download the ON Semiconductor Soldering and Mounting Techniques Reference Manual, SOLDERRM/D.

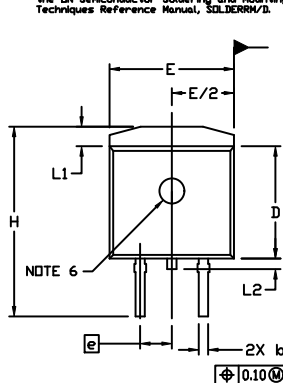

NOTES:

- DIMENSIONING AND TOLERANCING PER ASME Y14.5M, 2009.
- CONTROLLING DIMENSION: INCHES
- CHAMFER OPTIONAL.
- DIMENSIONS D AND E DO NOT INCLUDE MOLD FLASH. MOLD FLASH SHALL NOT EXCEED 0.005 PER SIDE. THESE DIMENSIONS ARE MEASURED AT THE OUTERMOST EXTREMES OF THE PLASTIC BODY AT DATUM H.
- THERMAL PAD CONTOUR IS OPTIONAL WITHIN DIMENSIONS E, L1, D1, AND E1.
- OPTIONAL MOLD FEATURE.
- ①, ② ... OPTIONAL CONSTRUCTION FEATURE CALL OUTS.

DIM	INCHES		MILLIMETERS	
	MIN.	MAX.	MIN.	MAX.
A	0.160	0.190	4.06	4.83
A1	0.000	0.010	0.00	0.25
b	0.020	0.039	0.51	0.99
c	0.012	0.029	0.30	0.74
c2	0.045	0.065	1.14	1.65
D	0.330	0.380	8.38	9.65
D1	0.260	---	6.60	---
E	0.380	0.420	9.65	10.67
E1	0.245	---	6.22	---
e	0.100	BSC	2.54	BSC
H	0.575	0.625	14.60	15.88
L	0.070	0.110	1.78	2.79
L1	---	0.066	---	1.68
L2	---	0.070	---	1.78
L3	0.010	BSC	0.25	BSC
M	0*	8*	0*	8*

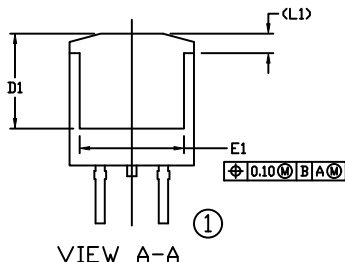
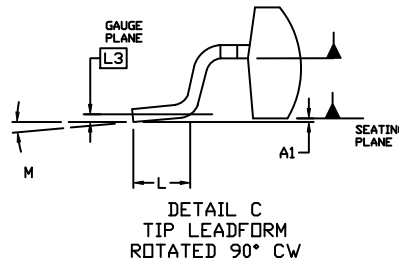
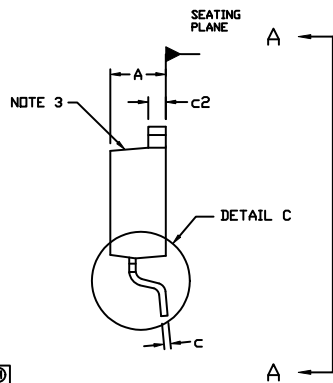

VIEW A-A

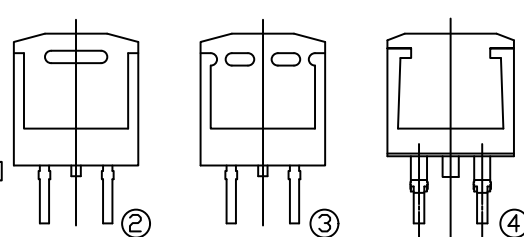

VIEW A-A
OPTIONAL CONSTRUCTIONS

GENERIC MARKING DIAGRAMS*

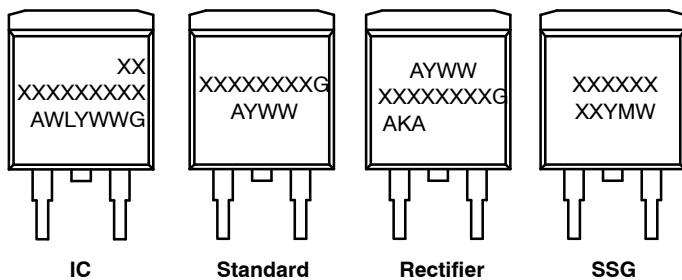

IC

Standard

Rectifier

SSG

- XXXXXX = Specific Device Code
- A = Assembly Location
- WL = Wafer Lot
- Y = Year
- WW = Work Week
- W = Week Code (SSG)
- M = Month Code (SSG)
- G = Pb-Free Package
- AKA = Polarity Indicator

*This information is generic. Please refer to device data sheet for actual part marking. Pb-Free indicator, "G" or microdot "▪", may or may not be present. Some products may not follow the Generic Marking.

DOCUMENT NUMBER:	98AON56370E	Electronic versions are uncontrolled except when accessed directly from the Document Repository. Printed versions are uncontrolled except when stamped "CONTROLLED COPY" in red.
DESCRIPTION:	D²PAK-3 (TO-263, 3-LEAD)	PAGE 1 OF 1

ON Semiconductor and ON are trademarks of Semiconductor Components Industries, LLC dba ON Semiconductor or its subsidiaries in the United States and/or other countries. ON Semiconductor reserves the right to make changes without further notice to any products herein. ON Semiconductor makes no warranty, representation or guarantee regarding the suitability of its products for any particular purpose, nor does ON Semiconductor assume any liability arising out of the application or use of any product or circuit, and specifically disclaims any and all liability, including without limitation special, consequential or incidental damages. ON Semiconductor does not convey any license under its patent rights nor the rights of others.

ON Semiconductor and  are trademarks of Semiconductor Components Industries, LLC dba ON Semiconductor or its subsidiaries in the United States and/or other countries. ON Semiconductor owns the rights to a number of patents, trademarks, copyrights, trade secrets, and other intellectual property. A listing of ON Semiconductor's product/patent coverage may be accessed at www.onsemi.com/site/pdf/Patent-Marking.pdf. ON Semiconductor reserves the right to make changes without further notice to any products herein. ON Semiconductor makes no warranty, representation or guarantee regarding the suitability of its products for any particular purpose, nor does ON Semiconductor assume any liability arising out of the application or use of any product or circuit, and specifically disclaims any and all liability, including without limitation special, consequential or incidental damages. Buyer is responsible for its products and applications using ON Semiconductor products, including compliance with all laws, regulations and safety requirements or standards, regardless of any support or applications information provided by ON Semiconductor. "Typical" parameters which may be provided in ON Semiconductor data sheets and/or specifications can and do vary in different applications and actual performance may vary over time. All operating parameters, including "Typicals" must be validated for each customer application by customer's technical experts. ON Semiconductor does not convey any license under its patent rights nor the rights of others. ON Semiconductor products are not designed, intended, or authorized for use as a critical component in life support systems or any FDA Class 3 medical devices or medical devices with a same or similar classification in a foreign jurisdiction or any devices intended for implantation in the human body. Should Buyer purchase or use ON Semiconductor products for any such unintended or unauthorized application, Buyer shall indemnify and hold ON Semiconductor and its officers, employees, subsidiaries, affiliates, and distributors harmless against all claims, costs, damages, and expenses, and reasonable attorney fees arising out of, directly or indirectly, any claim of personal injury or death associated with such unintended or unauthorized use, even if such claim alleges that ON Semiconductor was negligent regarding the design or manufacture of the part. ON Semiconductor is an Equal Opportunity/Affirmative Action Employer. This literature is subject to all applicable copyright laws and is not for resale in any manner.

PUBLICATION ORDERING INFORMATION

LITERATURE FULFILLMENT:

Email Requests to: orderlit@onsemi.com

ON Semiconductor Website: www.onsemi.com

TECHNICAL SUPPORT

North American Technical Support:
Voice Mail: 1 800-282-9855 Toll Free USA/Canada
Phone: 011 421 33 790 2910

Europe, Middle East and Africa Technical Support:

Phone: 00421 33 790 2910

For additional information, please contact your local Sales Representative