

NHPM260T3G, NRVHPM260T3G

Surface Mount Ultra Fast Power Rectifier

POWERMITE® Power Surface Mount Package

The ultrafast Powermite® provides soft recovery fast switching performance in a compact thermally efficient package. The advanced packaging techniques provide for a very efficient micro–miniature space–saving surface mount rectifier. With its unique heatsink design, the Powermite® offers thermal performance similar to the SMA while being 50% smaller in footprint area.

Features

- Fast Soft Switching for Reduced EMI and Higher Efficiency
- Low Profile – Maximum Height of 1.1 mm
- Small Footprint – Footprint Area of 8.45 mm²
- Supplied in 12 mm Tape and Reel
- Low Thermal Resistance with Direct Thermal Path of Die on Exposed Cathode Heat Sink
- These Devices are Pb–Free, Halogen Free and are RoHS Compliant

Mechanical Characteristics:

- Powermite® is JEDEC Registered as D0–216AA
- Case: Molded Epoxy
- Epoxy Meets UL 94 V–0 @ 0.125 in
- Weight: 16.3 mg (Approximately)
- Lead and Mounting Surface Temperature for Soldering Purposes: 260°C Maximum for 10 Seconds
- MSL 1

Applications

- Automotive HID Lighting
- Diesel Piezo Injection
- Power Factor Correction in Mini Adapters
- Freewheeling Diode Where Space is at a Premium



ON Semiconductor®

www.onsemi.com

**ULTRA FAST
RECTIFIER
2.0 AMPERES, 600 VOLTS**

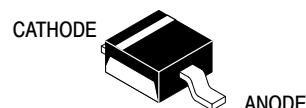

**POWERMITE
CASE 457**

MARKING DIAGRAM

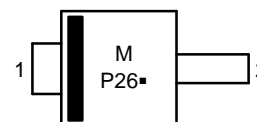

M = Date Code
P26 = Device Code
■ = Pb–Free Package

ORDERING INFORMATION

Device	Package	Shipping†
NHPM260T3G	Powermite (Pb–Free)	12000/Tape & Reel
NRVHPM260T3G	Powermite (Pb–Free)	12000/Tape & Reel

†For information on tape and reel specifications, including part orientation and tape sizes, please refer to our Tape and Reel Packaging Specifications Brochure, BRD8011/D.

NHPM260T3G, NRVHPM260T3G

MAXIMUM RATINGS

Rating	Symbol	Value	Unit
Peak Repetitive Reverse Voltage Working Peak Reverse Voltage DC Blocking Voltage	V_{RRM} V_{RWM} V_R	600	V
Average Rectified Forward Current ($T_L = 145^\circ\text{C}$)	I_O	2.0	A
Peak Repetitive Forward Current (Square Wave, 20 kHz, $T_L = 125^\circ\text{C}$)	I_{FRM}	4.0	A
Non-Repetitive Peak Surge Current (Surge Applied at Rated Load Conditions Halfwave, Single Phase, 60 Hz)	I_{FSM}	15	A
Storage and Operating Junction Temperature Range (Note 1)	T_{stg}, T_J	-65 to +175	$^\circ\text{C}$

Stresses exceeding those listed in the Maximum Ratings table may damage the device. If any of these limits are exceeded, device functionality should not be assumed, damage may occur and reliability may be affected.

1. The heat generated must be less than the thermal conductivity from Junction-to-Ambient: $dP_D/dT_J < 1/R_{\theta JA}$.

THERMAL CHARACTERISTICS

Characteristic	Symbol	Value	Unit
Thermal Resistance, Junction-to-Lead (Note 2)	Ψ_{JCL}	8.5	$^\circ\text{C/W}$
Thermal Resistance, Junction-to-Ambient (Note 2)	$R_{\theta JA}$	82.9	$^\circ\text{C/W}$
Thermal Resistance, Junction-to-Ambient (Note 3)	$R_{\theta JA}$	260	$^\circ\text{C/W}$

ELECTRICAL CHARACTERISTICS

Characteristic	Test Conditions	Symbol	Typ	Max	Unit
Instantaneous Forward Voltage (Note 4)	($I_F = 2\text{ A}$, $T_C = 125^\circ\text{C}$) ($I_F = 2\text{ A}$, $T_C = 25^\circ\text{C}$)	V_F	2.1 3.0	2.6 3.8	V
Instantaneous Reverse Current (Note 4)	(Rated DC Voltage, $T_C = 125^\circ\text{C}$) (Rated DC Voltage, $T_C = 25^\circ\text{C}$)	I_R	5.0 0.002	50 0.5	μA
Reverse Recovery Time Peak Reverse Recovery Current Total Reverse Recovery Charge Softness Factor	($I_F = 2\text{ A}$, $dI_F/dt = -200\text{ A}/\mu\text{s}$, $T_C = 25^\circ\text{C}$)	t_{rr} I_{RM} Q_{rr} S	15 0.5 2.1 0.8	30 3.0 10 3.0	ns A nC -
Reverse Recovery Time Peak Reverse Recovery Current Total Reverse Recovery Charge Softness Factor	($I_F = 2\text{ A}$, $dI_F/dt = -200\text{ A}/\mu\text{s}$, $T_C = 125^\circ\text{C}$)	t_{rr} I_{RM} Q_{rr} S	30 0.7 12 2.4	- - - -	ns A nC -

Product parametric performance is indicated in the Electrical Characteristics for the listed test conditions, unless otherwise noted. Product performance may not be indicated by the Electrical Characteristics if operated under different conditions.

2. Mounted with 700 mm² copper pad size (Approximately 1 in²) 1 oz FR4 Board.

3. Mounted with pad size approximately 20 mm² copper, 1 oz FR4 Board.

4. Pulse Test: Pulse Width $\leq 380\ \mu\text{s}$, Duty Cycle $\leq 2.0\%$.

NHPM260T3G, NRVHPM260T3G

TYPICAL CHARACTERISTICS

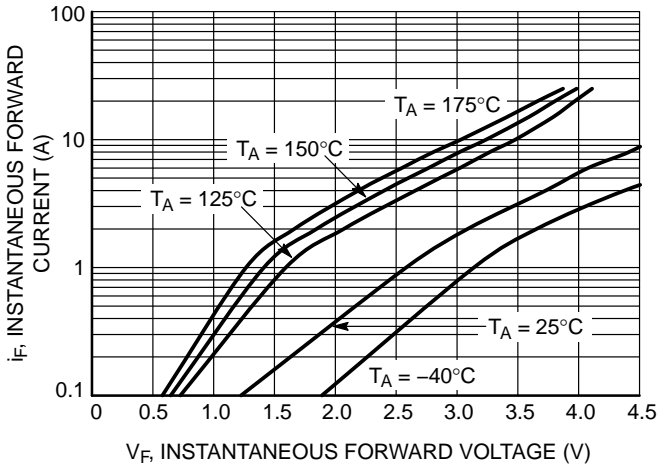

Figure 1. Typical Instantaneous Forward Characteristics

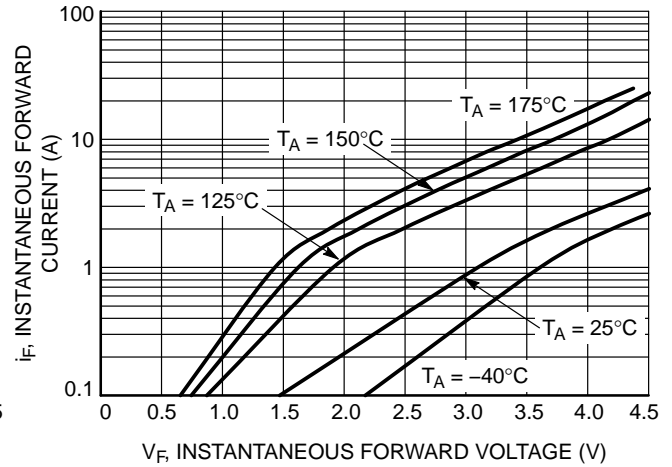

Figure 2. Maximum Instantaneous Forward Characteristics

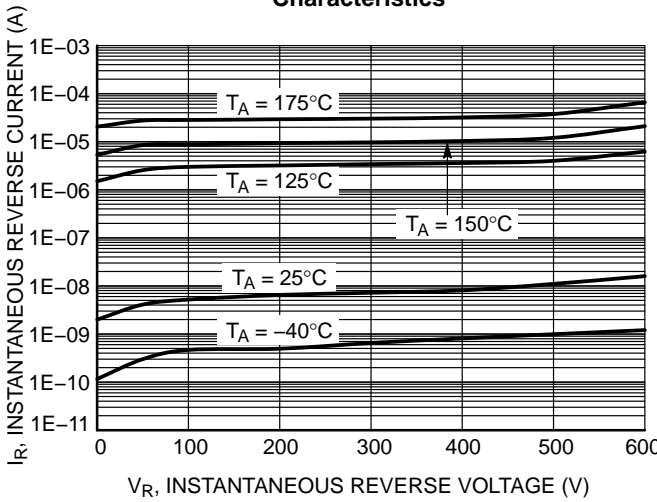

Figure 3. Typical Reverse Characteristics

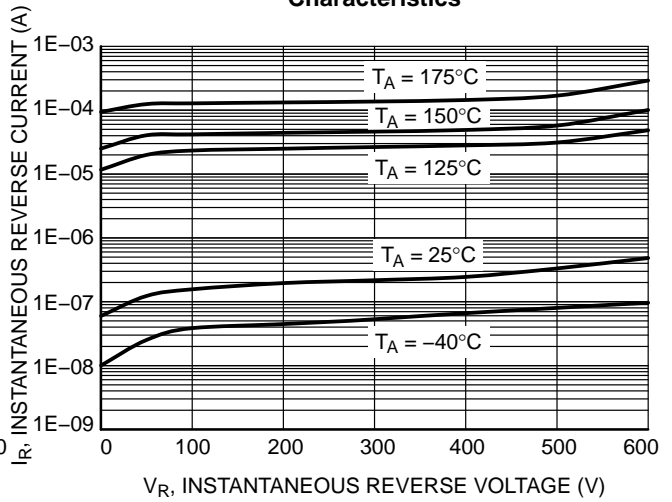

Figure 4. Maximum Reverse Characteristics

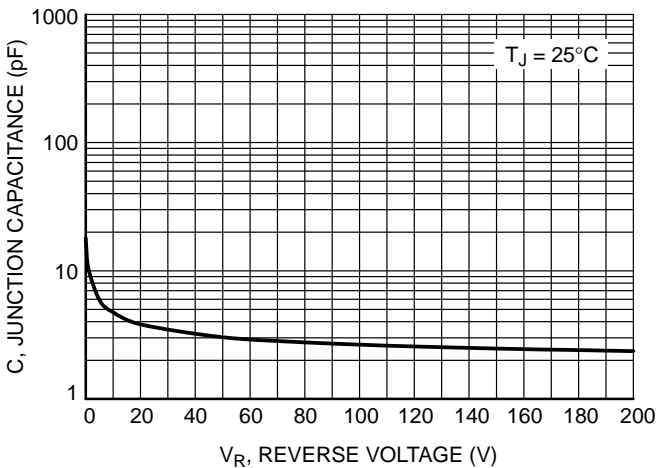

Figure 5. Typical Junction Capacitance

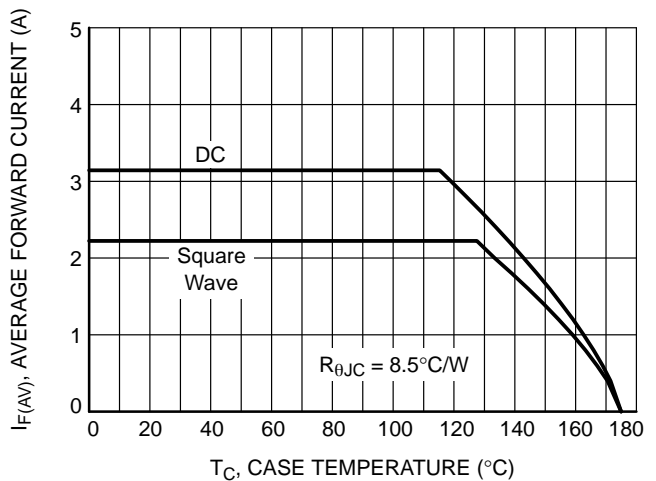

Figure 6. Current Derating

NHPM260T3G, NRVHPM260T3G

TYPICAL CHARACTERISTICS

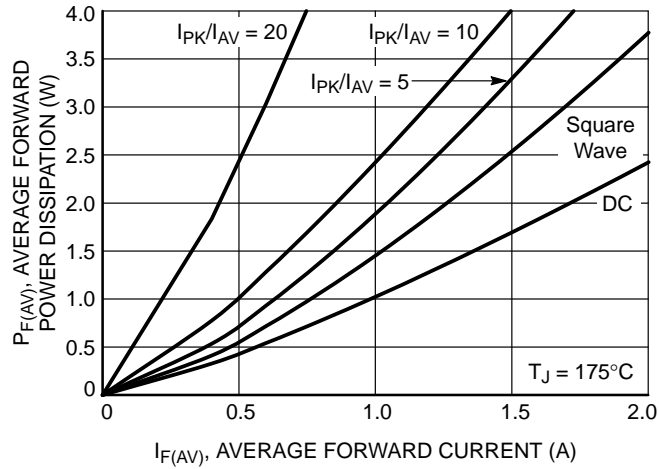

Figure 7. Forward Power Dissipation

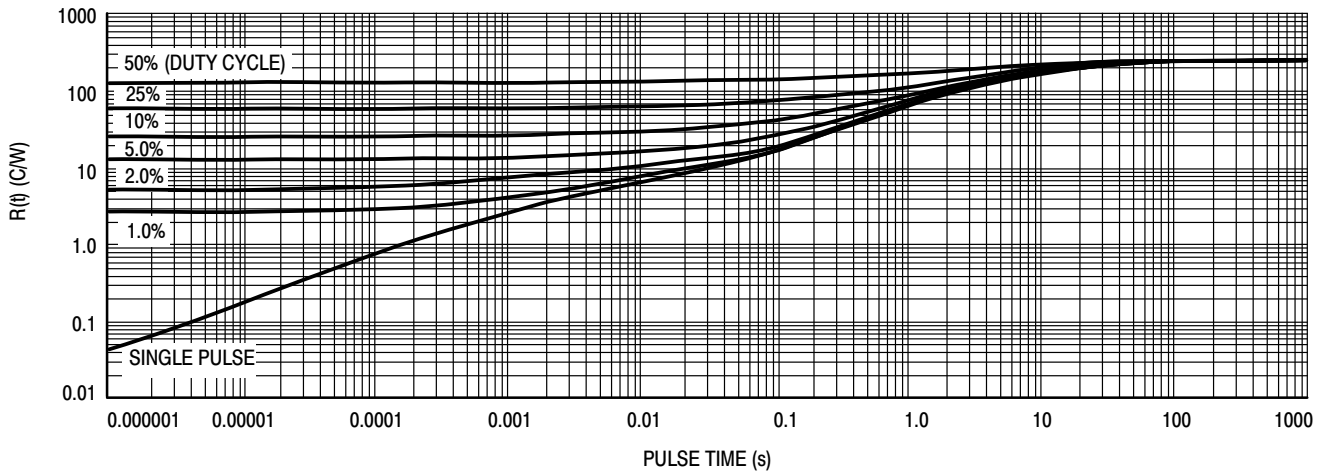

Figure 8. Thermal Response, Junction-to-Ambient (20 mm² pad)

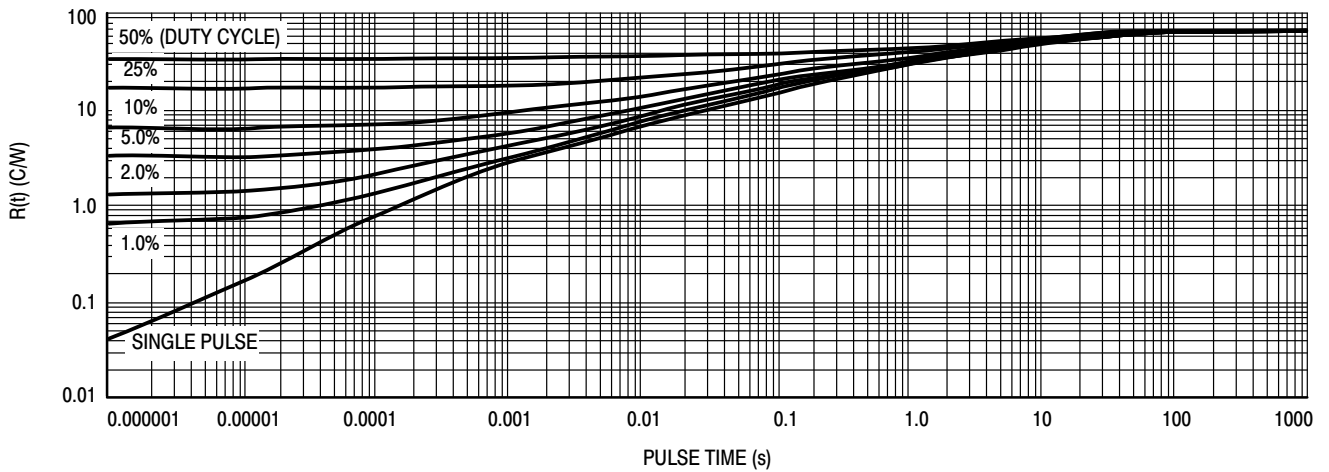
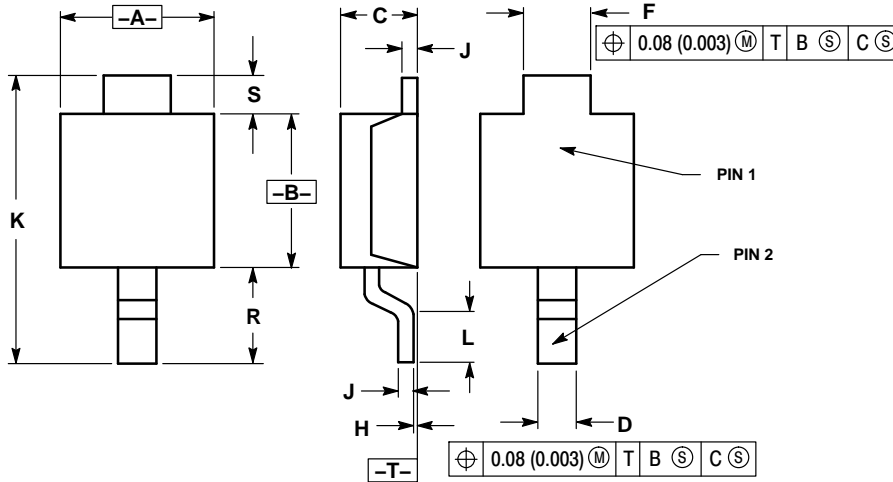

Figure 9. Thermal Response, Junction-to-Ambient (1 in² pad)

NHPM260T3G, NRVHPM260T3G

PACKAGE DIMENSIONS

POWERMITE CASE 457-04 ISSUE F



NOTES:

1. DIMENSIONING AND TOLERANCING PER ANSI Y14.5M, 1982.
2. CONTROLLING DIMENSION: MILLIMETER.
3. DIMENSIONS A AND B DO NOT INCLUDE MOLD FLASH, PROTRUSIONS OR GATE BURRS. MOLD FLASH, PROTRUSIONS OR GATE BURRS SHALL NOT EXCEED 0.15 (0.006) PER SIDE.

DIM	MILLIMETERS		INCHES	
	MIN	MAX	MIN	MAX
A	1.75	2.05	0.069	0.081
B	1.75	2.18	0.069	0.086
C	0.85	1.15	0.033	0.045
D	0.40	0.69	0.016	0.027
F	0.70	1.00	0.028	0.039
H	-0.05	+0.10	-0.002	+0.004
J	0.10	0.25	0.004	0.010
K	3.60	3.90	0.142	0.154
L	0.50	0.80	0.020	0.031
R	1.20	1.50	0.047	0.059
S	0.50 REF		0.019 REF	

SOLDERING FOOTPRINT*

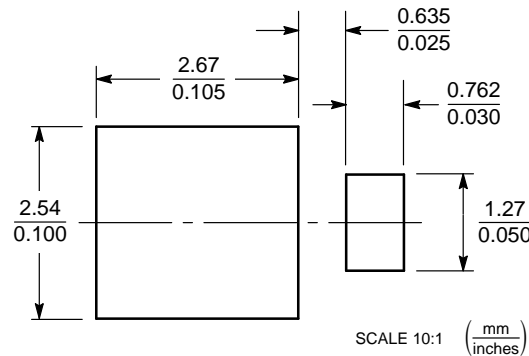

*For additional information on our Pb-Free strategy and soldering details, please download the ON Semiconductor Soldering and Mounting Techniques Reference Manual, SOLDERRM/D.

POWERMITE is a registered trademark of and used under a license from Microsemi Corporation.

ON Semiconductor and the are registered trademarks of Semiconductor Components Industries, LLC (SCILLC) or its subsidiaries in the United States and/or other countries. SCILLC owns the rights to a number of patents, trademarks, copyrights, trade secrets, and other intellectual property. A listing of SCILLC's product/patent coverage may be accessed at www.onsemi.com/site/pdf/Patent-Marking.pdf. SCILLC reserves the right to make changes without further notice to any products herein. SCILLC makes no warranty, representation or guarantee regarding the suitability of its products for any particular purpose, nor does SCILLC assume any liability arising out of the application or use of any product or circuit, and specifically disclaims any and all liability, including without limitation special, consequential or incidental damages. "Typical" parameters which may be provided in SCILLC data sheets and/or specifications can and do vary in different applications and actual performance may vary over time. All operating parameters, including "Typicals" must be validated for each customer application by customer's technical experts. SCILLC does not convey any license under its patent rights nor the rights of others. SCILLC products are not designed, intended, or authorized for use as components in systems intended for surgical implant into the body, or other applications intended to support or sustain life, or for any other application in which the failure of the SCILLC product could create a situation where personal injury or death may occur. Should Buyer purchase or use SCILLC products for any such unintended or unauthorized application, Buyer shall indemnify and hold SCILLC and its officers, employees, subsidiaries, affiliates, and distributors harmless against all claims, costs, damages, and expenses, and reasonable attorney fees arising out of, directly or indirectly, any claim of personal injury or death associated with such unintended or unauthorized use, even if such claim alleges that SCILLC was negligent regarding the design or manufacture of the part. SCILLC is an Equal Opportunity/Affirmative Action Employer. This literature is subject to all applicable copyright laws and is not for resale in any manner.

PUBLICATION ORDERING INFORMATION

LITERATURE FULFILLMENT:
Literature Distribution Center for ON Semiconductor
19521 E. 32nd Pkwy, Aurora, Colorado 80011 USA
Phone: 303-675-2175 or 800-344-3860 Toll Free USA/Canada
Fax: 303-675-2176 or 800-344-3867 Toll Free USA/Canada
Email: orderlit@onsemi.com

N. American Technical Support: 800-282-9855 Toll Free
USA/Canada
Europe, Middle East and Africa Technical Support:
Phone: 421 33 790 2910
Japan Customer Focus Center
Phone: 81-3-5817-1050

ON Semiconductor Website: www.onsemi.com
Order Literature: <http://www.onsemi.com/orderlit>

For additional information, please contact your local Sales Representative