

# Zener Diodes

## MM3Z2V4C - MM3Z75VC

### Features

- Wide Zener Voltage Range Selection, 2.4 V to 75 V
- VZ Tolerance Selection of  $\pm 5\%$  (C Series)
- Very Small and Thin SMD Package
- Matte Tin(Sn) Finish
- These Devices are Pb-Free and are RoHS Compliant

### ABSOLUTE MAXIMUM RATINGS ( $T_A = 25^\circ\text{C}$ unless otherwise noted)

Symbol	Parameter	Value	Units
$P_D$	Power Dissipation	200	mW
$T_{STG}$	Storage Temperature Range	-65 to +150	$^\circ\text{C}$
$T_J$	Maximum Junction Temperature	150	$^\circ\text{C}$
$I_{ZM}$	Maximum Regulator Current	$P_D/V_Z$	mA

Stresses exceeding those listed in the Maximum Ratings table may damage the device. If any of these limits are exceeded, device functionality should not be assumed, damage may occur and reliability may be affected.

### THERMAL CHARACTERISTICS

Symbol	Parameter	Value	Units
$R_{\theta JA}$	Thermal Resistance, Junction to Ambient	595	$^\circ\text{C}/\text{W}$

NOTE: Device mounted on PCB with minimum land pad.

### ELECTRICAL CHARACTERISTICS

( $T_A = 25^\circ\text{C}$  unless otherwise specified)

Symbol	Parameter	Min	Typ	Max	Units
$V_F$	Forward Voltage / $I_F = 10\text{ mA}$	-	-	1.0	V

Product parametric performance is indicated in the Electrical Characteristics for the listed test conditions, unless otherwise noted. Product performance may not be indicated by the Electrical Characteristics if operated under different conditions.



**ON Semiconductor**<sup>®</sup>

[www.onsemi.com](http://www.onsemi.com)

### CONNECTION DIAGRAM

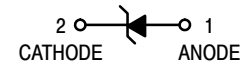

**SOD-323FL**  
**CASE 477AB**

### MARKING DIAGRAM



(Band Denotes Cathode)  
X = Specific Device Code  
M = Date Code

### ORDERING INFORMATION

Device	Package	Shipping†
Refer to Product Table List	SOD-323FL (Pb-Free)	3,000 / Tape & Reel

†For information on tape and reel specifications, including part orientation and tape sizes, please refer to our Tape and Reel Packaging Specifications Brochure, BRD8011/D.

## MM3Z2V4C – MM3Z75VC

### ELECTRICAL CHARACTERISTICS (T<sub>A</sub> = 25°C unless otherwise noted)

Device Type	Device Marking	V <sub>Z</sub> (V) @ I <sub>ZT</sub>			Z <sub>ZT</sub> (Ω) @ I <sub>ZT</sub>	I <sub>ZT</sub> (mA)	Z <sub>ZK</sub> (Ω) @ I <sub>ZK</sub>	I <sub>ZK</sub> (mA)	I <sub>R</sub> (μA) @ V <sub>R</sub>	V <sub>R</sub> (V)
		Min.	Typ.	Max.	Max.	–	Max.	–	Max.	–
MM3Z2V4C	Z0	2.28	2.4	2.52	94	5	564	1	45	1
MM3Z2V7C	Z1	2.57	2.7	2.84	94	5	564	1	18	1
MM3Z3V0C	Z2	2.85	3	3.15	89	5	564	1	9	1
MM3Z3V3C	Z3	3.14	3.3	3.47	89	5	564	1	4.5	1
MM3Z3V6C	Z4	3.42	3.6	3.78	84	5	564	1	4.5	1
MM3Z3V9C	Z5	3.71	3.9	4.1	84	5	564	1	2.7	1
MM3Z4V3C	Z6	4.09	4.3	4.52	84	5	564	1	2.7	1
MM3Z4V7C	Z7	4.47	4.7	4.94	75	5	470	1	2.7	2
MM3Z5V1C	Z8	4.85	5.1	5.36	56	5	451	1	1.8	2
MM3Z5V6C	Z9	5.32	5.6	5.88	37	5	376	1	0.9	2
MM3Z6V2C	ZA	5.89	6.2	6.51	9	5	141	1	2.7	4
MM3Z6V8C	ZB	6.46	6.8	7.14	14	5	75	1	1.8	4
MM3Z7V5C	ZC	7.11	7.5	7.86	14	5	75	1	0.9	5
MM3Z8V2C	ZD	7.79	8.2	8.61	14	5	75	1	0.63	5
MM3Z9V1C	ZE	8.65	9.1	9.56	14	5	94	1	0.45	6
MM3Z10VC	ZF	9.5	10	10.5	18	5	141	1	0.18	7
MM3Z11VC	ZG	10.45	11	11.55	18	5	141	1	0.09	8
MM3Z12VC	ZH	11.4	12	12.6	23	5	141	1	0.09	8
MM3Z13VC	ZJ	12.35	13	13.65	28	5	160	1	0.09	8
MM3Z15VC	ZK	14.25	15	15.75	28	5	188	1	0.045	10.5
MM3Z16VC	ZL	15.2	16	16.8	37	5	188	1	0.045	11.2
MM3Z18VC	ZM	17.1	18	18.9	42	5	212	1	0.045	12.6
MM3Z20VC	ZN	19	20	21	51	5	212	1	0.045	14
MM3Z22VC	ZP	20.9	22	23.1	51	5	235	1	0.045	15.4
MM3Z24VC	ZR	22.8	24	25.2	65	5	235	1	0.045	16.8
MM3Z27VC	ZS	25.65	27	28.35	75	2	282	0.5	0.045	18.9
MM3Z30VC	ZT	28.5	30	31.5	75	2	282	0.5	0.045	21
MM3Z33VC	ZU	31.35	33	34.65	75	2	306	0.5	0.045	23
MM3Z36VC	ZV	34.2	36	37.8	84	2	329	0.5	0.045	25.2
MM3Z39VC	ZW	37.05	39	40.95	122	2	329	0.5	0.045	27.3
MM3Z43VC	ZX	40.85	43	45.15	141	2	353	0.5	0.045	30.1
MM3Z47VC	ZY	44.65	47	49.35	160	2	353	0.5	0.045	33
MM3Z51VC	Z <sub>-</sub>	48.45	51	53.55	169	2	376	0.5	0.045	35.7
MM3Z56VC	Z <sub>=</sub>	53.2	56	58.8	188	2	400	0.5	0.045	39.2
MM3Z62VC	Z <sub>=</sub>	58.9	62	65.1	202	2	423	0.5	0.045	43.4
MM3Z68VC	Z <sub>&gt;</sub>	64.6	68	71.4	226	2	447	0.5	0.045	47.6
MM3Z75VC	Z <sub>&lt;</sub>	71.25	75	78.75	240	2	470	0.5	0.045	52.5

Product parametric performance is indicated in the Electrical Characteristics for the listed test conditions, unless otherwise noted. Product performance may not be indicated by the Electrical Characteristics if operated under different conditions.

1. The Zener Voltage (V<sub>Z</sub>) is tested under pulse condition of 10 ms.
2. The device numbers listed have a standard tolerance on the nominal zener voltage of ±5%.
3. The zener impedance is derived from the 60-cycle ac voltage, which results when an ac current having an rms value equal to 10% of the dc zener current (I<sub>ZT</sub> or I<sub>ZK</sub>) is superimposed to I<sub>ZT</sub> or I<sub>ZK</sub>.

# MM3Z2V4C – MM3Z75VC

## TYPICAL PERFORMANCE CHARACTERISTICS

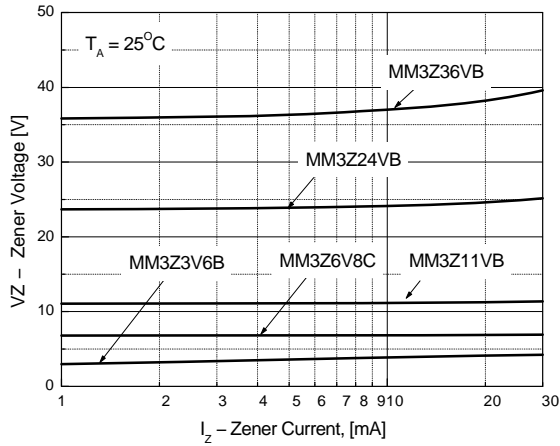

Figure 1. Zener Current vs. Zener Voltage

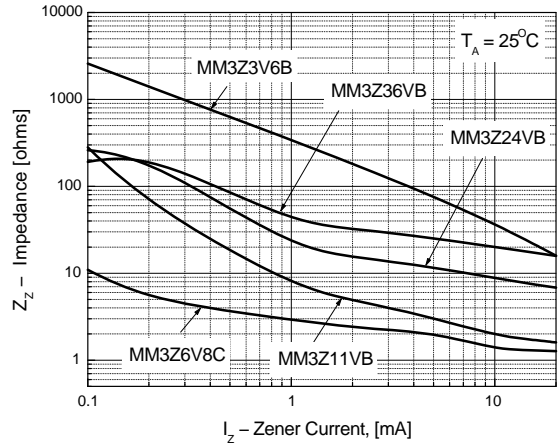

Figure 2. Zener Current vs. Zener Impedance

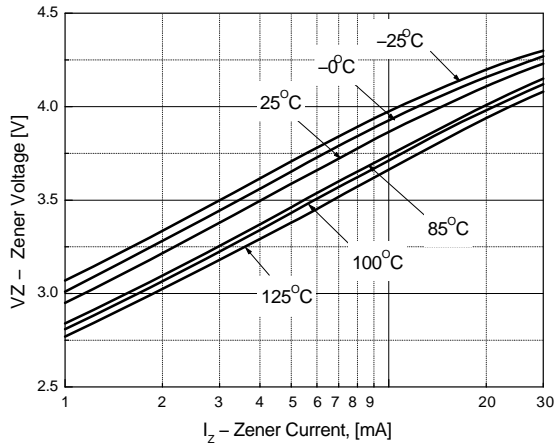

Figure 3. MM3Z3V6B  
Zener Current vs. Zener Voltage

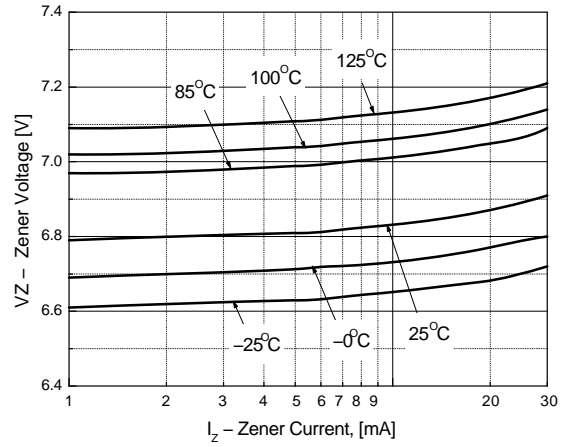

Figure 4. MM3Z6V8B  
Zener Current vs. Zener Voltage

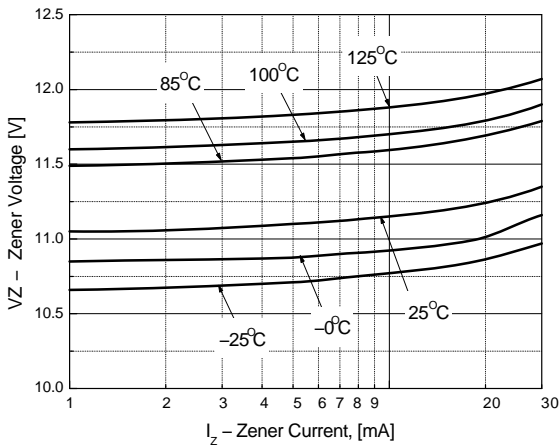

Figure 5. MM3Z11VB  
Zener Current vs. Zener Voltage

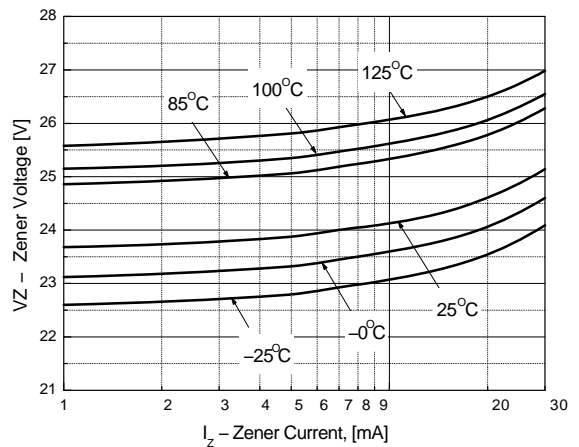
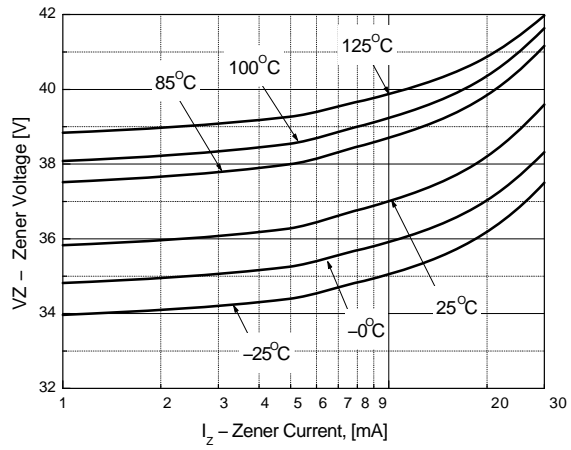

Figure 6. MM3Z24VB  
Zener Current vs. Zener Voltage

# MM3Z2V4C – MM3Z75VC

## TYPICAL PERFORMANCE CHARACTERISTICS

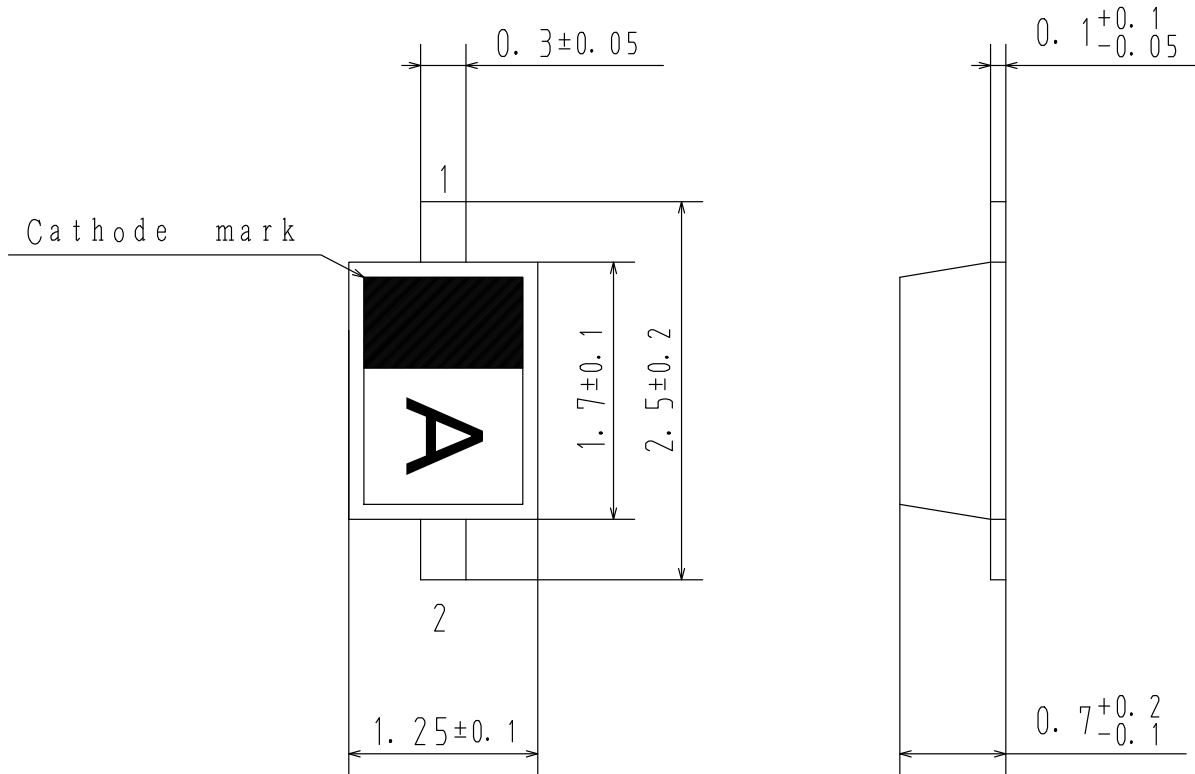

**Figure 7. MM3Z36VB**  
**Zener Current vs. Zener Voltage**

**MECHANICAL CASE OUTLINE**  
**PACKAGE DIMENSIONS**

SOD-323FL  
CASE 477AB  
ISSUE 0

DATE 30 APR 2012



<b>DOCUMENT NUMBER:</b>	<b>98AON79864E</b>	Electronic versions are uncontrolled except when accessed directly from the Document Repository. Printed versions are uncontrolled except when stamped "CONTROLLED COPY" in red.
<b>DESCRIPTION:</b>	<b>SOD-323FL</b>	<b>PAGE 1 OF 1</b>

ON Semiconductor and  are trademarks of Semiconductor Components Industries, LLC dba ON Semiconductor or its subsidiaries in the United States and/or other countries. ON Semiconductor reserves the right to make changes without further notice to any products herein. ON Semiconductor makes no warranty, representation or guarantee regarding the suitability of its products for any particular purpose, nor does ON Semiconductor assume any liability arising out of the application or use of any product or circuit, and specifically disclaims any and all liability, including without limitation special, consequential or incidental damages. ON Semiconductor does not convey any license under its patent rights nor the rights of others.

**onsemi**, **Onsemi**, and other names, marks, and brands are registered and/or common law trademarks of Semiconductor Components Industries, LLC dba "**onsemi**" or its affiliates and/or subsidiaries in the United States and/or other countries. **onsemi** owns the rights to a number of patents, trademarks, copyrights, trade secrets, and other intellectual property. A listing of **onsemi**'s product/patent coverage may be accessed at [www.onsemi.com/site/pdf/Patent-Marking.pdf](http://www.onsemi.com/site/pdf/Patent-Marking.pdf). **onsemi** reserves the right to make changes at any time to any products or information herein, without notice. The information herein is provided "as-is" and **onsemi** makes no warranty, representation or guarantee regarding the accuracy of the information, product features, availability, functionality, or suitability of its products for any particular purpose, nor does **onsemi** assume any liability arising out of the application or use of any product or circuit, and specifically disclaims any and all liability, including without limitation special, consequential or incidental damages. Buyer is responsible for its products and applications using **onsemi** products, including compliance with all laws, regulations and safety requirements or standards, regardless of any support or applications information provided by **onsemi**. "Typical" parameters which may be provided in **onsemi** data sheets and/or specifications can and do vary in different applications and actual performance may vary over time. All operating parameters, including "Typicals" must be validated for each customer application by customer's technical experts. **onsemi** does not convey any license under any of its intellectual property rights nor the rights of others. **onsemi** products are not designed, intended, or authorized for use as a critical component in life support systems or any FDA Class 3 medical devices or medical devices with a same or similar classification in a foreign jurisdiction or any devices intended for implantation in the human body. Should Buyer purchase or use **onsemi** products for any such unintended or unauthorized application, Buyer shall indemnify and hold **onsemi** and its officers, employees, subsidiaries, affiliates, and distributors harmless against all claims, costs, damages, and expenses, and reasonable attorney fees arising out of, directly or indirectly, any claim of personal injury or death associated with such unintended or unauthorized use, even if such claim alleges that **onsemi** was negligent regarding the design or manufacture of the part. **onsemi** is an Equal Opportunity/Affirmative Action Employer. This literature is subject to all applicable copyright laws and is not for resale in any manner.

## PUBLICATION ORDERING INFORMATION

### LITERATURE FULFILLMENT:

Email Requests to: [orderlit@onsemi.com](mailto:orderlit@onsemi.com)

**onsemi Website:** [www.onsemi.com](http://www.onsemi.com)

### TECHNICAL SUPPORT

**North American Technical Support:**

Voice Mail: 1 800-282-9855 Toll Free USA/Canada

Phone: 011 421 33 790 2910

**Europe, Middle East and Africa Technical Support:**

Phone: 00421 33 790 2910

For additional information, please contact your local Sales Representative