



Is Now Part of



ON Semiconductor®

To learn more about ON Semiconductor, please visit our website at
www.onsemi.com

Please note: As part of the Fairchild Semiconductor integration, some of the Fairchild orderable part numbers will need to change in order to meet ON Semiconductor's system requirements. Since the ON Semiconductor product management systems do not have the ability to manage part nomenclature that utilizes an underscore (_), the underscore (_) in the Fairchild part numbers will be changed to a dash (-). This document may contain device numbers with an underscore (_). Please check the ON Semiconductor website to verify the updated device numbers. The most current and up-to-date ordering information can be found at www.onsemi.com. Please email any questions regarding the system integration to Fairchild_questions@onsemi.com.

ON Semiconductor and the ON Semiconductor logo are trademarks of Semiconductor Components Industries, LLC dba ON Semiconductor or its subsidiaries in the United States and/or other countries. ON Semiconductor owns the rights to a number of patents, trademarks, copyrights, trade secrets, and other intellectual property. A listing of ON Semiconductor's product/patent coverage may be accessed at www.onsemi.com/site/pdf/Patent-Marking.pdf. ON Semiconductor reserves the right to make changes without further notice to any products herein. ON Semiconductor makes no warranty, representation or guarantee regarding the suitability of its products for any particular purpose, nor does ON Semiconductor assume any liability arising out of the application or use of any product or circuit, and specifically disclaims any and all liability, including without limitation special, consequential or incidental damages. Buyer is responsible for its products and applications using ON Semiconductor products, including compliance with all laws, regulations and safety requirements or standards, regardless of any support or applications information provided by ON Semiconductor. "Typical" parameters which may be provided in ON Semiconductor data sheets and/or specifications can and do vary in different applications and actual performance may vary over time. All operating parameters, including "Typicals" must be validated for each customer application by customer's technical experts. ON Semiconductor does not convey any license under its patent rights nor the rights of others. ON Semiconductor products are not designed, intended, or authorized for use as a critical component in life support systems or any FDA Class 3 medical devices or medical devices with a same or similar classification in a foreign jurisdiction or any devices intended for implantation in the human body. Should Buyer purchase or use ON Semiconductor products for any such unintended or unauthorized application, Buyer shall indemnify and hold ON Semiconductor and its officers, employees, subsidiaries, affiliates, and distributors harmless against all claims, costs, damages, and expenses, and reasonable attorney fees arising out of, directly or indirectly, any claim of personal injury or death associated with such unintended or unauthorized use, even if such claim alleges that ON Semiconductor was negligent regarding the design or manufacture of the part. ON Semiconductor is an Equal Opportunity/Affirmative Action Employer. This literature is subject to all applicable copyright laws and is not for resale in any manner.

FOD060L, FOD260L

3.3V/5V High Speed-10 MBit/s

Logic Gate Optocouplers

Features

- FOD060L in SO8 and FOD260L in 8-pin DIP
- Very high speed – 10 MBit/s
- Superior CMR — 50 kV/μs at 1,000V peak
- Fan-out of 8 over -40°C to +85°C
- Logic gate output
- Strobable output
- Wired OR-open collector
- Safety and regulatory approvals
 - UL1577
 - DIN EN/IEC 60747-5-2

- Line receiver, data transmission
- Data multiplexing
- Switching power supplies
- Pulse transformer replacement
- Computer-peripheral interface

Description

These optocouplers consist of an AlGaAs LED, optically coupled to a very high speed integrated photo-detector logic gate. Devices include a strobable output. This output features an open collector, thereby permitting wired OR outputs. The coupled parameters are guaranteed over the temperature range of -40°C to +85°C. A maximum input signal of 5 mA will provide a minimum output sink current of 13 mA (fan out of 8). An internal noise shield provides superior common mode rejection of typically 50 kV/μs at 1,000V common mode.

Applications

- Ground loop elimination
- LSTTL to TTL, LSTTL or 5-volt CMOS

Package



Truth Table (Positive Logic)

Input	Enable	Output
On	H	L
Off	H	H
On	L	H
Off	L	H
On*	NC*	L*
Off*	NC*	H*

*Devices with pin 7 not connected.

A 0.1 μF bypass capacitor must be connected between pins 5 and 8. (See Note 1)

Absolute Maximum Ratings (No derating required up to 85°C)

Stresses exceeding the absolute maximum ratings may damage the device. The device may not function or be operable above the recommended operating conditions and stressing the parts to these levels is not recommended. In addition, extended exposure to stresses above the recommended operating conditions may affect device reliability. The absolute maximum ratings are stress ratings only.

Symbol	Parameter	Value	Units
T _{STG}	Storage Temperature	-40 to +125	°C
T _{OPR}	Operating Temperature	-40 to +85	°C
EMITTER			
I _F	DC/Average Forward Input Current	50	mA
V _E	Enable Input Voltage, not to exceed V _{CC} by more than 500 mV	V _{CC} + 0.5V	V
V _R	Reverse Input Voltage	5.0	V
P _I	Power Dissipation	45	mW
DETECTOR			
V _{CC} (1 minute max)	Supply Voltage	7.0	V
I _O	Output Current	50	mA
V _O	Output Voltage	7.0	V
P _O	Collector Output Power Dissipation	85	mW

Recommended Operating Conditions

Symbol	Parameter	Min.	Max.	Units
I _{FL}	Input Current, Low Level	0	250	μA
I _{FH}	Input Current, High Level	*6.3	15	mA
V _{CC}	Supply Voltage, Output	3.0	5.5	V
V _{EL}	Enable Voltage, Low Level	0	0.8	V
V _{EH}	Enable Voltage, High Level	2.0	V _{CC}	V
T _A	Operating Temperature	-40	+85	°C
N	Fan Out (TTL load)		8	
R _L	Output Pull-up Resistor	330	4K	Ω

*6.3 mA is a guard banded value which allows for at least 20% CTR degradation. Initial input current threshold value is 5.0 mA or less.

Electrical Characteristics ($T_A = -40^\circ\text{C}$ to $+85^\circ\text{C}$ unless otherwise specified. Typical value is measured at $T_A = 25^\circ\text{C}$ and $V_{CC} = 3.3\text{V}$)

Individual Component Characteristics

Symbol	Parameter	Test Conditions	Min.	Typ.	Max.	Unit
EMITTER						
V_F	Input Forward Voltage	$I_F = 10\text{ mA}$		1.4	1.8	V
					$T_A = 25^\circ\text{C}$	
B_{VR}	Input Reverse Breakdown Voltage	$I_R = 10\ \mu\text{A}$	5.0			V
C_{IN}	Input Capacitance	$V_F = 0, f = 1\text{ MHz}$		6.0		pF
$\Delta V_F/\Delta T_A$	Input Diode Temperature Coefficient	$I_F = 10\text{ mA}$		-1.9		mV/ $^\circ\text{C}$
DETECTOR						
I_{CCH}	High Level Supply Current	$V_E = 0.5\text{ V}, I_F = 0\text{ mA}, V_{CC} = 3.3\text{ V}$		3.5	7	mA
I_{CCL}	Low Level Supply Current	$V_E = 0.5\text{ V}, I_F = 0\text{ mA}, V_{CC} = 3.3\text{ V}$		3.2	10	mA
I_{EL}	Low Level Enable Current	$V_{CC} = 3.3\text{ V}, V_E = 0.5\text{ V}$			-1.6	mA
I_{EH}	High Level Enable Current	$V_{CC} = 3.3\text{ V}, V_E = 2.0\text{ V}$			-1.6	mA
V_{EH}	High Level Enable Voltage	$V_{CC} = 3.3\text{ V}, I_F = 10\text{ mA}$	2.0	1.27		V
V_{EL}	Low Level Enable Voltage	$V_{CC} = 3.3\text{ V}, I_F = 10\text{ mA}$ (Note 2)		1.18	0.8	V

Switching Characteristics ($T_A = -40^\circ\text{C}$ to $+85^\circ\text{C}$, $V_{CC} = 3.3\text{ V}$, $I_F = 7.5\text{ mA}$ unless otherwise specified. Typical value is measured at $T_A = 25^\circ\text{C}$ and $V_{CC} = 3.3\text{ V}$)

Symbol	AC Characteristics	Test Conditions	Min.	Typ.	Max.	Unit
T_{PLH}	Propagation Delay Time to Output High Level	$R_L = 350\ \Omega, C_L = 15\text{ pF}$ (Fig. 9) (Note 3)		65	90	ns
T_{PHL}	Propagation Delay Time to Output Low Level	$R_L = 350\ \Omega, C_L = 15\text{ pF}$ (Fig. 9) (Note 4)		43	75	ns
$ T_{PHL} - T_{PLH} $	Pulse Width Distortion	$R_L = 350\ \Omega, C_L = 15\text{ pF}$ (Fig. 9)		23	25	ns
t_{PSK}	Propagation Delay Skew	$R_L = 350\ \Omega, C_L = 15\text{ pF}$ (Note 5)		31	40	ns
t_r	Output Rise Time (10-90%)	$R_L = 350\ \Omega, C_L = 15\text{ pF}$ (Fig. 9)(Note 6)		22		ns
t_f	Output Fall Time (90-10%)	$R_L = 350\ \Omega, C_L = 15\text{ pF}$ (Fig. 12) (Note 7)		3		ns
t_{ELH}	Enable Propagation Delay Time to Output High Level	$V_{EH} = 3\text{ V}, R_L = 350\ \Omega, C_L = 15\text{ pF}$ (Fig. 10) (Note 8)		47		ns
t_{EHL}	Enable Propagation Delay Time to Output Low Level	$V_{EH} = 3\text{ V}, R_L = 350\ \Omega, C_L = 15\text{ pF}$ (Fig. 10) (Note 9)		27		ns
CM_H	Common Mode Transient Immunity (at Output High Level)	$R_L = 350\ \Omega, T_A = 25^\circ\text{C}, I_F = 0\text{ mA}, V_{OH}(\text{Min.}) = 2.0\text{ V}, V_{CM} = 1,000\text{ V}$ (Fig. 11) (Note 10)	25,000	50,000		V/ μs
CM_L	Common Mode Transient Immunity (at Output Low Level)	$R_L = 350\ \Omega, T_A = 25^\circ\text{C}, I_F = 7.5\text{ mA}, V_{OL}(\text{Max.}) = 0.8\text{ V}, V_{CM} = 1,000\text{ V}$ (Fig. 11) (Note 11)	25,000	50,000		V/ μs

Transfer Characteristics ($T_A = -40^\circ\text{C}$ to $+85^\circ\text{C}$ Unless otherwise specified. Typical value is measured at $T_A = 25^\circ\text{C}$ and $V_{CC} = 3.3\text{V}$)

Symbol	DC Characteristics	Test Conditions	Min.	Typ.	Max.	Unit
I_{OH}	High Level Output Current	$I_F = 250\ \mu\text{A}$, $V_{CC} = 3.3\ \text{V}$, $V_O = 3.3\ \text{V}$, $V_E = 2.0\ \text{V}$ (Note 2)		0.01	50	μA
V_{OL}	Low Level Output Voltage	$V_{CC} = 3.3\ \text{V}$, $I_F = 5\ \text{mA}$, $I_{OL} = 13\ \text{mA}$, $V_E = 2.0\ \text{V}$ (Note 2)		0.3	0.6	V
I_{FT}	Input Threshold Current	$V_{CC} = 3.3\ \text{V}$, $V_O = 0.6\ \text{V}$, $I_{OL} = 13\ \text{mA}$, $V_E = 2.0\ \text{V}$ (Note 2)		1	5	mA

Isolation Characteristics ($T_A = -40^\circ\text{C}$ to $+85^\circ\text{C}$ Unless otherwise specified. Typical value is measured at $T_A = 25^\circ\text{C}$ and $V_{CC} = 3.3\text{V}$)

Symbol	Characteristics	Test Conditions	Min.	Typ.	Max.	Unit
I_{I-O}	Input-Output Insulation Leakage Current	Relative humidity = 45%, $T_A = 25^\circ\text{C}$, $t = 5\ \text{s}$, $V_{I-O} = 3000\ \text{VDC}$ (Note 12)			1.0	μA
V_{ISO}	Withstand Insulation Test Voltage FOD060L FOD260L	$I_{IO} \leq 2\ \mu\text{A}$, $R_H < 50\%$, $T_A = 25^\circ\text{C}$, $t = 1\ \text{min.}$ (Note 12)				V_{RMS}
			3750			
			5000			
R_{I-O}	Resistance (Input to Output)	$V_{I-O} = 500\ \text{V}$ (Note 12)		10^{12}		Ω
C_{I-O}	Capacitance (Input to Output)	$f = 1\ \text{MHz}$ (Note 12)		0.6		pF

Notes

- The V_{CC} supply to each optoisolator must be bypassed by a $0.1\ \mu\text{F}$ capacitor or larger. This can be either a ceramic or solid tantalum capacitor with good high frequency characteristic and should be connected as close as possible to the package V_{CC} and GND pins of each device.
- Enable Input – No pull up resistor required as the device has an internal pull up resistor.
- t_{PLH} – Propagation delay is measured from the 3.75 mA level on the HIGH to LOW transition of the input current pulse to the 1.5V level on the LOW to HIGH transition of the output voltage pulse.
- t_{PHL} – Propagation delay is measured from the 3.75 mA level on the LOW to HIGH transition of the input current pulse to the 1.5V level on the HIGH to LOW transition of the output voltage pulse.
- t_{PSK} is the worst case difference between t_{PHL} and t_{PLH} for any devices at the stated test conditions.
- t_r – Rise time is measured from the 90% to the 10% levels on the LOW to HIGH transition of the output pulse.
- t_f – Fall time is measured from the 10% to the 90% levels on the HIGH to LOW transition of the output pulse.
- t_{ELH} – Enable input propagation delay is measured from the 1.5V level on the HIGH to LOW transition of the input voltage pulse to the 1.5V level on the LOW to HIGH transition of the output voltage pulse.
- t_{EHL} – Enable input propagation delay is measured from the 1.5V level on the LOW to HIGH transition of the input voltage pulse to the 1.5V level on the HIGH to LOW transition of the output voltage pulse.
- CM_H – The maximum tolerable rate of rise of the common mode voltage to ensure the output will remain in the high state (i.e., $V_{OUT} > 2.0\ \text{V}$). Measured in volts per microsecond (V/ μs).
- CM_L – The maximum tolerable rate of fall of the common mode voltage to ensure the output will remain in the low output state (i.e., $V_{OUT} < 0.8\ \text{V}$). Measured in volts per microsecond (V/ μs).
- Device considered a two-terminal device: Pins 1, 2, 3 and 4 shorted together, and Pins 5, 6, 7 and 8 shorted together.

Typical Performance Curves

Fig. 1 Input Forward Current vs. Forward Voltage



Fig. 2 Input Threshold Current vs. Ambient Temperature



Fig. 3 Low Level Output Voltage vs. Ambient Temperature

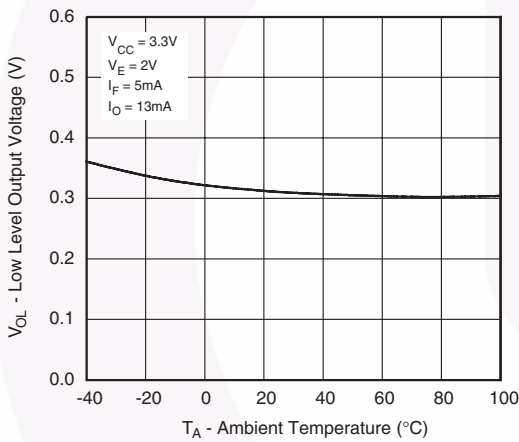

Fig. 4 High Level Output Current vs. Ambient Temperature

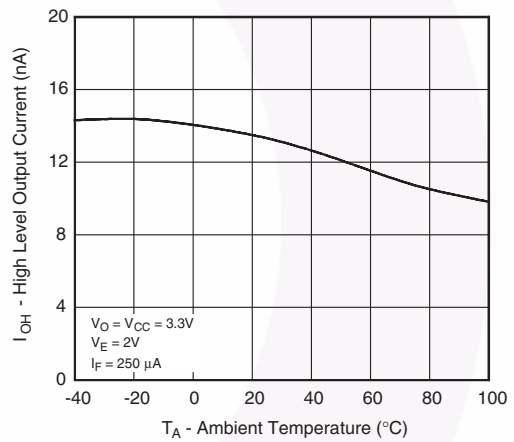

Fig. 5 Low Level Output Current vs. Ambient Temperature

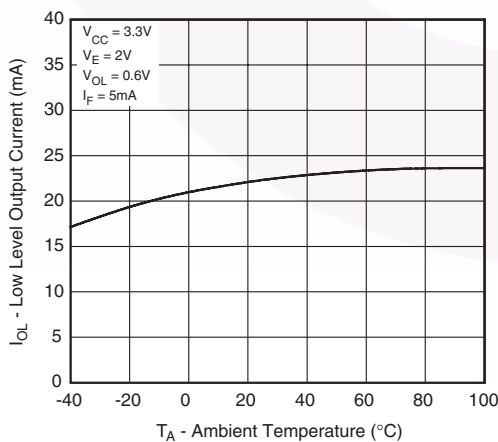
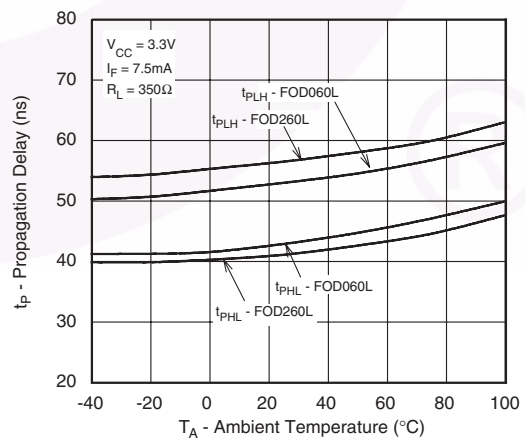

Fig. 6 Propagation Delay vs. Ambient Temperature



Typical Performance Curves

Fig. 7 Rise and Fall Times vs. Ambient Temperature



Fig. 8 Pulse Width Distortion vs. Ambient Temperature

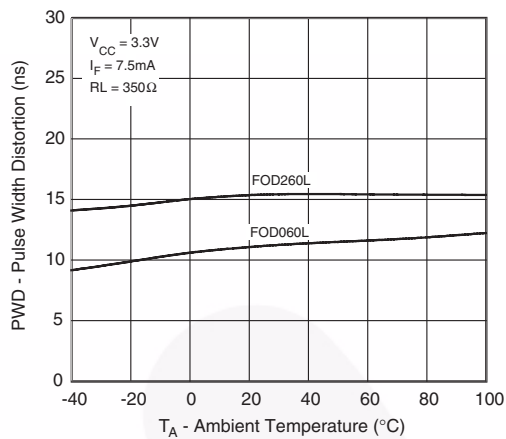



Fig. 9 Test Circuit and Waveforms for t_{PLH} , t_{PHL} , t_r and t_f .



Fig. 10 Test Circuit t_{EHL} and t_{ELH} .

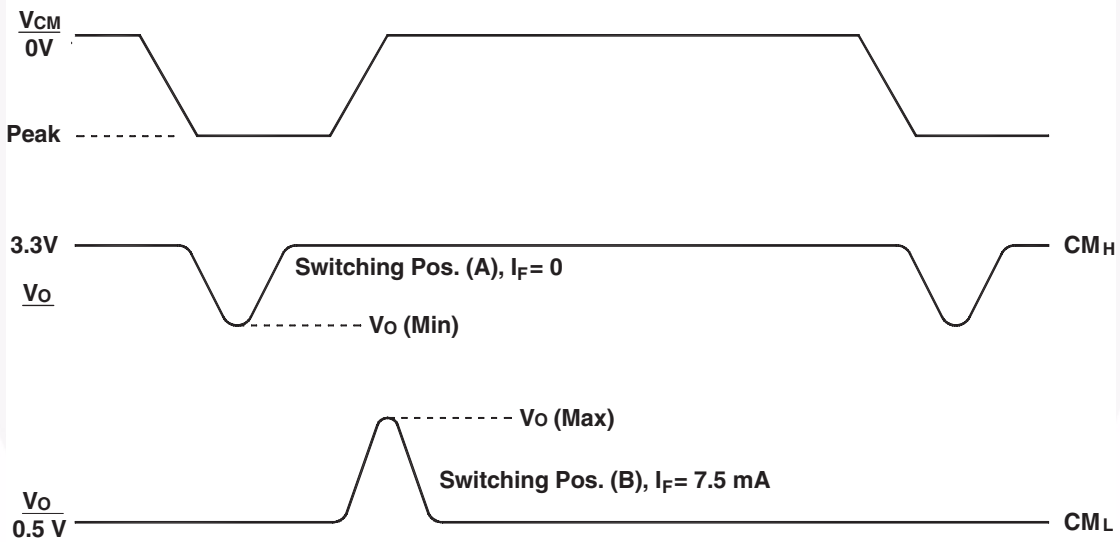

Fig. 11 Test Circuit Common Mode Transient Immunity

Ordering Information

Part Number	Package	Packing Method
FOD060L	Small outline 8-pin	Tube (50 units per tube)
FOD060LR2	Small outline 8-pin	Tape and Reel (2,500 units per reel)
FOD260L	DIP 8-Pin	Tube (50 units per tube)
FOD260LS	SMT 8-Pin (Lead Bend)	Tube (50 units per tube)
FOD260LSD	SMT 8-Pin (Lead Bend)	Tape and Reel (1,000 units per reel)
FOD260LV	DIP 8-Pin, DIN EN/IEC 60747-5-2 option	Tube (50 units per tube)
FOD260LSV	SMT 8-Pin (Lead Bend), DIN EN/IEC 60747-5-2 option	Tube (50 units per tube)
FOD260LSDV	SMT 8-Pin (Lead Bend), DIN EN/IEC 60747-5-2 option	Tape and Reel (1,000 units per reel)
FOD260LTV	DIP 8-Pin, 0.4" Lead Spacing, DIN EN/IEC 60747-5-2 option	Tube (50 units per tube)
FOD260LTSV	SMT 8-Pin, 0.4" Lead Spacing, DIN EN/IEC 60747-5-2 option	Tube (50 units per tube)
FOD260LTSR2	SMT 8-Pin, 0.4" Lead Spacing	Tape and Reel (700 units per reel)
FOD260LTSR2V	SMT 8-Pin, 0.4" Lead Spacing, DIN EN/IEC 60747-5-2 option	Tape and Reel (700 units per reel)

Marking Information

Small Outline

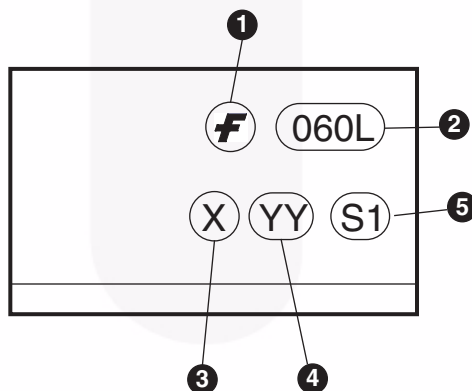

Definitions	
1	Fairchild logo
2	Device number
3	One digit year code, e.g., '8'
4	Two digit work week ranging from '01' to '53'
5	Assembly package code

Marking Information (Continued)

DIP and SMT



Definitions

1	Fairchild logo
2	Device number
3	VDE mark (Note: Only appears on parts ordered with DIN EN/IEC 60747-5-2 option – See order entry table)
4	Two digit year code, e.g., '11'
5	Two digit work week ranging from '01' to '53'
6	Assembly package code

Carrier Tape Specification

Small Outline



Note:

All dimensions are in millimeters.

Carrier Tape Specification (Continued)

Option S



Symbol	Description	Dimension in mm
W	Tape Width	16.0 ± 0.3
t	Tape Thickness	0.30 ± 0.05
P ₀	Sprocket Hole Pitch	4.0 ± 0.1
D ₀	Sprocket Hole Diameter	1.55 ± 0.05
E	Sprocket Hole Location	1.75 ± 0.10
F	Pocket Location	7.5 ± 0.1
P ₂		2.0 ± 0.1
P	Pocket Pitch	12.0 ± 0.1
A ₀	Pocket Dimensions	10.30 ± 0.20
B ₀		10.30 ± 0.20
K ₀		4.90 ± 0.20
W ₁	Cover Tape Width	13.2 ± 0.2
d	Cover Tape Thickness	0.1 max
	Max. Component Rotation or Tilt	10°
R	Min. Bending Radius	30

Carrier Tape Specification (Continued)

Option TS

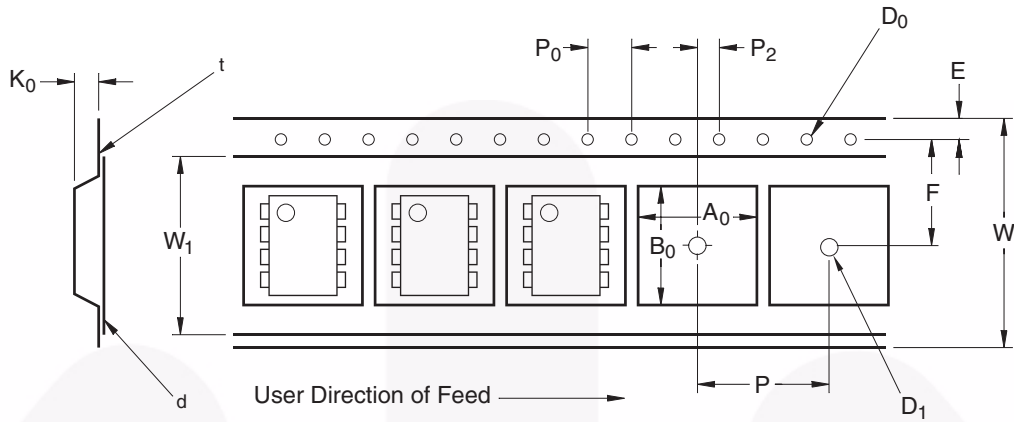

Symbol	Description	Dimension in mm
W	Tape Width	24.0 ± 0.3
t	Tape Thickness	0.40 ± 0.1
P ₀	Sprocket Hole Pitch	4.0 ± 0.1
D ₀	Sprocket Hole Diameter	1.55 ± 0.05
E	Sprocket Hole Location	1.75 ± 0.10
F	Pocket Location	11.5 ± 0.1
P ₂		2.0 ± 0.1
P	Pocket Pitch	16.0 ± 0.1
A ₀	Pocket Dimensions	12.80 ± 0.1
B ₀		10.35 ± 0.1
K ₀		5.7 ± 0.1
W ₁	Cover Tape Width	21.0 ± 0.1
d	Cover Tape Thickness	0.1 max
	Max. Component Rotation or Tilt	10°
R	Min. Bending Radius	30

Reflow Profile

Small Outline

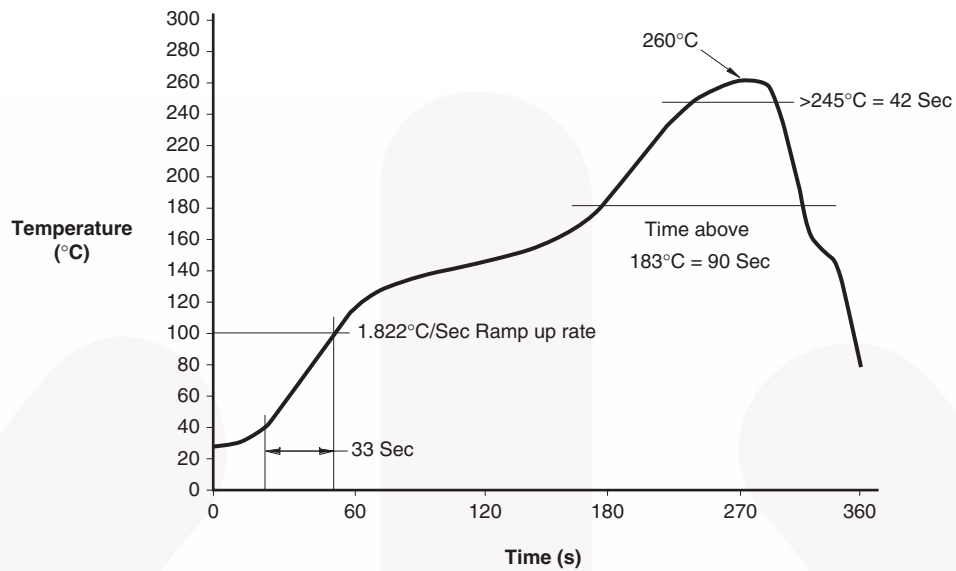

Reflow Profile (Continued)

DIP and SMT



Profile Feature	Pb-Free Assembly Profile
Temperature Min. (T _{smín})	150°C
Temperature Max. (T _{smáx})	200°C
Time (t _s) from (T _{smín} to T _{smáx})	60–120 seconds
Ramp-up Rate (t _L to t _p)	3°C/second max.
Liquidous Temperature (T _L)	217°C
Time (t _L) Maintained Above (T _L)	60–150 seconds
Peak Body Package Temperature	260°C +0°C / -5°C
Time (t _p) within 5°C of 260°C	30 seconds
Ramp-down Rate (T _p to T _L)	6°C/second max.
Time 25°C to Peak Temperature	8 minutes max.





NOTES:

- A) NO STANDARD APPLIES TO THIS PACKAGE
- B) ALL DIMENSIONS ARE IN MILLIMETERS.
- C) DIMENSIONS DO NOT INCLUDE MOLD FLASH OR BURRS.
- D) LANDPATTERN STANDARD: SOIC127P600X175-8M.
- E) DRAWING FILENAME: MKT-M08Erev5



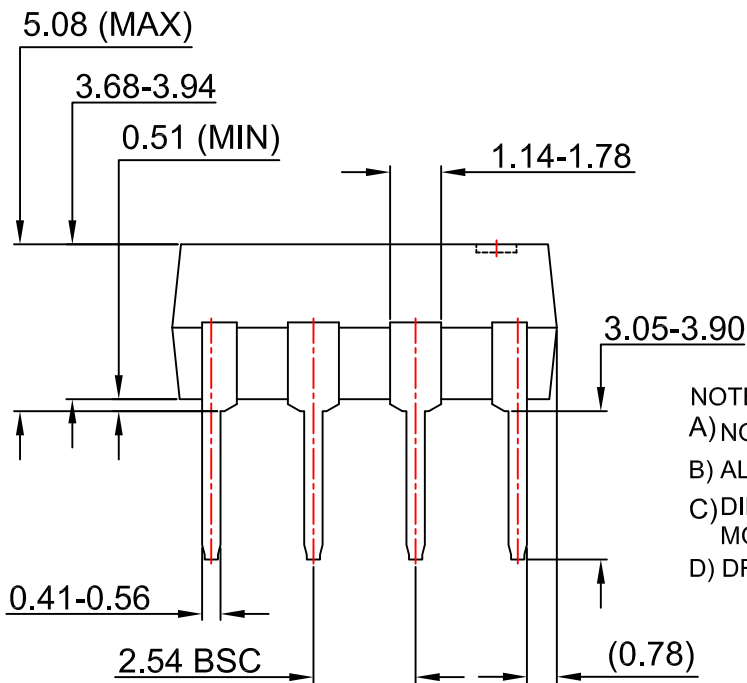

- NOTES:
 A) NO STANDARD APPLIES TO THIS PACKAGE
 B) ALL DIMENSIONS ARE IN MILLIMETERS.
 C) DIMENSIONS ARE EXCLUSIVE OF BURRS, MOLD FLASH, AND TIE BAR EXTRUSION
 D) DRAWING FILENAME AND REVISION: MKT-N08GREV7





LAND PATTERN RECOMMENDATION

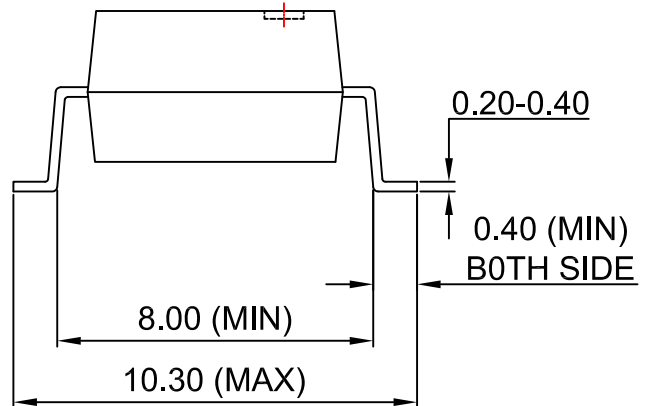

NOTES:

- A) NO STANDARD APPLIES TO THIS PACKAGE
- B) ALL DIMENSIONS ARE IN MILLIMETERS.
- C) DIMENSIONS ARE EXCLUSIVE OF BURRS, MOLD FLASH, AND TIE BAR EXTRUSION
- D) DRAWING FILENAME AND REVISION: MKT-N08Hrev7.



ON Semiconductor and  are trademarks of Semiconductor Components Industries, LLC dba ON Semiconductor or its subsidiaries in the United States and/or other countries. ON Semiconductor owns the rights to a number of patents, trademarks, copyrights, trade secrets, and other intellectual property. A listing of ON Semiconductor's product/patent coverage may be accessed at www.onsemi.com/site/pdf/Patent-Marking.pdf. ON Semiconductor reserves the right to make changes without further notice to any products herein. ON Semiconductor makes no warranty, representation or guarantee regarding the suitability of its products for any particular purpose, nor does ON Semiconductor assume any liability arising out of the application or use of any product or circuit, and specifically disclaims any and all liability, including without limitation special, consequential or incidental damages. Buyer is responsible for its products and applications using ON Semiconductor products, including compliance with all laws, regulations and safety requirements or standards, regardless of any support or applications information provided by ON Semiconductor. "Typical" parameters which may be provided in ON Semiconductor data sheets and/or specifications can and do vary in different applications and actual performance may vary over time. All operating parameters, including "Typicals" must be validated for each customer application by customer's technical experts. ON Semiconductor does not convey any license under its patent rights nor the rights of others. ON Semiconductor products are not designed, intended, or authorized for use as a critical component in life support systems or any FDA Class 3 medical devices or medical devices with a same or similar classification in a foreign jurisdiction or any devices intended for implantation in the human body. Should Buyer purchase or use ON Semiconductor products for any such unintended or unauthorized application, Buyer shall indemnify and hold ON Semiconductor and its officers, employees, subsidiaries, affiliates, and distributors harmless against all claims, costs, damages, and expenses, and reasonable attorney fees arising out of, directly or indirectly, any claim of personal injury or death associated with such unintended or unauthorized use, even if such claim alleges that ON Semiconductor was negligent regarding the design or manufacture of the part. ON Semiconductor is an Equal Opportunity/Affirmative Action Employer. This literature is subject to all applicable copyright laws and is not for resale in any manner.

PUBLICATION ORDERING INFORMATION

LITERATURE FULFILLMENT:

Literature Distribution Center for ON Semiconductor
19521 E. 32nd Pkwy, Aurora, Colorado 80011 USA
Phone: 303-675-2175 or 800-344-3860 Toll Free USA/Canada
Fax: 303-675-2176 or 800-344-3867 Toll Free USA/Canada
Email: orderlit@onsemi.com

N. American Technical Support: 800-282-9855 Toll Free
USA/Canada
Europe, Middle East and Africa Technical Support:
Phone: 421 33 790 2910
Japan Customer Focus Center
Phone: 81-3-5817-1050

ON Semiconductor Website: www.onsemi.com
Order Literature: <http://www.onsemi.com/orderlit>
For additional information, please contact your local
Sales Representative