

FGD3245G2-F085V

EcoSPARK[®] 2 Ignition IGBT

320 mJ, 450 V, N-Channel Ignition IGBT

Features

- SCIS Energy = 320 mJ at $T_J = 25^\circ\text{C}$
- Logic Level Gate Drive
- Low Saturation Voltage
- AEC-Q101 Qualified and PPAP Capable
- These Devices are Pb-Free and are RoHS Compliant

Applications

- Automotive Ignition Coil Driver Circuits
- High Current Ignition System
- Coil on Plug Application

MAXIMUM RATINGS ($T_J = 25^\circ\text{C}$ unless otherwise stated)

Symbol	Parameter	Value	Unit
BV_{CER}	Collector to Emitter Breakdown Voltage ($I_C = 1\text{ mA}$)	450	V
BV_{ECS}	Emitter to Collector Voltage – Reverse Battery Condition ($I_C = 10\text{ mA}$)	28	V
E_{SCIS25}	ISCIS = 14.6 A, L = 3.0 mHy, RGE = 1 K Ω , $T_C = 25^\circ\text{C}$ (Note 1)	320	mJ
$E_{SCIS150}$	ISCIS = 10.9 A, L = 3.0 mHy, RGE = 1 K Ω , $T_C = 150^\circ\text{C}$ (Note 2)	180	mJ
IC25	Collector Current Continuous at $V_{GE} = 4.0\text{ V}$, $T_C = 25^\circ\text{C}$	23	A
IC110	Collector Current Continuous at $V_{GE} = 4.0\text{ V}$, $T_C = 110^\circ\text{C}$	23	A
V_{GEM}	Gate to Emitter Voltage Continuous	± 10	V
PD	Power Dissipation Total, $T_C = 25^\circ\text{C}$	150	W
	Power Dissipation Derating, $T_C > 25^\circ\text{C}$	1.1	W/ $^\circ\text{C}$
T_J, T_{STG}	Operating Junction and Storage Temperature	-55 to +175	$^\circ\text{C}$
T_L	Lead Temperature for Soldering Purposes (1/8" from case for 10 s)	300	$^\circ\text{C}$
T_{PKG}	Reflow Soldering according to JESD020C	260	$^\circ\text{C}$
ESD	HBM–Electrostatic Discharge Voltage at 100 pF, 1500 Ω	4	kV
	CDM–Electrostatic Discharge Voltage at 1 Ω	2	kV

Stresses exceeding those listed in the Maximum Ratings table may damage the device. If any of these limits are exceeded, device functionality should not be assumed, damage may occur and reliability may be affected.

1. Self clamped inductive Switching Energy (E_{SCIS25}) of 320 mJ is based on the test conditions that is starting $T_J = 25^\circ\text{C}$, L = 3 mHy, ISCIS = 14.6 A, VCC = 100 V during inductor charging and VCC = 0 V during time in clamp.
2. Self Clamped inductive Switching Energy ($E_{SCIS150}$) of 180 mJ is based on the test conditions that is starting $T_J = 150^\circ\text{C}$, L = 3mHy, ISCIS = 10.9 A, VCC = 100 V during inductor charging and VCC = 0 V during time in clamp.



ON Semiconductor[®]

www.onsemi.com

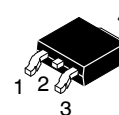
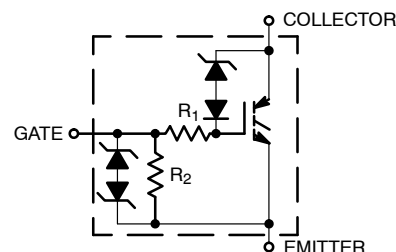

DPAK (SINGLE GAUGE)
CASE 369C

MARKING DIAGRAM

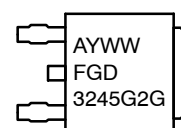

A = Assembly Location
Y = Year
WW = Work Week
FGD3245G2 = Device Code
G = Pb-Free Package

ORDERING INFORMATION

See detailed ordering and shipping information on page 2 of this data sheet.

FGD3245G2-F085V

THERMAL RESISTANCE RATINGS

Characteristic	Symbol	Max	Units
Junction-to-Case – Steady State (Drain)	$R_{\theta JC}$	0.9	°C/W

ELECTRICAL CHARACTERISTICS ($T_J = 25^\circ\text{C}$ unless otherwise specified)

Symbol	Parameter	Test Conditions	Min	Typ.	Max.	Units
--------	-----------	-----------------	-----	------	------	-------

OFF CHARACTERISTICS

BV_{CER}	Collector to Emitter Breakdown Voltage	$I_{CE} = 2\text{ mA}$, $V_{GE} = 0\text{ V}$, $R_{GE} = 1\text{ k}\Omega$, $T_J = -40\text{ to }150^\circ\text{C}$	420	–	480	V	
BV_{CES}	Collector to Emitter Breakdown Voltage	$I_{CE} = 10\text{ mA}$, $V_{GE} = 0\text{ V}$, $R_{GE} = 0$, $T_J = -40\text{ to }150^\circ\text{C}$	440	–	500	V	
BV_{ECS}	Emitter to Collector Breakdown Voltage	$I_{CE} = -75\text{ mA}$, $V_{GE} = 0\text{ V}$, $T_J = 25^\circ\text{C}$	28	–	–	V	
BV_{GES}	Gate to Emitter Breakdown Voltage	$I_{GES} = \pm 2\text{ mA}$	± 12	± 14	–	V	
I_{CER}	Collector to Emitter Leakage Current	$V_{CE} = 175\text{ V}$ $R_{GE} = 1\text{ k}\Omega$	$T_J = 25^\circ\text{C}$	–	–	25	μA
			$T_J = 150^\circ\text{C}$	–	–	1	
I_{ECS}	Emitter to Collector Leakage Current	$V_{EC} = 24\text{ V}$	$T_J = 25^\circ\text{C}$	–	–	1	mA
			$T_J = 150^\circ\text{C}$	–	–	40	
R_1	Series Gate Resistance		–	120	–	Ω	
R_2	Gate to Emitter Resistance		10K	–	30K	Ω	

ON CHARACTERISTICS

$V_{CE(SAT)}$	Collector to Emitter Saturation Voltage	$I_{CE} = 6\text{ A}$, $V_{GE} = 4\text{ V}$, $T_J = 25^\circ\text{C}$	–	1.13	1.25	V
$V_{CE(SAT)}$	Collector to Emitter Saturation Voltage	$I_{CE} = 10\text{ A}$, $V_{GE} = 4.5\text{ V}$, $T_J = 150^\circ\text{C}$	–	1.32	1.50	V
$V_{CE(SAT)}$	Collector to Emitter Saturation Voltage	$I_{CE} = 15\text{ A}$, $V_{GE} = 5\text{ V}$, $T_J = 150^\circ\text{C}$	–	1.64	1.85	V

DYNAMIC CHARACTERISTICS

$Q_{G(ON)}$	Gate Charge	$I_{CE} = 10\text{ A}$, $V_{CE} = 12\text{ V}$, $V_{GE} = 5\text{ V}$	–	23	–	nC	
$V_{GE(TH)}$	Gate to Emitter Threshold Voltage	$I_{CE} = 1\text{ mA}$ $V_{CE} = V_{GE}$	$T_J = 25^\circ\text{C}$	1.3	1.6	2.2	V
			$T_J = 150^\circ\text{C}$	0.75	1.1	1.8	
V_{GEP}	Gate to Emitter Plateau Voltage	$V_{CE} = 12\text{ V}$, $I_{CE} = 10\text{ A}$	–	2.7	–	V	

SWITCHING CHARACTERISTICS

$t_{d(ON)R}$	Current Turn-On Delay Time–Resistive	$V_{CE} = 14\text{ V}$, $R_L = 1\text{ }\Omega$, $V_{GE} = 5\text{ V}$, $R_G = 470\text{ }\Omega$, $T_J = 25^\circ\text{C}$	–	0.9	4	μs
t_{rR}	Current Rise Time–Resistive		–	2.6	7	
$t_{d(OFF)L}$	Current Turn-Off Delay Time–Inductive	$V_{CE} = 300\text{ V}$, $L = 1\text{ mH}$, $V_{GE} = 5\text{ V}$, $R_G = 470\text{ }\Omega$, $I_{CE} = 6.5\text{ A}$, $T_J = 25^\circ\text{C}$	–	5.4	15	
t_{fL}	Current Fall Time–Inductive		–	2.7	15	

Product parametric performance is indicated in the Electrical Characteristics for the listed test conditions, unless otherwise noted. Product performance may not be indicated by the Electrical Characteristics if operated under different conditions.

PACKAGE MARKING AND ORDERING INFORMATION

Device Marking	Device	Package	Reel Diameter	Tape Width	Qty [†]
FGD3245G2	FGD3245G2-F085V	DPAK (Pb-Free)	330 mm	16 mm	2500

[†]For information on tape and reel specifications, including part orientation and tape sizes, please refer to our Tape and Reel Packaging Specifications Brochure, BRD8011/D.

TYPICAL CHARACTERISTICS

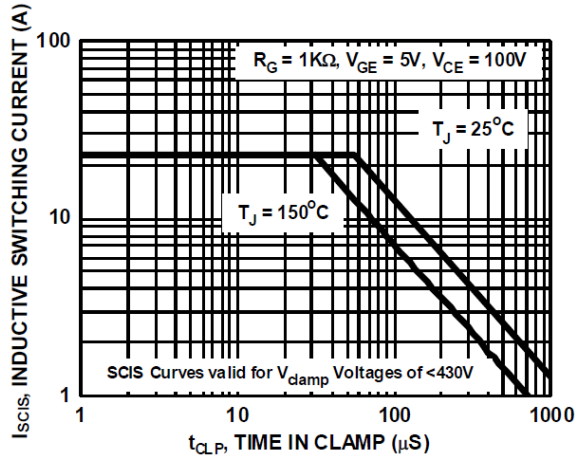

Figure 1. Self Clamped Inductive Switching Current vs. Time in Clamp

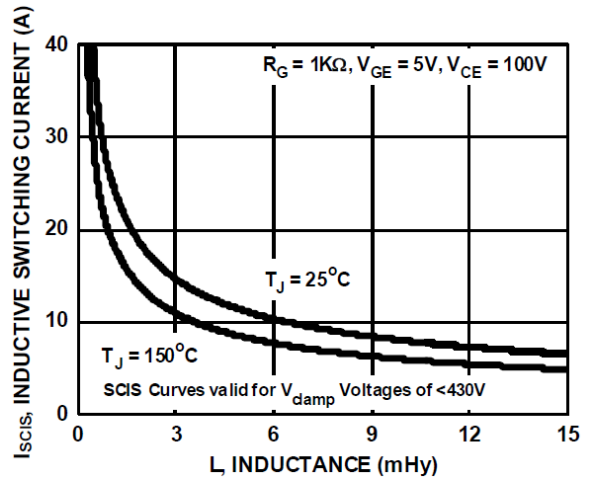

Figure 2. Self Clamped Inductive Switching Current vs. Inductance

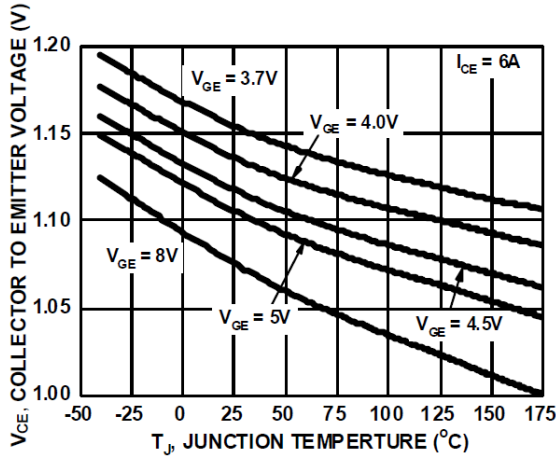

Figure 3. Collector to Emitter On-State Voltage vs. Junction Temperature

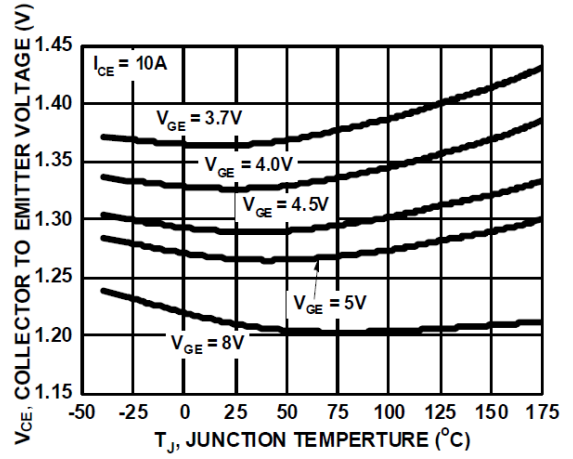

Figure 4. Collector to Emitter On-State Voltage vs. Junction Temperature

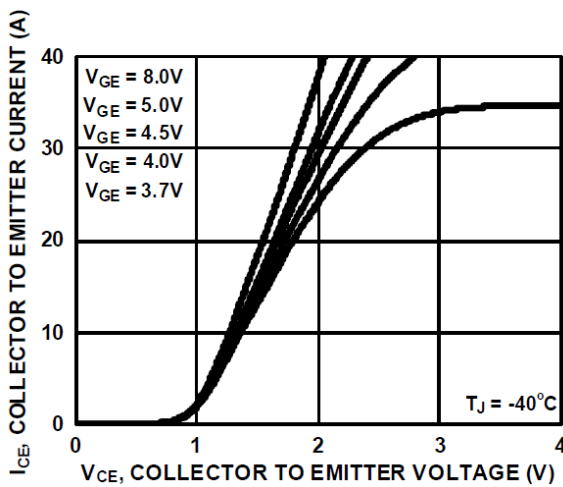

Figure 5. Collector to Emitter On-State Voltage vs. Collector Current

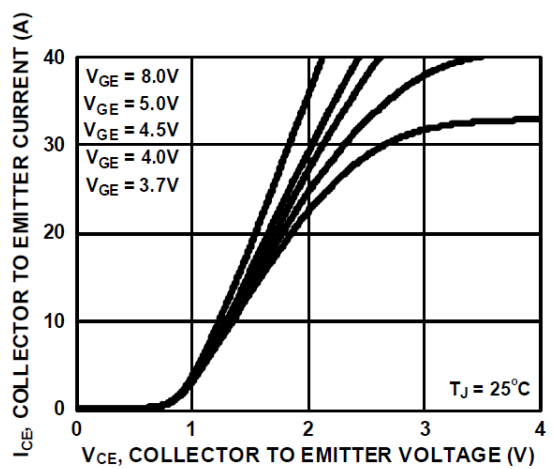

Figure 6. Collector to Emitter On-State Voltage vs. Collector Current

TYPICAL CHARACTERISTICS (continued)

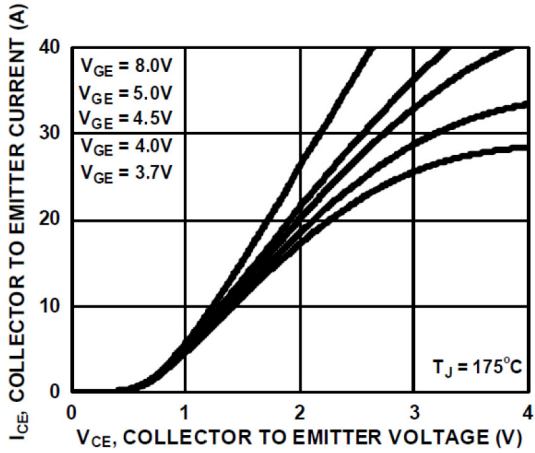

Figure 7. Collector to Emitter On-State Voltage vs. Collector Current

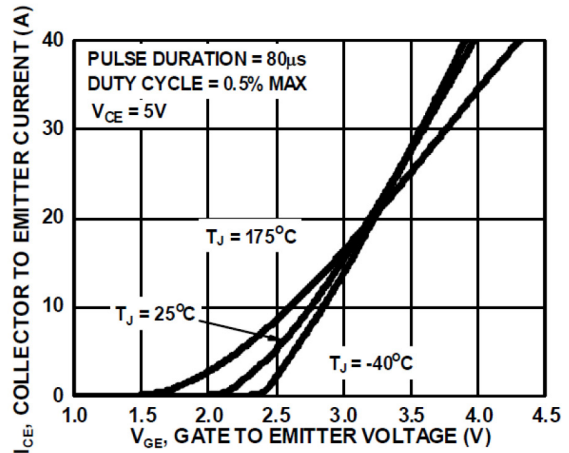

Figure 8. Transfer Characteristics

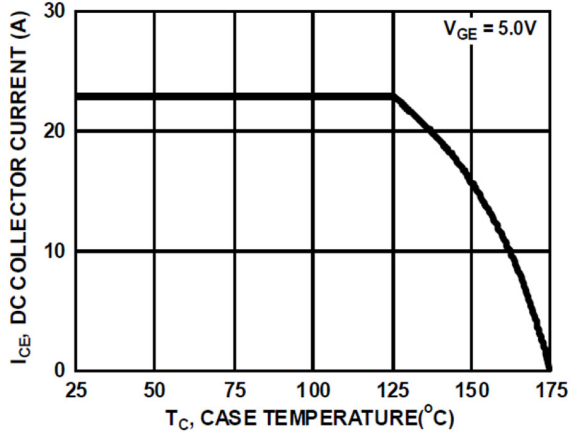

Figure 9. DC Collector Current vs. Case Temperature

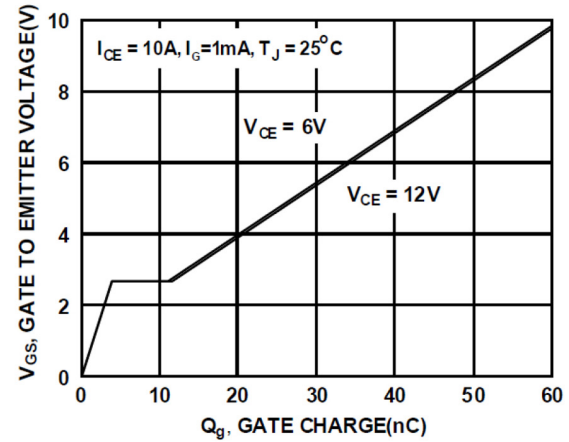

Figure 10. Gate Charge

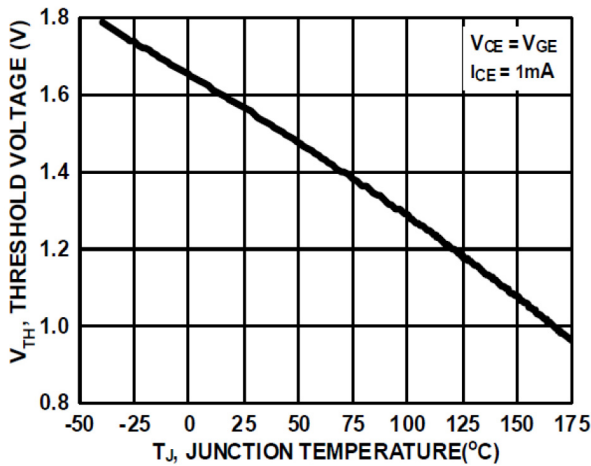

Figure 11. Threshold Voltage vs. Junction Temperature

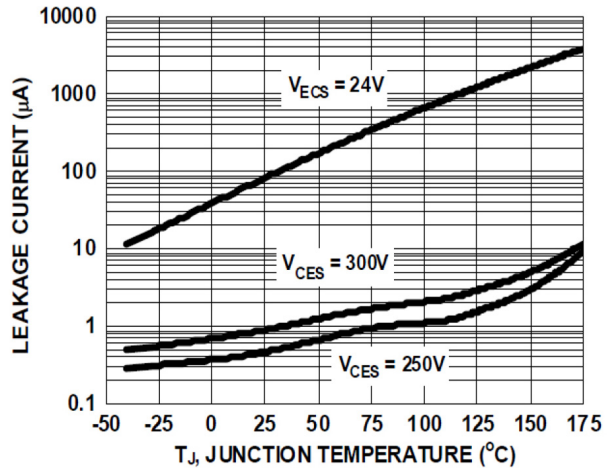

Figure 12. Leakage Current vs. Junction Temperature

FGD3245G2-F085V

TYPICAL CHARACTERISTICS (continued)

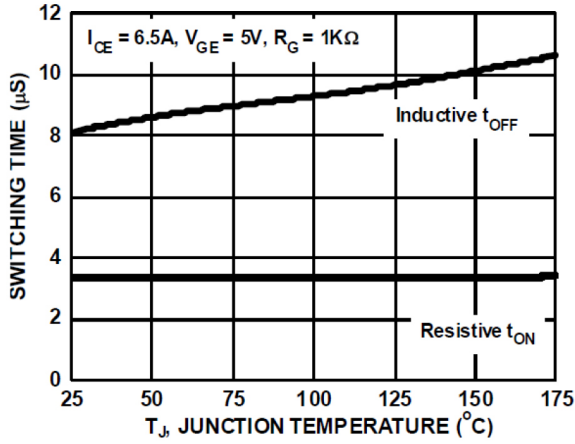

Figure 13. Switching Time vs. Junction Temperature

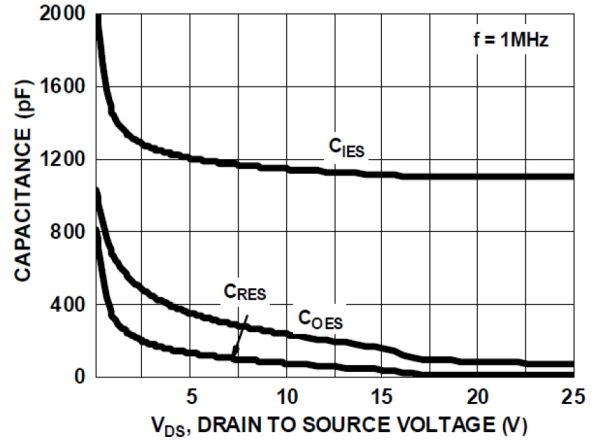

Figure 14. Capacitance vs. Collector to Emitter

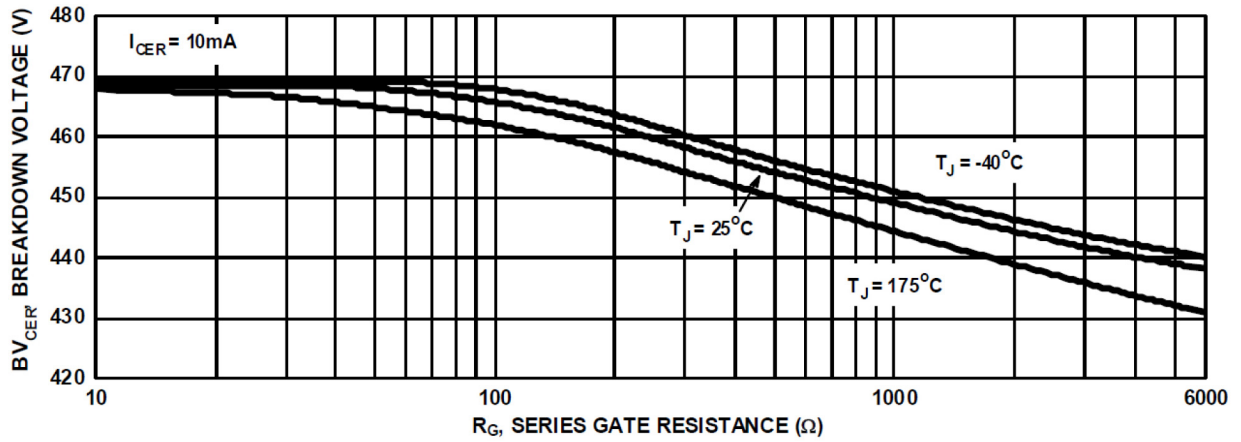

Figure 15. Break Down Voltage vs. Series Resistance

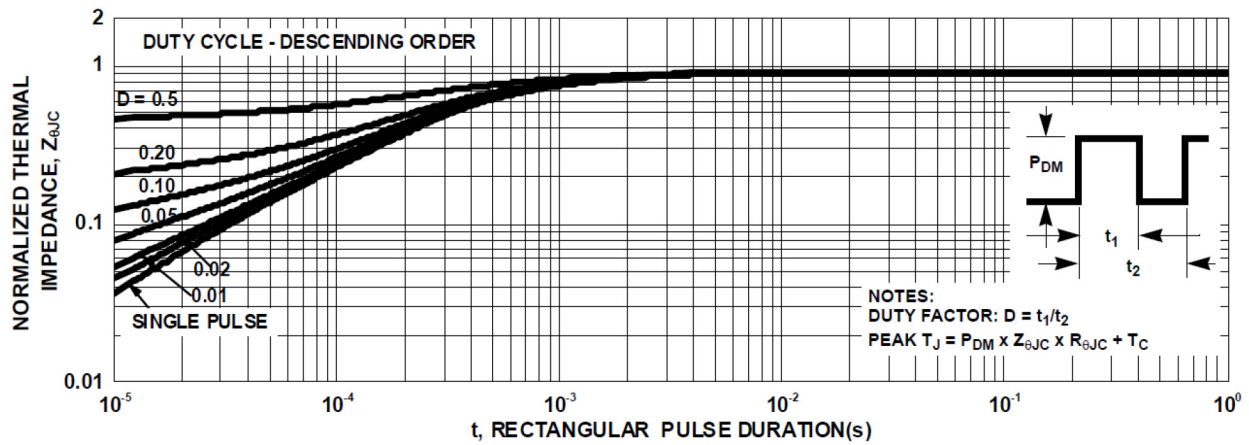

Figure 16. IGBT Normalized Transient Thermal Impedance, Junction to Case

FGD3245G2-F085V

TEST CIRCUIT AND WAVEFORMS

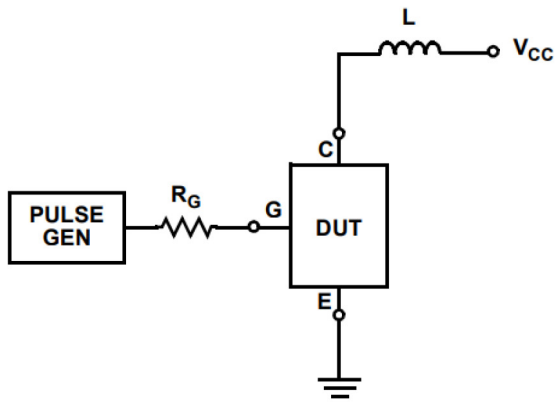

Figure 17. Inductive Switching Test Circuit

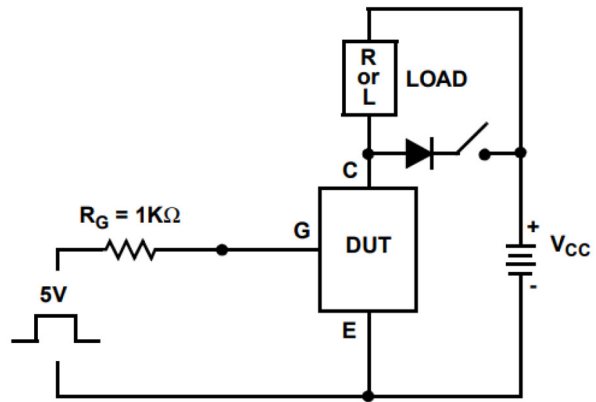

Figure 18. t_{ON} and t_{OFF} Switching Test Circuit

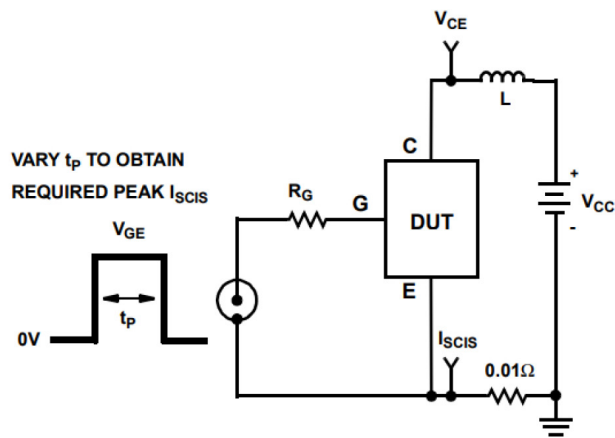

Figure 19. Energy Test Circuit

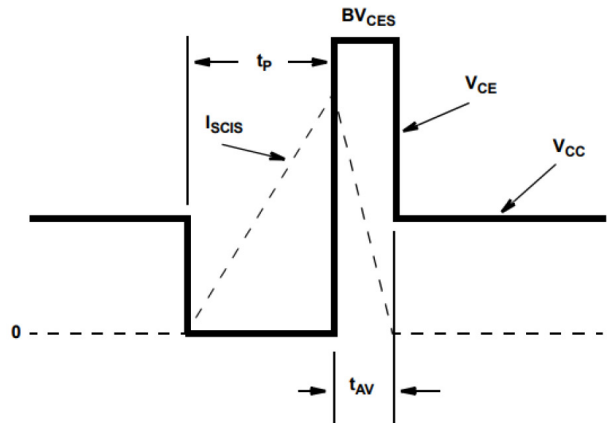
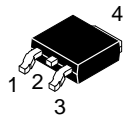

Figure 20. Energy Waveforms

MECHANICAL CASE OUTLINE PACKAGE DIMENSIONS

ON Semiconductor®



SCALE 1:1

DPAK (SINGLE GAUGE) CASE 369C ISSUE F

DATE 21 JUL 2015

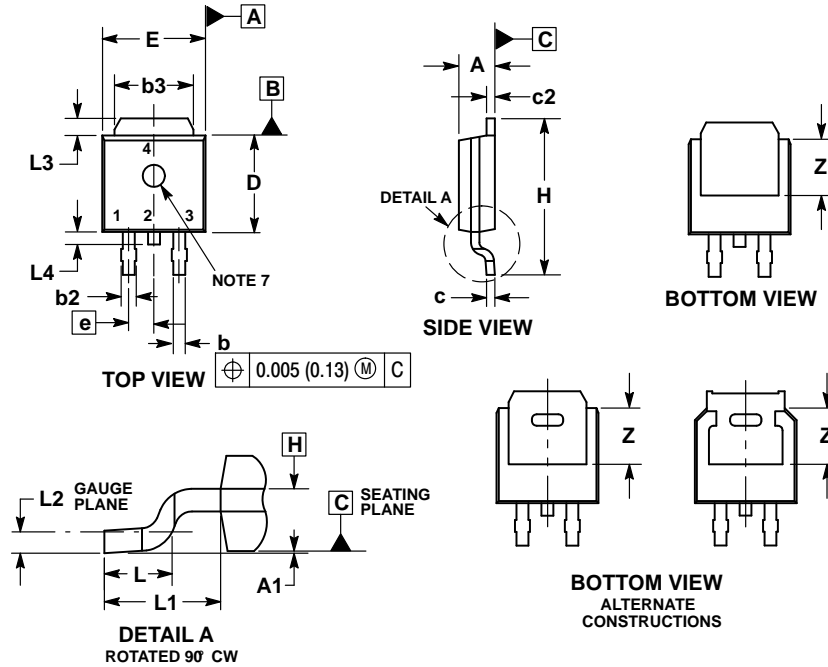

NOTES:

1. DIMENSIONING AND TOLERANCING PER ASME Y14.5M, 1994.
2. CONTROLLING DIMENSION: INCHES.
3. THERMAL PAD CONTOUR OPTIONAL WITHIN DIMENSIONS b3, L3 and Z.
4. DIMENSIONS D AND E DO NOT INCLUDE MOLD FLASH, PROTRUSIONS, OR BURRS. MOLD FLASH, PROTRUSIONS, OR GATE BURRS SHALL NOT EXCEED 0.006 INCHES PER SIDE.
5. DIMENSIONS D AND E ARE DETERMINED AT THE OUTERMOST EXTREMES OF THE PLASTIC BODY.
6. DATUMS A AND B ARE DETERMINED AT DATUM PLANE H.
7. OPTIONAL MOLD FEATURE.

DIM	INCHES		MILLIMETERS	
	MIN	MAX	MIN	MAX
A	0.086	0.094	2.18	2.38
A1	0.000	0.005	0.00	0.13
b	0.025	0.035	0.63	0.89
b2	0.028	0.045	0.72	1.14
b3	0.180	0.215	4.57	5.46
c	0.018	0.024	0.46	0.61
c2	0.018	0.024	0.46	0.61
D	0.235	0.245	5.97	6.22
E	0.250	0.265	6.35	6.73
e	0.090 BSC		2.29 BSC	
H	0.370	0.410	9.40	10.41
L	0.055	0.070	1.40	1.78
L1	0.114 REF		2.90 REF	
L2	0.020 BSC		0.51 BSC	
L3	0.035	0.050	0.89	1.27
L4	---	0.040	---	1.01
Z	0.155	---	3.93	---

GENERIC MARKING DIAGRAM*

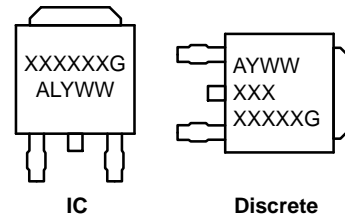

XXXXXX = Device Code
 A = Assembly Location
 L = Wafer Lot
 Y = Year
 WW = Work Week
 G = Pb-Free Package

*This information is generic. Please refer to device data sheet for actual part marking.

- | | | | | |
|---|---|--|--|---|
| <p>STYLE 1:
 PIN 1. BASE
 2. COLLECTOR
 3. EMITTER
 4. COLLECTOR</p> | <p>STYLE 2:
 PIN 1. GATE
 2. DRAIN
 3. SOURCE
 4. DRAIN</p> | <p>STYLE 3:
 PIN 1. ANODE
 2. CATHODE
 3. ANODE
 4. CATHODE</p> | <p>STYLE 4:
 PIN 1. CATHODE
 2. ANODE
 3. GATE
 4. ANODE</p> | <p>STYLE 5:
 PIN 1. GATE
 2. ANODE
 3. CATHODE
 4. ANODE</p> |
| <p>STYLE 6:
 PIN 1. MT1
 2. MT2
 3. GATE
 4. MT2</p> | <p>STYLE 7:
 PIN 1. GATE
 2. COLLECTOR
 3. EMITTER
 4. COLLECTOR</p> | <p>STYLE 8:
 PIN 1. N/C
 2. CATHODE
 3. ANODE
 4. CATHODE</p> | <p>STYLE 9:
 PIN 1. ANODE
 2. CATHODE
 3. RESISTOR ADJUST
 4. CATHODE</p> | <p>STYLE 10:
 PIN 1. CATHODE
 2. ANODE
 3. CATHODE
 4. ANODE</p> |

SOLDERING FOOTPRINT*

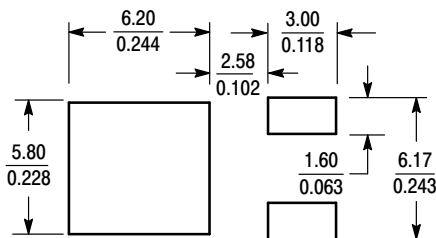

SCALE 3:1 (mm/inches)

*For additional information on our Pb-Free strategy and soldering details, please download the ON Semiconductor Soldering and Mounting Techniques Reference Manual, SOLDERRM/D.

DOCUMENT NUMBER:	98AON10527D	Electronic versions are uncontrolled except when accessed directly from the Document Repository. Printed versions are uncontrolled except when stamped "CONTROLLED COPY" in red.
STATUS:	ON SEMICONDUCTOR STANDARD	
NEW STANDARD:	REF TO JEDEC TO-252	
DESCRIPTION:	DPAK SINGLE GAUGE SURFACE MOUNT	PAGE 1 OF 2

ON Semiconductor and  are trademarks of Semiconductor Components Industries, LLC dba ON Semiconductor or its subsidiaries in the United States and/or other countries. ON Semiconductor owns the rights to a number of patents, trademarks, copyrights, trade secrets, and other intellectual property. A listing of ON Semiconductor's product/patent coverage may be accessed at www.onsemi.com/site/pdf/Patent-Marking.pdf. ON Semiconductor reserves the right to make changes without further notice to any products herein. ON Semiconductor makes no warranty, representation or guarantee regarding the suitability of its products for any particular purpose, nor does ON Semiconductor assume any liability arising out of the application or use of any product or circuit, and specifically disclaims any and all liability, including without limitation special, consequential or incidental damages. Buyer is responsible for its products and applications using ON Semiconductor products, including compliance with all laws, regulations and safety requirements or standards, regardless of any support or applications information provided by ON Semiconductor. "Typical" parameters which may be provided in ON Semiconductor data sheets and/or specifications can and do vary in different applications and actual performance may vary over time. All operating parameters, including "Typicals" must be validated for each customer application by customer's technical experts. ON Semiconductor does not convey any license under its patent rights nor the rights of others. ON Semiconductor products are not designed, intended, or authorized for use as a critical component in life support systems or any FDA Class 3 medical devices or medical devices with a same or similar classification in a foreign jurisdiction or any devices intended for implantation in the human body. Should Buyer purchase or use ON Semiconductor products for any such unintended or unauthorized application, Buyer shall indemnify and hold ON Semiconductor and its officers, employees, subsidiaries, affiliates, and distributors harmless against all claims, costs, damages, and expenses, and reasonable attorney fees arising out of, directly or indirectly, any claim of personal injury or death associated with such unintended or unauthorized use, even if such claim alleges that ON Semiconductor was negligent regarding the design or manufacture of the part. ON Semiconductor is an Equal Opportunity/Affirmative Action Employer. This literature is subject to all applicable copyright laws and is not for resale in any manner.

PUBLICATION ORDERING INFORMATION

LITERATURE FULFILLMENT:

Email Requests to: orderlit@onsemi.com

ON Semiconductor Website: www.onsemi.com

TECHNICAL SUPPORT

North American Technical Support:
Voice Mail: 1 800-282-9855 Toll Free USA/Canada
Phone: 011 421 33 790 2910

Europe, Middle East and Africa Technical Support:

Phone: 00421 33 790 2910

For additional information, please contact your local Sales Representative