

ESDM1051

Product Preview

5.5V ESD Protection Diodes

Micro-packaged Diodes for ESD Protection

The ESDM1051 Series is designed to protect voltage sensitive components from ESD. Excellent clamping capability, low leakage, and fast response time provide best in class protection on designs that are exposed to ESD. Because of its small size, it is suited for use in smartphone, smart-watch, or many other portable / wearable applications where board space comes at a premium.

Features

- Low Capacitance (21 pF Typ, I/O to GND)
- Small Body Outline Dimensions – 01005 Size: 0.445 x 0.240 mm
- Protection for the Following IEC Standards:
IEC 61000-4-2 (Level 4)
- Low ESD Clamping Voltage
- These Devices are Pb-Free, Halogen Free/BFR Free and are RoHS Compliant

MAXIMUM RATINGS (T_J = 25°C unless otherwise noted)

Rating	Symbol	Value	Unit
Operating Junction Temperature Range	T _J	-55 to +125	°C
Storage Temperature Range	T _{stg}	-55 to +150	°C
Lead Solder Temperature – Maximum (10 Seconds)	T _L	260	°C
ESDM1051: IEC 61000-4-2 Contact IEC 61000-4-2 Air	ESD	±30 ±30	kV kV

Stresses exceeding those listed in the Maximum Ratings table may damage the device. If any of these limits are exceeded, device functionality should not be assumed, damage may occur and reliability may be affected.

See Application Note AND8308/D for further description of survivability specs.

This document contains information on a product under development. ON Semiconductor reserves the right to change or discontinue this product without notice.



ON Semiconductor®

www.onsemi.com



X4DFN2
CASE 718AA

MARKING DIAGRAM



X = Specific Device Code

PIN CONFIGURATION AND SCHEMATIC

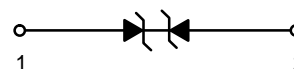

ORDERING INFORMATION

See detailed ordering and shipping information on page 2 of this data sheet.

ESDM1051

ELECTRICAL CHARACTERISTICS ($T_A = 25^\circ\text{C}$ unless otherwise specified)

Parameter	Symbol	Conditions	Min	Typ	Max	Unit
Reverse Working Voltage	V_{RWM}	I/O Pin to GND			5.5	V
Breakdown Voltage	V_{BR}	$I_T = 1\text{ mA}$, I/O Pin to GND		6.8		V
Reverse Leakage Current	I_R	$V_{RWM} = 5.5\text{ V}$, I/O Pin to GND			0.1	μA
Clamping Voltage TLP (Note 1)	V_C	$I_{PP} = 8\text{ A}$ } IEC 61000-4-2 Level 2 equivalent ($\pm 4\text{ kV}$ Contact, $\pm 8\text{ kV}$ Air)		7.5		V
		$I_{PP} = 16\text{ A}$ } IEC 61000-4-2 Level 2 equivalent ($\pm 8\text{ kV}$ Contact, $\pm 16\text{ kV}$ Air)		8.4		
Reverse Peak Pulse Current	I_{PP}	IEC61000-4-5 (8x20 μs)	11	12.5		A
Clamping Voltage	V_C	$I_{PP} = 11\text{ A}$, (8/20 μs pulse)		8.4	10	V
Dynamic Resistance	R_{DYN}	100 ns TLP Pulse		0.11		Ω
Junction Capacitance	C_J	$V_R = 0\text{ V}$, $f = 1\text{ MHz}$		21	24	pF

Product parametric performance is indicated in the Electrical Characteristics for the listed test conditions, unless otherwise noted. Product performance may not be indicated by the Electrical Characteristics if operated under different conditions.

1. ANSI/ESD STM5.5.1 – Electrostatic Discharge Sensitivity Testing using Transmission Line Pulse (TLP) Model.

TLP conditions: $Z_0 = 50\ \Omega$, $t_p = 100\text{ ns}$, $t_r = 1\text{ ns}$, averaging window; $t_1 = 70\text{ ns}$ to $t_2 = 90\text{ ns}$.

ORDERING INFORMATION

Device	Package	Shipping [†]
ESDM1051	X4DFN2 (Pb-Free)	10,000 / Tape & Reel

[†]For information on tape and reel specifications, including part orientation and tape sizes, please refer to our Tape and Reel Packaging Specifications Brochure, BRD8011/D.

TYPICAL CHARACTERISTICS

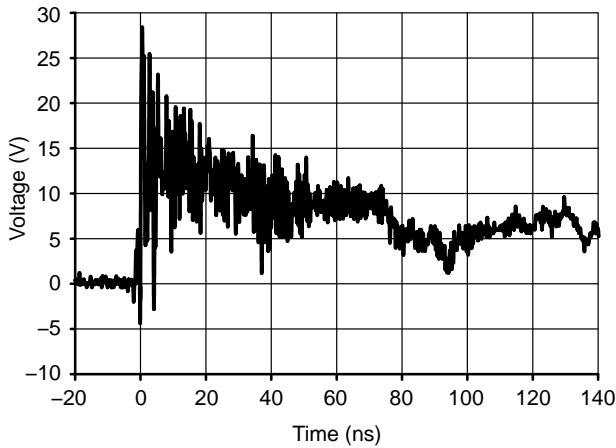

Figure 1. ESD Clamping Voltage
Positive 8 kV Contact per IEC61000-4-2

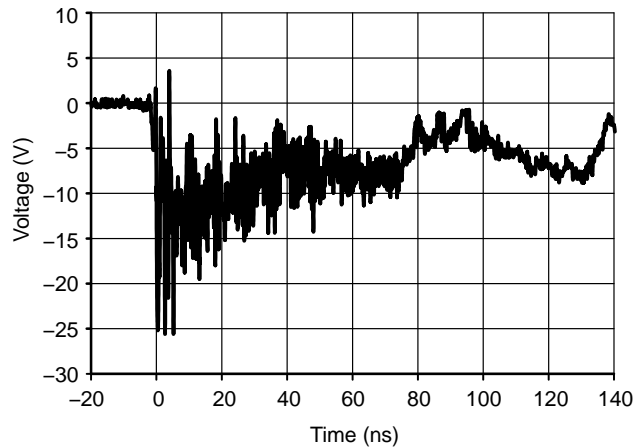

Figure 2. ESD Clamping Voltage
Negative 8 kV Contact per IEC61000-4-2

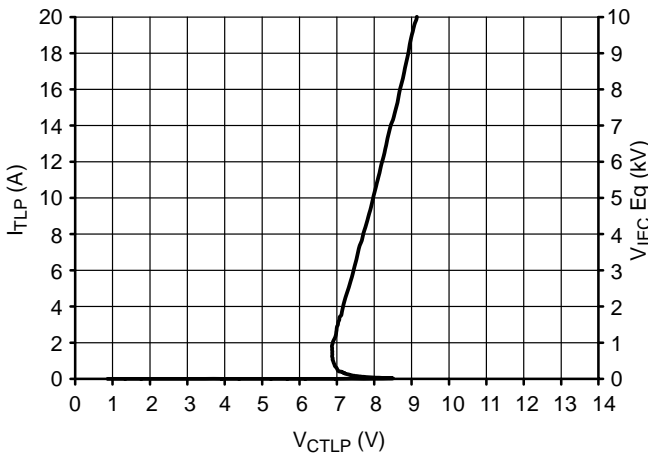

Figure 3. Positive TLP I-V Curve

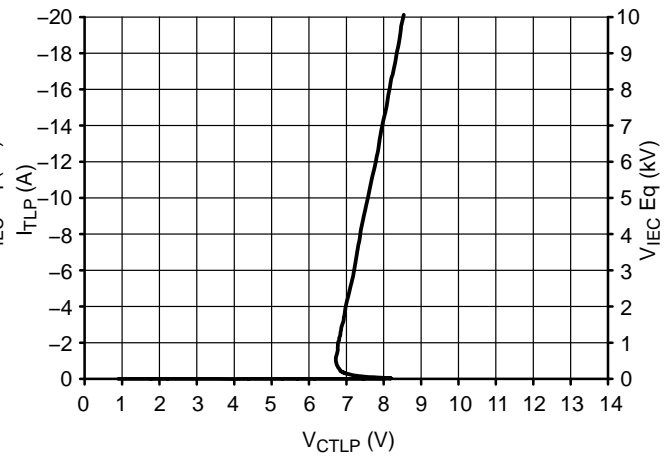

Figure 4. Negative TLP I-V Curve

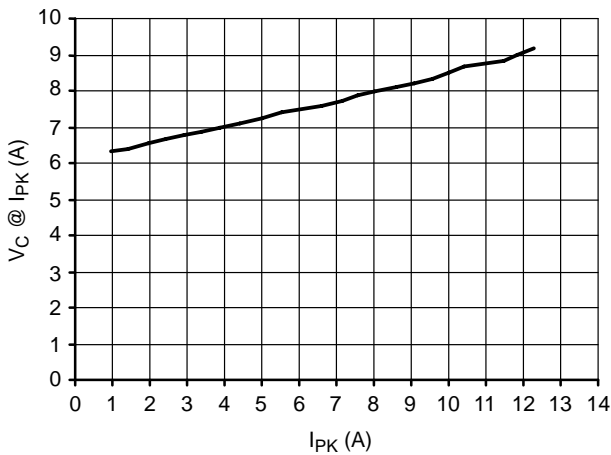

Figure 5. Positive Clamping Voltage vs. Peak
Pulse Current ($t_p = 8/20 \mu s$)

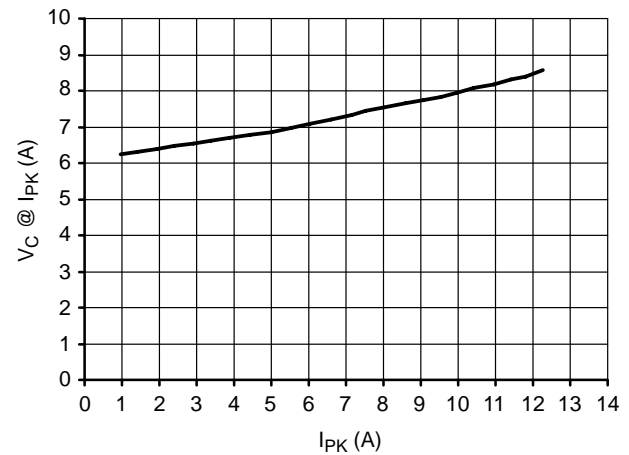

Figure 6. Negative Clamping Voltage vs. Peak
Pulse Current ($t_p = 8/20 \mu s$)

ESDM1051

TYPICAL CHARACTERISTICS

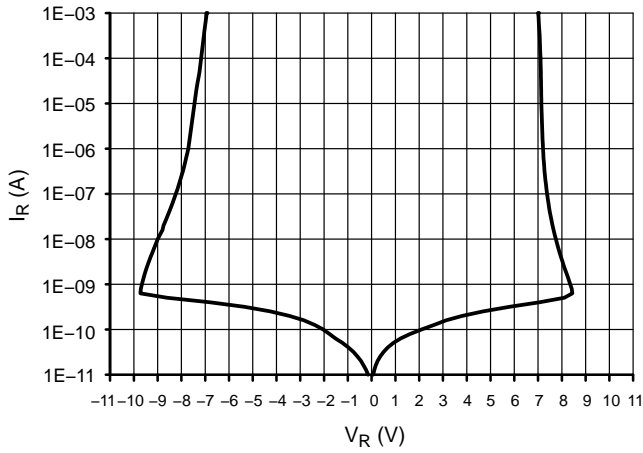

Figure 7. Breakdown Voltage

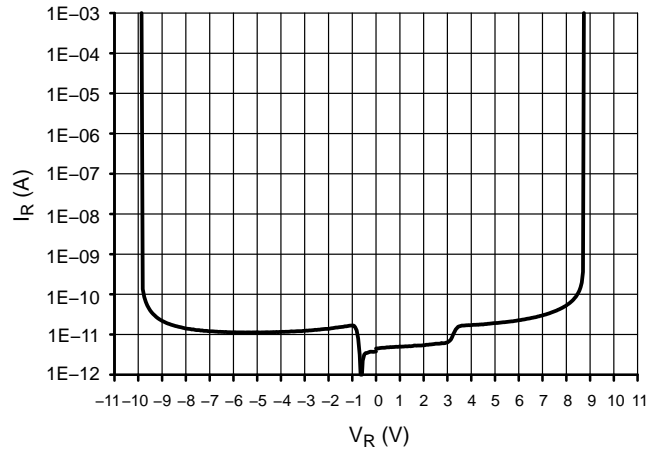

Figure 8. Reverse Leakage Current

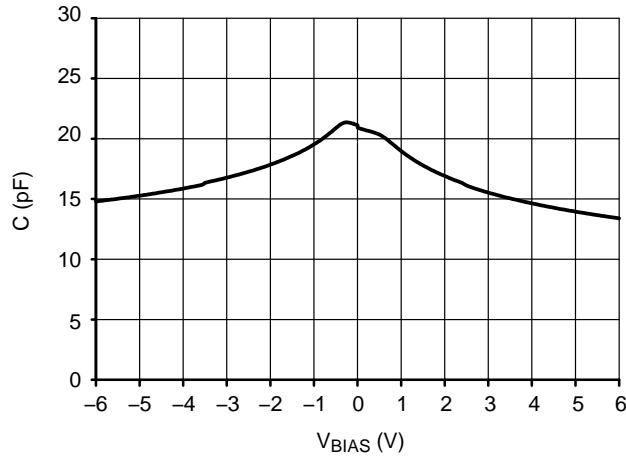

Figure 9. Line Capacitance, $f = 1$ MHz

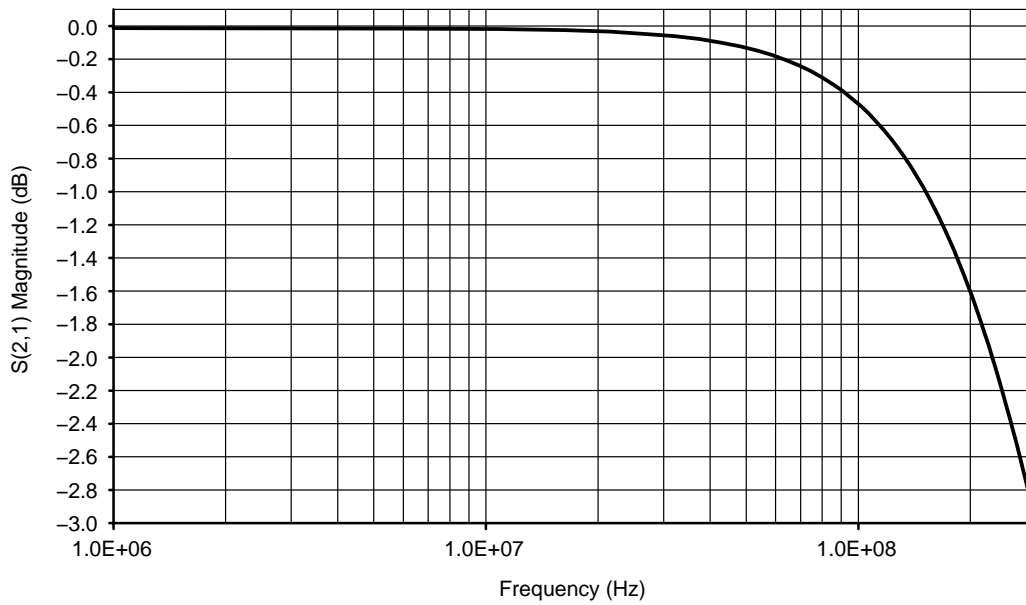

Figure 10. Magnitude vs. Frequency

IEC 61000-4-2 Spec.

Level	Test Voltage (kV)	First Peak Current (A)	Current at 30 ns (A)	Current at 60 ns (A)
1	2	7.5	4	2
2	4	15	8	4
3	6	22.5	12	6
4	8	30	16	8

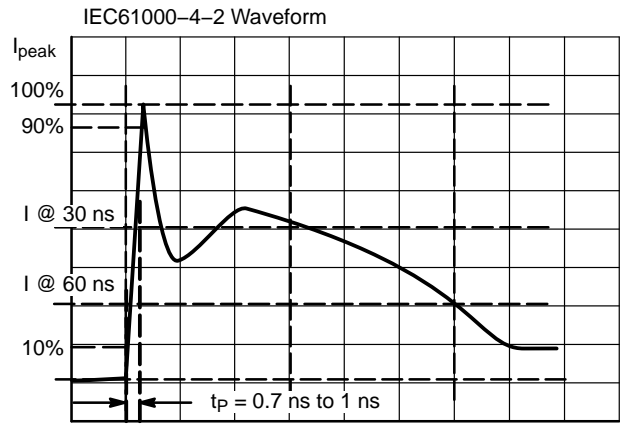

Figure 11. IEC61000-4-2 Spec

Transmission Line Pulse (TLP) Measurement

Transmission Line Pulse (TLP) provides current versus voltage (I-V) curves in which each data point is obtained from a 100 ns long rectangular pulse from a charged transmission line. A simplified schematic of a typical TLP system is shown in Figure 12. TLP I-V curves of ESD protection devices accurately demonstrate the product’s ESD capability because the 10s of amps current levels and under 100 ns time scale match those of an ESD event. This is illustrated in Figure 13 where an 8 kV IEC 61000-4-2 current waveform is compared with TLP current pulses at 8 A and 16 A. A TLP I-V curve shows the voltage at which the device turns on as well as how well the device clamps voltage over a range of current levels.

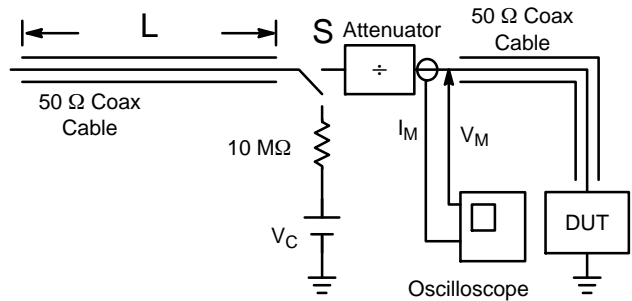

Figure 12. Simplified Schematic of a Typical TLP System

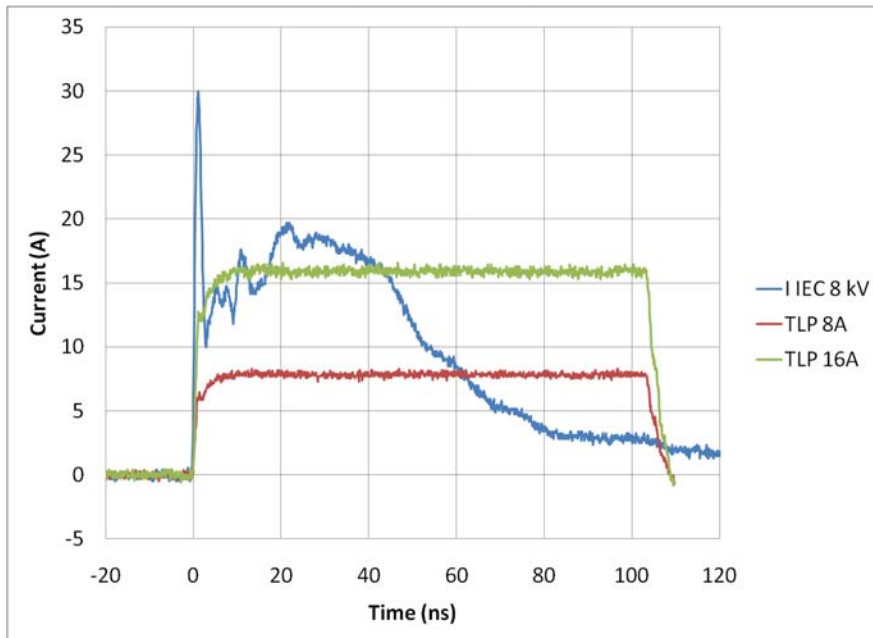
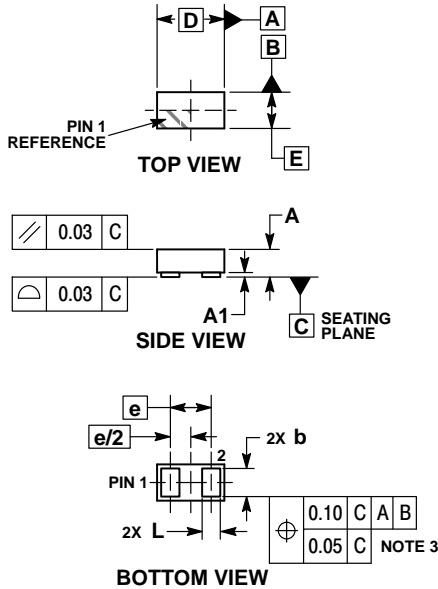

Figure 13. Comparison Between 8 kV IEC 61000-4-2 and 8 A and 16 A TLP Waveforms

ESDM1051

PACKAGE DIMENSIONS – ESDM1051 (01005)

X4DFN2, 0.445x0.24, 0.27P
CASE 718AA
ISSUE A



NOTES:

1. DIMENSIONING AND TOLERANCING PER ASME Y14.5M, 1994.
2. CONTROLLING DIMENSION: MILLIMETERS.
3. EXPOSED COPPER ALLOWED AS SHOWN.

MILLIMETERS			
DIM	MIN	NOM	MAX
A	0.15	0.18	0.21
A1	---	---	0.03
b	0.170	0.185	0.200
D	0.415	0.445	0.475
E	0.210	0.240	0.270
e	0.270 BSC		
L	0.105	0.120	0.135

RECOMMENDED MOUNTING FOOTPRINT*

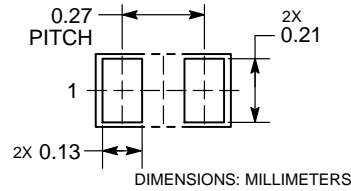

See Application Note AND8398/D for more mounting details
*For additional information on our Pb-Free strategy and soldering details, please download the ON Semiconductor Soldering and Mounting Techniques Reference Manual, SOLDERRM/D.

ON Semiconductor and are trademarks of Semiconductor Components Industries, LLC dba ON Semiconductor or its subsidiaries in the United States and/or other countries. ON Semiconductor owns the rights to a number of patents, trademarks, copyrights, trade secrets, and other intellectual property. A listing of ON Semiconductor's product/patent coverage may be accessed at www.onsemi.com/site/pdf/Patent-Marking.pdf. ON Semiconductor reserves the right to make changes without further notice to any products herein. ON Semiconductor makes no warranty, representation or guarantee regarding the suitability of its products for any particular purpose, nor does ON Semiconductor assume any liability arising out of the application or use of any product or circuit, and specifically disclaims any and all liability, including without limitation special, consequential or incidental damages. Buyer is responsible for its products and applications using ON Semiconductor products, including compliance with all laws, regulations and safety requirements or standards, regardless of any support or applications information provided by ON Semiconductor. "Typical" parameters which may be provided in ON Semiconductor data sheets and/or specifications can and do vary in different applications and actual performance may vary over time. All operating parameters, including "Typicals" must be validated for each customer application by customer's technical experts. ON Semiconductor does not convey any license under its patent rights nor the rights of others. ON Semiconductor products are not designed, intended, or authorized for use as a critical component in life support systems or any FDA Class 3 medical devices or medical devices with a same or similar classification in a foreign jurisdiction or any devices intended for implantation in the human body. Should Buyer purchase or use ON Semiconductor products for any such unintended or unauthorized application, Buyer shall indemnify and hold ON Semiconductor and its officers, employees, subsidiaries, affiliates, and distributors harmless against all claims, costs, damages, and expenses, and reasonable attorney fees arising out of, directly or indirectly, any claim of personal injury or death associated with such unintended or unauthorized use, even if such claim alleges that ON Semiconductor was negligent regarding the design or manufacture of the part. ON Semiconductor is an Equal Opportunity/Affirmative Action Employer. This literature is subject to all applicable copyright laws and is not for resale in any manner.

PUBLICATION ORDERING INFORMATION

LITERATURE FULFILLMENT:
Literature Distribution Center for ON Semiconductor
19521 E. 32nd Pkwy, Aurora, Colorado 80011 USA
Phone: 303-675-2175 or 800-344-3860 Toll Free USA/Canada
Fax: 303-675-2176 or 800-344-3867 Toll Free USA/Canada
Email: orderlit@onsemi.com

N. American Technical Support: 800-282-9855 Toll Free USA/Canada
Europe, Middle East and Africa Technical Support:
Phone: 421 33 790 2910
Japan Customer Focus Center
Phone: 81-3-5817-1050

ON Semiconductor Website: www.onsemi.com
Order Literature: <http://www.onsemi.com/orderlit>
For additional information, please contact your local Sales Representative