

UNCONTROLLED DOCUMENT

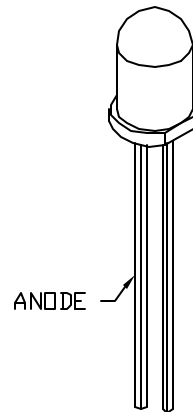
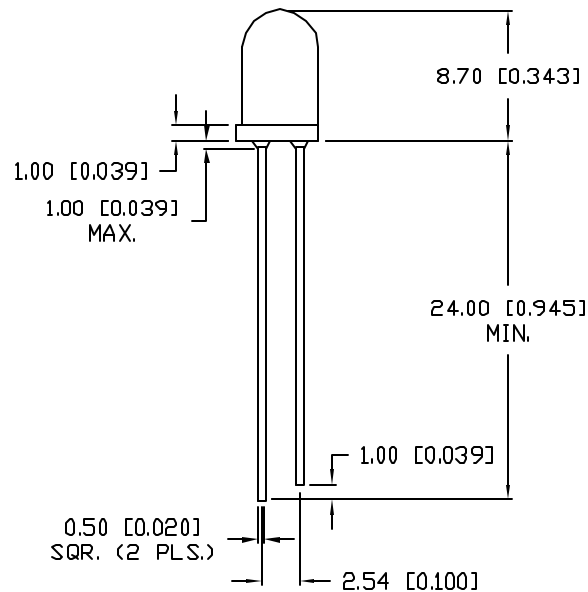
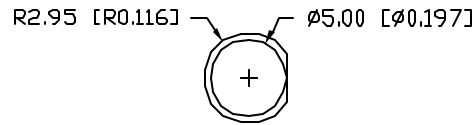

PART NUMBER
OED-EL-1L2

REV.
E

| REV. | E.C.N. NUMBER AND REVISION COMMENTS | DATE |
|------|-------------------------------------|----------|
| A | REDRAWN. | 11.24.93 |
| B | CHG'D INTENSITY AND HALF ANGLE. | 2.22.94 |
| C | E.C.N. #10BRDR. | 1.7.98 |
| D | E.C.N. #10BRDR. & REDRAWN IN 3D. | 12.31.02 |
| E | E.C.N. #11393. | 01.18.07 |

ELECTRO-OPTICAL CHARACTERISTICS $T_A=25^\circ\text{C}$ $I_f=20\text{mA}$

| PARAMETER | MIN | TYP | MAX | UNITS | TEST COND |
|--------------------|-----|----------|-----|---------|---------------------|
| PEAK WAVELENGTH | | 940 | | nm | |
| SPECTRAL BANDWIDTH | | 45 | | nm | |
| FORWARD VOLTAGE | | 1.2 | 1.6 | V_f | |
| REVERSE VOLTAGE | 5.0 | | | V_r | $I_r=10\mu\text{A}$ |
| RADIANT INTENSITY | | 60 | | mW/SR | $I_f=100\text{mA}$ |
| HALF ANGLE | | ± 30 | | degrees | |

EPOXY LENS FINISH: WATER CLEAR

LIMITS OF SAFE OPERATION AT 25°C

| PARAMETER | MAX | UNITS |
|--------------------------------|-------------|----------------------|
| PEAK FORWARD CURRENT* | 1 | A |
| STEADY CURRENT | 100 | mA |
| POWER DISSIPATION | 150 | mW |
| DERATE FROM 25°C | -1.2 | mW/ $^\circ\text{C}$ |
| OPERATING TEMP. | -25 TO +85 | $^\circ\text{C}$ |
| STORAGE TEMP. | -25 TO +100 | $^\circ\text{C}$ |
| SOLDERING TEMP. | +260 | $^\circ\text{C}$ |
| 2.0mm FROM BODY | | 3 SEC. MAX |

* $t_p < 10\mu\text{s}$, $t_p/T = 1\%$ DUTY CYCLE



UNCONTROLLED DOCUMENT

*UNLESS OTHERWISE SPECIFIED TOLERANCES PER DECIMAL PRECISION ARE: X= ± 1 (± 0.039), XX= ± 0.5 (± 0.020), XXX= ± 0.25 (± 0.010), XXXX= ± 0.127 (± 0.005). LEAD SIZE= ± 0.05 (± 0.002), LEAD LENGTH= ± 0.75 (± 0.030). MIN.= +DECIMAL PRECISION -0.00 MAX.= +0.00 -DECIMAL PRECISION

| | |
|--|---------------------------|
| REV. E | PART NUMBER OED-EL-1L2 |
| T-5mm, 940nm INFRARED EMITTING DIODE, WATER CLEAR LENS. | |

CONFIDENTIAL INFORMATION
THE INFORMATION CONTAINED IN THIS DOCUMENT IS THE PROPERTY OF LUMEX INC. EXCEPT AS SPECIFICALLY AUTHORIZED IN WRITING BY LUMEX INC., THE HOLDER OF THIS DOCUMENT SHALL KEEP ALL INFORMATION CONTAINED HEREIN CONFIDENTIAL AND SHALL PROTECT SAME IN WHOLE OR IN PART FROM DISCLOSURE AND DISSEMINATION TO ALL THIRD PARTIES.

RELIABILITY NOTE
OUR MANY YEARS OF EXPERIENCE DATA ACCUMULATION INDICATE THAT SOLDER HEAT IS A MAJOR CAUSE OF EARLY AND FUTURE FAILURE. PLEASE PAY ATTENTION TO YOUR SOLDERING PROCESS.

| | | |
|-----------------|-------------|---|
| | | 290 E. HELEN ROAD PALATINE, IL 60067-6976 PHONE: +1.847.359.2790 US WEB: www.lumex.com TW WEB: www.lumex.com.tw |
| DRAWN BY: jc | CHECKED BY: | APPROVED BY: |
| DATE: 12.20.90 | | PAGE: 1 OF 1 |
| SCALE: N/A | | |

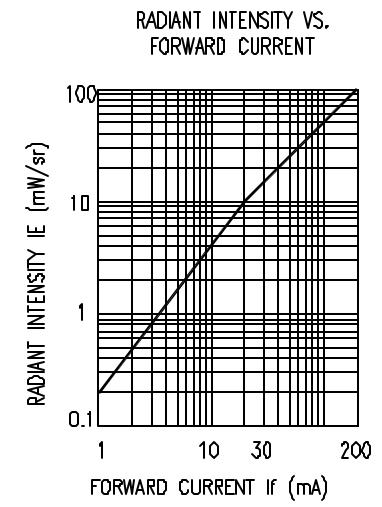
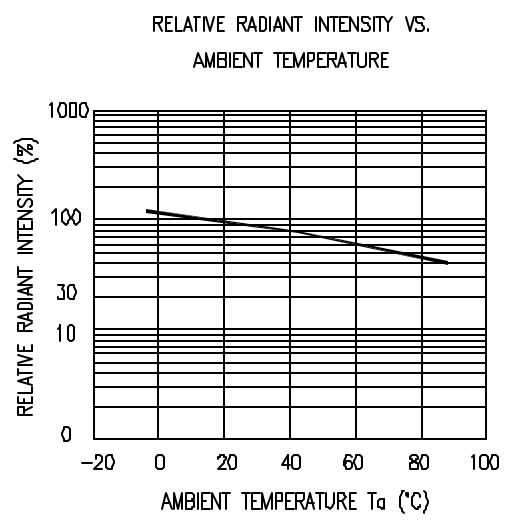
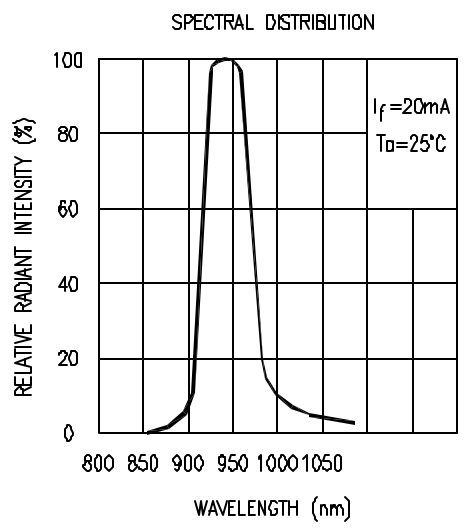
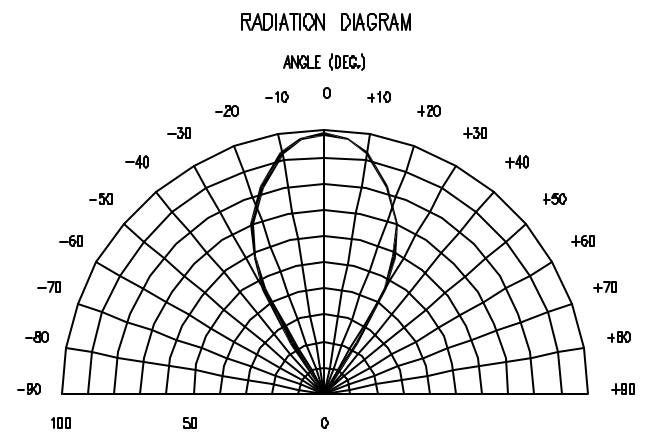
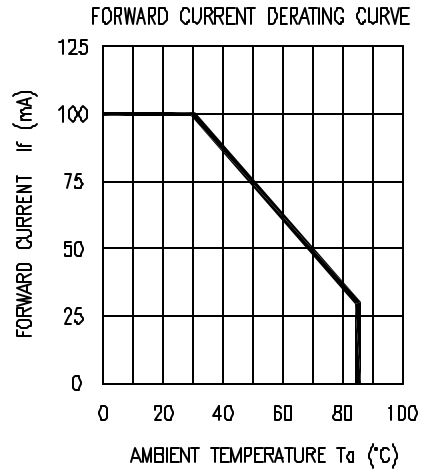
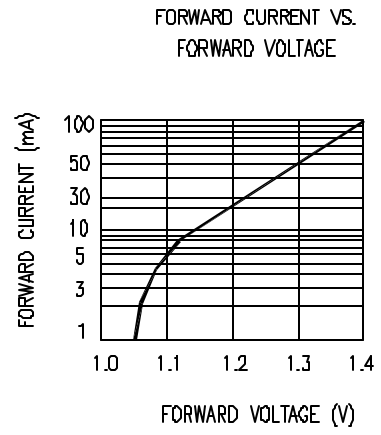

*UNLESS OTHERWISE SPECIFIED TOLERANCES PER DECIMAL PRECISION ARE: X=±1 (±0.039), XX=±0.5 (±0.020), XXX=±0.25 (±0.010), XXXX=±0.127 (±0.005). LEAD SIZE=±0.05 (±0.002), LEAD LENGTH=±0.75 (±0.030). MIN= +DECIMAL PRECISION -0.00 MAX.= +0.00 -DECIMAL PRECISION

| | |
|-----------|---------------------------|
| REV. E | PART NUMBER OED-EL-1L2 |
|-----------|---------------------------|

CONFIDENTIAL INFORMATION
THE INFORMATION CONTAINED IN THIS DOCUMENT IS THE PROPERTY OF LUMEX INC. EXCEPT AS SPECIFICALLY AUTHORIZED IN WRITING BY LUMEX INC., THE HOLDER OF THIS DOCUMENT SHALL KEEP ALL INFORMATION CONTAINED HEREIN CONFIDENTIAL AND SHALL PROTECT SAME IN WHOLE OR IN PART FROM DISCLOSURE AND DISSEMINATION TO ALL THIRD PARTIES.

RELIABILITY NOTE
OUR MANY YEARS OF EXPERIENCE DATA ACCUMULATION INDICATE THAT SOLDER HEAT IS A MAJOR CAUSE OF EARLY AND FUTURE FAILURE. PLEASE PAY ATTENTION TO YOUR SOLDERING PROCESS.

290 E. HELEN ROAD
PALATINE, IL 60067-6976
PHONE: +1.847.359.2790
US WEB: www.lumex.com
TW WEB: www.lumex.com.tw

CHARTS.

| | | | |
|-----------------|-------------|--------------|--------------|
| DRAWN BY: jc | CHECKED BY: | APPROVED BY: | DATE: 4.7.04 |
| | | | PAGE: 1 OF 1 |
| | | | SCALE: N/A |