

UL 1686 C1 Pin and Sleeve

200A, 600/250V AC/DC, 3 Pole, 4 Wire

Insulgrip® Pin and Sleeve Plug

Features

- Impact resistant shroud protects sleeves from bending and breaking
- Locking ring provides UL Type 4X watertight, dust-tight seal
- Catalog number and rating visible while in use
- All-Brass sleeve contacts provide reliable electrical contact

Ordering Information

Description Pin and Sleeve, Watertight Insulgrip Plug	UPC 783585011486	Catalog Number HBL4200PS2W
Device Color Aluminum	Grounding Style Style 2	

Standards

UL Standard 1682, UL 50, and UL 1010
CSA Certified to CSA Spec. C22.2 No. 159
UL Listed and CSA Certified Type 4X

Specifications

Housing	Valox® 357
Plug Shroud	Aluminum
Clamp Nut	Nickel Plated Brass
Gland Cap	Rynite® SST35
Retainer	Thermoset Polyester
O-Ring, Gaskets & Seals	Neoprene

Performance

Electrical	
Current Interrupting	Certified for current interrupting at full rated current
Dielectric Voltage	Withstands 3,000V AC
Max. Working Voltage	600V AC RMS
Mechanical	
Impact Resistance	Per CSA C22.2, No. 182.1, UL 1682
Product Identification	Identification and ratings are permanently fastened to the device housing
Terminal Identification	Terminals identified in accordance with UL 1686(1, 2, 3, Green)
Environmental	
Flammability (Enclosure)	UL 94V-0 and CSA C22.2 No. 0.17
Moisture Resistance	Type 3, 4, 4X per UL 50E and CSA 22.2, No. 94
Operating Temperatures	Max. Continuous 75°C; Min. -40°C w/o impact -25° with impact

Accessories

Cord Clamps and Locking Ring
Liquidtight Adapters

Online Resources

Customer Use Drawing
eCatalog
Installation Instructions

HUBBELL

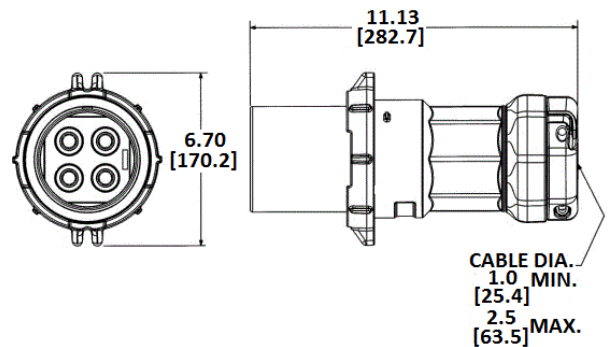

Dimensions in Inches (mm)

Hubbell Wiring Device-Kellems • Hubbell Incorporated (Delaware) • 40 Waterview Drive • Shelton, CT 06484

Phone (800) 288-6000 • Fax (800) 255-1031 • Specifications subject to change without notice.

