

FEATURES

- Single AD8041 and Dual AD8042 Also Available
- Fully Specified at +3 V, +5 V, and ± 5 V Supplies
- Output Swings to Within 25 mV of Either Rail
- Input Voltage Range Extends 200 mV Below Ground
- No Phase Reversal with Inputs 1 V Beyond Supplies
- Low Power of 2.75 mA/Amplifier
- High Speed and Fast Settling on +5 V
 - 150 MHz -3 dB Bandwidth ($G = +1$)
 - 170 V/ μ s Slew Rate
 - 40 ns Settling Time to 0.1%
- Good Video Specifications ($R_L = 150 \Omega$, $G = +2$)
 - Gain Flatness of 0.1 dB to 12 MHz
 - 0.06% Differential Gain Error
 - 0.15° Differential Phase Error
- Low Distortion
 - -68 dBc Total Harmonic @ 5 MHz
- Outstanding Load Drive Capability
 - Drives 30 mA 0.5 V from Supply Rails

APPLICATIONS

- Active Filters
- Video Switchers
- Distribution Amplifiers
- A/D Driver
- Professional Cameras
- CCD Imaging Systems
- Ultrasound Equipment (Multichannel)

PRODUCT DESCRIPTION

The AD8044 is a quad, low power, voltage feedback, high speed amplifier designed to operate on +3 V, +5 V, or ± 5 V supplies. It has true single-supply capability with an input voltage range extending 200 mV below the negative rail and within 1 V of the positive rail.

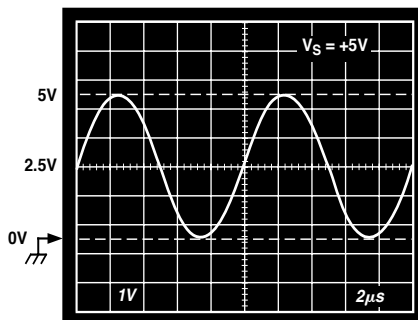
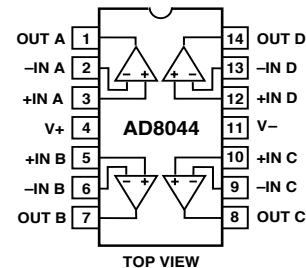

Figure 1. Output Swing: Gain = -1 , $R_L = 2 \text{ k}\Omega$

CONNECTION DIAGRAM 14-Lead Plastic DIP and SOIC



The output voltage swing extends to within 25 mV of each rail, providing the maximum output dynamic range. Additionally, it features gain flatness of 0.1 dB to 12 MHz, while offering differential gain and phase error of 0.04% and 0.22° on a single +5 V supply. This makes the AD8044 useful for video electronics, such as cameras, video switchers, or any high speed portable equipment. The AD8044's low distortion and fast settling make it ideal for active filter applications.

The AD8044 offers low power supply current of 13.1 mA max and can run on a single +3.3 V power supply. These features are ideally suited for portable and battery-powered applications where size and power are critical.

The wide bandwidth of 150 MHz, along with 170 V/ μ s of slew rate on a single +5 V supply, make the AD8044 useful in many general-purpose, high speed applications where dual power supplies of up to ± 6 V and single supplies from +3 V to +12 V are needed. The AD8044 is available in 14-lead PDIP and SOIC.

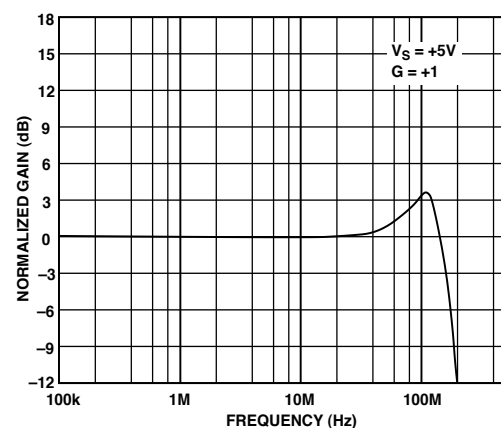

Figure 2. Frequency Response: Gain = +1, $V_S = +5 \text{ V}$

REV. B

Information furnished by Analog Devices is believed to be accurate and reliable. However, no responsibility is assumed by Analog Devices for its use, nor for any infringements of patents or other rights of third parties that may result from its use. No license is granted by implication or otherwise under any patent or patent rights of Analog Devices. Trademarks and registered trademarks are the property of their respective owners.

AD8044—SPECIFICATIONS (@ $T_A = +25^\circ\text{C}$, $V_S = +5\text{ V}$, $R_L = 2\text{ k}\Omega$ to 2.5 V , unless otherwise noted.)

Parameter	Conditions	AD8044A			Units
		Min	Typ	Max	
DYNAMIC PERFORMANCE					
-3 dB Small Signal Bandwidth, $V_O < 0.5\text{ V p-p}$	$G = +1$	80	150		MHz
Bandwidth for 0.1 dB Flatness	$G = +2$, $R_L = 150\ \Omega$		12		MHz
Slew Rate	$G = -1$, $V_O = 4\text{ V Step}$	140	170		V/ μs
Full Power Response	$V_O = 2\text{ V p-p}$		26		MHz
Settling Time to 1%	$G = -1$, $V_O = 2\text{ V Step}$		30		ns
Settling Time to 0.1%			40		ns
NOISE/DISTORTION PERFORMANCE					
Total Harmonic Distortion	$f_C = 5\text{ MHz}$, $V_O = 2\text{ V p-p}$, $G = +2$, $R_L = 1\text{ k}\Omega$		-68		dB
Input Voltage Noise	$f = 10\text{ kHz}$		16		nV/ $\sqrt{\text{Hz}}$
Input Current Noise	$f = 10\text{ kHz}$		850		fA/ $\sqrt{\text{Hz}}$
Differential Gain Error (NTSC)	$G = +2$, $R_L = 150\ \Omega$ to 2.5 V		0.04		%
Differential Phase Error (NTSC)	$G = +2$, $R_L = 150\ \Omega$ to 2.5 V		0.22		Degrees
Crosstalk	$f = 5\text{ MHz}$, $R_L = 1\text{ k}\Omega$, $G = +2$		-60		dB
DC PERFORMANCE					
Input Offset Voltage	$T_{\text{MIN}}-T_{\text{MAX}}$		1.0	6	mV
Offset Drift			8	8	mV/ $^\circ\text{C}$
Input Bias Current	$T_{\text{MIN}}-T_{\text{MAX}}$		2	4.5	μA
Input Offset Current			0.2	1.2	μA
Open-Loop Gain	$R_L = 1\text{ k}\Omega$	82	94		dB
	$T_{\text{MIN}}-T_{\text{MAX}}$		88		dB
INPUT CHARACTERISTICS					
Input Resistance			225		k Ω
Input Capacitance			1.6		pF
Input Common-Mode Voltage Range			-0.2 to 4		V
Common-Mode Rejection Ratio	$V_{\text{CM}} = 0\text{ V}$ to 3.5 V	80	90		dB
OUTPUT CHARACTERISTICS					
Output Voltage Swing	$R_L = 10\text{ k}\Omega$ to 2.5 V		0.03 to 4.975		V
	$R_L = 1\text{ k}\Omega$ to 2.5 V	0.25 to 4.75	0.075 to 4.91		V
	$R_L = 150\ \Omega$ to 2.5 V	0.55 to 4.4	0.25 to 4.65		V
Output Current	$T_{\text{MIN}}-T_{\text{MAX}}$, $V_{\text{OUT}} = 0.5\text{ V}$ to 4.5 V		30		mA
Short Circuit Current	Sourcing		45		mA
	Sinking		85		mA
Capacitive Load Drive	$G = +2$		40		pF
POWER SUPPLY					
Operating Range		3		12	V
Quiescent Current			11	13.1	mA
Power Supply Rejection Ratio	$V_S = 0, +5\text{ V}, \pm 1\text{ V}$	70	80		dB
OPERATING TEMPERATURE RANGE					
		-40		+85	$^\circ\text{C}$

Specifications subject to change without notice.

SPECIFICATIONS (@ $T_A = +25^\circ\text{C}$, $V_S = +3\text{ V}$, $R_L = 2\text{ k}\Omega$ to 1.5 V , unless otherwise noted.)

AD8044

Parameter	Conditions	AD8044A			Units
		Min	Typ	Max	
DYNAMIC PERFORMANCE					
-3 dB Small Signal Bandwidth, $V_O < 0.5\text{ V p-p}$	$G = +1$	80	135		MHz
Bandwidth for 0.1 dB Flatness	$G = +2$, $R_L = 150\ \Omega$		10		MHz
Slew Rate	$G = -1$, $V_O = 2\text{ V Step}$	110	150		V/ μs
Full Power Response	$V_O = 2\text{ V p-p}$		22		MHz
Settling Time to 1%	$G = -1$, $V_O = 2\text{ V Step}$		35		ns
Settling Time to 0.1%			55		ns
NOISE/DISTORTION PERFORMANCE					
Total Harmonic Distortion	$f_C = 5\text{ MHz}$, $V_O = 2\text{ V p-p}$, $G = -1$, $R_L = 100\ \Omega$		-48		dB
Input Voltage Noise	$f = 10\text{ kHz}$		16		nV/ $\sqrt{\text{Hz}}$
Input Current Noise	$f = 10\text{ kHz}$		600		fA/ $\sqrt{\text{Hz}}$
Differential Gain Error (NTSC)	$G = +2$, $R_L = 150\ \Omega$ to 1.5 V , Input $V_{CM} = 0.5\text{ V}$		0.13		%
Differential Phase Error (NTSC)	$G = +2$, $R_L = 150\ \Omega$ to 1.5 V , Input $V_{CM} = 0.5\text{ V}$		0.3		Degrees
Crosstalk	$f = 5\text{ MHz}$, $R_L = 1\text{ k}\Omega$, $G = +2$		-60		dB
DC PERFORMANCE					
Input Offset Voltage			1.5	5.5	mV
Offset Drift	$T_{MIN}-T_{MAX}$		8	7.5	mV
Input Bias Current			2	4.5	$\mu\text{V}/^\circ\text{C}$
Input Offset Current	$T_{MIN}-T_{MAX}$			4.5	μA
Open-Loop Gain	$R_L = 1\text{ k}\Omega$	80	92	1.2	μA
	$T_{MIN}-T_{MAX}$		88		dB
INPUT CHARACTERISTICS					
Input Resistance			225		k Ω
Input Capacitance			1.6		pF
Input Common-Mode Voltage Range			-0.2 to 2		V
Common-Mode Rejection Ratio	$V_{CM} = 0\text{ V}$ to 1.5 V	76	90		dB
OUTPUT CHARACTERISTICS					
Output Voltage Swing	$R_L = 10\text{ k}\Omega$ to 1.5 V		0.025 to 2.98		V
	$R_L = 1\text{ k}\Omega$ to 1.5 V	0.17 to 2.82	0.06 to 2.93		V
	$R_L = 150\ \Omega$ to 1.5 V	0.35 to 2.55	0.15 to 2.75		V
Output Current	$T_{MIN}-T_{MAX}$, $V_{OUT} = 0.5\text{ V}$ to 2.5 V		25		mA
Short Circuit Current	Sourcing		30		mA
	Sinking		50		mA
Capacitive Load Drive	$G = +2$		35		pF
POWER SUPPLY					
Operating Range		3		12	V
Quiescent Current			10.5	12.5	mA
Power Supply Rejection Ratio	$V_S = 0, +3\text{ V}, +0.5\text{ V}$	70	80		dB
OPERATING TEMPERATURE RANGE					
		0		+70	$^\circ\text{C}$

Specifications subject to change without notice.

AD8044—SPECIFICATIONS (@ $T_A = +25^\circ\text{C}$, $V_S = \pm 5\text{ V}$, $R_L = 2\text{ k}\Omega$ to 0 V , unless otherwise noted.)

Parameter	Conditions	AD8044A			Units
		Min	Typ	Max	
DYNAMIC PERFORMANCE					
-3 dB Small Signal Bandwidth, $V_O < 0.5\text{ V p-p}$	$G = +1$	85	160		MHz
Bandwidth for 0.1 dB Flatness	$G = +2$, $R_L = 150\ \Omega$		15		MHz
Slew Rate	$G = -1$, $V_O = 8\text{ V Step}$	150	190		V/ μs
Full Power Response	$V_O = 2\text{ V p-p}$		29		MHz
Settling Time to 0.1%	$G = -1$, $V_O = 2\text{ V Step}$		30		ns
Settling Time to 0.01%			40		ns
NOISE/DISTORTION PERFORMANCE					
Total Harmonic Distortion	$f_C = 5\text{ MHz}$, $V_O = 2\text{ V p-p}$, $G = +2$		-72		dB
Input Voltage Noise	$f = 10\text{ kHz}$		16		nV/ $\sqrt{\text{Hz}}$
Input Current Noise	$f = 10\text{ kHz}$		900		fA/ $\sqrt{\text{Hz}}$
Differential Gain Error (NTSC)	$G = +2$, $R_L = 150\ \Omega$		0.06		%
Differential Phase Error (NTSC)	$G = +2$, $R_L = 150\ \Omega$		0.15		Degrees
Crosstalk	$f = 5\text{ MHz}$, $R_L = 1\text{ k}\Omega$, $G = +2$		-60		dB
DC PERFORMANCE					
Input Offset Voltage			1.4	6.5	mV
Offset Drift	$T_{\text{MIN}}-T_{\text{MAX}}$		10	9	mV
Input Bias Current			2	4.5	μA
Input Offset Current	$T_{\text{MIN}}-T_{\text{MAX}}$		0.2	4.5	μA
Open-Loop Gain	$R_L = 1\text{ k}\Omega$	82	96	1.2	dB
	$T_{\text{MIN}}-T_{\text{MAX}}$		92		dB
INPUT CHARACTERISTICS					
Input Resistance			225		k Ω
Input Capacitance			1.6		pF
Input Common-Mode Voltage Range			-5.2 to 4		V
Common-Mode Rejection Ratio	$V_{\text{CM}} = -5\text{ V to } 3.5\text{ V}$	76	90		dB
OUTPUT CHARACTERISTICS					
Output Voltage Swing	$R_L = 10\text{ k}\Omega$		-4.97 to +4.97		V
	$R_L = 1\text{ k}\Omega$	-4.6 to +4.6	-4.85 to +4.85		V
	$R_L = 150\ \Omega$	-4.0 to +3.8	-4.5 to +4.5		V
Output Current	$T_{\text{MIN}}-T_{\text{MAX}}$, $V_{\text{OUT}} = -4.5\text{ V to } +4.5\text{ V}$		30		mA
Short Circuit Current	Sourcing		60		mA
	Sinking		100		mA
Capacitive Load Drive	$G = +2$		40		pF
POWER SUPPLY					
Operating Range		3		12	V
Quiescent Current			11.5	13.6	mA
Power Supply Rejection Ratio	$V_S = -5, +5\text{ V}, \pm 1\text{ V}$	70	80		dB
OPERATING TEMPERATURE RANGE					
		-40		+85	$^\circ\text{C}$

Specifications subject to change without notice.

ABSOLUTE MAXIMUM RATINGS¹

Supply Voltage	+12.6 V
Internal Power Dissipation ²	
Plastic DIP Package (N)	1.6 Watts
Small Outline Package (R)	1.0 Watts
Input Voltage (Common-Mode)	$\pm V_S \pm 0.5$ V
Differential Input Voltage	± 3.4 V
Output Short Circuit Duration	
.	Observe Power Derating Curves
Storage Temperature Range (N, R)	-65°C to +125°C
Lead Temperature Range (Soldering 10 sec)	+300°C

NOTES

¹Stresses above those listed under Absolute Maximum Ratings may cause permanent damage to the device. This is a stress rating only; functional operation of the device at these or any other conditions above those indicated in the operational section of this specification is not implied. Exposure to absolute maximum rating conditions for extended periods may affect device reliability.

²Specification is for the device in free air:

- 14-Lead Plastic Package: $\theta_{JA} = 75^\circ\text{C}/\text{W}$
- 14-Lead SOIC Package: $\theta_{JA} = 120^\circ\text{C}/\text{W}$

MAXIMUM POWER DISSIPATION

The maximum power that can be safely dissipated by the AD8044 is limited by the associated rise in junction temperature. The maximum safe junction temperature for plastic encapsulated devices is determined by the glass transition temperature of the plastic, approximately +150°C. Exceeding this limit temporarily may cause a shift in parametric performance due to a change in the stresses exerted on the die by the package. Exceeding a junction temperature of +175°C for an extended period can result in device failure.

While the AD8044 is internally short-circuit protected, this may not be sufficient to guarantee that the maximum junction temperature (+150°C) is not exceeded under all conditions. To ensure proper operation, it is necessary to observe the maximum power derating curves.

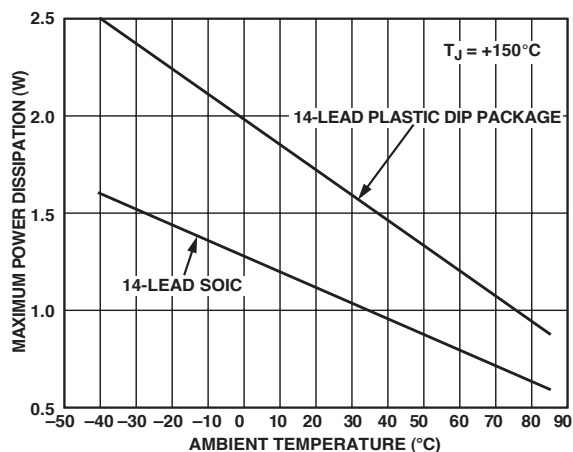

Figure 3. Maximum Power Dissipation vs. Temperature

ORDERING GUIDE

Model	Temperature Range	Package Description	Package Option
AD8044AN	-40°C to +85°C	14-Lead PDIP	N-14
AD8044AR-14	-40°C to +85°C	14-Lead SOIC	R-14
AD8044AR-14-REEL	-40°C to +85°C	14-Lead SOIC 13" REEL	R-14
AD8044AR-14-REEL7	-40°C to +85°C	14-Lead SOIC 7" REEL	R-14
AD8044ARZ-14*	-40°C to +85°C	14-Lead Plastic SOIC	R-14
AD8044ARZ-14-REEL*	-40°C to +85°C	14-Lead SOIC 13" REEL	R-14
AD8044ARZ-14-REEL7*	-40°C to +85°C	14-Lead SOIC 7" REEL	R-14

*Z = Pb free part

CAUTION

ESD (electrostatic discharge) sensitive device. Electrostatic charges as high as 4000 V readily accumulate on the human body and test equipment and can discharge without detection. Although the AD8016 features proprietary ESD protection circuitry, permanent damage may occur on devices subjected to high energy electrostatic discharges. Therefore, proper ESD precautions are recommended to avoid performance degradation or loss of functionality.



AD8044—Typical Performance Characteristics

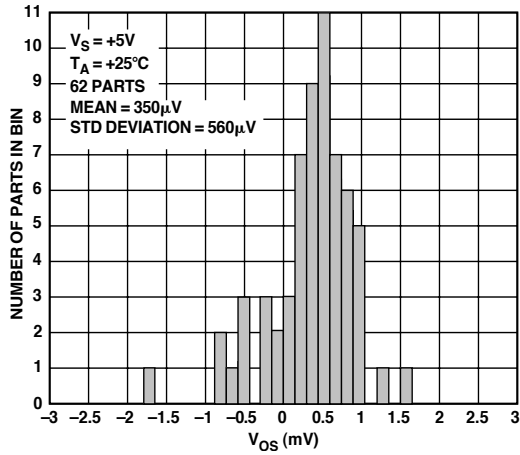

Figure 4. Typical Distribution of V_{OS}

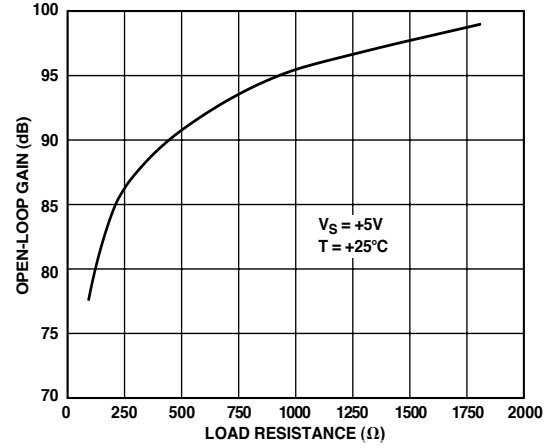

Figure 7. Open-Loop Gain vs. R_L to +2.5 V

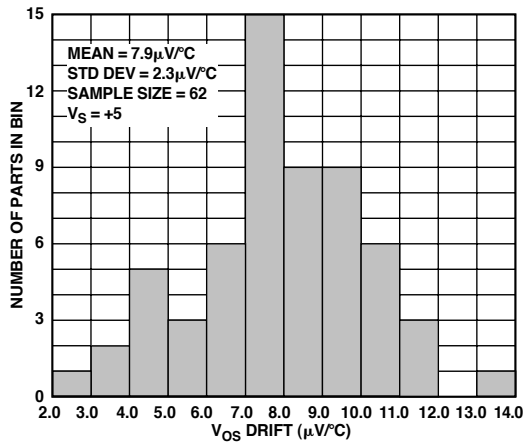

Figure 5. V_{OS} Drift Over -40°C to $+85^{\circ}\text{C}$

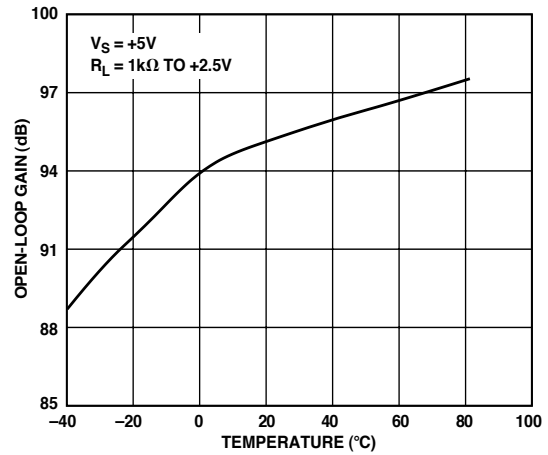

Figure 8. Open-Loop Gain vs. Temperature

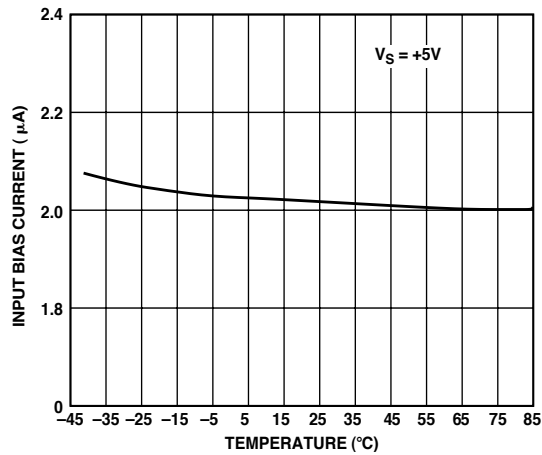

Figure 6. I_B vs. Temperature

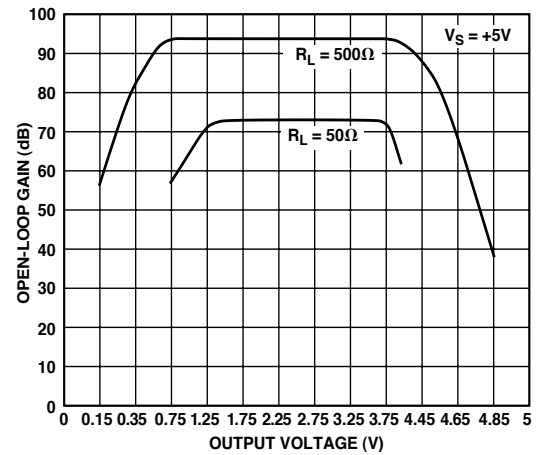

Figure 9. Open-Loop Gain vs. Output Voltage

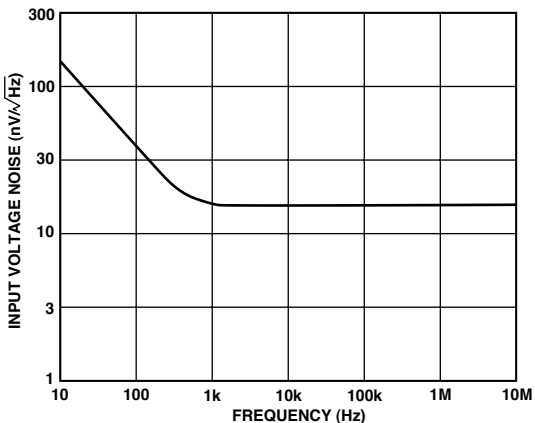

Figure 10. Input Voltage Noise vs. Frequency

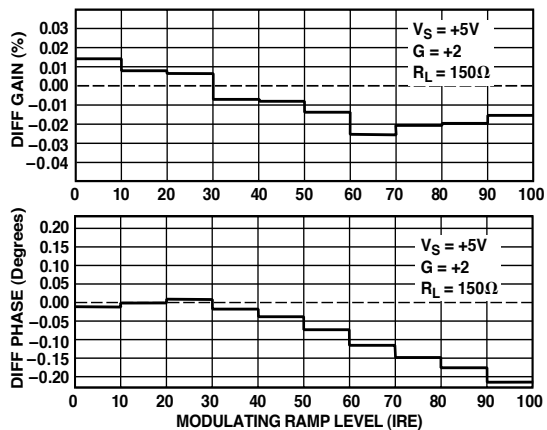

Figure 13. Differential Gain and Phase Errors

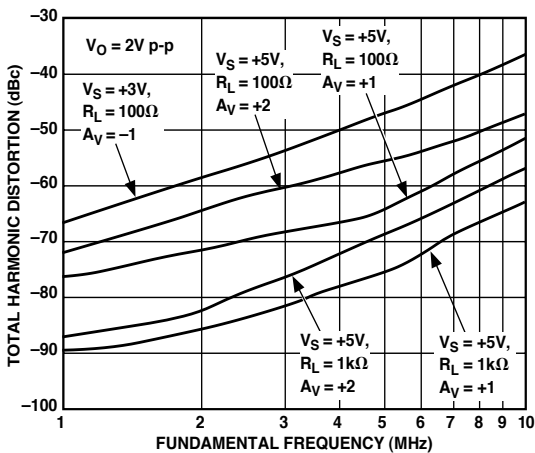

Figure 11. Total Harmonic Distortion

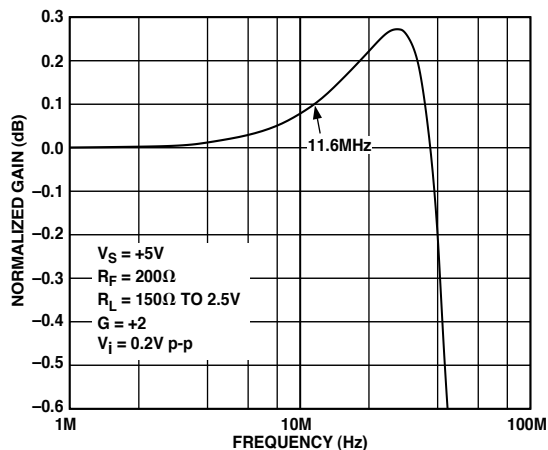

Figure 14. 0.1 dB Gain Flatness

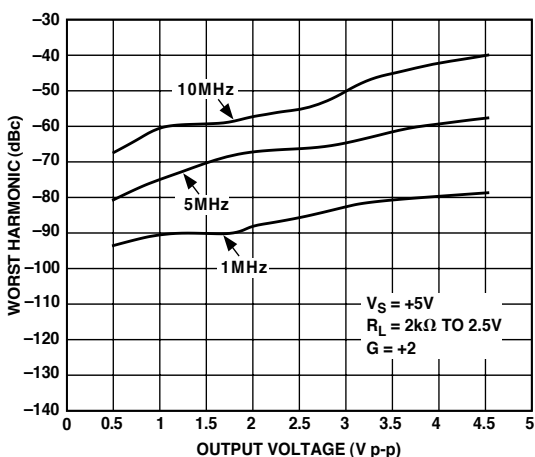

Figure 12. Worst Harmonic vs. Output Voltage

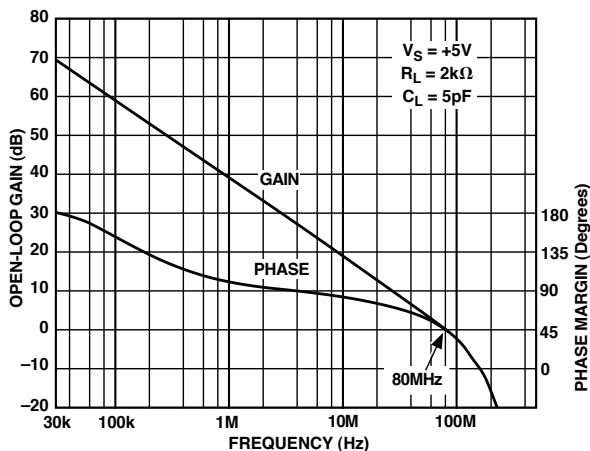

Figure 15. Open-Loop Gain and Phase Margin vs. Frequency

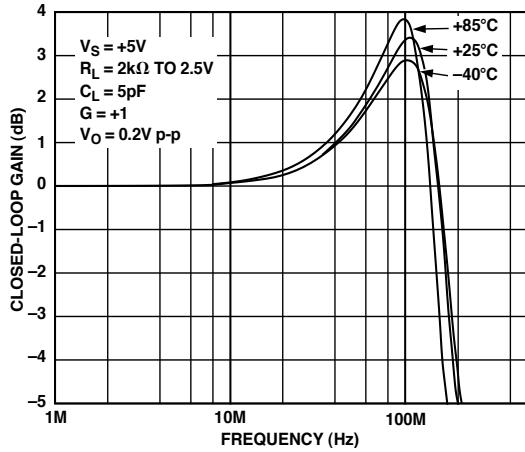

Figure 16. Closed-Loop Frequency Response vs. Temperature

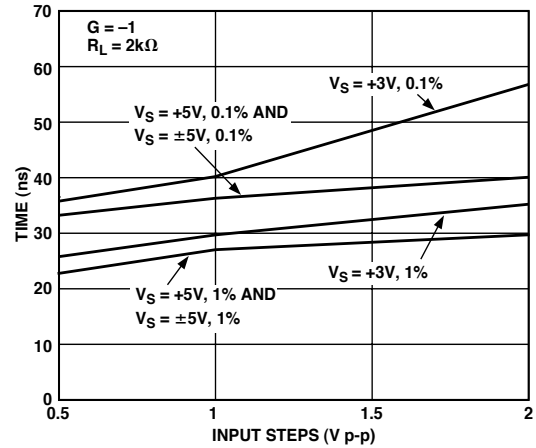

Figure 19. Settling Time vs. Input Step

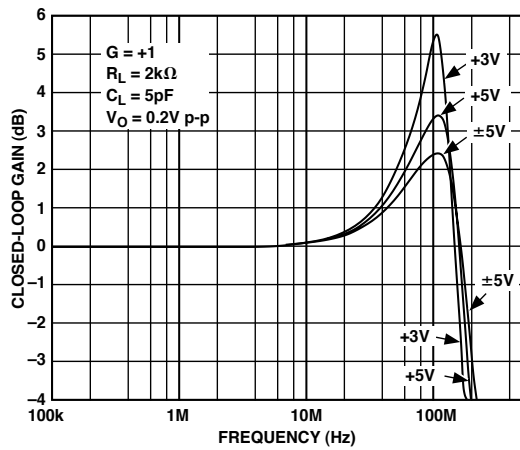

Figure 17. Closed-Loop Frequency Response vs. Supply

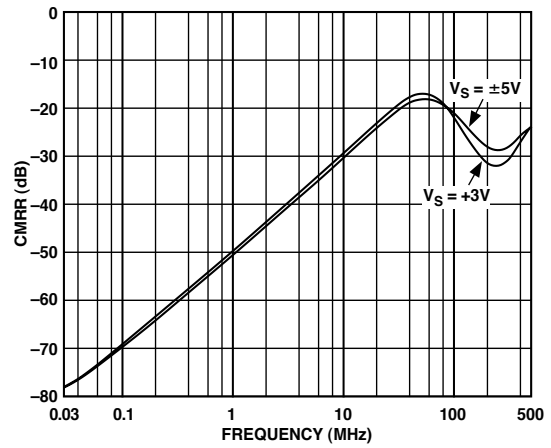

Figure 20. CMRR vs. Frequency

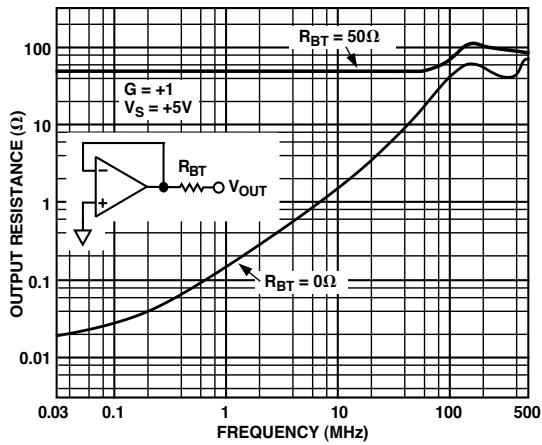

Figure 18. Output Resistance vs. Frequency

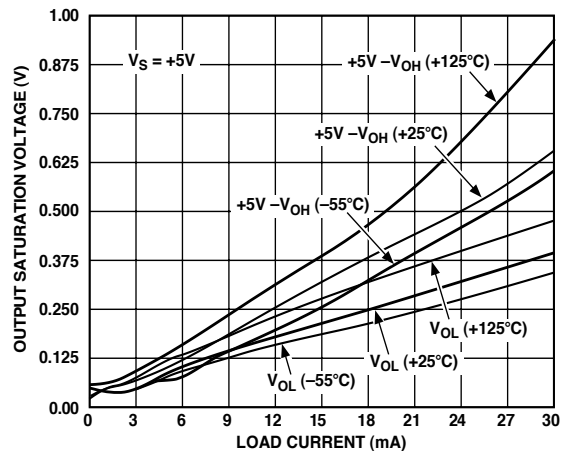

Figure 21. Output Saturation Voltage vs. Load Current

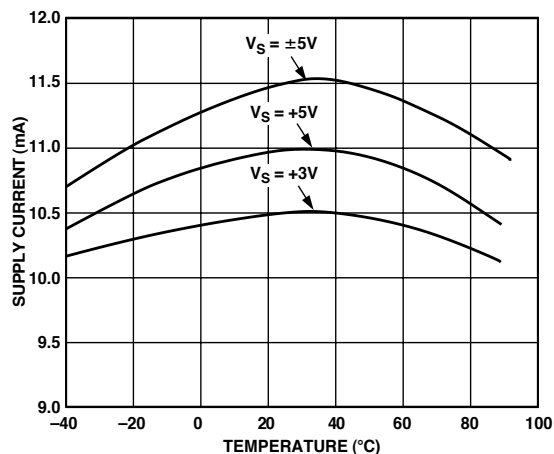

Figure 22. Supply Current vs. Temperature

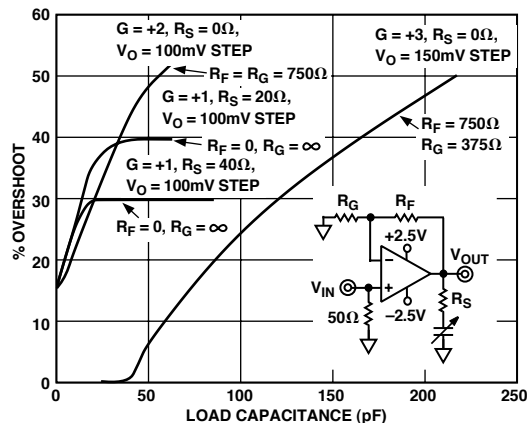

Figure 25. % Overshoot vs. Capacitive Load

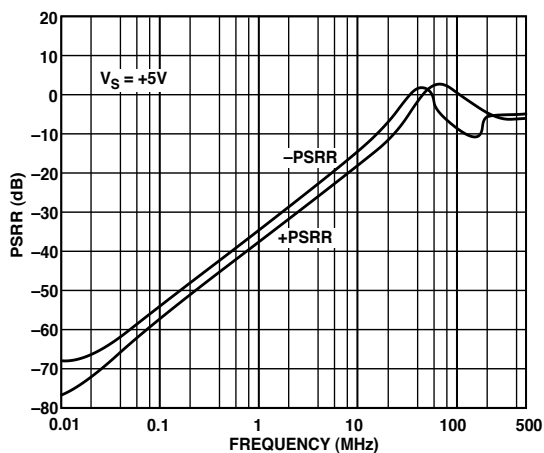

Figure 23. PSRR vs. Frequency

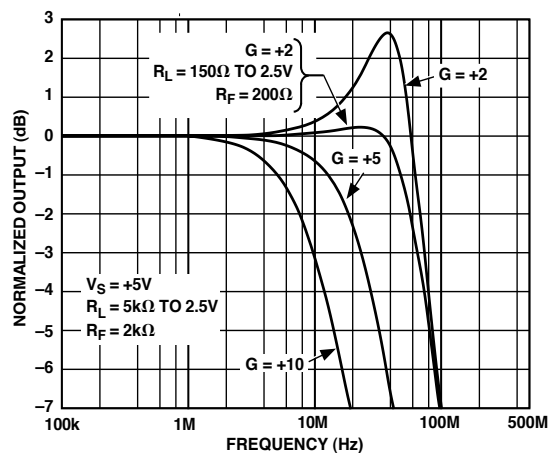

Figure 26. Frequency Response vs. Closed-Loop Gain

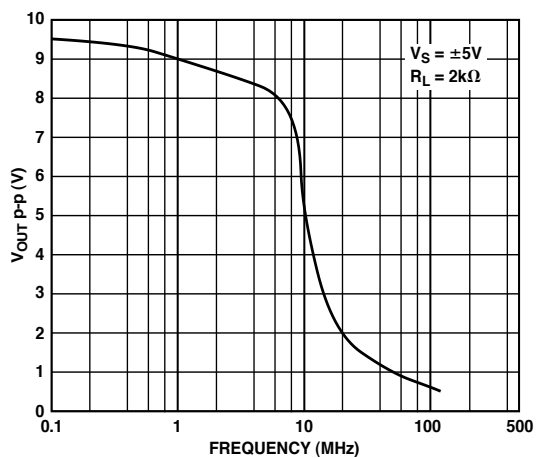

Figure 24. Output Voltage Swing vs. Frequency

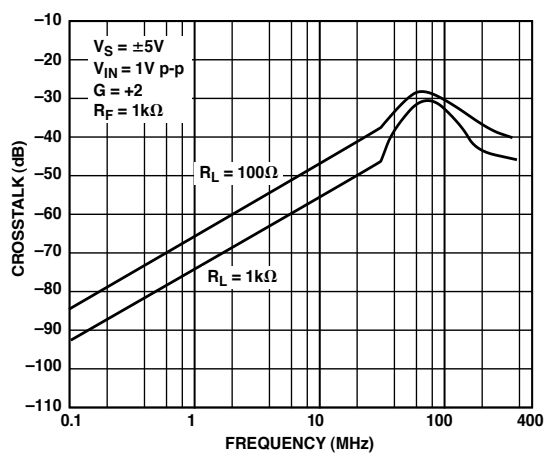

Figure 27. Crosstalk (Output to Output) vs. Frequency

AD8044

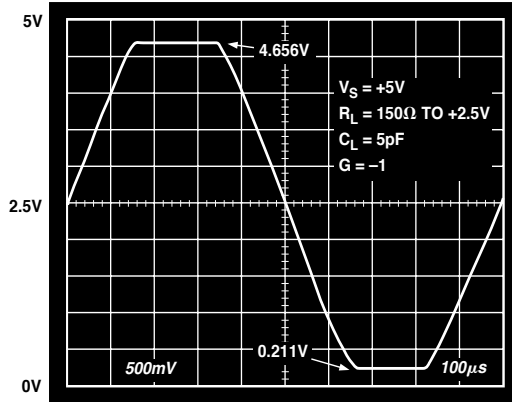

Figure 28a. Output Swing vs. Load Reference Voltage, $V_S = +5\text{ V}$, $G = -1$

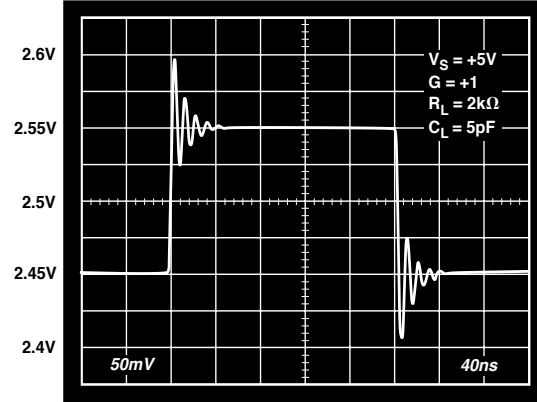

Figure 30. 100 mV Step Response, $V_S = +5\text{ V}$, $G = +1$

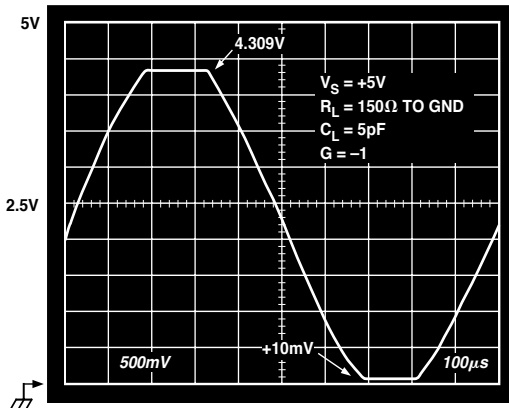

Figure 28b. Output Swing vs. Load Reference Voltage, $V_S = +5\text{ V}$, $G = -1$

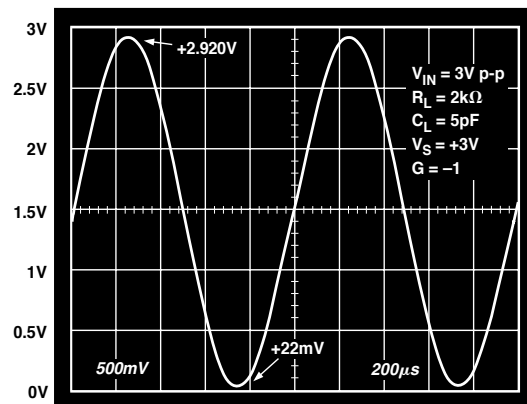

Figure 31. Output Swing, $V_S = +3\text{ V}$

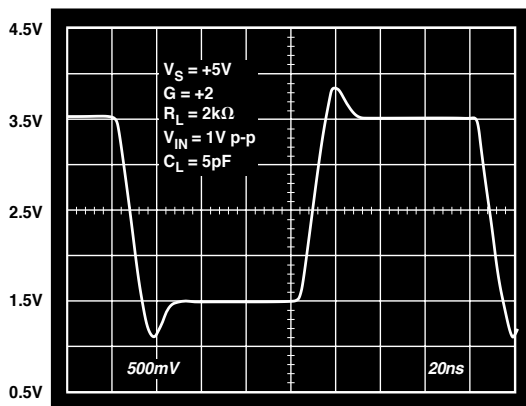

Figure 29. One Volt Step Response, $V_S = +5\text{ V}$, $G = +2$

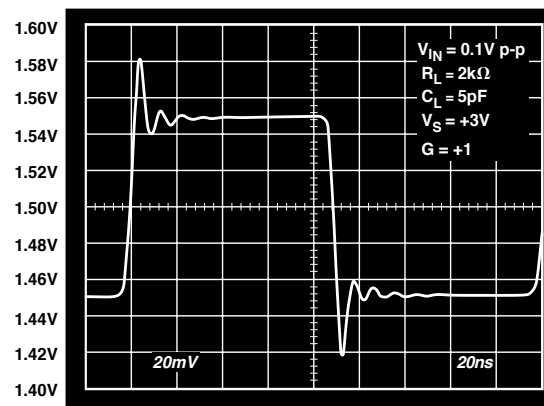

Figure 32. Step Response, $G = +1$, $V_{IN} = 100\text{ mV}$

Overdrive Recovery

Overdrive of an amplifier occurs when the output and/or input range are exceeded. The amplifier must recover from this overdrive condition. As shown in Figure 33, the AD8044 recovers within 50 ns from negative overdrive and within 25 ns from positive overdrive.

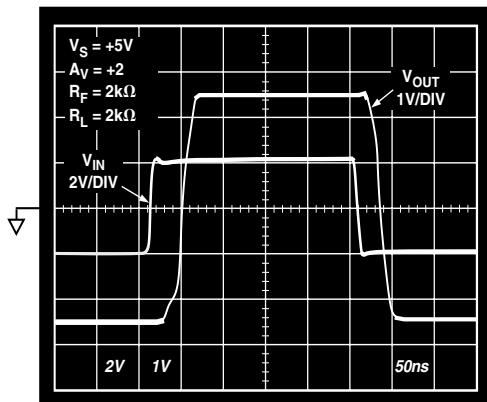

Figure 33. Overdrive Recovery, $V_S = +5\text{ V}$, $V_{IN} = 4\text{ V Step}$

Circuit Description

The AD8044 is fabricated on Analog Devices' proprietary eXtra-Fast Complementary Bipolar (XFCB) process which enables the construction of PNP and NPN transistors with similar f_T s in the 2 GHz–4 GHz region. The process is dielectrically isolated to eliminate the parasitic and latch-up problems caused by junction isolation. These features allow the construction of high frequency, low distortion amplifiers with low supply currents. This design uses a differential output input stage to maximize bandwidth and headroom (see Figure 34). The smaller signal swings required on the first stage outputs (nodes S1P, S1N) reduce the effect of nonlinear currents due to junction capacitances and improve the distortion performance. With this design harmonic distortion of better than -85 dB @ 1 MHz into $100\ \Omega$ with $V_{OUT} = 2\text{ V p-p}$ (Gain = +2) on a single 5 volt supply is achieved.

The AD8044's rail-to-rail output range is provided by a complementary common-emitter output stage. High output drive capability is provided by injecting all output stage predriver currents directly into the bases of the output devices Q8 and Q36. Biasing of Q8 and Q36 is accomplished by I8 and I5, along with a common-mode feedback loop (not shown). This circuit topology allows the AD8044 to drive 50 mA of output current with the outputs within 0.5 V of the supply rails.

On the input side, the device can handle voltages from -0.2 V below the negative rail to within 1.2 V of the positive rail. Exceeding these values will not cause phase reversal; however, the input ESD devices will begin to conduct if the input voltages exceed the rails by greater than 0.5 V.

Driving Capacitance Loads

The capacitive load drive of the AD8044 can be increased by adding a low valued resistor in series with the load. Figure 35 shows the effects of a series resistor on capacitive drive for varying voltage gains. As the closed-loop gain is increased, the larger phase margin allows for larger capacitive loads with less overshoot. Adding a series resistor with lower closed-loop gains accomplishes this same effect. For large capacitive loads, the frequency response of the amplifier will be dominated by the roll-off of the series resistor and capacitive load.

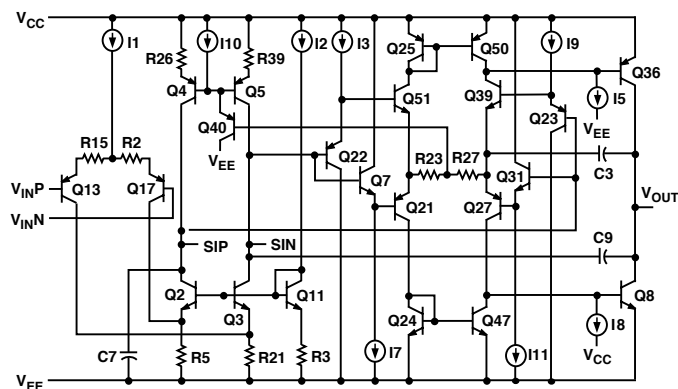

Figure 34. AD8044 Simplified Schematic

AD8044

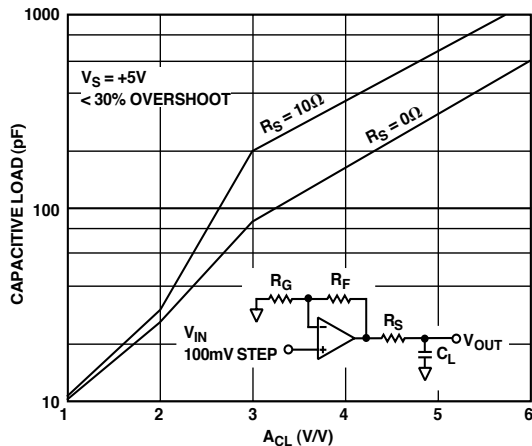

Figure 35. Capacitive Load Drive vs. Closed-Loop Gain

APPLICATIONS

RGB Buffer

The AD8044 can provide buffering of RGB signals that include ground while operating from a single +3 V or +5 V supply.

When driving two monitors from the same RGB video source it is necessary to provide an additional driver for one of the monitors to prevent the double termination situation that the second monitor presents. This has usually required a dual-supply op amp because the level of the input signal from the video driver goes all the way to ground during horizontal blanking. In single-supply systems it can be a major inconvenience and expense to add an additional negative supply.

A single AD8044 can provide the necessary drive capability and yet does not require a negative supply in this application. Figure 36 is a schematic that uses three amplifiers out of a single AD8044 to provide buffering for a second monitor.

The source of the RGB signals is shown to be from a set of three current output DACs that are within a single-supply graphics IC. This is typically the situation in most PCs and workstations that may use either a standalone triple DAC or DACs that are integrated into a larger graphics chip.

During horizontal blanking, the current output from the DACs is turned off and the RGB outputs are pulled to ground by the termination resistors. If voltage sources were used for the RGB signals, then the termination resistors near the graphics IC would be in series and the rest of the circuit would remain the same. This is because a voltage source is an ac short circuit, so a series resistor is required to make the drive end of the line see 75 Ω to ac ground. On the other hand, a current source has a very high output impedance, so a shunt resistor is required to make the drive end of the line see 75 Ω to ground. In either case, the monitor terminates its end of the line with 75 Ω.

The circuit in Figure 36 shows minimum signal degradation when using a single-supply for the AD8044. The circuit performs equally well on either a +3 V or +5 V supply.

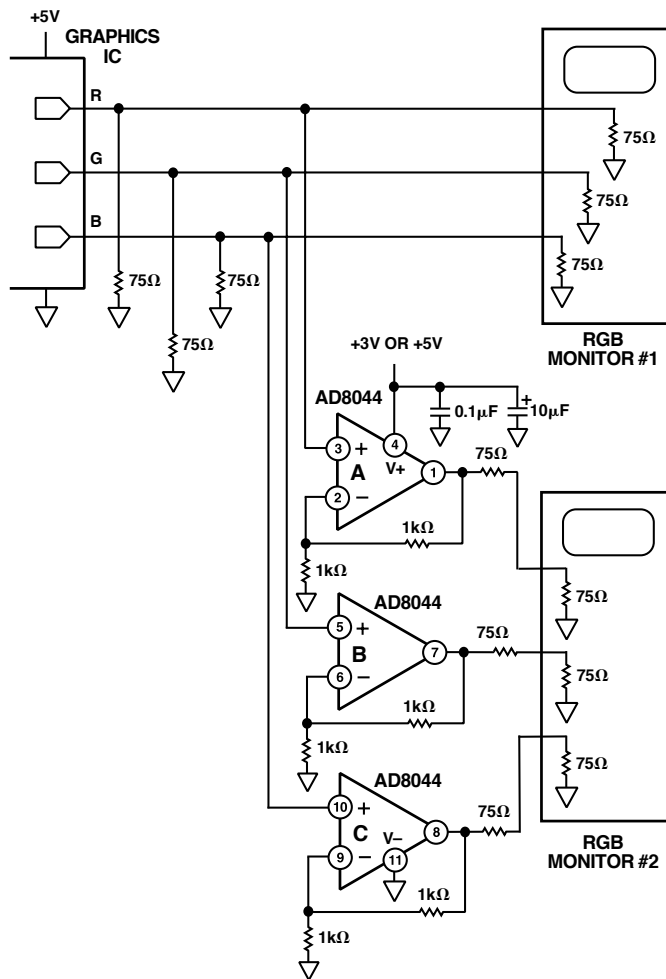

Figure 36. Single Supply RGB Video Driver

Figure 37 is an oscilloscope photo of the circuit in Figure 36 operating from a +3 V supply and driven by the Blue signal of a color bar pattern. Note that the input and output are at ground during the horizontal blanking interval. The RGB signals are specified to output a maximum of 700 mV peak. The output of the AD8044 is 1.4 V with the termination resistors providing a divide-by-two.

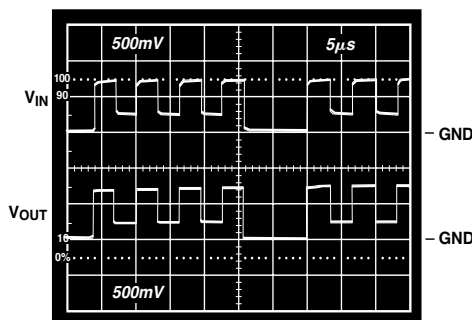

Figure 37. +3 V, RGB Buffer

Active Filters

Active filters at higher frequencies require wider bandwidth op amps to work effectively. Excessive phase shift produced by lower frequency op amps can significantly impact active filter performance.

Figure 38 shows an example of a 2 MHz biquad bandwidth filter that uses three op amps of an AD8044 package. Such circuits are sometimes used in medical ultrasound systems to lower the noise bandwidth of the analog signal before A/D conversion.

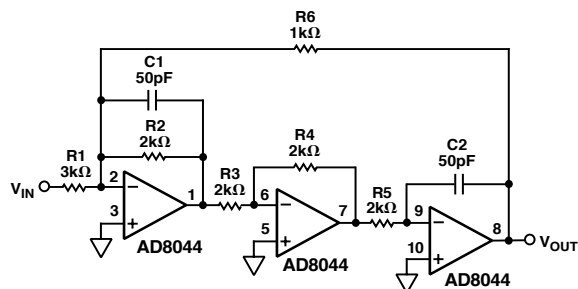

Figure 38. 2 MHz Biquad Band-pass Filter Using AD8044

The frequency response of the circuit is shown in Figure 39.

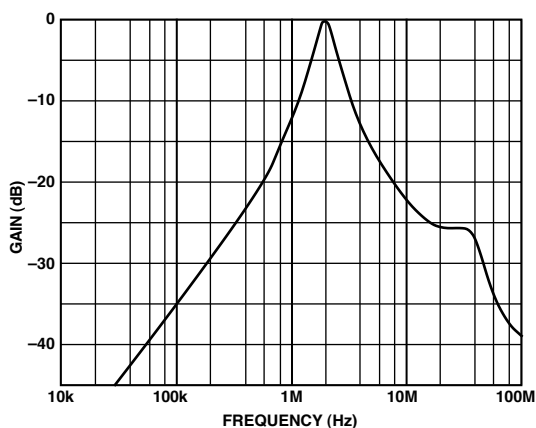

Figure 39. Frequency Response of 2 MHz Band-pass Biquad Filter

Layout Considerations

The specified high speed performance of the AD8044 requires careful attention to board layout and component selection. Proper RF design techniques and low-pass parasitic component selection are necessary.

The PCB should have a ground plane covering all unused portions of the component side of the board to provide a low impedance path. The ground plane should be removed from the area near the input pins to reduce the stray capacitance.

Chip capacitors should be used for the supply bypassing. One end should be connected to the ground plane and the other within 1/8 inch of each power pin. An additional large (0.47 μ F – 10 μ F) tantalum electrolytic capacitor should be connected in parallel, but not necessarily so close, to supply current for fast, large signal changes at the output.

The feedback resistor should be located close to the inverting input pin in order to keep the stray capacitance at this node to a minimum. Capacitance variations of less than 1 pF at the inverting input will significantly affect high speed performance.

Stripline design techniques should be used for long signal traces (greater than about 1 inch). These should be designed with a characteristic impedance of 50 Ω or 75 Ω and properly terminated at each end.

OUTLINE DIMENSIONS

14-Lead Plastic Dual In-Line Package [PDIP] (N-14)

Dimensions shown in inches and (millimeters)

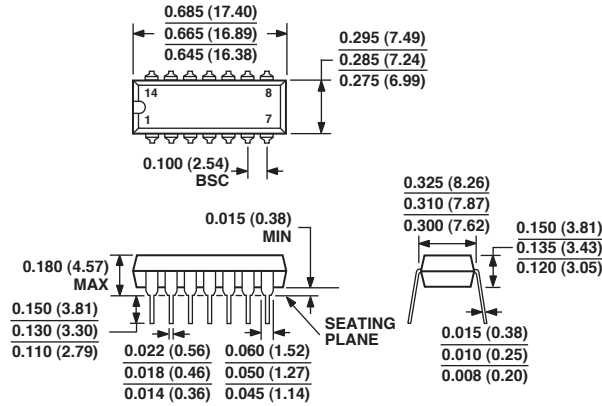

COMPLIANT TO JEDEC STANDARDS MO-095-AB
CONTROLLING DIMENSIONS ARE IN INCHES; MILLIMETER DIMENSIONS
(IN PARENTHESES) ARE ROUNDED-OFF INCH EQUIVALENTS FOR
REFERENCE ONLY AND ARE NOT APPROPRIATE FOR USE IN DESIGN

14-Lead Standard Small Outline Package [SOIC] Narrow Body (R-14)

Dimensions shown in millimeters and (inches)

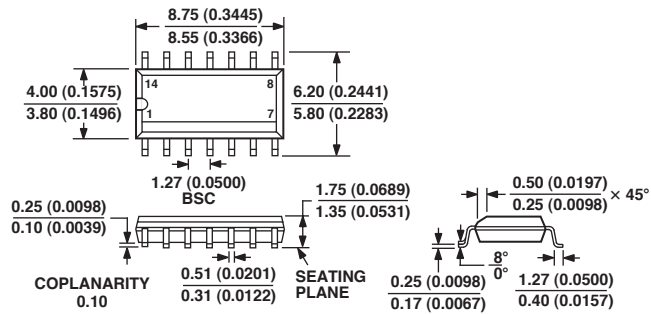

COMPLIANT TO JEDEC STANDARDS MS-012AB
CONTROLLING DIMENSIONS ARE IN MILLIMETERS; INCH DIMENSIONS
(IN PARENTHESES) ARE ROUNDED-OFF MILLIMETER EQUIVALENTS FOR
REFERENCE ONLY AND ARE NOT APPROPRIATE FOR USE IN DESIGN

Revision History

Location	Page
8/04—Data Sheet changed from Rev. A to Rev. B	
Changes to ORDERING GUIDE	5
Updated OUTLINE DIMENSIONS	14

